

- (3) Tighten three mounting bolt nuts (H and S) to 25 to 30 pound-feet torque.

Note. Heads of front mounting bolts (D) are accessible after removal of rubber clearance hole cover (C) in floor at each front corner.

- (4) Shift steering gear to cab mountings so that no binding of steering column exists. Tighten four cap screws attaching rubber spacer to dash brace and steering cowl bracket as used on early models (fig. 284). On late models, tighten two cap screws and nuts attaching bracket support to dash brace (fig. 285).

c. Removal.

- (1) *Remove right or left front mounting bolt.* Pry up clearance hole cover (C) from cab floor. Remove nut (H), steel washer (E), and lower cushions (F) from mounting bolt (D). Withdraw mounting bolt, with steel washer and upper cushion. Raise corner of cab to relieve pressure on mounting cushion; then withdraw cushion from between cab side sill and cab front supporting bracket (J).
- (2) *Remove cab rear center mounting bolt.* From underneath vehicle, remove nut (S), steel washer (M), and lower cushion (P) from rear mounting bolt (N). Remove two nuts, washers, and cap screws (U) attaching either right or left cab mounting spring (Q) to frame cross member. From inside cab, remove rear center mounting bolt (N), steel washer (M), and upper cushion (P). Raise rear corner of cab at which mounting spring is disconnected; then withdraw mounting cushion and steel spacer (L).

d. Installation.

- (1) *Install cab rear center mounting bolt.* Raise rear corner of cab at which mounting spring is disconnected; then position rear mounting cushion (P) and steel spacer (L), with holes alined. Install steel rear mounting bolt washer (M) and mounting cushion (P) on rear mounting bolt (N). Insert mounting bolt down through cab floor, steel spacer, mounting cushions, and frame cross member. Lower rear corner of cab; then install two $\frac{7}{16}$ -20 x 1 cap screws (U) and nuts, attaching cab mounting spring (Q) to frame cross member. Install cushion, steel washer, and $\frac{1}{2}$ -20 nut (S) on mounting bolt. Tighten nut to 25 to 30 pound-feet torque.
- (2) *Install right or left front mounting bolt.* Raise front corner of cab and insert front mounting cushion (F) between cab sill and cab front support bracket. Install steel front mounting bolt washer (E) and cushion on mounting bolt (D); then, from inside cab, insert bolt through cab, mounting cushion, and cab supporting bracket (J). Lower cab; then install

lower cushion, steel washer, and 1/2-20 nut on mounting bolt. Tighten nut firmly against shoulder on bolt.

293. Roof Paulin and Rear Curtain (Soft-Top Cab Only)

a. Roof Paulin. Canvas roof paulin is of one-piece type, supported by windshield, roof panels, and roof bow. Paulin is secured to windshield by a bead which slides into retaining channel on windshield. Roof paulin is further secured by lashing ropes to windshield, roof panels, cab rear panel, and roof bow ring nuts.

Note. Do not roll or stow roof paulin or rear curtain when canvas is wet.

- (1) *Removal.* Untie roof paulin lashing rope from roof bow ring nut at each side of cab. Pull ropes from loops in sides of rear curtains; then disengage ropes from hooks on roof panels. Unhook rope from lashing hooks on back of cab rear panel. Lift roof paulin over roof bow and windshield onto engine hood. From either side, pull bead of roof paulin from channel (fig. 306) at upper front side of windshield frame.
- (2) *Installation.* Slide bead of roof paulin into channel on upper front side of windshield frame. Draw roof paulin into position over windshield and roof bow. Engage rope in lashing hooks on back of cab rear panel. Pull rear lashing rope taut; then tie rope ends to ring nuts. Engage each side rope in hooks on roof panels, thread ropes through straps in

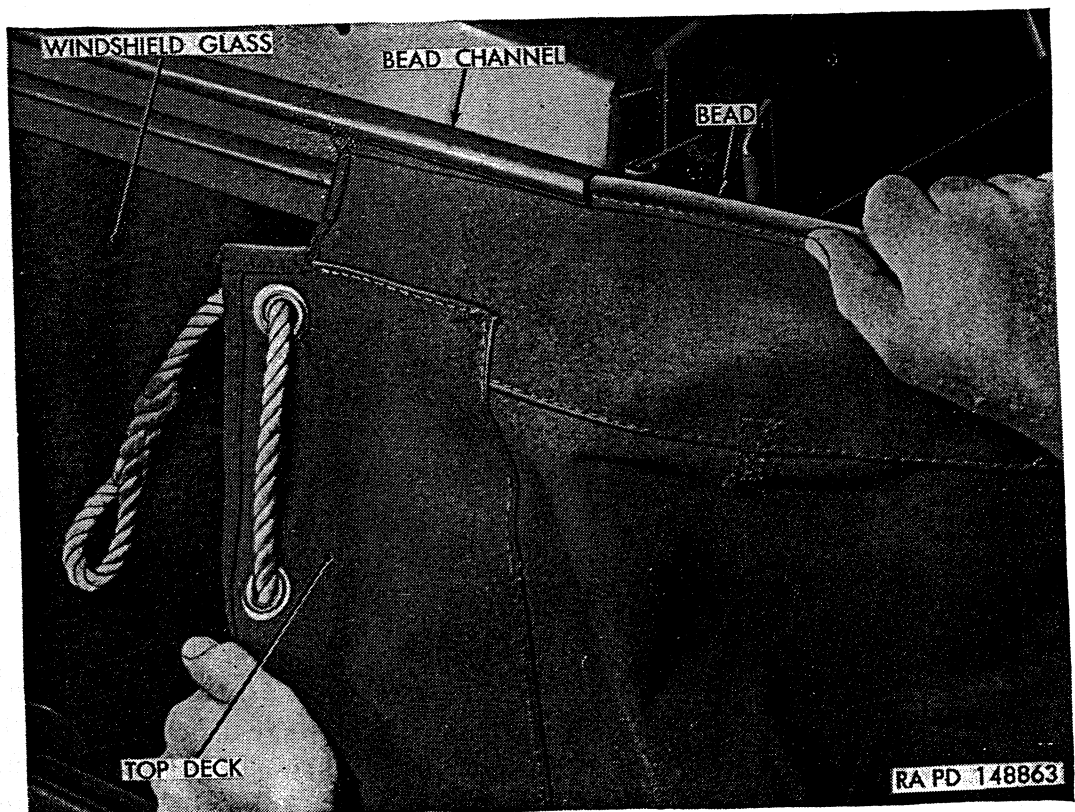

Figure 306. Removing roof paulin from windshield channel.

ends of rear curtain, and engage ropes in hooks on side panels.

Pull each rope taut; then tie to ring nuts.

b. Rear Curtain. Rear curtain is one-piece type, attached to roof bow by means of screws and washers. Each leg of roof bow fits into socket at inside rear corner of cab. Roof bow is held in position by ring nut at each side. Lashing rope, threaded through loops on lower inside of curtain, is engaged in hooks on cab rear panel in back of seats. Ends of lashing ropes are tied to bow. Front edges of rear curtain are secured to side panels with roof paulin lashing rope, threaded through loops and engaging hooks on roof side panel.

(1) *Removal.* With roof paulin removed or rolled forward, untie rear curtain lashing rope from roof bow. Disengage lashing rope from hooks at inside of cab rear panel. Remove retaining screw from each leg of roof bow. Loosen both roof bow ring nuts; then pull roof bow, with rear curtain, straight upward out of sockets.

(2) *Installation.* Insert legs of bow through sockets and install retainer screw in each leg of bow below bow retainer; then raise bow until stop screws contact retainers. Tighten bow retainer ring nuts. Engage rear curtain lashing rope in hooks on inside of cab rear panel. Pull rope taut and tie each end to bow.

c. Positioning Roof Paulin and Curtain. To meet the demands of a wide variety of operating conditions, roof paulin and rear curtain, in connection with windshield and door windows, may be positioned in several ways. Varying degrees of visibility and protection may thus be obtained.

(1) *Roof paulin rolled.* Untie roof paulin side ropes and rear rope from roof bow ring nuts. Disengage ropes from hooks on roof panels and from straps of rear curtain. Roll roof paulin under, from inside cab, into a tight roll, and secure to windshield top frame with roll-up straps.

(2) *Rear curtain rolled.* Roll roof paulin and secure to windshield ((1) above). Untie ends of rear curtain lashing rope from legs of roof bow; then disengage rope from hooks on inside of rear panel (A, fig. 307). Roll each end of rear curtain inward (B, fig. 307); then fold each corner inward (C, fig. 307). Roll curtain up, from inside cab, and secure to roof bow with roll-up straps (D, fig. 307).

(3) *Roof paulin rolled and roof bow down.* Roll roof paulin and rear curtain ((1) and (2) above). Push each roof panel straight upward to disengage from windshield and roof bow anchors and from side panel studs (fig. 308). Lift each roof panel straight upward to disengage studs; then remove from cab. Bolt roof panels together and bolt rear quarter panels

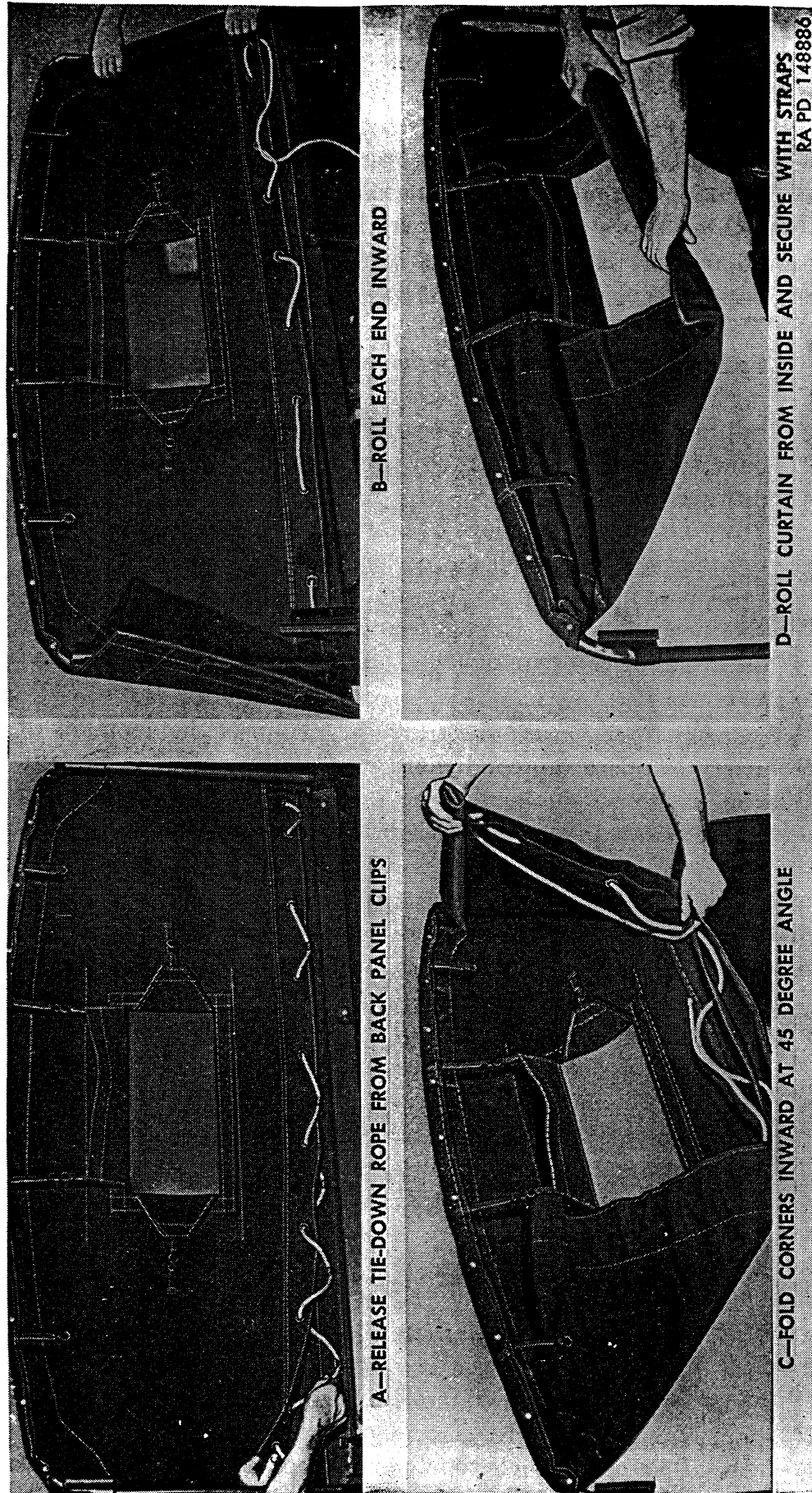

Figure 307. Rolling up rear curtain.

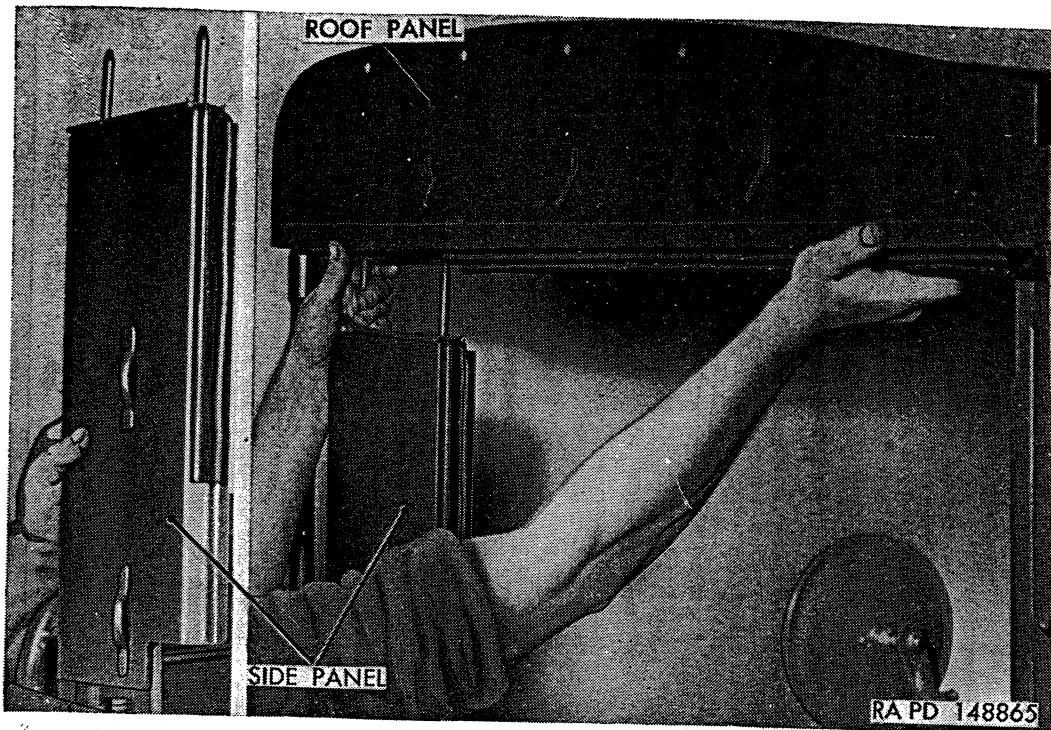

Figure 308. Removing roof and side panels (right side shown).

together, using existing holes and special bolts provided for that purpose. After bolting together, stow roof and side panels back of companion seat and secure with retaining strap (fig. 309). Loosen both roof bow ring nuts and lower roof bow to stops, then tighten ring nuts.

- (a) *Maximum visibility with wind protection.* Vehicle may now be driven with windows cranked up, thus obtaining maximum visibility consistent with protection from wind (A, fig. 310). Door windows may be cranked down for slightly increased visibility.

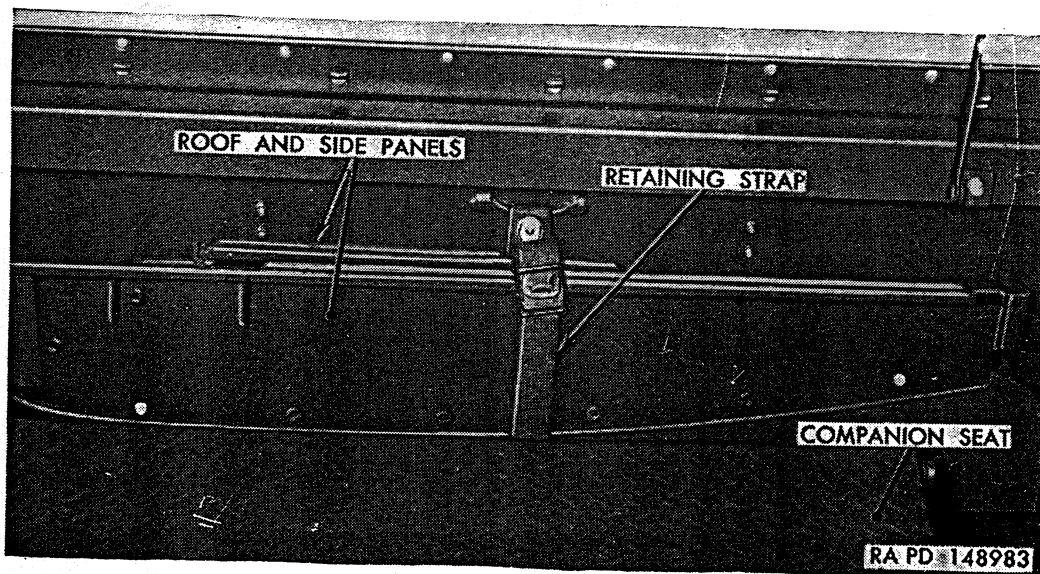
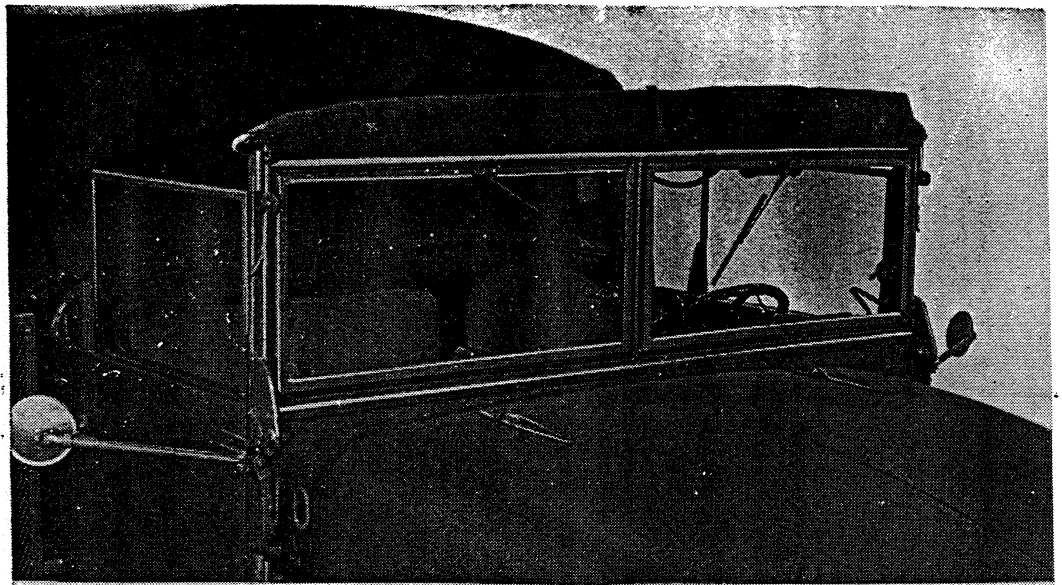

Figure 309. Roof quarter and side panels stowed.



A—MAXIMUM VISIBILITY—WITH WIND PROTECTION



B—MAXIMUM VISIBILITY

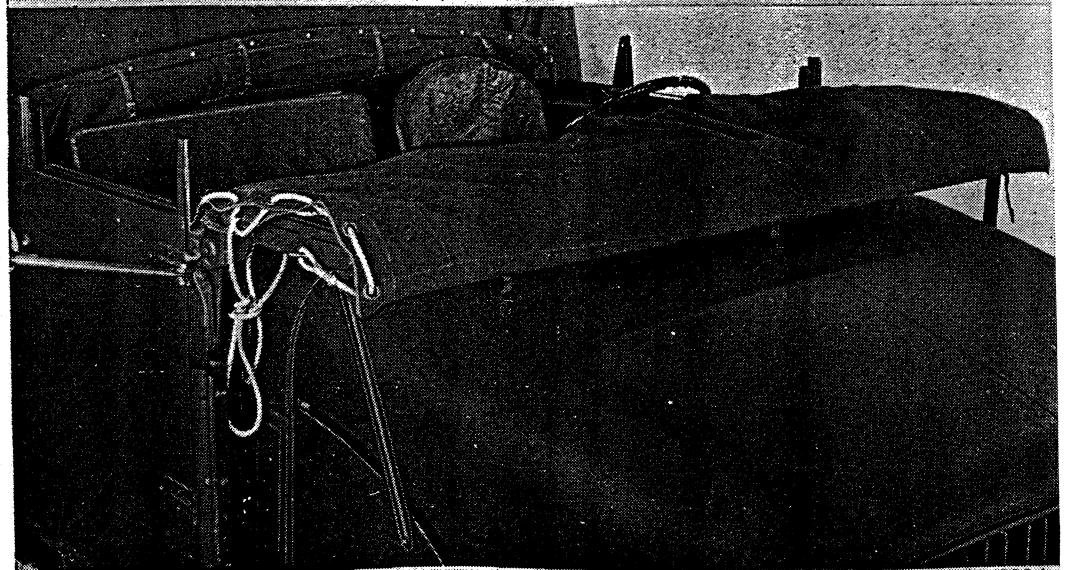

C—MAXIMUM VISIBILITY—WITHOUT GLARE REFLECTION

RA PD 149004

Figure 310. Roof paulin, rear curtain, and windshield positions.

- (b) *Maximum visibility.* Increased visibility is obtained by folding windshield down over hood (B, fig. 310) as described in paragraph 294c.

Caution: Do not drive with door windows raised when windshield is lowered.

- (c) *Maximum visibility with minimum glare reflection.* With windshield positioned for maximum visibility ((b) above), objectional glare may be reflected from windshield glass. Reflected glare can be avoided by covering lower windshield with roof paulin. Unroll roof paulin from windshield frame, fold over windshield, and lash in place as shown in C, figure 310.

294. Windshield

a. *Description* (fig. 311). Windshield consists of two frame and glass assemblies hinged to tubular outer support frame at top by interlocking metal strips. Outer frame is hinged to cab cowl by means of bolts in brackets. Either half of windshield may be tilted outward for ventilation. Entire windshield may be lowered to horizontal position over hood on vehicles with soft-top cabs only.

b. *Adjustment.* Remove roof paulin and roof panels (par. 293c(3)) on vehicles equipped with soft-top cab only. Make sure windshield brackets are seated on adjusting nuts (fig. 312) and that lock bolt wing nuts are tight. Check fit of windows against windshield frame.

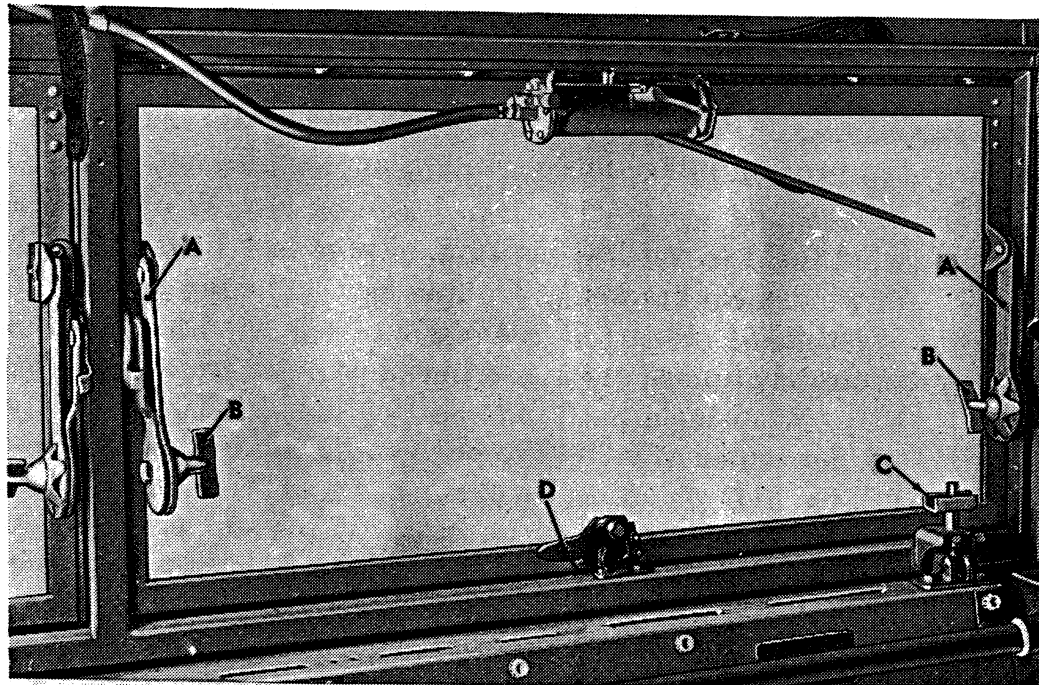

A—ADJUSTING ARM (WINDSHIELD TILT)
B—ADJUSTING ARM CLAMP SCREW

C—WINDSHIELD LOCK BOLT AND WING NUT
D—WINDSHIELD INNER FRAME LOCK HANDLE

RA PD 197745

Figure 311. Windshield controls.

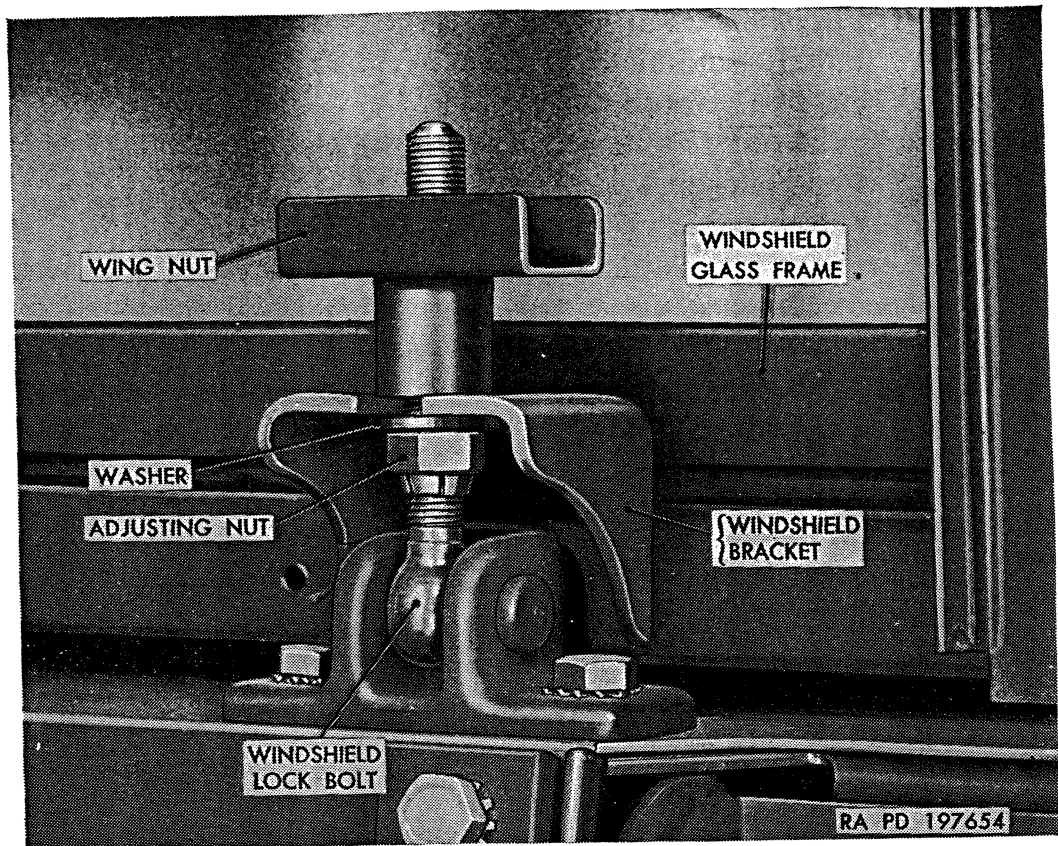

Figure 312. Windshield frame vertical adjustment.

Windows should seal against windshield without binding. If windshield requires adjustment, loosen wing nut and turn adjusting nut. Recheck for proper fit with windows. Install roof panels and roof paulin on soft-top cab only.

c. Positioning Windshield. Windshield may be positioned in various ways to provide protection, visibility, and ventilation.

- (1) *Windshield upright (soft-top cab only).* While holding windshield in vertical position, engage lock bolts (fig. 312) in windshield brackets. Tighten lock bolt wing nuts.
- (2) *Windshield tilted (all vehicles).* Each windshield half is separately hinged at top to windshield outer frame. To open either windshield half, unlatch lock handle (D, fig. 311) at bottom center of section to be opened. Loosen clamp screw (B, fig. 311) on adjusting arm (A, fig. 311) at each side and tilt section forward and upward. While supporting windshield half in desired position, tighten clamp screw at each adjusting arm.
- (3) *Windshield lowered (soft-top cab only).* Roll up roof paulin and rear curtain; then remove and stow roof panels and side panels (par. 293c(3)). While supporting windshield, unscrew wing nuts from lock bolts (fig. 312) and swing lock bolts rearward and downward. Lower windshield forward

over hood. Disengage windshield support arm on each side from clip and hook to windshield bracket bolt as shown in view B, figure 310. Tighten bracket bolt nuts.

295. Windshield Wipers and Control

a. Description. Two identical air-operated windshield wiper motors are used, one mounted at top center of each windshield half on all models. Motors are controlled by a single valve, mounted on instrument board (fig. 29) at left side. Valve is pressure-regulating-type, permitting wiper motors to operate at constant speed, regardless of normal fluctuations of pressure in vehicle air system.

b. Control Valve Adjustment.

Caution: Windshield wiper control valve must be properly adjusted to limit speed of wiper motors. Excessive motor speed will cause rapid wear of motors and depletion of air supply, with no gain in visibility through windshield.

- (1) Both windshield glasses must be kept thoroughly wetted during adjustment. With system air pressure of 35 psi or more, open control valve completely. If motors operate between 60 and 70 complete cycles (120 to 140 strokes) per minute, valve is correctly adjusted. Count as one stroke each time blade reaches end of travel. If motor speed is not in this range, adjust valve.
- (2) Loosen two setscrews and pull stop knob (fig. 313) off regulator knob. Turn regulator to operate motors at 120 to 140 strokes per minute (preferably 120 strokes) on thoroughly wetted windshield. Without disturbing adjustment, install

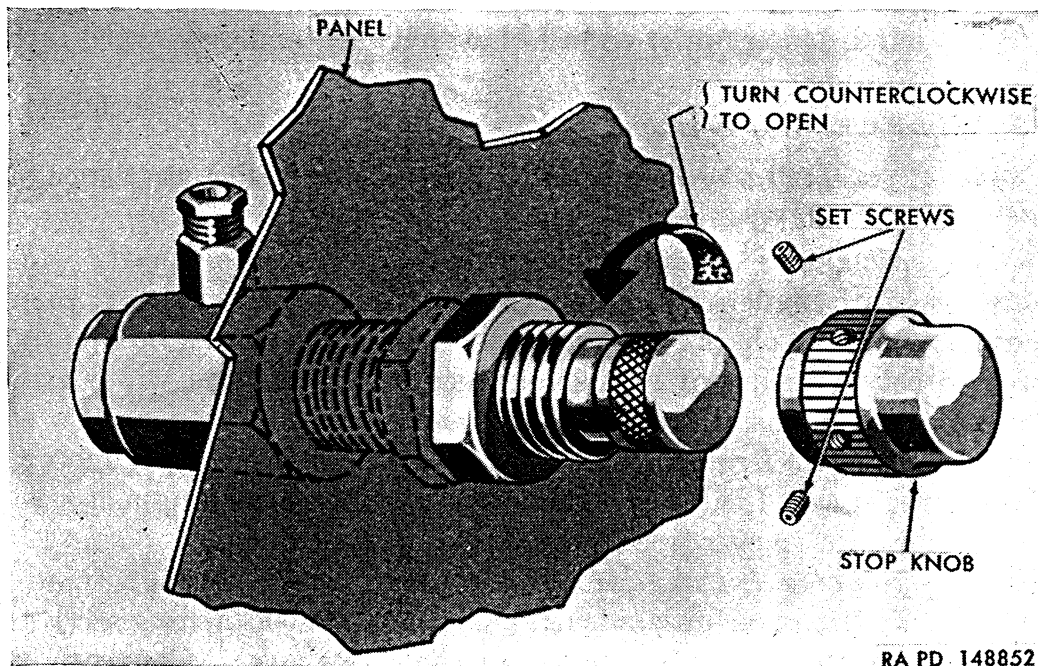

Figure 313. Windshield wiper control adjustment.

stop knob on regulator knob and while holding stop knob tight against valve body, tighten two setscrews. If adjustment is properly made, stop knob will bottom on valve body with motors operating at maximum desired speed.

c. Control Valve Replacement.

(1) *Removal.*

Note. Before replacing control valve, exhaust air pressure from air system.

Disconnect air lines at valve. Loosen two setscrews and pull stop knob (fig. 313) off regulator knob. Remove hex nut which retains valve and nameplate to instrument panel; then from underneath dash, remove valve assembly.

(2) *Installation.* From underside of dash, insert threaded end of valve assembly into hole in instrument panel. Place wiper control nameplate on valve, then loosely install retaining hex nut. Connect air lines to valve body; then final tighten valve-to-panel hex nut. Build up air pressure in air system. Adjust valve and make final installation (*b* above).

d. Wiper Blade Replacement.

(1) *Removal.* Pull wiper arm away from windshield with one hand. With other hand, swing lower end of blade outward and upward through a 180° arc. Pull blade straight away from motor shaft to remove.

(2) *Installation.* With hook on blade pointing to motor shaft, and with metal part of blade in contact with forward side of arm, engage hook by pushing blade toward shaft. Hold lower end of arm away from windshield with one hand; with other hand, swing upper end of blade outward and downward into position.

e. Wiper Arm Replacement.

Note. If present arm sweep is satisfactory, mark arm position in relation to shaft of motor before removing arm.

Remove special hex nut attaching wiper arm to motor shaft. Remove arm with blade. Place wiper arm on end of motor shaft; then operate wiper and check sweep of wiper arm which should be equally centered between sides of windshield section. Reposition wiper arm if necessary; then install special hex nut and tighten.

f. Wiper Motor Removal. Disconnect air hose from wiper motor. Remove wiper arm (*e* above). Remove two screws attaching motor to glass frame. Pull motor free from rear side of windshield.

g. Wiper Motor Installation. Insert motor shaft through windshield frame from rear of windshield and install two attaching screws. Install wiper arm with blade on motor shaft (*e* above). Connect air hose to wiper motor.

h. Air strainer.

- (1) *General.* Air supply to operate windshield wiper motors is filtered through an air strainer assembly which is located in wiper motor air supply line at junction block under dash. Air leaks at ends of strainer assembly can be detected by applying soap suds to line connections.
- (2) *Cleaning.*
 - (a) Exhaust air pressure from air system. Disconnect air line at air strainer assembly; then unscrew strainer assembly from nipple at air line junction block.
 - (b) Remove reducing bushings from ends of strainer assembly; then remove curled hair and two screen disks from strainer housing.
 - (c) Wash all parts in dry-cleaning solvent or volatile mineral spirits. Rinse and dry all parts.
 - (d) Fluff curled hair; then compress hair into strainer housing. Install screen disks, one in each end of housing, with cup-side on each disk inward. Using a sealing compound on threads of strainer end bushings, install end bushings into ends of strainer housing.
 - (e) Apply sealing compound to threads of nipple at air line junction block, then thread strainer assembly onto nipple. At opposite end of strainer assembly, connect wiper motor supply line. Tighten line connector nut.
 - (f) Build up air pressure in system and check for leaks.

296. Rear View Mirrors

(fig. 314)

a. General. One inside and two outside rear view mirrors are used on all early models. Later models are equipped with two outside rear view mirrors only.

b. Inside Rear View Mirror Replacement. Remove two screws attaching mirror and mounting bracket to center bar of windshield frame. Remove mirror with bracket. Position new mirror with mounting bracket to windshield frame and attach with two No. 10-32 x 1/2 cross-recess pan-head screws with external-teeth lockwashers. Tighten screws.

c. Outside Rear View Mirror Replacement. Remove stud nut (E) attaching mirror ball stud to mirror inner arm (H); then remove mirror assembly (G) with ball stud. Position mirror and ball stud, with 1/4-inch internal-teeth lockwasher on stud, to mirror inner arm and secure with 1/4-20 nut.

d. Outside Rear View Mirror Adjustment.

- (1) *Tilt adjustment.* Mirror-to-ball-stud tension can be adjusted by tightening or loosening three small adjusting screws (F) on back side of mirror assembly (G).

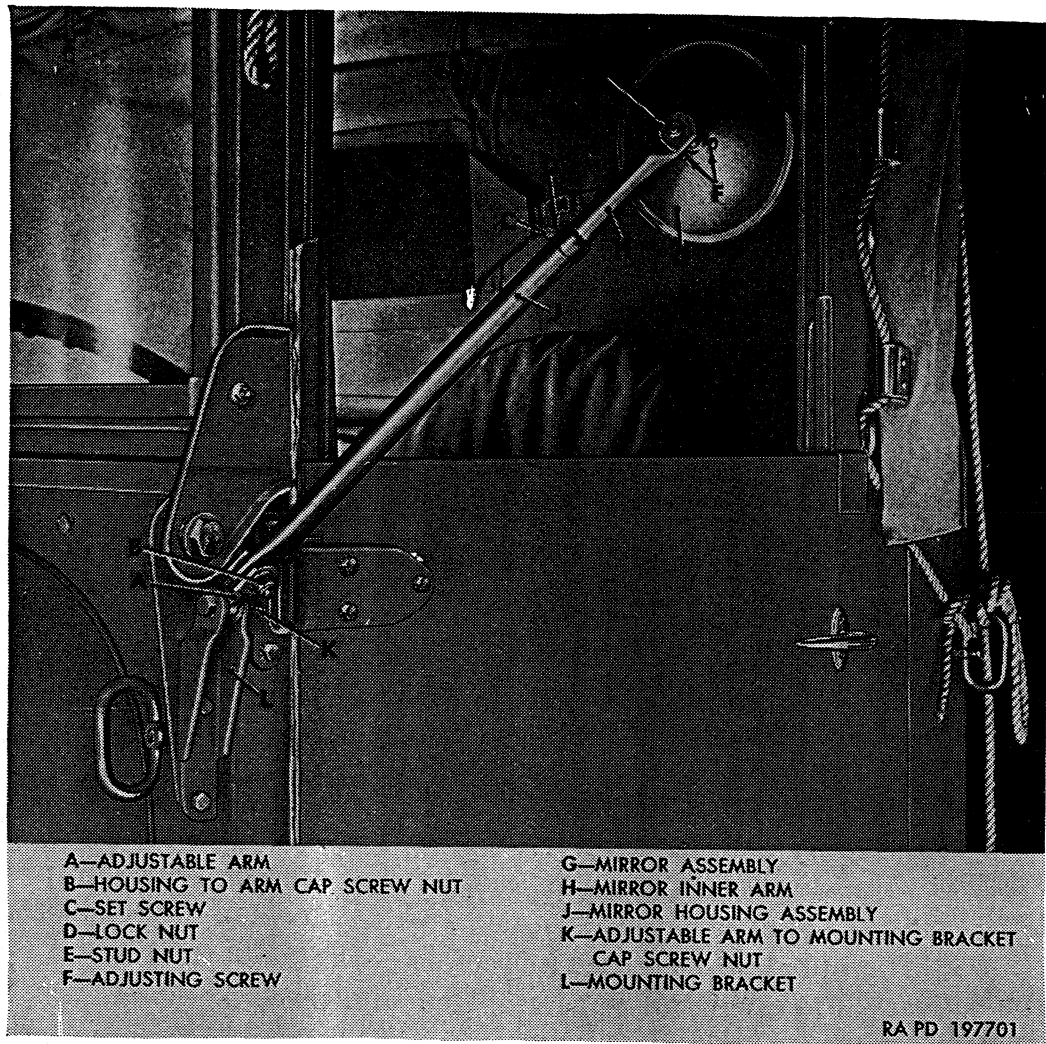

Figure 314. Outside rear view mirror.

- (2) *Extension adjustment.* Distance between mirror assembly (G) and mirror mounting bracket (L) at cab can be extended or lessened by loosening locknut (D) and setscrew (C) on mirror housing assembly (J), repositioning mirror and arm to desired position, then retightening setscrew (C) and locknut (D).
- (3) *Height adjustment.* Height of mirror assembly from mounting bracket (L) at cab can be adjusted by loosening cap screw nut (K) attaching adjustable arm (A) to mirror mounting bracket (L) at cab, repositioning mirror with arm and housing to desired elevation, then retightening cap screw nut (K).
- (4) *Fore and aft adjustment.* Adjustment is accomplished by loosening cap screw nut (B) attaching mirror housing assembly (J) to adjustable arm (A), positioning mirror assembly, then tightening cap screw nut (B).

297. Driver's Seat

(fig. 315)

a. Positioning. Driver's seat can be positioned in fore and aft direction, raising as seat is moved forward. Seat is readily removed, no tools being required. Driver's seat adjuster (D) is located at left side of seat bottom. Pull out, or lift up lever of adjuster, position seat, then release adjuster lever.

b. Removal. Lift seat cushion assembly (C) from seat frame (E) and remove from cab. Loosen wingnut (B) on lock bolt (A) at rear of driver's seat frame; then swing lock bolt forward and downward. Slide seat rearward to disengage seat support rod from seat support bracket (F) on floor. Remove seat assembly from cab.

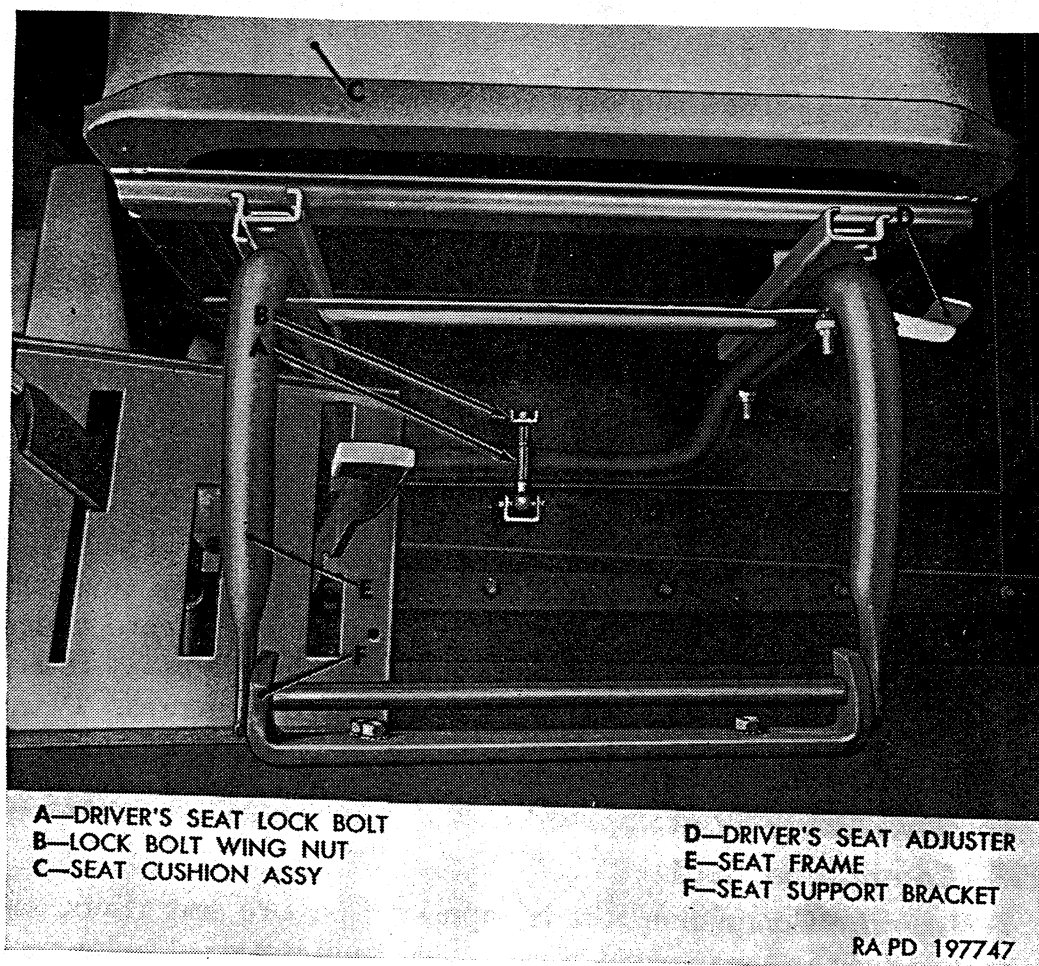

Figure 315. Driver's seat mounting.

c. Installation. Position seat assembly in cab, with seat support rod engaged in seat support bracket (F) at floor. At rear of seat, swing driver's seat lock bolt (A) upward into engagement with bracket and seat frame. Tighten lock bolt wing nut (B).

d. Driver's Seat Cushions.

(1) *Removal and disassembly.* Untie seat back cushion hold-down strap at back of seat; then lift cushion (fig. 316) from

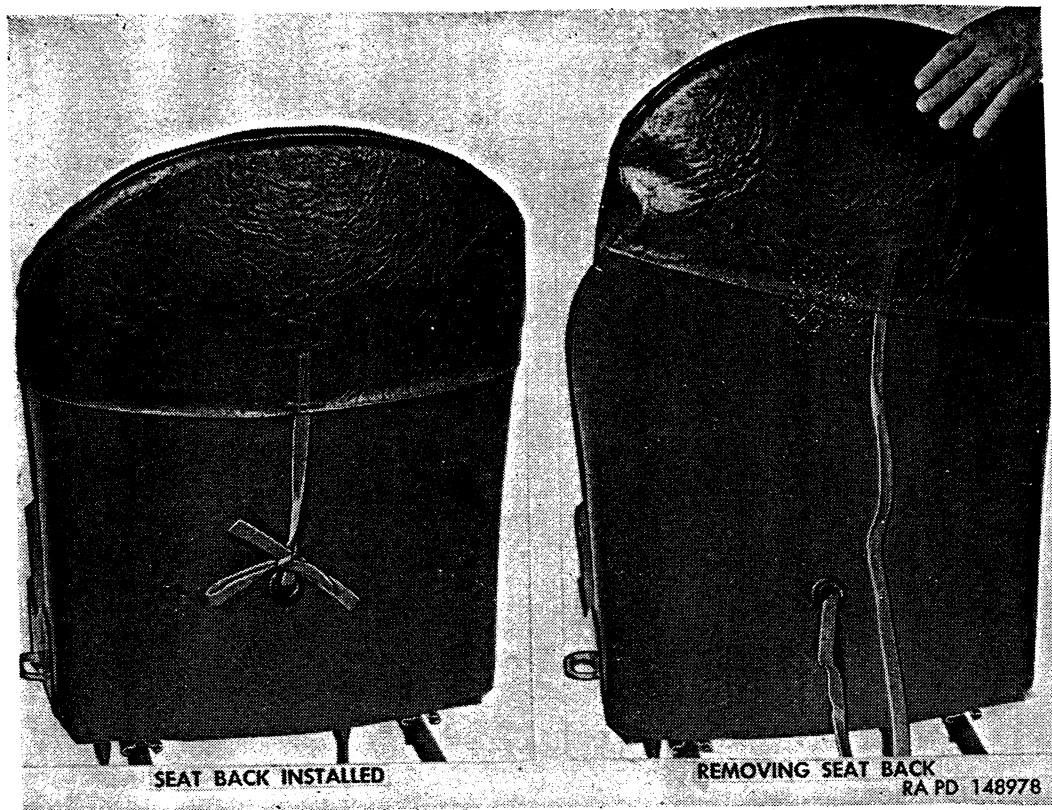

Figure 316. Driver's seat back cushion.

seat frame. Untie straps at back of seat back cushion; then pull padding from cover (fig. 317). Untie lacing cord at bottom of seat cushion. Disengage cord from hooks on seat bottom, then remove cushion cover from springs and padding.

- (2) *Assembly and installation.* Position seat cushion cover on padding and springs (fig. 317). Engage lacing cord under hooks at bottom of springs. Pull cord taut and tie. Insert pad in seat back cover, fold flap up, and tie straps. Place seat back cushion (fig. 316) on seat frame and tie holddown strap.

298. Companion Seat

a. General. Companion seat is supported on two seat risers, attached to floor and rear panel of cab. Seat back is hinged to lay forward on seat, and seat bottom can be tilted up against seat back. Latch, attached to cab rear panel, is used to hold seat back and seat bottom in upright position.

b. Positioning Seat. Companion seat may be placed in several different positions to meet varying conditions of observation and accessibility (fig. 318).

- (1) *Normal operation.* For normal driving, position seat as shown in A, figure 318.



Figure 317. Driver's seat cushion disassembled.

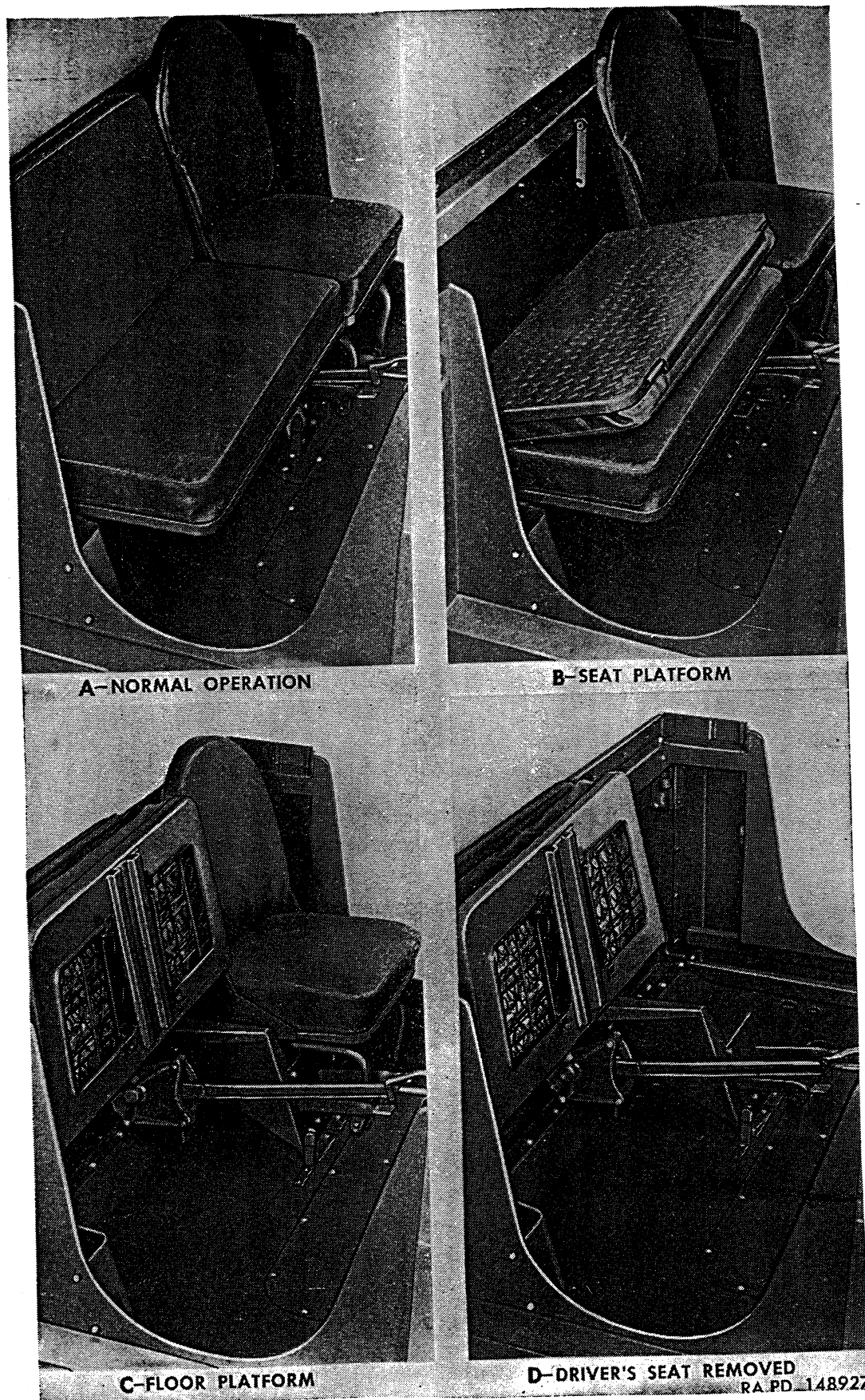

Figure 318. Seat positions.

- (2) *Seat platform.* By folding back of seat down, as shown in B, figure 318, a firm nonskid standing platform is provided.
- (3) *Floor platform.* Companion seat may be folded up (C, fig. 318) to permit standing on floor. Retain seat bottom in upright position with seat latch, which is attached to cab back panel at left of seat.
- (4) *Maximum accessibility.* To obtain maximum accessibility to interior of cab, position companion seat as shown in D, figure 318. Remove driver's seat from cab (par. 297b).

c. Seat Removal. Remove three cap screws and nuts which attach seat hinge bracket to each seat riser. Lift seat from risers and remove from cab.

d. Seat Installation. Position companion seat on seat risers. Install three $\frac{5}{16}$ -24 x $\frac{3}{4}$ cap screws and $\frac{5}{16}$ -24 nuts attaching each hinge bracket to seat riser.

e. Companion Seat Cushions.

- (1) *Removal and disassembly.* Pull bottom of seat back cushion forward and upward. Slide seat back cushion to side to disengage bead on cushion from metal channel on seat back (fig. 319). Raise seat bottom frame to vertical position. Disengage seat spring latches (fig. 320) by tapping with hammer. Lower seat bottom to horizontal position. Lift seat cushion from seat bottom frame. Untie lacing cord at bot-

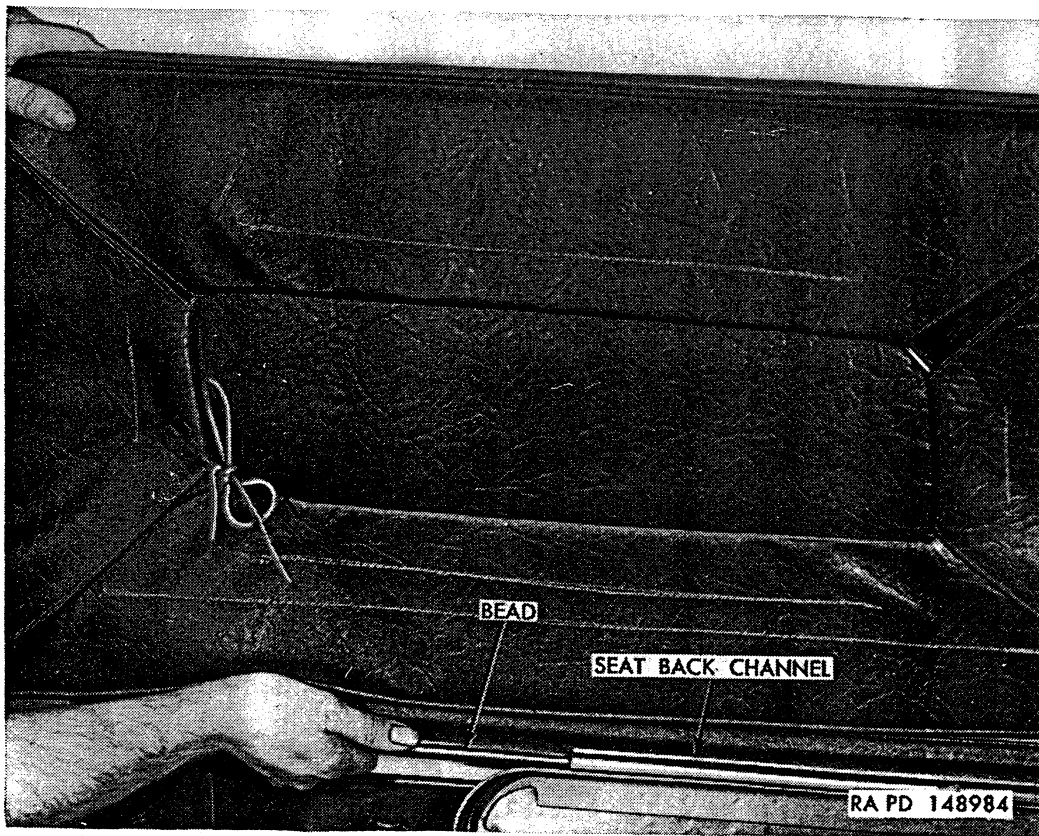

Figure 319. Companion seat back cushion removal.

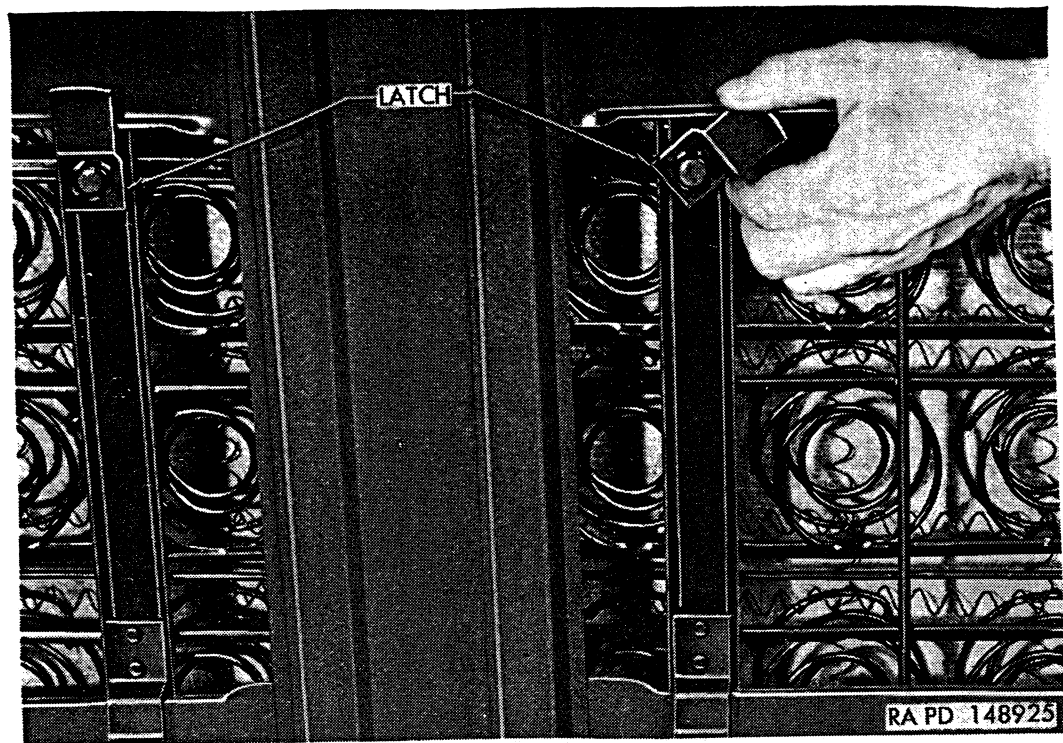

Figure 320. Companion seat cushion removal.

tom of seat cushion, disengage cord from hooks on spring, and lift cover from pads and spring (fig. 321). Untie lacing cord at back of seat back cushion, pull cord from loops in cover, and lift pad from cover.

- (2) *Assembly and installation.* Position seat back pad in cover, thread cord through loops, pull cord taut and tie. Position seat cushion cover over spring and pads (fig. 321) and engage loops of cord in hooks on spring bottom (fig. 321). Pull cord taut and tie. Position seat cushion on seat frame, raise to vertical position, and engage latches (fig. 320), by tapping with hammer; then lower seat to horizontal position. Holding seat back cushion upside down, engage bead on seat back cushion in metal channel on seat frame. Slide bead fully into seat back channel (fig. 319); then lower cushion into place.

299. Doors

a. General. Component subassemblies at doors, such as window regulator handle, lock, remote control handle, etc., can be replaced without removing door from vehicle.

b. Door Adjustments. Provision is made for adjusting door both horizontally and vertically in opening. Door lock striker and door wedge plate (fig. 322) are also adjustable.

- (1) *Horizontal adjustment.* Loosen three screws attaching each hinge to door; then shift door forward or rearward, as re-

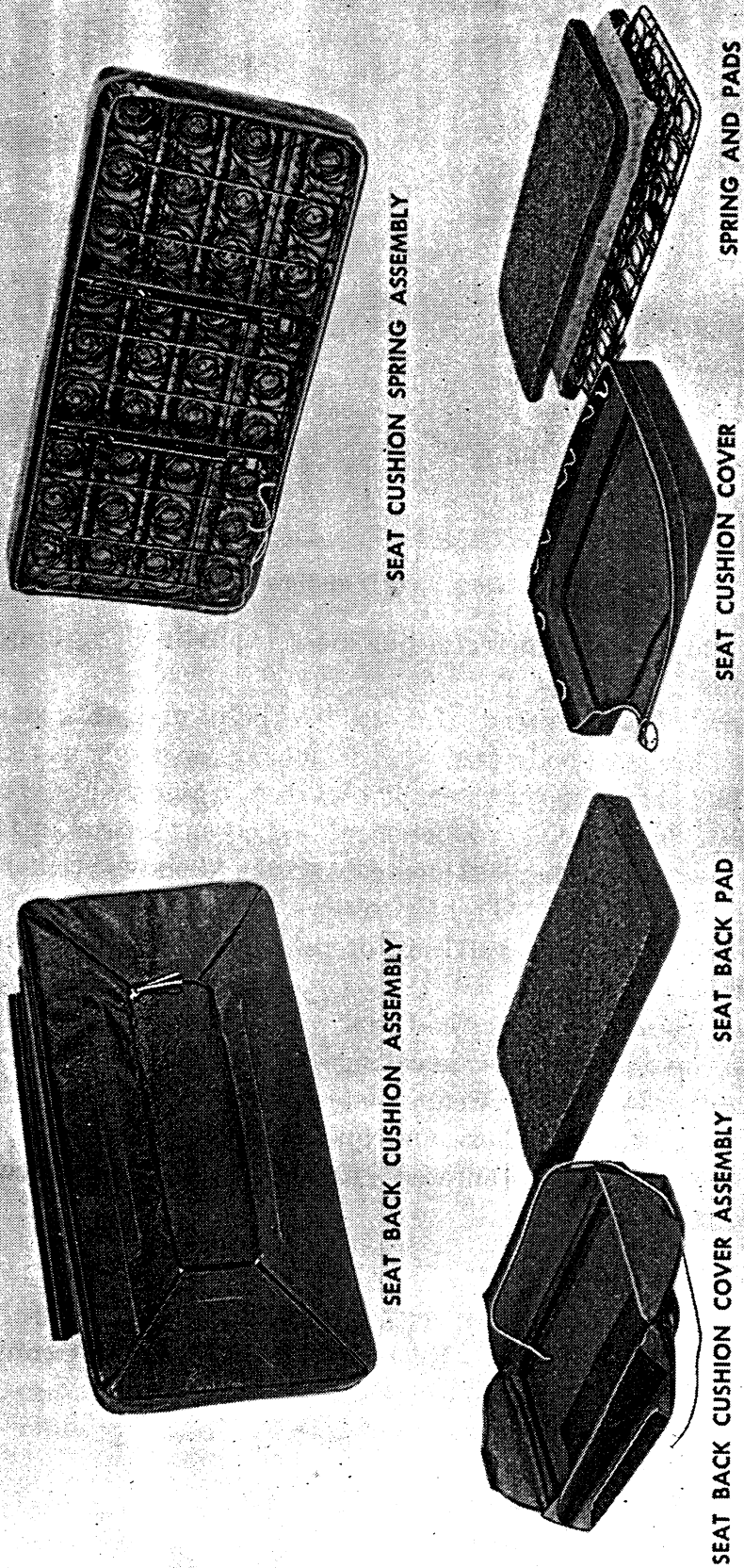

RA PD 148982

Figure 921. Companion seat cushions disassembled.

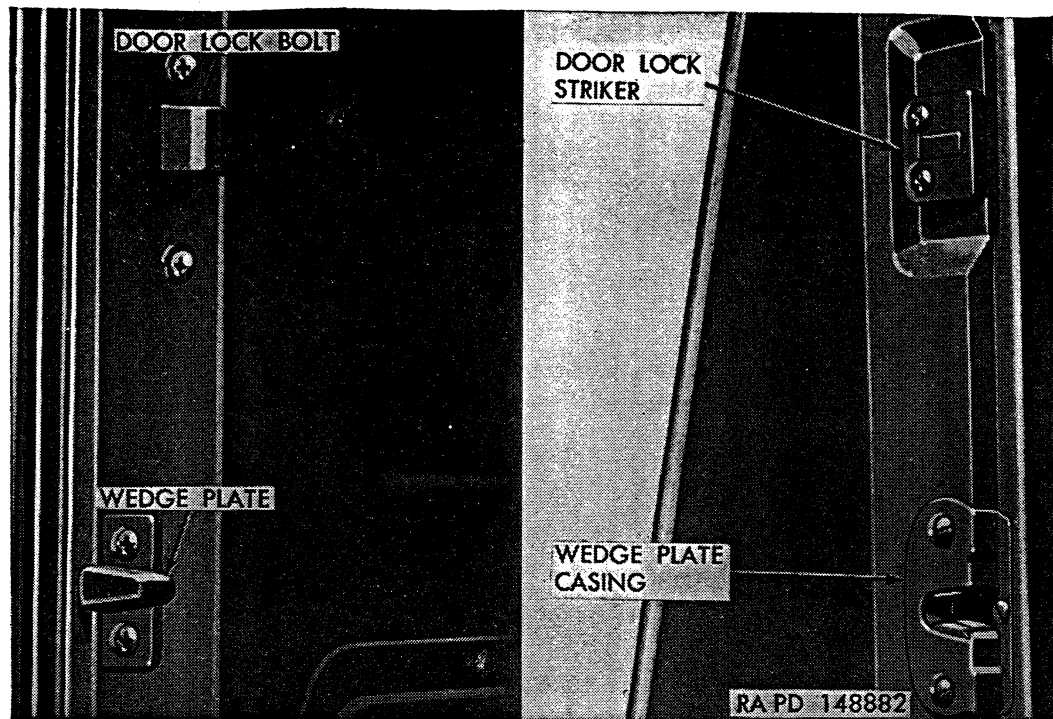

Figure 322. Door striker and wedge plate.

quired. When correct adjustment is obtained, tighten hinge bolts.

- (2) *Vertical adjustment.* Loosen two bolts and nuts attaching each hinge to body post. Shift door up or down, as required. When correct adjustment is obtained, tighten nuts.
- (3) *Door lock striker adjustment.* Loosen screws attaching striker plate (fig. 322) to cab post and move striker in or out, as required. Tighten screws, then close door to determine if looseness, rattling, or improper latching have been corrected.
- (4) *Door wedge plate adjustment.* To move wedge plate (fig. 322) on door to center in casing on cab lock post, loosen wedge plate screws. Move wedge plate up or down, as required; then tighten screws. Close and open door several times, noting if shoe is properly centered. Repeat adjustment procedure, if necessary.

300. Cowl Ventilator

a. General. Cab is equipped with two adjustable cowl ventilators, one located each side of cowl. Each ventilator is remotely controlled by a lock lever located inside of cab, forward of door hinge pillar. Ventilator lid can be placed in three open positions by moving lock lever forward.

b. Ventilator Lid-to-Cowl Adjustment (fig. 323). Snugness of ventilator lid-to-cowl can be adjusted by repositioning ventilator lock assembly on lock support bracket which is designed with slotted holes

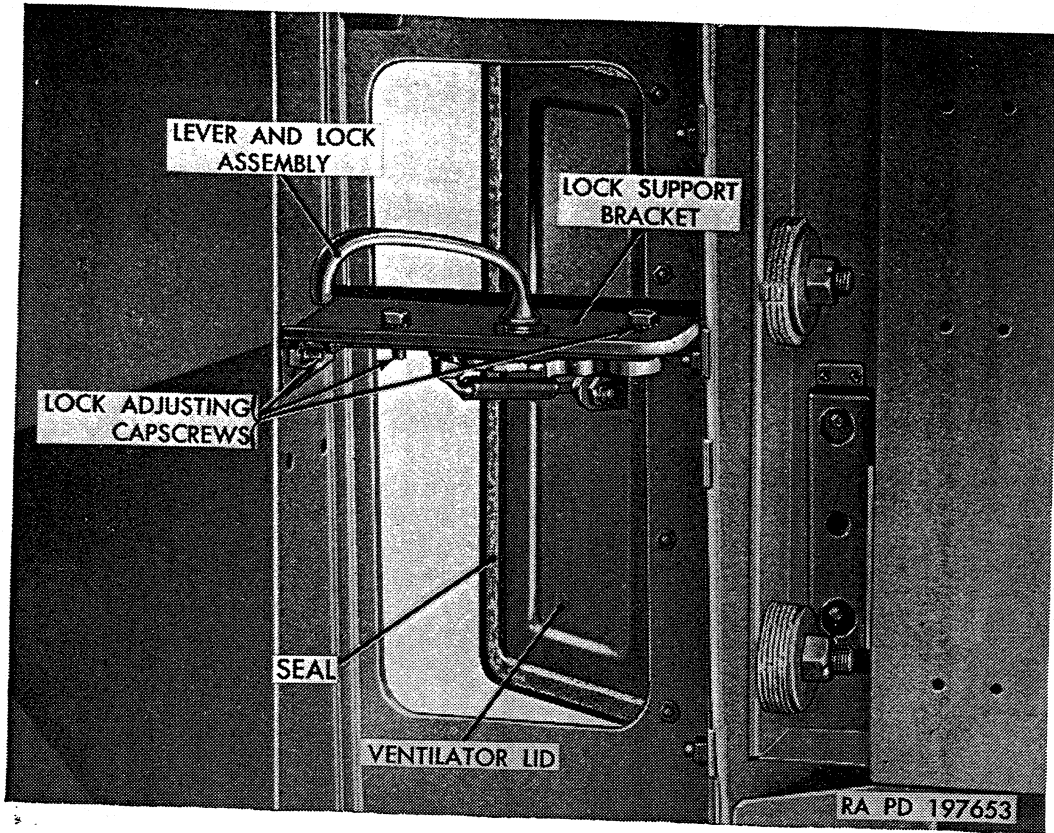

Figure 323. Cowl ventilator.

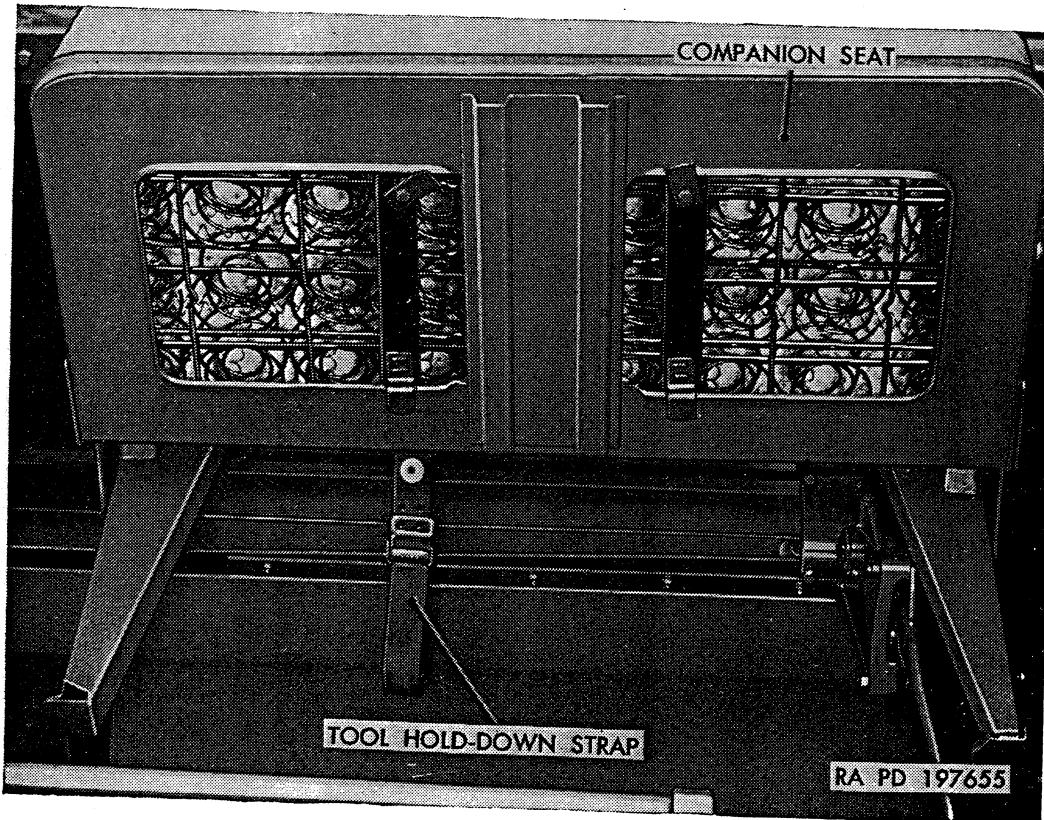

Figure 324. Pioneer tool stowage.

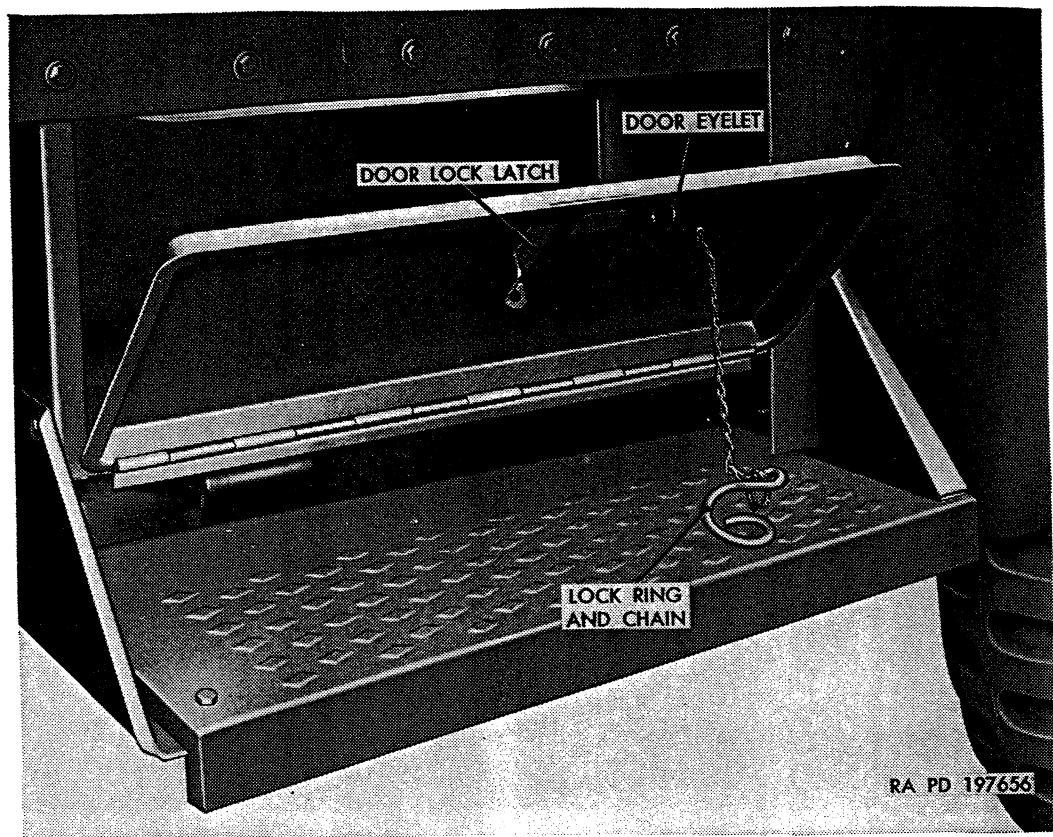

Figure 325. Tool box.

for attaching cap screws. Make lid-to-cowl adjustment as directed in (1) and (2) below.

- (1) Place lock lever forward to first-open position, then loosen two cap screws attaching lock assembly to lock support bracket.
- (2) Pull or pry lock assembly inward, pressing ventilator lid and seal against cowl opening. With retaining lock assembly in this position, tighten two lock attaching cap screws; then check fit of ventilator lid and seal.

301. Pioneer and Vehicle Tool Stowage

Pioneer tools must be stowed under companion seat on back panel of cab with a webbed tool hold-down strap, shown in figure 324. Raise companion seat bottom up to gain access to tools. Vehicle tools must be stowed in tool box (fig. 325) located under cab, above right running board. To open tool box door, disengage chained lock ring from door lock latch and eyelet, press downward on latch, then pull top of door outward and down.

Section XXXII. SHEET METAL

302. General

This section includes organizational maintenance operations on those items of sheet metal not part of chassis, cab, or body, and includes

engine hood, fenders, shields, brush guard, and running boards for all vehicles.

303. Engine Hood

a. General. The rear-hinged-type hood is retained in closed position with a conventional hood catch on each side of hood. On late models, in addition to hood side catches, hood is retained in closed position with a hood support assembly located at front of hood (fig. 327). Catch on support assembly engages bottom bar of brush guard to retain hood in closed position.

b. Hood Positions. Hood can be raised to two positions; first-raised position, for inspection and light maintenance of engine accessories, and in completely-raised position for more extensive maintenance and inspection operations. Methods of supporting hood differ on early and late models. On early models, hood is supported by two telescopic side props, which support hood in both raised positions (fig. 326). On late models, hood is supported in first-raised position by a single support at front of hood, and retained in completely-raised position by a hood tie rod (fig. 327). When not in use, hood tie rod is secured in spring-loaded clip at windshield frame.

(1) *First-raised position.*

(a) *Early models.* Release the hood catch on each side of hood. Grasp nose of hood, then lift to first-raised position (fig. 326). Telescoping side props will automatically lock and hold hood in this position.

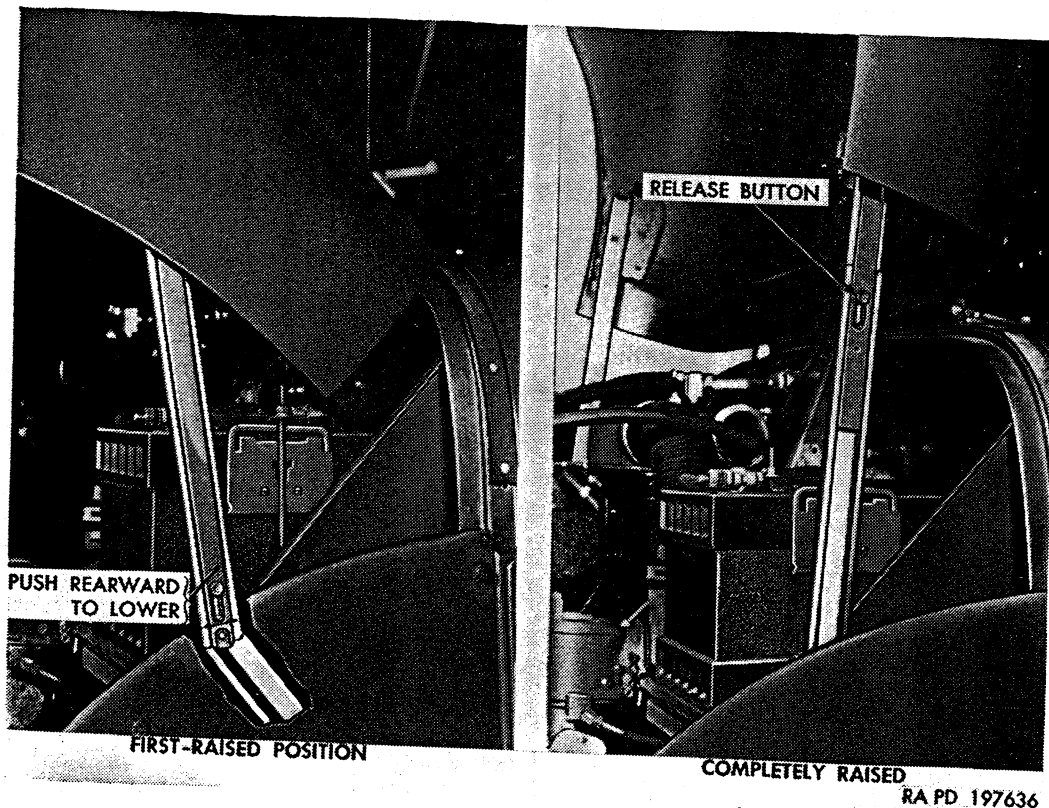

Figure 326. Positioning engine hood (early models).

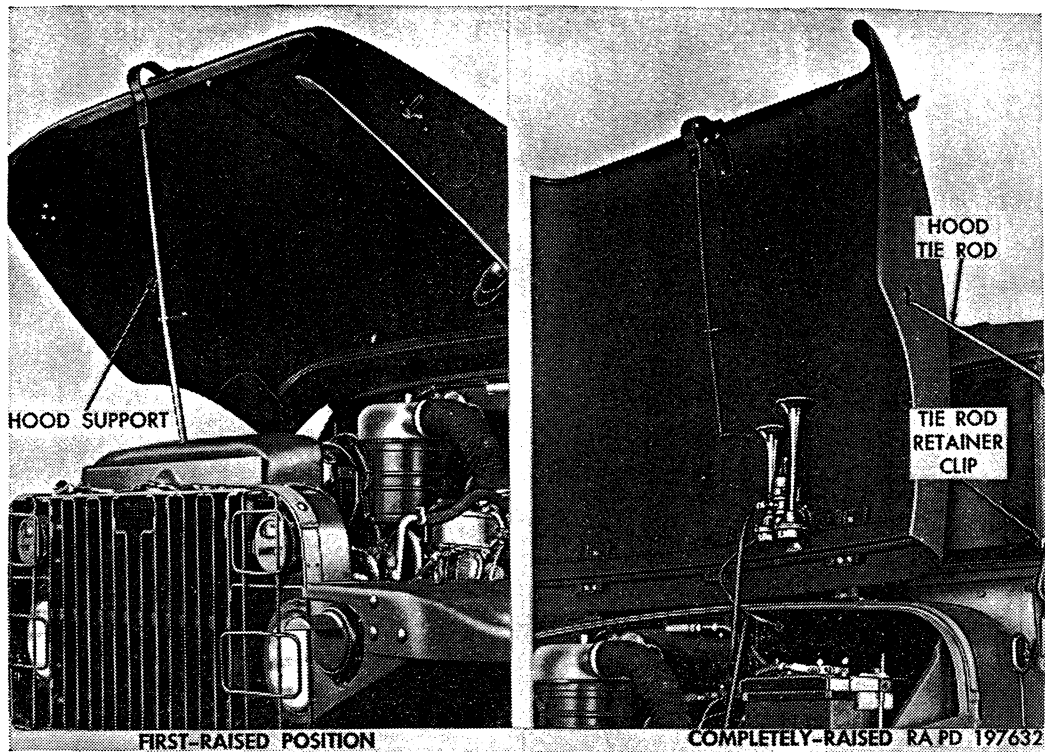

Figure 327. Positioning engine hood (late models).

- (b) *Late models.* Release the hood catch on side of hood. Pull downward and forward on hood front support, disengaging catch on support from bottom bar of brush guard. Lift hood support and hood; then place bottom of support in hole at top of radiator support (fig. 327).
- (2) *Completely-raised position.*
 - (a) *Early models.* Press release button (fig. 326) on each side prop; then raise hood to a vertical position.
 - (b) *Late models.* From left side of windshield frame, pull forward on lower end of hood tie rod, disengaging rod from spring-loaded clip. Raise hood to vertical position; then engage ball-end of tie rod in hole and slot in side of hood panel (fig. 327).
- (3) *Lowering hood.*
 - (a) *Early models* (fig. 326). To lower hood from completely raised position, press release button on each side prop; then lower hood to first-raised position. To lower hood from first-raised position, raise hood slightly; then slightly push lower prop on each side toward cab. Hood can then be lowered to closed position. Fasten hood side catches.
 - (b) *Late models* (Fig. 327). Disengage hood tie rod from slot and hole in side of hood panel. Hood can be lowered to first-raised position by placing lower end of hood support in hole on radiator support. To lower hood to closed position, raise hood support from hole in radiator support;

then lower hood. Pull downward and push inward on lower end of hood support to engage catch on support under bottom bar of radiator brush guard. Fasten hood side catches.

c. Hood Adjustment. Hood can be adjusted for close fit when lowered. Disengage hood catches; then loosen three cap screws and nuts which attach each hinge to cab cowl. Shift hood to desired position; then, without disturbing hood adjustment, tighten hinge-to-cowl cap screws and nuts.

d. Hood Replacement.

Note. The key letters noted in parentheses are in figure 328, except where otherwise indicated.

(1) *Removal.* Disengage hood catches and raise hood to completely-raised position (fig. 326 or 327). Remove cap screws (F) which attach horn support bracket to hood panel reinforcement, permitting horns to be lowered. While supporting hood, remove two cap screws (B) and nuts which attach each telescopic hood prop (C) to hood support bracket on (early models only). Lower hood to closed position. Remove hinge cap screw (G) and nut (E) from each hood hinge (D), then remove hood panel (A).

(2) *Installation.* Position hood panel (A) on vehicle, with hinge holes alined. Install one $\frac{5}{16}$ -24 x $2\frac{1}{2}$ hinge cap screws (G) and $\frac{5}{16}$ -24 hinge cap screw nut (E) at each hood hinge (D). While supporting hood panel in upright position, connect each telescopic hood prop (C) to hood support bracket as used on early models, with two $\frac{1}{4}$ -28 x $\frac{5}{8}$ prop to hood cap screws (B). With hood in upright position, attach horn bracket (with horns) to hood panel reinforcement with two $\frac{5}{16}$ -24 x $\frac{3}{4}$ horn bracket to hood cap screws (F) and lockwashers. Lower hood and fasten.

e. Hood Prop Replacement (Telescopic-Type—Early Models Only).

(1) *Removal.* Raise and support hood panel with a stick; then remove dowl extension panel (par. 304d(1)). Remove two cap screws (B, fig. 328) attaching hood support prop upper bracket to hood. Remove two cap screws attaching prop lower slide bracket to cab cowl. Remove prop assembly.

(2) *Installation.* Place prop assembly in position on vehicle; then install two $\frac{5}{16}$ -24 x $\frac{3}{4}$ cap screws and $\frac{5}{16}$ -24 nuts attaching hood prop lower slide bracket and cowl extension panel support to cab cowl. Install two $\frac{1}{4}$ -28 x $\frac{5}{8}$ prop to hood cap screws (B, fig. 328) with external-teeth lockwashers which attach hood prop upper bracket to hood panel. Install cowl extension panel (par. 304d(2)).

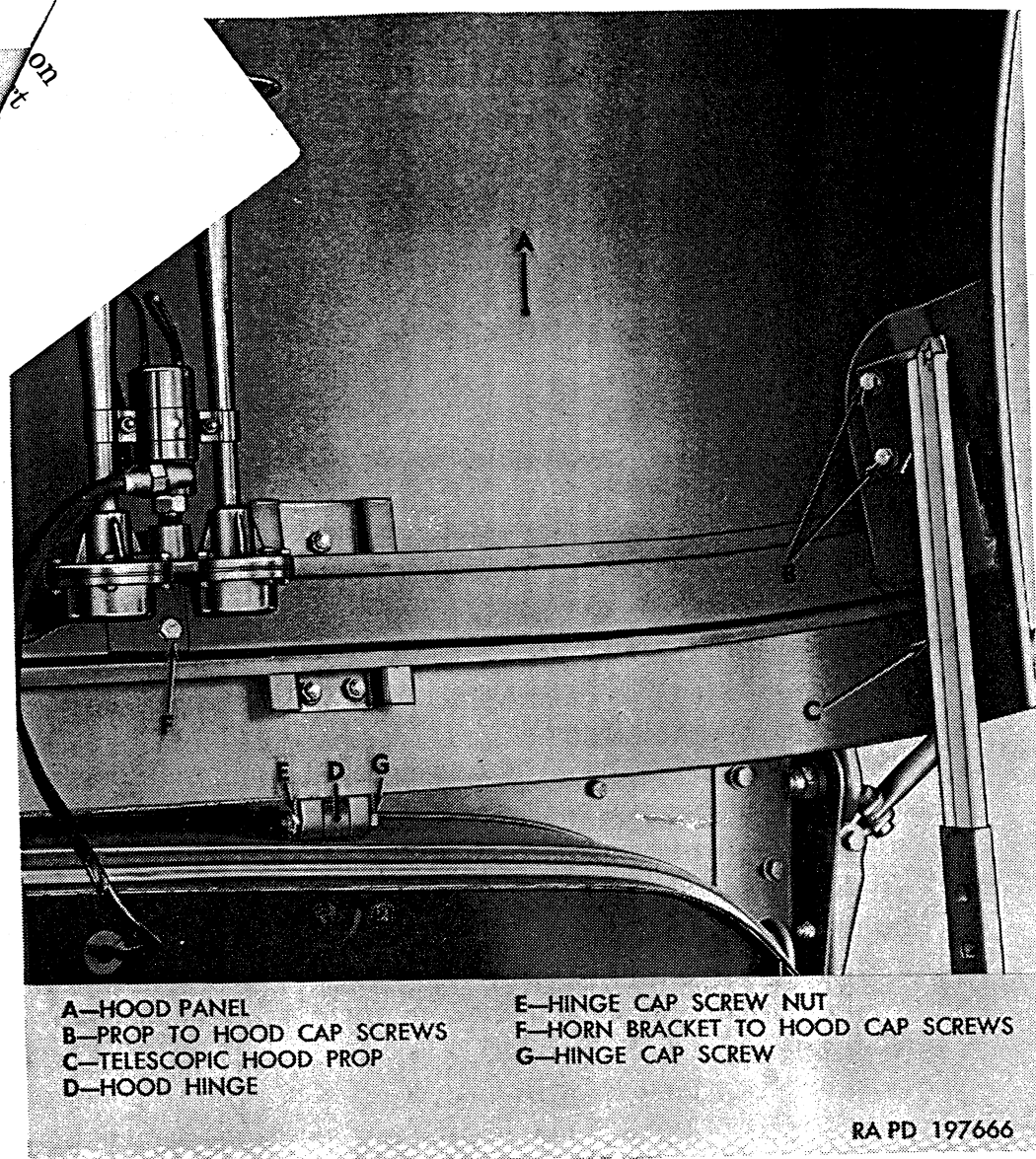

Figure 328. Engine hood installed (early model shown).

f. Hood Side Catches.

- (1) *General.* Hood panel on all models is retained in lowered position by two spring-loaded catch assemblies, one located on each fender near front of hood panel. Hood catch assemblies engage adjacent catch brackets on hood panel.
- (2) *Repair.* If breakage of catch brackets occur, replace bracket. If inspection of catch bracket indicates fractures at turn-up point of bracket, reinforce bracket before breakage occurs. Weld a short piece of $\frac{1}{4}$ -inch cold-rolled steel reinforcement, formed to contour at under-side of bracket. Weld both sides of reinforcement. Grind off sharp edges, then paint.

304. Fenders, Skirts, and Extension Panels

a. *General.* Accessibility to engine and other units under hood is greatly increased by removal of one or both extension panels and

fender and skirt assemblies. Removal of fender with skirt assembly is readily accomplished, and removal procedures are same for right and left assemblies, except as otherwise indicated in *b* and *c* below.

b. Fender with Skirt Removal. Raise hood to completely-raised position (fig. 326 or 327). Disconnect blackout driving light connections at left fender (fig. 329). From under hood, loosen bolt attaching fender to cowl extension panel. Remove five cap screws and nuts, then lift fender and attached skirt from chassis. Remove 10 cap screws attaching fender skirt to fender and fender support.

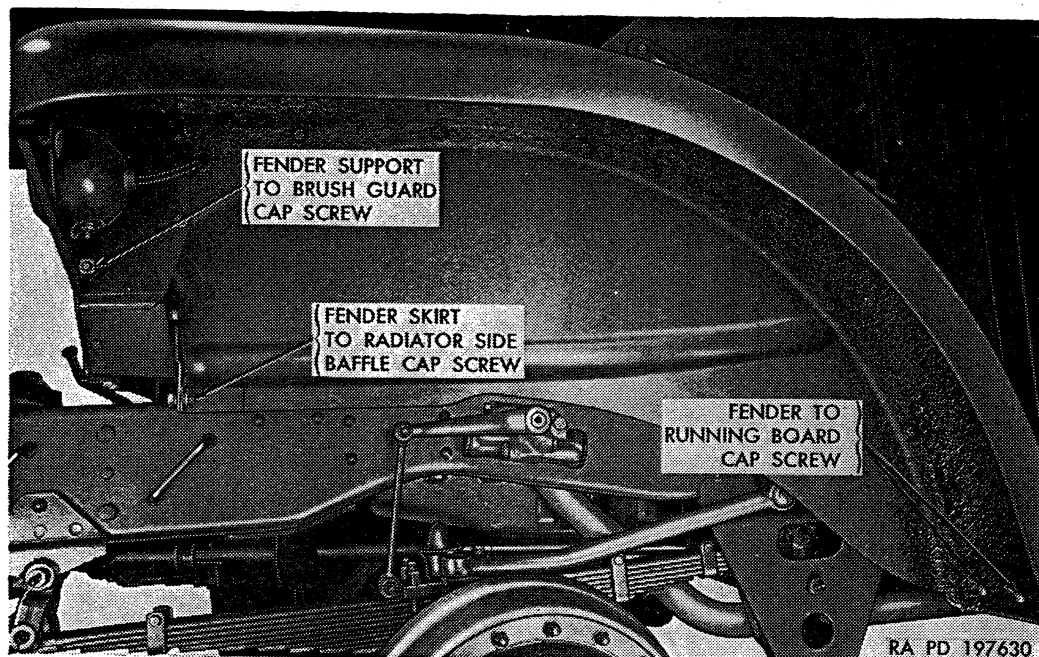

Figure 329. Fender installed (left side shown).

c. Fender with Skirt Installation (fig. 329). Install fender skirt and fender brace to fender and fender support with ten $\frac{3}{8}$ -24 x $\frac{7}{8}$ cap screws, $\frac{3}{8}$ -24 nuts, and $\frac{3}{8}$ -inch plain washers. Position fender with skirt assembled to vehicle, engaging slot in fender brace bolt in bracket of cowl extension panel. Install all fender and skirt attaching cap screws and nuts loosely. Install two $\frac{1}{2}$ -20 x 1 cap screws, $\frac{1}{2}$ -inch lockwashers, and $\frac{17}{32}$ -inch plain washers attaching each fender support to brush guard and baffle. Install one $\frac{1}{2}$ -20 x 1 cap screw, $\frac{1}{2}$ -inch lockwasher, and $\frac{17}{32}$ -inch plain washer attaching each fender skirt to radiator side baffle, position spacer between fender and running board; then install two $\frac{5}{16}$ -24 x $1\frac{3}{8}$ cap screws, $1\frac{1}{32}$ -inch plain washers, and $\frac{5}{16}$ -24 nuts attaching each fender to running board. Tighten all attaching nuts and cap screws, including cap screw at cowl extension bracket. At fender, connect blackout driving light cables. Lower hood to closed position and engage hood catches.

d. Cowl Extension Panel Replacement (fig. 330). Replacement procedures are same for either left or right panel.

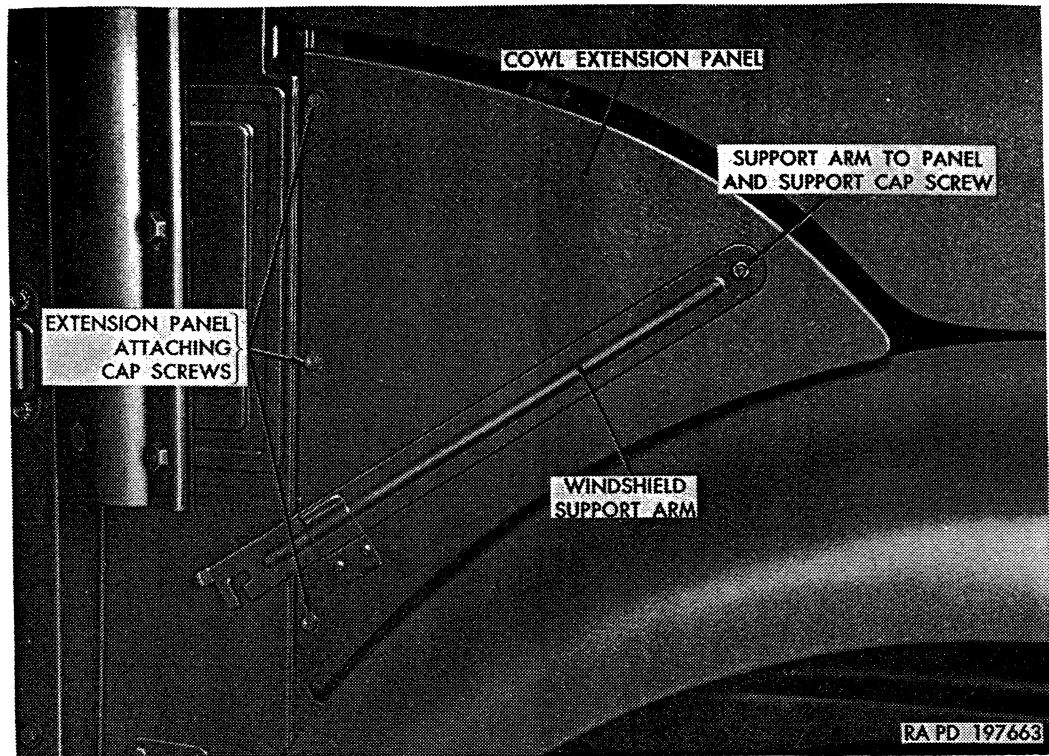

Figure 330. Right cowl extension panel installed.

- (1) *Removal.* Remove cap screw attaching windshield support arm to cowl extension panel and support, and remove arm. Remove three cap screws attaching cowl extension panel to cab cowl, and remove panel.
- (2) *Installation.* Start three $\frac{5}{16}$ -24 x $\frac{3}{4}$ cap screws, with external-teeth lockwashers, attaching cowl extension panel to cab cowl. Insert windshield support arm cap screw through cowl extension panel into extension panel support. Tighten all attaching cap screws.

305. Brush Guard

(fig. 331)

a. General. Brush guard assembly can be more readily replaced if radiator baffles, headlights, and marker lights are removed with brush guard as an assembly, and those parts removed while on bench.

b. Removal.

- (1) Place hood in completely-raised position (fig. 326 or 327). Pull wiring plug out of front end connector at right side of radiator. At left side of radiator, disconnect front marker light by disconnecting two bayonet-type connectors.
- (2) Loosen nuts on cap screws (A), but do not remove. Remove cap screws (B and C), nuts, and washers.
- (3) Lift brush guard assembly upward and forward to disengage cap screws (A) from brackets (K) on support (D).

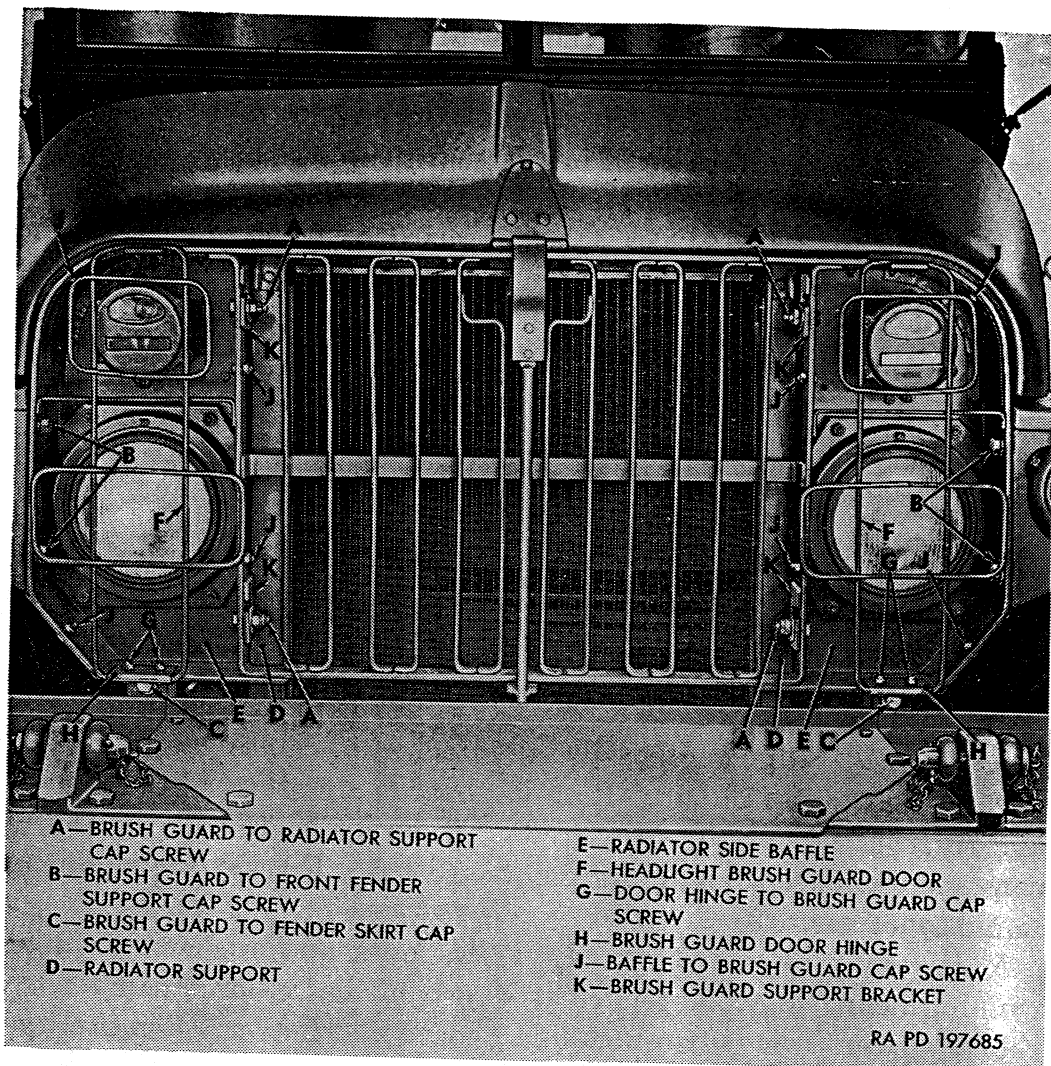

Figure 331. Brush guard installed.

- (4) Remove two cap screws and nuts attaching wiring harness clips and radiator top baffle to radiator side baffles.
- (5) Remove four cap screws (J), nuts, and washers attaching each radiator side baffle (E) to brush guard.
- (6) Remove headlight brush guard door (F) at right and left sides by removing two cap screws (G) and nuts attaching door hinge (H) to brush guard.

c. Installation.

- (1) Install headlight brush guard doors (F), using two $\frac{5}{16}$ -24 x $\frac{3}{4}$ door hinge to brush guard cap screws (G) and $\frac{5}{16}$ -24 nuts which attach brush guard door hinge (H) to brush guard.
- (2) Install right and left radiator side baffles (E) (with lights) to brush guard, using four $\frac{5}{16}$ -24 x $\frac{3}{4}$ baffle to brush guard cap screws (J), $\frac{5}{16}$ -24 nuts, and $\frac{5}{16}$ -inch lockwashers.
- (3) Install radiator top baffle and wiring harness clips to radiator side baffles with two $\frac{5}{16}$ -24 x $\frac{5}{8}$ cap screws and $\frac{5}{16}$ -24 nuts.
- (4) Install four $\frac{1}{2}$ -20 x $\frac{13}{8}$ brush guard to radiator cap screws

- (A) with $\frac{1}{2}$ -20 nuts and $\frac{17}{32}$ -inch plain washers, with nuts toward inside. Do not tighten nuts.
- (5) Position brush guard assembly to engage four $\frac{1}{2}$ -20 x $\frac{13}{8}$ cap screws (A) with brush guard support brackets (K) on radiator support (D).
 - (6) Install two $\frac{1}{2}$ -20 x 1 brush guard to front fender support cap screws (B) and $\frac{1}{2}$ -inch lockwashers on each side attaching brush guard to each fender support.
 - (7) Install one $\frac{1}{2}$ -20 x 1 brush guard to fender skirt cap screws (C) and $\frac{1}{2}$ -inch lockwasher with $\frac{17}{32}$ -inch plain washer to attach brush guard to each fender skirt. Tighten all cap screws and nuts.
 - (8) At left side of radiator, connect two bayonet-type connectors.
 - (9) Connect wiring harness connector plug at right side of radiator.
 - (10) Lower hood (par. 303b(3)).

306. Running Board

a. General. Running boards are attached to cab by means of supports bolted to cab pillars. Running boards are attached to supports and to front fenders by cap screws. Running boards are similar in construction, except right running board has a bracket for mounting liquid container.

b. Removal. Remove two cap screws, nuts, and washers attaching running board to front fender as shown in figure 332; then remove rubber spacer from between running board and fender. Remove four cap screws, nuts, and washers attaching running board to support, then remove running boards.

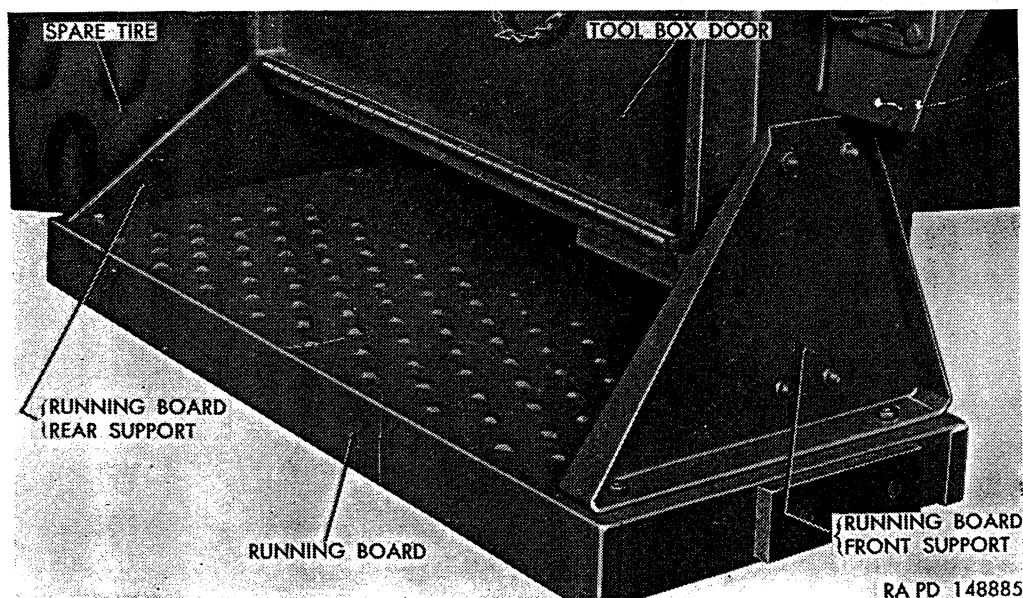

Figure 332. Right running board installed.

c. Installation. Position running board supports. Install four $\frac{5}{16}$ -24 x $1\frac{1}{2}$ cap screws, $\frac{3}{8}$ -inch plain washers, and $\frac{5}{16}$ -24 nuts attaching running board to supports. Position rubber spacer between fender and running board; then install two $\frac{5}{16}$ -24 x $1\frac{3}{8}$ cap screws, $1\frac{1}{32}$ -inch plain washers, and $\frac{5}{16}$ -24 nuts attaching running board to fender. Tighten all attaching cap screw nuts.

Section XXXIII. CARGO BODY

307. Description

a. General. This section includes description and organizational maintenance procedures on cargo body used on cargo truck M135 (figs. 1 and 2) and cargo truck M211 (figs. 3 and 4).

b. M135 Cargo Body.

- (1) Body is all-steel construction, mounted on frame in back of cab. The body bed has wheel housings at each side to clear tires.
- (2) A hinged tail gate at rear of body can be positioned to various angles from completely closed to completely down position. Tail gate on early vehicles includes a hinged step for personnel use when tail gate is completely lowered. Later models include a stationary step mounted at each side of tail gate.
- (3) Body is equipped with front and side wood stake racks. The side racks incorporate folding troop seats. The racks are equipped with bow sockets into which removable bows may be installed. Top paulin and end curtains can be installed over bows and lashed to body structure.

c. M211 Cargo Body. Body is similar in design and equipment as body described in *b* above, except that bed of body is flat (no wheel housings).

d. Body Nameplate. Body nameplate (fig. 333), on left front lower corner of body, includes manufacturer's name, body number, and dimensional data.

e. Body Drain Holes. All late cargo bodies are equipped with two water drain holes located in bed, one at each front corner. Early models did not include these drain holes and may be modified according to procedures in MWO ORD G749-W11.

308. Body Mounting

a. M135 Cargo Body (fig. 334). Body is mounted to frame side members as shown in figure 334. Dual spring-type mounting is used at each front corner of body. Three rigid-type mountings are used at each side in addition to the spring-type front mountings.

- (1) *Tightening.* At intervals indicated in table V, mounting cap screws must be checked for condition and tightness. The

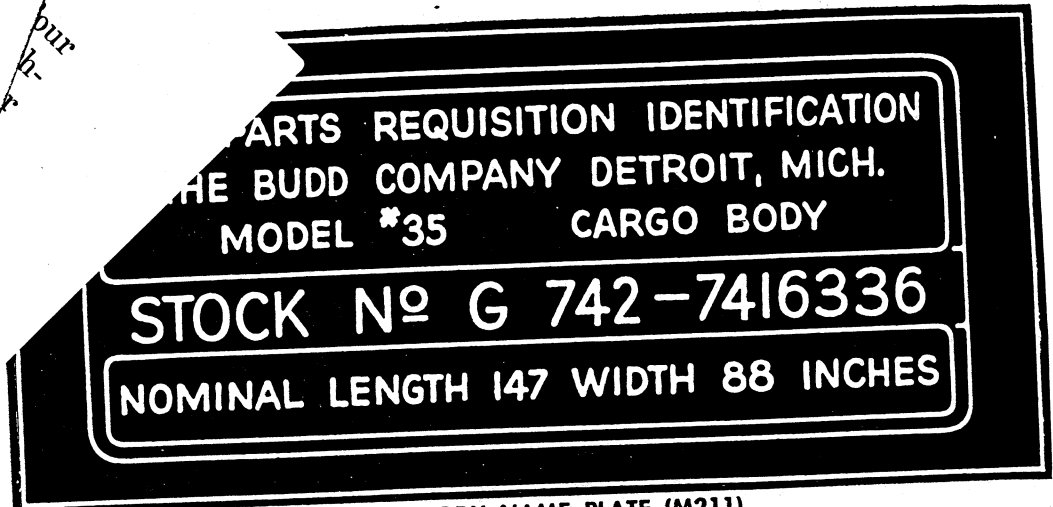

CARGO BODY NAME PLATE (M211)

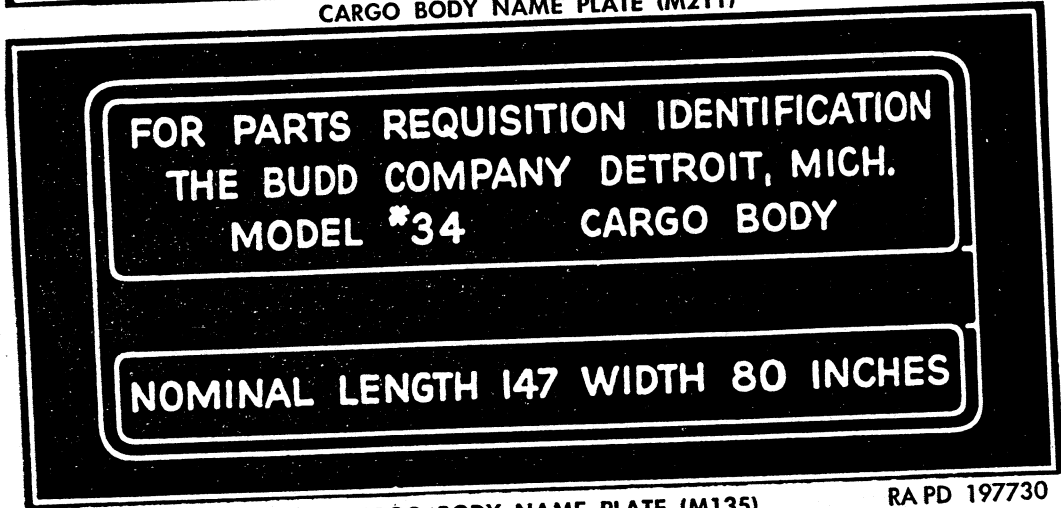

CARGO BODY NAME PLATE (M135)

RA PD 197730

Figure 333. Cargo body nameplates.

- rigid-type mounting cap screw nuts (H) must be tightened to 100 to 120 pound-feet torque. The front corner spring mounting cap screw nuts (F) must be drawn up just enough to compress springs to overall height of $6\frac{1}{2}$ to $6\frac{3}{4}$ inches.
- (2) *Removal.* On front spring-type mountings, remove cap screws nut (F), then remove holddown cap screw (E), washer (L), and inner and outer springs (M and N). On rigid-type mountings, remove cap screw nut (H). Washers (if used) and holddown cap screw (K).
 - (3) *Installation.* On front spring-type mounting, position flat washers (L), inner spring (M), and outer spring (N) on $\frac{5}{8}$ -18 x 9 holddown cap screw (E). Position cap screw through frame mounting and upper holddown brackets (G and D), then install cap screw nut (F). Tighten nut until overall length of compressed springs is $6\frac{1}{2}$ to $6\frac{3}{4}$ inches. On rigid-type mountings, position $\frac{3}{4}$ -16 x $2\frac{1}{4}$ holddown cap screws (K) through frame mounting and upper holddown

brackets (G and D). Install cap screw nut (H) and tighten to 100 to 120 pound-feet torque. Make sure two spacer clips (A) which prevent each wood spacer (B) from repositioning between body and chassis, are properly bent down.

b. *M211 Cargo Body* (fig. 335). Body is mounted to frame side member. Dual spring-type mounting is used at each front corner of body. One rigid-type mounting is used on each side of body. Body is also secured to frame by two U bolts at each side.

(1) *Tightening*. At intervals indicated in table V, body mountings must be inspected and tightened if necessary. The rigid-

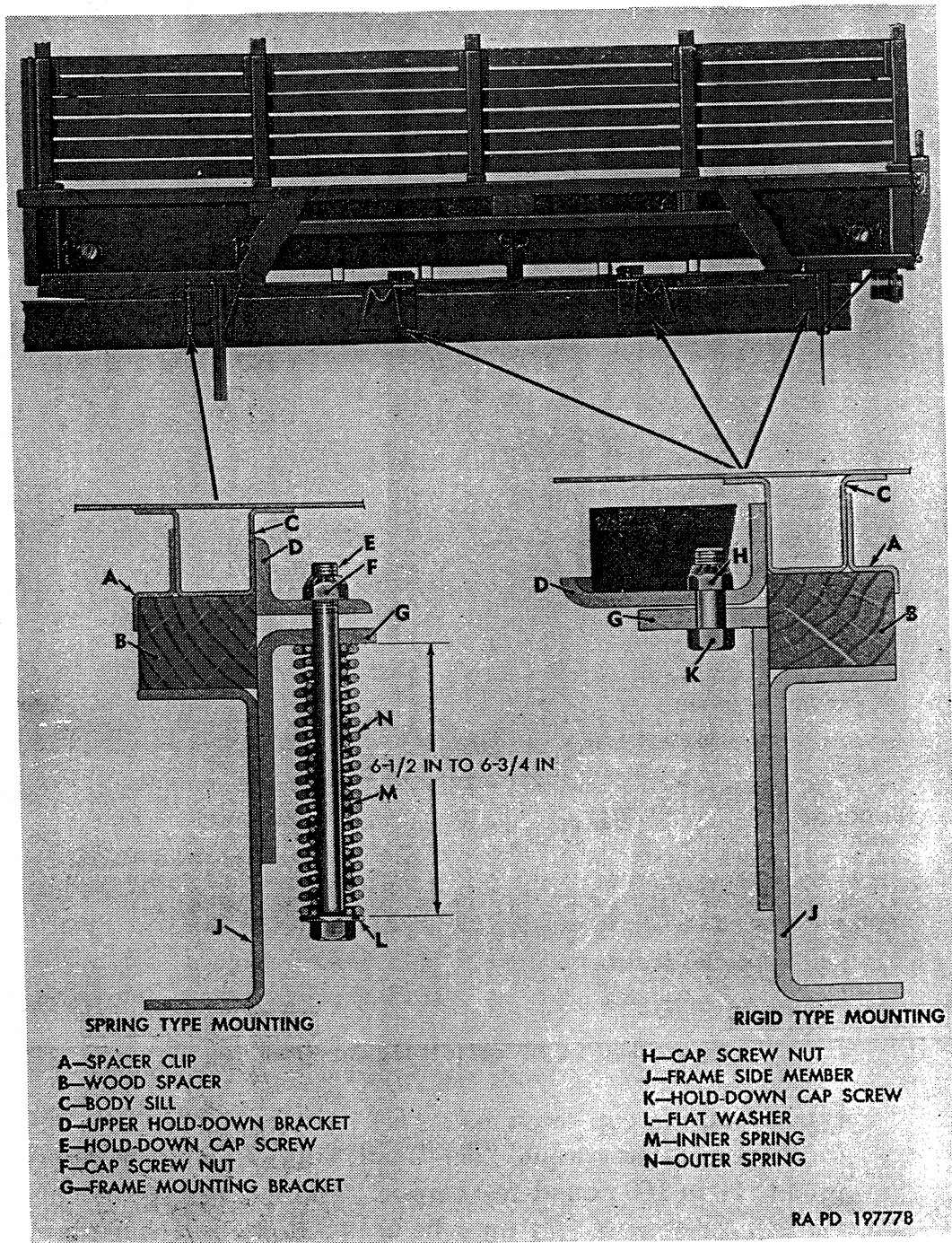

Figure 334. M135 cargo body mounting.

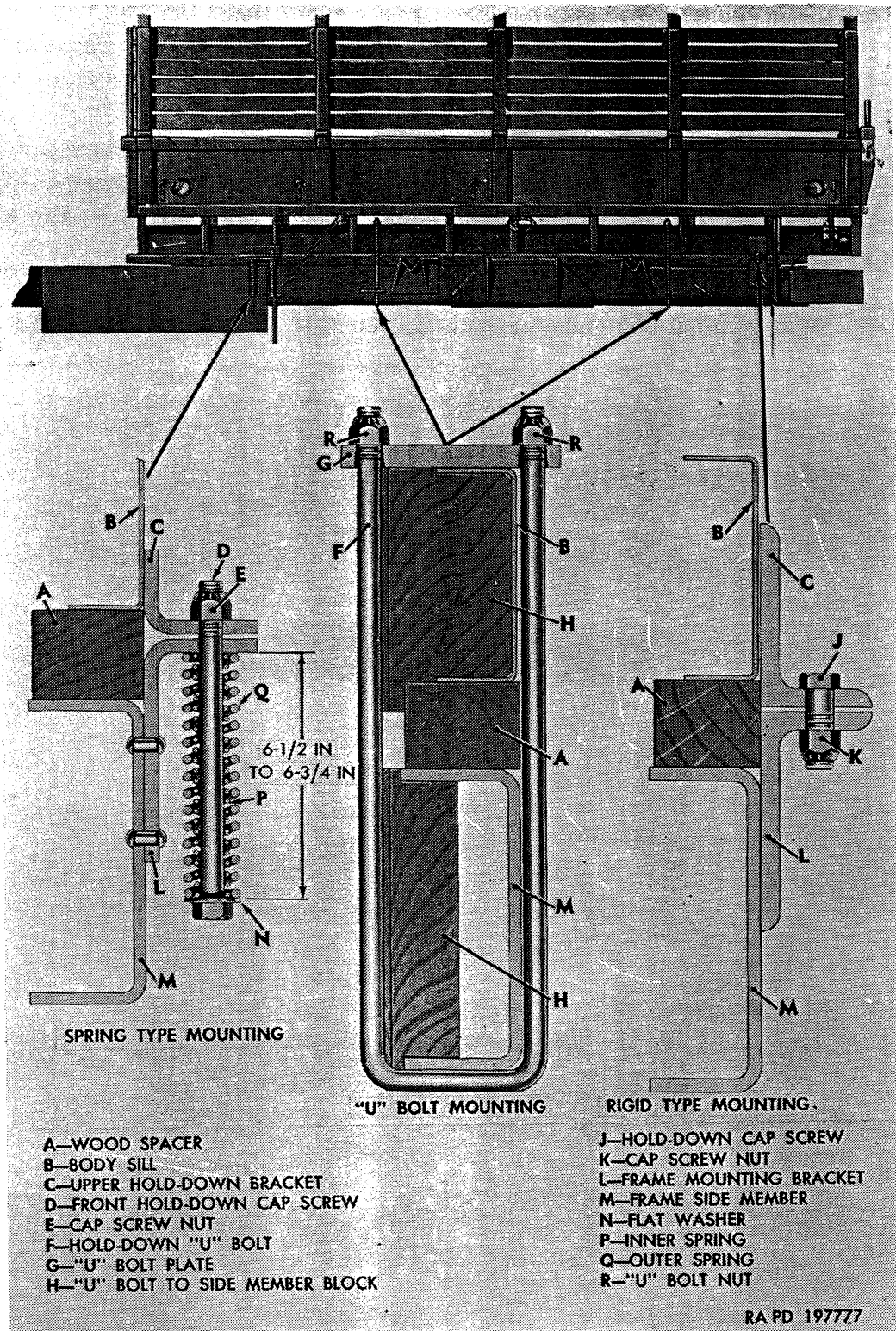

Figure 335. M211 cargo body mounting.

type mounting cap screw nuts (K) must be tightened to 100 to 120 pound-feet torque. The U bolt nuts (R) must be tightened to 90 to 100 pound-feet torque. The spring-type mounting cap screw nuts (E) must be drawn down just enough to compress springs to overall height of 6½ to 6¾ inches.

(2) *Removal.*

- (a) On spring-type mounting, remove cap screw nut (E); then remove front holddown cap screw (D), inner and outer springs (P and Q), and flat washer (N).
- (b) On rigid-type mounting, remove cap screw nut (K) and holddown cap screw (J).
- (c) On U-bolt mountings, remove U-bolt nuts (R); then remove holddown U-bolts (F), blocks (H), and plate (G).

(3) *Installation.*

- (a) On spring-type mountings, position flat washer (N), inner spring (P), and outer spring (Q) on $\frac{5}{8}$ -18 x 9 front holddown cap screw (D). Position cap screw with springs through frame mounting and upper holddown brackets (L and C). Install cap screw nut (E) and draw down until overall length of springs is $6\frac{1}{2}$ to $6\frac{3}{4}$ inches.
- (b) On rigid-type mountings, position $\frac{3}{4}$ -16 x $2\frac{1}{4}$ holddown cap screws through frame mounting and upper holddown brackets (C and L). Install cap screw nuts (K) and tighten to 100 to 120 pound-feet torque.
- (c) On U-bolt mountings, position holddown U-bolt (F), U-bolt to side member blocks (H), and U-bolt plate (G) as shown in figure 335. U-bolt plate (G) must be placed with large diameter of the tapered hole against body sill (B). Install U-bolt nuts (R) and tighten to 90 to 100 pound-feet torque.

309. Top Bows and Paulin

a. Top Paulin and End Curtains. Canvas paulins used on cargo body consist of separate top paulin, front end curtain, and rear end curtain. Top paulin is supported by bows, which are fitted into pockets in cargo racks.

Note. Do not fold or stow top paulin or end curtains when canvas is wet. Always make sure canvas is thoroughly dry before folding or stowing.

- (1) *Removal.* Untie all side and rear top paulin lashing ropes. End curtains may or may not be removed at this time. Make first fold on each side lengthwise until lower edge of paulin is even with top buckles. Make second fold lengthwise on both sides until both folds meet. Bring one folded side over the other fold. At each end, make an equal fold toward the center. Make another equal end fold until folded paulin is laying across center bow.
- (2) *Installation.* Unfold paulin and secure in place with lashing ropes.
- (3) *Positioning top paulin for ventilation.* Untie all top cover lashing ropes. Fold each side under three folds as shown in

figure 336. Straps on bows may then be fastened to buckles on top paulin.

b. Top Bows. Each bow consists of a wood center section, two steel corner section assemblies, two side stakes, and two top cover straps. Side stakes on all M135 and early M211 are wood; on late M211, side stakes are of steel. Parts are attached together by means of screws, and are easily disassembled. All bows are not interchangeable on cargo truck M135, as front and rear bows have longer stakes than intermediate bows. All bows are interchangeable on cargo truck M211.

(1) *Replacement.* Top bows are easily removed by lifting straight up to disengage from pockets in stake racks. End curtains must be removed and top paulin rolled back to remove front or rear top bows. Top paulin must be removed completely to permit removal of intermediate bows.

(2) *Stowage.* Top bows, top paulin, and end curtains may be stowed when their use hampers loading or unloading activities, or the carrying of bulky cargo. Remove rear end curtain and lash curtain against front end curtain to front top bow. Untie lashing ropes from sides and rear of top paulin cover; then, starting at rear, roll top paulin forward to front bow. Form paulin to bow in shape of an inverted U. Remove rear and intermediate bows and position bows to top paulin and front bow. Lash bows and top paulin to front bow and to hooks on front sides of body.

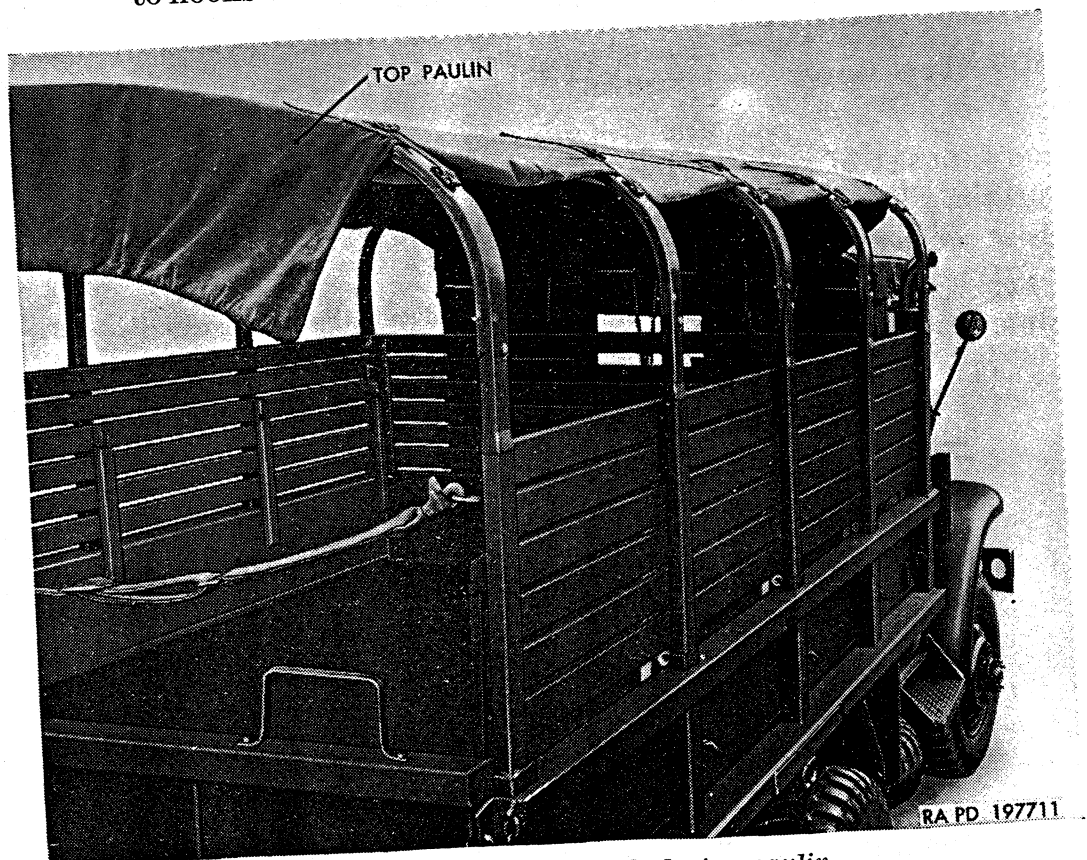

Figure 336. Positioning body top paulin.

310. Racks and Seats

a. Description. Cargo racks consist of left and right side racks, incorporating full-length troop seats, and a front rack. Rack stakes fit into pockets at sides and front of body to provide a firm support for racks. A clamp at each end of seat section holds seat in folded-up position as part of rack. When clamps are released, seats fold down and are supported on hinged legs. Tailgate is hinged to rear of body and incorporates step for use when entering or leaving the body. Step is mounted to top of tailgate and is accessible when tailgate is down. Hinged-type step used on early models is unlatched by pulling latching lever at left side of tailgate.

b. Cargo Rack Removal. Cargo racks can be removed without necessity of first removing troop seats.

- (1) *Remove troop seats only.* Remove cotter pins and hinge pins from all five hinges attaching each seat to rack stakes. Release seat clamps, disengage hinges, and lift troop seat from body.
- (2) *Remove front cargo rack.* Paulins and bows must be removed before attempting to remove any of the cargo racks. Lift straight up on front rack while standing inside body. When rack stakes are clear of front stake pockets, remove rack from body.
- (3) *Remove side cargo racks.* Remove front cargo rack ((2) above). Lift each side rack straight up to free ends of stakes from pockets at sides of body. Remove side racks from vehicle.

c. Cargo Rack Installation.

- (1) *Install side cargo racks.* Position each side rack on body with longitudinal slats on inner side of stakes. Engage stakes in pockets and push down on rack until hinge brackets fit down against body side.
- (2) *Install front cargo rack.* Position front rack on body and fit rack stakes into front stake pockets. Push down on rack, making sure lock pin at each end of rack engages eye in each side rack.
- (3) *Install troop seats only.* Position troop seats on side rack hinge brackets and align hinge holes with drifts. Install hinge pin and cotter pin in each of five hinges for each troop seat. Fold seat up against side rack and retain with seat clamp at each end of seat.

311. Tailgate

a. General. Tailgate is hinged to rear of body and incorporates step for use when entering or leaving body. Hinged-type step, used on early models, is unlatched by pulling latching lever at left side of tailgate.

b. Removal. Unhook tailgate chains and swing tailgate down. Remove cotter pin and flat washer from one end of each hinge shaft. While supporting tailgate, remove hinge shafts and remove tailgate from body.

c. Installation. Position tailgate to body and align hinges. Install hinge shafts through hinges and secure with flat washer and cotter pin at each end of each shaft. Swing tailgate up into closed position and hook chains.

312. Splash Shields

a. General. Splash shields are mounted to cargo body, both in front and at rear of rear axle wheels. Front splash shields are of one-piece all-steel construction. Rear splash shields are of two-piece construction, upper portion of metal and lower flap portion of rubber-soaked fabric. Lower flap portion of shield on early models is bolted to upper portion, whereas lower portion on later models is hinged to upper shield portion.

b. Removal. Remove four cap screws, nuts, and washers attaching each splash shield to body and to splash shield braces; then remove shield. Remove one cap screw and nut attaching each splash shield brace to body sill; then remove brace.

c. Installation.

(1) *On M135 cargo body.*

(a) *Front left splash shield.* Position splash shield to body sill with wood spacer placed between shield and body sill. Install two $\frac{3}{8}$ -24 x $1\frac{3}{4}$ cap screws and $\frac{3}{8}$ -24 nuts attaching shield and spaced to body. Install splash shield to braces and braces to body sill with four $\frac{3}{8}$ -24 x 1 cap screws and $\frac{3}{8}$ -24 nuts. Tighten nuts.

(b) *Front right splash shield.* Attach splash shield to body sill with two $\frac{3}{8}$ -24 x $\frac{3}{4}$ cap screws and $\frac{3}{8}$ -24 nuts. Attach two shield braces to shield and body sill with four $\frac{3}{8}$ -24 x 1 cap screws and $\frac{3}{8}$ -24 nuts. Tighten all nuts.

(c) *Rear splash shields.* Attach each splash shield to body sill with two $\frac{3}{8}$ -24 x $2\frac{3}{4}$ cap screws and $\frac{3}{8}$ -24 nuts. Install each shield brace to body sill with a $\frac{3}{8}$ -24 x 1 cap screw and $\frac{3}{8}$ -24 nut. Install lower end of each brace to splash shield with a $\frac{3}{8}$ -24 nut. Tighten all nuts.

(2) *On M211 cargo body.*

(a) *Front left splash shield.* Install splash shield to body sill with two $\frac{3}{8}$ -24 x 2 cap screws and $\frac{3}{8}$ -24 nuts. Install each shield brace to body sill with a $\frac{3}{8}$ -24 x 1 cap screw and $\frac{3}{8}$ -24 nut. Install lower end of each brace to splash shield with a $\frac{3}{8}$ -24 x 2 cap screw and $\frac{3}{8}$ -24 nut. Tighten all nuts.

(b) *Front right splash shield.* Install splash shield to body sill with two $\frac{3}{8}$ -24 x 1 cap screws and $\frac{3}{8}$ -24 nuts. Attach

each shield brace to body sill with one $\frac{3}{8}$ -24 x 1 cap screw and $\frac{3}{8}$ -24 nut. Install lower end of each brace to splash shield with a $\frac{3}{8}$ -24 x 1 cap screw, $\frac{3}{8}$ -24 nut, and $\frac{3}{8}$ -inch flat washer. Tighten all nuts.

- (c) *Rear splash shields.* Using six $\frac{3}{8}$ -24 x 1 cap screws and $\frac{3}{8}$ -24 nuts, install splash shield to body sill, splash shield to braces, and braces to body sill. Tighten all nuts.

Section XXXIV. WINCH AND CONTROLS

313. Description and Data

a. Description.

- (1) *Winch.* The worm-gearred, jaw-clutch, drum winch assembly (when used) is mounted at front of vehicle on support brackets attached to frame side members as shown in figure 337. Winch is driven by power-take-off through a drive shaft. Winch is equipped with a manually operated clutch control lever and a drum lock poppet knob (fig. 337). The

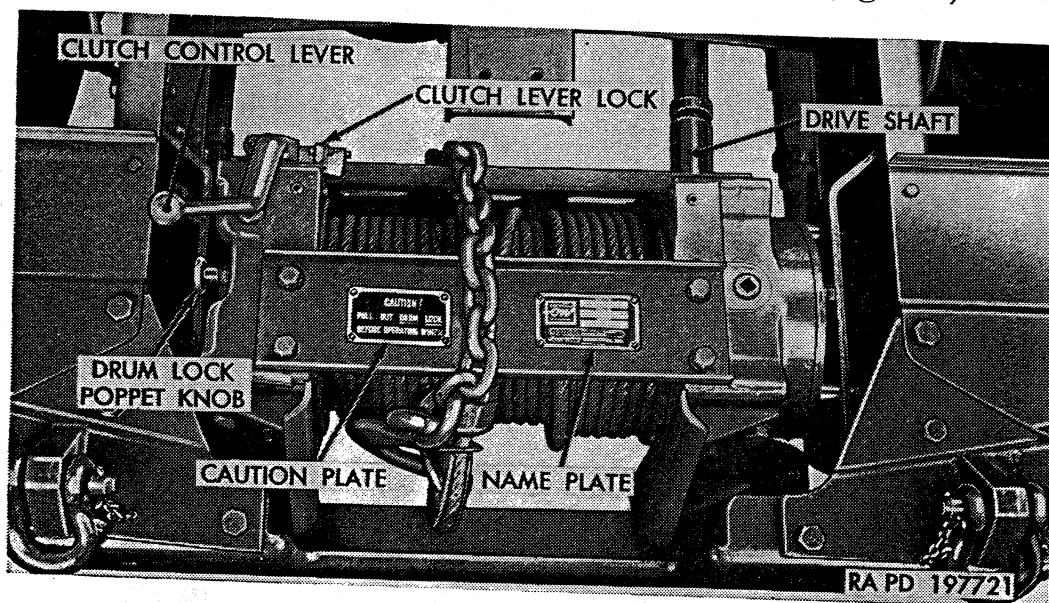

Figure 337. Winch installed.

clutch control lever is used to engage or disengage the jaw clutch which drives the drum. The drum lock poppet knob is used to lock the drum when winch is not being used. Winch is equipped with two brakes, the drum drag brake and the drive worm automatic brake. The drag brake consists of a flat shoe and lining assembly, spring-loaded to exert a constant drag on end of drum to prevent drum spinning when cable is being pulled off drum. The drive worm automatic brake, which sustains the load when shifting power-take-off gears, consists of an external band type brake which acts on a brake disk (fig. 340) keyed to end of drive worm.

- (2) *Drive system.* The winch drive system (fig. 341) consists of two drive shafts connected at center by a universal joint and supported by a pilot bearing. There is also a universal joint at each end of the drive shaft assembly. The rear universal joint consists of a fixed yoke, which is attached to power-take-off shaft by a setscrew and key, and a slip yoke which is splined to rear drive shaft. Center universal joint consists of two fixed yokes which are attached to front and rear drive shafts by woodruff keys and taper groove pins. Front universal joint consists of a fixed yoke which is attached to winch drive worm by a shear pin, and a slip yoke which is splined to the front drive shaft. The two yokes of each universal joint are assembled together with a universal joint journal, four bushing-type bearings, and four snap rings, with a cork seal and a metal seal retainer on each arm of the journal to retain lubricant in bearings. The pilot bearing assembly, consisting of a ball bearing mounted in a bracket attached to left front spring and lower torque rod rear bracket, supports the rear end of the front drive shaft.

b. Data.

Manufacturer----- Gar Wood Industries, Inc
 Model----- CA514
 Type----- horizontal drum
 Drive----- drive shaft from power-take-off
 Capacity----- 10,000 lb
 Cable----- 200-ft. long, 1/2-in. diameter with 4-ft. chain with hook

314. Shear Pin Replacement

(fig. 338)

a. General. Shear pin is inserted through winch worm shaft and front universal joint, and is held in place by a cotter pin at each end of shear pin. Pin will shear when winch is overloaded.

b. Removal.

- (1) Loosen setscrews in front drive shaft stop, then slide stop toward rear.
- (2) If shear pin is broken, pull universal joint toward rear until removed from winch shaft; then drive out broken pin. If shear pin is not broken, remove cotter pin from each end of shear pin, drive out pin, then slide universal joint off winch shaft. Discard shear pin.

c. Inspection, Repair, and Lubrication.

- (1) *Inspection and repair of universal joint yoke.* Examine shear pin hole through hub of yoke for elongation. If hole is worn, new hole may be drilled at right angle to the old hole. Hole must be drilled exactly on centerline and square with bore of yoke. Using a drill press, drill and ream a

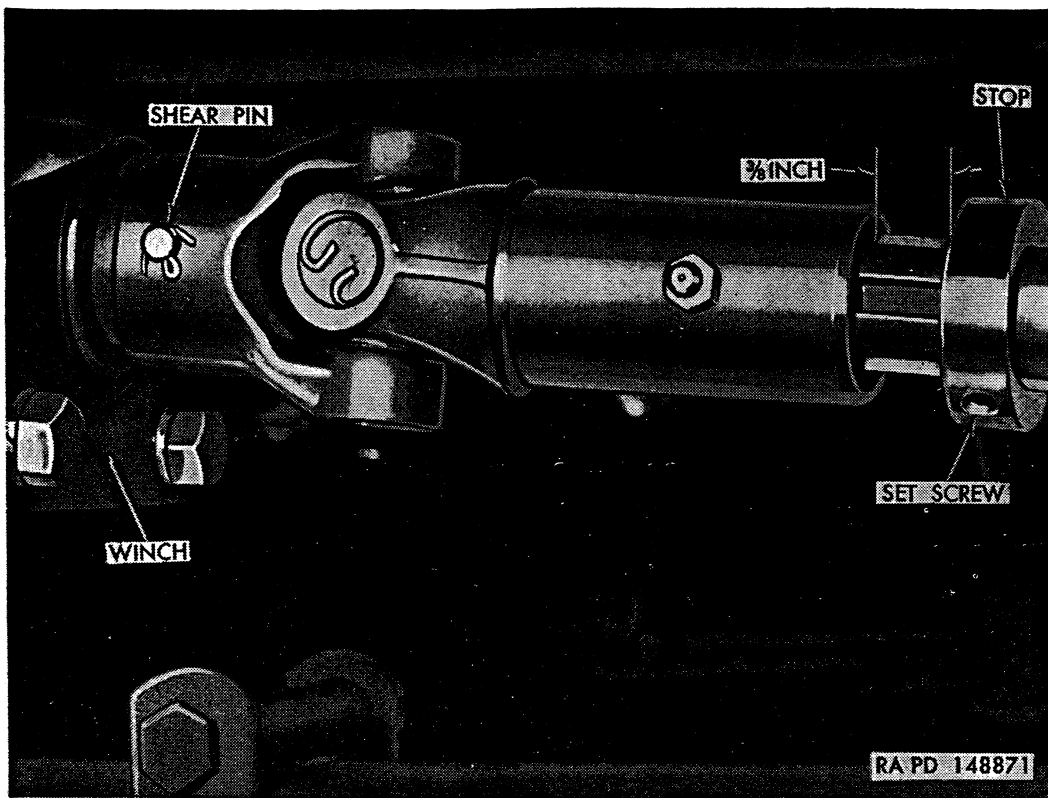

Figure 338. Shear pin installed.

0.3125- to 0.3166-inch diameter hole, with centerline of hole one-half of an inch in from end of yoke hub. Old holes should be plugged to prevent installing shear pin in worn holes.

- (2) *Lubrication.* Clean winch shaft and inside of universal joint yoke, then wipe dry. Coat shaft and inside of universal joint yoke with preservative lubricating oil (PL) special to prevent rusting.

d. Installation.

Caution: Standard shear pins are aluminum-alloy. Do not use rivets, bolts, or pins of other metals as substitutes for the standard shear pin. A magnet may be used to determine material of pins.

- (1) Position universal joint yoke on winch shaft with shear pin holes in alinement.
- (2) Dip new shear pin in preservative lubricating oil (PL) special; then insert pin through universal joint yoke and winch shaft. Install $\frac{1}{16} \times \frac{1}{2}$ cotter pin at each end of shear pin. Bend ends of cotter pins.
- (3) Move front drive shaft stop toward universal joint yoke until there is $\frac{3}{8}$ -inch clearance between stop and yoke. Tighten $\frac{3}{8}$ -16 $\times \frac{1}{2}$ hex-socket setscrew in stop. This adjustment allows for movement between front drive shaft and universal joint yoke, and prevents universal joint backing off winch shaft when shear pin is broken.

315. Winch Lubrication

a. General. Refer to lubrication chart (par. 69) for intervals of lubrication and types of lubricant.

b. Winch Cable. Lubricate cable as described in paragraph 318*c*.

c. Winch Worm Housing.

(1) *Checking level.* Remove level plug at end of housing (AG, fig. 87). Add lubricant through filler plug opening (AE, fig. 87) at top of housing. Lubricant level must be up to filler plug opening. Install plugs.

(2) *Draining and refilling.* Housing should be drained while lubricant is hot, preferably immediately after operation. Remove plug (AH, fig. 87) at bottom of housing to drain lubricant. Install and tighten drain plug. Remove level and filler plugs ((1) above). Fill through filler plug until lubricant is up to filler plug opening. Install and tighten filler and level plugs.

d. Winch End-Frame Housing.

(1) *Checking level.* Remove filler plug from top of housing (AF, fig. 87). Check level of lubricant with a rule. Proper lubricant level is $7\frac{5}{8}$ -inches below top of housing. Fill to correct level and install plug.

(2) *Draining and filling.* Housing should be drained while lubricant is hot, preferably immediately after operation. Remove plug at bottom of housing (AD, fig. 87) to drain lubricant. Install and tighten drain plug. Fill through filler plug opening as described in (1) above.

316. Tests and Adjustments

a. Adjustment Tests.

(1) *Operation of winch.* Refer to paragraph 49 for winch operating instructions before attempting adjustment checks.

(2) *Drag brake test.* At winch, place controls as described in paragraph 49*f*. Start pulling cable off drum. Drum should cease to revolve as soon as cable pull is stopped. If drum overruns cable, then drag brake requires adjustment (*b* below).

(3) *Automatic brake test.* The most convenient method of testing automatic brake is to tow another vehicle up grade with the winch (par. 49*d* (2)). Tow vehicle up grade part way, release accelerator, and shift power-take-off lever into CENTER-NEUTRAL position. Vehicle being pulled by winch should not roll backward. If winch will not hold vehicle, adjust automatic brake (*c* below).

b. Drag Brake Adjustment (fig. 339). Turn slotted adjusting screw with offset screwdriver. Screw is located at right side of

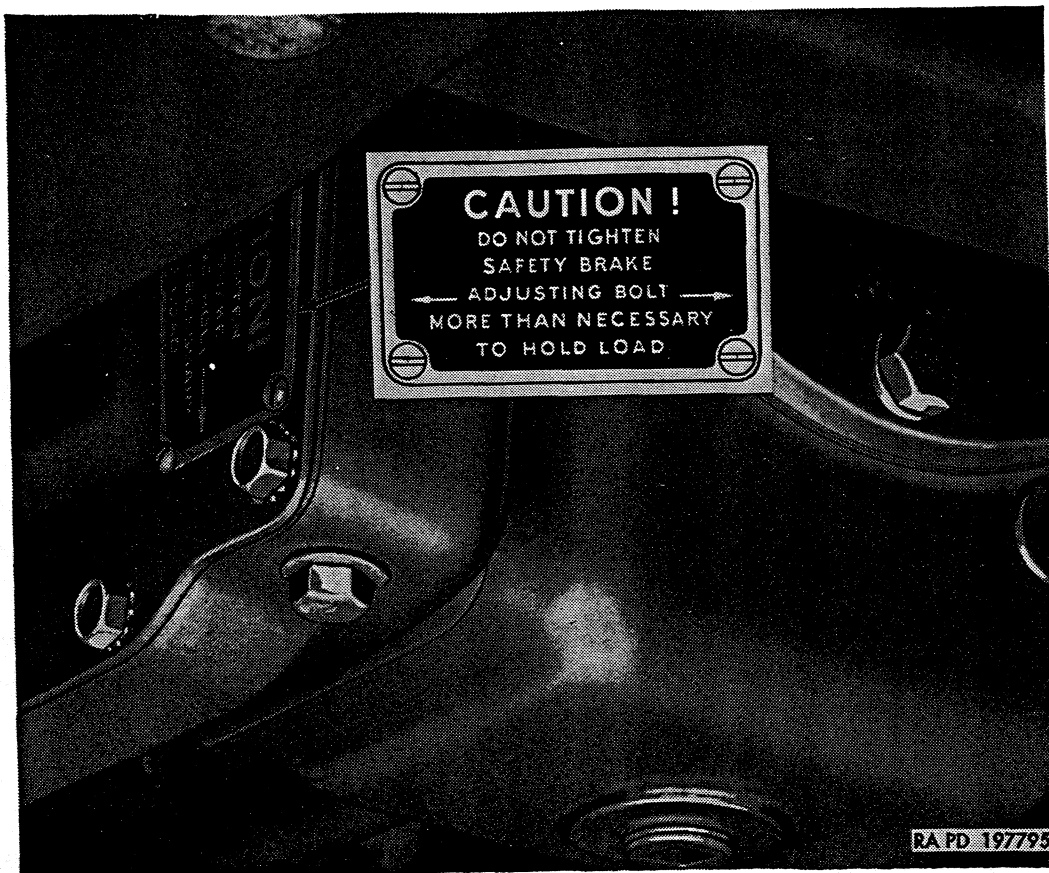

Figure 339. Winch adjustments.

winch. Turn screw clockwise about one-half turn to tighten drag brake. Test adjustment (a (2) above).

c. *Automatic Brake Adjustment* (fig. 339). Adjusting bolt head is located on underside of worm housing at left side. Increase tension of brake by turning adjusting bolt clockwise only one-half turn. Test adjustment (a(3) above).

Caution: If, after adjustment and using for several minutes, hand cannot be held on brake cover because of heat, loosen adjusting bolt about one-half turn and test again. When brake is correctly adjusted, brake may become warm during use, but not too hot to allow hand to be held on brake band cover.

317. Automatic Brake Band

a. *General.* A caution plate (fig. 339) is attached to automatic brake case cover. In event this caution plate is not on the cover, it must be installed in accordance with instructions contained in MWO ORD G749-W9.

b. *Removal.*

- (1) Remove front bumper (par. 285b).
- (2) Remove three cap screws and washers attaching left cable guard to winch assembly.

- (3) Remove six cap screws and lockwashers attaching brake case cover to brake case. Remove cover and discard gasket.
- (4) Remove adjusting screw, washer, and brake spring (fig. 340). Pull brake band from brake disk.

c. Installation (fig. 340).

- (1) Position brake band on disk.
- (2) Place $\frac{7}{16}$ -inch plain washer on the $\frac{3}{8}$ -24 x 4 adjusting cap screw, then install O-ring gasket on cap screw.
- (3) Position brake spring between case and lower leg of brake band, then insert adjusting cap screw through spring and both legs of brake band. Compress upper part of band with a pry bar until screw engages nut.
- (4) Position cover on case, using new gasket. Attach cover with six $\frac{5}{16}$ -18 x $\frac{5}{8}$ cap screws and external-teeth lockwashers. Tighten cap screws.
- (5) Position left cable guard on winch assembly; then install three $\frac{5}{8}$ -11 x $1\frac{1}{4}$ cap screws and washers. Tighten cap screws.
- (6) Install front bumper (par. 285*c*).
- (7) Adjust automatic brake (par. 316*c*).

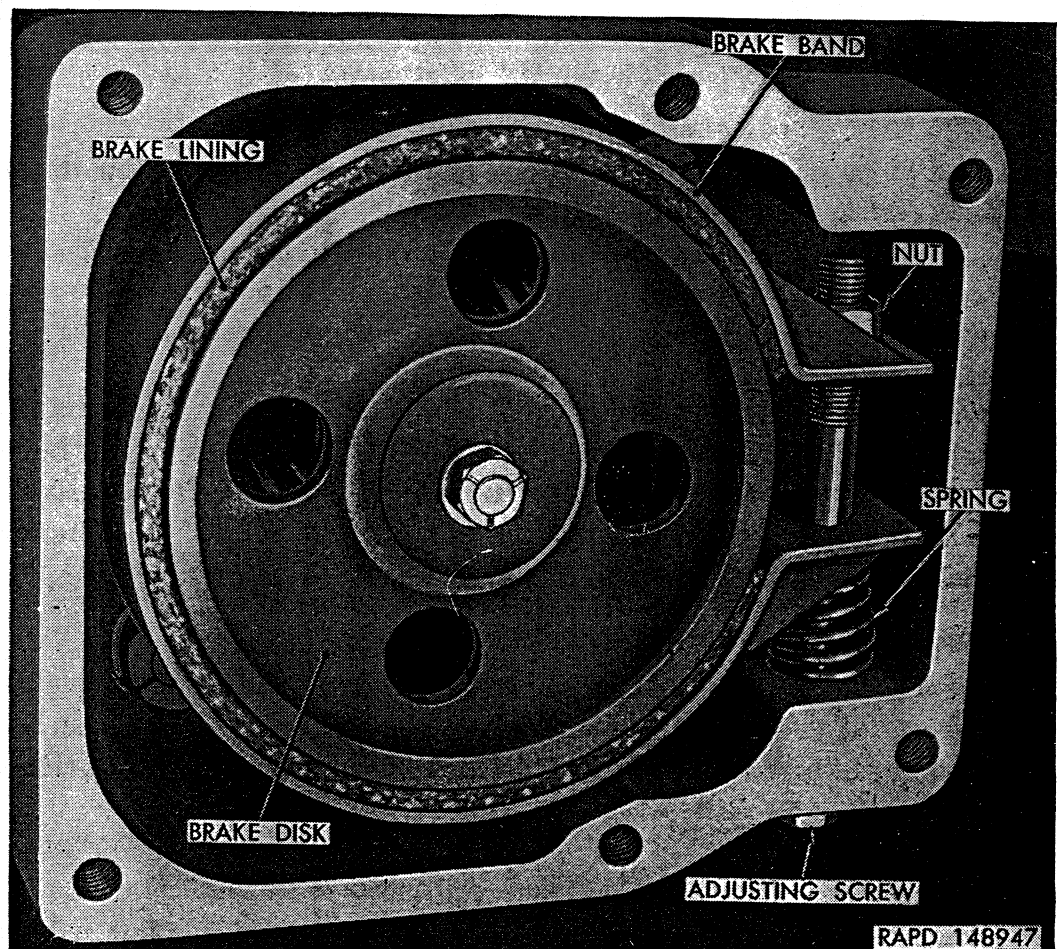

Figure 340. Automatic brake band installed.

318. Winch Cable

a. General. Winch cable consists of 200 feet of 1/2-inch wire rope with outer end attached to four feet of chain and hook. A thimble and clamp attach rope to chain.

b. Removal.

- (1) Push clutch control lever (fig. 43) in toward winch drum to disengage drum sliding clutch. Pull out drum lock poppet knob and rotate one-quarter turn to unlocked position. In cab, place power-take-off lever in CENTER-NEUTRAL position.

Caution: Do not handle cable with bare hands.

- (2) Unwind cable from drum; then loosen hex-socket setscrew securing cable end in drum. Pull end of cable out of drum.

c. Cleaning, Inspection, and Lubrication.

- (1) *Cleaning.* Wipe cable clean of any accumulation of old oil and dirt.
- (2) *Inspection.* Examine cable for frayed or broken strands, kinks, or bends which may weaken cable.
- (3) *Lubrication.* Wipe entire cable by means of a brush with preservative lubricating oil (PL) special. Wipe off excess oil; then coat cable and winch drum with chain and wire rope lubricant (CW).

d. Installation.

- (1) Insert end of cable through hole in drum and secure in place by tightening 1/2-13 x 5/8 hex-socket setscrew firmly against cable.
- (2) Connect other end of cable to a load, preferably another vehicle, to keep cable taut while winding on drum. Leave all controls in neutral and brake released on vehicle being used as a load.
- (3) Wind cable on winch drum (par. 49d(1)).

319. Winch Drive Line Assembly

a. General. Both front and rear drive shafts, universal joint at power-take-off end, and pilot bearing with bearing bracket and shield, are removed as an assembly (fig. 341). Front universal joint at winch is removed after the other parts of the drive line assembly have been removed.

b. Removal (fig. 341).

- (1) At rear universal joint, loosen setscrew securing joint to power-take-off shaft.
- (2) At front of front shaft, loosen setscrew on shaft stop, then slide stop back from end of shaft.
- (3) Disconnect brake pull-back spring from pilot bearing bracket.

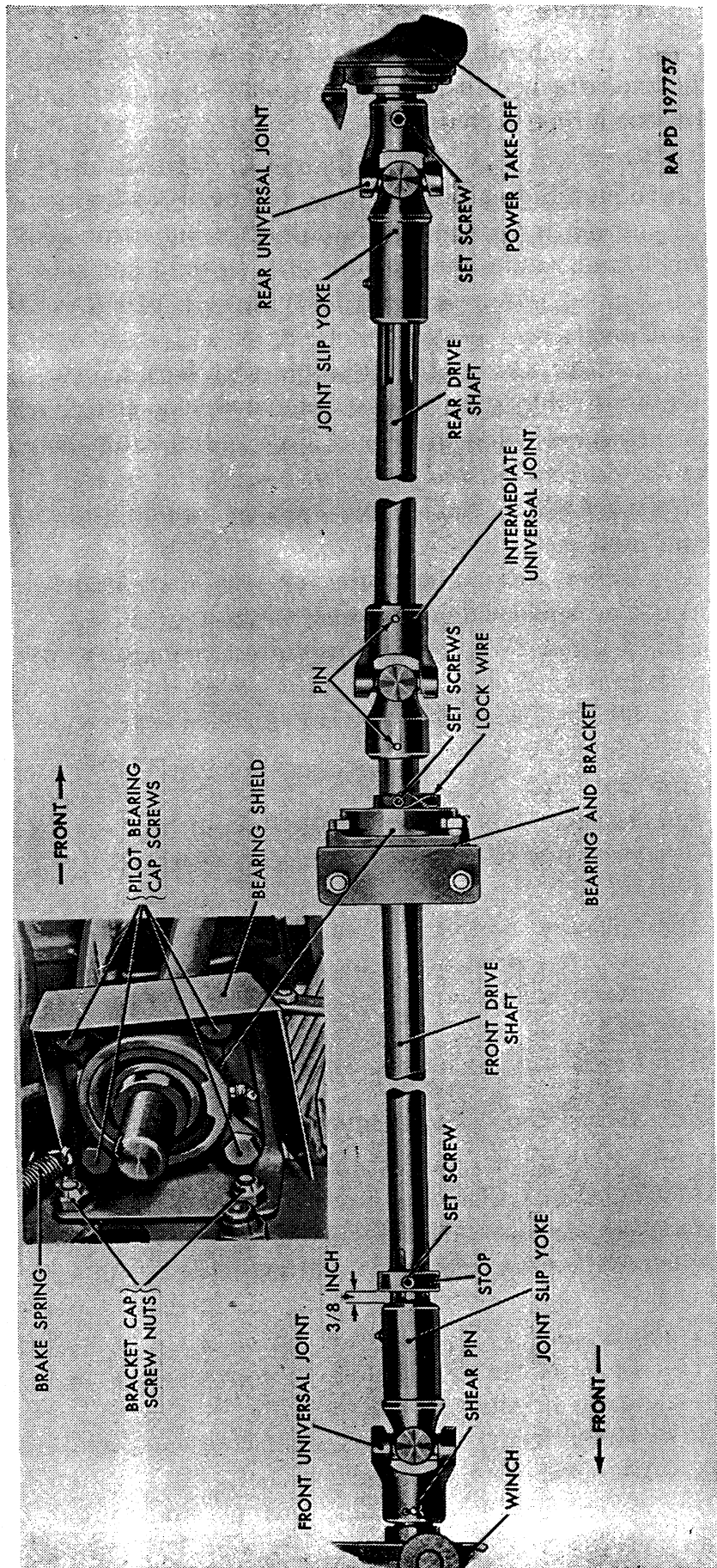

RA PD 197757

Figure 341. Winch drive line assembled.

- (4) Remove two cap screws attaching pilot bearing bracket to front spring and torque rod bracket.
- (5) Pull complete drive line assembly toward front until rear universal joint yoke clears power-take-off shaft; then pull drive line assembly to rear until end of front shaft clears hole in front cross member, at same time sliding stop off end of front drive shaft.
- (6) Remove rear universal joint from rear shaft splines.
- (7) Remove lock wire, and loosen two setscrews securing pilot bearing to front shaft; then push bearing and bracket away from intermediate universal joint.
- (8) Drive out two tapered groove pins securing intermediate universal joint to front and rear shafts. Intermediate universal joint can then be removed from shafts.
- (9) Slide pilot bearing and bracket off front shaft.
- (10) To remove pilot bearing assembly from bracket, remove four safety nuts from pilot bearing cap screws; then remove bearing shield. Remove four spacing jam nuts attaching bearing assembly to bracket.
- (11) Remove shear pin at front universal joint, then pull joint from winch shaft.

c. Cleaning and Inspection.

- (1) *Cleaning.* Thoroughly wash drive shafts, universal joints, pilot bearing, and other parts in dry-cleaning solvent or volatile mineral spirits.
- (2) *Inspection.*
 - (a) *Drive shafts.* Check front and rear drive shafts for runout. If runout exceeds 0.010-inch total dial indicator reading, replace shaft. Check shaft splines for wear or damage. Shaft must slide freely in slip yokes, but backlash between yoke and shaft splines must not exceed 0.005 inch. If backlash exceeds limits, replace parts as required.
 - (b) *Pilot bearing.* Hold pilot bearing case and rotate inner race by hand to check for roughness or looseness in bearing. Check setscrew holes in bearing inner race for damaged threads. If rough action, looseness, or damaged threads are evident, replace pilot bearing assembly.
 - (c) *Universal joints.* Check journals and journal bearings for looseness. If journals or bearings are worn, install repair kit (par. 320). Examine shear pin hole through hub of front fixed yoke for elongation. If hole is worn, new hole may be drilled (par. 314c(1)). Examine setscrew hole in rear fixed yoke for damaged threads; replace yoke if threads are damaged. Fit of slip yokes on drive shaft splines is checked in (a) above.

d. Installation (fig. 341).

- (1) Position pilot bearing assembly in pilot bearing bracket with lubrication fitting at bottom. Attach with four $\frac{1}{2}$ -20 x $\frac{17}{8}$ cap screws and $\frac{1}{2}$ -20 jam nuts; tighten jam nuts to 48 to 64 pound-feet torque. Position pilot bearing shield on the four cap screws; then install $\frac{1}{2}$ -20 safety nuts. Tighten nuts to 48 to 64 pound-feet torque.
- (2) Slide pilot bearing and bracket on front drive shaft with bracket toward front.
- (3) Place $\frac{1}{4}$ x 1 woodruff key in keyway of both front and rear drive shafts. With keyways in alignment, slide front and rear drive shafts into yokes of intermediate universal joint until taper groove pin holes are in alignment. Drive $\frac{5}{16}$ x 2 taper groove pin through each yoke and shaft.
- (4) Install rear universal joint over splines of rear shaft.
- (5) Install front universal joint over winch worm shaft, then install shear pin through joint yoke and shaft. Install $\frac{1}{16}$ x $\frac{1}{2}$ cotter pin at each end of shear pin. Bend cotter pins in place.
- (6) Guide front end of front shaft through cross member hole, then position stop on shaft. Insert front shaft into splines of front universal joint.
- (7) Push entire drive line assembly toward front until rear universal joint yoke can be installed on power-take-off shaft, aligning key in shaft and universal joint yoke. Tighten $\frac{1}{2}$ -13 x $\frac{1}{2}$ hex-socket setscrew which secures joint yoke to power-take-off shaft.
- (8) Position pilot bearing bracket against front spring and torque rod bracket, then install two $\frac{1}{2}$ -20 x $1\frac{1}{4}$ cap screws and $\frac{1}{2}$ -20 nuts. Tighten nuts to 48 to 64 pound-feet torque.
- (9) Tighten two pilot bearing setscrews and install lock wire through heads of setscrews.
- (10) Position stop at front universal joint until three-eighths of an inch exists between collar and universal joint yoke as shown in figure 338. Tighten $\frac{3}{8}$ -16 x $\frac{1}{2}$ hex-socket setscrew.
- (11) Connect brake pull back spring to pilot bearing bracket.

320. Universal Joint Repair

Note. The key letters noted in parentheses are in figure 343, except where otherwise indicated.

a. General. Replacement and inspection of the universal joint assemblies is covered in paragraph 319. The component parts of all three universal joint assemblies are the same except for the yokes, and the following procedure for installing a universal joint repair kit applies to all of the three universal joint assemblies. Disassembled

view of the universal joints and other drive line components is shown in figure 343.

b. Disassembly.

- (1) Grip one yoke of universal joint in a vise and remove four snap rings (A) securing bushing-type bearings (B) in yokes.
- (2) Remove 90° lubrication fitting (F) from journal (E).
- (3) Support one yoke in vise jaws; then strike other yoke with hammer as shown in left view of figure 342 to remove one bushing-type bearing. Turn yoke over and strike on opposite side to remove opposite bearing. Remove yoke from which bearings were removed from journal.

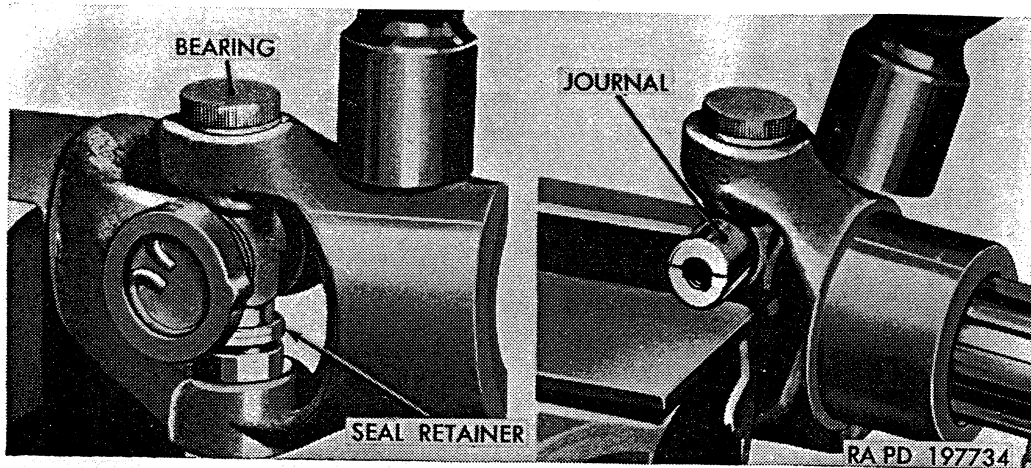

Figure 342. Disassembly of winch drive line universal joint.

- (4) Install soft metal jaw protectors in vise; then support ends of journal on vise jaws as shown in right view of figure 342. Strike yoke with hammer to remove one bushing-type bearing; then turn yoke over and strike opposite side to remove opposite bearing.
- (5) Remove journal (E) from yoke; then remove and discard cork seals (C) and seal retainers (D) from journal.

c. Assembly.

- (1) The following procedures cover assembly of a universal joint repair kit consisting of journal, seal retainers, cork seals, bushing-type bearings, and snap rings in any of the three universal joint assemblies.
- (2) Install new seal retainer (D) and new cork seal (C) on each arm of journal (E). Push retainers down against shoulders on journal and make sure cork seals are fully seated in retainers. Install 90° lubrication fitting (F) in journal with end of fitting pointing between two arms of journal for accessibility.
- (3) Grip hub of one yoke in vise and insert journal into yoke. Start one bushing-type bearing (B) into each side of yoke,

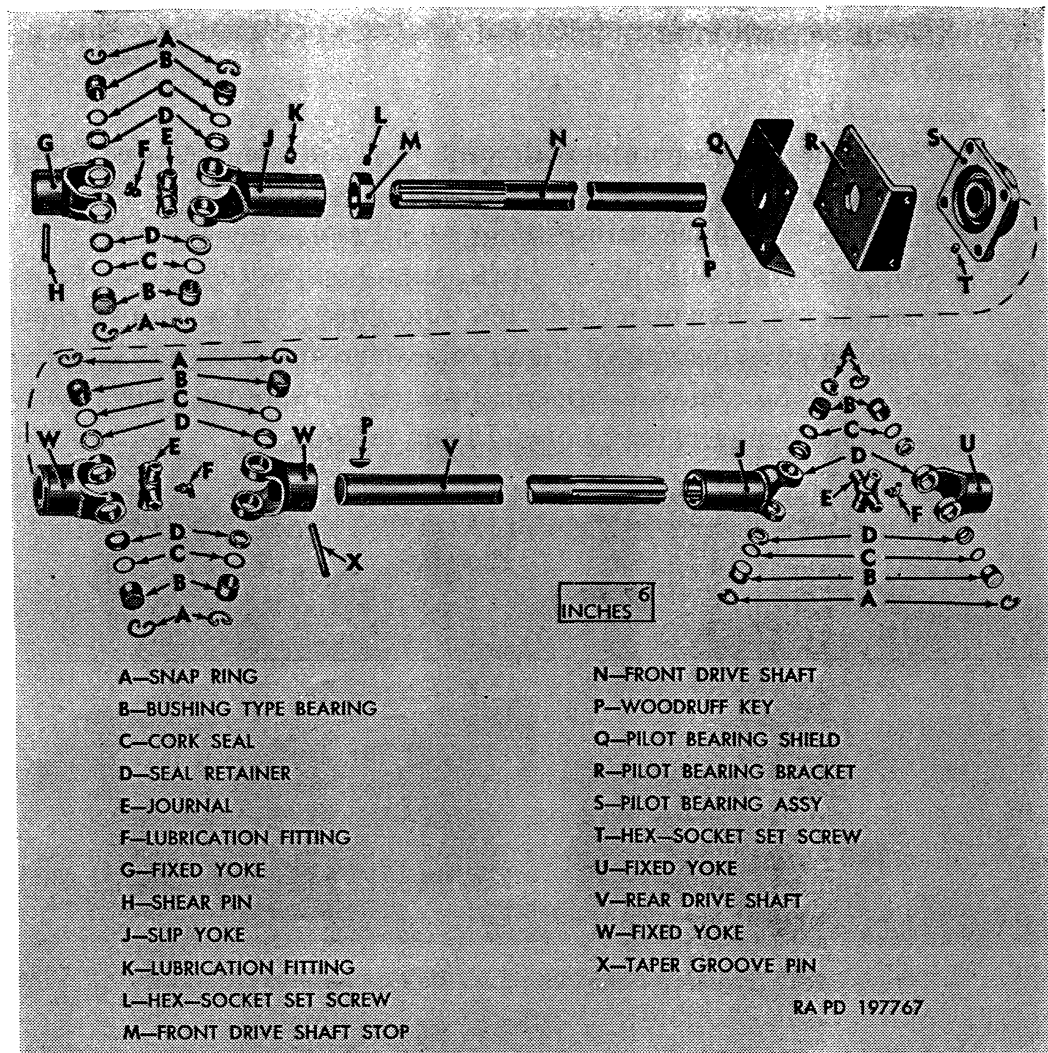

Figure 343. Winch drive system components.

guiding ends of journal into bearings. Drive bearings in below snap ring grooves; then install snap rings (A), making sure they are fully seated.

- (4) Position other yoke in vise, insert free ends of journal in yoke; then install bushing-type bearings (B) and snap rings (A) as in (3) above.
- (5) Assembly of winch drive line and installation in the vehicle is described in paragraph 319d.

321. Winch Control Linkage

(fig. 344)

a. General. The winch is driven through drive shafts and universal joints from the power-take-off. Operation of the power-take-off in conjunction with the winch is explained in paragraph 49. Power-take-off mechanism is placed into neutral, forward, and reverse driving positions by means of a manually operated control lever, mounted under driver's seat. A control cable assembly connects control lever in

cab with shifting lever in power-take-off. Cable assembly is attached with a J-bolt to a support bolted under floor pan and has an adjustable yoke at control lever.

b. Linkage Control Cable Removal.

- (1) Remove J-bolt and nut attaching cable assembly to support under floor pan.
- (2) Remove pin from yoke at control lever.
- (3) Pull cable assembly down through rubber grommet in floor pan (under driver's seat).
- (4) Remove six cap screws and plain washers attaching cover plate to power-take-off. Remove cover and discard gasket. Reach in and remove cotter pin and clevis pin from yoke at power-take-off lever.
- (5) Loosen cable nut at power-take-off. Turn cable housing to remove cable assembly from power-take-off.

c. Linkage Control Cable Installation.

- (1) Check condition of control-cable-to-power-take-off leather

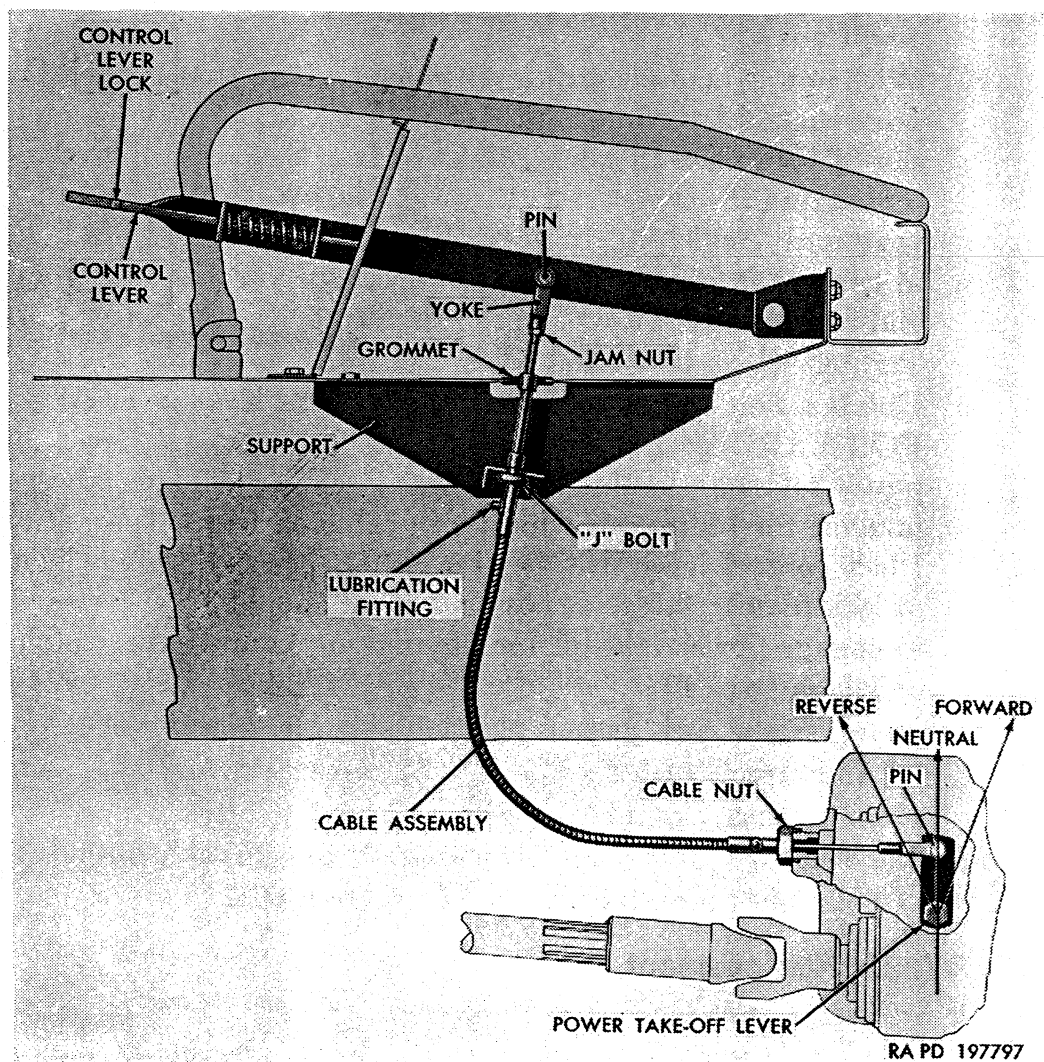

Figure 344. Power-take-off control linkage.

- seal in power-take-off housing. Replace seal if worn or damaged.
- (2) Place control cable locknut and plain washer on lower end of control cable housing. Insert cable into power-take-off housing. Clevis at end of cable must be pushed in against cable stop. Power-take-off lever must be in reverse position (toward front of vehicle). Screw cable into power-take-off until clevis pin hole lines up with hole in power-take-off shift lever. Back off cable one turn and tighten locknut; this will prevent clevis from bottoming in cable. Install $\frac{3}{16}$ x $\frac{31}{64}$ clevis pin through clevis and shift lever; then install $\frac{1}{16}$ x $\frac{5}{16}$ cotter pin in end of clevis pin.
 - (3) Push cable assembly up through grommet in floor pan.
 - (4) Attach cable assembly to support under floor pan with J-bolt and $\frac{5}{16}$ -24 safety nut. Make certain that cable assembly is positioned with lubrication fitting toward front of vehicle and that J-bolt engages groove in cable assembly. Tighten J-bolt nut.
 - (5) With power-take-off shift lever in neutral position (vertical), place control lever in CENTER-NEUTRAL position (center slot of lock plate in cab). Make certain that control lever is centered in the center slot; then turn control cable adjustable yoke until clevis pin slides freely through yoke and pin hole in control lever. Insert $\frac{5}{16}$ x $\frac{13}{16}$ clevis pin through yoke and control lever; then secure pin with a $\frac{3}{32}$ x $\frac{1}{2}$ cotter pin. Tighten $\frac{5}{16}$ -24 jam nut at yoke.
 - (6) Check action of linkage by placing control lever in DOWN-FORWARD position (lower slot in lock plate). Lever at power-take-off should move toward rear to engage power-take-off for pulling or winding in cable on winch (par. 49). Place control lever in UP-REVERSE position (upper slot of lock plate). Lever at power-take-off should move forward to engage power-take-off for paying-out or unwinding cable on winch (par. 49).
 - (7) Using a new cork gasket, position side plate on power-take-off and attach with six $\frac{5}{16}$ -18 x $\frac{3}{4}$ cap screws and $\frac{11}{32}$ -inch plain washers. Tighten cap screws.
 - (8) Lubricate cable through lubrication fittings in cable assembly at point shown on lubrication chart (par. 69).

322. Winch Replacement

a. *Coordination with Ordnance Maintenance Unit.* Refer to paragraph 2 for information on coordination with an ordnance maintenance unit.

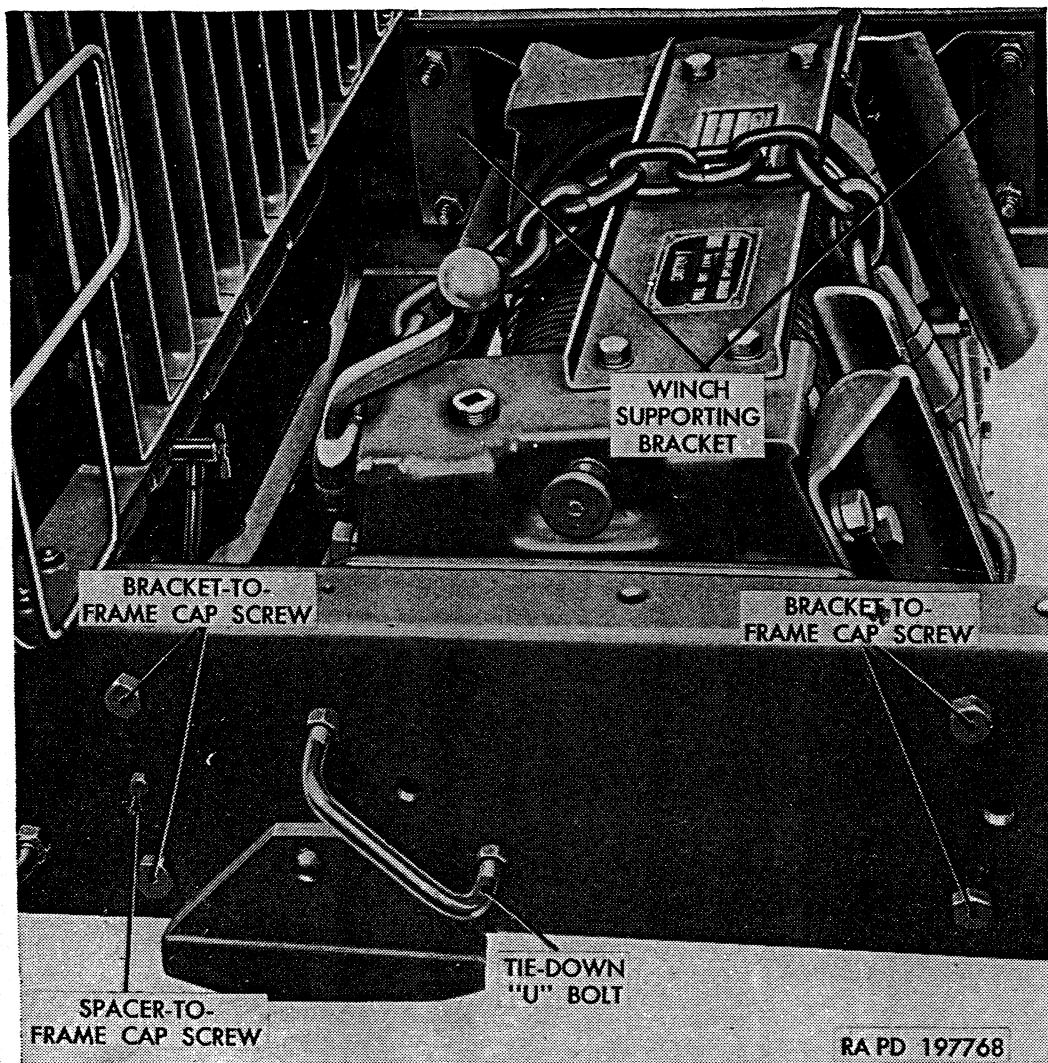

Figure 345. Winch disconnect points.

b. General. The winch assembly (fig. 346), which includes supporting brackets and drive shaft universal joint, can be replaced as an assembly. A suitable chain fall is required.

c. Removal.

- (1) Remove front bumper (par. 285*b*).
- (2) Support winch with hoist.
- (3) Remove two nuts from inside of frame attaching each front tie-down U bolt to frame.
- (4) Remove four cap screws and nuts attaching each winch supporting bracket to frame side member.
- (5) Do not remove cap screws attaching winch supporting bracket spacer to frame.
- (6) While supporting winch with hoist, pull winch, with supporting brackets attached, toward front and out of frame side members.
- (7) Remove winch drive shaft universal joint from winch shaft by removing shear pin.

- (8) Supporting brackets can be removed from winch by removing six screws (E, fig. 346) and lockwashers from each side.

d. Installation.

Note. The key letters noted in parentheses are in figure 346, except where otherwise indicated.

- (1) Install winch right and left supporting brackets (D and A) on winch with special screws (E) and $\frac{9}{16}$ -inch lockwashers. The special screws on right supporting bracket are $1\frac{3}{4}$ -inches long, and on left bracket are $2\frac{3}{4}$ -inches long.

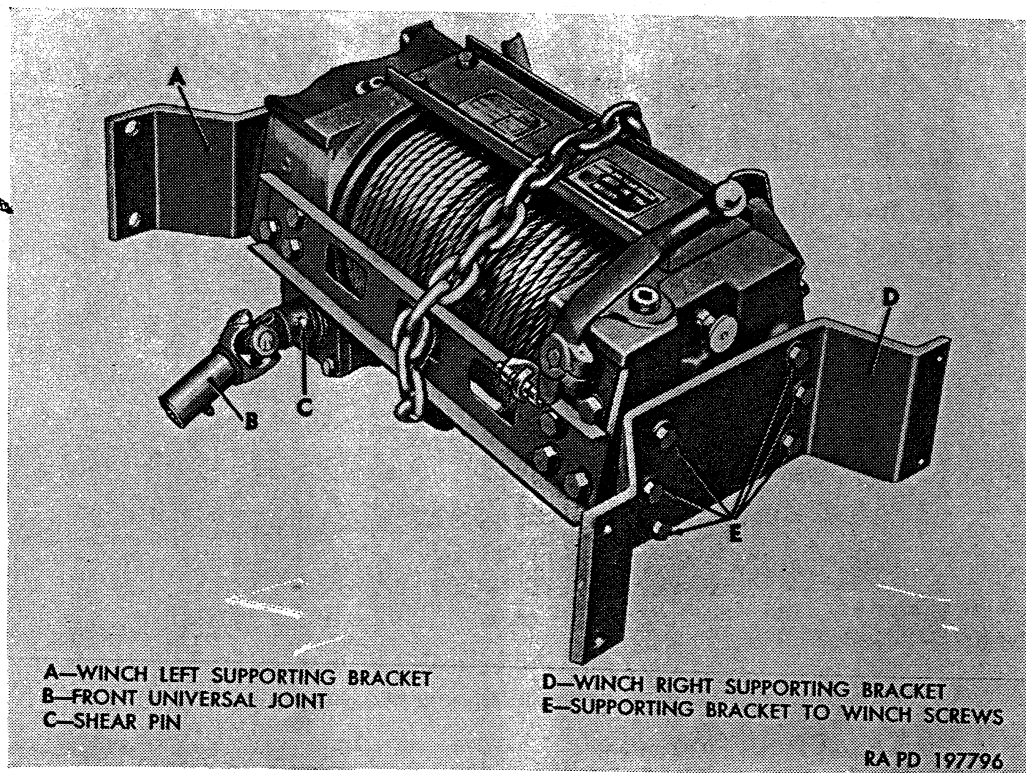

Figure 346. Winch assembly removed.

- (2) Install front universal joint (B) on splines of winch shaft and insert shear pin (C) through joint and shaft. Install $\frac{1}{16} \times \frac{1}{2}$ cotter pin at each end of shear pin. Bend cotter pins in place.
- (3) Supporting winch with chain fall, guide winch with supporting brackets attached between frame side members. As winch is pushed toward rear, guide front universal joint splines onto front drive shaft splines.
- (4) Position supporting brackets in place in frame. Install eight $\frac{5}{8}$ -18 x $1\frac{3}{4}$ bracket-to-frame cap screws and $\frac{5}{8}$ -18 safety nuts. Tighten nuts to 95 to 127 pound-feet torque.
- (5) Position two tie-down U bolts on frame; then attach with four $\frac{1}{2}$ -20 safety nuts. Tighten nuts to 48 to 64 pound-feet torque.

(6) Position front drive shaft stop three-eighths of an inch from winch universal joint yoke. Lock stop to shaft with $\frac{3}{8}$ -16 x $\frac{1}{2}$ setscrew (fig. 338).

(7) Install front bumper (par. 285c).

e. *Record of Replacement.* Record the replacement on DA Form 478.

Section XXXV. DUMP BODY AND CONTROLS

323. Description and Data

a. *General.* This section contains description and data, also replacement and adjustment of component assemblies used in connection with dump body assembly on dump truck M215. Refer to paragraphs 50 and 51 for operation instructions.

b. *Description.*

- (1) *Dump body* (fig. 350). Dump body is of all steel construction, with body cross sills and longitudinal sills welded together as a complete unit. Steel tail gate is hinged at top and bottom. Body is hinged at rear to subframe to provide dumping action. Body also is equipped with cargo side racks, troop seats, bows, and paulin.
- (2) *Body subframe* (fig. 351). Body subframe is of all steel construction, with cross braces and gussets welded to side members. Forward cross member is box girder-type and serves as system hydraulic fluid reservoir. Wood sill strips are used between subframe and vehicle frame. Subframe is bolted to vehicle frame at rear and is retained at front by springs, bolts, and brackets. Guide brackets at right and left sides assist in locating subframe.
- (3) *Power-take-off.* A single speed power-take-off, with top mounted accessory drive, is installed at left side of transfer. Accessory drive at top of power-takeoff drives hydraulic pump through a drive shaft. Power-take-off also supplies power to winch through a drive shaft when vehicle is so equipped. Levers in cab provide a means of engaging or disengaging power-take-off.
- (4) *Drive shaft* (fig. 362). Hydraulic hoist pump drive shaft is used to drive the hydraulic hoist pump. Shaft is conventional-type with slip joint, journals, and closed end needle bearings. Shaft is attached to power-take-off accessory drive and pump with keys and setscrews.
- (5) *Hydraulic cylinder* (fig. 355). Hydraulic cylinder is installed on a mounting shaft between a pair of gussets. Gussets are bolted to mounting shaft and to rear end of cylinder. Cylinder, gussets, and mounting shaft assembly are installed

in subframe with mounting shaft resting on brackets and secured with lock blocks at each side of subframe.

- (6) *Crosshead and roller arms* (fig. 356). Crosshead is attached to hydraulic cylinder piston rod by two lock retainers. A roller arm is installed on each end of crosshead and one end of roller arm is attached to body by a straight pin. A roller is pinned to opposite end of roller arm which bears against a curved track welded in subframe.
- (7) *Control box* (fig. 347). A control box assembly is installed at front underneath subframe. Manual linkage is connected to lever at one side of control box. Lever at opposite side of control box is connected to power-take-off to provide engagement and disengagement of this unit. Control box also is connected to control valve to permit raising, holding, and lowering of body.
- (8) *Hoist pump* (fig. 347). Hoist pump is gear-type and is mounted to the crossover adapter assembly. Pump is driven from power-take-off accessory drive assembly by means of a drive shaft assembly.
- (9) *Control valve* (fig. 358). Control valve assembly is spool-type and is mounted directly to fluid supply tank. Control valve spool, which controls flow of fluid for raising and lowering body, is operated by linkage from control box.
- (10) *Control valve adapter* (fig. 358). Control valve adapter assembly is mounted to control valve body. Adapter provides means for fluid passage between crossover adapter assembly and control valve assembly, also a spring-loaded plunger is installed in adapter as a safety check in the event of a failure.
- (11) *Crossover adapter* (fig. 347). Crossover adapter assembly is mounted between fluid pump assembly and control valve adapter assembly. Crossover adapter contains four spring-loaded balls, which open or close passages within the adapter body as pump rotation direction is changed.

c. Data.

Body:

Make and number:
 Perfection..... A-4079
 Gar Wood..... 2026286
 Capacity..... 2½ cu yd

Hoist cylinder:

Make and model:
 Perfection..... A4020
 Gar Wood..... M2022790
 Diameter..... 5¼ in.

Hoist pump:

Make and model:
 Perfection..... A5111
 Gar Wood..... 2026488

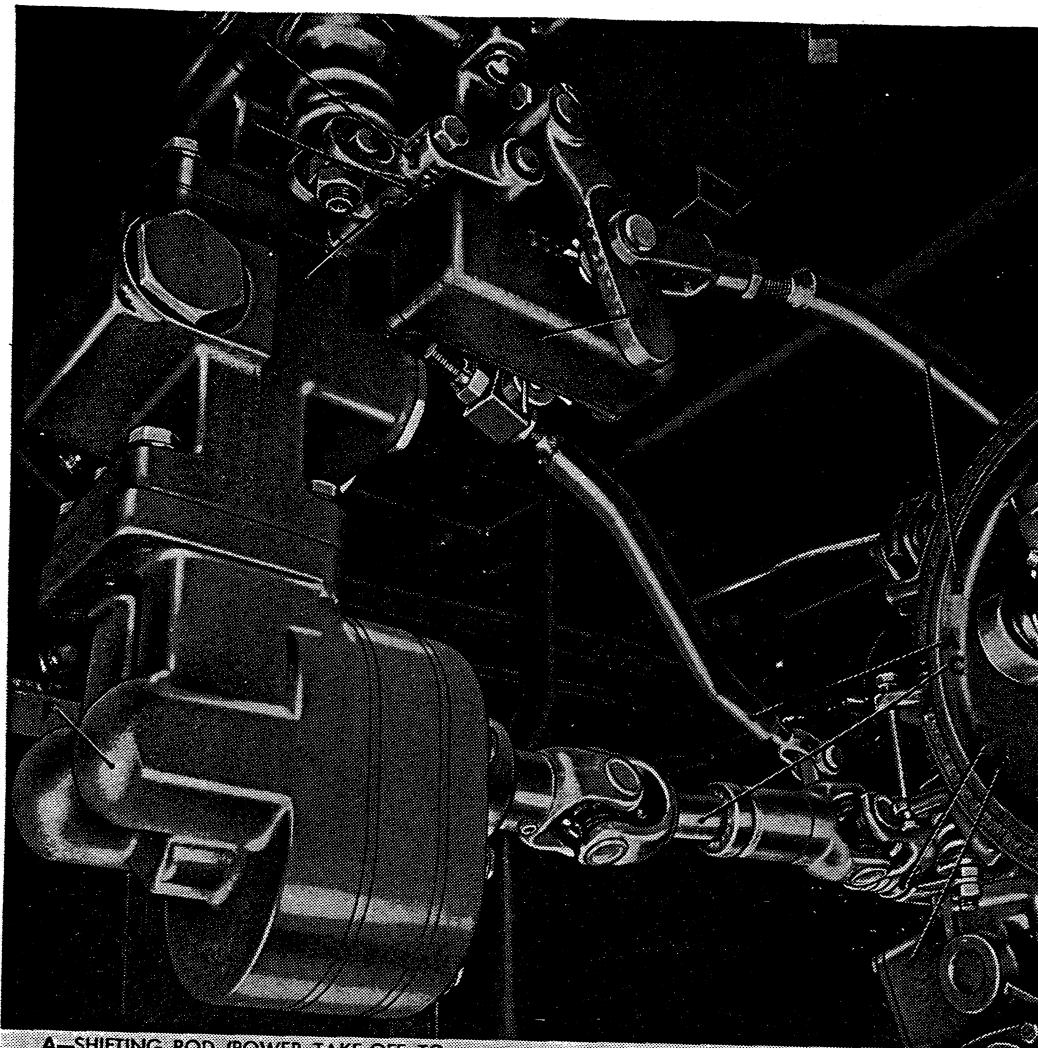

A—SHIFTING ROD (POWER TAKE-OFF TO CONTROL BOX)
 B—SHIFTING ROD (IDLER LEVER TO CONTROL BOX)
 C—PUMP DRIVE SHAFT ASSY
 D—ACCESSORY DRIVE ASSY

E—POWER TAKE-OFF ASSY
 F—PUMP ASSY
 G—CROSSOVER ADAPTER ASSY
 H—CONTROL VALVE ADAPTER ASSY
 J—CONTROL VALVE ASSY
 K—CONTROL BOX ASSY

RA PD 197678

Figure 347. Dump body hoist units and controls.

Control box :

Make and model :

Perfection..... A3853

Gar Wood..... 2026997

Control valve adapter :

Make and model :

Perfection..... A3018

Gar Wood..... M2020475

Crossover adapter :

Make and model :

Perfection..... A4080

Gar Wood..... 2026464

Power-take-off :

Make..... Chelsea

Model..... 87C1

Power-take-off accessory drive :

Make _____ Chelsea

Model _____ 82C

Drive shaft :

Make _____ Spicer

Number _____ 200750-1

324. Hoist Control Adjustments

Note. The key letters in parentheses are in figure 348, except where otherwise indicated.

a. General. Adjustable shifting rods are used between idler lever shaft and control box lever, also between power-take-off accessory drive and control box lever. Control valve spool adjustment also is provided to obtain raising, holding, and lowering positions.

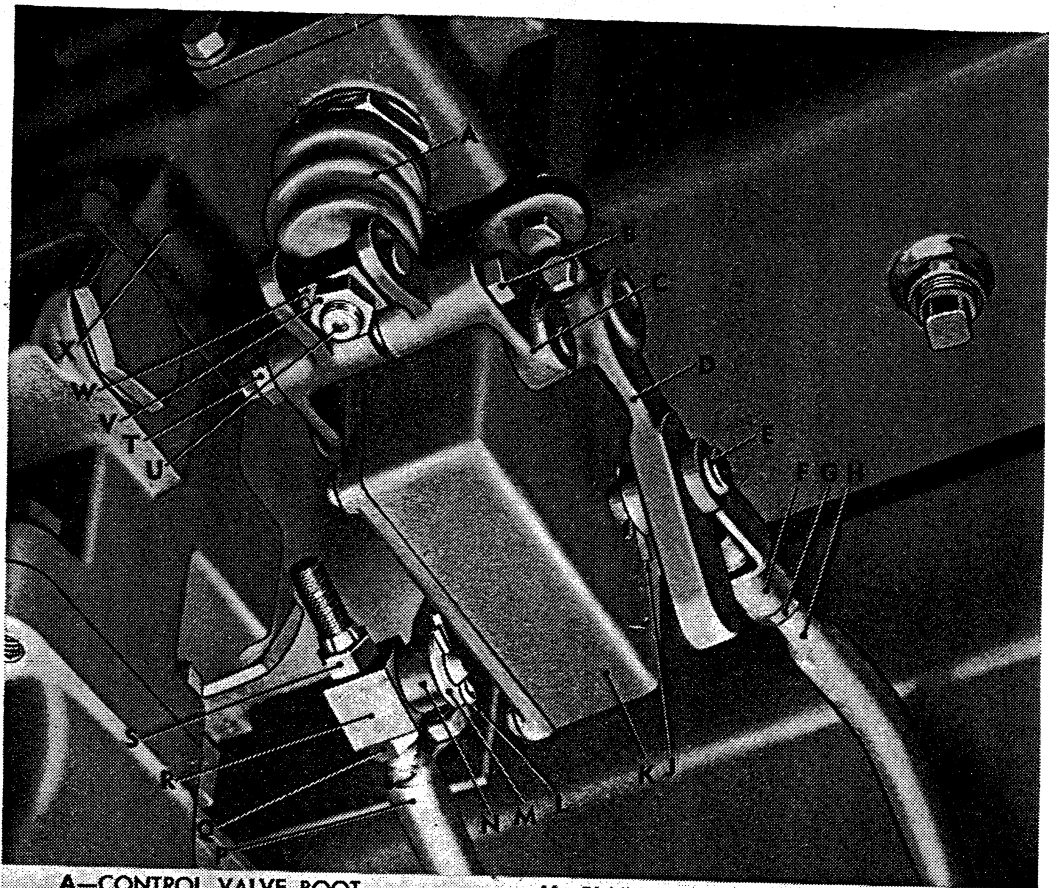

A—CONTROL VALVE BOOT
B—CAP SCREW
C—CONTROL BOX VALVE SHAFT LEVER
D—CONTROL BOX LEVER
E—CLEVIS PIN
F—ADJUSTABLE YOKE
G—JAM NUT
H—SHIFTING ROD
J—COTTER PIN
K—CONTROL BOX ASSY
L—COTTER PIN

M—PLAIN WASHER
N—CONTROL BOX LEVER
P—SHIFTING ROD
Q—JAM NUT
R—SHIFTING ROD TRUNNION
S—LOCK NUT
T—NUT
U—CONTROL VALVE SPOOL
V—JAM NUT
W—CONTROL VALVE SPOOL TRUNNION
X—CONTROL VALVE ASSY

RA PD 197674

Figure 348. Control valve adjustment.

b. Control Box Shifting Rod.

- (1) Remove cotter pin (J) and clevis pin (E); then position power-takeoff lever (fig. 360) so that top of handle is 5 inches above cab floor.
- (2) Move control box lever (D) forward as far as possible.
- (3) Loosen jam nut (G) and turn adjustable yoke (F) until clevis pin (E) may be inserted into adjustable yoke and lever holes freely, while lever is in forward position. Tighten jam nut (G) when adjustment is complete. Also install $\frac{1}{8}$ x $\frac{7}{8}$ cotter pin (J).

c. Power-Take-Off Shifting Rod.

- (1) Adjust control box shifting rod (*b* above).
- (2) Move power-take-off accessory drive shifter shaft into neutral by pulling shaft rearward as far as possible.
- (3) Loosen locknut (S) and jam nut (Q) at each side of shifting rod trunnion (R). Turn nuts (S) and (Q) to position trunnion, until pin enters lever holes freely. Install plain washer (M) and $\frac{1}{8}$ x $\frac{7}{8}$ cotter pin (L).

d. Control Valve Spool.

- (1) Raise body and position safety braces as directed in paragraph 51*d*.
- (2) Loosen jam nut (V). Slide control valve boot (A) upward to expose flats on control valve spool.
 - (a) If body fails to raise when power-take-off lever is placed in BODY RAISE position, the spool valve should be turned out of control valve spool trunnion (W). Tighten jam nut (V); then check for proper raising, holding, and lowering.
 - (b) If body fails to lower when control lever is placed in BODY LOWER position, the spool valve should be turned into the control valve spool trunnion (W). Tighten jam nut (V); then check for proper raising, holding, and lowering.
 - (c) If body fails to hold (par. 51*b*(2)) when properly adjusted in raise and lower positions as explained in (a) and (b) above, failure of internal parts is indicated. Report to ordnance maintenance personnel.

325. Dump Body Hydraulic Fluid System

a. General. Raising and lowering of dump body is accomplished by a hydraulic fluid system. Units included in fluid system are hydraulic cylinder, pump, crossover adapter, control valve, control valve adapter, fluid reservoir, and high pressure lines. Control of fluid system is accomplished by the use of the following units: power-take-off, drive shaft, control box, and connecting rods and levers or other linkage.

b. Checking Fluid Level. Remove fluid reservoir filler plug and gasket at left side of reservoir; then remove level gage and screen from reservoir filler (fig. 349). Clean filler screen of accumulated foreign matter; then replace in filler. Check fluid level in tank, using level gage. Replenish fluid, if necessary, until level is within two marks of top mark on level gage (fig. 349) when body is down, or at center of level gage when body is raised. Refer to lubrication chart (par. 69) for type of fluid and checking intervals.

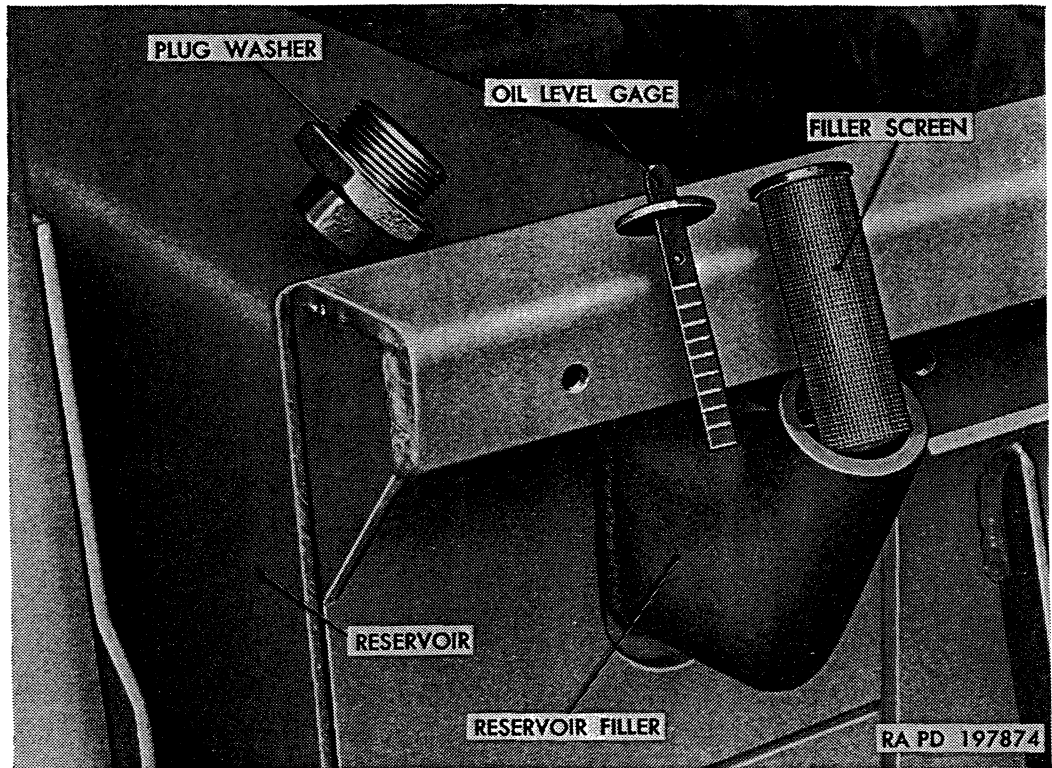

Figure 349. Hoist fluid reservoir filler cap, gage, and screen.

c. Draining System.

- (1) Raise body and position safety braces as directed in paragraph 51*d*.
- (2) Place container under fluid reservoir; then remove pipe plug in bottom of reservoir to drain fluid.
- (3) After fluid is drained, install pipe plug in bottom of reservoir. Tighten plug.

d. Filling System.

- (1) Remove filler plug and level gage at reservoir filler. Fill reservoir with engine lubricating oil (OE-10) until level with top mark on gage.
- (2) Operate hoist (par. 51*b*(1)) to lift body to fully raised position.
- (3) Lower safety braces; then lower body (par. 51*b*(3)).
- (4) Completely raise and lower body several times to expel air from system; then recheck fluid level (*b*, above).

326. Body and Subframe Mountings

a. *General.* Body is attached to and supported by a subframe assembly which is attached to the vehicle frame side members.

b. *Body Mounting.* Body (fig. 350) is secured to subframe by hinges at each rear corner. Hinges are held to body by five cap screws and nuts. Also, each hinge is attached to subframe by a hinge pin which serves as a bearing when body is raised and lowered.

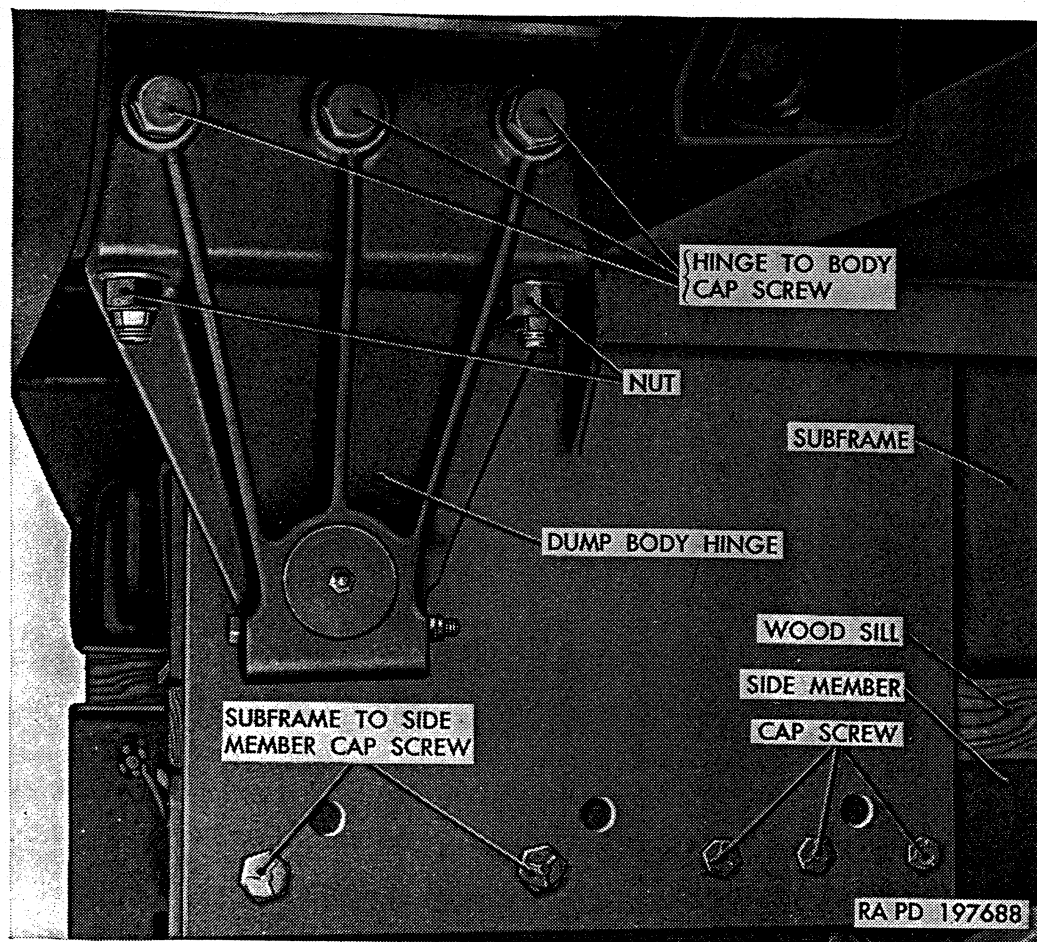

Figure 350. Body and subframe rear mounting.

c. *Subframe Mounting.* Subframe assembly is rigidly attached to vehicle frame side member at rear (fig. 350), and flexibly mounted at front (fig. 351). Wood sill strips are used between subframe and vehicle side members.

- (1) *Rear mounting.* Subframe (fig. 350) is secured to each vehicle side member at rear by five cap screws and nuts. Cap screws should be inspected for tightness at intervals indicated in paragraph 79, table V.
- (2) *Front mounting.* Subframe mounting at each side near front is flexible-type shown in figure 351. At installation, hold-down bolts (K, fig. 351) and nuts (D, fig. 351) should be tightened until tension springs (J, fig. 351) are compressed

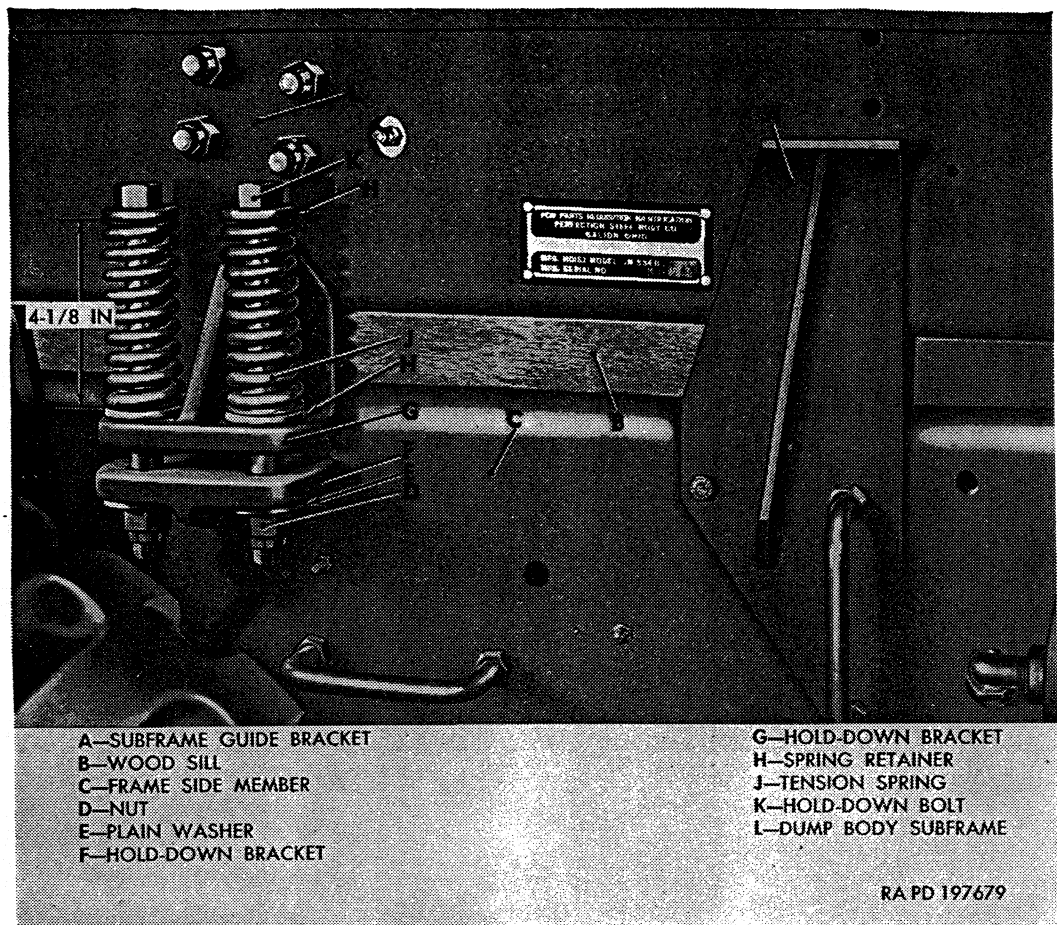

Figure 351. Subframe front mounting.

to 4 1/8 inches as shown in figure 351. At intervals indicated in paragraph 79, table V, inspect springs for proper compressed height and broken coils. Inspect holddown brackets to be sure they are tight at vehicle and subframe side members.

327. End Gate and Controls

a. General. End gate assembly is hinged at top and bottom and can be adjusted as necessary to meet several operating requirements as explained in paragraph 51a.

b. Adjustment (fig. 352). End gate lower latches must be properly adjusted to hold end gate tight when using as a dump body, also lower latch is used as a hinge when end gate is lowered. Whenever end gate lower latches do not grip end gate hinge pin tightly, need of adjustment is indicated.

- (1) Loosen rear jam nut at front end of each control rod at right and left sides of body.
- (2) Tighten front jam nut at forward end of each control rod.
- (3) Check adjustment by operating hand lever several times and note if lever has a definite over-center feel when moved into locked position. Observe that both right and left control

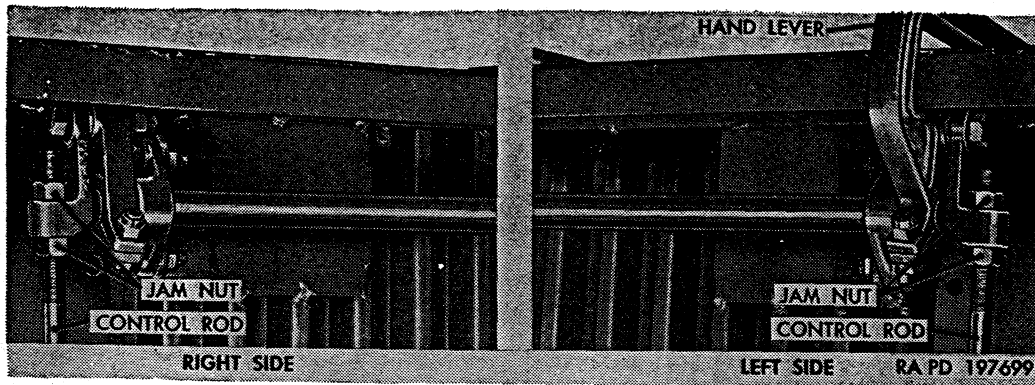

Figure 352. Body end gate latch adjustment.

rods are adjusted equally; then tighten rear jam nut at both sides.

328. Hydraulic Cylinder Assembly

a. General. Hydraulic cylinder assembly, for raising and lowering dump body, is supported in subframe on a mounting shaft. Gussets at each side of cylinder are also used to provide a rigid support for cylinder. Cylinder piston rod is attached to body through a cross-head and two crosshead roller arms.

b. Piston Rod Packing Replacement (fig. 353).

(1) *Removal.*

- (a) Raise body and position safety braces as directed in paragraph 51*d*.
- (b) Remove three bolts attaching packing gland to cylinder head. Pry packing gland out of cylinder head.
- (c) Use stiff wire or other locally available tool to remove packing from counterbore in cylinder head.

(2) *Installation.*

- (a) Clean piston rod, cylinder head counterbore, and packing gland of all dirt, oil, or other deposits. Apply light film of engine lubricating oil (OE) to facilitate assembly.
- (b) Observe that one of the four pieces of packing is flat on one side; install in cylinder head counterbore with flat side toward cylinder. Install remaining three packings, being sure that each is installed so that concave side is toward cylinder.
- (c) Slide packing gland toward and into cylinder head counterbore to compress packings. Install three $\frac{3}{8}$ -24 x $1\frac{1}{4}$ bolts securing packing gland to cylinder head. Tighten bolts evenly and only enough to compress packing and prevent leaks.
- (d) Lower safety braces (par. 51*d*); then lower body (par. 51*b*(3)). Completely raise and lower body several times and inspect for fluid leaks around packing.

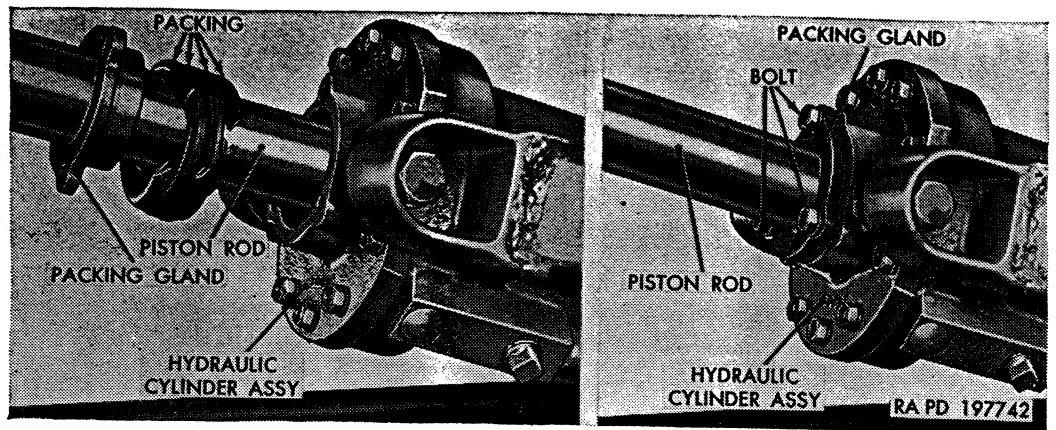

Figure 353. Hoist cylinder piston rod packing replacement.

c. Cylinder Removal.

Note. The key letters in parentheses are in figure 355, except where otherwise indicated.

- (1) *Coordination with ordnance maintenance unit.* Refer to paragraph 2 for information on coordination with an ordnance maintenance unit.
- (2) *Raise body.* Raise body and position safety braces as directed in paragraph 51d.
- (3) *Install wood support.* Position a wood support approximately 2 x 6 x 48 across top of subframe and under hydraulic cylinder (fig. 354) to support cylinder when piston rod is disconnected from crosshead.

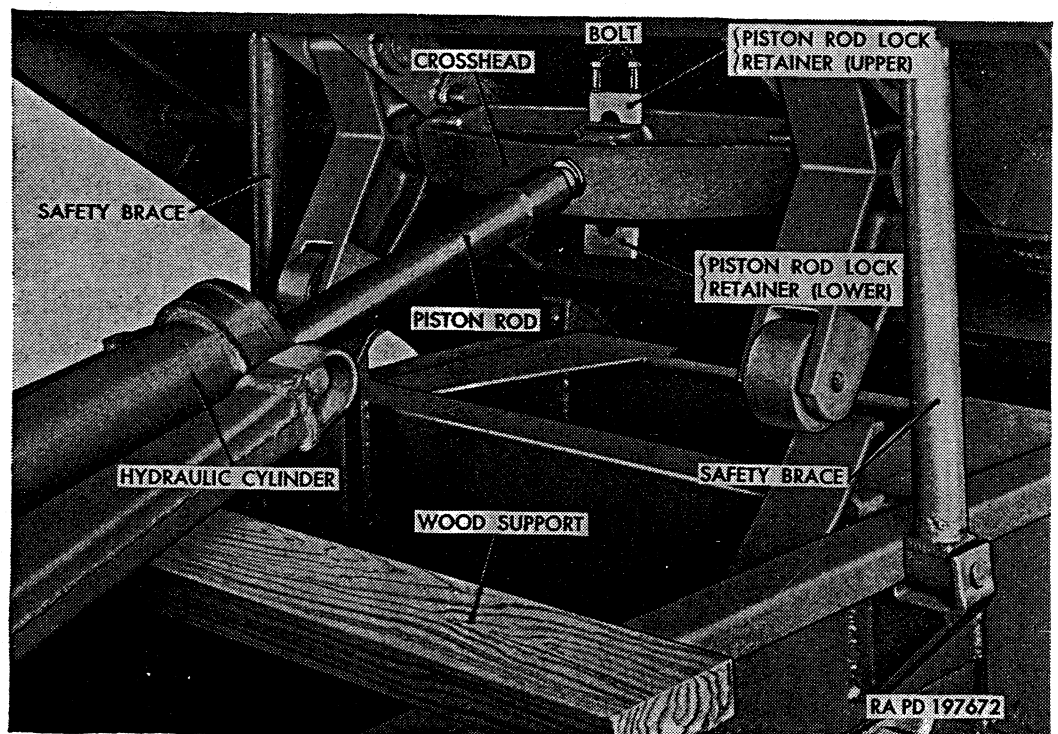

Figure 354. Piston rod to crosshead lock retainers.

- (4) *Disconnect piston rod.* Remove two bolts from piston rod lock retainer; then remove upper and lower retainers from crosshead as shown in figure 354.
- (5) *Retract piston rod.* Place transfer lever in DOWN NEUTRAL position. Place transmission shift control lever into F-2 HIGH RANGE position. Place power-take-off lever in BODY LOWER position (fig. 45); then accelerate engine to retract piston rod until it is pulled from crosshead.
- (6) *Drain fluid.* Place suitable receptacle under reservoir; then remove pipe plug in bottom of reservoir.

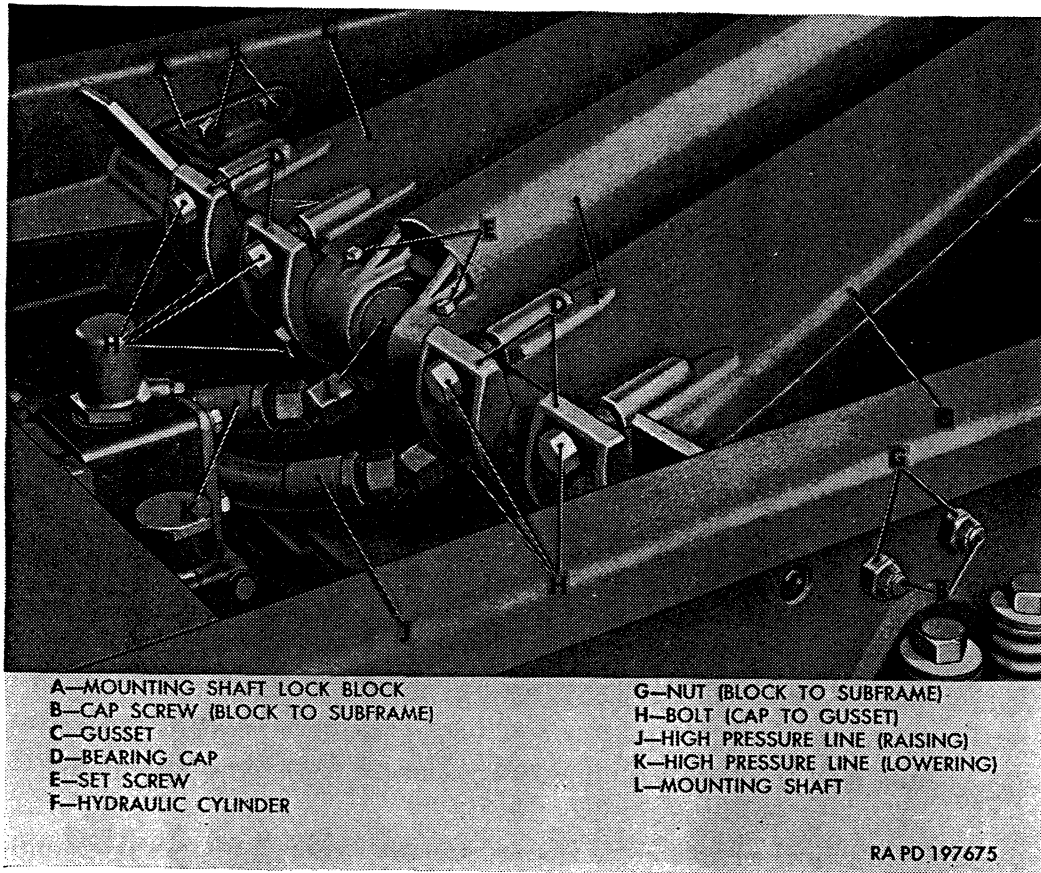

Figure 355. Hoist cylinder and gussets installed.

- (7) *Disconnect high pressure lines.* Place suitable fluid receptacle under hydraulic cylinder; then disconnect high pressure lines (J and K) from base of hydraulic cylinder (F).
- (8) *Remove mounting shaft lock blocks.* Remove four nuts (G) and four cap screws (B) attaching mounting shaft lock blocks (A) to subframe at right and left sides. Remove lubrication fitting from each end of mounting shaft (L).
- (9) *Remove cylinder and gussets.* Lift cylinder, mounting shaft, and gussets from subframe and place assembly on bench for better accessibility and further disassembly. Remove two bolts (H) attaching each bearing cap (D) to gussets (C);

then remove cap. Remove bolt attaching gusset to cylinder head; then remove gusset. Remove two setscrews (E) locating hydraulic cylinder (F) to mounting shaft (L); then remove cylinder.

d. Cylinder Installation.

Note. The key letters in parentheses are in figure 355 except where otherwise indicated.

- (1) *Assemble cylinder and gussets.* Install hydraulic cylinder (F) onto mounting shaft (L). Locate cylinder in center of shaft; then install two $\frac{3}{8}$ -16 x $\frac{1}{2}$ setscrews (E) securing cylinder to shaft. Position gussets (C) at each side of cylinder and against mounting shaft. Secure each gusset to cylinder head with a $\frac{3}{4}$ -16 x $1\frac{1}{4}$ bolt, and to mounting shaft with two bearing caps (D), using two $\frac{3}{4}$ -16 x 2 bolts (H) at each cap (D). Tighten bolts evenly and alternately.
- (2) *Install cylinder and gussets.* Position cylinder, gussets, and mounting shaft assembly in subframe. Mounting shaft ends must be seated in welded brackets in subframe. Install mounting shaft lock blocks (A) at each end of shaft. Install four $\frac{5}{8}$ -18 x $1\frac{1}{2}$ cap screws (B) and $\frac{5}{8}$ -18 nuts (G) attaching each mounting shaft lock block (A) to subframe. Install lubrication fitting at each end of mounting shaft.
- (3) *Connect high pressure lines.* Connect high pressure lines (J and K) to connectors at end of cylinder.

Note. Upper line at control valve must be connected to left side of cylinder.

- (4) *Connect piston rod.* Pull piston rod out of cylinder until it can be inserted into crosshead as shown in figure 354. Install lower and upper piston rod lock retainers in crosshead and around groove in piston rod. Install two $\frac{3}{8}$ -24 x $2\frac{1}{2}$ bolts securing retainers in crosshead.
- (5) *Fill fluid reservoir.* Fill reservoir with fluid specified on lubrication chart (par. 69) as directed in paragraph 325*d*.
- (6) *Operate hoist.* Operate hoist as directed in paragraph 51*b* until system is free of air and fluid level is at center mark on dipstick gage (par. 325).

e. Record of Replacement. Record the replacement on DA Form 478.

329. Crosshead Roller Arms

a. General. Crosshead roller arms are installed on each end of crosshead. One end of roller arm is attached to dump body by a lifting pin while opposite end is fitted with a roller.

b. Removal.

- (1) *Raise body.* Raise body and position safety braces as directed in paragraph 51*d*.

- (2) *Install wood support.* Refer to paragraph 328c(3).
- (3) *Remove lifting pins.* At each side, remove nut, lockwasher, and cap screw (B, fig. 356) securing lifting pins (A, fig. 356) to body. Use drift pin and hammer to drive lifting pins from body and roller arms.

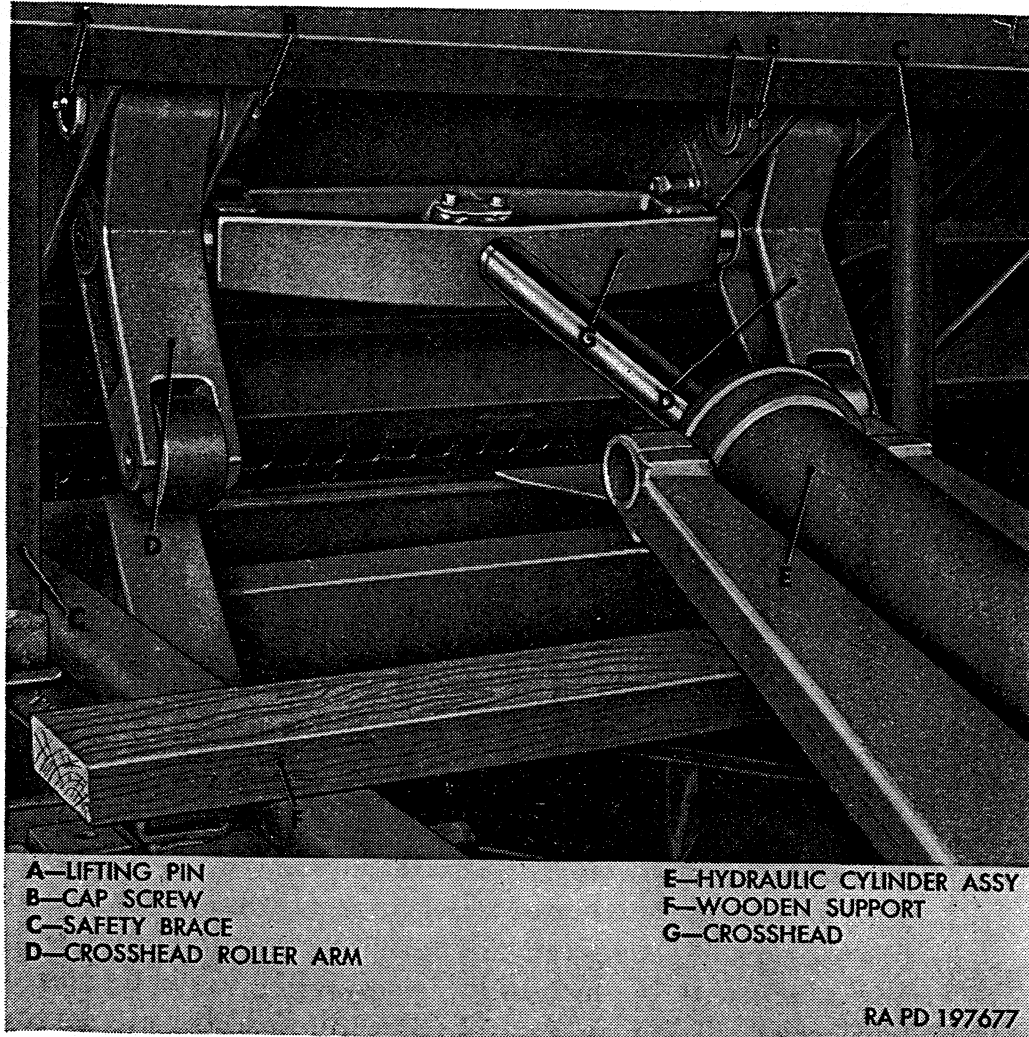

Figure 356. Hoist crosshead and roller arms installed.

- (4) *Retract piston rod.* Place transfer lever in DOWN NEUTRAL position. Place transmission shift control lever into F-2 HIGH RANGE position. Place power-take-off lever in BODY LOWER position (fig. 45), then accelerate engine to retract roller arms from body.
 - (5) *Remove crosshead roller arm* (fig. 357). When lifting pins are removed and piston rod retracted, roller arms can be lifted from crosshead.
- c. *Installation.*

- (1) *Install crosshead roller arm* (fig. 357). Install roller arm at each end of crosshead, with roller resting on subframe track.

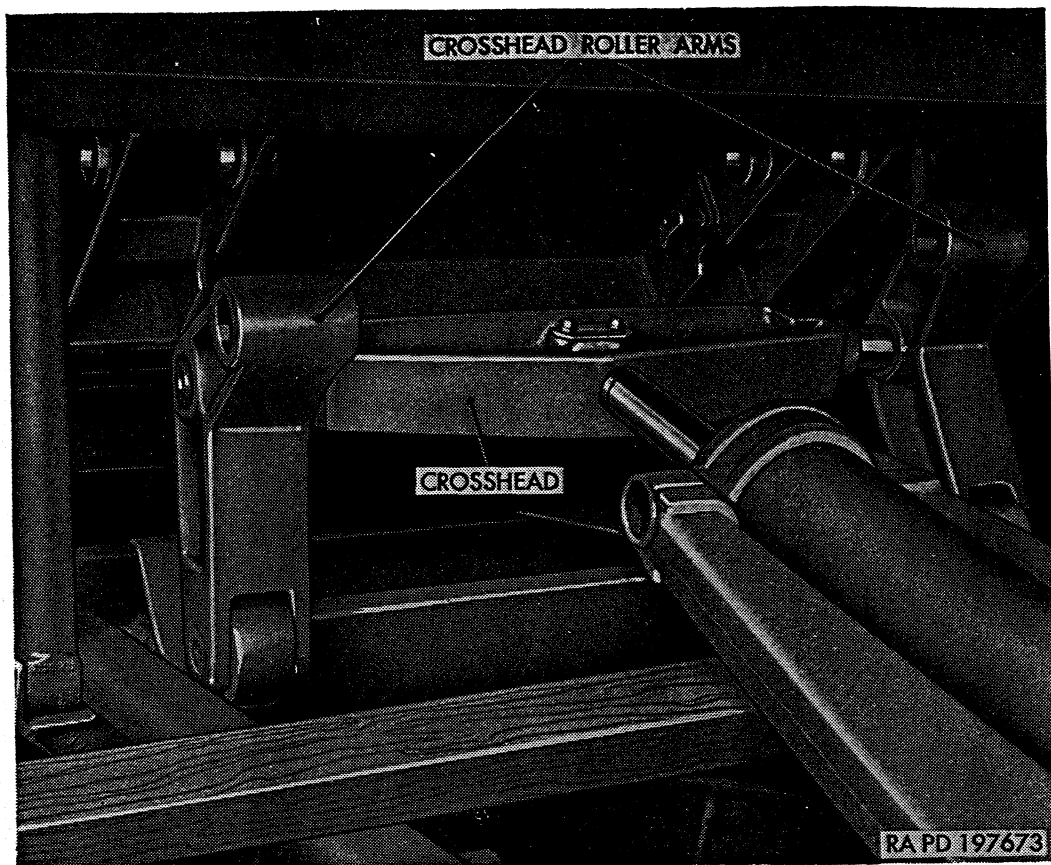

Figure 357. Hoist roller arms disconnected.

- (2) *Operate hoist.* Operate hoist as directed in paragraph 51*b* until crosshead roller arms are in their approximately correct position at body.
- (3) *Install lifting pins.* Install lifting pins (A, fig. 356) through body braces and crosshead roller arms (D, fig. 356). Install one $\frac{5}{16}$ -24 x $3\frac{1}{4}$ cap screw (B, fig. 356), retaining pin to body and secure with $\frac{5}{16}$ -inch lockwasher and $\frac{5}{16}$ -24 nut. Install lubrication fitting in each lifting pin. Lubricate as instructed on lubrication chart (par. 69).
- (4) *Lower body.* Operate hoist as instructed in paragraph 51*b* until safety braces can be lowered and wooden support (fig. 356) can be removed. Lower body to subframe.

330. Hoist Crosshead

a. General. Hoist crosshead (G, fig. 356) is used between two crosshead roller arms and is connected to hoist cylinder piston rod (fig. 354).

b. Removal.

- (1) Remove crosshead roller arms (par. 329*b*).
- (2) Remove two bolts from piston rod lock retainers; then remove upper and lower retainers from crosshead, and remove crosshead from piston rod (fig. 354).

c. Installation.

- (1) Install crosshead to piston rod as shown in figure 354 (par. 328d(4)).
- (2) Install right and left crosshead roller arms on crosshead and secure to body (par. 329c).

331. Hoist Pump

a. General. Hoist fluid pump is gear-type and is attached to the crossover adapter assembler (G, fig. 347). Pump is driven by a drive shaft from an accessory drive mounted on power-take-off assembly.

b. Removal.

- (1) *Raise body.* Operate body hoist and raise body until safety braces can be installed (par. 51d). Place power-take-off control lever in BODY HOLD position (fig. 45).
- (2) *Disconnect drive shaft.* Remove socket-head setscrew attaching drive shaft yoke to pump drive shaft. Remove yoke from shaft.
- (3) *Remove pump.* Place receptacle under pump to catch fluid as pump is removed. Remove six cap screws and lockwashers attaching pump assembly to crossover adapter, then remove pump assembly. Remove and discard gasket.

c. Installation.

- (1) *Install pump.* Position pump assembly to crossover adapter, using new gasket. Install six $\frac{1}{2}$ -13 x $1\frac{1}{4}$ cap screws and $\frac{1}{2}$ -inch lockwashers attaching pump to crossover adapter. Tighten cap screws evenly and alternately.
- (2) *Connect drive shaft.* Install $\frac{5}{32}$ x $\frac{3}{4}$ woodruff key in pump drive shaft. Position drive shaft yoke over pump drive shaft, with key and keyway in alignment; then push yoke onto shaft. Install a $\frac{3}{8}$ -16 x $\frac{1}{2}$ socket-head setscrew securing yoke to pump shaft; then prick punch yoke around screw to prevent loosening.
- (3) *Lower body.* Lower safety braces; then lower body (par. 51b(3)).
- (4) *Check fluid level.* Check and replenish fluid (par. 325b).

332. Crossover Adapter

a. General. Crossover adapter is mounted between hoist pump and control valve adapted assembly (H, fig. 347). Assembly consists of four spring-loaded balls held in a body by plugs. Purpose of adapter is to control fluid to desired passages since rotation of hoist pump is always the same, regardless of direction of vehicle.

b. Removal.

- (1) Remove hoist pump (par. 331b).

- (2) Remove six cap screws and lockwashers attaching crossover adapter to control valve adapter; then remove crossover adapter. Remove and discard gasket.

c. Installation.

- (1) Position crossover adapter assembly to control valve adapter, using new gasket. Install six $\frac{1}{2}$ -13 x $1\frac{1}{4}$ cap screws and $\frac{1}{2}$ -inch lockwashers attaching the two adapters to each other. Tighten cap screws evenly and alternately.

Note. Side of adapter with two plugs must be toward front of vehicle.

- (2) Install hoist pump (par. 331*e*).

333. Control Valve Adapter

(fig. 358)

a. General. Control valve adapted assembly is mounted between control valve and crossover adapter as shown in figure 358. Adapter provides a means for fluid passage between control valve and crossover adapter.

b. Removal.

- (1) Remove hoist pump (par. 331*b*).
- (2) Remove crossover adapter (par. 332*b*).

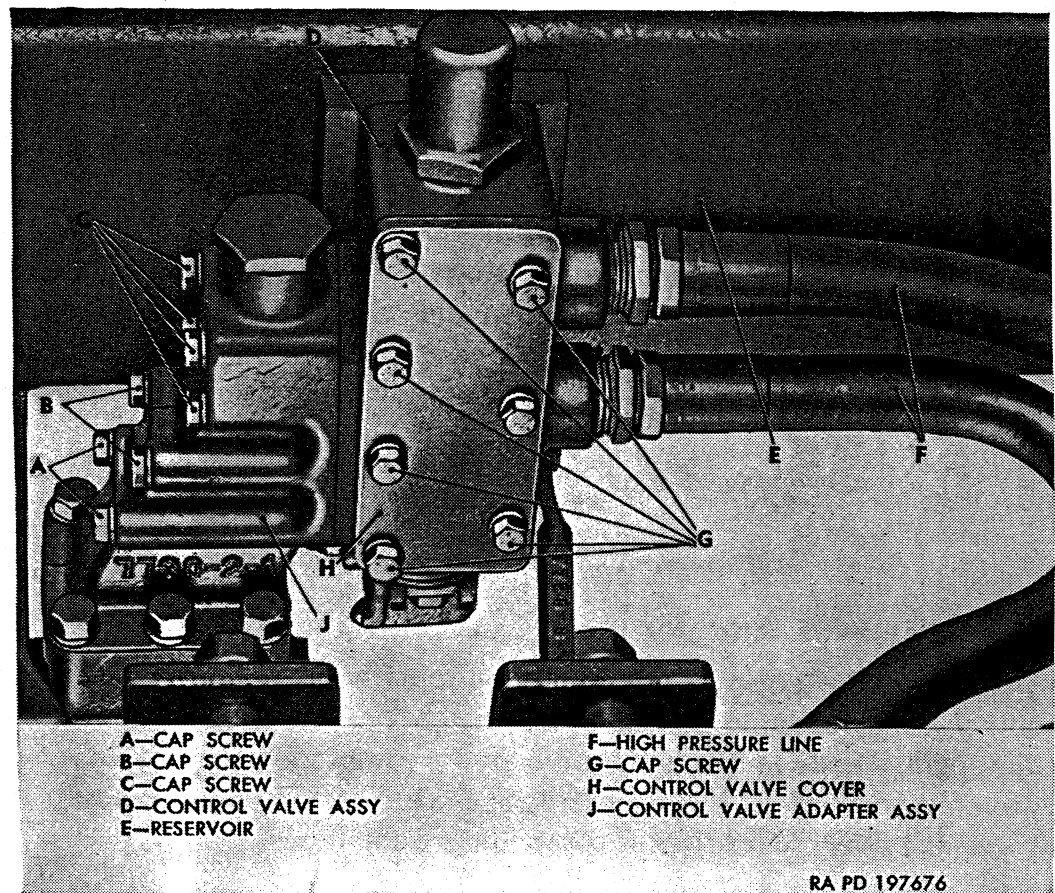

Figure 358. Control valve and valve adapter mounting.

- (3) Remove eight cap screws (A, B, and C) and lockwashers attaching adapter (J) to control valve assembly (D) then remove adapter. Remove and discard gasket.

c. Installation.

- (1) Position control valve adapter assembly (J) to control assembly (D), using new gasket. Install four $\frac{3}{8}$ -16 x $4\frac{1}{4}$ cap screws (C), two $\frac{3}{8}$ -16 x $3\frac{1}{4}$ cap screws (B), and two $\frac{3}{8}$ -16 x $2\frac{3}{4}$ cap screws (A), using one $\frac{3}{8}$ -inch lockwasher with each cap screw. Tighten cap screws alternately and evenly.
- (2) Install crossover adapter assembly (par. 332c).
- (3) Install hoist pump (par. 331c).

334. Control Valve

a. General. Control valve assembly (D, fig. 358) is mounted on fluid reservoir at front of subframe. Control valve assembly contains a spool-type valve which is operated by linkage to control fluid as necessary to raise, lower, or hold dump body.

b. Removal.

- (1) *Raise body.* Operate body hoist and raise body until safety braces can be installed (par. 51d).
- (2) *Drain fluid.* Drain fluid from reservoir (par. 325c).
- (3) *Remove high pressure lines* (fig. 359). Remove two high pressure lines from fittings at base of hydraulic cylinder, then remove both lines from control valve.
- (4) *Remove pump and adapters* (fig. 358). Remove drive shaft from pump shaft (par. 331b(2)). Remove eight cap screws (A, B, and C) and lockwashers attaching adapter to control valve assembly; then remove pump, crossover adapter, and control valve adapter as an assembly. Remove and discard gasket.
- (5) *Disconnect control linkage* (fig. 348). At control box, under reservoir, remove nut (T), cap screw (B), and washer which clamp together two control box valve shaft levers (C). Remove control valve spool trunnion (W) from slot in levers.
- (6) *Remove control valve* (fig. 358). Remove seven cap screws (G) attaching control valve assembly (D) to reservoir (E). Remove control valve cover (H) and control valve assembly. Remove and discard gaskets used between cover and valve, and between valve and reservoir.

c. Installation.

- (1) *Install control valve* (fig. 358). Position a new gasket at each side of control valve body; then position control valve cover (H) to valve body. Hold gaskets and cover by installing seven $\frac{3}{8}$ -24 x 4 cap screws (G) through valve body.

- Position control valve assembly (D) to reservoir (E); then tighten cap screws evenly and alternately.
- (2) *Connect control linkage* (fig. 348). Position control valve spool trunnion (W) in slot of each control box valve shaft lever (C). Install $\frac{3}{8}$ -24 x $3\frac{1}{2}$ cap screw, $\frac{3}{8}$ -inch lockwasher, and $\frac{3}{8}$ -24 nut (T); then tighten sufficiently to hold trunnion in lever slots.
 - (3) *Install pump and adapters* (fig. 358). Position pump and adapter assembly to control valve assembly, using new gasket. Install four $\frac{3}{8}$ -16 x $4\frac{1}{4}$ cap screws (C), two $\frac{3}{8}$ -16 x $3\frac{1}{4}$ cap screws (B), and two $\frac{3}{8}$ -16 x $2\frac{3}{4}$ cap screws (A), using one $\frac{3}{8}$ -inch lockwasher with each cap screw. Tighten cap screws alternately and evenly.
 - (4) *Install high pressure lines* (fig. 359). Attach high pressure lines to openings in control valve and tighten. Attach lower line at control valve to left opening in cylinder, and attach upper line at control valve to right opening in cylinder. Tighten lines to prevent fluid leaks.
 - (5) *Fill fluid reservoir*. Fill fluid reservoir as instructed in paragraph 325d.
 - (6) *Lower body*. Lower body (par. 51b).

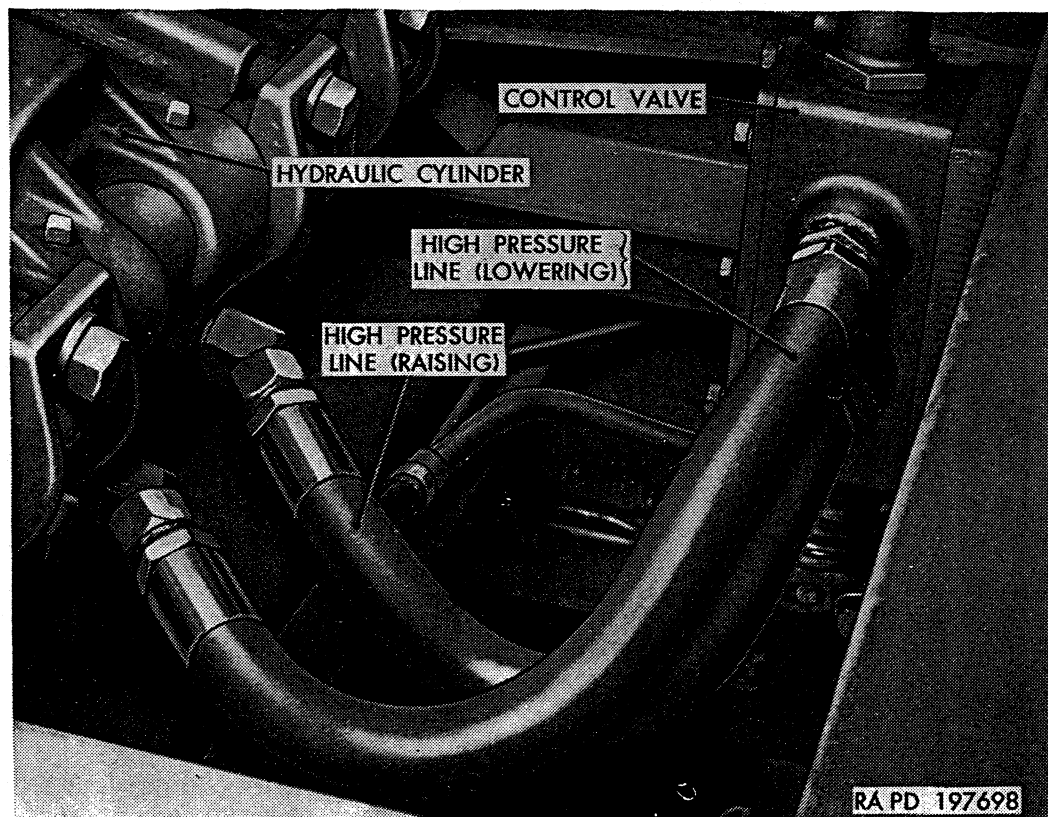

Figure 359. Fluid pressure lines installed.

335. Control Box

Note. The key letters in parentheses are in figure 348, except where otherwise indicated.

a. General. Control box assembly (K, fig. 347) is installed on subframe under fluid reservoir. Control box transmits manual control linkage movement to power-take-off and control valve linkage as necessary to operate dump body.

b. Removal.

- (1) At control box lever (N), remove cotter pin (L), and plain washer (M); then pull shifting rod trunnion (R) from lever. At control box lever (D), remove cotter pin (J) and clevis pin (E); then remove shifting rod from lever.
- (2) At control box valve shaft levers (C), remove nut (T) from cap screw (B) which clamps two levers together; then remove cap screw. Pry levers (C) apart sufficiently to remove control valve spool trunnion (W) from slot in levers.
- (3) Remove two hex-head bolts, one screw, and one lockwasher attaching control box to subframe fluid reservoir.

c. Installation.

- (1) Position control box assembly to under side of fluid reservoir. Install two $\frac{3}{8}$ -24 x 1 bolts, one $\frac{3}{8}$ -24 x 1 screw, and one lockwasher. Tighten bolts and screw.
- (2) Position control valve spool trunnion (W) in slot of each control box valve shaft lever (C). Install $\frac{3}{8}$ -24 x $3\frac{1}{2}$ cap screw (B), $\frac{3}{8}$ -inch lockwasher, and $\frac{3}{8}$ -24 nut (T); then tighten sufficiently to hold trunnion in lever slots.
- (3) Install shifting rod trunnion (R) stud to control box lever (N) and secure with plain washer (M) and $\frac{1}{8}$ x $\frac{7}{8}$ cotter pin (L). Install shifting rod adjustable yoke (F) to control box lever (D), using clevis pin (E) and $\frac{1}{8}$ x $\frac{7}{8}$ cotter pin.
- (4) Operate hoist to raise and lower body several times (par. 51) and observe if controls operate satisfactorily. If necessary, adjust (par. 324).

336. Power-Take-Off and Hoist Control Linkage

Note. The key letters in parentheses are in figure 361, except where otherwise indicated.

a. General. Power-take-off control lever (fig. 360) in cab is interconnected to control box, control valve, and power-take-off accessory drive with linkage. Power-take-off control lever can be placed in varied positions to operate hoist as described in paragraphs 50 and 51.

b. Control Lever Lock Bracket Replacement.

- (1) *Removal.* At cab left panel, remove two nuts (T) and cap screws (U) attaching control lever lock bracket (V) to panel. Remove bracket.

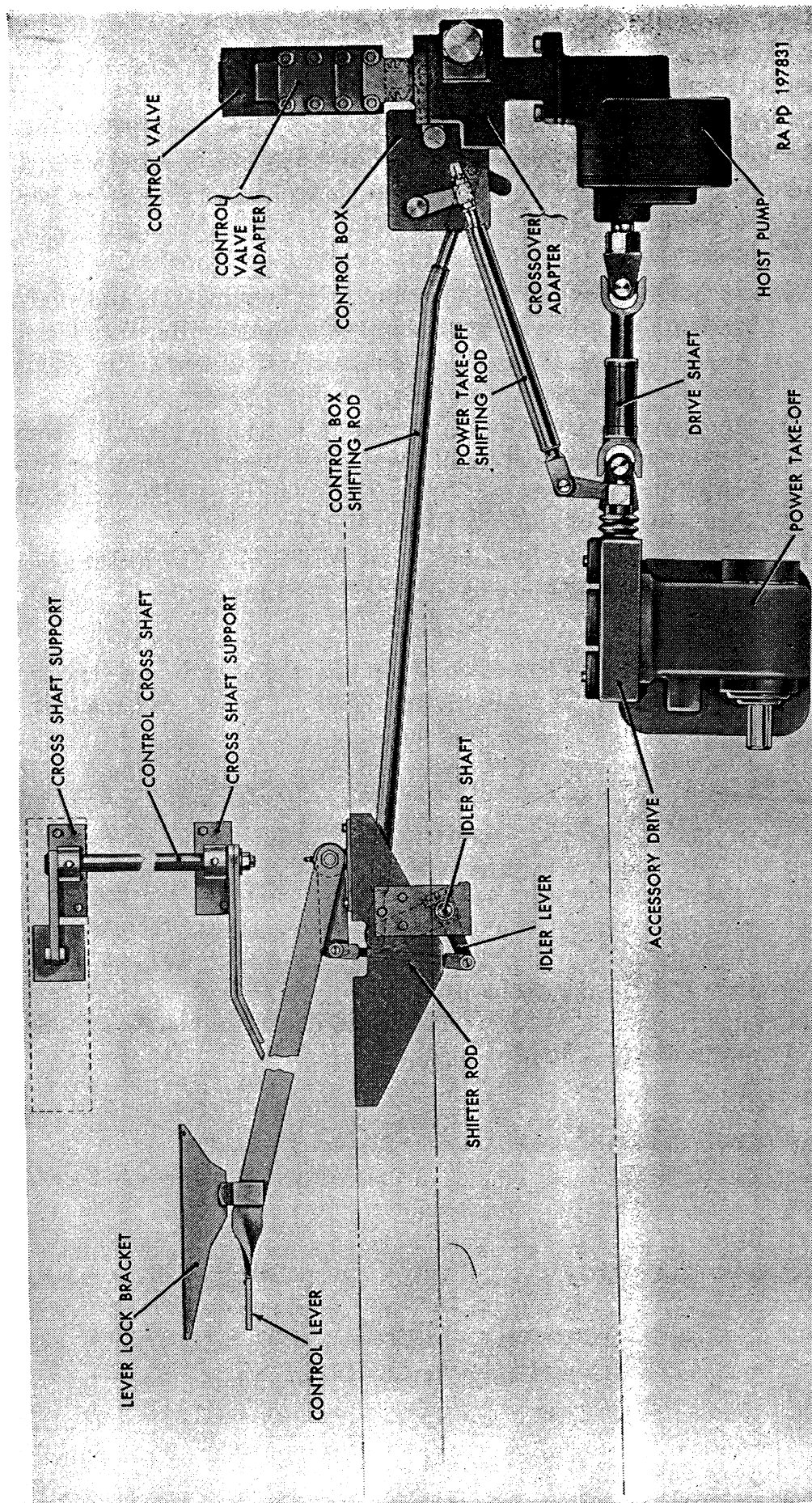

Figure 360. Power-take-off and hoist control linkage arrangement.

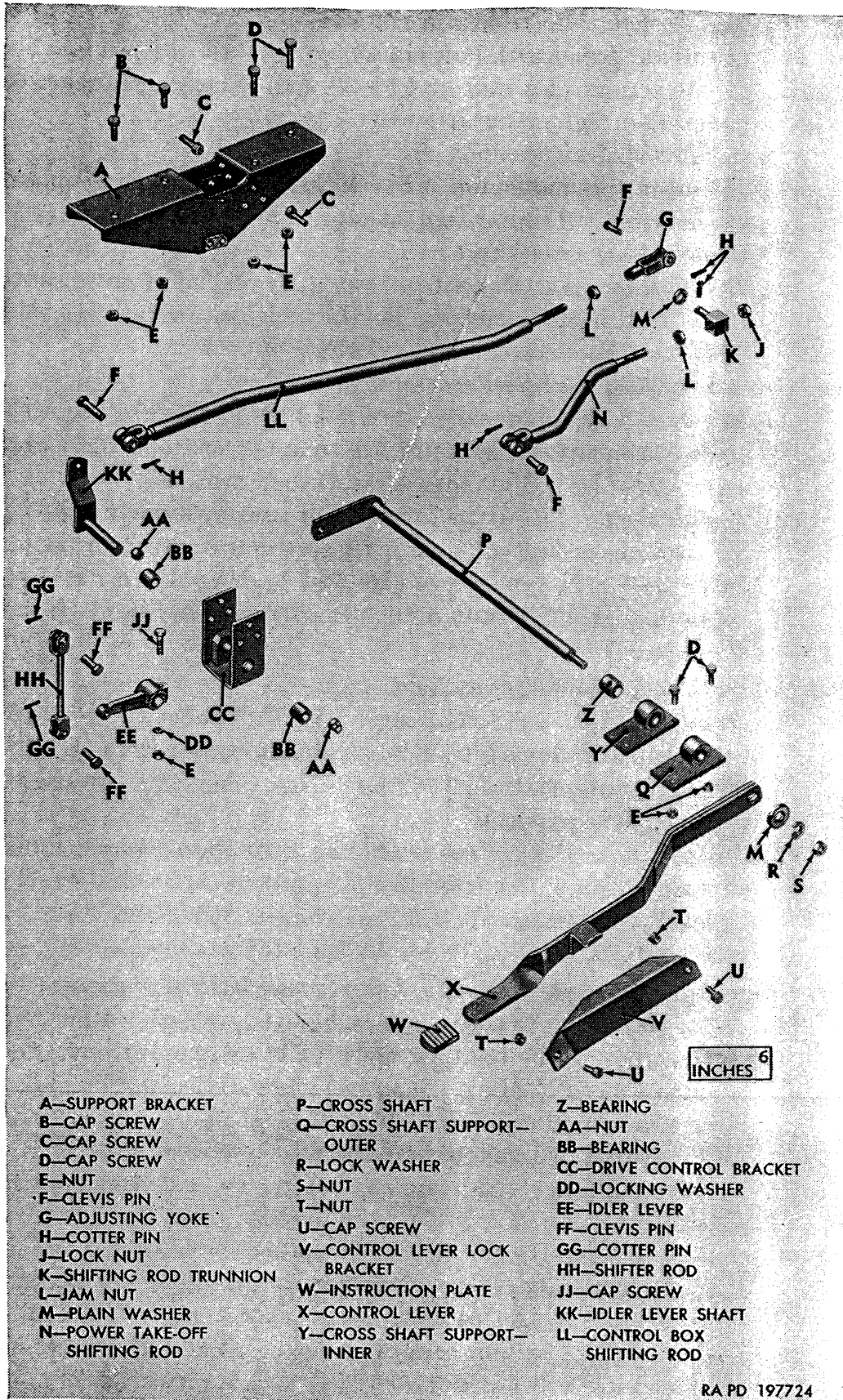

Figure 361. Power-take-off and hoist control linkage components.

(2) *Installation.* Position control lever lock bracket (V) inside of cab left panel with holes in alignment. Install two $\frac{1}{4}$ -28 x $\frac{7}{8}$ cap screws (U) and $\frac{1}{4}$ -28 nuts (T) attaching bracket to panel; then tighten nuts equally.

c. *Control Lever Replacement.*

(1) *Removal.* Remove nut (S), lockwasher (R), and plain washer (M) retaining control lever (X) to cross shaft (P). Remove lever from shaft.

(2) *Installation.* Install control lever (X) on end of cross shaft (P). Install plain washer (M), $\frac{1}{2}$ -inch lockwasher (R), and $\frac{1}{2}$ -20 nut (S) on cross shaft. Tighten nut.

d. *Cross Shaft Support Replacement.*

(1) *Removal.* Remove control lever (X) (c(1) above). At each cross shaft support (Q and Y), remove two nuts (E) and cap screws (D). Slide supports off cross shaft.

(2) *Installation.* Install two outer and inner supports (Q and Y) over cross shaft (P). Secure supports to cab floor, using two $\frac{5}{16}$ -24 x $\frac{7}{8}$ cap screws (D) and $\frac{5}{16}$ -24 nuts (E) at each support. Tighten nuts. Install control lever (X) (c(2) above).

e. *Control Cross Shaft Replacement.*

(1) *Removal.* Remove control lever (X) (c(1) above). Remove cotter pin and clevis pin (FF) attaching shifter rod (HH) to lever on cross shaft (P). Slide cross shaft (P) inward to remove from supports.

(2) *Installation.* Slide cross shaft (P) through outer and inner supports (Q and Y) from inside. Attach shifter rod (HH) to lever on cross shaft, using clevis pin (FF) and $\frac{3}{32}$ x $\frac{5}{8}$ cotter pin. Install control lever (X) (c(2) above).

f. *Control and Support Brackets, Lever, and Shaft Replacement.*

(1) *Removal.* Remove cotter pin and clevis pin (FF) attaching shifter rod (HH) to idler lever (EE). Remove nut (E), locking washer (DD), cap screw (JJ) and clamping idler lever (EE) to idler lever shaft (KK). Push idler lever shaft (KK) from drive control bracket (CC) and idler lever (EE). Remove six nuts (AA) and cap screws (C) attaching drive control bracket (CC) to support bracket (A); then remove control bracket (CC) and two bushing-type bearings (BB). Remove four nuts (E) and cap screws (B and D) attaching support bracket (A) to floor board; then remove bracket.

(2) *Installation.* Position support bracket (A) to underside of cab floor and secure with two $\frac{5}{16}$ -24 x $\frac{7}{8}$ and two $\frac{5}{16}$ -24 x $\frac{5}{8}$ cap screws (B and D) and four $\frac{5}{16}$ -24 nuts (E). Position drive control bracket (CC) to support bracket, using six $\frac{3}{8}$ -24 x $\frac{3}{4}$ cap screws (C) and $\frac{3}{8}$ -24 nuts (AA). Install two

bushing-type bearings (BB) in bracket (CC). Install idler lever shaft (KK) through drive control bracket (CC) and idler lever (EE). Aline slot in idler shaft with split in idler lever; then install locking washer (DD), $\frac{5}{16}$ -24 x $1\frac{3}{8}$ cap screw (JJ), and $\frac{5}{16}$ -24 nut (E). Install clevis pin (FF) and $\frac{3}{32}$ x $\frac{5}{8}$ cotter pin attaching shifter rod (HH) to idler lever (EE).

g. Shifting Rod Replacement.

- (1) *Removal.* At each end of control box shifting rod (LL), remove cotter pin and clevis pin; then remove rod assembly. At power-take-off end of shifting rod (N), remove cotter pin and clevis pin, also remove cotter pin and plain washer at control box lever; then remove rod assembly.
- (2) *Installation.* Position control box shifting rod (LL) and secure forward end to idler lever shaft (KK) and adjustable yoke end to control box lever, using $\frac{1}{2}$ x $1\frac{13}{64}$ clevis pins (F) and $\frac{1}{8}$ x $\frac{7}{8}$ cotter pins. Attach plain yoke of power-take-off shifting rod (N) to accessory drive shifter shaft lever, using $\frac{1}{2}$ x $1\frac{13}{64}$ clevis pin (F) and $\frac{1}{8}$ x $\frac{7}{8}$ cotter pin. At trunnion end of power-take-off shifting rod (N), attach shifting rod trunnion (K) to control box lever, using plain washer (M) and $\frac{1}{8}$ x $\frac{7}{8}$ cotter pin.

337. Power-Take-Off Drive Shaft

a. General. Hoist pump assembly is driven from accessory drive unit assembly, which is mounted on top of power-take-off assembly. Drive shaft assembly (fig. 362) connecting pump and accessory drive unit is conventional type consisting of two universal joints and slip joint.

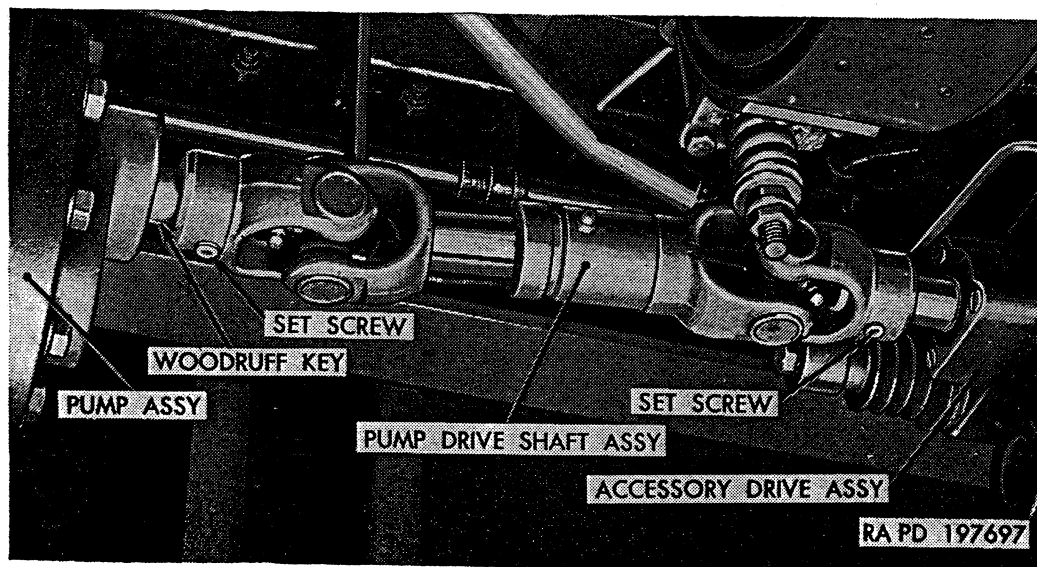

Figure 362. Pump drive shaft installed.

b. Replacement.

- (1) *Removal* (fig. 362). Remove setscrew at each end of drive shaft. Use soft hammer to tap universal joint yokes from pump and accessory drive shafts. Remove woodruff keys.
- (2) *Installation* (fig. 362). Install one $\frac{1}{4} \times \frac{7}{8}$ woodruff key in pump and accessory drive shafts. Position drive shaft assemblies with keyways in universal joint yokes aligned with keys in shafts. Tap yokes with soft hammer until fully installed on shafts. Install a $\frac{3}{8}$ -16 \times $\frac{1}{2}$ socket-head setscrew in yoke at each end of shaft. Prick punch each screw to prevent loosening.

c. Drive Shaft and Universal Joint Repair.

Note. The key letters in parentheses are in figure 363, except where otherwise indicated.

- (1) *General.* The following procedures cover disassembly, cleaning and inspection, and assembly of drive shaft assembly, after it has been removed from vehicle (b(1) above).

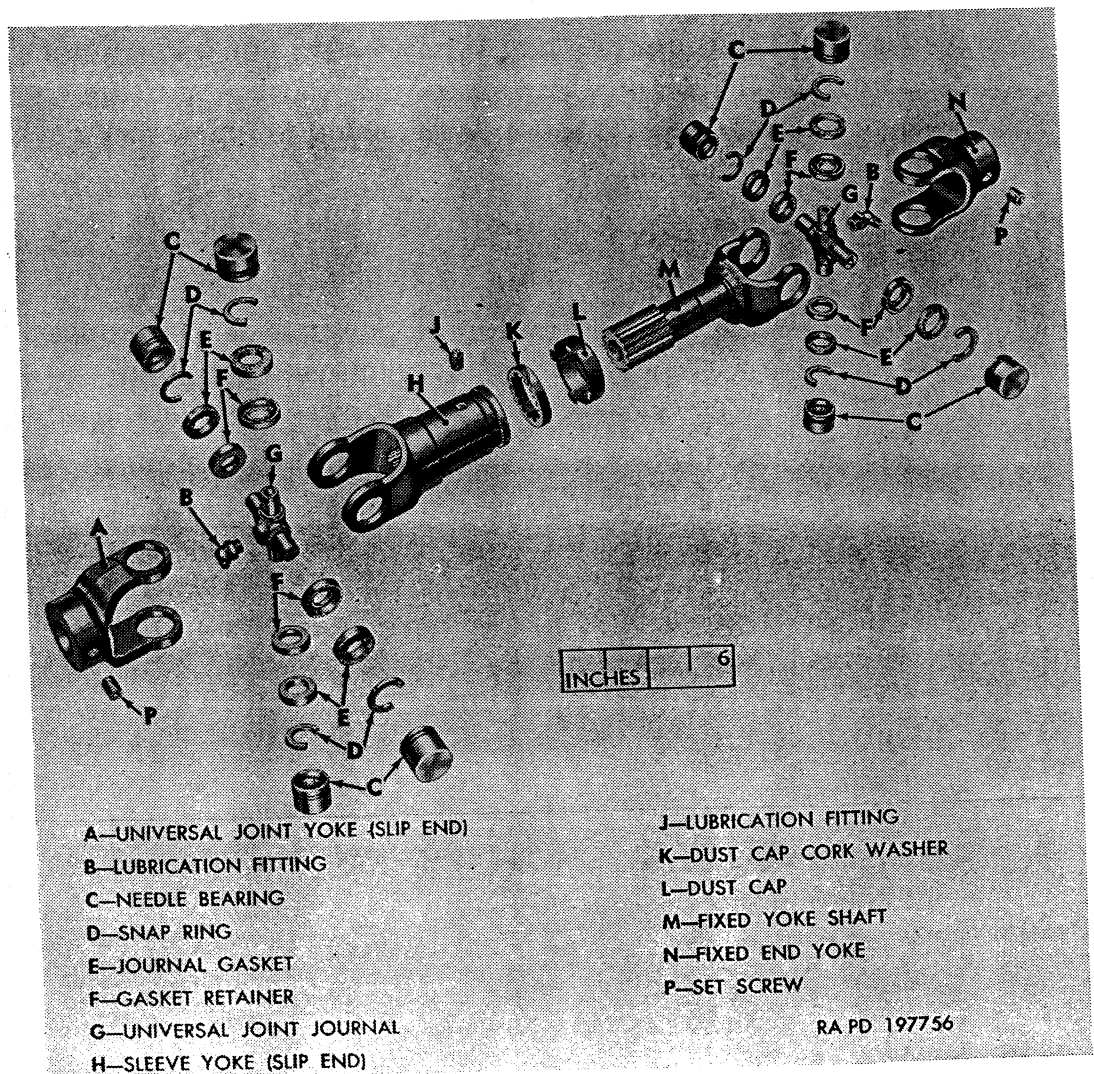

Figure 363. Pump drive shaft components.

(2) *Disassembly.*

- (a) Before disassembling drive shaft assembly, check for alignment arrows on sleeve yoke and yoke shaft. If arrows are not readily visible, scratch arrows on parts for reassembly reference.
- (b) Bend tangs of dust cap (L) out of groove in sleeve yoke (H). Pull sleeve yoke (H) off fixed yoke shaft (M); then remove dust cap cork washer (K) and dust cap (L) from yoke shaft.
- (c) Remove lubrication fitting (B) from universal joint journal (G).
- (d) Clamp one yoke of universal joint in vise. Remove four snap rings (D) securing needle bearings (C) in yokes.
- (e) With one yoke supported in vise, strike opposite yoke with soft hammer to force bearing out of yoke. Turn yoke over and strike in opposite direction to force out opposite bearing. This procedure is the same as illustrated for winch drive shaft in figure 342. Remove yoke when bearings are removed from journal.
- (f) Support free ends of journal (fig. 342) on vise jaws and strike yoke with soft hammer to remove one bearing; then turn over and drive out opposite bearing.
- (g) Remove universal joint journal (G) from yoke; then remove journal gaskets (E) and gasket retainers (F) from journal.

(3) *Cleaning and inspection.*

- (a) Discard journal gaskets (E), gasket retainers (F), snap rings (D), and dust cap cork washer (K) and obtain new parts for assembly. Wash all other parts in dry-cleaning solvent or volatile mineral spirits. Make sure lubricant passages through journals (G) are open, and that all old lubricant is removed from inside of needle bearings (C).
- (b) Check fit of bearings on journal. If excessive wear is evident, or if any rollers are missing from bearing, replace with new journal and bearings. Make sure sleeve yoke (H) slides freely on fixed yoke shaft (M). If backlash between yoke and shaft splines exceeds 0.005 inch, replace worn parts.

(4) *Assembly.*

- (a) Assembly of universal joint ((b) through (e) below), applies to universal joint at slip end or fixed end. Pack bearings with automotive and artillery grease (GAA) before assembly.
- (b) Install new gasket retainer (F) and new journal gasket (E) on each arm of universal joint journal (G). Push retainers down against shoulders on journal and make sure

- journal gasket is fully seated in each retainer. Install elbow lubrication fitting (B) in journal (G), with end of fitting pointing between two arms of journal for accessibility.
- (c) Grip hub of one yoke in vise and insert journal into yoke. Start one needle bearing (C) into each side of yoke, guiding ends of journal into bearings. Drive bearings in until snap ring grooves in bearings are fully exposed at inside of yoke; then install new snap rings (D), making sure they are fully seated.
 - (d) Position opposite yoke in vise and insert free ends of journal into yoke; then install bearings and snap rings as in (c) above.
 - (e) Install dust cap (L) over splined yoke shaft and place dust cap cork washer (K) in retainer. Place sleeve yoke (H) on splined fixed yoke shaft (M) with arrows aligned, place dust cap and new cork washer against end of yoke, and bend tangs of cap into groove in yoke.

Section XXXVI. WATER TANK BODY AND CONTROLS

338. Description and Data

a. *Description.*

- (1) *General.* Water tank body used on water tank truck M222 is a 1,000-gallon tank divided into two compartments. The forward compartment is of 400-gallon capacity and the rear compartment is of 600-gallon capacity. Each compartment has a manhole and filler hole with sealed covers at top, and a drain valve at bottom. Drain valves are controlled by levers in equipment compartment at rear. Both drain valves open into a single drain pipe which leads to pump suction gate valve in equipment compartment. All parts of tank are of aluminum, except equipment compartment, running boards, and skirting which are of steel. Bow pockets are provided in running boards for installation of camouflage bows and paulin.
- (2) *Exhaust heater.* An exhaust control valve, controlled by a handle in cab, is provided to permit driver to direct engine exhaust either through the engine exhaust muffler or through the water tank heating chamber. Engine exhaust provides sufficient heat to prevent water freezing while in transit. Exhaust gate valve at exhaust entrance into tank heating chamber is provided only to prevent entrance of water into tank heating chamber when deep water fording.
- (3) *Equipment compartment.* Equipment compartment at rear of tank is accessible through two doors. Tank pump, drain valve control levers, pump suction gate valve, pump dis-

charge gate valve handwheel, and hose and accessory stowage compartments are contained in the equipment compartment.

b. Data.

Tank body :
 Make ----- The Heil Company
 Capacity :
 Front compartment ----- 400 gal
 Rear compartment ----- 600 gal
 Tank pump :
 Make ----- Blackmer Pump Company
 Ordnance number ----- 8327899
 Capacity ----- 60 gpm at 500 rpm

339. Body Mounting

a. Description. Water tank body is attached to vehicle frame side members at four points on each side. Front mounting at each side is dual spring flexible-type mounting, the two center mountings are single spring flexible-type mountings, and rear mounting consists of a bolt attaching tank mounting channel directly to frame side member. Wood sills, drilled to provide clearance at rivet heads, are used between body mounting channels and frame side members.

b. Replacement. When mountings have been removed for any reason, parts must be installed in positions shown in figure 364. Bolt sizes are as follows: dual spring-type mounting— $\frac{5}{8}$ -18 x 9; single spring-type mounting— $\frac{3}{4}$ -16 x $6\frac{1}{2}$; rear mounting— $\frac{5}{8}$ -18 x $4\frac{1}{2}$ carriage bolt. Note that inner and outer springs are used on each bolt on front mounting, with plain washer next to bolt-head and under nut. On single spring-type mounting, install keeper at each end of spring and plain washer under nut. Tighten spring-type mounting bolts until springs are compressed to dimensions shown in

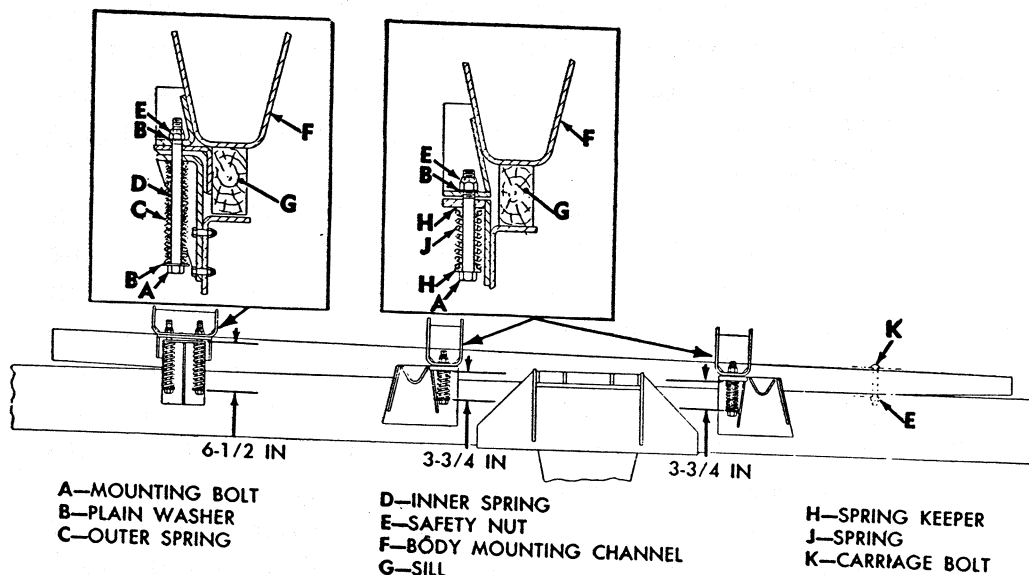

Figure 364. Water tank mountings.

RA PD 197695

figure 364. Tighten rear mounting bolt to 95 to 127 pound-foot torque.

340. Manhole Covers

(fig. 365)

a. General. A manhole is provided in top of each tank compartment. Provision is made in each manhole for installation of a submerision-type water heater. When heater is not used, a heater opening cover is used. Since these water tanks are used in many cases to transport drinking water, it is important that cover gaskets be replaced whenever necessary to maintain a leakproof seal.

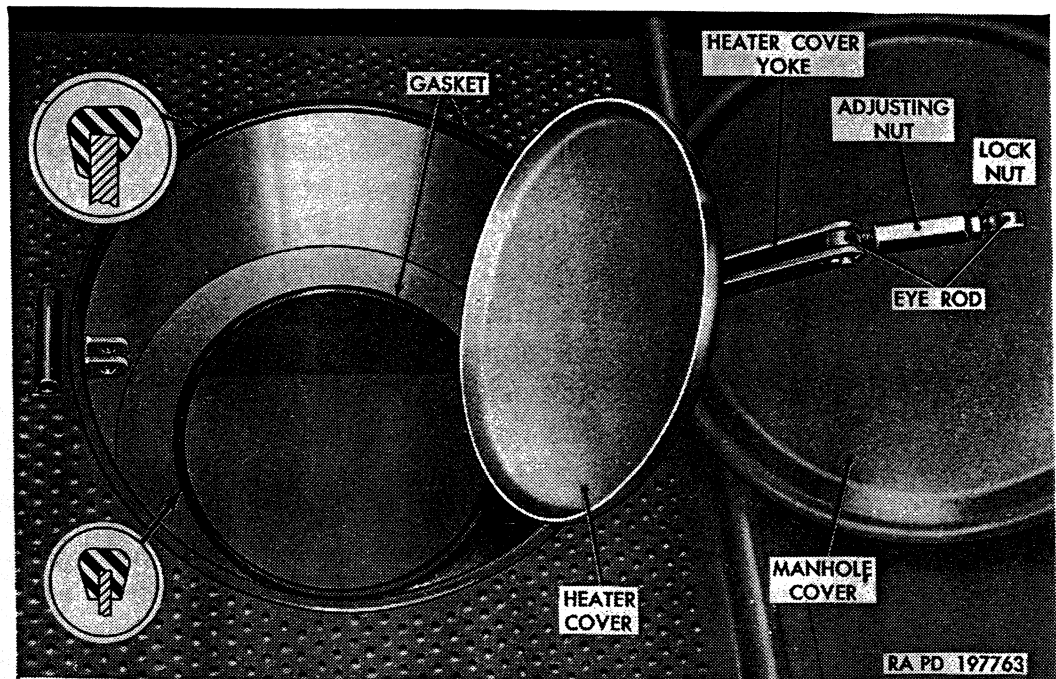

Figure 365. Manhole and heater cover gaskets.

b. Gasket Removal.

- (1) Unlock manhole cover padlock and remove padlock. Swing manhole cover to open position.
- (2) Loosen locknut on eye rod; then loosen adjusting nut to remove tension from heater cover yoke.
- (3) Remove cotter pin and clevis pin attaching eye rod to brackets on manhole wall. With eye rod disconnected, pull up on heater cover yoke to open heater cover.
- (4) Remove gaskets from around heater cover opening and manhole cover opening.
- (5) Clean all particles of old gasket or sealing compound from opening flanges, using dry-cleaning solvent or scraper as necessary. Use caution not to permit cleaning solvent or dirt particles to enter the tank compartment. Also make sure

surfaces of covers which contact gaskets are clean and smooth.

c. Gasket Installation.

- (1) Install heater cover gasket on flange around heater opening. Make sure gasket is fully seated all the way around.
- (2) Apply gasket cement to top and outside diameter of manhole opening flange; then install manhole cover gasket on flange. Make sure gasket is fully seated all the way around.
- (3) Close heater cover. Position eye rod in brackets on manhole wall and secure with clevis pin and cotter pin. Turn adjusting nut to exert a downward force on heater cover yoke, which in turn forces cover down against gasket; tighten just enough to form a watertight seal. Secure adjusting nut with locknut.
- (4) Close manhole cover and secure with padlock.

341. Filler Cover and Strainer

(fig. 366)

a. General. Filler opening for each tank compartment is equipped with a filler pipe and coupling and a filler cover. Filler pipe is a

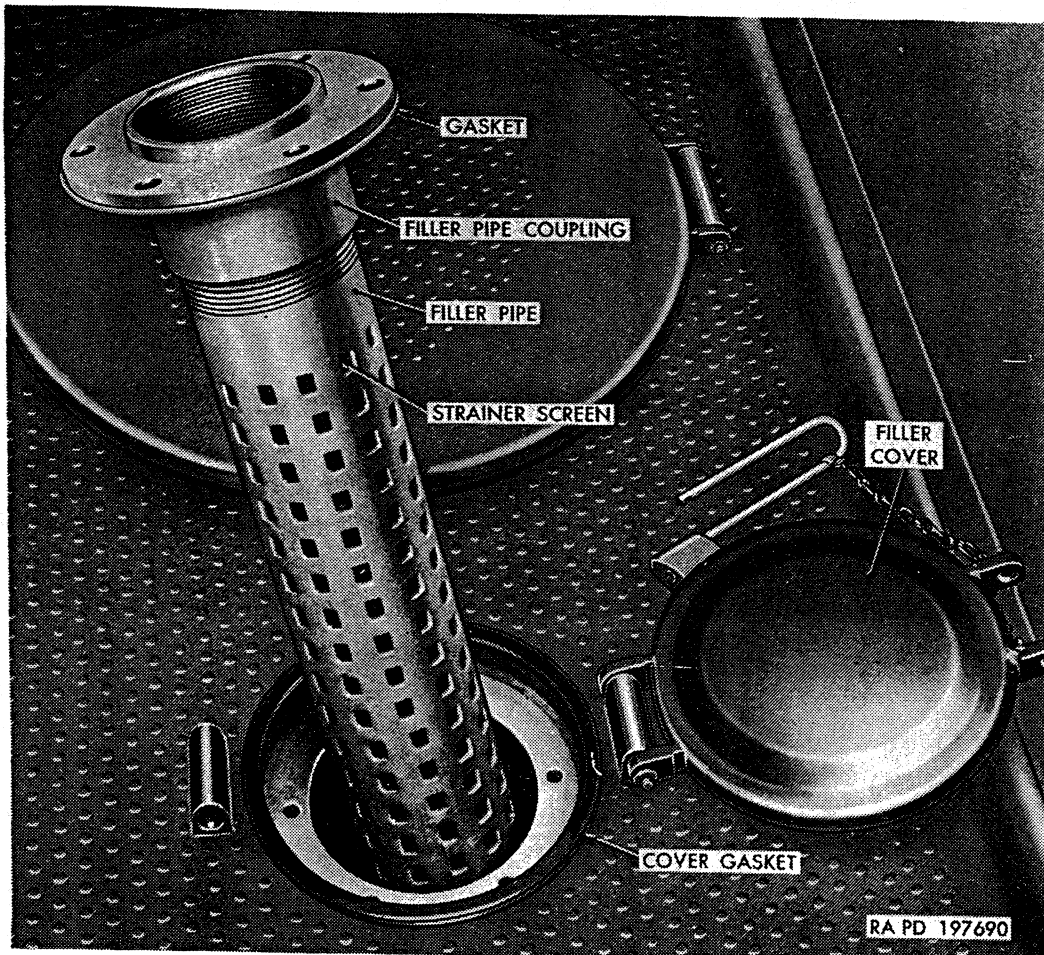

Figure 366. Filler cover, gasket, and filler pipe.

4-inch galvanized pipe with punched openings, lined with 20-mesh gage brass screen. Screen is soldered to inside of pipe. Filler pipe coupling is a 4-inch pipe coupling with mounting flange welded in place. Bottom of pipe is plugged so that all water entering tank compartment must pass through the filler pipe screen. Service operations include cleaning of screen and replacement of filler pipe flange gasket and cover gasket.

b. Filler Pipe Removal.

- (1) Unlock filler cover padlock, remove padlock, and open filler cover.
- (2) Remove six cap screws and lockwashers attaching filler pipe flange to collar in filler opening.
- (3) Use suitable pry bar or tap filler pipe coupling flange with hammer to break the gasket joint. Lift filler pipe straight up out of filler opening.
- (4) Cork gasket will stick to either the filler pipe flange or to collar in filler opening. In either case, remove gasket and thoroughly clean all particles of gasket from mating surfaces, using care not to permit dirt or other foreign material to fall into tank. Discard gasket.

c. Cleaning Filler Pipe Screen. A high pressure water spray applied from outside through openings in filler pipe should loosen foreign particles from inside of screen. Filler pipe must be in inverted position while cleaning to permit loosened particles to wash out. Do not use dry-cleaning solvent or volatile mineral spirits for cleaning screen. If screen is clogged with an accumulation of foreign material or corrosion to the extent that it cannot be cleaned with high pressure water spray, replace the filler pipe assembly.

d. Filler Pipe Installation.

- (1) Place new gasket on collar in filler opening in body, alining holes in gasket with holes in collar.
- (2) Insert end of filler pipe through filler opening and carefully lower pipe into place. Aline holes in filler pipe coupling flange with holes in gasket and collar.
- (3) Attach filler pipe coupling flange to collar with six $\frac{1}{2}$ -13 x $1\frac{1}{4}$ cap screws and $\frac{1}{2}$ -inch lockwashers. Tighten cap screws evenly.
- (4) Examine filler cover gasket. If deteriorated or damaged in any way, replace gasket (*e* below). If gasket is satisfactory, close filler cover and secure with padlock.

e. Cover Gasket Replacement.

- (1) Unlock and remove cover padlock; then open cover.
- (2) Pull rubber gasket off flange around filler opening and discard.

- (3) Make sure gasket mounting surface is clean and that area of cover which contacts gasket is clean and smooth.
- (4) Place new gasket on flange around opening, making sure it is fully seated.
- (5) Close filler cover and secure with padlock.

342. Gate Valves (Suction and Discharge)

(fig. 367)

a. General. Two identical gate valves are used, one on suction side of pump and one on discharge side of pump. Use of gate valves is described in paragraph 53. Gate valve packing gland nut can be tightened or packing can be replaced to correct leakage at valve stem without removing the valve assembly from the vehicle. If replacement of packing does not correct leakage, or if valve becomes inoperative for other reasons, replace gate valve assembly.

b. Valve Stem Packing Replacement.

- (1) Remove nut (E) securing handwheel (F) on valve stem (G) and remove handwheel.

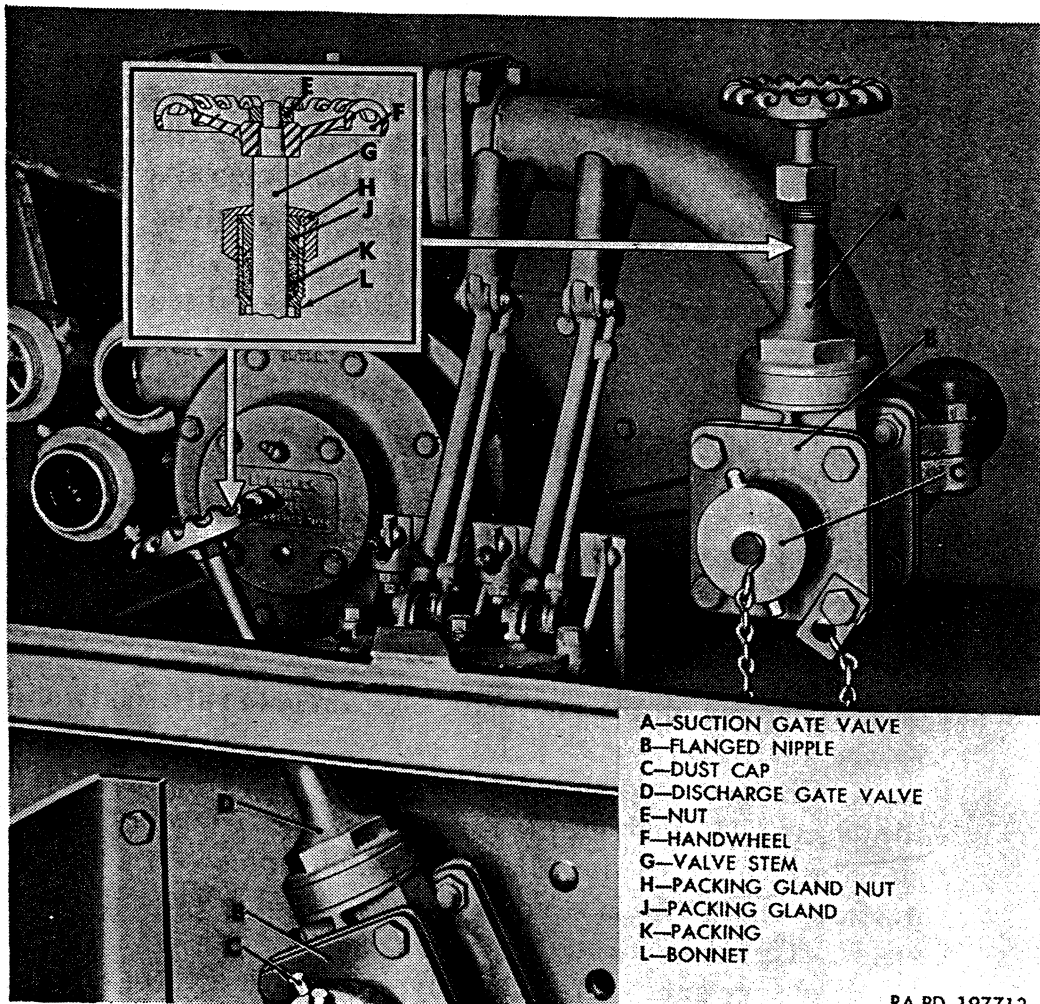

RA PD 197712

Figure 367. Pump discharge and suction gate valves.

- (2) Remove packing gland nut (H) from valve stem (G); then remove packing gland (J). Using a pointed tool, pry packing (K) out of bonnet and remove from valve stem. Discard packing.
- (3) Place new packing (K) over valve stem (G) and press into place with packing gland (J). (If moulded packing is not available, ordinary candlewick or graphited packing such as used by plumbers can be used.)
- (4) With packing (K) and packing gland (J) in place, install packing gland nut (H) over valve stem (G) and thread onto valve bonnet (L). Tighten packing gland nut (H) just enough to prevent leakage.
- (5) Install handwheel (F) on valve stem (G) and secure with nut (E).

c. Gate Valve Removal. The following procedure covers removal of either the suction or discharge gate valve. Valves can be removed while tank contains water providing the drain valve control levers are in closed position (par. 52).

- (1) On discharge gate valve (D) only, remove nut (E) securing handwheel (F) on valve stem (G) and remove handwheel.
- (2) Remove four cap screws and nuts attaching flanged nipple (B) to valve body flange and remove flanged nipple. Cap screw in lower right hole also attaches dust cap chain clip.
- (3) Remove four cap screws and nuts attaching valve body to flange on pump suction or discharge valve pipe. Remove valve body and discard gasket.

d. Gate Valve Installation. When installing a new discharge gate valve (D), handwheel (F) must be removed from valve stem (G) to permit inserting valve stem up through equipment compartment.

- (1) Make sure all particles of old gasket are removed from mating surfaces on valve body flanges, pipe flange, and flanged nipple.
- (2) Position gate valve assembly and new gasket at pump suction or discharge pipe flange and secure with four $\frac{1}{2}$ -20 x $1\frac{1}{2}$ cap screws and $\frac{1}{2}$ -20 safety nuts. Tighten nuts on cap screws to provide a watertight joint.
- (3) Install flanged nipple (B) and gasket on gate valve body and secure with four $\frac{1}{2}$ -20 x $1\frac{1}{2}$ cap screws and $\frac{1}{2}$ -20 safety nuts. Flanged nipple used at suction gate valve is a $2\frac{3}{4}$ -inch nipple, and $1\frac{1}{4}$ -inch nipple is used at discharge valve. Make sure dust cap (C) is installed on flanged nipple (B) and that dust cap chain clip is secured under head of lower right cap screw. Tighten nuts on cap screws.
- (4) On discharge gate valve (D) only, install handwheel (F) on valve stem (G) and secure with nut (E).

343. Drain Valves and Controls

a. General. Drain valve sump with tapped mounting lugs is welded into bottom of each tank compartment. Both drain valves open into a drain pipe which connects to pump suction pipe and gate valve in equipment compartment. Drain valves are controlled by operating levers in equipment compartment (par. 52). Drain valves, drain pipe, and cables are accessible from under vehicle after removing drain pipe cover. Cover is secured to body underframing by three cap screws and nuts at each end. Drain valves, drain pipe, and control cables, as viewed from under vehicle at rear end with drain pipe cover removed, are shown in figure 368. Detailed views of drain valve installed are shown in figures 369 and 371. Drain valve controls installed in equipment compartment are shown in figure 372. Drain valve screen can be serviced, cam shaft packing can be replaced, and plunger spring can be replaced without removing the valve assembly from the vehicle. Tank must be drained (par. 53) before performing the service operations which follow.

b. Servicing Drain Valve Screen (fig. 369). This procedure applies to drain valve screen in either the front or rear compartment.

- (1) Open manhole and heater covers (par. 340b(1), (2), and (3)) to gain access to drain valve screen.
- (2) Lift screen off drain valve. Thoroughly clean screen, using a brush if necessary to remove all foreign material. If cleaning solvent is used to loosen corrosion, wash screen in hot water before installing.
- (3) Place screen over valve. Close heater cover and manhole cover, making sure gaskets are in place and in good condition (par. 340c(3) and (4)).

c. Drain Valve Cam Shaft Packing Replacement (figs. 370 and 371). This procedure applies to either the front or rear tank compartment drain valve.

- (1) Remove three cap screws and nuts at each end of drain pipe cover and pull cover out from under rear of vehicle.
- (2) Remove cotter pin securing cam shaft lever on cam shaft. Remove lever from cam shaft.
- (3) Unscrew cam shaft packing nut from valve body and remove nut from cam shaft. Use pointed or hooked tool to pull packing out from between cam shaft and valve body.
- (4) Wrap asbestos-graphite packing ($\frac{3}{16}$ in. sq x $11\frac{1}{2}$ in. long) around cam shaft and press into body until packing nut can be started. Thread packing nut into valve body and tighten.
- (5) Install cam shaft lever on cam shaft and secure with cotter pin. Operate lever several times; then tighten packing nut. Do not tighten sufficiently to prevent valve closing.

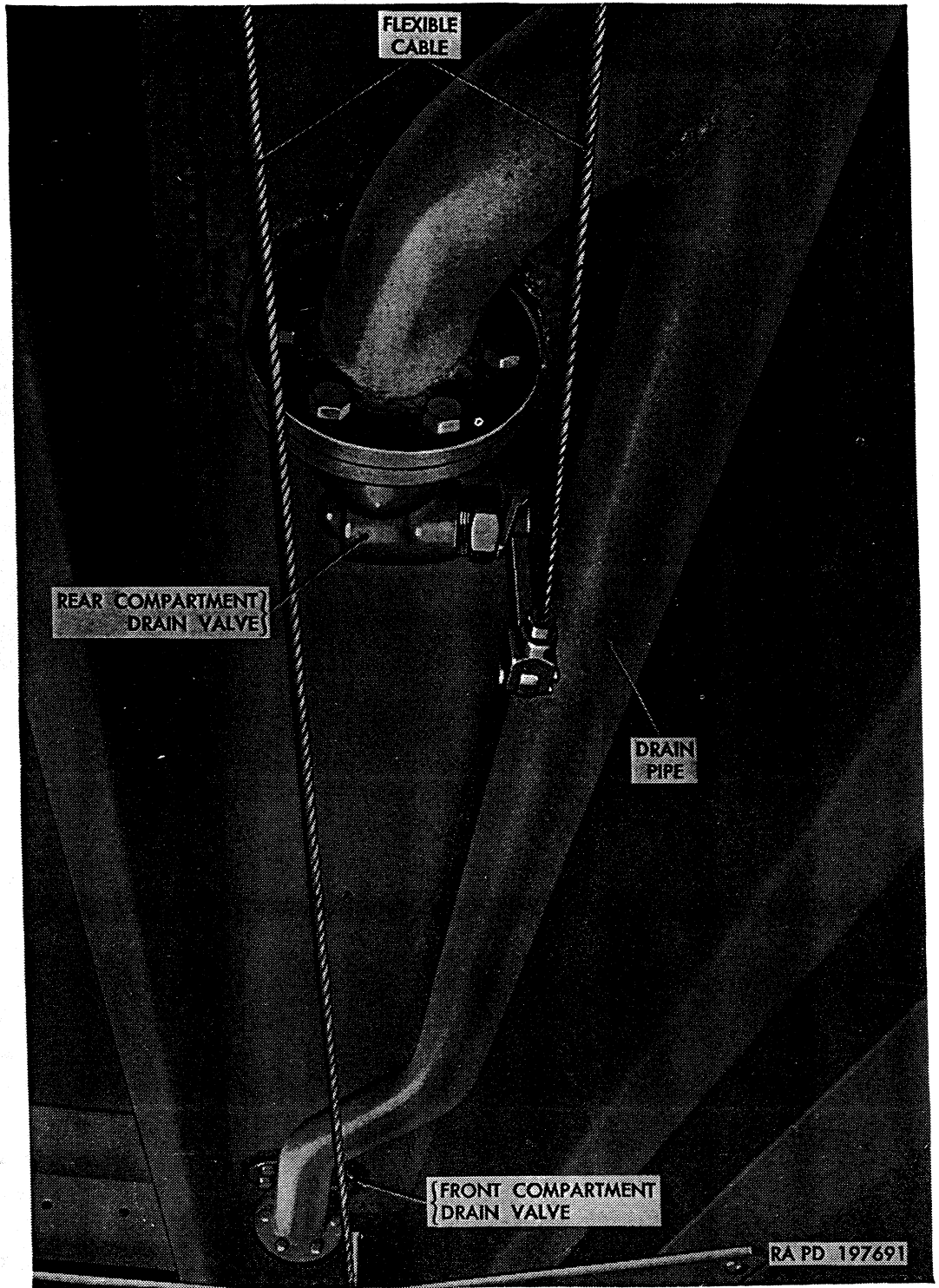

Figure 368. Drain valves and drain pipe installed.

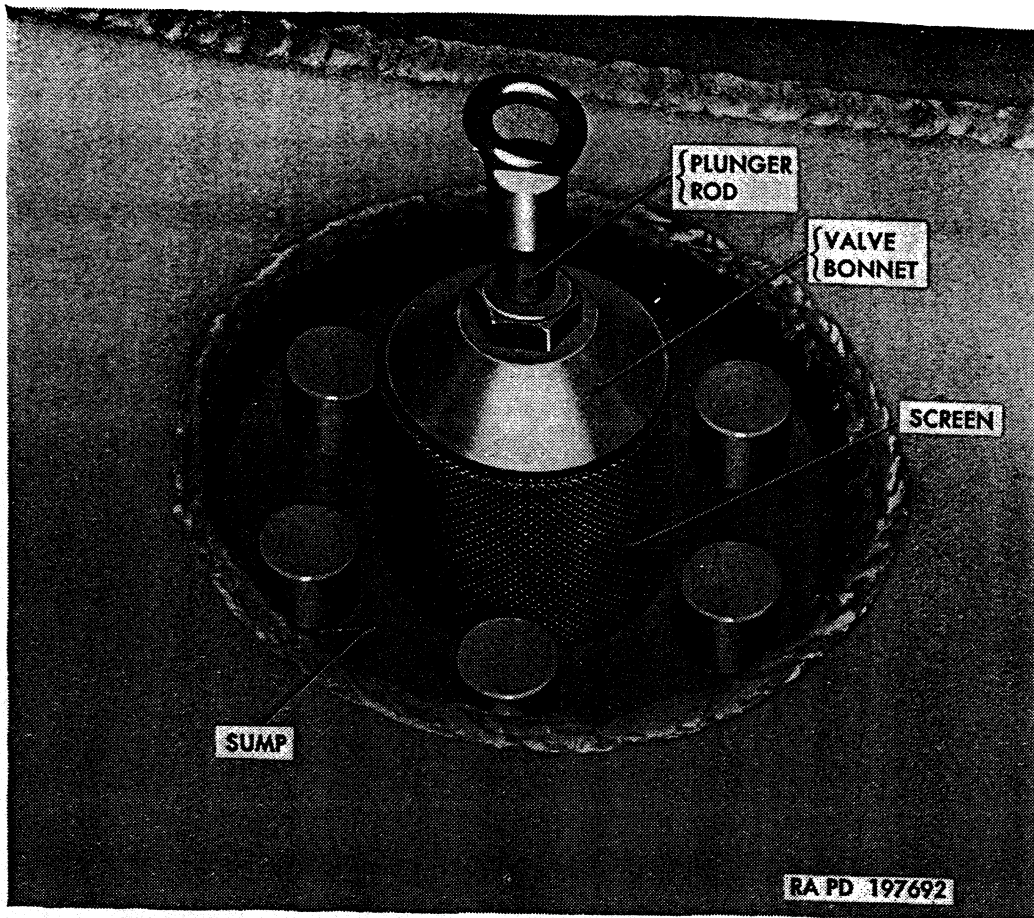

Figure 369. Drain valve screen installed.

- (6) Install drain pipe cover under vehicle and secure in place at each end with three $\frac{1}{4}$ -20 x 1 cap screws and $\frac{1}{4}$ -20 safety nuts.

d. Drain Valve Plunger Spring Replacement (figs. 369 and 370). This procedure applies to either the front or rear tank compartment drain valve.

- (1) Open manhole and heater covers (par. 340b(1), (2), and (3)) to gain access to drain valve.
- (2) Lift screen off drain valve. Unscrew eye from end of plunger rod; hold rod with pipe wrench or pliers while unscrewing eye.
- (3) Using wrench on hex portion of valve bonnet, unscrew bonnet from valve body. Lift bonnet and plunger spring off plunger rod.
- (4) Install new spring over plunger rod, install bonnet over plunger rod, and thread bonnet into valve body. Tighten bonnet.
- (5) Thread eye onto end of plunger rod and tighten. Clean drain valve screen (b(2) above); then place screen over valve.
- (6) Close heater cover and manhole cover (par. 340c(3) and (4)).

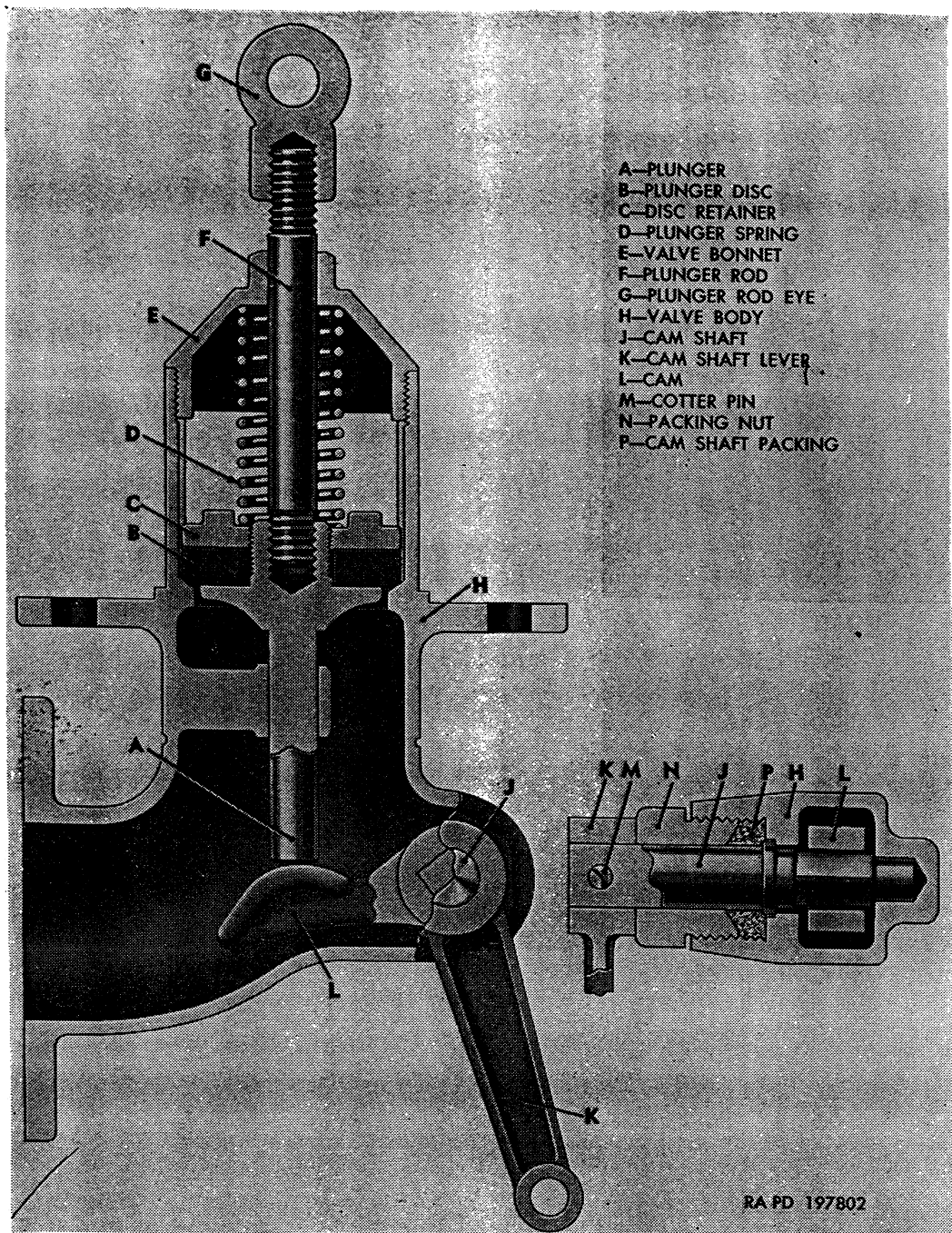

Figure 370. Water tank drain valve.

e. *Drain Valve Assembly Replacement* (fig. 371). This procedure applies to either the front or rear tank compartment drain valve.

- (1) Remove three cap screws and nuts at each end of drain pipe cover and pull cover out from under rear of vehicle. Remove cotter pin and clevis pin attaching cable yoke to cam shaft lever.
- (2) Remove six nuts and cap screws attaching drain pipe flange to drain valve flange.
- (3) Remove six self-locking bolts attaching drain valve to tank sump. Break the gasket joints with a screwdriver; then re-

- move valve assembly. Remove plunger rod eye and screen for installation on replacement unit.
- (4) Make sure mating surfaces of valve body, drain pipe flange, and tank sump are clean. Coat both sides of new gaskets with gasket cement and position gaskets on drain pipe flange and on tank sump.
 - (5) Place screen over valve and install eye on plunger rod. Position valve assembly at sump and drain pipe, being careful not to dislodge gaskets. Attach valve body to sump with six $\frac{3}{8}$ -16 x 1 self-locking bolts. Attach drain pipe flange to valve body with six $\frac{3}{8}$ -24 x $1\frac{1}{4}$ cap screw and $\frac{3}{8}$ -24 safety nuts. Tighten all bolts and nuts.
 - (6) Connect cable yoke to cam shaft lever with clevis pin and cotter pin.
 - (7) Install drain pipe cover under vehicle and secure in place at each end with three $\frac{1}{4}$ -20 x 1 cap screws and $\frac{1}{4}$ -20 safety nuts.

f. Drain Valve Control Cable Replacement (figs. 371 and 372). This procedure applies to either the front or rear tank compartment drain valve control cable. Cable to front compartment drain valve is 96 inches long, and cable to rear compartment drain valve is 36 inches long.

- (1) Remove three cap screws and nuts at each end of drain pipe cover and pull cover out from under rear of vehicle to gain access to cable connection at drain valve.
- (2) To disconnect cable at drain valve cam shaft lever, unscrew ferrule from cable yoke; then pull cable and inserts out of

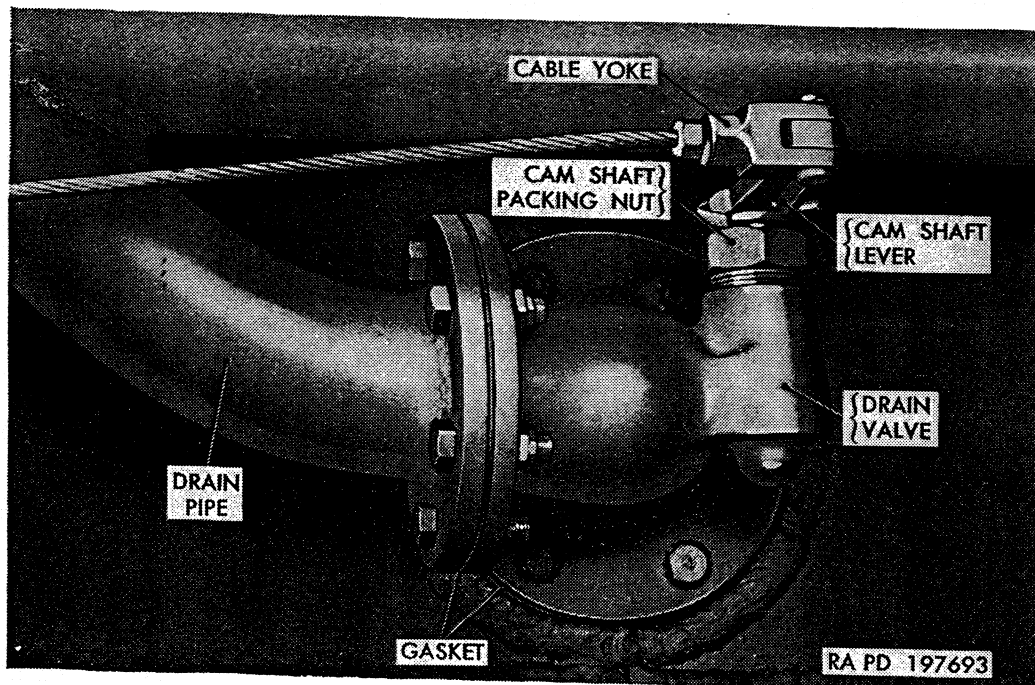

Figure 371. Drain valve and cable (rear shown).

yoke. Remove inserts and ferrule from cable for installation on replacement cable.

- (3) In equipment compartment, loosen nut on drain valve cable locking screw in operating lever; then pull cable end out of screw. Pull cable out of guide in control lever shaft bracket spacer; then withdraw cable from under vehicle.
- (4) Thread one end of new cable through cable guides in control lever shaft bracket spacer and in tank rear support member.
- (5) At drain valve end of cable, place ferrule over cable; then place inserts on cable with end of cable flush with tapered ends of inserts. Place inserts and cable end into cable yoke; then thread ferrule into yoke over the inserts and tighten. As ferrule is tightened into yoke, tapered inner diameter of ferrule forces tapered inserts, together, causing threads in inserts to bite into cable.
- (6) In equipment compartment, thread end of cable through cable locking screw in operating lever. Provide for slight slack in cable with operating lever in forward (valve closed) position; then tighten nut on cable locking screw.
- (7) Install drain pipe cover under vehicle and secure in place at each end with three $\frac{1}{4}$ -20 x 1 cap screws and $\frac{1}{4}$ -20 safety nuts.

g. Drain Valve Operator Assembly Replacement (fig. 372). Drain valve operator comprises the drain valve control levers together with their mounting brackets, shafts, bearings, etc., as a unit assembly.

- (1) Loosen nuts on drain valve cable locking screws. Withdraw cable ends from locking screws and from cable guides in bracket spacer.
- (2) Remove six cap screws and nuts attaching control lever shaft brackets to bottom of equipment compartment. Lift operator assembly out of compartment.
- (3) Position new or rebuild operator assembly on equipment compartment floor and secure with six $\frac{1}{4}$ -20 x $\frac{3}{4}$ cap screws and $\frac{1}{4}$ -20 safety nuts. Tighten nuts.
- (4) Thread ends of cables through cable guides in bracket spacer and through holes in cable locking screws. Provide for slight slack in cables and operating levers in forward (valves closed) position; then tighten nuts on cable locking screws.

344. Water Tank Body Pump

a. Description. Water pump is a rotary-type pump, mounted in equipment compartment at rear end of tank body. The direction of water flow through the pump is through the strainer into the top of the pump and out the bottom of the pump. Suction side of pump is

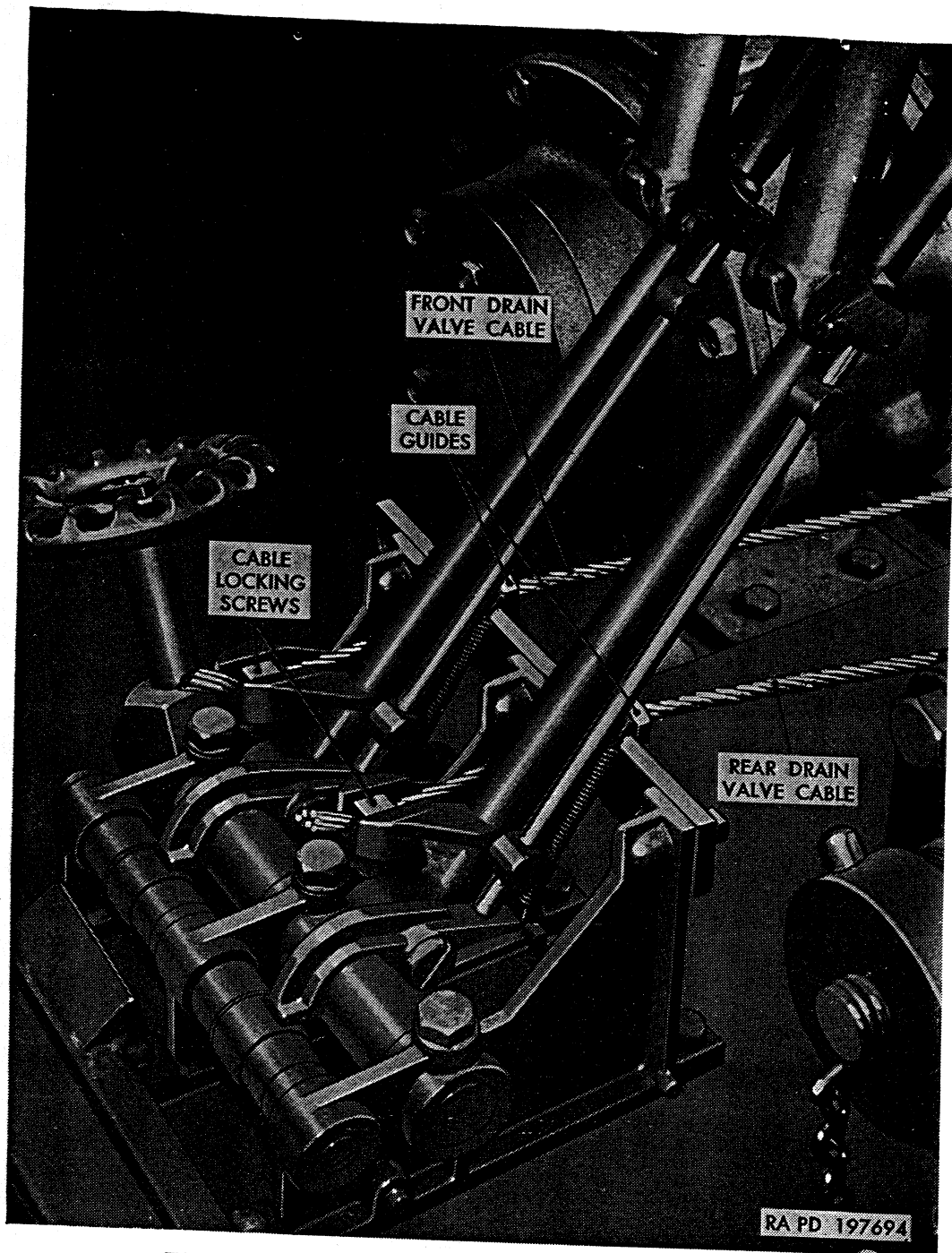

Figure 372. Drain valve operator assembly installed.

connected to drain pipe and to suction gate valve. Pump discharge is connected to discharge gate valve. Water pump is driven by propeller shafts from the accessory drive unit on power-take-off, and is controlled from the driver's compartment; however, operation of pump gate valves and tank drain valve controls must be accomplished at rear of vehicle. Pressure relief valve in pump prevents damage from excessive pressure buildup when pump is operated with discharge gate valve closed. Refer to paragraphs 52 and 53 for description and operation of water pump controls.

b. *Pump Strainer Service* (fig. 373).

- (1) Remove four cap screws and external-teeth lockwashers attaching strainer body end cover to strainer body. Remove end cover and gasket; then withdraw strainer screen from strainer body. Discard gasket.
- (2) Thoroughly clean screen, using a brush if necessary to remove all foreign material. If cleaning solvent is used to loosen dirt or corrosion, wash off all traces of cleaning fluid with hot water. Make sure all particles of gasket are removed from end cover and from strainer body flange.
- (3) Insert strainer screen into strainer body, open end first. Coat both sides of new end cover gasket with gasket cement and place gasket on strainer body flange. Position strainer body end cover against body flange, with centering bar on strainer in place in depression in end cover. Attach cover to strainer body with four $\frac{1}{2}$ -13 x 1 cap screws and $\frac{1}{2}$ -inch external-teeth lockwashers.

c. *Removal.*

- (1) Remove four cap screws and external-teeth lockwashers attaching pump suction pipe flange to strainer body.
- (2) From under vehicle, remove four cap screws and external-teeth lockwashers attaching discharge flange to bottom of pump body.
- (3) From under vehicle, remove nuts from four cap screws attaching pump body to channel in bottom of equipment com-

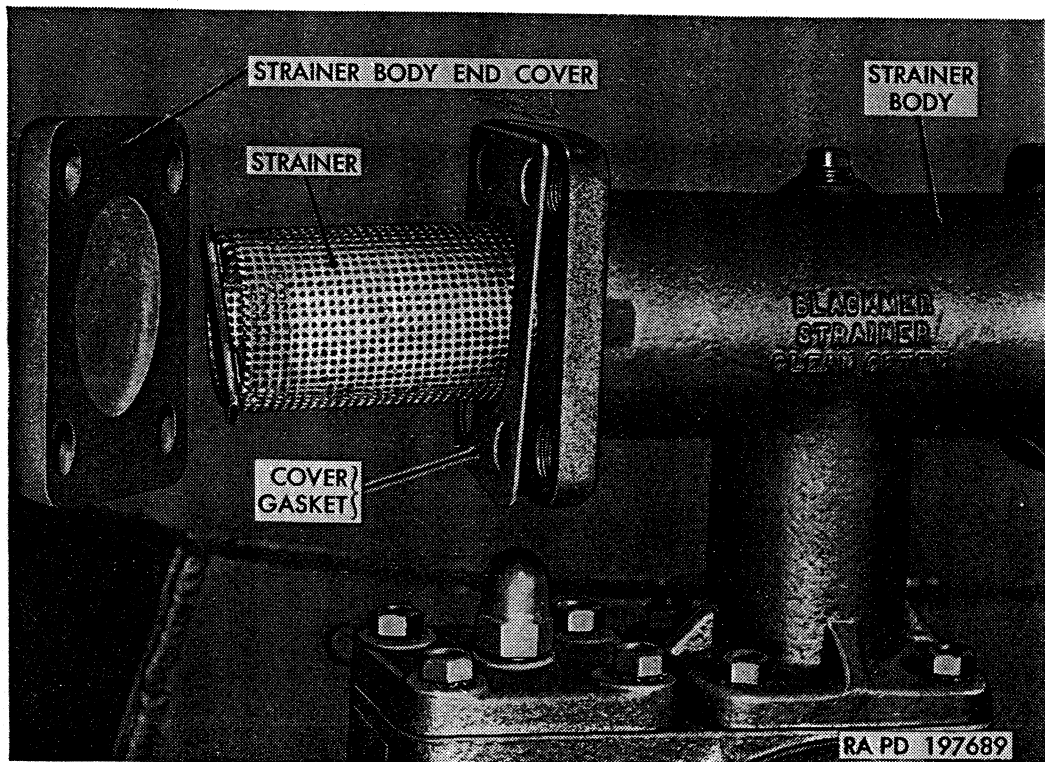

Figure 373. Water tank pump strainer.

- partment. Remove cap screws from body mounting flange.
- (4) Loosen hex-socket setscrew securing universal joint yoke on pump rotor shaft.
 - (5) Use a flat blade screwdriver or chisel to break the gasket joint between suction pipe and strainer body, and between discharge pipe flange and pump body. Also, tap universal joint yoke toward end of rotor shaft; drive shaft slip joint permits universal joint to move forward.
 - (6) With all points disconnected and the joints broken, lift pump up and rearward out of equipment compartment.
 - (7) Remove four cap screws and external-teeth lockwashers attaching pump strainer body to pump body, then remove strainer body and strainer assembly for installation on replacement unit.

d. Installation

- (1) Clean all particles of old gasket or gasket cement off flanges of suction pipe, discharge pipe, and strainer body. Service strainer (*b* above). Tap $\frac{1}{4}$ x 1 woodruff key into keyseat in pump rotor shaft. Note position of keyway in universal joint yoke; then turn rotor shaft so key will engage keyway when pump is moved into place.
- (2) Place new or rebuilt pump assembly on mounting channel in equipment compartment, at the same time guiding pump rotor shaft into universal joint yoke. Insert four $\frac{3}{8}$ -24 x 1 cap screws through pump body mounting flange and mounting channel. Install $\frac{3}{8}$ -24 safety nut on each cap screw, but do not tighten until suction and discharge pipes have been connected.
- (3) Using new gasket coated with gasket cement between discharge flange and pump body, connect discharge flange to pump body with four $\frac{3}{8}$ -16 x $1\frac{1}{4}$ cap screws and $\frac{1}{2}$ -inch external-teeth lockwashers. Tighten cap screws.
- (4) Make sure universal joint yoke is fully in place on pump rotor shaft; then secure in place by tightening hex-socket setscrew.
- (5) Coat new strainer-body-to-pump and strainer-body-to-suction-pipe gaskets with gasket cement. Place one gasket on top of pump body and the other on the suction pipe flange; gasket cement will hold gasket in place on the suction pipe flange.
- (6) Position strainer body on top of pump and against suction pipe flange. Attach strainer body to pump with four $\frac{3}{8}$ -16 x 1 cap screws and $\frac{1}{2}$ -inch external-teeth lockwashers. Attach suction pipe flange to strainer body with four $\frac{1}{2}$ -13 x 1 cap screws and $\frac{1}{2}$ -inch external-teeth lockwashers. Tighten all cap screws.

- (7) Make sure pump is properly positioned so that discharge pipe does not contact edge of hole through frame rear cross member; then tighten nuts on cap screws attaching pump body to mounting channel.

345. Water Tank Pump Propeller Shafts

a. General. Power to drive the water tank pump is supplied from the vehicle engine through the power-take-off accessory drive unit and a drive line. The drive line consists of two identical propeller shaft and universal joint assemblies, a solid center shaft, and two pillow block (center bearing) assemblies. The center shaft is supported from the under side of the body framing by the two pillow blocks, one at each end. Each propeller shaft is a tubular-type shaft with a fixed universal joint yoke welded to one end and a splined stub shaft welded to the other end. Each shaft assembly incorporates a fixed yoke-type universal joint at forward end and a slip yoke-type universal joint at rear end. Propeller shaft universal joint yokes are attached to accessory drive output shaft, front and rear ends of center propeller shaft, and at water pump rotor shaft by a woodruff key and a hex-socket setscrew. Lubrication fittings are provided at each universal joint journal, slip yoke, and pillow block.

b. Front Propeller Shaft Removal (fig. 374).

- (1) Loosen hex-socket setscrew (B) securing universal joint yoke on power-take-off accessory drive shaft (A). Loosen hex-socket setscrew (B) securing universal joint yoke on forward end of center propeller shaft (D).
- (2) Push yoke onto power-take-off accessory drive shaft (A) as far as possible to permit removing yoke from center propeller shaft (D) at other end. Move universal joint yoke forward off end of center propeller shaft, telescoping shaft at slip joint.

c. Front Propeller Shaft Installation (fig. 374).

- (1) Make sure woodruff key is in place in accessory drive shaft end in front end of center propeller shaft.
- (2) Position propeller shaft assembly under vehicle with slip joint end toward rear. Place front universal joint yoke on accessory drive shaft and push onto shaft as far as possible. Telescope shaft at slip joint and place universal joint yoke on forward end of center propeller shaft. Make sure woodruff keys have not been dislodged at either end.
- (3) At power-take-off, position yoke on shaft so that setscrew indexes with milled flat on shaft; then tighten setscrew. Position rear universal joint yoke on front end of center propeller shaft so that yoke completely covers the woodruff key; then tighten yoke setscrew.

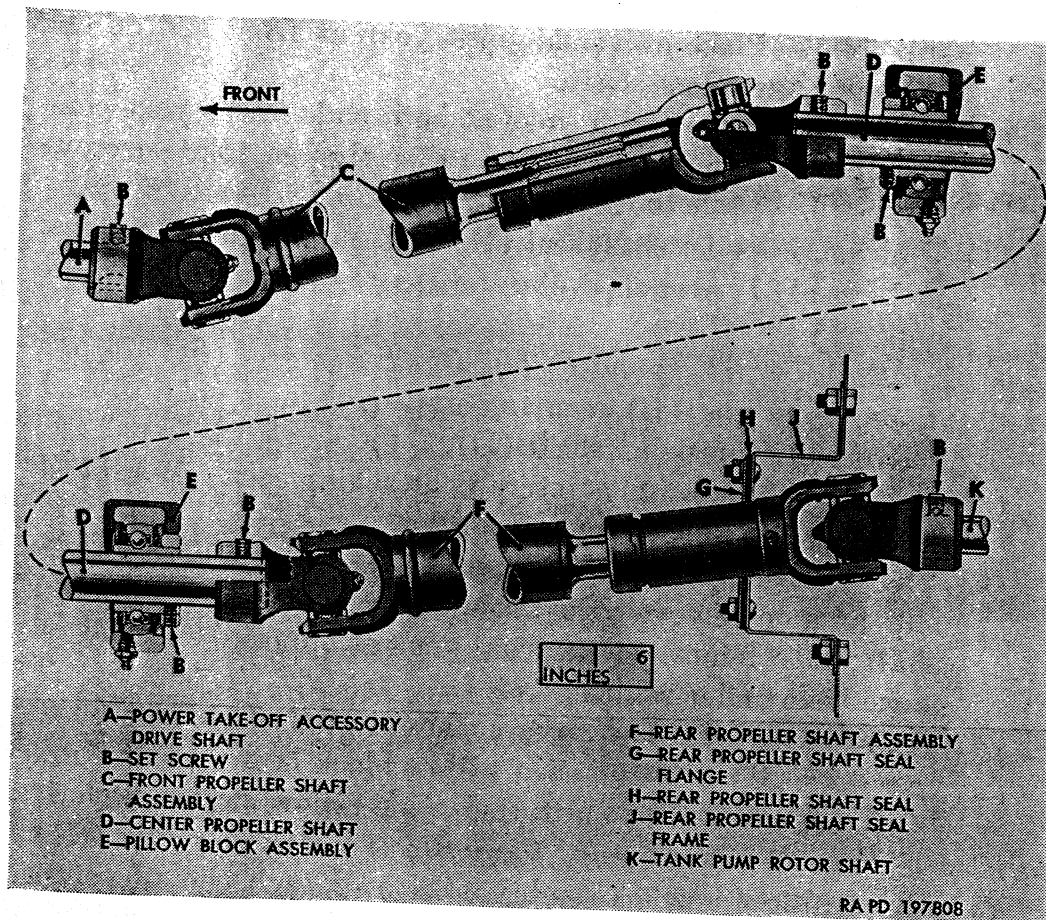

Figure 374. Water tank pump propeller shafts.

d. *Rear Propeller Shaft Removal* (fig. 374).

- (1) At rear end of shaft, remove four screws and nuts attaching propeller shaft seal flange (G) and seal (H) to seal frame (J).
- (2) At forward end of shaft, loosen setscrew (B) securing universal joint yoke on rear end of center propeller shaft (D). Push yoke onto center shaft as far as possible.
- (3) At rear end of shaft, loosen setscrew (B) securing universal joint on pump rotor shaft (K). Move universal joint yoke forward off pump rotor shaft, telescoping propeller shaft at slip joint. Move propeller shaft forward to complete removal, withdrawing rear universal joint assembly from seal frame.

e. *Rear Propeller Shaft Installation* (fig. 374).

- (1) Make sure woodruff key is in place in rear end of center shaft and in pump rotor shaft (K). Place seal flange (G) and seal (H) over slip joint end of shaft.
- (2) Position propeller shaft assembly under vehicle, with universal joint at slip joint end inserted through seal frame (J) and with universal joint yoke in place on pump rotor shaft (K). Push universal joint yoke onto rotor shaft as far as

possible, and make shaft short as possible by telescoping at slip joint. Place universal joint yoke at front end on end of center propeller shaft.

- (3) Position universal joint yoke at both ends so the yoke completely covers the woodruff key; then tighten yoke setscrews (B).
- (4) Position propeller shaft seal (H) and seal flange (G) against seal frame (J) over slip yoke and secure with four screws and nuts.

f. Center Propeller Shaft and Pillow Block Removal (fig. 374).

- (1) Loosen setscrew (B) securing universal joint yoke to each end of center propeller shaft (D).
- (2) Remove two nuts and cap screws attaching each pillow block assembly (E) to body underframing.
- (3) Shorten front and rear propeller shafts by telescoping at slip joint to remove yoke from one end of center propeller shaft; then remove shaft from yoke at opposite end and remove from under vehicle.
- (4) Remove woodruff key from each end of shaft. Loosen two setscrews (B) securing each pillow block bearing collar and bearing inner race to shaft, then slide pillow blocks off shaft.

g. Center Propeller Shaft and Pillow Block Installation (fig. 374).

- (1) Place pillow block assembly (E) over each end of center shaft, but do not tighten setscrews (B) in bearing collar at this time. Tap woodruff key into keyseat in each end of shaft.
- (2) Position shaft and pillow blocks under vehicle and install front and rear propeller shaft yokes on ends of shaft, being careful not to dislodge woodruff keys. Do not tighten setscrews in yokes at this time.
- (3) Attach each pillow block to body underframing with two $\frac{1}{2}$ -20 x 2 cap screws and $\frac{1}{2}$ -20 safety nuts. Tighten nuts.
- (4) Position universal joint yokes on ends of shafts so the yokes completely cover the woodruff keys; then tighten setscrews (B) in yokes.
- (5) Position center shaft in pillow blocks to provide $4\frac{5}{16}$ inches from center of pillow block bracket to center of universal joint yoke; then tighten two setscrews in each pillow block bearing collar. This locks the bearing inner race to the propeller shaft.

h. Propeller Shaft and Universal Joint Repair.

Note. The key letters in parentheses are in figure 375, except where otherwise indicated.

The procedures which follow cover disassembly, cleaning and inspection, and assembly of either propeller shaft and universal joint assembly after it has been removed from the vehicle as in *b* above, or disassembly of universal joint and slip joint end.

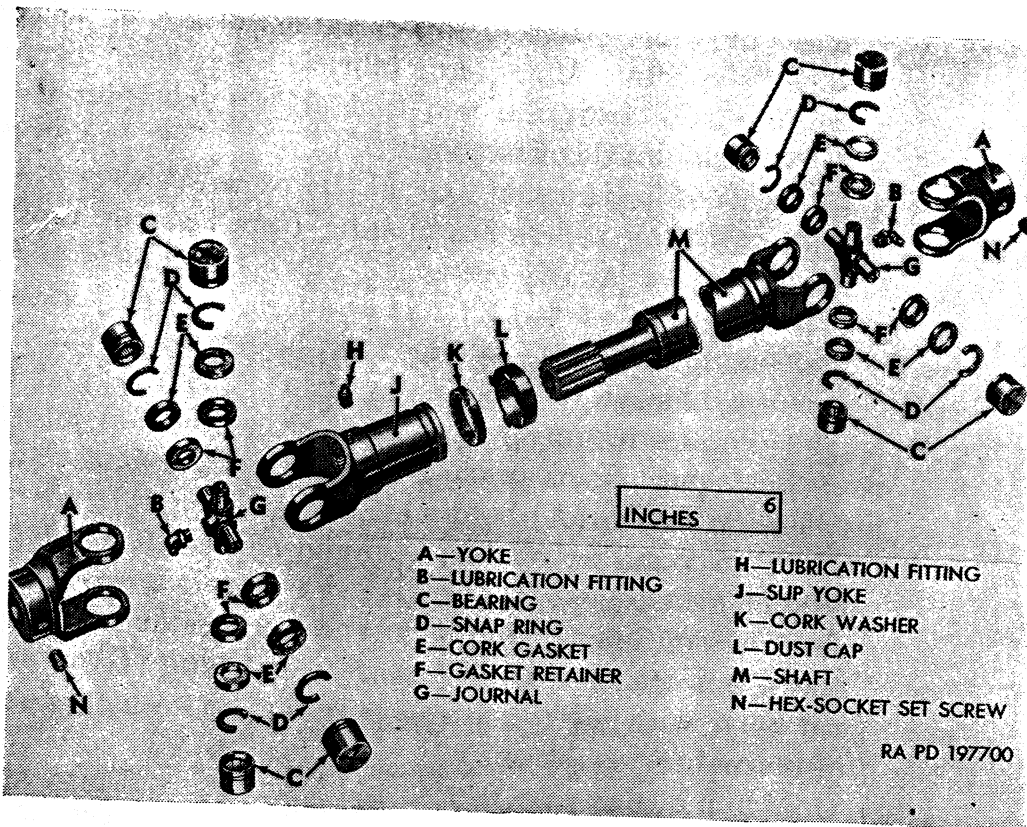

Figure 375. Propeller shaft and universal joint components.

- (1) *Disassembly.*
 - (a) Before disassembling propeller shaft assembly, check for alignment arrows on slip yoke and splined stub shaft. If arrows are not readily visible, scratch arrows on parts.
 - (b) Bend tangs of dust cap (L) out of groove in slip yoke (J). Pull slip yoke (J) off stub shaft; then remove cork washer (K) and dust cap (L) from stub shaft.
 - (c) Clamp one yoke of universal joint in vise. Remove four snap rings (D) securing roller bearings (C) in yokes.
 - (d) Remove lubrication fitting (B) from journal (G).
 - (e) With one yoke supported in vise, strike other yoke with hammer to force one bearing out of yoke. Turn over and strike in opposite direction to force out opposite bearing. (This procedure is the same as illustrated for winch propeller shaft in fig. 342.) Remove yoke from which bearing has been removed from journal.
 - (f) Support free ends of journal (fig. 342) on vise jaws and strike yoke with hammer to remove one bearing; then turn over and drive out opposite bearing.
 - (g) Remove journal from yoke; then remove cork gaskets (E) and gasket retainers (F) from journal.
- (2) *Cleaning and inspection.*
 - (a) Discard cork gaskets (E), retainers (F), snap rings (D), and cork washer (K) and obtain new parts for assembly.

Wash all other parts in dry-cleaning solvent or volatile mineral spirits. Make sure lubricant passages through journals (G) are open, and that all old lubricant is removed from inside of bearings (C).

- (b) Check fit of bearings on journal. If excessive wear is evident, or if any rollers are missing from bearing, replace with new journal and bearings. Make sure slip yoke (J) slides freely on shaft (M). If backlash between yoke and shaft splines exceeds 0.005 inch, replace worn parts.
- (3) *Assembly.* Assembly of universal joint ((a) (b), and (c) below), applies to universal joint at either the slip joint or fixed joint end. Pack bearing rollers with automotive and artillery grease (GAA) before installing.
 - (a) Install new gasket retainer (F) and new cork gasket (E) on each arm of journal (G). Push retainers down against shoulders on journal and make sure cork gaskets are fully seated in retainers. Install lubrication fitting (B) in journal (G), with end of fitting pointing between two arms of journal for accessibility.
 - (b) Grip hub of one yoke in vise and insert journal into yoke. Start one bearing (C) into each side of yoke, guiding ends of journal into bearings. Drive bearings in until snap ring grooves in bearings are fully exposed at inside of yoke; then install new snap rings (D), making sure they are fully seated.
 - (c) Position other yoke in vise, insert free ends of journal into yoke, then install bearings and snap rings as in (b) above.
 - (d) Install dust cap (L) over splined stub shaft and place new cork washer (K) in retainer. Place slip yoke on splined shaft with arrows aligned, place dust cap and cork washer against end of yoke, and bend tangs of cap into groove in yoke.

346. Power-Take-Off Accessory Drive Control Linkage (fig. 376)

a. General. Power-take-off accessory drive control lever in cab is connected to accessory drive shift shaft by two rods and an idler lever. Linkage adjustment is provided by an adjustable yoke at lower end of control-lever-to-idler-lever rod. Operation of control lever is explained in paragraph 53.

b. Adjustment.

- (1) This adjustment normally should not be required except when a part of the linkage has been disconnected or replaced or when accessory drive unit has been replaced.
- (2) Yoke at lower end of control-lever-to-idler-lever rod has an elongated clevis pin hole. With accessory drive shift shaft pushed in (rearward) to neutral position, with control lever

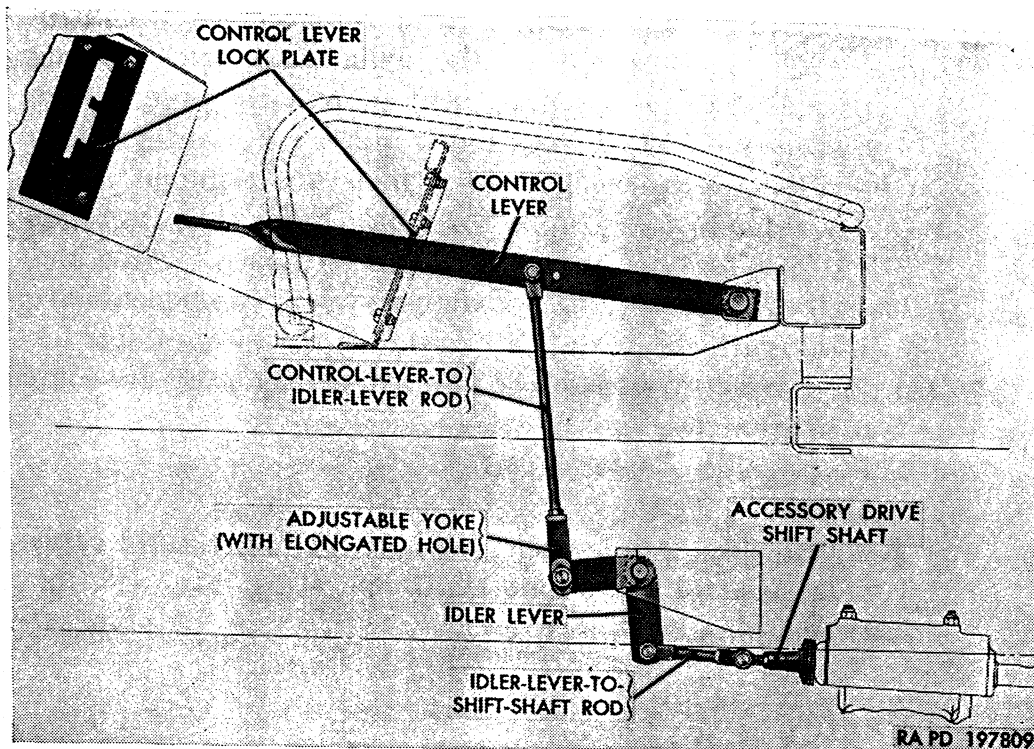

Figure 376. Power-take-off accessory drive control linkage.

resting in lower guide slot in control lever lock plate, and with all linkage connected, position yoke on rod so that clevis pin, when installed, will be centered in elongated hole in yoke. Tighten locknut against yoke after correct adjustment is obtained.

c. Replacement. All linkage connections, and control and idler lever mountings consist of clevis pins and cotter pins. Any part of the linkage can be removed by removing the connecting cotter pins and clevis pins. Whenever linkage has been disconnected or replaced, adjust after installation (*b* above).

347. Water Tank Exhaust Heater System

a. General.

- (1) Water tank exhaust heater system is connected to the engine exhaust system at the exhaust control valve. Control valve is controlled by a flexible cable from the driver's compartment. With handle in driver's compartment pushed in, gate in control valve seals the outlet to the water tank, and exhaust gases are directed through the muffler and tail pipe as in a conventional exhaust system. With handle pulled out, gate in control valve seals outlet to muffler and directs exhaust gases into the pipe leading to water tank heating chamber. After passing through tank heating chamber, the exhaust gases are expelled through an exhaust opening in tank body underframing at left rear corner.

(2) Procedures in this paragraph cover replacement of control valve cable, replacement of the exhaust pipe connecting clamps and seals, and replacement of exhaust pipes which are used only on water tank truck M222. For information on exhaust system components which are common to all vehicles, refer to paragraphs 137-140. Refer to paragraphs 348 and 349 for information on exhaust control valve and exhaust heater gate valve. Exhaust system components are shown in figure 377, with parts used only on water tank truck M222 indicated by an asterisk (*). All other parts are common to all vehicles.

b. Control Valve Cable Replacement.

(1) Removal.

(a) Remove cotter pin and clevis pin attaching control cable yoke to control valve gate shaft operating lever (G, fig. 379).

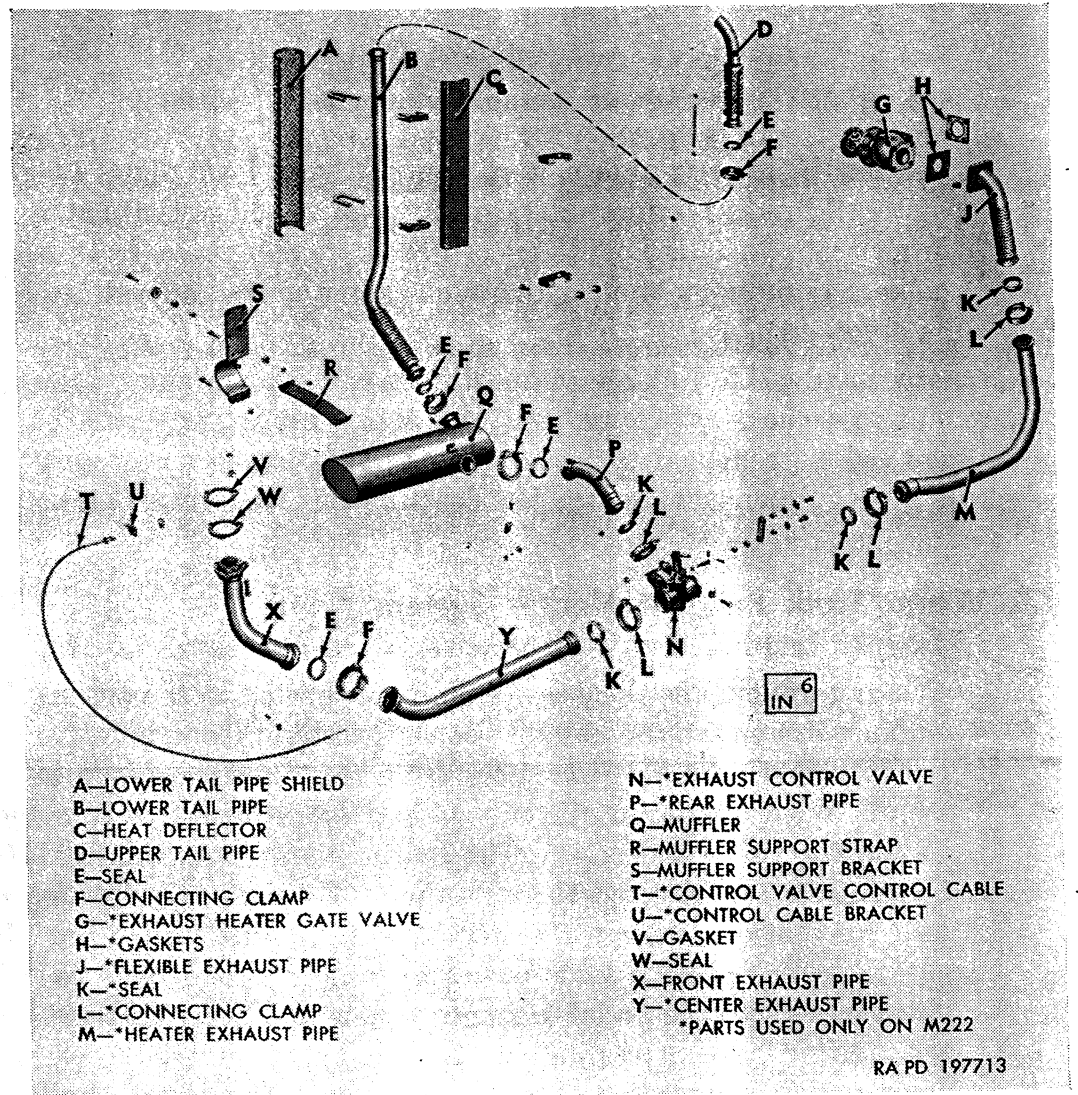

Figure 377. Water tank truck M222 exhaust system components.

- (b) Loosen cable yoke locknut and remove yoke from cable; then remove locknut from cable.
 - (c) Remove cap screws attaching control cable clips at control valve support bracket, at brake master cylinder, and at engine side of dash; then remove clips from cable.
 - (d) In driver's compartment, unscrew nut securing control cable end in bracket on instrument panel; then withdraw control cable from bracket. Remove retaining nut and lockwasher and instruction plate from cable as cable is removed.
- (2) *Installation.*
- (a) Place instruction plate over cable; then insert end of cable through bracket at instrument panel. Place lockwasher and retaining nut on cable, then insert end of cable through dash and guide end of cable down and rearward to exhaust control valve. Thread retaining nut onto cable housing at bracket and position cable handle and nameplate at bracket; then tighten retaining nut.
 - (b) Thread locknut and yoke onto end of cable. With cable handle pushed all the way in and with control valve gate shaft operating lever turned rearward to the limit of its travel, adjust yoke on cable to permit free installation of clevis pin. Install clevis pin and secure with cotter pin. Tighten locknut against yoke.
 - (c) Install three clips on cable housing and attach to control valve support bracket, brake master cylinder, and at engine side of dash.

c. Exhaust Pipe Replacement.

Note. The key letters noted in parentheses are in figure 377, except where otherwise indicated.

- (1) *Removal.* To remove either the heater exhaust pipe (M), rear exhaust pipe (P), or center exhaust pipe (Y), remove connecting clamps (F and L) at both ends of pipe. To remove clamp, loosen clamp bolt nut enough to permit disengaging hinged anchor from end of clamp bolt (fig. 378); then spread clamp enough to remove from joint and slide onto pipe. Work each end of pipe loose from its attaching part and remove from under vehicle. To remove flexible exhaust pipe (J), remove connecting clamp (L); then remove four cap screws and nuts securing pipe flange to gate valve. Remove pipe and gasket (H). Discard gasket. Examine clamp seals (E and K); if damaged to the extent that leakage will occur, discard seals and obtain new seals for installation.

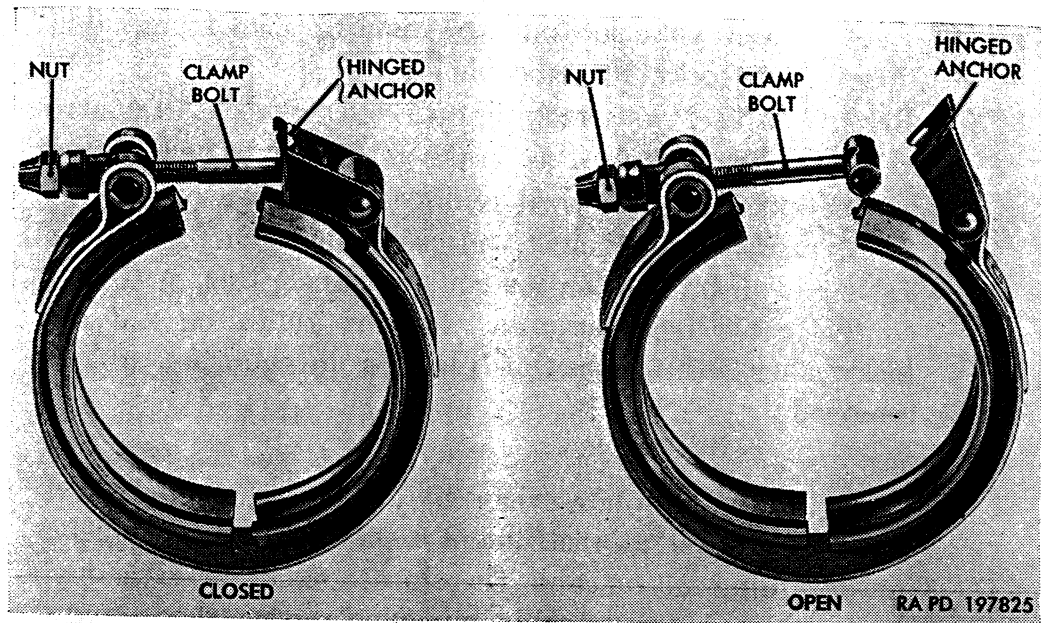

Figure 378. Exhaust pipe connecting clamp.

(2) *Installation.* Place clamp seals (E and K) on ends of pipe and place connecting clamps (F and L) over pipe; then position pipe under vehicle. Work each end of pipe into its connecting part until clamping flanges are close enough together to engage groove in connecting clamp. Position clamp over each joint, making sure it engages both clamping flanges. Squeeze clamp together and swing hinged anchor over end of bolt. Tighten clamp bolt enough to prevent leakage. When installing flexible exhaust pipe (J), use new gasket (H) between pipe flange and gate valve. Connect flexible pipe to heater exhaust pipe (M) with seal (K) and connecting clamp (L). Attach pipe flange to gate valve with four $\frac{1}{2}$ -20 x $1\frac{1}{2}$ cap screws and $\frac{1}{2}$ -20 safety nuts. Tighten nuts.

d. Exhaust Pipe Connecting Clamp and Seal Replacement. In order to replace connecting clamp and seal at either end of any exhaust pipe, it is necessary to completely remove the exhaust pipe (c(1) above).

348. Exhaust Control Valve

a. General. Exhaust control valve is a lever-operated gate-type valve having one inlet and two outlets. Valve is connected into engine exhaust system as shown in figure 379, and is supported from the transmission rear support member by a support strap and support bracket. Inlet side of valve is connected to exhaust pipe from engine exhaust manifold. One outlet opening is connected to rear exhaust pipe leading to exhaust muffler; the other outlet is connected to pipe leading to water tank heating chamber. The valve gate, integral with shaft,

closes one outlet and directs the exhaust gases out the other outlet as controlled by handle in driver's compartment. Operation of water tank exhaust heater system is explained in paragraph 53e.

b. *Removal* (fig. 379).

- (1) Remove center exhaust pipe (M) (par. 347c(1)).
- (2) Open connecting clamps (J) attaching rear exhaust pipe (H) and heater exhaust pipe (K) to exhaust control valve (L), and slide clamps into pipes.
- (3) Remove cotter pin and clevis pin attaching cable yoke (F) to control valve gate shaft operating lever (G). Remove cap screw attaching cable clip (B) to control valve support bracket (C).
- (4) Remove nut, cap screw, plain washer, and spacer securing control valve support strap (D) to support bracket (C).
- (5) Work control valve assembly loose from rear exhaust pipe

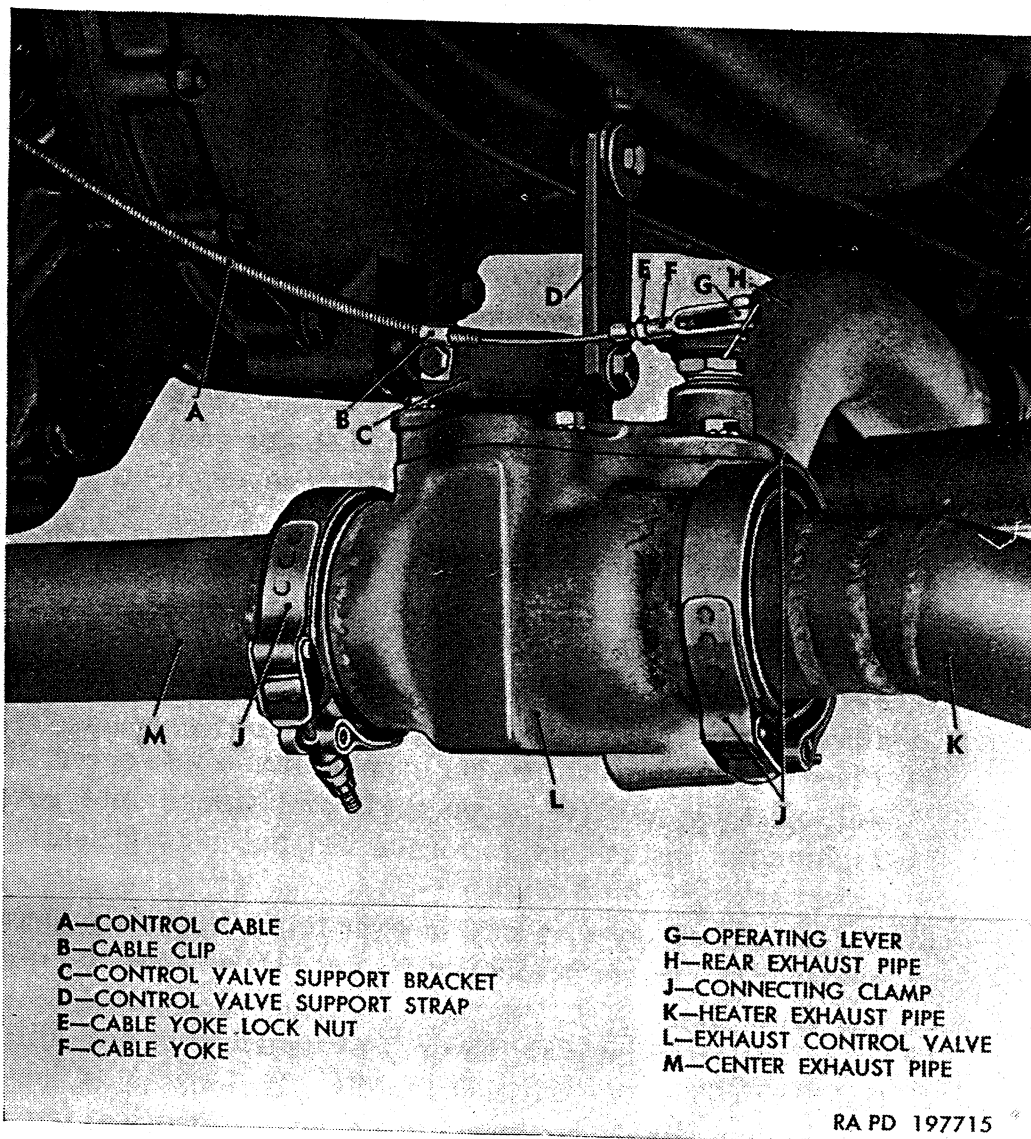

Figure 379. Exhaust control valve installed.

(H) and heater exhaust pipe (K), and remove from under vehicle.

c. Disassembly (fig. 380).

- (1) Loosen nut (D) on lever clamping cap screw (B) and remove operating lever (C) from shaft. Remove woodruff key (N) from shaft.
- (2) Unscrew packing nut (G) from cover and remove from shaft.
- (3) Remove cover-to-body cap screws (A and J) and external-teeth lockwashers (E). The two long cap screws (A) also attach the support bracket (F).
- (4) Separate cover (K) from control valve body (Q). Lift cover off shaft (P), then remove gasket (L), spacer (M), and shaft (P).
- (5) Remove shaft packing (H) from cover and discard.

d. Inspection.

- (1) Clean all rust and scale from inside of valve body, shaft and gate, bottom of cover, spacer, and packing nut. Use wire brush and scraper as necessary to clean parts. Make sure all old packing is removed from shaft opening in cover.
- (2) Inspect clamping flanges at body inlet and outlet openings. If burned excessively or otherwise damaged, replace body assembly.
- (3) Inspect shaft and gate. If gate is loose on shaft, or distorted, or if shaft is damaged at packing surface, replace with new part.

e. Assembly (fig. 380).

- (1) Place shaft (P) in body and install spacer (M) on shaft.
- (2) Place gasket (L) on body; then install cover (K) over shaft and onto body.
- (3) Attach cover-to-body with three short $\frac{5}{16}$ -18 x 1 cap screws (J), two long $\frac{5}{16}$ -18 x $1\frac{3}{8}$ caps screws (A), and five $\frac{5}{16}$ -inch external-teeth lockwashers (E). Support bracket (F) must also be attached with the two long cap screws (A). Tighten all cap screws.
- (4) Place new shaft packing (H) over shaft and into cover. Install packing nut (G) over shaft and thread into cover. Tighten nut just enough to form a seal, but not sufficiently to cause packing to bind shaft.
- (5) Tap woodruff key (N) into keyseat in shaft, install operating lever (C) on shaft, and tighten nut (D) on lever clamping cap screw (B).
- (6) Turn operating lever to the limit of its travel in both directions to make sure shaft turns freely. If shaft binds, loosen packing nut slightly and work lever back and forth to free up shaft.

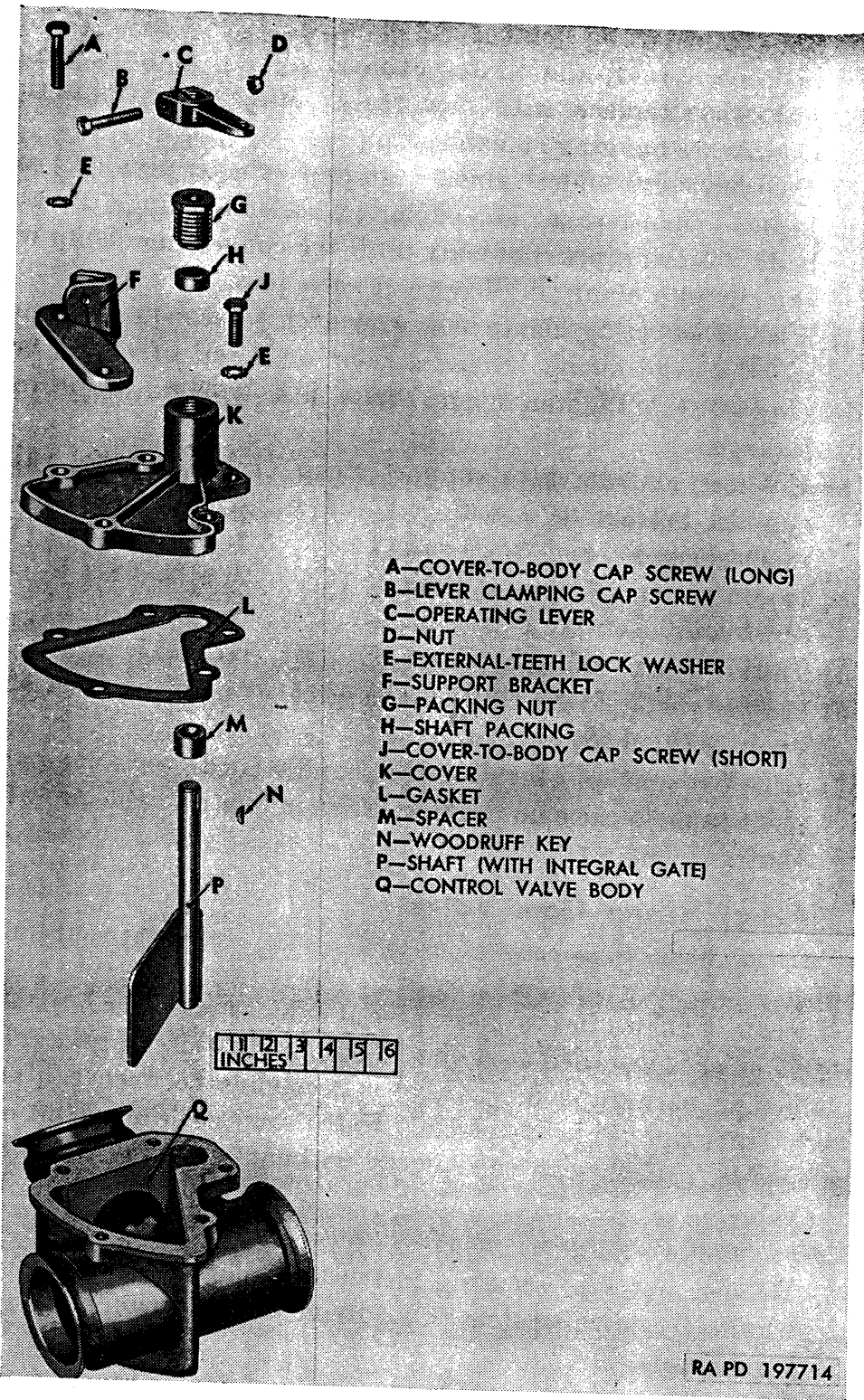

Figure 380. Exhaust control valve components.

f. Installation

Note. The key letters in parentheses are in figure 379, except where otherwise indicated.

- (1) Before installing control valve, examine seals (K, fig. 377) on center, rear, and heater exhaust pipes. If damaged in any way, replace with new seals. Make sure connecting clamps are hanging on exhaust pipes.
- (2) Position valve under vehicle with rear exhaust pipe (H) and heater exhaust pipe (K) engaging outlet openings in valve body. Work pipes into body until the connecting clamp will engage both clamping flanges at each joint.
- (3) Place connecting clamp (J) over each joint, squeeze clamp together and swing hinged anchor over end of clamp bolt (fig. 378). Tighten clamp bolts just enough to prevent leakage.
- (4) Connect control valve support strap (D) to control valve support bracket (C) with a $\frac{3}{8}$ -24 x $1\frac{1}{8}$ cap screw, plain washer, spacer, and $\frac{3}{8}$ -24 safety nut. Attach cable clip (B) to control valve support bracket (C) with a $\frac{1}{4}$ -28 x $\frac{3}{4}$ cap screw and $\frac{1}{4}$ -28 safety nut.
- (5) Install center exhaust pipe (M) (par. 347c(2)).
- (6) Adjust yoke (F) on cable and connect to operating lever (G) (par. 347b(2)(b)).
- (7) Check operation of valve with handle in driver's compartment to make sure no binding exists in control cable or valve shaft.

349. Exhaust Heater Gate Valve

Note. The key letters in parentheses are in figure 381, except where otherwise indicated.

a. General. Exhaust heater gate valve at exhaust entrance into tank heating chamber is installed as shown in figure 381. Use of gate valve is explained in paragraph 53. Valve is accessible between cab and tank body from right side of vehicle. Valve stem packing gland can be tightened or packing can be replaced without removing the valve from the vehicle.

b. Valve Stem Packing Gland Replacement.

- (1) Remove nut (A) securing instruction plate (N) and handwheel (B) on valve stem (C). Remove instruction plate and handwheel.
- (2) Unscrew packing nut (D) from valve bonnet; then remove packing nut, packing gland spring (E), and packing gland (F) from valve stem.
- (3) Using a pointed tool, pry packing (G) from between valve stem and bonnet. Make sure all old packing is removed.

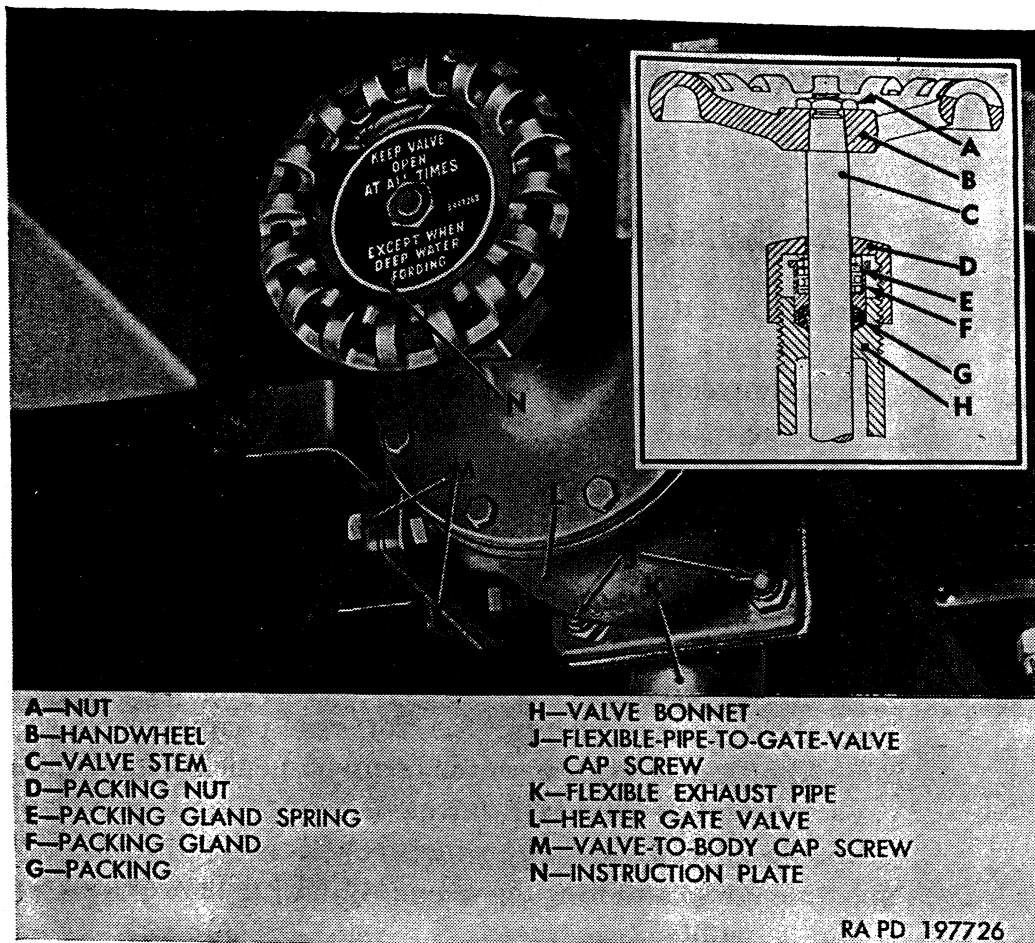

Figure 381. Exhaust heater gate valve.

- (4) Place new packing (G) over valve stem (C) and push into place in valve bonnet (H).
- (5) Place packing gland (F), packing gland spring (E), and packing nut (D) over valve stem. Thread packing nut onto valve bonnet.
- (6) Install handwheel (B) and instruction plate (N) on valve stem and secure with nut (A). While turning valve stem with handwheel, tighten packing nut enough to cause a slight drag on valve stem. For normal operation, leave valve stem turned out (counterclockwise) to open position.

c. Removal.

- (1) Remove four nuts and cap screws (J) attaching flexible exhaust pipe (K) to heater gate valve (L).
- (2) Remove four nuts and cap screws (M) attaching heater gate valve (L) to mounting on body. Remove gate valve assembly.
- (3) Remove and discard two gaskets (H, fig. 377). Make sure all particles of gasket are removed from flexible pipe flange and mounting on body.

d. Installation.

- (1) Using new gasket between gate valve and mounting on body, position gate valve at body and attach with four $\frac{1}{2}$ -20 x $1\frac{1}{2}$ valve-to-body cap screws (M) and $\frac{1}{2}$ -20 safety nuts. Tighten nuts.
- (2) Using new gaskets between flexible pipe flange and gate valve, attach pipe flange to valve with four $\frac{1}{2}$ -20 x $1\frac{1}{2}$ flexible-pipe-to-gate-valve cap screws (J) and $\frac{1}{2}$ -20 safety nuts. Tighten nuts. For normal operation, leave valve stem turned out (counterclockwise) to open position.

Section XXXVII. GASOLINE TANK BODY AND CONTROLS

350. Description and Data

a. Description.

- (1) Gasoline tank body used on gasoline tank truck M217 is a 1,200-gallon tank of all steel construction. Tank is divided into three compartments; the forward compartment is of 200-gallon capacity, the center compartment is of 400-gallon capacity, and the rear compartment is of 600-gallon capacity. Manhole in top of each compartment is equipped with a manhole cover and fill plug assembly. Plug is provided with a vent assembly.
- (2) Drain valve in bottom of each compartment is operated by control lever in pump compartment at rear of body. Emergency control is provided at front end of tank for closing drain valves in emergency, regardless of the position of the control levers at the rear. Drain pipe from each compartment drain valve leads to manifold in pump compartment. Manifold connects to suction side of pump and to pump suction gate valve.
- (3) A running board is provided on each side of tank. Stowage tubes for hose are provided under the running boards, with access doors at the rear. Bow pockets are provided in running boards for installation of camouflage bows and paulin.

b. Data.

Tank body :

Make..... Butler Manufacturing Company
Capacity :
Front compartment..... 200 gal
Center compartment..... 400 gal
Rear compartment..... 600 gal

Tank pump :

Make..... Blackmer Pump Company
Ordnance number..... 8327899
Capacity 60 gpm at 500 rpm

351. Gas-Freeing Tank

Caution: It seldom, if ever, should be necessary for a person to enter a gasoline tank which has not been certified as "gas free." The term "gas free" means that the concentration of flammable vapors in a tank as measured by a combustible gas indicator is not more than 14 percent of the lower flammable limit. However, should such a necessity arise because of an emergency, the person entering the tank should wear a fresh air hose mask. Extreme care should be taken that no open flames or other sources of ignition are introduced in areas where flammable vapors may be present.

The tank can be gas-freed by several methods, such as filling with water to overflowing, steaming, forced ventilation, or natural ventilation. Work should be accomplished only by competent mechanics, and all work should be carried on out-of-doors, remote from other vehicles and known sources of ignition. Care must be exercised when accomplishing even minor service operations to prevent hand tools from producing a spark where any concentration of gas fumes may be present.

352. Body Mounting

a. Description. Gasoline tank body is attached to vehicle frame side members (R, fig. 382) at four points on each side. Front mounting at each side is dual flexible type mounting, the two center mountings are single flexible type, and at rear mounting, bracket on tank is bolted directly to bracket on frame. Each flexible-type mounting consists of an inner and outer spring. At front end, wear plates are bolted to frame side members at points where tank guide plates contact frame. Wood sills, drilled to provide clearance at rivet heads, are used between body mounting channels and frame side members.

b. Replacement. When mountings have been removed for any reason, parts must be installed in positions shown in figure 382. Bolts used at all spring type mountings are $\frac{5}{8}$ -18 x 9; bolts used at rear mountings are $\frac{3}{4}$ -16 x $2\frac{1}{4}$. Tighten spring type mounting bolts until springs are compressed to dimensions shown in figure 382. Tighten rear mounting bolts.

353. Manhole Covers

(fig. 383)

a. General. Operations described in this paragraph cover replacement of fill plug gasket, replacement of manhole cover gasket, and servicing the fill plug vent assembly. Fill plug gasket can be replaced and vent can be serviced after opening the fill plug. The complete manhole cover assembly must be removed to replace the manhole cover gasket.

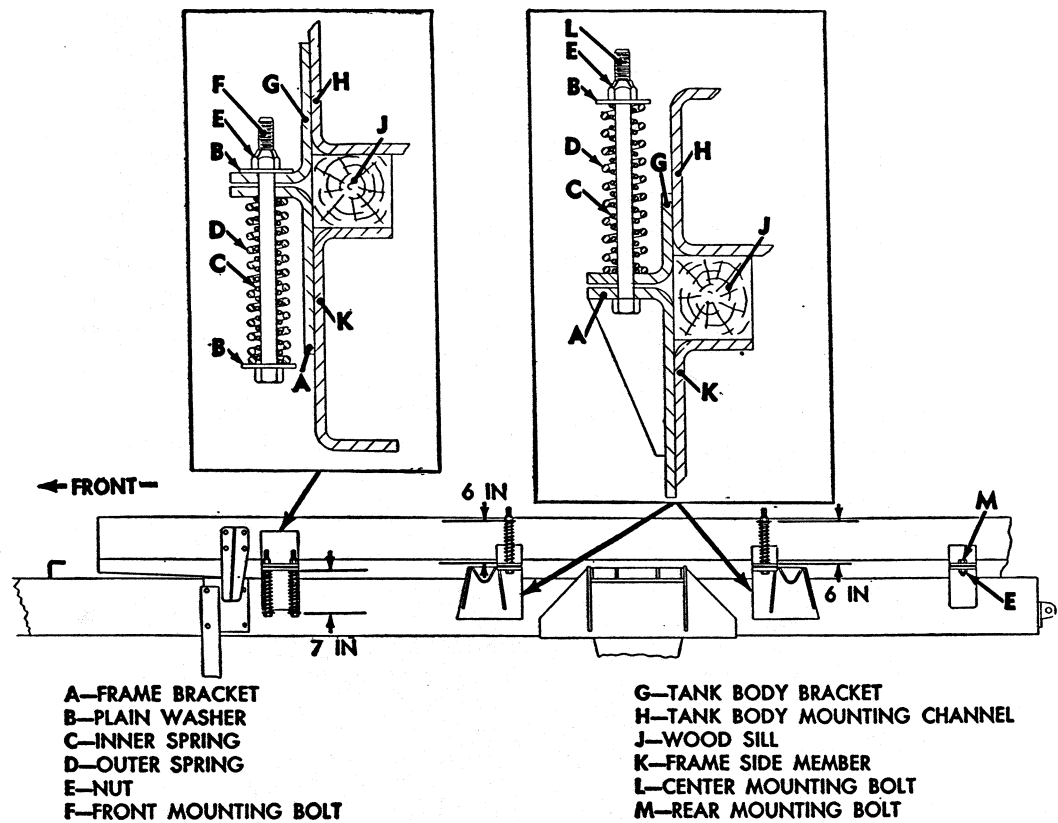

RA PD 197826

Figure 382. Gasoline tank mountings.

b. Fill Plug Gasket Replacement.

- (1) Unlock padlock and disengage padlock from cover hinge; then open fill plug. Place clean cover over opening to prevent entrance of dirt.
- (2) Remove old gasket from groove on underside of fill plug. Make sure groove is thoroughly cleaned; then install new gasket.
- (3) Remove cover from opening, close fill plug, and secure with padlock.

c. Fill Plug Vent Service.

- (1) Unlock padlock, disengage padlock from cover hinge, and open fill plug. Place clean cover over opening. Unscrew vent assembly (M through X) from underside of fill plug (K).
- (2) Loosen locking screw (V) securing vent body (U) to vent cover (M). Unscrew cover from body; then remove ball (N), screen (P), upper disk (Q), pressure spring (R), and lower disk (S). Remove cotter pin (W); then remove vacuum spring (T) and valve (X) from body.
- (3) Wash all parts in dry-cleaning solvent or volatile mineral spirits. Make sure ball (N) and ball seat in cover (M) are

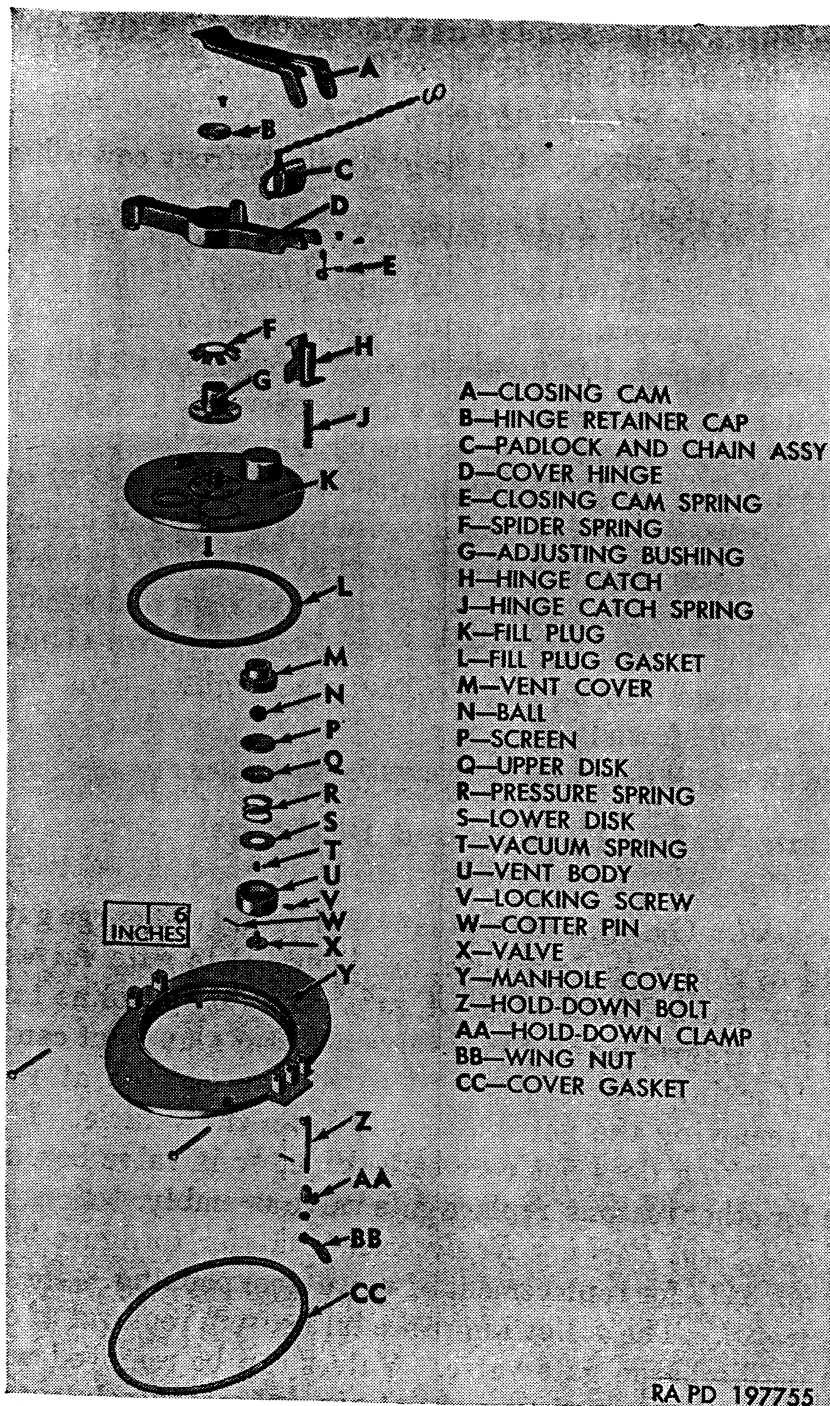

Figure 383. Manhole cover and fill plug components.

- clean, that openings through screen (P) and upper disk (Q) are unobstructed, and that stem of valve (X) slides freely in guide in body (U). Replace worn or damaged parts.
- (4) Insert stem of valve (X) through vent body (U), place vacuum spring (T) over valve stem, and secure with cotter pin (W). Install ball (N) in cover (M); place lower disk (S), pressure spring (R), upper disk (Q), and screen (P) in body; then thread cover into body. Tighten cover into body; then secure in place by tightening locking screw (V).

- (5) Thread vent assembly into under side of fill plug and tighten. Close fill plug and secure with padlock.

d. Manhole Cover Gasket Replacement.

- (1) Unlock padlock, disengage padlock from cover hinge, and open fill plug.
- (2) Reach through fill plug opening and loosen wing nut (BB) on six holddown bolts (Z) until holddown clamps (AA) can be disengaged from bottom of manhole collar. With clamps disengaged, lift manhole cover assembly straight up to remove from tank. It may be necessary to pry under edge of cover at several points to break the gasket joint.
- (3) Remove old gasket from groove in under side of cover and install new gasket. Make sure top of manhole collar is clean.
- (4) Position manhole cover assembly on top of manhole collar, making sure gasket does not become dislodged. Reach through fill plug opening and hook holdown clamps (AA) on bottom of manhole collar; then tighten wing nuts (BB) on holddown bolts.
- (5) Close fill plug and secure with padlock.

354. Gate Valves (Suction and Discharge)

(fig. 384)

a. General. Gasoline tank pump suction and discharge gate valves, installed as shown in figure 384, are identical to gate valves used on water tank truck M222. Use of gate valves on gasoline tank is described in paragraph 55. Gate valve packing gland nut can be tightened or packing can be replaced to correct leakage at valve stem without removing the valve assembly from the vehicle. If replacement of packing does not correct leakage, or if valve becomes inoperative for other reasons, replace gate valve assembly.

b. Valve Stem Packing Replacement. Refer to figure 367 and to paragraph 342*b* for replacement of valve stem packing.

c. Removal. The following procedure covers removal of either the suction or discharge gate valve. Valves can be removed while tank contains gasoline, providing the drain valve control levers are in closed position.

- (1) At discharge gate valve (K) only, remove nut securing handwheel on valve stem and remove handwheel. Also remove four screws attaching valve hole cover plate to compartment floor, and remove the two halves of the cover plate.
- (2) Remove four cap screws and nuts attaching elbow (H or J) to valve body flange, and remove elbow.
- (3) Remove four cap screws and nuts attaching valve body to flange on manifold (F) or pump discharge pipe (L); then remove valve assembly.

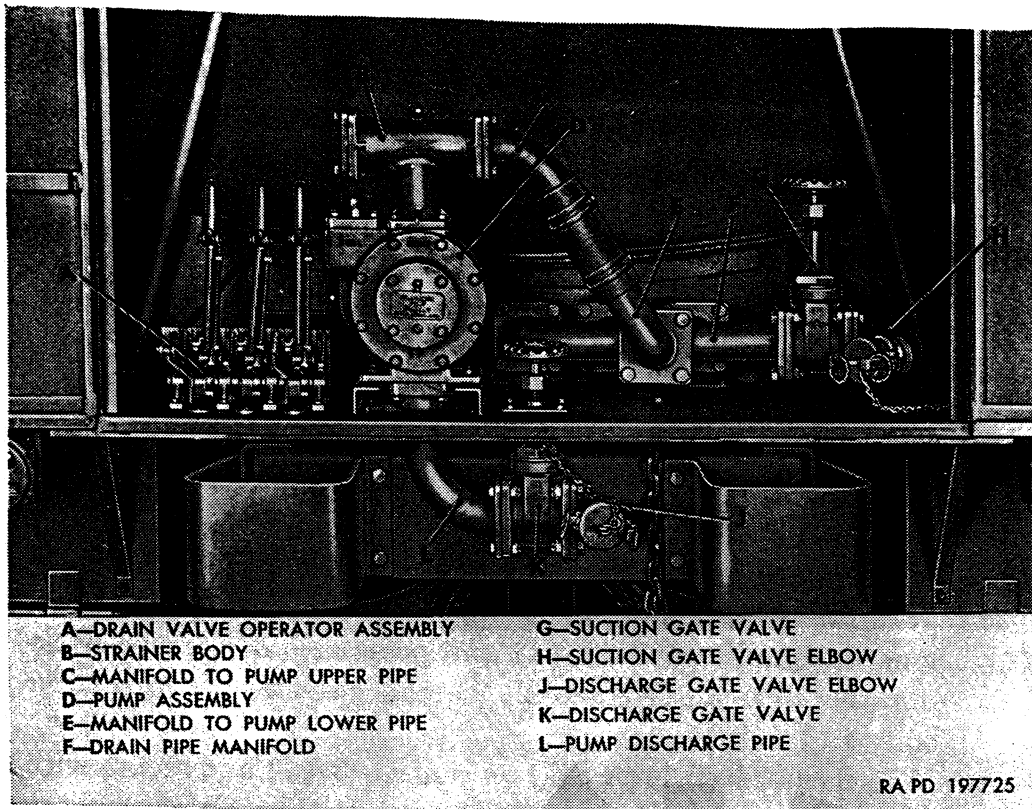

Figure 384. Units installed in pump compartment.

d. Installation. When installing a new discharge gate valve (K), handwheel must be removed from valve stem to permit inserting valve bonnet up through compartment floor.

- (1) Make sure all particles of old gasket are removed from mating surfaces on valve body flanges, discharge pipe flange, and manifold flange.
- (2) Position gate valve assembly and new gasket at pump discharge pipe (L) or drain pipe manifold (F) flange and secure with four $\frac{1}{2}$ -20 x $1\frac{1}{2}$ cap screws and $\frac{1}{2}$ -20 safety nuts. Tighten to provide a leakproof joint.
- (3) Install suction and discharge gate valve elbow (H or J) and gasket on gate valve body and secure with four $\frac{1}{2}$ -20 x $1\frac{1}{2}$ cap screws and $\frac{1}{2}$ -20 safety nuts. Tighten to provide a leakproof joint. Install dust cap on elbow.
- (4) At discharge gate valve (K) only, install gate valve hole cover plates on compartment floor around valve bonnet and secure to floor with four No. 14 x $\frac{1}{2}$ tapping screws. Install handwheel on valve stem and secure with nut.

355. Drain Valves and Controls

a. General. Drain valve sump with mounting studs is welded into bottom of each tank compartment. Drain pipe from each drain valve connects to manifold in pump compartment. Drain valves are iden-

tical to those used in water tank truck M217, and are controlled by operating levers in pump compartment as described in paragraph 55. Drain valves, drain pipes, and cables are accessible from under vehicle. Drain valve controls installed in pump compartment are shown in figure 384. Drain valve cam shaft packing can be replaced without removing the drain valve from the tank. Drain valve should be removed from tank for all other services to avoid the necessity of entering the tank compartment.

b. Drain Valve Cam Shaft Packing Replacement (fig. 370).

- (1) Remove cotter pin (M) securing cam shaft lever (K) on cam shaft (J). Remove lever from cam shaft.
- (2) Unscrew cam shaft packing nut (N) from valve body (H) and remove nut from cam shaft. Use pointed or hooked tool to pull packing out from between cam shaft and valve body.
- (3) Wrap asbestos-graphite packing (P) ($\frac{3}{16}$ in. sq x $11\frac{1}{2}$ in. long) around cam shaft (J) and press into body until packing nut (N) can be started. Thread packing nut into valve body and tighten.
- (4) Install cam shaft lever (K) on cam shaft (J) and secure with cotter pin (M). Operate lever several times; then tighten packing nut. Do not tighten packing nut sufficiently to prevent valve closing.

c. Drain Valve Removal.

- (1) Remove cotter pin and clevis pin attaching cable yoke to cam shaft lever. Remove six nuts and cap screws attaching drain pipe flange to drain valve flange.
- (2) Remove six nuts from studs attaching drain valve to tank sump. Break the gasket joints with a screwdriver; then remove valve assembly. Discard gasket.

d. Drain Valve Plunger Spring Replacement (fig. 370).

- (1) Remove plunger rod eye (G) and screen from valve bonnet (E).
- (2) Using wrench on hex portion of valve bonnet, unscrew bonnet from valve body (H). Lift bonnet and plunger spring off plunger rod. Discard spring.
- (3) Install new plunger spring (D) over plunger rod (F) install bonnet (E) over plunger rod, and thread bonnet into valve body. Tighten bonnet.
- (4) Thread eye onto end of plunger rod. Clean drain valve screen; then place screen over valve.

e. Drain Valve Installation.

- (1) Make sure mating surfaces of valve body, drain pipe flange and tank sump are clean. Coat both sides of new gaskets with gasket cement and position gaskets on drain pipe flange and on tank sump.

- (2) Position valve assembly at sump and drain pipe, being careful not to dislodge gaskets. Attach valve body to sump by installing six $\frac{3}{8}$ -24 safety nuts on studs. Attach drain pipe flange to valve body with six $\frac{3}{8}$ -24 x $1\frac{1}{4}$ cap screws and $\frac{3}{8}$ -24 safety nuts. Tighten all nuts.
- (3) Connect cable yoke to cam shaft lever with clevis pin and cotter pin.

f. Drain Valve Control Cable Replacement (fig. 385). The following procedure applies to either of the three drain valve operating cables and to the front end release cable. Cable lengths are as follows: rear compartment drain valve is 84 inches; center compartment drain valve is 132 inches; front compartment drain valve and front end trip release cables is 156 inches.

- (1) In pump compartment, disconnect cable from valve operating control lever (A) or from front end release lever cable connector (J) by loosening nut on cable locking screw (B) and pulling cable from screw.
- (2) From under vehicle, pull cable out of rear guide tube. Disconnect cable from cable connector at drain valve cam shaft lever by loosening nut on cable locking screw and pulling end of cable out of screw. To remove front end release cable, disconnect cable from release handle in same manner, then pull cable out of front end guide tube.
- (3) Solder end of new cable to prevent spreading of strands. From under vehicle, insert cable through guide tube, applying chain and wire rope lubricant (CW) to cable as cable is inserted into tube. Push cable through tube just far enough to make connection at control levers. If front end release cable was removed, insert front end of cable through front end guide tube in same manner.
- (4) Insert end of cable through locking screw in drain valve cam shaft lever cable connector or in front end release handle and tighten nut on cable locking screw. Make sure cables are in place on cable spools (guide pulleys).
- (5) In pump compartment, insert end of cable through locking screw (B) in operating control lever or in front end release lever cable connector. Provide for slight slack in cable with control lever and valve in closed position; then tighten nut on cable locking screw.

g. Drain Valve Operator Assembly Replacement.

Note. The key letters in parentheses are in figure 385 except where otherwise indicated.

Drain valve operator comprises the drain valve control levers together with their mounting brackets, shafts, bearings, etc., as a unit assembly (fig. 385). Operator assembly installed is shown in figure 384.

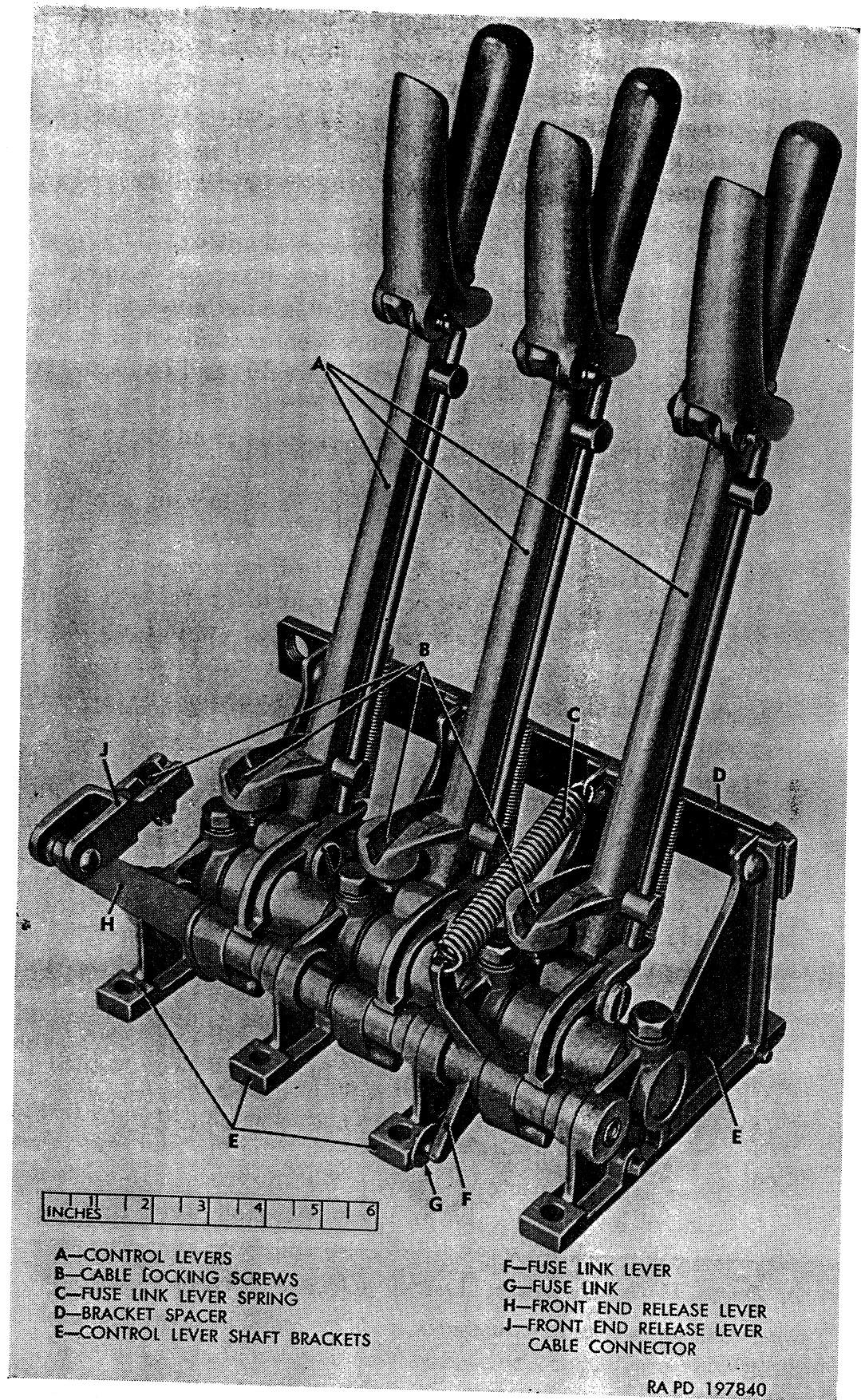

Figure 385. Drain valve operator assembly.

- (1) Loosen nuts on cable locking screws (B). Withdraw ends of cables from locking screws. Unscrew four nuts securing cable guide tubes to bracket spacer (D).
- (2) Remove eight cap screws and nuts attaching control lever shaft brackets (E) to bottom of compartment. Lift operator assembly out of compartment.
- (3) Position new or rebuilt operator assembly on equipment compartment floor, guiding cable ends through openings in bracket spacer (D). Thread cable guide tube nuts into bracket spacer.
- (4) Attach control lever shaft brackets (E) to compartment floor with eight $\frac{1}{4}$ -28 x 1 cap screws and $\frac{1}{4}$ -28 safety nuts. Tighten nuts.
- (5) Thread ends of cables through locking screws (B) in control levers and in front end release lever cable connector. Provide for slight slack in cables with levers in forward (valves closed) position; then firmly tighten nuts on cable locking screws.

h. Drain Valve Operator Fuse Link Replacement (fig. 385).

- (1) Fuse link (G) consists of two brass links soldered together. One end of link is anchored to one of the control lever shaft brackets, and the other end acts as an anchor for the lower end of the fuse link lever (F). The lever is spring-loaded against the link at all times by the fuse link lever spring (C). If fuse link becomes separated for any reason and one or more of the drain valve control levers are in open position, spring rotates lever and causes cams to release the control levers, permitting valve to close.
- (2) To replace fuse link, remove cotter pins securing link ends on bracket and lever. Place end of new link on lug on bracket and secure with cotter pin. Pull rearward on upper end of fuse link lever, stretching fuse link lever spring (C), until link end can be hooked onto lower end of lever. Secure link end on lever with cotter pin.

356. Drain Pipe Manifold

(fig. 384)

a. General. Cast aluminum drain pipe manifold (F) connects tank compartment drain pipes and pump suction gate valve to intake side of pump. In the event manifold becomes damaged in any way, it must be replaced.

b. Replacement.

- (1) *Removal.* Remove four nuts and cap screws attaching suction gate valve (G) to manifold, and remove valve assembly. Remove nuts and cap screws attaching manifold to pump

lower pipe (E) and three tank compartment drain pipes to manifold (F). Remove manifold and gaskets.

(2) *Installation.*

- (a) Make sure all particles of gasket are removed from bolting flanges of manifold (F), manifold to pump lower pipe (E), and suction gate valve (G). Coat both sides of five gaskets with gasket cement and stick gaskets onto manifold flanges.
- (b) Position manifold against drain pipe flanges and secure with twelve $\frac{1}{2}$ -20 x $1\frac{1}{2}$ cap screws and $\frac{1}{2}$ -20 safety nuts. Tighten nuts.
- (c) Connect manifold to pump lower pipe to manifold with four $\frac{1}{2}$ -20 x $1\frac{1}{2}$ cap screws and $\frac{1}{2}$ -20 safety nuts. Tighten nuts.
- (d) Install suction gate valve on end of manifold and secure with four $\frac{1}{2}$ -20 x $1\frac{1}{2}$ cap screws and $\frac{1}{2}$ -20 safety nuts. Tighten nuts.

357. Gasoline Tank Body Pump

Pump used with gasoline tank body is identical to the pump used with water tank body on water tank truck M222. Refer to paragraphs 54 and 55 for description and operation of gasoline pump controls. Refer to paragraph 344 for instructions for servicing pump strainer and for replacing the pump assembly.

358. Gasoline Tank Pump Propeller Shafts

a. General. Power to drive the gasoline tank pump is supplied from the vehicle engine through the power-take-off accessory drive unit and a drive line. The drive line consists of a front and rear propeller shaft and universal joint assembly, a solid center shaft, and two pillow block (center bearing) assemblies. The center shaft is supported from the under side of the body framing by the two pillow blocks, one at each end. Each propeller shaft is a tubular-type shaft with a fixed universal joint yoke welded to one end and a splined stub shaft welded to the other end. Each shaft assembly incorporates a fixed yoke-type universal joint at forward end and a slip yoke type universal joint at rear end. Propeller shaft universal joint yokes are attached to accessory drive output shaft, front and rear ends of center shaft, and at gasoline pump rotor shaft by a woodruff key and a hex-socket setscrew. Lubrication fittings are provided at each universal joint journal, slip yoke, and pillow block. The front propeller shaft used on gasoline tank truck M217 is identical to the one used at front on water tank truck M222 (figs. 374 and 375). The balance of the drive line is similar to that shown in figure 374.

b. Front Propeller Shaft Replacement. Refer to paragraph 345b and c.

c. Rear Propeller Shaft Removal.

- (1) Loosen hex-socket setscrew securing universal joint yokes to center shaft and to pump rotor shaft.
- (2) Loosen hex-socket setscrew securing slip yoke stop collar on shaft splines and slide collar forward on shaft.
- (3) Telescope shaft at slip yoke, pulling universal joint yoke off pump rotor shaft. Pull universal joint yoke off center shaft; then remove rear propeller shaft assembly from under vehicle.

d. Rear Propeller Shaft Installation.

- (1) Make sure woodruff key is in place in rear end of center shaft and in pump rotor shaft.
- (2) Position propeller shaft under vehicle, with universal joint yoke at front end of shaft in place on end of center shaft.
- (3) Telescope shaft at slip yoke and install universal joint yoke on pump rotor shaft.
- (4) Position universal joint yokes on center shaft and on pump rotor shaft so that the shaft completely fills the yoke bores; then tighten hex-socket setscrews.
- (5) Position slip yoke stop collar to provide $\frac{3}{4}$ -inch clearance between collar and end of slip yoke; then tighten setscrew in collar.

e. Center Propeller Shaft and Pillow Block Replacement. Refer to paragraphs 345f and g.

f. Propeller Shaft and Universal Joint Repair.

- (1) *Front propeller shaft and universal joint.* Refer to paragraph 345h.
- (2) *Rear propeller shaft and universal joint.* Refer to paragraph 320.

359. Power-Take-Off Accessory Drive Control Linkage

Power-take-off accessory drive control linkage, used on gasoline tank truck M217, is the same as that used on water tank truck M222. Refer to paragraph 346.

Section XXXVIII. SHOP VAN BODY AND ASSOCIATED PARTS

360. Description

a. Shop van body used on shop van truck M220 is a completely inclosed body which is used as a mobile machine shop. Side walls and roof are fully insulated, and body is completely sealed for deep-water fording. Access to body interior is through double doors at rear, with a step ladder provided to facilitate entering and leaving. Small door near top of front end at left side is a communication door, providing a means for an occupant of the body to communicate with the driver.

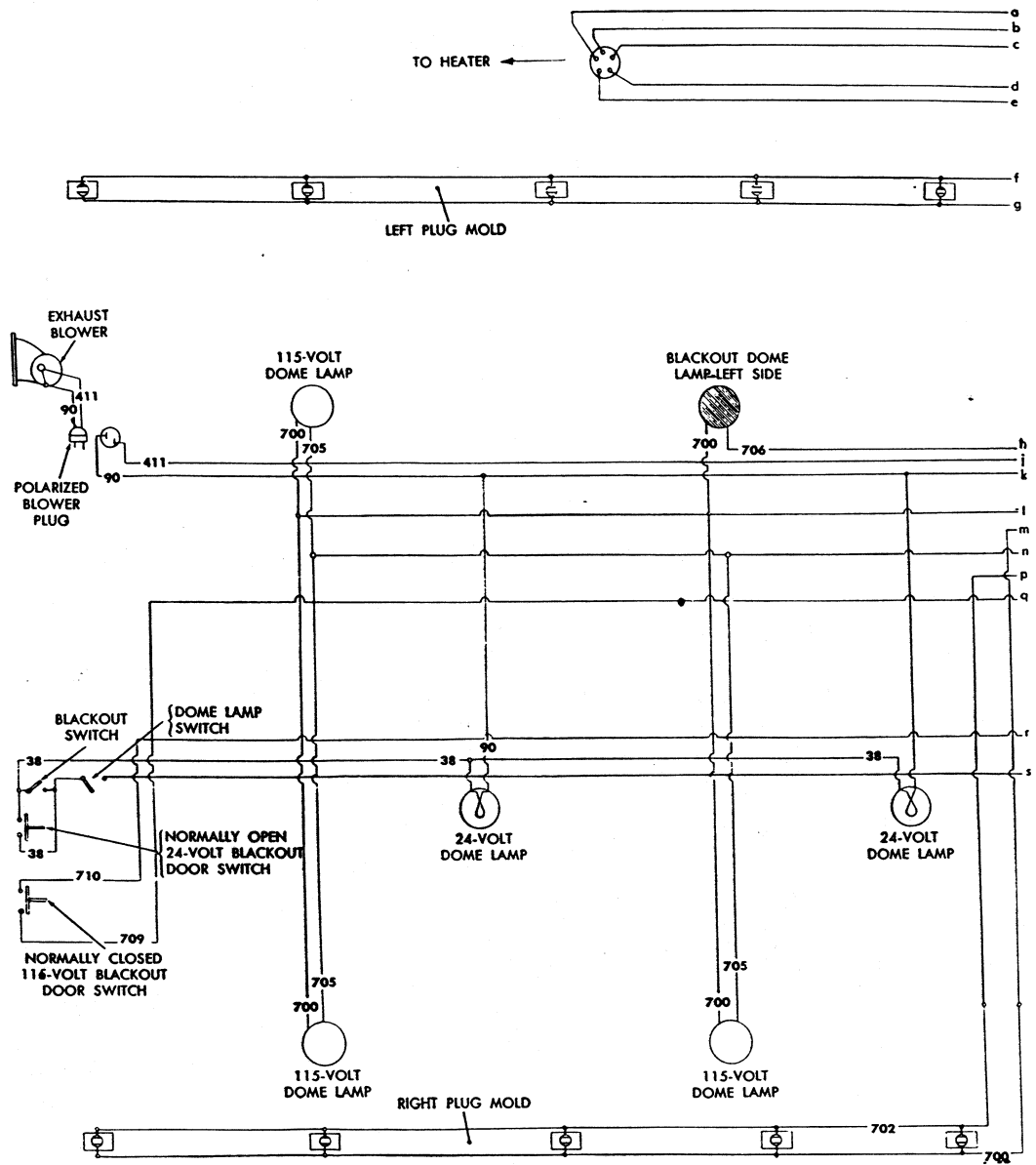
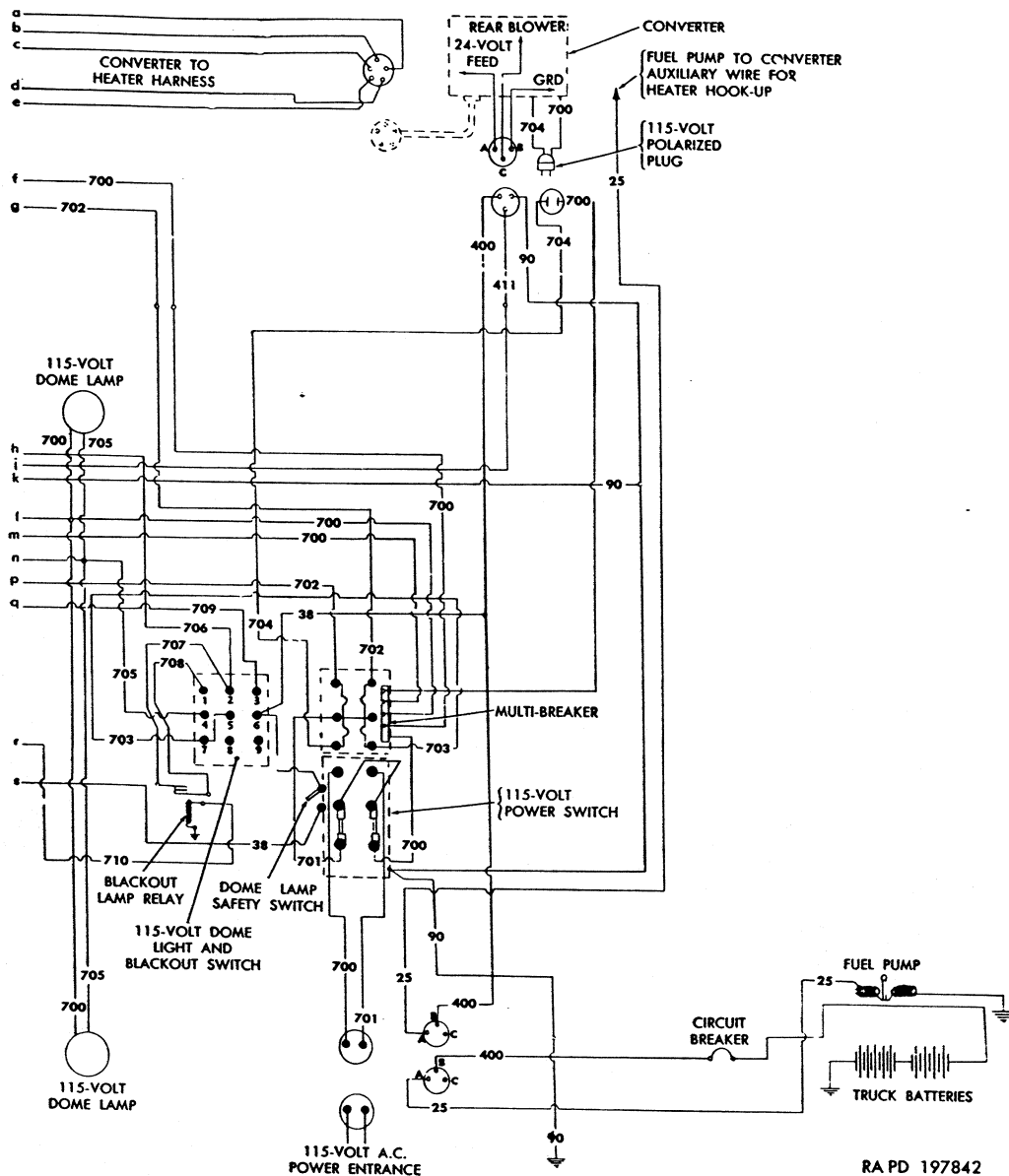

Figure 386. Shop van body wiring circuit diagram.

b. Three windows are provided in each side, one in front end, and one in each door at rear. All windows are equipped with screens and blackout panels. Side windows are hinged at top and can be opened to any desired degree from inside the body.

c. Body is equipped with wiring and controls necessary for use of either 24-volt direct current from the truck electrical system or 115-volt alternating current from an outside power source. An exhaust blower is provided at left rear corner of body for ventilation of body interior. Blower is operative on either 24-volt dc or 115-volt ac power. Operation of switches, lights, and exhaust blower is described in paragraph 57. Wiring circuit diagram (fig. 386) shows all wiring circuits and connections, and shows ordnance circuit numbers which appear on metal tag near end of each cable.



RA PD 197842

Figure 386—Continued.

361. Body Mountings

a. Description. Shop van body is attached to vehicle frame side members at four points on each side as shown in figure 387. Front mounting at each side is dual spring flexible-type mounting, the two center mountings at each side are single spring flexible-type mountings, and at rear mounting, bracket on body mounting channel is bolted directly to bracket on frame. Wood sills, drilled to provide clearance at rivet heads, are used between body mounting channels and frame side members. At front end, wear plates are bolted to frame side members at points where body guide plates contact frame.

b. Replacement. When mountings have been removed for any reason, parts must be installed in positions shown in figure 387. Bolt sizes are as follows: Front mountings (L, fig. 387)— $\frac{5}{8}$ -18 x 9; center mountings (N, fig. 387)— $\frac{3}{4}$ -16 x 7, and rear mounting (R, fig. 387)—

$3/4$ -16 x 2 $1/2$. Note that inner and outer springs are used on each bolt at front mounting, with plain washer next to bolt-head. On center mountings, spring keepers are used at each end of springs. Tighten spring-type mounting bolts until springs are compressed to dimensions shown on figure 387. Tighten rear mounting bolts.

362. Body Lubrication

a. Door Holders. Door holders, mounted at each upper rear corner of body, are equipped with lubrication fittings. Automotive and artillery grease (GAA) should be applied through fittings at regular intervals to assure free movement of the spring-loaded plungers.

b. Door Hinges and Lock Linkage. Door hinges and door lock linkage pivot points should be lubricated with preservative lubricating oil (PL) at frequent intervals to assure free operation.

363. Switch Boxes

(fig. 388)

a. General. Blackout operation switch box (B), multibreaker box (F), and power switch box (J) assemblies are mounted inside body at upper right front corner. Boxes are mounted on mounting rails, which are attached to the body panel. Cables leading from one box to the other pass through a pipe nipple connecting the boxes. Pipe nipple connecting the blackout operation switch box to multibreaker box also serves as a right side mounting for the blackout operation switch box. Pipe nipples are held in place by locknuts installed on nipples between the boxes and by bushings threaded onto ends of nipple inside the boxes. Mounting cap screw nuts are accessible from inside the boxes. Inside of blackout operation switch box and power switch box are accessible after opening the box doors; cover must be removed from multibreaker box for access to inside box.

b. Removal. The procedures which follow are general and cover removal and installation of either of the three switch boxes.

- (1) Open door of power switch box (J) and blackout operation switch box (B), or remove cover from multibreaker box (F).
- (2) Turn locknut (D) on pipe nipple (E) away from box to be removed. From inside box, unscrew bushing (H) from end of nipple.
- (3) Disconnect feed cable (No. 400) from vehicle right battery positive (+) terminal to prevent accidental short. Disconnect all cables leading from box to be removed into the adjoining box (or boxes).
- (4) Remove nuts from lower mounting cap screws (K). Loosen nuts on upper mounting cap screws (G).
- (5) Lift box sufficiently to unhook from upper mounting cap screws, then withdraw box from nipple, pulling cables from box as box is removed.

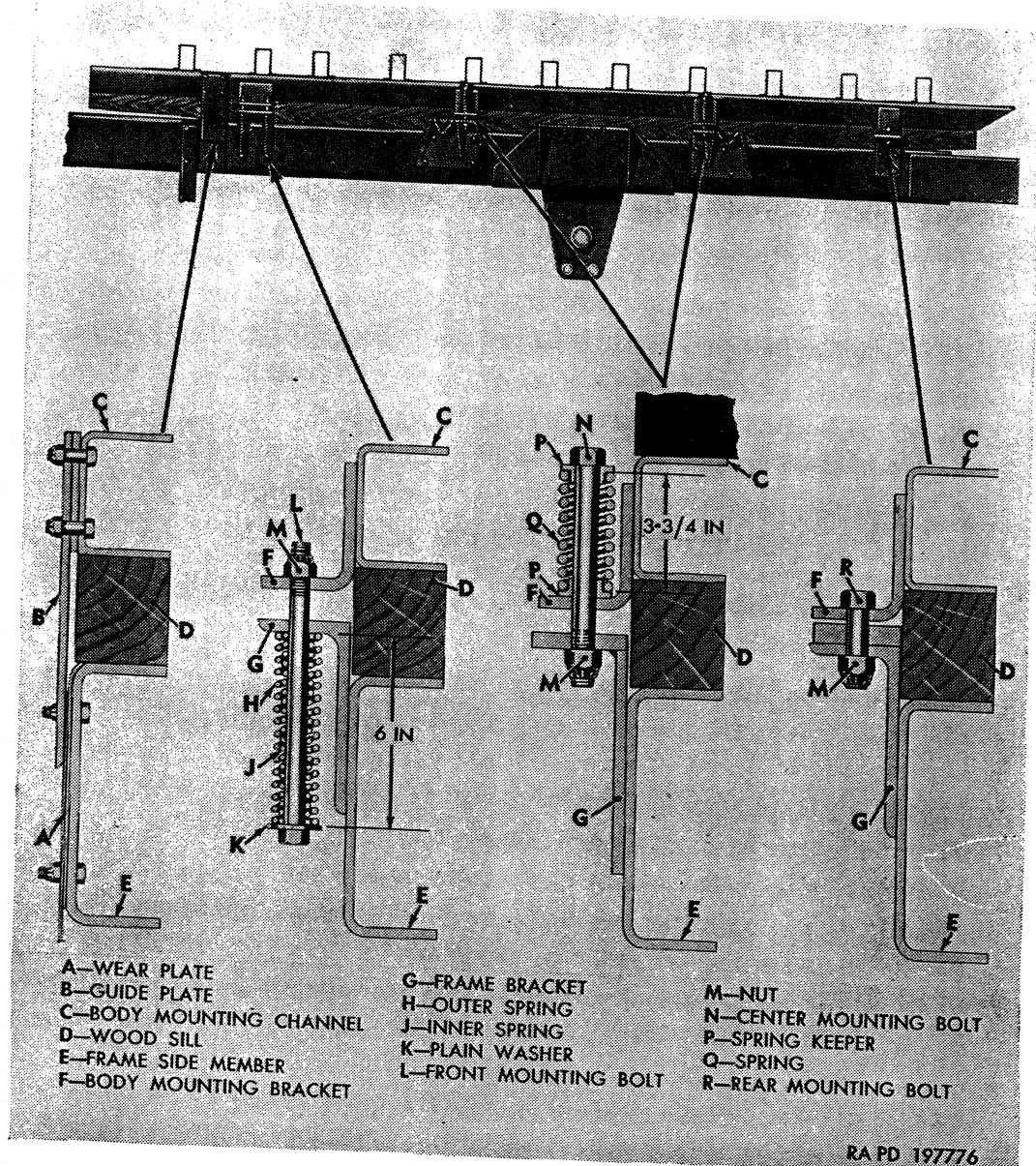

RA PD 197776

Figure 387. Shop van body mountings.

c. Installation.

- (1) Make sure locknut (D) is in place on pipe nipple (E) on adjacent box. Be sure upper mounting cap screws (G) are in place in mounting rails with nuts loosened.
- (2) As box is moved into position, thread cables through opening in box and guide opening over nipple on adjacent box. Engage upper mounting cap screws (G) in upper mounting holes. Install lower mounting cap screws (K) and nuts; then tighten nuts on all cap screws.
- (3) Place bushing over cables extending through nipple and thread bushing (H) onto end of nipple. Turn locknut (D) toward end of nipple to force box against edge of bushing.

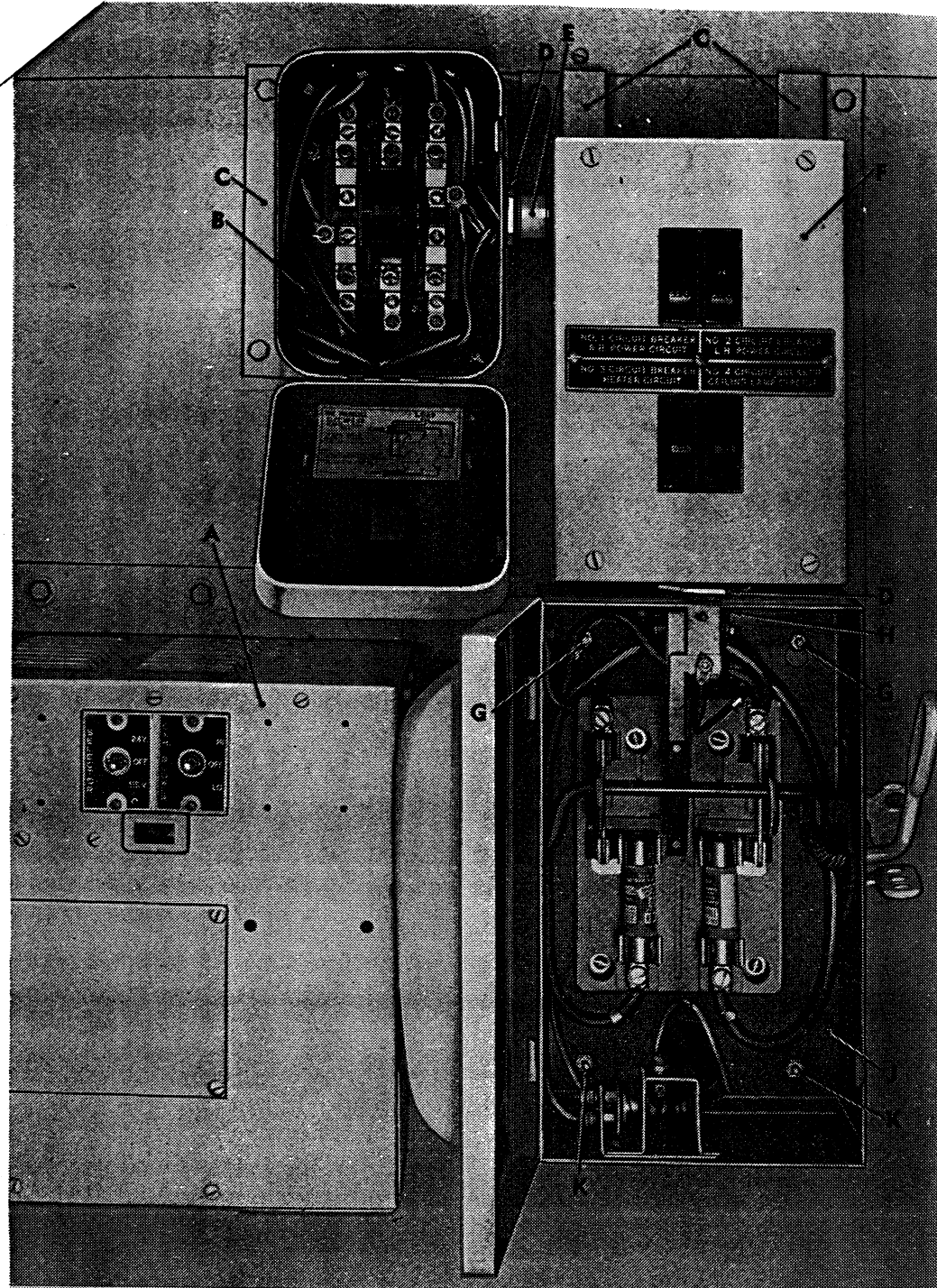

A—CONVERTER ASSEMBLY
 B—BLACKOUT OPERATION SWITCH BOX
 C—MOUNTING CHANNEL
 D—LOCK NUT
 E—PIPE NIPPLE

F—MULTI-BREAKER BOX
 G—UPPER MOUNTING CAP SCREWS
 H—BUSHING
 J—POWER SWITCH BOX
 K—LOWER MOUNTING CAP SCREWS

RA PD 197845

Figure 388. Switch boxes installed.

- (4) Connect cables to terminals in box, referring to wiring circuit diagram (fig. 386) to identify cable numbers which connect to each terminal.
- (5) With mounting cap screws tightened and all cables connected, close switch box door or install cover on multibreaker box.
- (6) Connect feed cable No. 400 to vehicle right battery positive (+) terminal.

364. Exhaust Blower

(fig. 389)

a. General. Exhaust blower assembly, consisting of a blower wheel, blower housing, and blower motor is mounted on exhaust blower duct in upper left rear corner of body. Blower provides forced ventilation inside the body. Air intake is through screened opening in side of blower housing opposite the blower motor. Air is exhausted to outside through blower duct. Blower duct door, controlled by handle at right side of duct, must be open for blower to be effective; notches in segment hold handle in any desired position.

b. Removal.

- (1) Pull blower motor cable plug out of receptacle in rear wall of body.

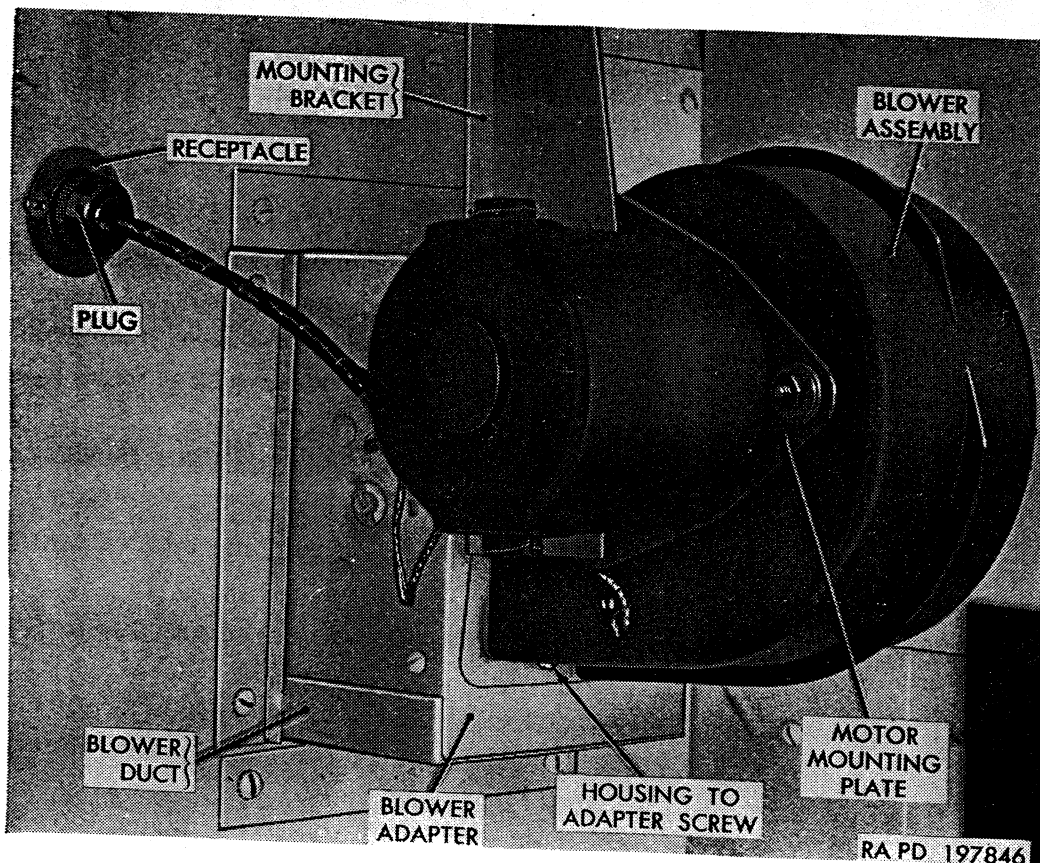

Figure 389. Exhaust blower installed.

- (2) Blower housing is attached to blower adapter by six screws, only one of which is visible in figure 389. There are two screws at top, two at bottom, and one on each side. Remove all six blower housing-to-adapter screws.
- (3) Remove nuts from two blower housing-to-motor-mounting-plate studs which extend through the mounting bracket.
- (4) Disengage studs from mounting bracket and pull blower assembly away from blower adapter.

c. Installation.

- (1) Position blower assembly at blower duct, with flanges on blower adapter inside the blower housing, and with two blower housing-to-motor-mounting-plate studs through holes in mounting bracket.
- (2) Install nuts on the two mounting studs and tighten.
- (3) Install six blower housing-to-adapter screws and tighten.
- (4) Insert blower motor cable plug into receptacle in rear wall of body.

365. Dome Lights

(fig. 390)

a. General. Eight dome lights are installed in ceiling of shop van body. Three lights on each side are 115-volt units, and the two center lights are 24-volt units. The center 115-volt light on left side has a dark lens to provide limited illumination under blackout conditions. Operation of lights is explained in paragraph 57e.

b. Lamp-Unit (Bulb) Replacement. The following procedures apply to both the 115-volt and 24-volt units with differences noted in text.

- (1) Unscrew door retaining screw and swing door down.
- (2) To replace 115-volt lamp-unit, unscrew lamp from socket and thread new lamp into place. To replace 24-volt lamp-unit, press lamp in and turn counterclockwise to release from socket; press new lamp into socket and turn clockwise to lock in place.
- (3) Swing door up against light body and thread door retaining screw into body.

c. Light Assembly Replacement. The following procedures apply to both the 115-volt and 24-volt units.

- (1) Unscrew door retaining screw and swing door down for access to screws attaching light body to ceiling.
- (2) Remove four screws attaching light body to ceiling.
- (3) Pull light assembly away from ceiling; then disconnect cables from lamp socket.
- (4) Connect cables to socket on new light assembly, position light assembly at ceiling, and attach with four screws.

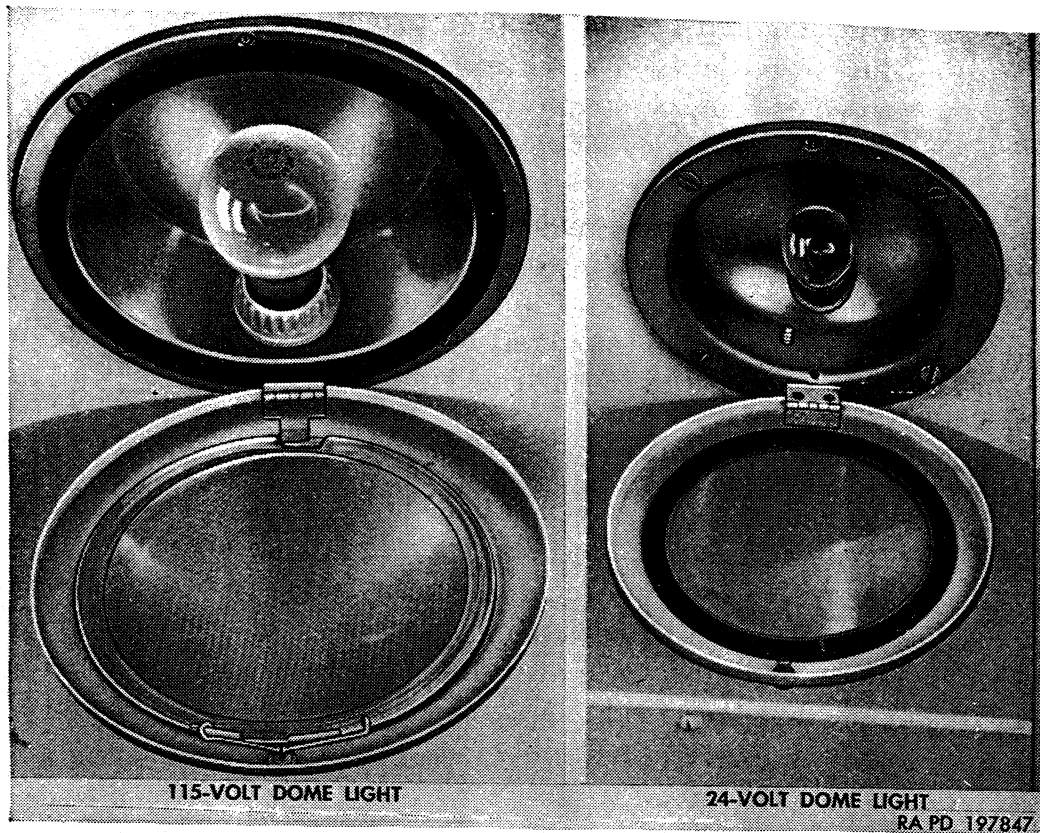

Figure 390. Dome lights installed (doors open).

- (5) Install lamp-unit (bulb) in socket, close door, and secure with door retaining screw.

366. External Power Receptacle

a. General. External power receptacle (fig. 69) for 115-volt alternating current is mounted in upper right front corner of shop van body. Receptacle cables pass through the body wall into the power switch box (J, fig. 388).

b. Removal.

- (1) From inside body, open door of power switch box (J, fig. 388). Loosen screws securing receptacle cables in switch terminals (two upper terminals). Pull cable ends out of terminals.
- (2) From outside body, remove four screws securing receptacle housing to body. Remove receptacle from body, withdrawing cables from switch box as receptacle is removed.

c. Installation.

- (1) Place gasket over receptacle cables, then thread cables through opening in body and into power switch box (J, fig. 388). Secure receptacle to body with four screws, with dust cap chain clip under head of one screw. Tighten screws.
- (2) Insert cable ends into switch terminals, matching numbers on cables with numbers on cables connected to lower termi-

nals. Tighten terminal screws to hold cable ends in place. Close switch box door.

367. Side Window Screens

(fig. 75)

a. General. Screens are provided at the three side windows on each side. Screens are installed on inside of body, with window control arm extending through the screen frame center channel. Control arm spring-loaded slide bolt is mounted on center channel. Screen installed with window opened is illustrated in figure 75.

b. Removal.

- (1) Disengage ring in end of window control arm from control arm hook at top of screen frame and swing control arm down. Spread ring at split and remove ring from control arm.
- (2) Remove 18 screws attaching screen frame to body. Loosen screen from body panel, using small pry tool if necessary.
- (3) While holding control arm slide bolt down as far as possible to prevent bolt from engaging openings in window control arm, remove screen assembly from control arm.

c. Installation.

- (1) Position screen assembly on inside of body panel, with window control arm inserted through opening in screen center channel.
- (2) Attach screen frame to body panel with 18 screw and lock-washer assemblies. Tighten screws.
- (3) Install ring in end of window control arm. If window is to be left in closed position, swing control arm up and engage control arm ring in hook at top of screen frame.

368. Window Glass Replacement

a. General. Front window glass and rear door window glass can be replaced from inside the body (*c* below) without removing the complete sash assembly. To replace side window glass, the complete sash assembly must be removed from the body.

b. Side Window Sash Removal.

- (1) From outside vehicle, remove blackout panel from guide channels on window outer frame.
- (2) Inside vehicle, remove ring from end of window control arm (fig. 75). Pull down on control arm slide bolt and open window until control arm is completely withdrawn from the screen frame center channel.
- (3) Outside vehicle, remove screw from top center of body half of window hinge. With screw removed, raise window until window half of hinge will slide from body half of hinge; then slide window endwise to remove from body.

c. Glass and Glazing Strip Replacement. The following procedure covers replacement of glass in side windows after they have been removed from the body (*b* above), also replacement of front window and rear door window glass from inside the body.

- (1) Remove screws attaching window inner frame assembly to insulation strips; then remove inner frame assembly.
- (2) From outer side, push glass and glazing strip toward inner side and out of outer frame.
- (3) Place glazing strip around glass assembly with hole in glazing strip over vent cap at top of glass. Install glass and glazing strip in outer frame with vent cap at top, making sure glazing strip is squarely seated inside the insulation strips.
- (4) Position inner frame assembly against insulation strips and attach with round-head wood screws. Tighten screws.

d. Side Window Sash Installation.

- (1) Hold window assembly in raised position outside the body and engage window half of hinge with body half of hinge. Slide window into place and insert control arm through opening in center channel screen frame (fig. 75).
- (2) With notch in window half of hinge aligned with screw hole in body half of hinge, thread screw into tapped hole.
- (3) Inside body, close window and install ring in end of control arm. Swing control arm up and engage control arm ring in hook at top of screen frame.
- (4) Install blackout panel in guide channels on window outer frame.

Section XXXIX. MAINTENANCE UNDER UNUSUAL CONDITIONS

369. Extreme Cold Weather Maintenance Problems

a. The importance of maintenance must be impressed on all concerned, with special emphasis on organizational (preventive) maintenance. Maintenance of mechanical equipment in extreme cold is exceptionally difficult in the field. Even shop maintenance cannot be completed with normal speed, because the equipment must be allowed to thaw out and warm up before the mechanic can make satisfactory repairs. In the field, maintenance must be undertaken under the most difficult of conditions. Bare hands stick to cold metal. Fuel in contact with the hands results in super-cooling due to evaporation, and the hands can be painfully frozen in the matter of minutes. Engine oils, except subzero grade, are unpourable at temperatures below -40° F. Ordinary greases become as solid as cold butter.

b. These difficulties increase the time required to perform maintenance. At temperatures below -40° F., maintenance requires up to five times the normal amount of time. The time required to warm up

a vehicle so that it is operable at temperatures as low as -50° F. may approach 2 hours. Vehicles in poor mechanical condition probably will not start at all, or only after many hours of laborious maintenance and heating. Complete winterization, diligent maintenance, and well-trained crews are the key to efficient arctic-winter operations.

c. Refer to TM 9-2855 and TB ORD 193 for general information on extreme cold weather maintenance procedures.

d. Refer to SB 9-16 for information on winterization kit for these vehicles.

370. Extreme Cold Weather Maintenance

Refer to TM 9-2855 for a general discussion of maintenance problems, the application of antifreeze compounds and arctic-type lubrication, handling of storage batteries in extreme cold, and dewinterization procedure.

371. Extreme Hot Weather Maintenance

a. *Cooling System.* Thoroughly clean and flush cooling system (par. 144) at frequent intervals and keep system filled with clean water when operating in extremely high temperatures. Formation of scale and rust in the cooling system occurs more rapidly during operation in extremely high temperatures; therefore, corrosion-inhibitor compound should always be added to the cooling liquid. Avoid the use of water that contains alkali or other substances which may cause scale and rust formations. Use soft water whenever possible.

b. Batteries.

- (1) *Electrolyte level.* In torrid zones, check level of electrolyte in cells daily and replenish, if necessary, with pure distilled water. If this is not available, rain or drinking water may be used. However, continuous use of water with high mineral content will eventually cause damage to batteries and should be avoided.
- (2) *Specific gravity.* Batteries operating in torrid climates should have a weaker electrolyte than for temperate climates. Instead of 1.280 specific gravity as issued, the electrolyte (sulphuric acid, sp gr 1.280) should be diluted to 1.200 to 1.240 specific gravity (TM 9-2857). This is the correct reading for fully-charged batteries. This procedure will prolong the life of the negative plates and separators. Batteries should be recharged at about 1.160 specific gravity.
- (3) *Self-discharge.* A battery will self-discharge at a greater rate if left standing for long periods at high temperatures. This must be considered when operating in torrid zones. If necessary to park for several days, remove the battery and store in a cool place.

Note. Do not store acid-type storage batteries near stacks of tires, as the acid fumes have a harmful effect on rubber.

c. Chassis and Body.

- (1) In hot, dry climates, a careful watch must be kept for evidence of the presence of moths and termites.
- (2) In hot, damp climates, corrosive action will occur on all parts of the vehicle and will be accelerated during the rainy season. Evidence will appear in the form of rust and paint blisters on metal surfaces and mildew, mold, or fungus growth on fabrics, leather, and glass.
- (3) Protect all exposed exterior surfaces from corrosion by touch-up painting and keep a film of engine lubricating oil (OE-10) on unfinished exposed metal surfaces. Cables and terminals should be protected by ignition-insulation compound.
- (4) Make frequent inspections of idle, inactive vehicles. Remove corrosion from exterior metal surfaces with abrasive paper or cloth, and apply a protective coating of paint, oil, or suitable rust-preventive.

372. Maintenance After Fording

a. General. Although the vehicle unit housings are sealed to prevent the free flow of water into the housings, it must be realized that, due to the necessary design of these assemblies, some water may enter, especially during submersion. The following services should be accomplished on all vehicles which have been exposed to some depth of water or completely submerged, especially in salt water. Precautions should be taken as soon as practicable to halt deterioration and avoid damage before the vehicle is driven extensively in regular service.

b. Body and Chassis. Drain and clean out body, engine, and tool compartment; clean all exposed painted surfaces and touchup paint where necessary. Coat unpainted metal parts with engine lubricating oil (OE-10). Lubricate the chassis thoroughly as directed in lubrication chart (par. 69), making sure that the lubricant is forced into each lubrication point to force out any water present.

c. Engine, Transmission, Transfer, and Axles. Check the lubricant in engine, transmission, transfer, and axles. Should there be evidence that water has entered, drain, flush, and refill with the correct lubricant. Service oil filter, replacing element (par. 109).

d. Wheels and Brakes. Remove the front wheels and hubs (par. 266), and flush out the knuckle housings with a half-and-half mixture of engine lubricating oil (OE-10) and dry-cleaning solvent or volatile mineral spirits. Refill to filler plug level (Q, fig. 82) with correct lubricant as prescribed in lubrication chart (par. 69). Remove rear wheels and hubs (par. 266). Wash all wheel bearings thoroughly with dry-cleaning solvent or volatile mineral spirits, after which repack, assemble, and adjust (par. 265). While the wheels are removed, dry

out brake linings, and clean rust and scum from brakedrum face. Check brake system for presence of water.

e. Batteries. Check the batteries for quantity and specific gravity of electrolyte to be sure no water has entered through the vent caps. This is of special importance should the vehicle have been submerged in salt water.

f. Steering Gear. Remove and disassemble steering gear. If the lubricant is contaminated, clean the housing thoroughly with a half-and-half mixture of engine lubricating oil (OE-10) and dry-cleaning solvent or volatile mineral spirits. Assemble, refill with correct lubricant as specified in lubrication chart (par. 69), and then adjust (par. 268).

g. Electrical Connections. Check all electrical connections for corrosion, particularly the bayonet-type connectors.

h. Fuel System. Drain fuel tank of any accumulated water, clean fuel pump filter (par. 133*b*) and lines if necessary. If water is found in the air cleaner, clean and refill with oil (par. 136).

i. Distributor. Remove the distributor cap and check to determine if any water has entered the distributor. If water is present, drain, clean, and lubricate the distributor as required.

j. Condensation. Although most units are sealed, the sudden cooling of the warm interior air upon submersion may cause condensation of moisture within the cases or instruments. A period of exposure to warm air after fording should eliminate this fault. Cases which can be opened may be uncovered and dried.

k. Aluminum or Magnesium Parts. If the vehicle remains in salt water for any appreciable length of time, aluminum or magnesium parts which were exposed to the water will probably be unfit for further use and must be replaced.

l. Deepwater Fording. Refer to TM 9-2853 for deepwater fording information.

373. Maintenance After Operation on Unusual Terrain

a. Mud. Thorough cleaning and lubrication of all parts affected must be accomplished as soon as possible after operation in mud, particularly when a sea of liquid mud has been traversed. Clean radiator fins and interior of engine compartment. Repack wheel bearings if necessary. Clean, oil, and stow tire chains in vehicle.

b. Sand or Dust. Clean engine and engine compartment at least daily. Touch up all painted surfaces damaged by sandblasting. Lubricate completely to force out lubricants contaminated by sand or dust. Air cleaners, and fuel and oil filters must be cleaned at least daily. Make sure that chassis unit vent air cleaner (AV, fig. 88) is cleaned (par. 136*d*) daily. Radiator fins should be cleaned daily with compressed air when operating in dusty terrain.

CHAPTER 4

SHIPMENT AND LIMITED STORAGE AND DESTRUCTION OF MATERIEL TO PREVENT ENEMY USE

Section I. SHIPMENT AND LIMITED STORAGE

374. Domestic Shipping Instructions

a. Preparation for Shipment in Zone of Interior. When shipping the 2½-ton 6 x 6 trucks interstate or within the zone of interior, the officer in charge of preparing shipments *will be responsible* for furnishing vehicles to carriers for transport in a *serviceable* condition, properly cleaned, preserved, painted, and lubricated as prescribed in SB 9-4.

Note. For instructions on loading and blocking these vehicles on flatcars, see paragraphs 376 and 377. On-vehicle-materiel (OVM) will be prepared, packed, and stowed as prescribed in paragraph 376b.

b. Removal of Preservatives Before Shipment. Personnel withdrawing vehicles from limited storage for domestic shipment *must not remove preservatives* other than to insure that the vehicles are complete and serviceable. If it has been determined that preservatives have been removed, they must be restored prior to domestic shipment. The removal of preservatives is the responsibility of depots, ports, and field installations (posts, camps, and stations) receiving the shipments.

c. Preparation for Shipment to Ports (see AR 747-30).

(1) *Inspection.* All used vehicles destined for oversea use will be inspected, prior to shipment, in accordance with TB ORD 385.

(2) *Processing for shipment to ports.* All vehicles destined to ports of embarkation for oversea shipment will be further processed in accordance with SB 9-4.

Note. Ports of embarkation will perform any necessary supplementary or previously omitted processing upon receipt of vehicles, in accordance with AR 747-30.

(3) *Marking of arctic-lubricated materiel.* It will be the responsibility of the officer in charge of the organization performing arctic lubrication to insure that the equipment is marked as prescribed in SR 746-30-10. It will be the responsibility of the officer in charge of the installation ship-

ping arctic-lubricated equipment to insure that each item is so marked. Unit commanders of using organizations will insure that such markings are not obliterated while the equipment is arctic-lubricated. When the equipment is deprocessed of this special lubrication, such markings will be immediately and thoroughly obliterated.

d. Army Shipping Documents. Prepare all Army shipping documents accompanying freight in accordance with TM 38-705.

e. Deepwater Fording. If deepwater fording is anticipated during shipment, prepare vehicles in accordance with TM 9-2853.

375. Limited-Storage Instructions

a. General.

- (1) Vehicles received for storage and already processed for domestic shipment, as indicated on DA Form 9-3, must not be reprocessed, unless inspection, performed on receipt of vehicles, reveals corrosion, deterioration, etc.
- (2) Process vehicles upon receipt directly from manufacturing facilities or if processing data recorded on tag indicates that preservatives have been rendered ineffective by operation or freight-shipping damage.
- (3) Vehicles to be prepared for limited storage must be given a limited technical inspection and processed as prescribed in SB 9-4. Results and classification will be entered on DA Form 461-5.

b. Receiving Inspections.

- (1) Report of vehicles received for storage in a damaged condition or improperly prepared for shipment will be made on DD Form 6, in accordance with SR 745-45-5. Report of vehicles received in an unsatisfactory condition (chronic failure or malfunction) will be made on DA Form 468, in accordance with SR 700-45-5.
- (2) When vehicles are inactivated, they will be processed in accordance with type I as prescribed in SB 9-4. Standby storage will normally be handled by ordnance maintenance personnel only.
- (3) Immediately upon receipt of vehicles for storage, they must be inspected and serviced as prescribed in paragraphs 8 and 9. Perform a systematic inspection and replace or repair all missing or broken parts. If repairs are beyond the scope of the unit and vehicles will be inactivated for an appreciable length of time, store them in a limited storage status and attach tags specifying repairs needed. Report of these conditions will be submitted by the unit commander for action by an ordnance maintenance unit.

c. Inspection During Storage. Perform a visual inspection periodically to determine general condition. If corrosion is found on any part, remove it and clean, paint, and treat with the prescribed preservatives.

Note. Touchup painting will be in accordance with TM 9-2851.

d. Removal From Limited Storage.

(1) If vehicles are not shipped or issued upon expiration of the limited storage period, they will be further treated for standby storage by ordnance maintenance personnel.

(2) If vehicles to be shipped will reach their destination within the limited storage period, they need not be reprocessed upon removal from storage, unless inspection reveals it to be necessary according to anticipated in-transit weather conditions.

Note. All vehicles being reissued through the depot supply system to troops within the continental limits of the United States must meet the requirements of TB ORD 385. This is NOT required for so-called reissues, exchanges, or redistribution among troop units, where the depot supply system is not involved.

(3) Vehicles will be deprocessed, when it has been ascertained that they are to be placed into immediate service. Remove all corrosion-preventive compounds and thoroughly lubricate as prescribed in paragraphs 69 and 70. Inspect and service vehicles as prescribed in paragraphs 8 and 9.

(4) Repair and/or replace all items tagged in accordance with b(3) above.

e. Storage Site. Whenever possible, the preferred type of storage for vehicles is under cover in open sheds or warehouses. When it is found necessary to store vehicles outdoors, the storage site must be selected in accordance with AR 700-105 and vehicles protected against the elements as prescribed in TB ORD 379.

376. Loading the 2½-Ton 6 X 6 Trucks on Railroad Flatcars

a. Preparation.

(1) When vehicles are shipped by rail, every precaution must be taken to see that they are properly loaded and fastened and blocked to floor of flatcar as prescribed in paragraph 377.

(2) Prepare all vehicles for rail shipment in accordance with SB 9-4. On-vehicle-material (OVM) will be thoroughly cleaned, preserved, packed (boxed or crated), and stowed in or on the vehicle as prescribed in b below.

(3) Load vehicle on flatcar so as not to make an unbalanced load. Apply parking brakes and place transmission in neutral position, after vehicle has been finally spotted on flatcar.

(4) Increase tire pressure slightly higher than normal, except where shipment is to be exposed to extreme hot weather conditions.

- (5) If vehicle is equipped with steel toolboxes, remove all padlocks and keys from vehicle in order to prevent pilferage while in transit and secure lids of steel toolboxes by wiring hasp to prevent damage during shipment. Preserve padlocks and keys with preservative engine oil (grade 1); wrap in greaseproof barrier-material for domestic shipment or in a waterproof-greaseproof wrapping or bag for oversea shipment. Locate all wrapped padlocks and keys in shipping container with accessories.

b. On-Vehicle-Material (OVM) Requirements.

- (1) *General.* Preserve and package all OVM individually, except items used as sets or in quantities greater than one.

- (2) *Battery and electrolyte.*

- (a) If the material is to be shipped within the continental limits of the United States, *except* directly to ports of embarkation, disconnect the battery cables from battery, clean ((b) low), if necessary, and coat cable terminals with automotive and artillery grease (GAA). Tape cable terminals and battery posts with nonhygroscopic adhesive tape. Secure terminals *away* from battery.

- (b) If materiel is to be shipped directly to ports of embarkation, except when it is to be combat-loaded, disconnect battery cables and remove batteries. Plug vents and clean outside of batteries with a solution containing $\frac{1}{2}$ pound of commercial-grade baking soda (sodium bicarbonate) to 1 gallon of water. Rinse with cool water and remove vent plugs. Scrape or wire-brush and clean cable terminals and battery box (holder) with this cleaning solution, rinse with cool water, coat terminals with automotive and artillery grease (GAA), and cover with nonhygroscopic adhesive tape. Paint battery boxes, if required, with black acid-resisting paint. Battery and electrolyte will be packed in accordance with TM 9-2857 and TM 9-1005 and shipped in vehicle, separate from other OVM.

- (3) *Publications.* Package publications in accordance with Method IC-3, "Waterproof bag, sealed," using heavy duty, type 1, heat-sealable, grade A, waterproof class B bags. Pack in the OVM container. Publications provided by separate technical services will be packed in the same exterior OVM containers as the items to which they are applicable.

- (4) *Unit packages.* Unit packages that are not water-resistant and are impracticable for intermediate packaging will be overwrapped in flexible, waterproof barrier-material and sealed with waterproof water-resistant adhesive.

- (5) *Intermediate packages.* Whenever possible, unit packages of related items will be made into intermediate packages in fiber-

board cartons. Container closure will be made by sealing all seams with water-resistant, gummed paper tape. When the gross weight exceeds 20 pounds, the container will be sealed with water-resistant adhesive, in addition to being sealed with tape.

(6) *Exterior containers.*

- (a) Keep the number of exterior containers to a minimum. The size will be governed by the cubic displacement of the packaged OVM. Dimensions will be such that, when assembled in sets as required and stowed on vehicle, the overall cubage of the vehicle will not be increased and lifting devices will not be obstructed.
- (b) Place heavy materiel or equipment in the bottom of exterior containers and block and brace, as necessary, so that they will not damage other contents. Pack fragile materiel and canvas items above other OVM items at the top of the container; in addition, pack canvas covers for OVM items in the same exterior containers with the items for which they are intended.
- (c) Pack unit and intermediate packages in style 2, unlined, snug-fitting, nailed wood boxes, for a type III load, modified as prescribed in 1 through 5 below.
 1. Exterior containers over 200-pounds gross weight will have nominal 2 x 4 end cleats; also, beveled end skids of nominal 2 x 4 lumber, will be placed flat, parallel to the ends of the containers, and spaced approximately 6 inches from each end, with span between skids not to exceed 36 inches.
 2. The skids will be fastened to the bottom with nails driven through the floor into the skid member. Nails will be of sufficient length and size to achieve maximum holding power.
 3. Additional battens, when required, will be fastened to the inside faces of the top and side panels and to the inside face of the bottom panel, when skids are not required.
 4. Construct the container top of matched lumber and nail to the side and end panels. The container will be weather-proofed, strapped, and marked in accordance with TM 9-1005.

Note. Weatherproofing of container tops will not be necessary, if containers are to be stowed within the vehicle.

5. Cover exterior surfaces of all OVM exterior containers (except tops) with one coat of olive drab enamel.

Note. OVM containers stowed within the vehicle will not require painting.

(7) *Stowage.*

- (a) Stow all OVM containers inside the body or other suitable location, without increasing the cubic displacement of the vehicle. Strap, block, or brace all OVM containers to prevent free movement.

Note. OVM containers must receive maximum protection against corrosion, deterioration, and mechanical damage during shipment and prolonged periods of storage.

- (b) OVM containers without skids, which are to be stowed in exposed locations in contact with platforms, floors, or other boxes, will be placed on nominal 1 x 4 wood cleats to minimize surface contact. Secure cleats in a manner that will prevent shifting or damage to contact surfaces.

c. Method of Loading the 2½-Ton 6 x 6 Trucks on Flatcars. For method of loading and general loading rules pertaining to rail shipment of ordnance vehicles, see TB 9-OSSC-G.

Warning: The height and width of vehicles, when prepared for rail transportation, must not exceed the limitations indicated in the loading table in AR 700-105 (section II). Whenever possible, local transportation officers must be consulted about the limitations of the particular railroad lines to be used for the movement in order to avoid delays, dangerous conditions, or damage to equipment.

377. Blocking the 2½-Ton 6 X 6 Trucks on Railroad Flatcars

a. General. All blocking instructions specified herein are minimum and are in accordance with "Pamphlet No. MD-7, Rules Governing the Loading of Department of Defense Materiel on Open Top Cars" of the Association of American Railroads. Additional blocking may be added, as required, at the discretion of the officer in charge. Double-headed nails may be used, except in the lower piece of two-piece cleats. All item reference letters given in *b* through *f* below refer to the details and locations shown in figure 392.

Note. Any other loading instructions, regardless of source, which appear to be in conflict with this publication or existing loading rules of the carriers, must be submitted for approval to the Chief of Ordnance, Washington 25, D. C.

b. Brake Wheel Clearance "A." Load vehicles on flatcars, with a minimum clearance of at least 4 inches below and 6 inches above, behind, and to each side of the brake wheel. Any increase in clearance must be consistent with proper location of load.

c. Chock Blocks "B" (6 x 8 x 24 In., Eight Required). Locate the 45° surface of blocks against the front and rear of each front wheel, against the front of each outside intermediate wheel, and against the rear of each outer rear wheel. Nail heel of blocks to car floor with

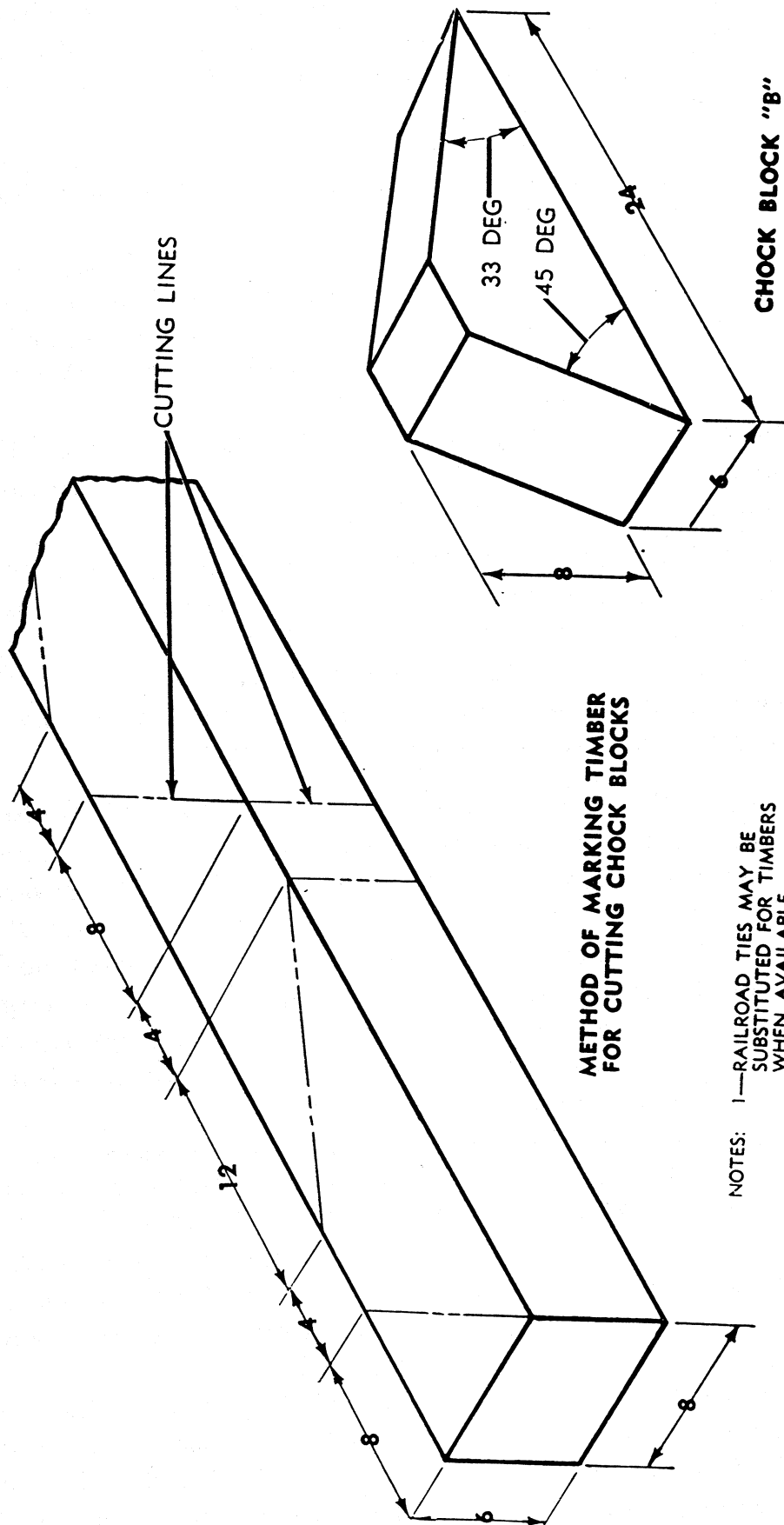

**METHOD OF MARKING TIMBER
FOR CUTTING CHOCK BLOCKS**

- NOTES: 1—RAILROAD TIES MAY BE
SUBSTITUTED FOR TIMBERS
WHEN AVAILABLE
2—ALL DIMENSIONS SHOWN
ARE IN INCHES

CHOCK BLOCK "B"

RA PD 115824C

Figure 391. Cutting chock blocks from timbers.

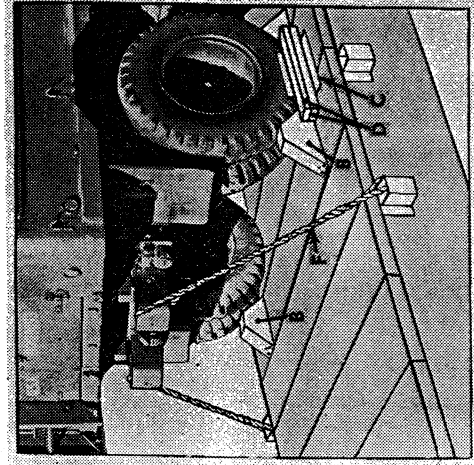

**DETAIL A
VEHICLE TIE DOWN
(REAR)**

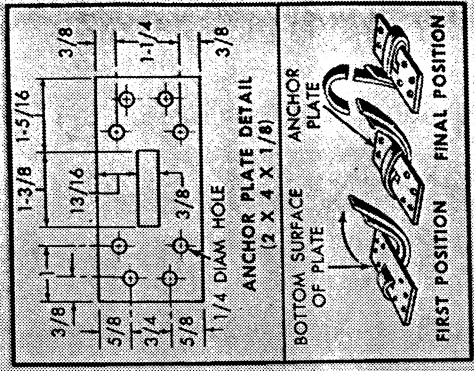

**DETAIL B
METHOD OF THREADING
ANCHOR PLATE**

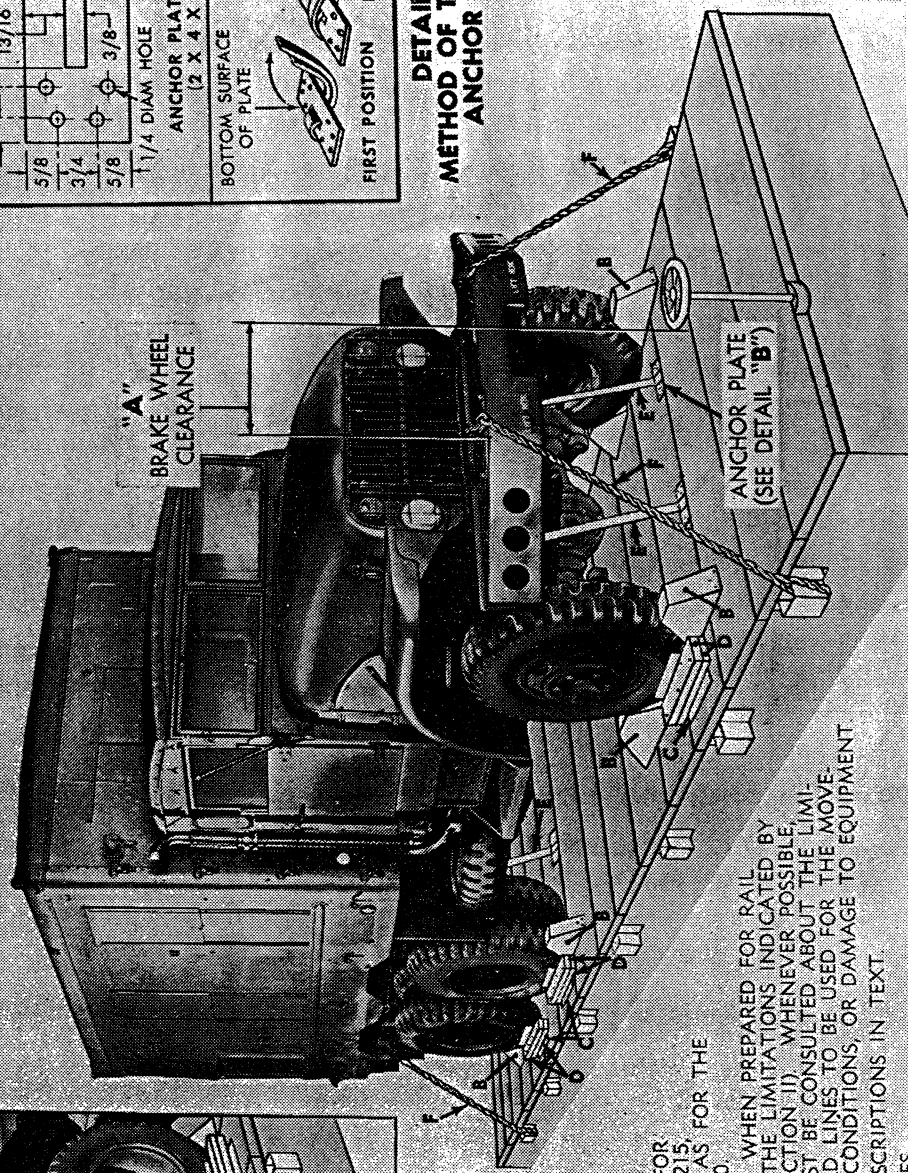

- NOTES:
- 1-THE 2-1/2-TON, 6X6 SHOP-VAN TRUCK M220 ILLUSTRATED HAS NOT BEEN PROCESSED FOR DOMESTIC FREIGHT SHIPMENT BUT SIMPLY ILLUSTRATES METHOD OF BLOCKING. BLOCKING INSTRUCTIONS FOR THE 2-1/2-TON TRUCKS M135, M211, M215, M217, M221 AND M222 ARE THE SAME AS FOR THE 2-1/2-TON, 6X6 SHOP-VAN TRUCK M220.
 - 2-THE HEIGHT AND WIDTH OF MATERIEL WHEN PREPARED FOR RAIL TRANSPORTATION MUST NOT EXCEED THE LIMITATIONS INDICATED BY THE LOADING TABLE IN AR 700.105 (SECTION II), WHENEVER POSSIBLE. LOCAL TRANSPORTATION OFFICERS MUST BE CONSULTED ABOUT THE LIMITATIONS OF THE PARTICULAR RAILROAD LINES TO BE USED FOR THE MOVEMENT TO AVOID DELAYS, DANGEROUS CONDITIONS, OR DAMAGE TO EQUIPMENT.
 - 3-ITEM REFERENCE LETTERS REFER TO DESCRIPTIONS IN TEXT.
 - 4-ALL DIMENSIONS SHOWN ARE IN INCHES.

RAPD 212029

Figure 392. Method of blocking the 2 1/2-ton 6 x 6 trucks on flatcars.

three forty-penny nails and toenail both sides of block to car floor with two forty-penny nails each.

Note. Chock blocks may be cut from timber (or railroad ties, when available), as shown in figure 391.

d. Wheel Side Cleats "D" (2 x 4 x 36 In., 12 Required) and Cushioning Material "C." Locate suitable cushioning material, such as waterproof paper or burlap against tire and on floor. Locate one cleat on top of the cushioning material, flush against the outside of each tire (the cushioning material should protrude 2 inches beyond cleat at floor and 2 inches above cleats at side of tire), and secure to the car floor with four thirty-penny nails, staggered. Place another cleat on top of each lower cleat and secure to the lower cleat with four thirty-penny nails, staggered.

e. Axle Strapping "E" (Six 1-In. No. 14 BW Gage Hot-Rolled Steel Band, Length to Suit, and 12 Steel Anchor Plates). Pass two steel bands over each axle, one near each wheel, and pass each end through a steel anchor plate. Secure each steel anchor plate to the car floor with eight twenty-penny cement-coated nails.

Note. Four strands of No. 8 gage, black annealed wire, twisted to form a cable, may be substituted for each band, if desired; secure each cable to car floor with a 2 x 4 x 18-inch wood cleat nailed lengthwise to car floor with four thirty-penny nails.

f. Vehicle Tiedown "F" (Four Strands, No. 8 Gage, Black Annealed Wire or Wires of Equivalent Strength, Length to Suit). Twist-tie wires together to form four cables. Pass one end of each cable through a stake pocket on opposite sides of the vehicle and form a six-inch loop in end, winding each of the four wires tightly around the cable. Extend the loop of the cable around and up to a point above the stake pocket. Pass the other end of each front cable through a towing eye in front of the vehicle and down through the loop at the other end of cable; tighten the four strands of wire around the cable, forming a "loop around a loop." Twist-tie cables to remove slack. Pass the ends of each rear cable through the bumper as shown in figure 392, detail A, and tighten in a similar manner to front cables.

Section II. DESTRUCTION OF MATERIEL TO PREVENT ENEMY USE

378. General

a. Destruction of the 2½-ton 6 x 6 cargo truck M135, when subject to capture or abandonment in the combat zone, will be undertaken by the using arm only when, in the judgment of the unit commander concerned, such action is necessary in accordance with orders of, or policy established by, the army commander.

b. The information which follows is for guidance only. Certain of the procedures outlined require the use of explosives and incendiary

grenades which normally may not be authorized items for the vehicle. The issue of these and related materials, and the conditions under which destruction will be effected, are command decisions in each case, according to the tactical situation. Of the several means of destruction, those most generally applicable are:

Mechanical—Requires axe, pick mattock, sledge, crowbar, or similar implement.

Burning —Requires gasoline, oil, incendiary grenades, or other flammables.

Demolition—Requires suitable explosives or ammunition.

Gunfire —Includes artillery, machineguns, rifles using rifle grenades, and launchers using antitank rockets. Under some circumstances, hand grenades may be used.

In general, destruction of essential parts, followed by burning will usually be sufficient to render the 2½-ton 6 x 6 cargo trucks useless. However, selection of the particular method of destruction requires imagination and resourcefulness in the utilization of the facilities at hand under the existing conditions. Time is usually critical.

c. If destruction to prevent enemy use is resorted to, the truck must be so badly damaged that it cannot be restored to a usable condition in the combat zone either by repair or cannibalization. Adequate destruction requires that all parts essential to the operation of the materiel, including essential spare parts, be destroyed or damaged beyond repair. However, when lack of time and personnel prevents destruction of all parts, priority is given to the destruction of those parts most difficult to replace. Equally important, the same essential parts must be destroyed on all like materiel so that the enemy cannot construct one complete unit from several damaged ones.

d. If destruction is directed, due consideration should be given to:

- (1) Selection of a point of destruction that will cause greatest obstruction to enemy movement and also prevent hazard to friendly troops from fragments or ricocheting projectiles which may occur incidental to the destruction.
- (2) Observance of appropriate safety precautions.

379. Method No. 1—Destruction by Burning

a. Remove and empty portable fire extinguisher.

b. Using an axe, pick mattock, sledge, or other heavy implement, smash all vital elements such as distributor, carburetor, generator, ignition coil, fuel pump, batteries, spark plugs, air cleaner, lights, instruments, and controls. If time permits, and a sufficiently heavy implement is available, smash the engine cylinder block and head, crankcase, and transmission control tower.

Slash tires. If tires are inflated, exercise care to prevent injury to the tire blow out while being slashed. Whenever practicable, it is preferable to deflate tires before slashing.

d. Remove drain plug or puncture the fuel tank as near the bottom as possible, collecting gasoline for use as outlined in *f* below.

e. Explosive ammunition, if present in the vehicle or available nearby, should be removed from packing or other protective material. Place ammunition in and about the vehicle so that it will be fully exposed to the fire and in such locations that the greatest damage will result from its detonation. Remove any safety devices from the ammunition.

f. With the doors and hood open to admit air for combustion, pour gasoline and oil in and over the entire vehicle. Ignite by means of an incendiary grenade fired from a safe distance, by a burst from a flame-thrower, a combustible train of suitable length, or other appropriate means. Take cover immediately.

Caution: Cover must be taken without delay since an early explosion of the explosive ammunition, if present, may be caused by the fire. Due consideration should be given to the highly flammable nature of gasoline and its vapor. Carelessness in its use may result in painful burns.

If explosive ammunition is present on the vehicle, the danger zone is 250 yards. Elapsed time: about 6 minutes.

380. Method No. 2—Destruction by Demolition

a. Remove and empty portable fire extinguisher.

b. Smash all vital elements as outlined in 379b.

c. Planning for simultaneous detonation, prepare two 2-pound charges of EXPLOSIVE, TNT (two 1-lb blocks or equivalent per charge together with the necessary detonating cord to make up each charge). Set the charges as in (1) and (2) below.

(1) The first on top of the transmission case housing.

(2) The second as low on the left side of the engine as possible.

d. Connect the charges for simultaneous detonation with detonating cord.

e. Provide for dual priming to minimize the possibility of a misfire. For priming, either a nonelectric blasting cap crimped to at least 5 feet of safety fuse (safety fuse burns at the rate of 1 ft in aprx 40 sec; test before using) or an electric blasting cap and firing wire may be used. Safety fuse, which contains black powder, and nonelectric blasting caps must be protected from moisture at all times. The safety fuse may be ignited by a fuse lighter or a match; the electric blasting cap requires a blasting machine or equivalent source of electricity.

Caution: Keep the blasting caps, detonating cord, and safety fuse separated from the charges until required for use.

Note. For the successful execution of methods of destruction involving the use of demolition materials, all personnel concerned will be thoroughly familiar with the pertinent provisions of FM 5-25. Training and careful planning are essential.

f. Destroy the tires by placing an incendiary grenade under each tire. The detonation of the explosive charges should be delayed until the incendiary fires are well started. This will prevent the fires from being extinguished by the blast when the charges are detonated.

g. Detonate the charges. If primed with nonelectric blasting cap and safety fuse, ignite and take cover. If primed with electric blasting cap, take cover before firing.

Caution: Cover must be taken without delay since an early explosion of the charges may be caused by the incendiary fires. The danger zone is approximately 250 yards. Elapsed time: about 6 minutes.

381. Method No. 3—Destruction by Gunfire

a. Remove and empty portable fire extinguisher.

b. Ordinarily destruction of the tires is affected incidental to and in conjunction with the destruction of the vehicle by gunfire. However, if such destruction is not practicable, destroy the tires as directed in paragraph 379c or 380f.

c. Drain or puncture the fuel tanks, unless incendiary grenades are to be used to destroy the tires.

d. Destroy the vehicle by gunfire using artillery, machineguns, rifles using rifle grenades, or launchers using antitank rockets. Fire on the vehicle aiming at the engine, axles, wheels, and body. Although one well-placed direct hit may render the vehicle temporarily useless, several hits are usually required for complete destruction unless an intense fire is started, in which case the vehicle may be considered destroyed.

Caution: Firing artillery at ranges of 500 yards or less should be from cover. Firing rifle grenades or antitank rockets should be from cover.

Elapsed time: about 6 minutes.

APPENDIX

REFERENCES

1. Publication Indexes

Special regulations in the 310-20-series, DA pamphlets of the 310 series, Pam 108-1, and FM 21-8 should be consulted frequently for latest changes or revisions of references given in this appendix and for new publications relating to materiel covered in this manual.

2. Supply Manuals

The following manuals of the Department of the Army supply manual pertain to this materiel:

a. Destruction to Prevent Enemy Use.

Land Mines and Components; Demolition Explosives ORD 3 SNL R-7 and Related Items; and Ammunition for Simulated Artillery, Booby Trap, Hand Grenade, and Land Mine Fire.

b. Maintenance and Repair.

Cleaners, Preservatives, Lubricants, Recoil Fluids, Special Oils, and Related Maintenance Materials. ORD 3 SNL K-1
Items of Soldering, Metallizing, Brazing, and Welding Materials; Gases and Related Items. ORD 3 SNL K-2
Lubricating Equipment, Accessories, and Related Dispensers. ORD (*) SNL K-3
Lubricating Fittings, Oil Filters, and Oil Filter Elements. ORD 5 SNL H-16

c. Vehicle.

Trucks, 2½-Ton, 6 x 6, Cargo M135 and M211; Dump M215; Gasoline Tank M217; Shop Van M220; Tractor M221; and Water Tank M222. ORD (*) SNL G-749

d. General.

Index of Supply Manuals—Ordnance Corps----- Pam 310-29
Index of Technical Manuals, Technical Regulations, Technical Bulletins, Supply Bulletins, Lubrication Orders, and Modification Work Orders. Pam 310-4
Introduction----- ORD 1

3. Forms

The following forms pertain to this materiel:

Standard Form 91. Operator's Report of Motor Vehicle Accident (Card)

(*) See Pam. 310-29, Index of Supply Manuals—Ordnance Corps, for published types of manuals of the Ordnance section of the Department of the Army Supply Manual.

DA Form 285	Accident (report of individual accident)
DA Form 1208	Report of Claims Officer
Standard Form 94.	Statement of Witness
DA Form 9-3	Processing Record for Shipment and Storage of Vehicles and Boxed Engines (Tag)
DA Form 9-4	Vehicular Storage and Servicing Record (Card)
DA Form 9-68	Spot Check Inspection Report for Wheeled and Half-Track Vehicles.
DA Form 9-75	Daily Dispatching Record of Motor Vehicles
DA Form 348	Driver Qualification Record
DA Form 446	Issue Slip
DA Form 460	Preventive Maintenance Roster
DA Form 461	Preventive Maintenance Service and Inspection for Wheel and Half-Track Vehicles
DA Form 461-5	Limited Technical Inspection
DA Form 468	Unsatisfactory Equipment Report
DA Form 478	Organizational Equipment File
DA Form 811	Work Request and Job Order
DD Form 6	Report of Damaged or Improper Shipment
DD Form 110	Vehicle and Equipment Operational Record
DD Form 313	U. S. Government Operator's Permit
DD Form 317	Preventive Maintenance Service
DD Form 518	Accident-Identification Card
DA Form 1089	Claim for Property

4. Other Publications

The following explanatory publications contain information pertinent to this materiel and associated equipment :

a. Ammunition.

Safety: Regulations for Firing Ammunition for SR 385-310-1
Training, Target Practice and Combat.
Ammunition for Training----- TA 23-100
Supply Control: Distribution of Ammunition for AR 710-1300-1
Training.

b. Camouflage.

Camouflage, Basic Principles----- FM 5-20
Camouflage of Vehicles----- FM 5-20B

c. Decontamination.

Decontamination ----- TM 3-220
Defense Against CBR Attack----- FM 21-40

d. Destruction to Prevent Enemy Use.

Explosives and Demolitions----- FM 5-25

e. General.

Basic Artic Manual----- FM 31-70
Cold Weather Lubrication: Operation and Maintenance of Artillery and Sighting and Fire Control Materiel. TB ORD 193
Cooling Systems: Vehicles and Powered Ground Equipment. TM 9-2858
Driver's Manual----- TM 21-305

Driver Selection and Training-----	TM 21-300
Instruction Guide: Operation and Maintenance of Ordnance Materiel in Extreme Cold (0° to -65° F.).	TM 9-2855
Lubrication Order-----	LO 9-8024
Motor Transportation, Operations-----	FM 25-10
Mountain Operations-----	FM 70-10
Operations in the Arctic-----	FM 31-71
Precautions in Handling Gasoline-----	AR 850-20
Preparation of Ordnance Materiel for Deepwater Fording.	TM 9-2853
Principles of Automotive Vehicles-----	TM 9-2700
Safety: Prevention of Motor Vehicle Accidents---	AR 385-55
Safety: Accident Reporting-----	SR 385-10-40
Spark Plugs-----	TB ORD 313
Storage Batteries, Lead-Acid-Type-----	TM 9-2857
Supplies and Equipment: Motor Vehicles-----	AR 700-105
Supplies and Equipment: Unsatisfactory Equip- ment Report.	SR 700-45-5

f. Maintenance and Repair.

Abrasives, Cleaning, Preserving, Sealing, Adhesive, and Related Materials Issued for Ordnance Materiel.	TM 9-850
Fire Control Materiel: Lubrication (if appli- cable).	TB 9-2835-1
General Supply: Winterization Equipment for Automotive Materiel.	SB 9-16
Instruction Guide: Care and Maintenance of Ball and Roller Bearings.	TM 37-265
Lubrication-----	TM 9-2835
Lubrication Order-----	LO 9-8024
Maintenance and Care of Hand Tools-----	TM 9-867
Maintenance and Care of Pneumatic Tires and Rubber Treads.	TM 31-200
Maintenance of Supplies and Equipment: Maintenance Responsibilities and Shop Opera- tion.	AR 750-5
Painting Instructions for Field Use-----	TM 9-2851

g. Shipment and Limited Storage.

Army Shipping Document-----	TM 38-705
Instruction Guide: Ordnance Packaging, Preser- vation, Packing, Storage, and Shipping.	TM 9-1005
Marking and Packing of Supplies and Equipment: Marking of Oversea Supply.	SR 746-30-5
Marking and Packing of Supplies and Equipment: Marking of Arctic-Lubricated Material and Equipment.	SR 746-30-10
Military Standard, Marking of Shipments-----	MIL STD 129**
Ordnance Storage and Shipment Chart—Group G Items and Major Combinations of Group G.	TB 9-OSSC-G

**Copies may be obtained from Aberdeen Proving Ground, Aberdeen, Maryland.

Preparation of Supplies and Equipment: Process- AR 747-30
ing of Unboxed and Uncrated Equipment for
Oversea Shipment.

Preservation, Packaging, and Packing of Mili- TM 38-230
tary Supplies and Equipment.

Processing of Motor Vehicles and Related Unboxed SB 9-4
Materiel for Shipment and Storage.

Protection of Ordnance General Supplies in Open TB ORD 379
Storage.

Shipment of Supplies and Equipment: Report of SR 745-45-5
Damaged or Improper Shipment.

Standards for Oversea Shipment and Domestic TB ORD 385
Issue of Ordnance Materiel Other than Ammu-
nition and Army Aircraft.

INDEX

	<i>Paragraph</i>	<i>Page</i>
Accelerator pedal.....	14, 128d	45, 230
Accessory drive. (See Power-take-off and accessory drive.)---		
Adjustments:		
Belt:		
Air compressor drive.....	247	454
Fan.....	145b	264
Brake, mechanical parking.....	254	467
Brake pedal linkage.....	241b	444
Brakes, service.....	238	439
Cab mounting.....	292b	521
Carburetor.....	127b	228
Control valve, windshield wiper.....	295b	531
Cowl ventilator.....	300b	542
Distributor points.....	123a	219
Doors, cab.....	299b	540
End gate controls (dump body).....	327b	584
Front band (transmission).....	201	352
Governor:		
Air compressor.....	246b	451
Engine.....	129c	235
Headlights, service.....	161	294
Hoist control, dump body.....	324	580
Hood, engine.....	303c	545
Manifold heat control.....	135	247
Manual shift linkage (transmission).....	202c	355
Mirrors, outside rear view.....	296d	533
Power-take-off accessory drive control linkage (tank bodies).....	346b	622
Starter control linkage.....	152	275
Steering gear.....	268	486
Throttle linkage (transmission).....	202b	355
Toe-in (front wheel).....	220	408
Valve clearance, engine.....	110	186
Wheel bearing.....	265	479
Winch.....	316	564
Windshield.....	294b	529
Air cleaners, engine.....	134	245
Air compressor.....	248	456
Air compressor governor.....	246	451
Air-hydraulic cylinder (brake).....	243	447
Air pressure gage.....	32, 176	51, 321
Air reservoirs.....	249	458
Alinement:		
Frame.....	284	514
Front axle.....	216	401
Auxiliary power outlet (early M135).....	170	316

	<i>Paragraph</i>	<i>Page</i>
Axle, front:		
Alinement.....	216	401
Axle assembly replacement.....	222	413
Axle shaft and universal joint replacement.....	221	409
Data.....	215b	401
Description.....	215a	399
Differential lubricant checking, draining, and filling.....	217	404
Drive shift linkage.....	208	386
Housing outer seals.....	218	404
Tie-rod.....	219	407
Toe-in adjustment.....	220	408
Troubleshooting.....	93	170
Axle shaft and universal joint (front axle).....	221	409
Axle shafts (rear axles).....	225	418
Axles, rear:		
Axle shafts.....	225	418
Data.....	223b	416
Description.....	223a	416
Differential lubricant checking, draining, and filling.....	224	418
Forward rear axle replacement.....	226	419
Rear rear axle replacement.....	227	421
Troubleshooting.....	94	171
Band:		
Brake (mechanical parking).....	255	467
Brake (winch).....	317	565
Batteries.....	159	289
Batteries and lighting system:		
Batteries.....	159	289
Blackout headlight.....	162	300
Data.....	158	288
Description.....	157	286
Extreme-hot weather maintenance (batteries).....	371	654
Front marker lights.....	163	301
Instrument panel lights.....	165	303
Service headlights.....	161	294
Slave battery receptacle.....	160	293
Stop and taillights.....	164	302
Troubleshooting.....	88	160
Use of lights.....	45	66
Bayonet-type connectors (electrical).....	169	315
Bearings, wheel.....	265	479
Belt:		
Air compressor drive.....	247	454
Fan.....	145	264
Blackout headlight.....	162	300
Bleeding brake system.....	237	437
Blower, exhaust (shop van body).....	364	649
Body:		
Cargo. (See Cargo body.)		
Dump. (See Dump body.)		
Gasoline tank. (See Gasoline tank body.)		
Shop van. (See Shop van body.)		
Water tank. (See Water tank body.)		

	<i>Paragraph</i>	<i>Page</i>
Brakedrums.....	240	443
Brakeshoes.....	239	439
Brake system, parking:		
Brake band and lining.....	255	467
Data.....	253c	466
Description.....	253	466
Linkage (mechanical).....	256	469
Mechanical parking brake adjustment.....	254	467
Temporary parking brake switch.....	181	323
Temporary parking brake valve.....	257	470
Use (mechanical).....	42	61
Use (temporary).....	43	61
Brake system, service:		
Air compressor.....	248	456
Air compressor governor.....	246	451
Air-hydraulic cylinder.....	243	447
Air reservoirs and safety valve.....	249	458
Bleeding system.....	237	437
Brake adjustment for normal wear.....	238	439
Brakedrums.....	240	443
Brakeshoes.....	239	439
Data.....	235	434
Description.....	234a	433
Drive belt, air compressor.....	247	454
Lines and connections.....	245	449
Master cylinder.....	242	446
Operation.....	234b	433
Pedal and linkage.....	241	444
System tests.....	236	435
Trailer brake hand control valve.....	251	463
Trailer brake service line double check valve.....	252	465
Trailer connections.....	250	460
Troubleshooting.....	96	172
Use.....	41	61
Wheel cylinders.....	244	448
Brakes:		
Hydraulic. (See Brake system, service.)		
Trailer (use of).....	44	62
Breather, crankcase.....	114c	201
Brush guard.....	305	550
Bumper, front.....	285	515
Bumpers, rear.....	286	517
Button, horn.....	185	328
Buzzer, low air pressure.....	186	330
Cab and associated parts:		
Cab mountings.....	292	521
Companion seat.....	298	536
Cowl ventilator.....	300	542
Description.....	291	521
Doors.....	299	540
Driver's seat.....	297	535
Pioneer and vehicle tool stowage.....	301	543
Rear view mirrors.....	296	533

Cab and associated parts—Continued	<i>Paragraph</i>	<i>Page</i>
Roof paulin and rear curtain.....	293	524
Troubleshooting.....	102	176
Windshield.....	294	529
Windshield wipers and controls.....	295	531
Cable, winch.....	318	567
Capacitors:		
Distributor breaker point.....	123c	221
Distributor coaxial.....	189c	332
Fuel pump.....	192b	334
Ignition coil.....	189b	332
Starter.....	191b	334
Carburetor.....	127	228
Carburetor controls.....	128	230
Cargo body:		
Description.....	307	553
Mounting.....	308	553
Racks and seats.....	310	559
Splash shields.....	312	560
Tailgate.....	311	559
Top bows and paulin.....	309	557
Carrier, spare wheel.....	262	474
Caution plates.....	6	24
Charging batteries.....	159e	290
Chart, lubrication.....	69	117
Check valve, trailer brake service line.....	252	465
Choke control.....	22, 128b	49, 230
Circuit breakers.....	171d, 184	318, 326
Circuits and connections (electrical).....	167	308
Coil, ignition.....	123f	226
Common tools and equipment.....	67	113
Companion seat.....	298	536
Compression test, engine.....	111a	188
Compressor, air.....	248	456
Control box, dump body hoist.....	335	595
Control tower, transmission.....	203	363
Controls and instruments (location and purpose).....	12-35	44
Cooling system:		
Cleaning and flushing.....	144	262
Data.....	141b	259
Description.....	141a	259
Draining and filling.....	142	259
Fan and drive belt.....	145	264
Radiator.....	146	264
System tests.....	143	260
Thermostat.....	147	266
Troubleshooting.....	85	159
Water hose, lines, and fittings.....	149	270
Water pump.....	148	268
Coupling, trailer brake.....	250	460
Cowl ventilator.....	300	542
Crankcase ventilation system.....	114	199
Curtain, cab rear.....	293	524
Cylinder, air-hydraulic (brake).....	243	447

	<i>Paragraph</i>	<i>Page</i>
Cylinder head, engine.....	113	191
Cylinder:		
Hydraulic (dump body hoist).....	328	585
Master (brake).....	242	446
Cylinders, wheel (brake).....	244	448
Data, tabulated (vehicle).....	7	37
Description (vehicle).....	4	5
Destruction of materiel to prevent enemy use:		
General.....	378	665
Method:		
No. 1—Destruction by burning.....	379	666
No. 2—Destruction by demolition.....	380	667
No. 3—Destruction by gunfire.....	381	668
Diagrams, wiring circuit.....	166	303
Differences between models.....	5	22
Differential. (See Axle, front or axles, rear.)		
Dimmer switch.....	182	324
Distributor and ignition coil.....	123	219
Dome lights, shop van body.....	365	650
Doors, cab.....	299	540
Drag link, steering.....	269	489
Drain valves and controls:		
Gasoline tank body.....	355	637
Water tank body.....	343	609
Draining cooling system.....	142b	260
Drive line, winch.....	319	567
Driver's seat.....	297	535
Drive shaft, dump body power-take-off.....	337	599
Drums, brake.....	240	443
Dump body:		
Body and subframe mountings.....	326	583
Control box.....	335	595
Control valve.....	334	593
Control valve adapter.....	333	592
Controls.....	50	77
Crosshead roller arms.....	329	588
Crossover adapter.....	332	591
Data.....	323c	577
Description.....	323b	577
End gate and controls.....	327	584
Hoist control adjustments.....	324	580
Hoist crosshead.....	330	590
Hoist pump.....	331	591
Hydraulic cylinder.....	328	585
Hydraulic fluid system.....	325	581
Operation.....	51	78
Power-take-off and hoist control linkage.....	336	595
Power-take-off drive shaft.....	337	599
Troubleshooting.....	104	177
Engine:		
Checking, draining, and filling crankcase.....	108	182
Compression and vacuum tests.....	111	188
Crankcase ventilation system.....	114	199

	<i>Paragraph</i>	<i>Page</i>
Engine—Continued		
Cylinder head.....	113	191
Data.....	107b	181
Description.....	107a	180
Installation.....	119	209
Intake and exhaust manifolds.....	112	189
Mountings.....	115	202
Oil filter.....	109	183
Removal.....	118	207
Starting.....	37a	54
Stopping.....	37b	54
Troubleshooting.....	81	152
Valve clearance adjustment.....	110	186
Warmup.....	38	54
Exhaust blower, shop van body.....	57d, 364	101, 649
Exhaust heater system (water tank body).....	347	623
Exhaust system:		
Description.....	137	249
Exhaust pipes.....	138	251
Muffler.....	139	254
Tailpipes.....	140	255
Troubleshooting.....	84	159
Extinguisher, fire.....	58	105
Fan, radiator.....	145	264
Fenders:		
Front.....	304	548
Tractor truck.....	290	519
Fifth wheel, tractor (operation).....	56	97
Filler cover, water tank body.....	341	605
Filling cooling system.....	142a	259
Filler, oil (engine).....	109	183
Filters, fuel pump.....	133	243
Fire extinguisher.....	58	105
Fluid system, dump body hydraulic.....	325	581
Fording.....	64	111
Forms, records, and reports.....	3	4
Frame:		
Alinement.....	284	514
Bumper, front.....	285	515
Bumpers, rear.....	286	517
Description.....	283	514
Pintle.....	288	518
Tie-down U bolts.....	289	519
Towing shackles.....	287	518
Tractor truck rear fenders.....	290	519
Front axle. (See Axle, front.)		
Fuel and air intake system:		
Air cleaners.....	134	245
Carburetor.....	127	228
Carburetor controls.....	128	235
Data.....	126	227
Description and operation.....	125	226
Fuel primer pump.....	131	238

Fuel and air intake system—Continued		
	<i>Paragraph</i>	<i>Page</i>
Fuel pump.....	133	243
Fuel tank and lines.....	132	239
Governor:		
Engine.....	129	234
Power-take-off (Mechanovac).....	130	236
Manifold heat control.....	135	247
Radio interference suppression (fuel pump).....	192	334
Troubleshooting.....	83	158
Unit vent and breather lines.....	136	248
Fuel gage.....	174	320
Fuel pump.....	133	243
Fuse link, gasoline tank body drain valve operator.....	355 <i>h</i>	637
Gages:		
Air pressure.....	32, 176	51, 321
Fuel.....	33, 174	51, 320
Oil pressure.....	31, 173	51, 319
Temperature.....	30, 175	51, 321
Gages and sending units.....	171 <i>b</i>	317
Gasoline tank body:		
Controls and equipment.....	54	92
Data.....	350 <i>b</i>	632
Description.....	350 <i>a</i>	632
Drain pipe manifold.....	356	641
Gas-freeing the tank.....	351	633
Manhole covers.....	353	633
Mounting.....	352	633
Operation (pump).....	55	93
Power-take-off accessory drive control linkage.....	359	643
Pump.....	357	642
Pump propeller shafts.....	358	642
Troubleshooting.....	106	179
Gate, end (dump body).....	327	584
Gate, tail (cargo body).....	311	559
Gate valves:		
Exhaust heater.....	349	630
Gasoline tank body.....	354	636
Water tank body.....	342	607
Gear, steering. (See Steering system.)		
Generating system:		
Data.....	153 <i>d</i>	281
Description.....	153	279
Generator.....	155	283
Generator-regulator.....	156	285
Radio interference suppression.....	190	333
Tests.....	154	281
Troubleshooting.....	87	160
Governor:		
Air compressor.....	246	451
Engine.....	129	234
Power-take-off (Mechanovac).....	130	236
Hand control valve, trailer brake.....	251	463
Headlight, blackout.....	162	300

	<i>Paragraph</i>	<i>Page</i>
Headlights, service.....	161	294
Heater, water tank.....	53e	86
Hoist pump, dump body.....	331	591
Hood, engine.....	303	545
Horn and horn button.....	185	328
Hose, tire inflation.....	260b	472
Hubs and bearings, wheel.....	265, 266	479, 482
Hydraulic brakes. (See Brake system, service.)		
Hydraulic cylinder, dump body hoist.....	328	585
Ignition:		
Coil.....	123f	226
Switch.....	20, 179	49, 322
System:		
Data.....	121b	215
Description.....	121a	214
Distributor and ignition coil.....	123	219
Ignition switch.....	20, 179	49, 322
Ignition timing.....	122	215
Radio interference suppression.....	189	331
Spark plugs.....	124	226
Troubleshooting.....	82	155
Indicator, battery-generator.....	29, 177	50, 321
Instruction plates.....	6	24
Instrument cluster.....	171a, 172	317, 319
Instrument panel lights.....	165	303
Instruments (location and purpose).....	12-35	44
Lighting system. (See Batteries and lighting system.)		
Lights. (See Batteries and lighting system.)		
Light switch, main.....	45, 180	66, 323
Link, drag (steering).....	269	489
Linkage, manual and throttle (transmission).....	202	355
Lines:		
Brake.....	245	449
Fuel.....	132	239
Vent and breather.....	136	248
Water.....	149	270
Low air pressure switch and buzzer.....	186	330
Lubrication:		
After fording operation.....	73	134
After operation under dusty and sandy conditions.....	74	135
For continued operation below 0° F.....	72	134
Under unusual conditions.....	71	134
Lubrication and painting.....	69-75	113
Maintenance under unusual conditions:		
Extreme cold weather maintenance.....	370	654
Extreme cold weather maintenance problems.....	369	653
Extreme hot weather maintenance.....	371	654
Maintenance after fording.....	372	655
Maintenance after operation on unusual terrain.....	373	656
Manhole covers:		
Gasoline tank body.....	353	633
Water tank body.....	340	604

	<i>Paragraph</i>	<i>Page</i>
Manifold, drain pipe (gasoline tank body)	356	641
Manifold heat control	135	247
Manifolds, intake and exhaust	112	189
Marker lights, front	163	301
Master cylinder, brake	242	446
Mechanovac governor	130	236
Mirrors, rear view	296	533
Mountings, engine	115	202
Muffler, exhaust	139	254
Nameplates	6	24
Oil filter, engine	109	186
Oil pressure gage	31, 173	51, 319
Operating instructions	8-64	42
Operation:		
Materiel used in conjunction with major item	47-58	72
Under unusual conditions	59-64	106
Under usual conditions	36-46	52
Organizational maintenance allocation	2	3
Painting	75	135
Parts:		
Spare	66	113
Special tools, and equipment for operation and organiza- tional maintenace	65-68	113
Paulin:		
Cargo body	309	557
Roof (cab)	293	524
Pedal, brake	241	444
Pillow block	233	432
Pintle	46a, 288	70, 518
Pioneer tool stowage	301	543
Pipes:		
Exhaust	138	251
Tail	140	255
Pitman arm	270	490
Plates, name, caution, and instruction	6	24
Plugs, spark	124	226
Polarizing generator	155d	285
Power outlet, auxiliary (early M135)	170	316
Power plant:		
Engine assembly installation	119	209
Engine assembly removal	118	207
Installation	120	210
Removal	117	205
Power-take-off and accessory drive:		
Accessory drive replacement	214	399
Data	211b	392
Description	211	391
Power-take-off installation	213	397
Power-take-off removal	212	392
Troubleshooting	92	170

	<i>Paragraph</i>	<i>Page</i>
Preventive maintenance services:		
Cleaning.....	77	136
Driver or operator(s).....	78	137
General.....	76	135
Organizational maintenance mechanics.....	79	140
Primer pump, fuel.....	131	238
Propeller shaft, transmission-to-transfer.....	232	430
Propeller shafts, axle:		
Description.....	228	423
Installation.....	230	426
Pillow block.....	233	432
Removal.....	229	424
Transmission-to-transfer.....	232	430
Troubleshooting.....	95	171
Universal joints.....	231	426
Propeller shafts:		
Gasoline tank body pump.....	358	642
Water tank body pump.....	345	618
Pulley, water pump (engine).....	148b	269
Pump:		
Fuel.....	133	243
Fuel primer.....	131	238
Gasoline tank body.....	55, 357	93, 642
Hoist (dump body).....	331	591
Water (engine).....	148	268
Water tank body.....	53, 344	86, 614
Racks and seats, cargo body.....	310	559
Radiator.....	146	264
Radio interference suppression:		
Description.....	188	330
Fuel pump.....	192	334
Generating system.....	190	333
Ignition system.....	189	331
Purpose.....	187	330
Starter.....	191	333
Troubleshooting.....	89	162
Rear axles. (See Axles, rear.)		
Regulator, generator.....	153c, 156	279, 285
Reservoirs, air.....	249	458
Resistor, distributor primary circuit.....	189d	332
Roof paulin, cab.....	293	524
Running boards.....	306	552
Safety valve, air pressure.....	249	458
Screen:		
Drain valve (water tank body).....	343d	609
Pump strainer (water tank body).....	344b	614
Screens, side window (shop van body).....	367	652
Seals, front axle housing outer.....	218	404
Seat:		
Companion.....	298	536
Driver's.....	297	535
Spring (rear).....	281	510
Seats, troop (cargo body).....	310	559

	<i>Paragraph</i>	<i>Page</i>
Sending units:		
Air pressure gage	176	321
Fuel gage	174	320
Oil pressure gage	173	319
Temperature gage	175	321
Service upon receipt of materiel	8-11	42
Shackles:		
Spring	274	497
Towing	287	518
Shaft, flexible (speedometer)	178	321
Shafts, rear axle	225	418
Shearpin (winch)	314	562
Sheet metal:		
Brush guard	305	550
Engine hood	303	545
Fenders, skirts, and extension panels	304	548
General	302	543
Running boards	306	552
Shield, spare tire	263	474
Shipment and limited storage:		
Blocking on flatcars	377	662
Domestic shipping instructions	374	657
Limited storage instructions	375	658
Loading on flatcars	376	659
Shock absorbers	277	501
Shoes, brake	239	439
Shop van body:		
Description	360	643
Dome lights	365	650
Exhaust blower	364	649
External power receptacle	366	651
Lubrication	362	646
Mountings	361	645
Operation of auxiliary equipment	57	99
Side window screens	367	652
Switchboxes	363	646
Window glass replacement	368	652
Slave battery receptacle	160	293
Spare wheel and carrier	262	474
Spark plugs	124	226
Special tools and equipment	68	113
Speedometer	178	321
Spring suspension:		
Front:		
Data	273b	494
Description	273a	494
Shock absorbers	277	501
Spring replacement	275	498
Spring shackles	274	497
Torque rods	276	499
Troubleshooting	100	175
Rear:		
Data	278b	502
Description	278a	502

	<i>Paragraph</i>	<i>Page</i>
Spring suspension—Continued		
Rear—Continued		
Main spring seat replacement.....	281	510
Main spring replacement.....	279	504
Secondary spring replacement.....	280	507
Torque rod replacement.....	282	513
Troubleshooting.....	101	176
Starter.....	151	273
Starting engine.....	37a	53
Starting system:		
Data.....	150d	273
Description.....	150	271
Radio interference suppression.....	191	333
Starter.....	151	273
Starter control linkage.....	152	275
Troubleshooting.....	86	159
Steering system:		
Data.....	267b	485
Description.....	267a	485
Drag link.....	269	489
Pitman arm.....	270	490
Steering gear adjustment.....	268	486
Steering gear replacement.....	272	491
Steering wheel.....	271	490
Troubleshooting.....	99	174
Stoplights.....	164	302
Stoplight switch.....	183	325
Stopping engine.....	37b	53
Strainer:		
Air (windshield wiper).....	295g	531
Filler (water tank body).....	341	605
Suspension, spring. (See Spring suspension, front or rear.)		
Switch boxes, shop van body.....	363	646
Switches:		
Dimmer.....	45c, 182	66, 324
Ignition.....	20, 179	49, 322
Low air pressure.....	186	330
Main light.....	45a, 180	66, 323
Starter.....	151d	275
Stoplight.....	183	325
Temporary parking brake.....	181	323
Tables:		
Circuit numbers and descriptions (early M135) (table VII)....	167	308
Circuit numbers and descriptions (late M135 and all other models) (table VIII).....	167	308
Connector tabulation (table IX).....	167	308
Driver or operator(s) preventive maintenance services (table IV).....	78	137
Name, caution, and instruction plates (table I).....	6	24
Organizational mechanic or maintenance crew C and D preventive maintenance services (table IV).....	79	140
Special tools and equipment for operation and organizational maintenance (table III).....	68	113
Transmission automatic shift pattern (table X).....	199	349
Transmission troubleshooting diagnosis guide (table VI)....	90	163
Vehicle tabulated data (table II).....	7	37

	<i>Paragraph</i>	<i>Page</i>
Tabulated data (vehicle).....	7	37
Tailgate (cargo body).....	311	559
Taillights.....	164	302
Tailpipes, exhaust.....	140	255
Tank, fuel.....	132	239
Temporary gage.....	30, 175	51, 321
Temporary (electric) parking brake valve.....	257	470
Thermostat, engine.....	147	266
Throttle, hand.....	21, 128c	49, 232
Throttle linkage (transmission).....	202	355
Tie-down U-bolts (frame).....	289	519
Tie rod front axle.....	219	407
Timing, ignition.....	122	215
Tires and tubes.....	260	472
Toe-in adjustment.....	220	408
Tool stowage.....	301	543
Tools and equipment:		
Common.....	67	113
Special.....	68	113
Torque rods:		
Front.....	276	499
Rear.....	282	513
Tower, transmission control.....	203	363
Towing shackles.....	287	518
Towing the vehicle.....	46	70
Tractor fifth wheel.....	56	97
Trailer brake connection.....	250	460
Trailer brake hand control valve.....	44, 251	62, 463
Transfer and controls:		
Checking, draining, and filling.....	207	384
Data.....	206b	384
Description.....	206	384
Front axle drive shift linkage.....	208	386
Manual shift linkage.....	209	387
Transfer replacement.....	210	388
Troubleshooting.....	91	169
Use.....	39	55
Transmission and controls:		
Automatic-shift pattern (table X).....	199	349
Checking, draining, and filling.....	194	338
Data.....	193b	338
Description.....	193	335
Front band adjustment.....	201	352
Manual and throttle linkage.....	202	355
Noise check.....	200	349
Oil:		
Leakage checks.....	195	341
Pressure tests.....	198	346
Operation tests.....	197	345
Road test.....	199	349
Transmission:		
Control tower.....	203	363
Installation.....	205	377
Removal.....	204	372

Transmission and controls—Continued		Paragraph	Page
Troubleshooting.....	90	163	
Use.....	40	55	
Water leakage check.....	196	345	
Troubleshooting:			
Axle propeller shafts.....	95	171	
Batteries and lighting system.....	88	160	
Brakes, parking.....	97	173	
Brakes, service.....	96	172	
Cab and associated parts.....	102	176	
Cooling system.....	85	159	
Dump body and controls.....	104	177	
Engine.....	81	152	
Exhaust system.....	84	159	
Front axle.....	93	170	
Front spring suspension.....	100	175	
Fuel and air intake system.....	83	158	
Gasoline tank body.....	106	179	
Generating system.....	87	160	
Ignition system.....	82	155	
Power-take-off and controls.....	92	170	
Radio interference.....	89	162	
Rear axles.....	94	171	
Rear spring suspension.....	101	176	
Scope.....	80	152	
Starting system.....	86	159	
Steering system.....	99	174	
Transfer and controls.....	91	169	
Transmission and controls.....	90	163	
Water tank body.....	105	178	
Wheels, tires, and hubs.....	98	174	
Winch.....	103	177	
Universal joints (axle propeller shafts).....	231	426	
Universal joint, winch drive shaft.....	320	570	
Vacuum test, engine.....	111b	188	
Valve:			
Check (trailer brake service line).....	252	465	
Clearance adjustment (engine).....	110	186	
Control (dump body hoist).....	334	593	
Control (exhaust heater system).....	348	626	
Crankcase ventilator.....	114b	199	
Hand control (trailer brake).....	44, 251	62, 463	
Radiator pressure.....	146d	266	
Safety (air pressure).....	249	458	
Valves:			
Drain. (See Drain valves and controls.)			
Gate. (See Gate valves.)			
Temporary parking brake.....	257	470	
Ventilation system, crankcase.....	114	199	
Ventilator, cowl.....	300	542	
Voltmeter.....	29, 177	50, 321	
Water pump (engine).....	148	268	
Water tank body:			
Controls and equipment.....	52	84	

	<i>Paragraph</i>	<i>Page</i>
Water tank body—Continued		
Data.....	338b	602
Description.....	338a	602
Drain valves and controls.....	343	609
Exhaust		
Control Valve.....	348	626
Heater gate valve.....	349	630
Heater system.....	347	623
Filler cover and strainer.....	341	605
Gate valves.....	342	607
Manhole covers.....	340	604
Mounting.....	339	603
Operation (Pump).....	53	86
Power-take-off accessory drive control linkage.....	346	622
Pump propeller shafts.....	345	618
Pump, water.....	344	614
Troubleshooting.....	105	178
Wheel cylinders, brake.....	244	448
Wheel hubs and bearings:		
Description.....	264	479
Hubs and bearings.....	266	482
Troubleshooting.....	98	174
Wheel bearing adjustment.....	265	479
Wheels and tires:		
Data.....	258b	471
Description.....	258a	471
Spare tire shield.....	263	474
Spare wheel and carrier.....	262	474
Tire and tube replacement.....	261	474
Tires and tubes.....	260	472
Troubleshooting.....	98	174
Wheels.....	259	472
Wheel, steering.....	271	490
Windshield.....	294	529
Windshield wipers.....	295	531
Winch and controls:		
Automatic brake band.....	317	565
Cable.....	318	567
Control linkage.....	321	572
Controls.....	48	72
Data.....	313b	561
Description.....	313a	561
Drive line.....	319	567
Operation.....	49	74
Shear pin replacement.....	314	562
Tests and adjustments.....	316	564
Troubleshooting.....	103	117
Winch:		
Lubrication.....	315	5
Replacement.....	322	
Wipers, windshield.....	295	
Wiring and harnesses (electrical).....	168	
Wiring harnesses, and circuits:		
Auxiliary power outlet.....	170	
Bayonet-type connectors.....	169	

Wiring harnesses, and circuits—Continued		
Circuits and connections.....	Paragraph	Page
General.....	167	308
Wiring and harnesses.....	166	303
	168	313

[AG 451.2 (23 Jun 55)]

BY ORDER OF THE SECRETARIES OF THE ARMY AND THE AIR FORCE:

MAXWELL D. TAYLOR,
General, United States Army,
Chief of Staff.

OFFICIAL:

JOHN A. KLEIN,
Major General, United States Army,
The Adjutant General.

N. F. TWINING,
Chief of Staff, United States Air Force.

OFFICIAL:

E. E. TORO,
Colonel, United States Air Force,
Air Adjutant General.

DISTRIBUTION:

Active Army:

CNGB (1)
Tec Svc, DA (1)
Ord Bd (2)
CONARC (3)
Army AA Comd (2)
OS Maj Comd (5)
OS Base Comd (2)
Log Comd (3)
MDW (1)
Armies (3)
Corps (2)
Div (2)
Brig (2)
Regt/Gp (1) except Ord Gp (2)
Bn (1) except Ord Bn (2)
Co (1) except Ord Co (2)
Ft & Cp (2)
Gen & Br Svc Sch (2)
Ord Sch (50)
PMST Ord ROTC units (1)
Gen Depots (2) except Atlanta
 Gen Depot (None)
Ord Sec, Gen Depots (5)
Ord Depots (10)
POE (2)

OS Sup Agencies (1)
ORD PG (10)
Ord Arsenal (5)
Mil Dist (1)
Ord Proc Dist (10)
MAAG (1)
Mil Msn (1)
Units organized under following
 TOE's:
 9-12A, Hq & Hq Co, Maint &
 Sup Co Ammo (1)
 9-17, Ammo Co, Army (1)
 9. 45A, Sp Wpn Spt or Depot
 Bn (1)
 9-46A, Hq & Hq Det, Sp
 Wpns Spt or Depot Bn (1)
 9-47A, Sp Wpns Spt or Depot
 Co (1)
 9-49, Sp Wpns Dir Spt Co (1)
 9-57A, Fld Sup Co (1)
 9-229, ORD GM Dir Spt Co
 (1)
 9-347, Ord Tire Rebuild Co (1)
 9-367, Sup Depot Co (1)
 9. 387, Ammo Depot Co (1)

NG: State AG (6); units—same as Active Army except allowance is one copy to each unit.

USAR: None.

For explanation of abbreviations used, see SR 320-50-1.

