

TM 9-2320-209-20-2-2
T.O. 36A12-1B-1092-1-2

TECHNICAL MANUAL
VOLUME 2 OF 3
PART 2 OF 2
TROUBLESHOOTING
ORGANIZATIONAL LEVEL
2 1/2-TON, 6X6, M44A1 AND M44A2 SERIES TRUCKS
(MULTIFUEL)

TRUCK, CARGO: M35A1,
M35A2, M35A2C, M36A2; TRUCK,
TANK, FUEL: M49A1C, M49A2C; TRUCK, TANK,
WATER: M50A1, M50A2, M50A3; TRUCK, VAN,
SHOP: M109A2, M109A3; TRUCK, REPAIR SHOP:
M185A2, M185A3; TRUCK, TRACTOR: M275A1,
M275A2; TRUCK, DUMP: M342A2; TRUCK,
MAINTENANCE PIPELINE CONSTRUCTION:
M756A2; TRUCK, MAINTENANCE,
EARTH BORING AND POLESETTING: M764

NOTE:
THE STYLE OF THIS TM IS
EXPERIMENTAL. IT IS BEING TRIED
BY THE ARMY ONLY ON
A LIMITED BASIS

WARNING

Engine cooling system runs under pressure and at very high temperatures. If filler cap is taken off before pressure is set free, scalding coolant will blow out. Due to high temperature of coolant bad burns can occur if contact is made with skin.

Do not touch any part of the exhaust system while engine is running. You can get badly burned. If the engine has just been shut off, wait until the exhaust system has time to cool down before doing any work.

Because of their higher power, 24 volt systems are more dangerous than 6 or 12 volt systems. Do not let a hot wire touch metal parts of the truck at any time. Flash testing by striking a hot wire against a ground will cause an arc that can destroy the lead connector and possibly the lead itself.

Accidental contact of metal tools between positive (+) battery or starter terminal will cause burns on the hand, damaged tools, truck electrical components and batteries. The battery can explode spraying acid and sharp fragments that can cause serious or fatal injuries.

Only properly trained personnel should perform test on 115 volt system. The voltage present in 115 volt system can cause severe or fatal electric shock.

Take off battery ground cable before working near or touching fan. This will make sure that the engine will not be started by accident. Use a rag when touching fan blades because edges on blades can cause cuts.

Eye shields must be worn when using compressed air. Eye injury can occur if eye shields are not used.

TECHNICAL MANUAL

NO. 92320-209-20-2-2

TECHNICAL ORDER

NO. 36A12-1B-1092-1-2

TECHNICAL MANUAL

VOLUME 2 OF 3

PART 2 OF 2

TROUBLESHOOTING

ORGANIZATIONAL LEVEL

21/2-TON, 6X6, M44A1 AND M44A2 SERIES TRUCKS

(MULTIFUEL)

Model		NSN without Winch	NSN with Winch
Truck, Cargo	M35A1	2320-00-542-5633	2320-00-542-5634
	M35A2	2320-00-077-1616	2320-00-077-1617
	M35A2C	2320-00-926-0873	2320-00-926-0875
	M36A2	2320-00-077-1618	2320-00-077-1619
Truck, Tank, Fuel	M49A1C	2320-00-440-3349	2320-00-440-3346
	M49A2C	2320-00-077-1631	2320-00-077-1632
Truck, Tank, Water	M50A1	2320-00-440-8307	2320-00-440-8305
	M50A2	2320-00-077-1633	2320-00-077-1634
	M50A3	2320-00-937-4036	2320-00-937-5264
Truck, Van, Shop	M109A2	2320-00-440-8313	2320-00-440-8308
	M109A3	2320-00-077-1636	2320-00-077-1637
Truck, Repair Shop	M185A2	4940-00-987-8799	
	M185A3	4940-00-077-1638	4940-00-077-1639
Truck, Tractor	M275A1	2320-00-446-2479	
	M275A2	2320-00-077-1640	2320-00-077-1641
Truck, Dump	M342A2	2320-00-077-1643	2320-00-077-1644
Truck, Maintenance, Pipeline Construction	M756A2		2320-00-904-3277
Truck, Maintenance, Earth Boring and Polesetting	M764		2320-00-937-5980

*This manual, together with TM 9-2320-209-20-1, 27 May 1981; TM 9-2320-209-20-2-1, 27 May 1981; TM 9-2320-209-20-3-1, 27 May 1981; TM 9-2320-209-20-3-2, 27 May 1981; TM 9-2320-209-20-3-3, 27 May 1981; and TM 9-2320-209-20-3-4, 27 May 1981, supersedes TM 9-2320-209-20-1, 31 August 1978.

REPORTING OF ERRORS AND RECOMMENDING IMPROVEMENTS

You can help improve this manual. If you find any mistake or if you know of a way to improve the procedure, please let us know. Mail your letter, DA Form 2028 (Recommended Changes to Publication and Blank Forms), or DA Form 2028-2 located in the back of this manual direct to: Commander, U.S. Army Tank Automotive Materiel Readiness Command, ATTN: DRSTA-MB, Warren, Michigan 48090. A reply will be furnished to you.

TABLE OF CONTENTS

	Paragraph	Page
CHAPTER 26. ELECTRICAL SYSTEM TROUBLESHOOTING SUMMARY		
General	26-1	26-1
Procedures	26-2	26-1
CHAPTER 27. ELECTRICAL SYSTEM SUPPORT DIAGRAMS		
General	27-1	27-1
CHAPTER 28. MULTIMETER TEST PROCEDURES		
General	28-1	28-1
Test Set-Up	28-2	28-1
Test Procedure	28-3	28-1
CHAPTER 29. OPERATING AND PRELIMINARY PROCEDURES		
Equipment Items Covered	29-1	29-1
Equipment Items Not Covered	29-2	29-1
CHAPTER 30. ELECTRICAL SYSTEM CHECKOUT PROCEDURES		
General	30-1	30-1
CHAPTER 31. TRANSMISSION SYSTEM TROUBLESHOOTING		
Equipment Items Covered	31-1	31-1
Equipment Items Not Covered	31-2	31-1
CHAPTER 32. TRANSMISSION SYSTEM TROUBLESHOOTING SUMMARY		
General	32-1	32-1
Procedures	32-2	32-1
CHAPTER 33. TRANSFER SYSTEM TROUBLESHOOTING		
Equipment Items Covered	33-1	33-1
Equipment Items Not Covered	33-2	33-1
CHAPTER 34. TRANSFER SYSTEM TROUBLESHOOTING SUMMARY		
General	34-1	34-1
Procedures	34-2	34-1
CHAPTER 35. TRANSFER SYSTEM CHECKOUT PROCEDURES		
General	35-1	35-1
CHAPTER 36. PROPELLER SHAFT SYSTEM TROUBLESHOOTING		
Equipment Items Covered	36-1	36-1
Equipment Items Not Covered	36-2	36-1
CHAPTER 37. PROPELLER SHAFT SYSTEM TROUBLESHOOTING SUMMARY		
General	37-1	37-1
Procedures	37-2	37-1

TABLE OF CONTENTS-CONT

	Paragraph	Page
CHAPTER 38.	PROPELLER SHAFT SYSTEM SUPPORT DIAGRAMS	
	General	38-1 38-1
CHAPTER 39.	FRONT AXLE SYSTEM TROUBLESHOOTING	
	Equipment Items Covered	39-1 39-1
	Equipment Items Not Covered	39-2 39-1
CHAPTER 40.	FRONT AXLE SYSTEM TROUBLESHOOTING SUMMARY	
	General	40-1 40-1
	Procedures	40-2 40-1
CHAPTER 41.	FRONT AXLE SYSTEM CHECKOUT PROCEDURES	
	General	41-1 41-1
CHAPTER 42.	REAR AXLE SYSTEM TROUBLESHOOTING	
	Equipment Items Covered	42-1 42-1
	Equipment Items Not Covered	42-2 42-1
CHAPTER 43.	REAR AXLE SYSTEM SUPPORT DIAGRAMS	
	General	43-1 43-1
CHAPTER 44.	BRAKE SYSTEM TROUBLESHOOTING	
	Equipment Items Covered	44-1 44-1
	Equipment Items Not Covered	44-2 44-1
CHAPTER 45.	BRAKE SYSTEM TROUBLESHOOTING SUMMARY	
	General	45-1 45-1
	Procedures	45-2 45-1
CHAPTER 46.	BRAKE SYSTEM SUPPORT DIAGRAMS	
	General	46-1 46-1
CHAPTER 47.	HANDBRAKE SUBSYSTEM TROUBLESHOOTING	
	Equipment Items Covered	47-1 47-1
	Equipment Items Not Covered	47-2 47-1
CHAPTER 48.	COMPRESSED AIR SUBSYSTEM TROUBLESHOOTING	
	Equipment Items Covered	48-1 48-1
	Equipment Items Not Covered	48-2 48-1
CHAPTER 49.	BRAKE SYSTEM TEST PROCEDURES	
	General	49-1 49-1
	Test Set-Up	49-2 49-1
	Test Procedure	49-3 49-1
CHAPTER 50.	BRAKE SYSTEM CHECKOUT PROCEDURES	
	General	50-1 50-1
CHAPTER 51.	WHEEL SYSTEM TROUBLESHOOTING	
	Equipment Items Covered	51-1 51-1
	Equipment Items Not Covered	51-2 51-1
CHAPTER 52.	STEERING SYSTEM TROUBLESHOOTING	
	Equipment Items Covered	52-1 52-1
	Equipment Items Not Covered	52-2 52-1
CHAPTER 53.	STEERING SYSTEM TROUBLESHOOTING SUMMARY	
	General	53-1 53-1
	Procedures	53-2 53-1
CHAPTER 54.	STEERING SYSTEM SUPPORT DIAGRAMS	
	General	54-1 54-1

TABLE OF CONTENTS-CONT

		Paragraph	Page
CHAPTER 55.	SPRING AND SHOCK ABSORBERS SYSTEM TROUBLESHOOTING		
	Equipment Items Covered	55-1	55-1
	Equipment Items Not Covered	55-2	55-1
CHAPTER 56.	SPRING AND SHOCK ABSORBERS SYSTEM TROUBLESHOOTING SUMMARY		
	General.....	56-1	56-1
	Procedures	56-2	56-1
CHAPTER 57.	DUMP BODY TROUBLESHOOTING		
	Equipment Items Covered	57-1	57-1
	Equipment Items Not Covered	57-2	57-1
CHAPTER 58.	DUMP BODY TROUBLESHOOTING SUMMARY		
	General	58-1	58-1
	Procedures	58-2	58-1
CHAPTER 59.	DUMPBODY SUPPORT DIAGRAMS		
	General	59-1	59-1
CHAPTER 60.	DUMP BODY CHECKOUT PROCEDURES		
	General	60-1	60-1
CHAPTER 61.	WATER TANK BODY TROUBLESHOOTING		
	Equipment Items Covered	61-1	61-1
	Equipment Items Not Covered	61-2	61-1
CHAPTER 62.	WATER TANK BODY TROUBLESHOOTING SUMMARY		
	General.....	62-1	62-1
	Procedures	62-2	62-1
CHAPTER 63.	WATER TANK BODY SUPPORT DIAGRAMS		
	General	63-1	63-1
CHAPTER 64.	WATER TANK BODY CHECKOUT PROCEDURES		
	General	64-1	64-1
CHAPTER 65.	FUEL TANK BODY (TRUCK M49A1C) TROUBLESHOOTING		
	Equipment Items Covered	65-1	65-1
	Equipment Items Not Covered	65-2	65-1
CHAPTER 66.	FUEL TANK BODY (TRUCK M49A1C) TROUBLESHOOTING SUMMARY		
	General	66-1	66-1
	Procedures	66-2	66-1
CHAPTER 67.	FUEL TANK BODY (TRUCK M49A1C) SUPPORT DIAGRAMS		
	General	67-1	67-1
CHAPTER 68.	FUEL TANK BODY (TRUCK M49A1C) CHECKOUT PROCEDURES		
	General	68-1	68-1

TABLE OF CONTENTS-CONT

	Paragraph	Page
CHAPTER 69.	FUEL TANK BODY (TRUCK M49A2C) TROUBLESHOOTING	
	Equipment Items Covered	69-1 69-1
	Equipment Items Not Covered	69-2 69-1
CHAPTER 70.	FUEL TANK BODY (TRUCK M49A2C) TROUBLESHOOTING SUMMARY	
	General	70-1 70-1
	Procedures	70-2 70-1
CHAPTER 71.	FUEL TANK BODY (TRUCK M49A2C) SUPPORT DIAGRAMS	
	General	71-1 71-1
CHAPTER 72.	FUEL TANK BODY (TRUCK M49A2C) CHECKOUT PROCEDURES	
	General	72-1 72-1
CHAPTER 73.	EARTH BORING MACHINE TROUBLESHOOTING	
	Equipment Items Covered	73-1 73-1
	Equipment Items Not Covered	73-2 73-1
CHAPTER 74.	EARTH BORING MACHINE TROUBLESHOOTING SUMMARY	
	General	74-1 74-1
	Procedures	74-2 74-1
CHAPTER 75.	EARTH BORING MACHINE SUPPORT DIAGRAMS	
	General	75-1 75-1
CHAPTER 76.	EARTH BORING MACHINE CHECKOUT PROCEDURES	
	General	76-1 76-1
CHAPTER 77.	FRONT WINCH TROUBLESHOOTING	
	Equipment Items Covered	77-1 77-1
	Equipment Items Not Covered	77-2 77-1
CHAPTER 78.	FRONT WINCH TROUBLESHOOTING SUMMARY	
	General	78-1 78-1
	Procedures	78-2 78-1
CHAPTER 79.	FRONT WINCH CHECKOUT PROCEDURES	
	General	79-1 79-1
CHAPTER 80.	EARTH BORING MACHINE REAR WINCH TROUBLESHOOTING	
	Equipment Items Covered	80-1 80-1
	Equipment Items Not Covered	80-2 80-1
CHAPTER 81.	PIPELINE CONSTRUCTION TRUCK REAR WINCH TROUBLESHOOTING	
	Equipment Items Covered	81-1 81-1
	Equipment Items Not Covered	81-2 81-1

TABLE OF CONTENTS-CONT

		Paragraph	Page
CHAPTER 82.	ENGINE COOLANT HEATER TROUBLE- SHOOTING		
	Equipment Items Covered	82-1	82-1
	Equipment Items Not Covered.	82-2	82-1
CHAPTER 83.	ENGINE COOLANT HEATER TROUBLE- SHOOTING SUMMARY		
	General	83-1	83-1
	Procedures	83-2	83-1
CHAPTER 84.	ENGINE COOLANT HEATER SUPPORT DIAGRAMS		
	General	84-1	84-1
CHAPTER 85.	ENGINE COOLANT HEATER TEST PROCEDURES		
	General	85-1	85-1
	Test Set-Up.....	85-2	85-1
	Test Procedure	85-3	85-1
CHAPTER 86.	ENGINE COOLANT HEATER CHECKOUT PROCEDURES		
	General	86-1	86-1
CHAPTER 87.	FUEL BURNING PERSONNEL HEATER TROUBLESHOOTING		
	Equipment Items Covered	87-1	87-1
	Equipment Items Not Covered	87-2	87-1
CHAPTER 88.	FUEL BURNING PERSONNEL HEATER TROUBLESHOOTING SUMMARY		
	General	88-1	88-1
	Procedures	88-2	88-1
CHAPTER 89.	FUEL BURNING PERSONNEL HEATER SUPPORT DIAGRAMS		
	General	89-1	89-1
CHAPTER 90.	FUEL BURNING PERSONNEL HEATER CHECKOUT PROCEDURES		
	General	90-1	90-1
CHAPTER 91.	HOT WATER HEATER TROUBLESHOOTING		
	Equipment Items Covered	91-1	91-1
	Equipment Items Not Covered	91-2	91-1
CHAPTER 92.	HOT WATER HEATER TROUBLESHOOTING SUMMARY		
	General	92-1	92-1
	Procedures	92-2	92-1
CHAPTER 93.	HOT WATER HEATER CHECKOUT PROCEDURES		
	General	93-1	93-1
CHAPTER 94.	DEEP WATER FORDING KIT TROUBLE- SHOOTING		
	Equipment Items Covered	94-1	94-1
	Equipment Items Not Covered	94-2	94-1

TABLE OF CONTENTS-CONT

	Paragraph	Page
CHAPTER 95. DEEP WATER FORDING KIT TROUBLE- SHOOTING SUMMARY		
General	95-1	95-1
Procedures	95-2	95-1
CHAPTER 96. DEEP WATER FORDING KIT SUPPORT DIAGRAMS		
General	96-1	96-1
CHAPTER 97. DEEP WATER FORDING KIT CHECKOUT PROCEDURES		
General	97-1	97-1
CHAPTER 98. NONELECTRICAL GAGES TROUBLESHOOTING		
Equipment Items Covered	98-1	98-1
Equipment Items Not Covered	98-2	98-1
CHAPTER 99. NONELECTRICAL GAGES TROUBLESHOOTING SUMMARY		
General	99-1	99-1
Procedures	99-2	99-1
CHAPTER 100. NONELECTRICAL GAGES SUPPORT DIAGRAMS		
General	100-1	100-1

CHAPTER 26

ELECTRICAL SYSTEM TROUBLESHOOTING SUMMARY

26-1. GENERAL. This chapter gives a summary of troubleshooting procedures given in chapter 25 for the electrical system.

26-2. PROCEDURES. The summary in this chapter covers all fault symptoms found in the detailed troubleshooting procedures. Chapter 7 outlines a sample troubleshooting procedure. The summary procedures are based on the "what-to-do" portions of the detailed procedures and do not include the "how-to-do-it" instructions. Warnings, cautions, and notes are given where needed.

ELECTRICAL SYSTEM TROUBLESHOOTING SUMMARY

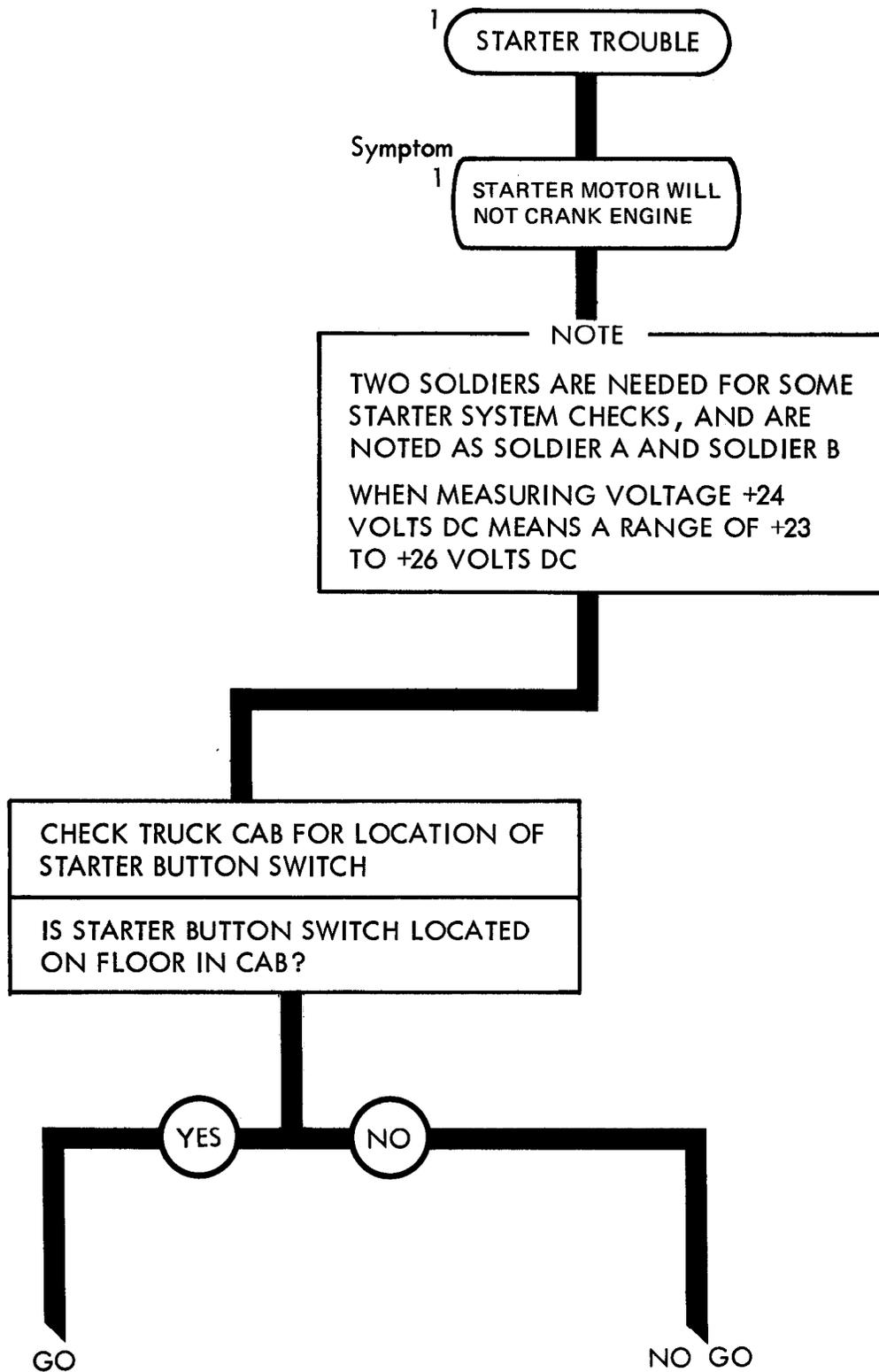

TA 114598

Figure 26-1 (Sheet 1 of 3)

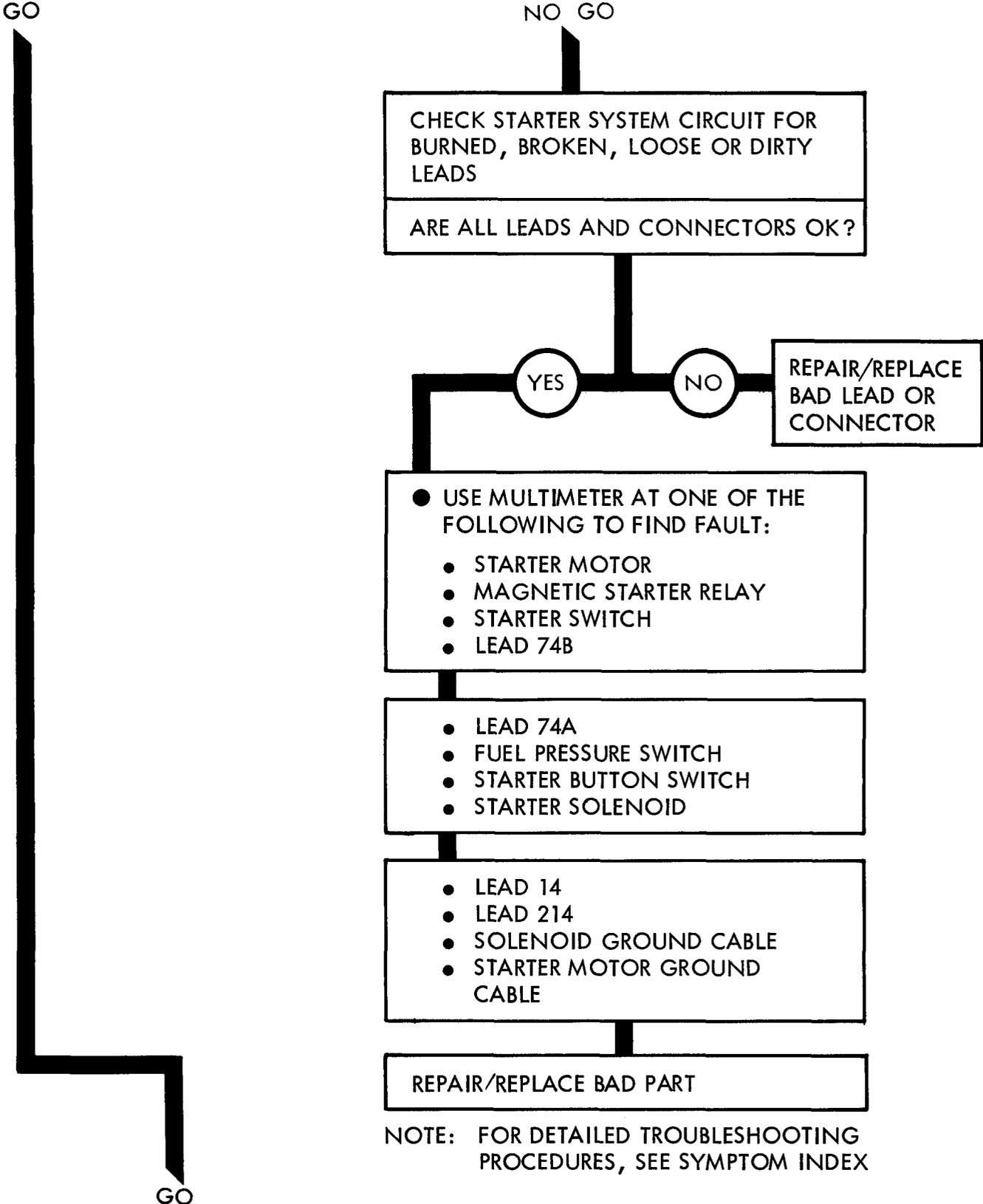
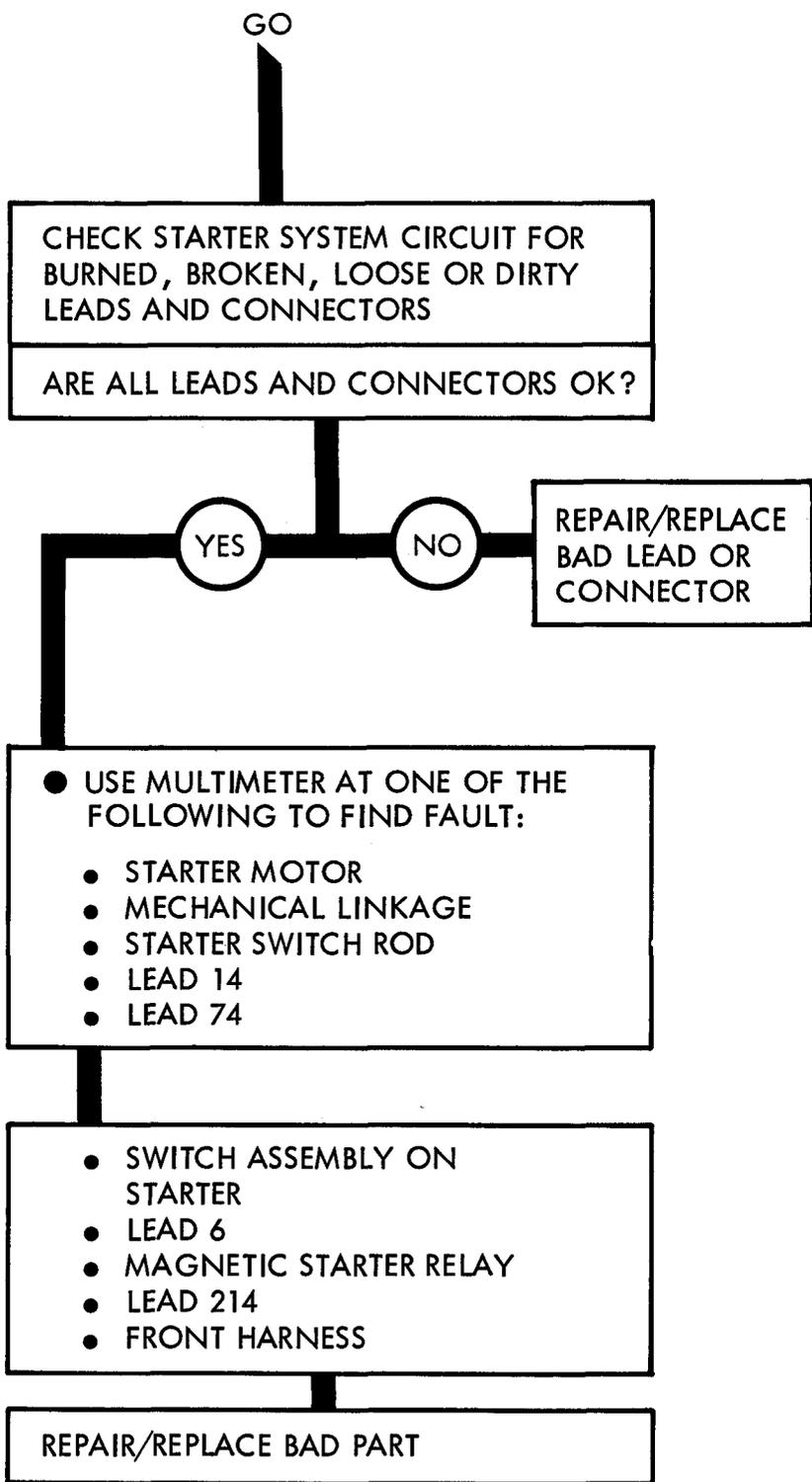

Figure 26-1 (Sheet 2 of 3)



NOTE: FOR DETAILED TROUBLESHOOTING PROCEDURES, SEE SYMPTOM INDEX

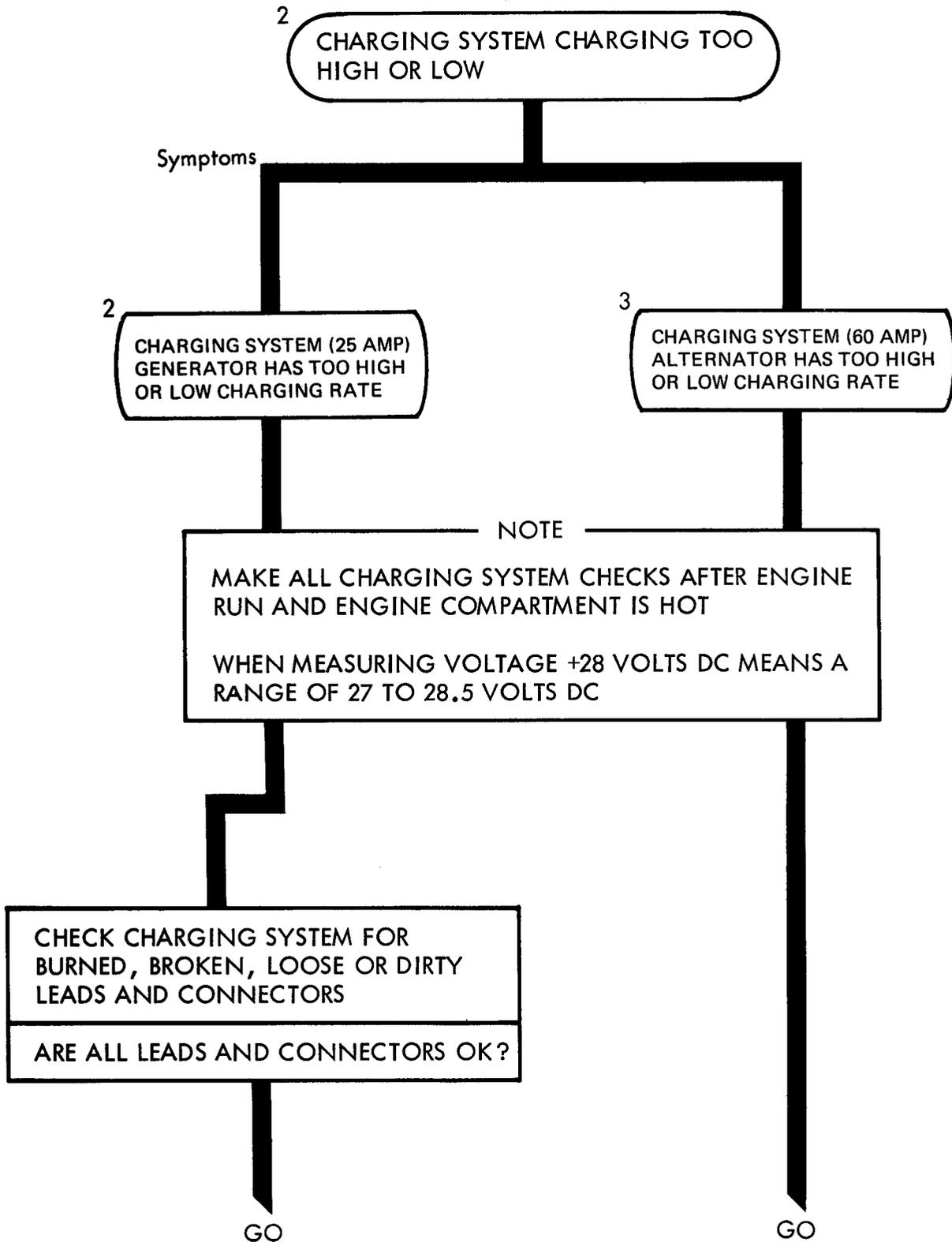
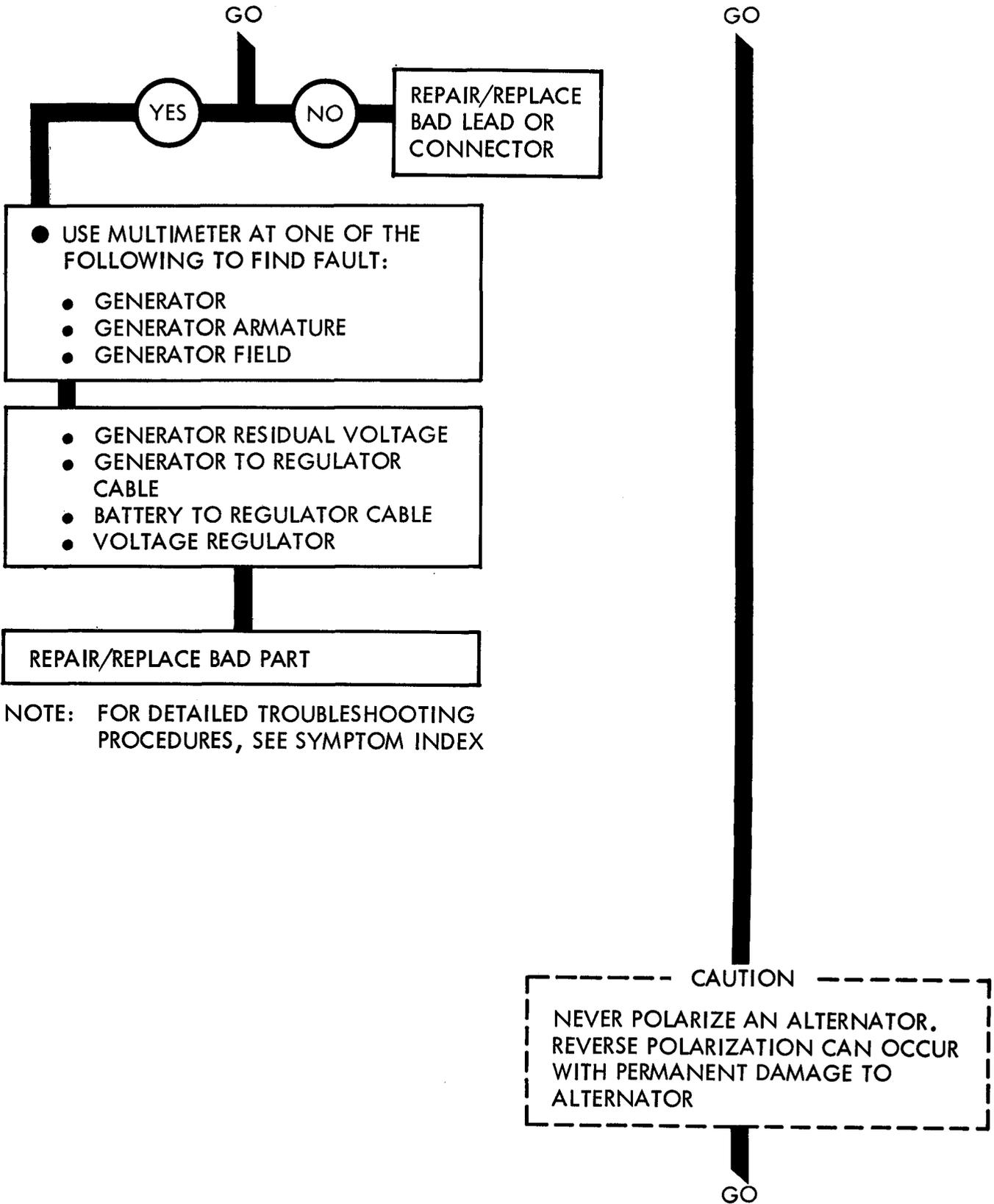
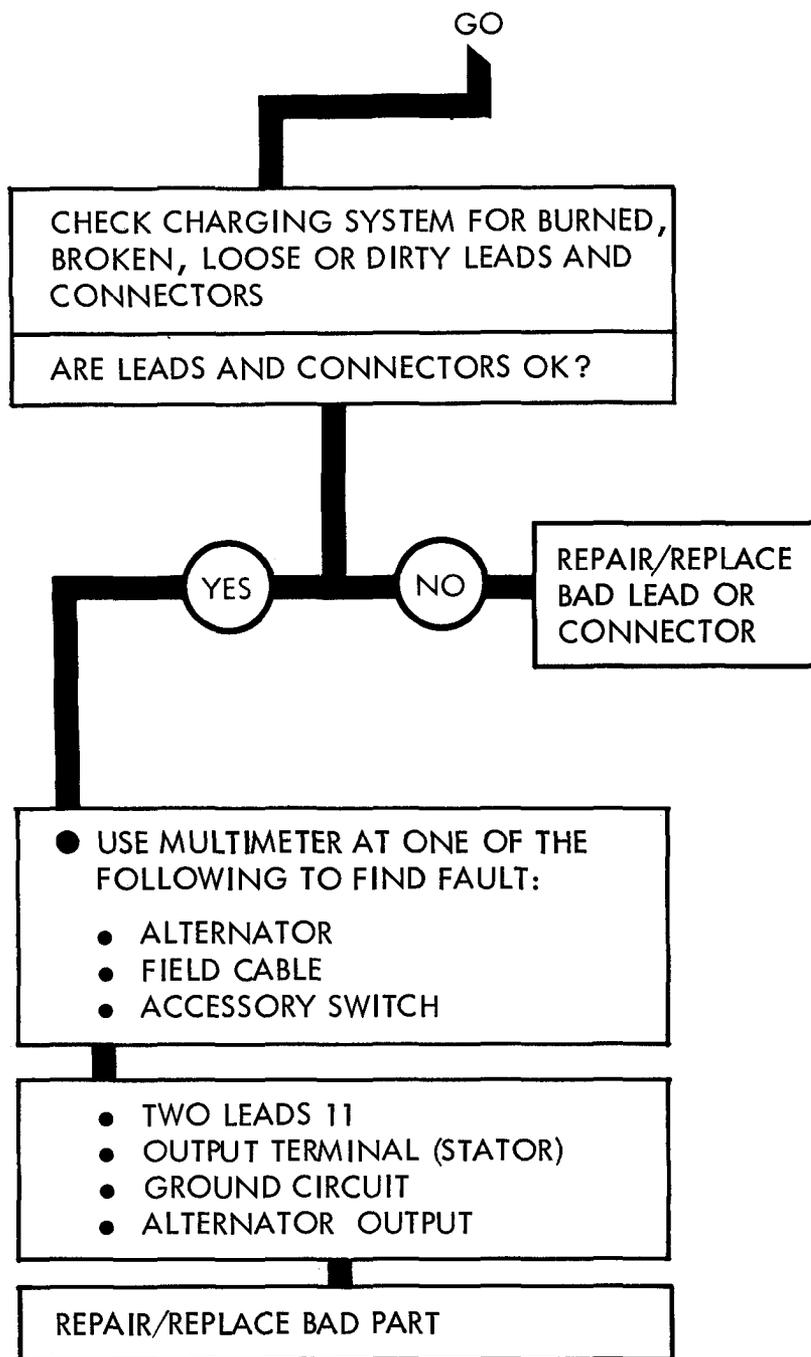

Figure 26-2 (Sheet 1 of 3)





NOTE: FOR DETAILED TROUBLESHOOTING PROCEDURES, SEE SYMPTOM INDEX

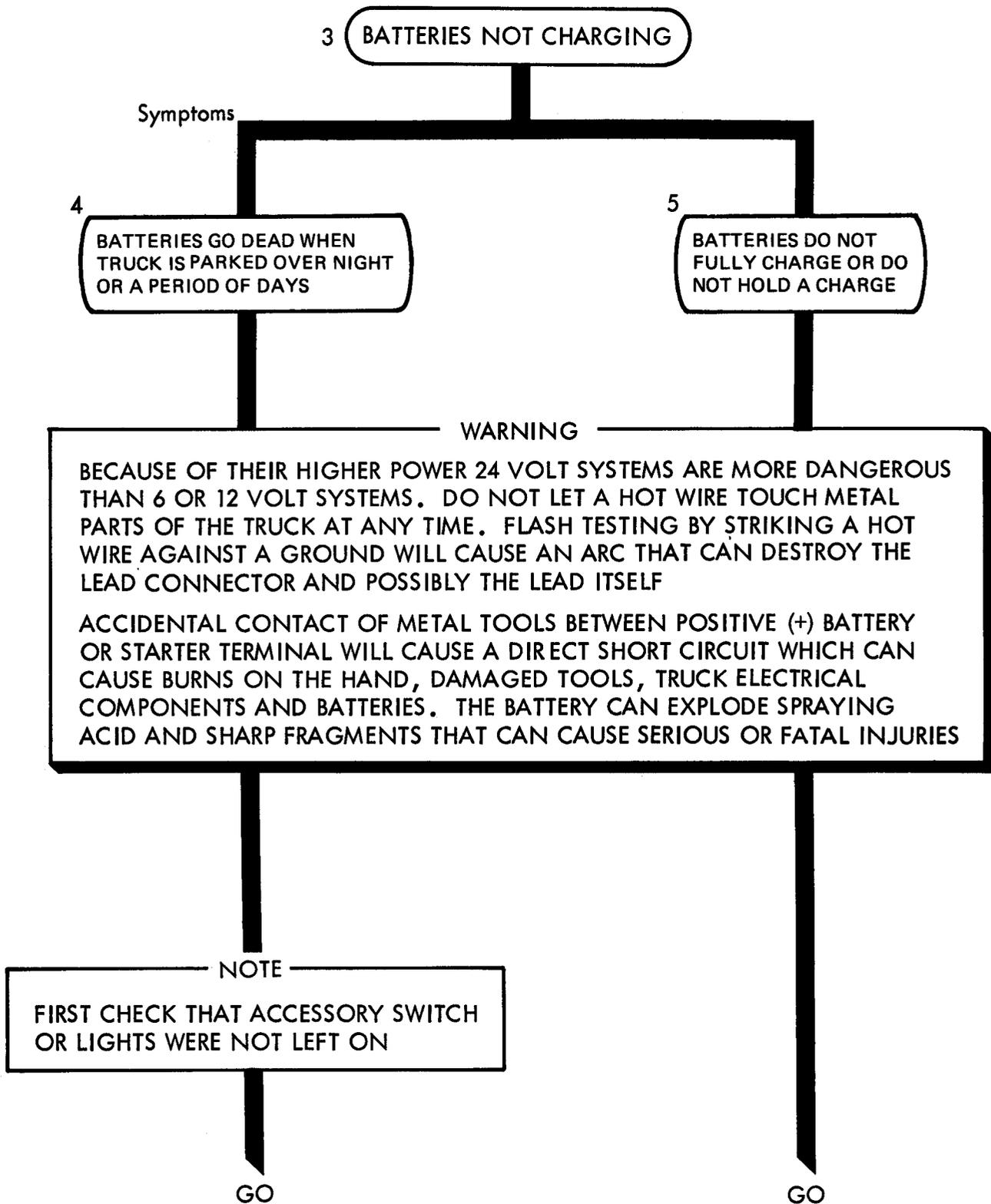
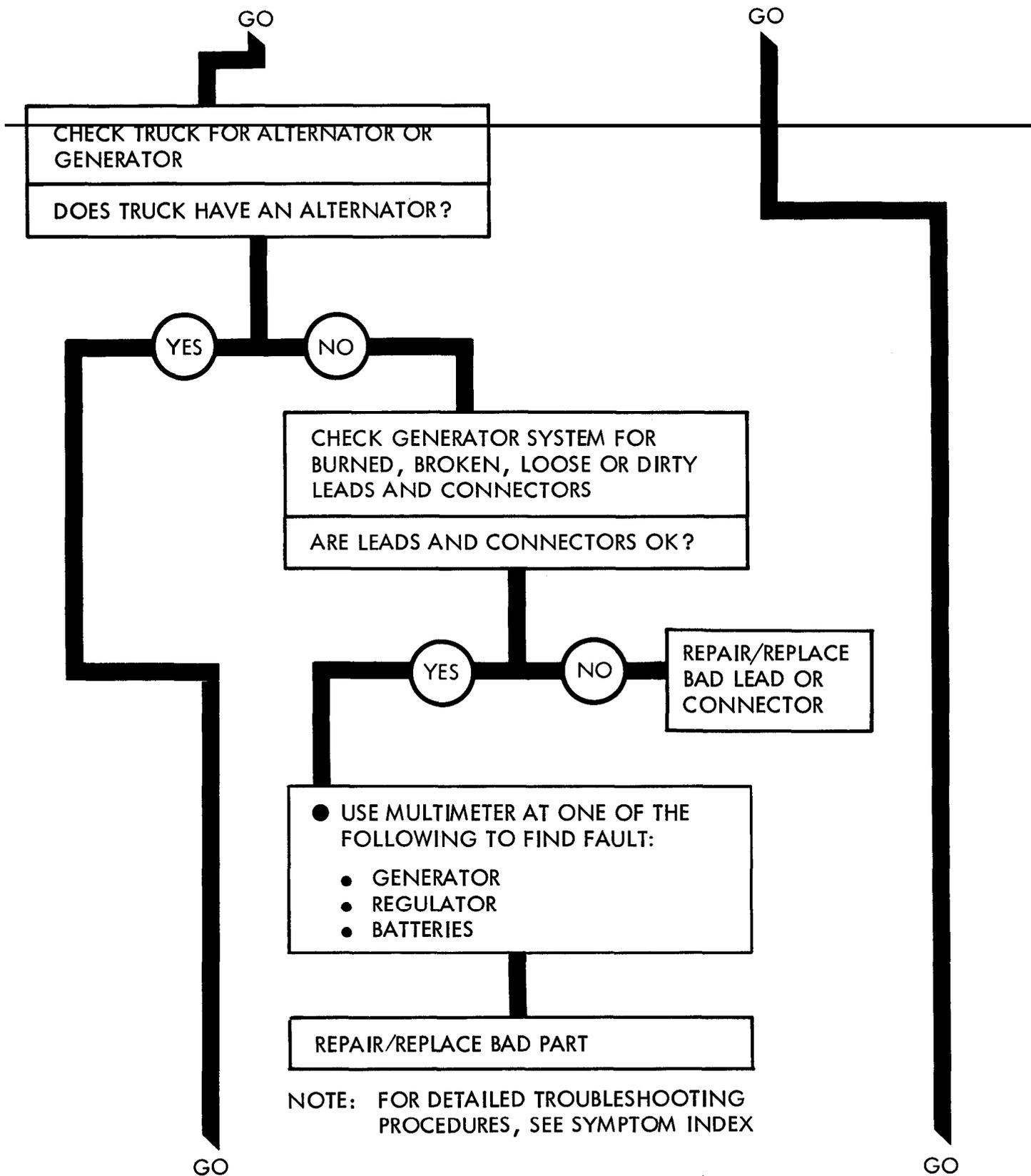
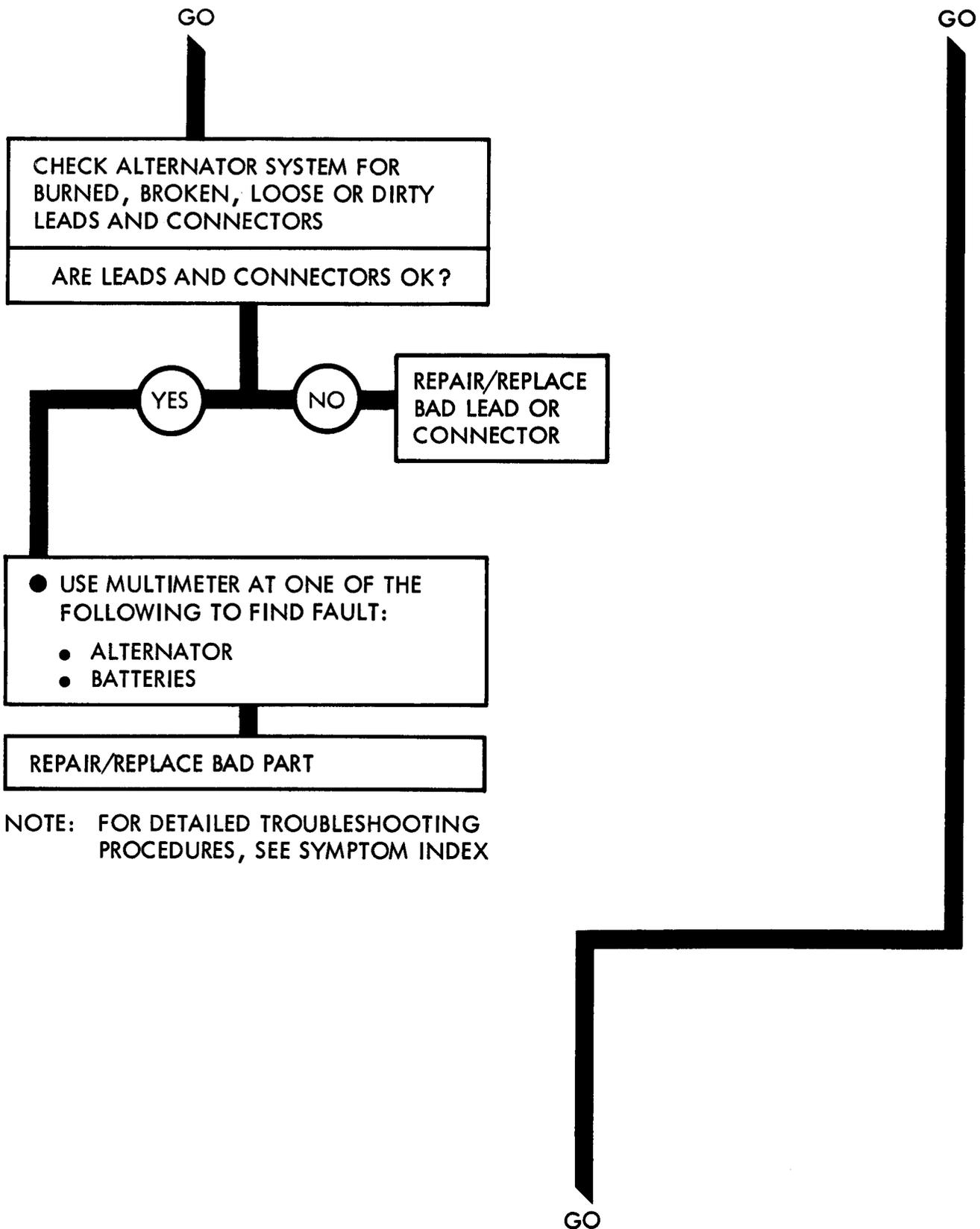
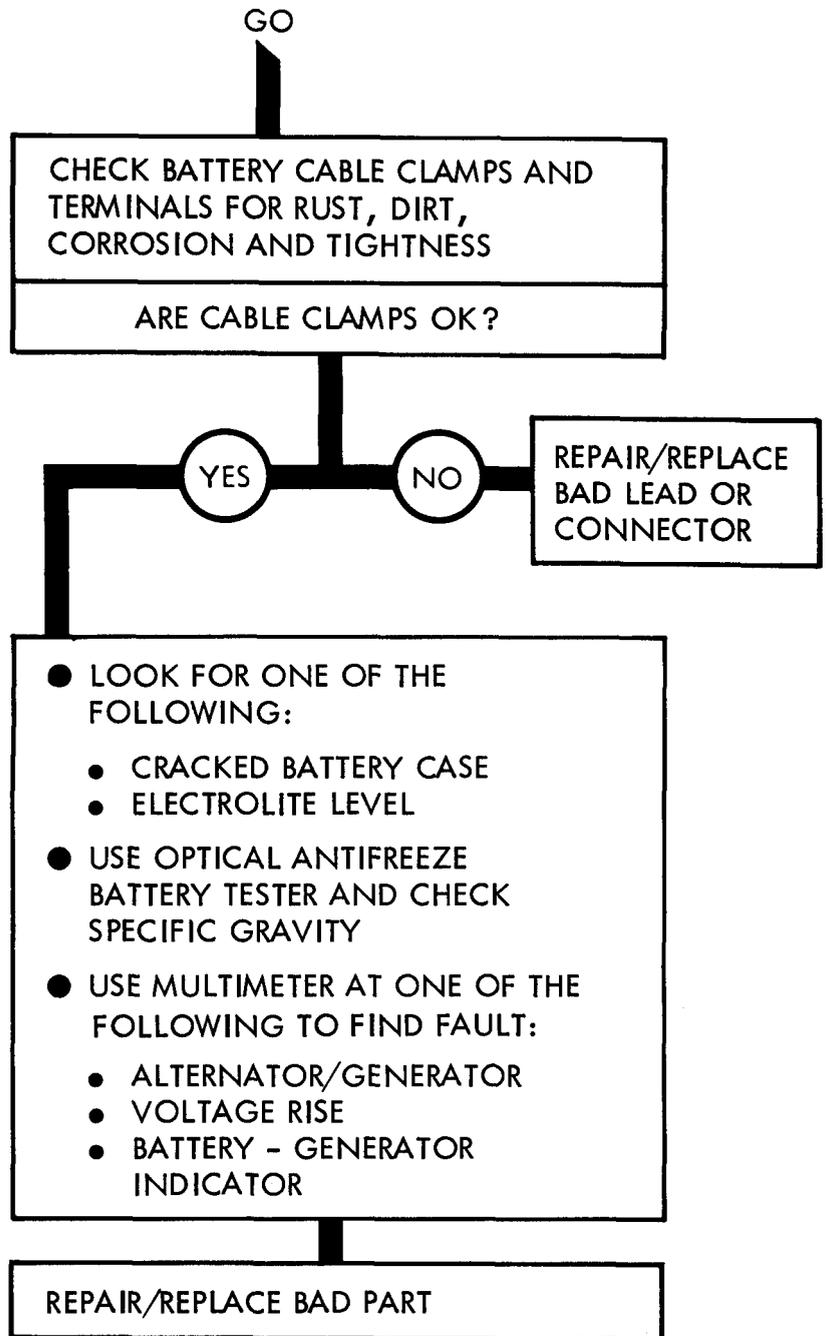

Figure 26-3 (Sheet 1 of 4)





NOTE: FOR DETAILED TROUBLESHOOTING PROCEDURES, SEE SYMPTOM INDEX



NOTE: FOR DETAILED TROUBLESHOOTING PROCEDURES, SEE SYMPTOM INDEX

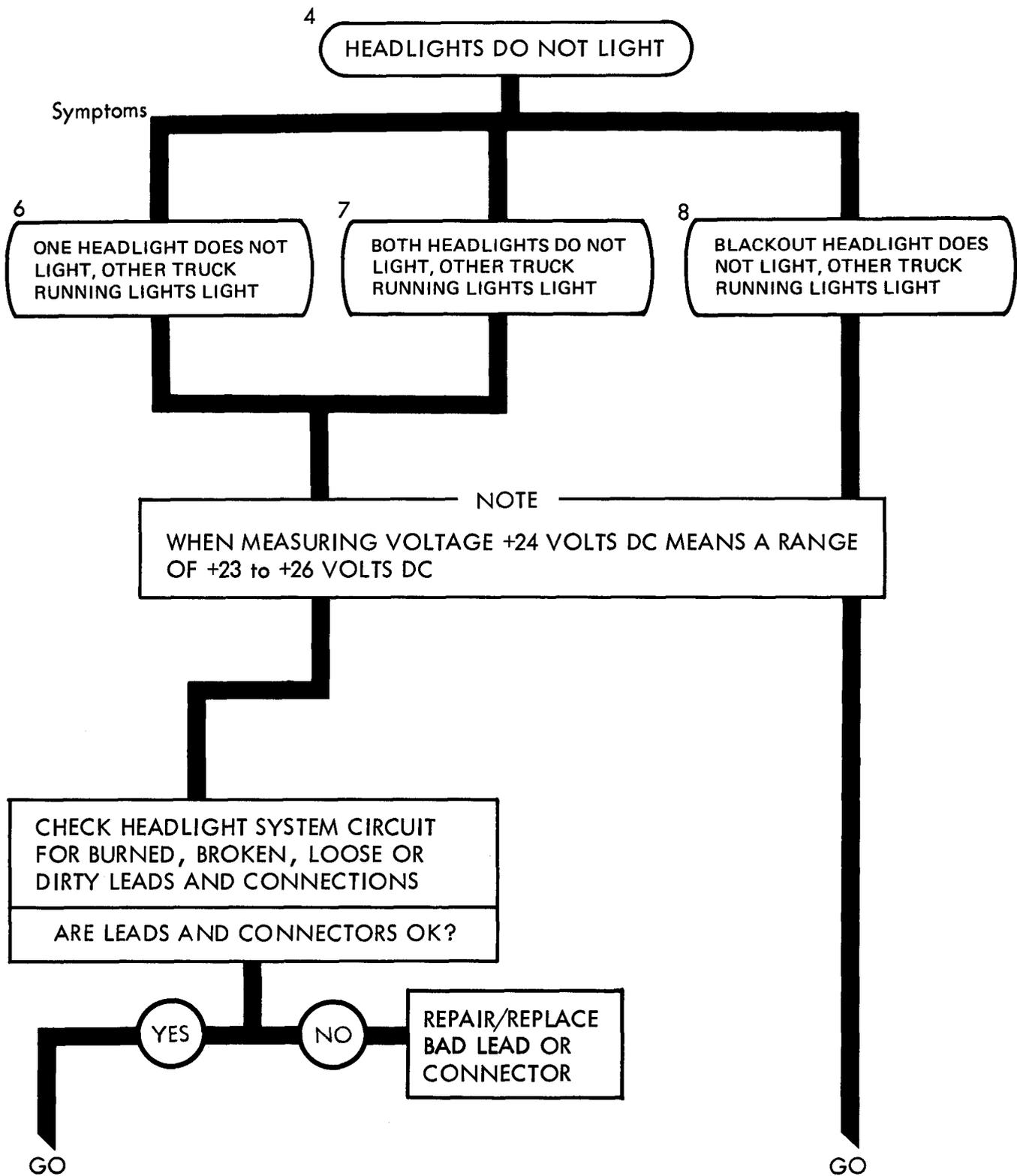

Figure 26-4 (Sheet 1 of 3)

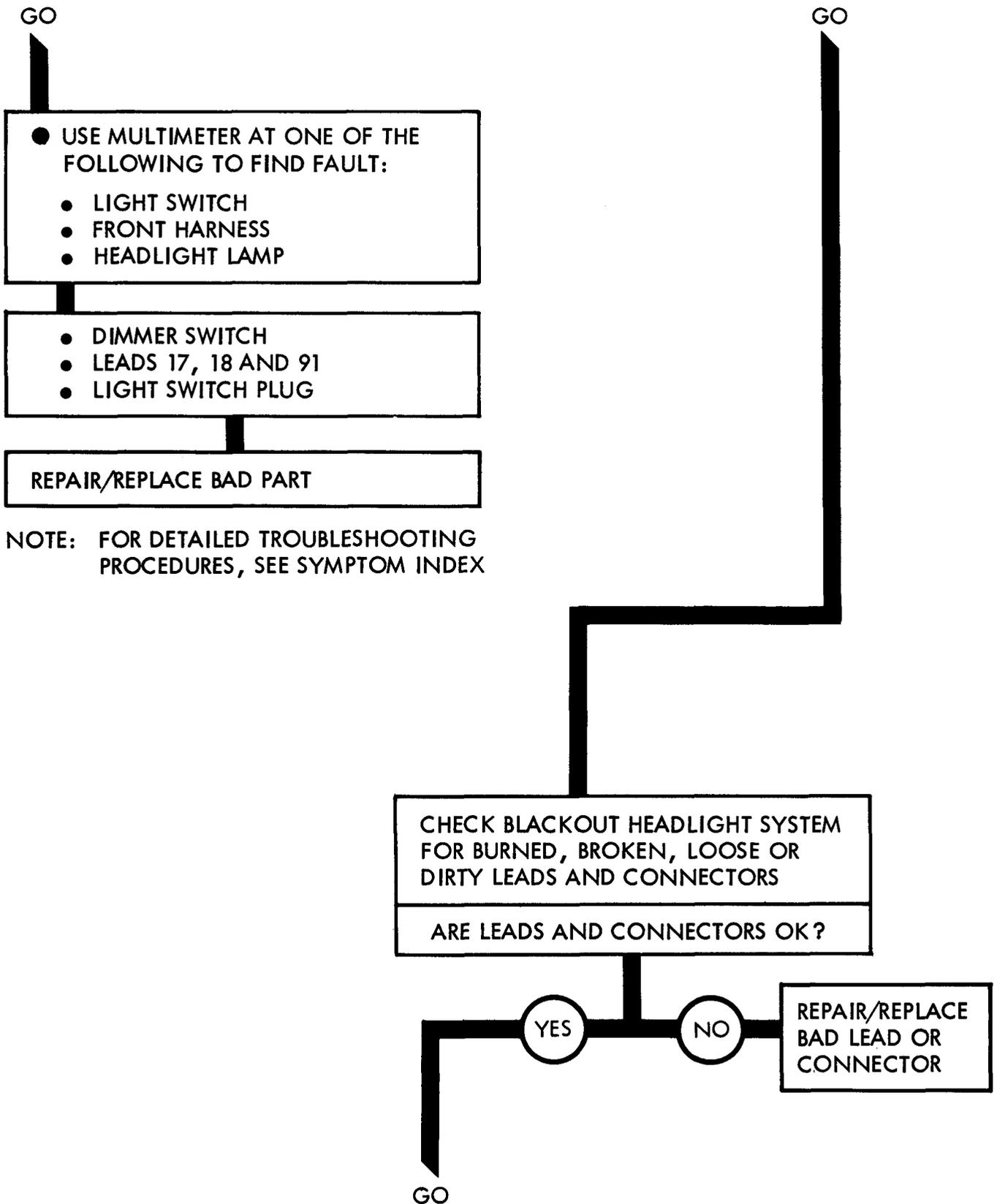
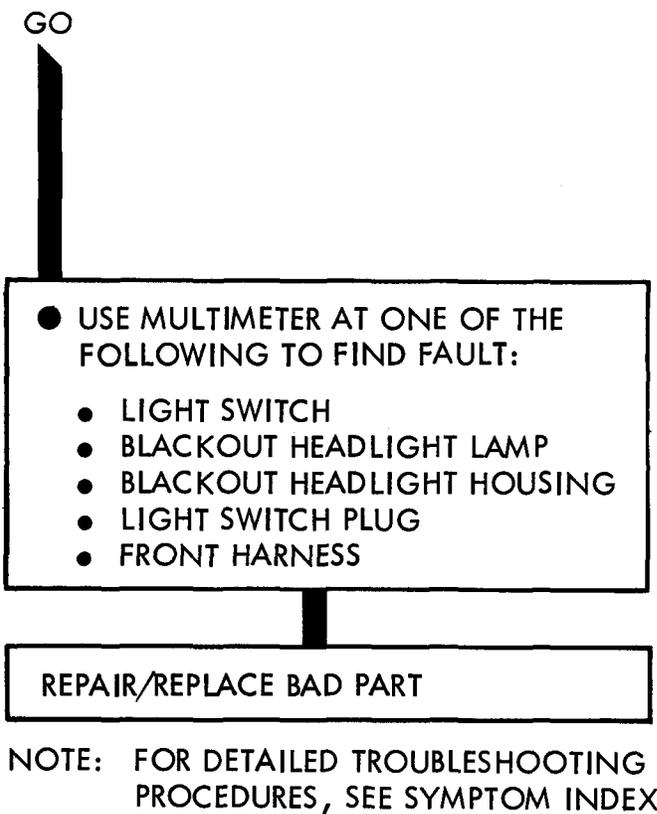

Figure 26-4 (Sheet 2 of 3)



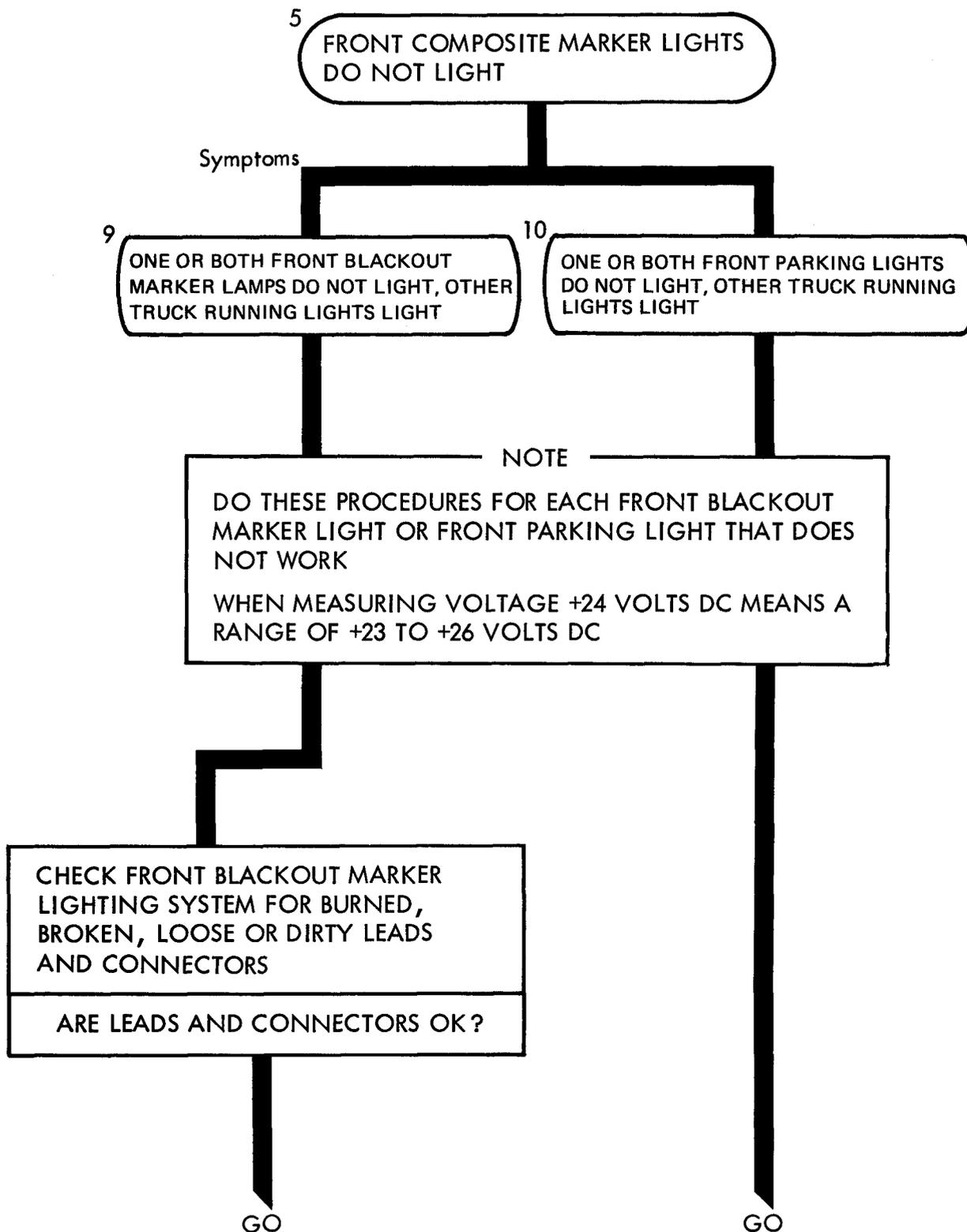
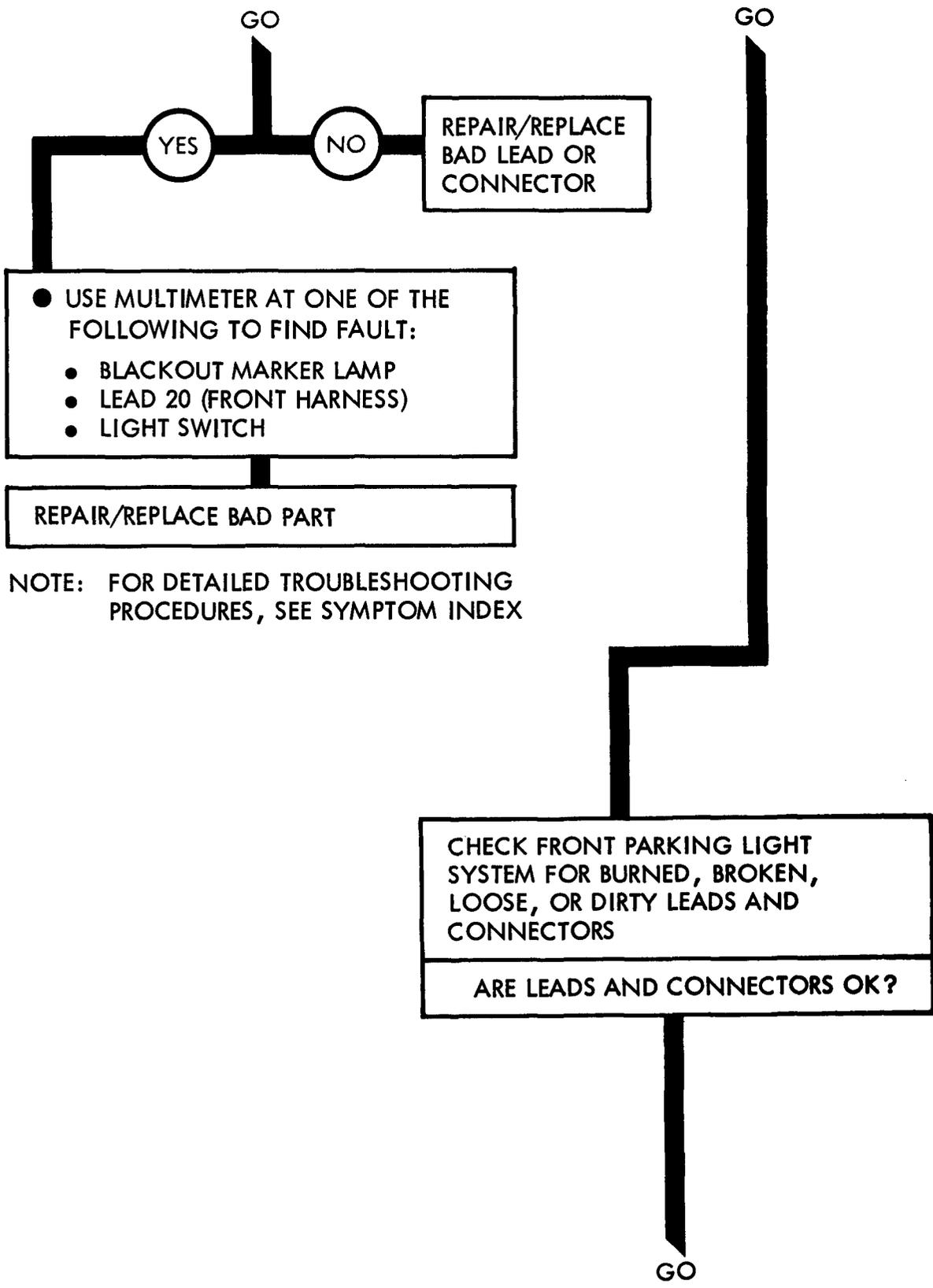

Figure 26-5 (Sheet 1 of 3)



NOTE: FOR DETAILED TROUBLESHOOTING PROCEDURES, SEE SYMPTOM INDEX

Figure 26-5 (Sheet 2 of 3)

TA 114612

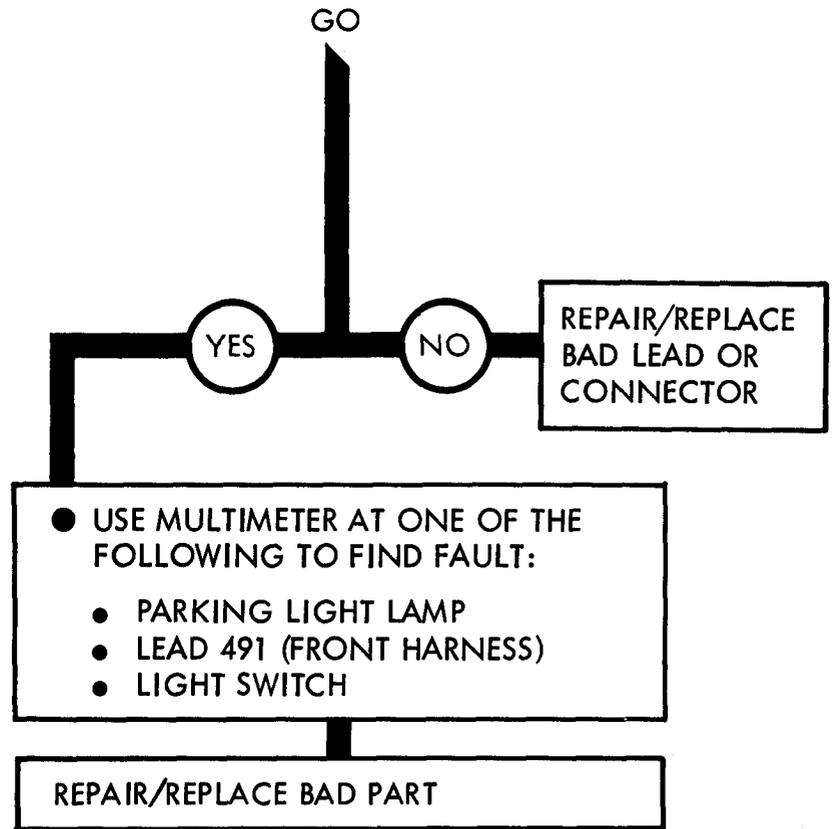

NOTE: FOR DETAILED TROUBLESHOOTING PROCEDURES, SEE SYMPTOM INDEX

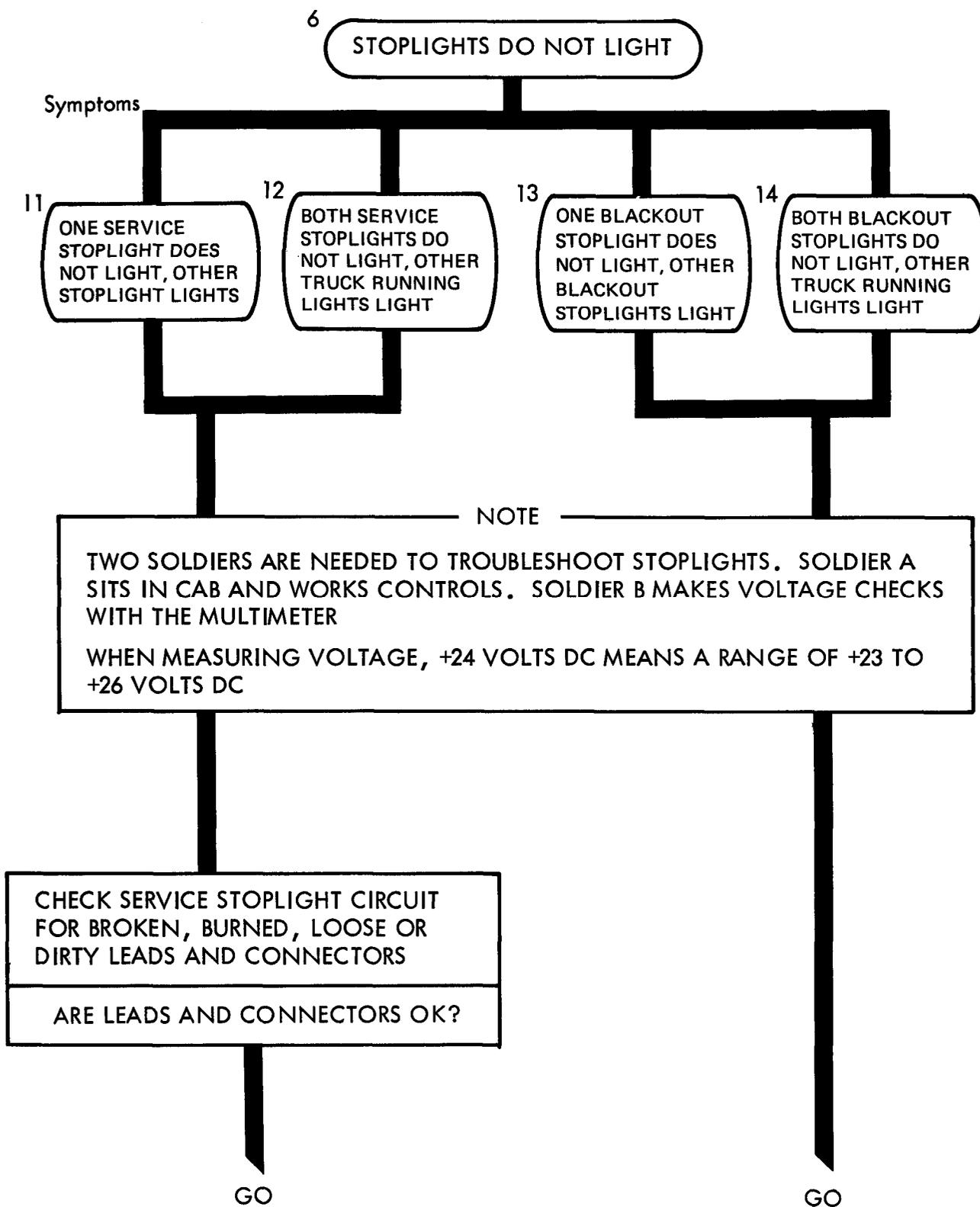

Figure 26-6 (Sheet 1 of 3)

JA 114614

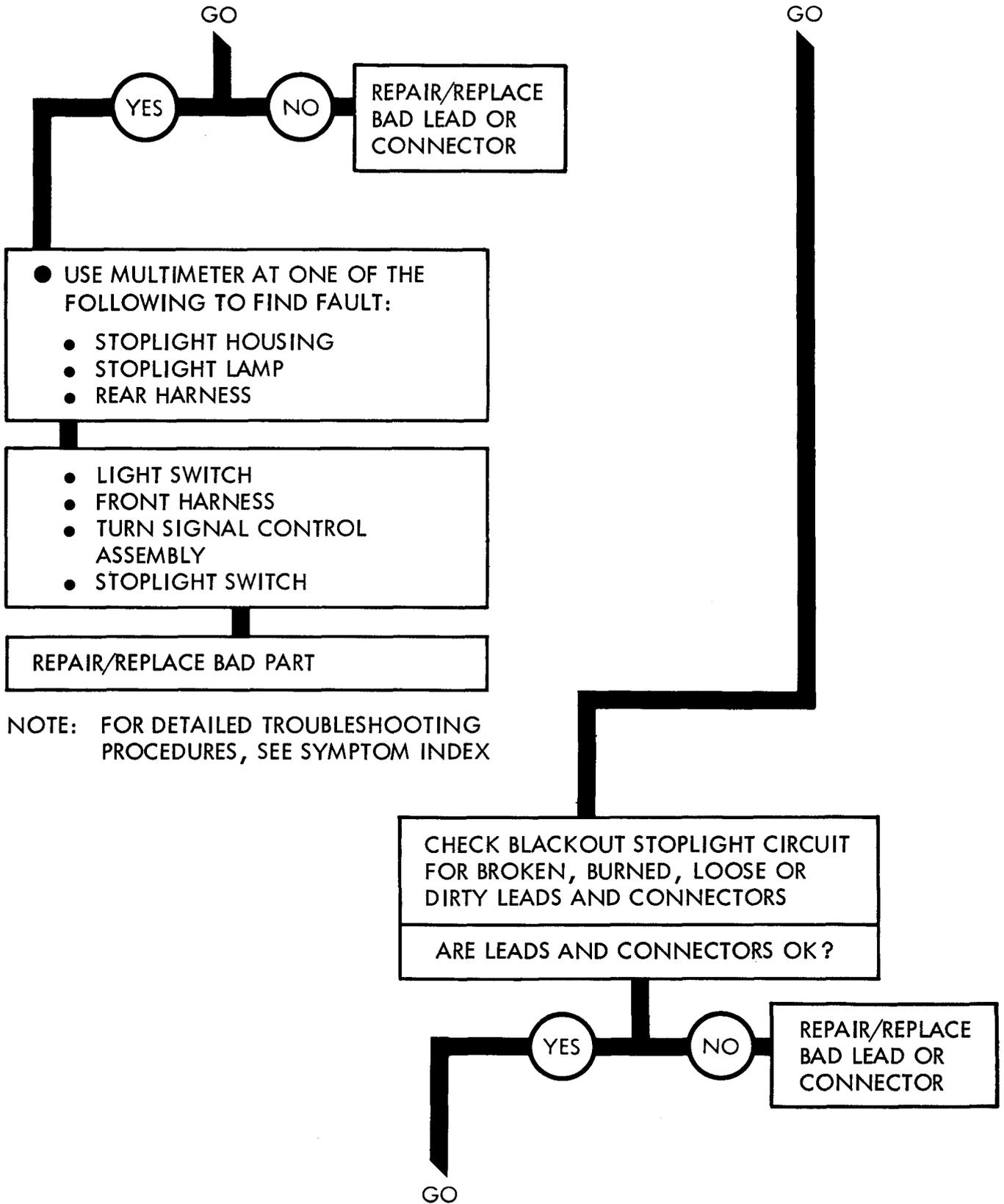

Figure 26-6 (Sheet 2 of 3)

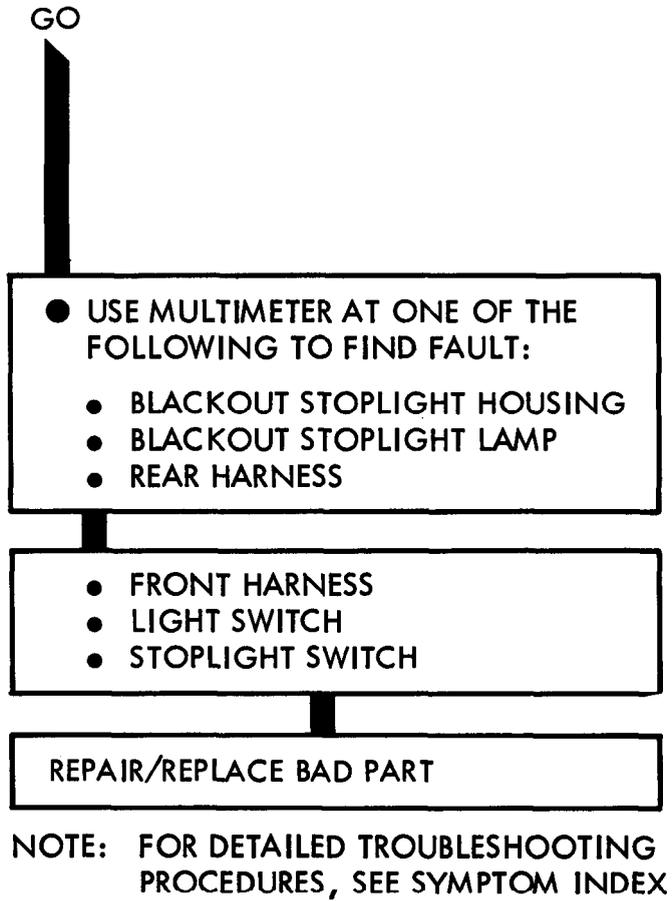

Figure 26-6 (Sheet 3 of 3)

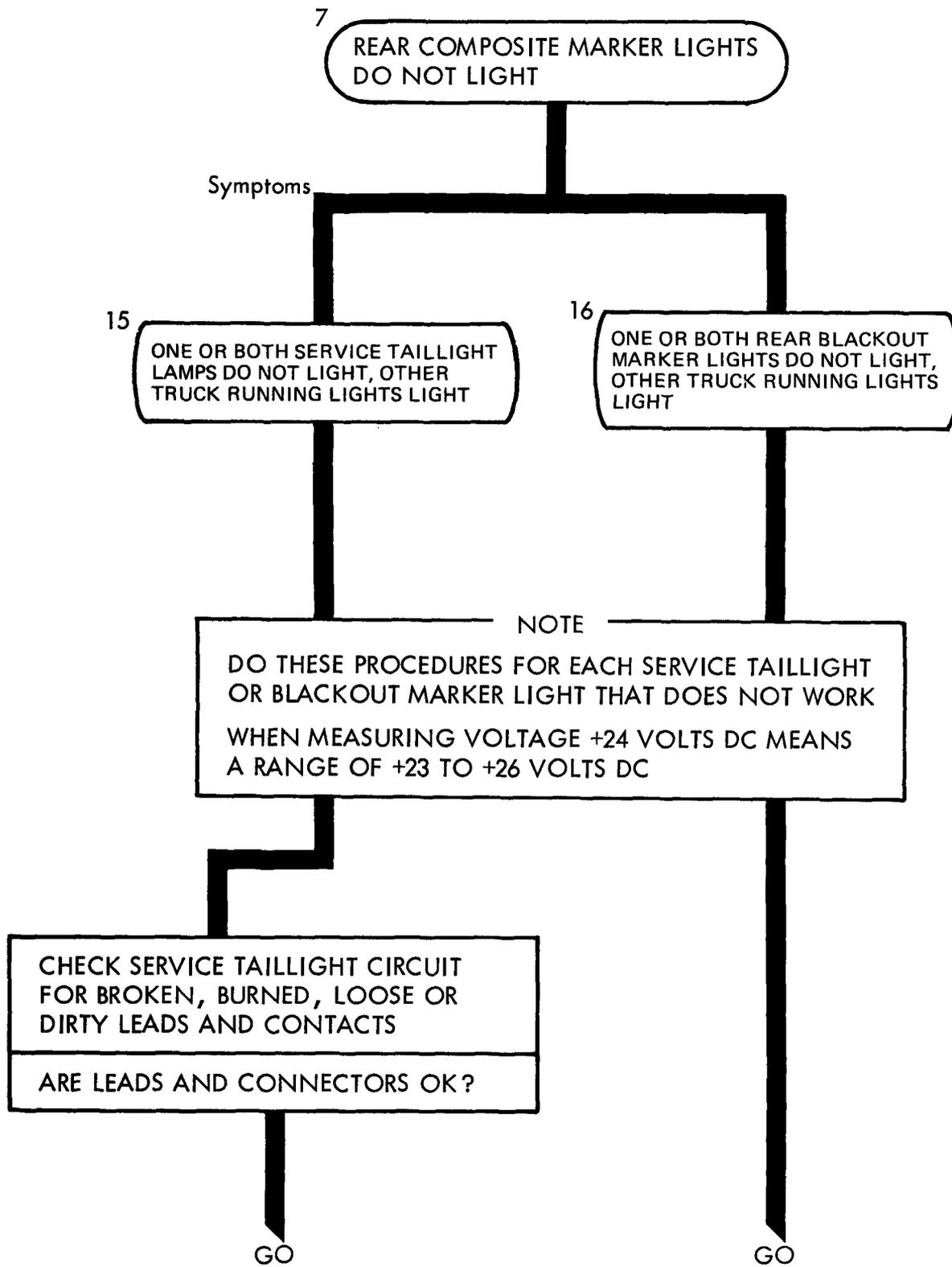
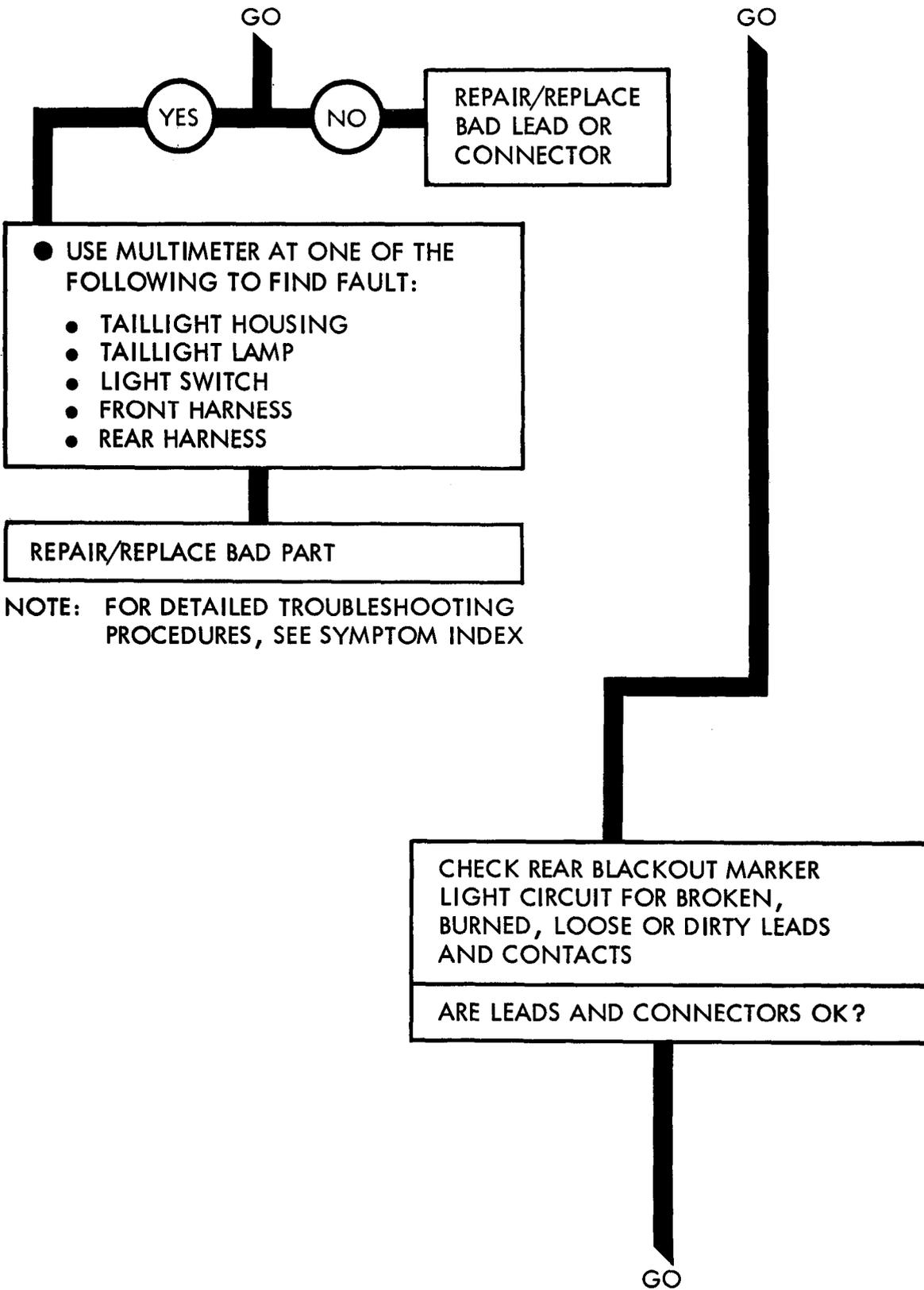
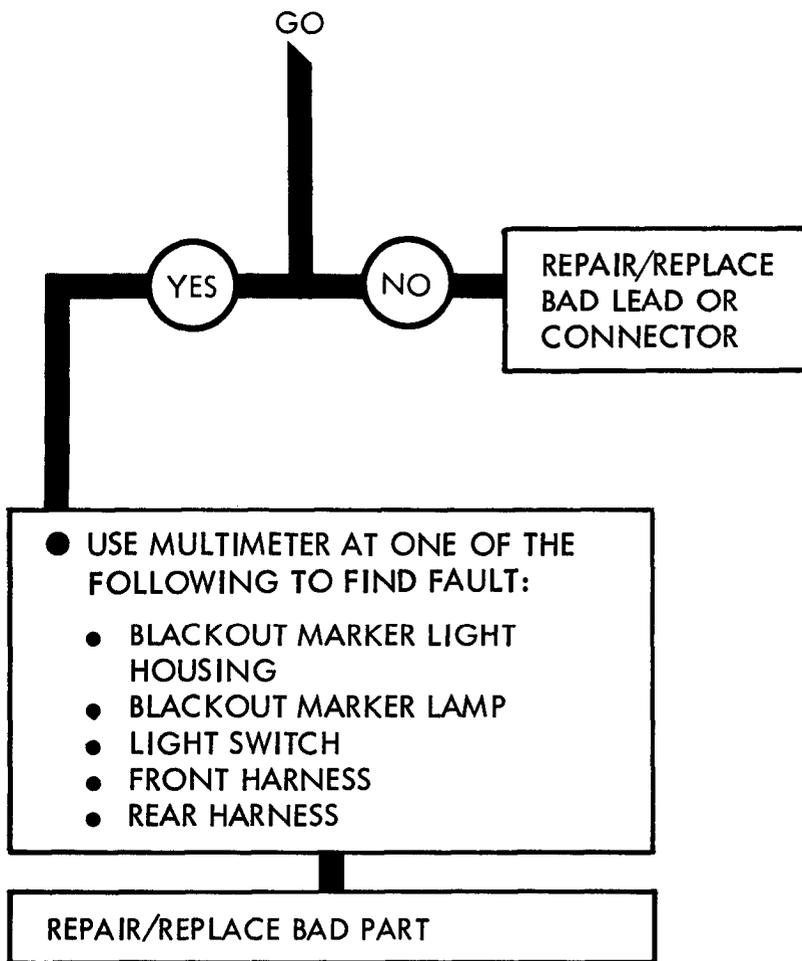

Figure 26-7 (Sheet 1 of 3)



NOTE: FOR DETAILED TROUBLESHOOTING PROCEDURES, SEE SYMPTOM INDEX

Figure 26-7 (Sheet 2 of 3)



NOTE: FOR DETAILED TROUBLESHOOTING PROCEDURES, SEE SYMPTOM INDEX

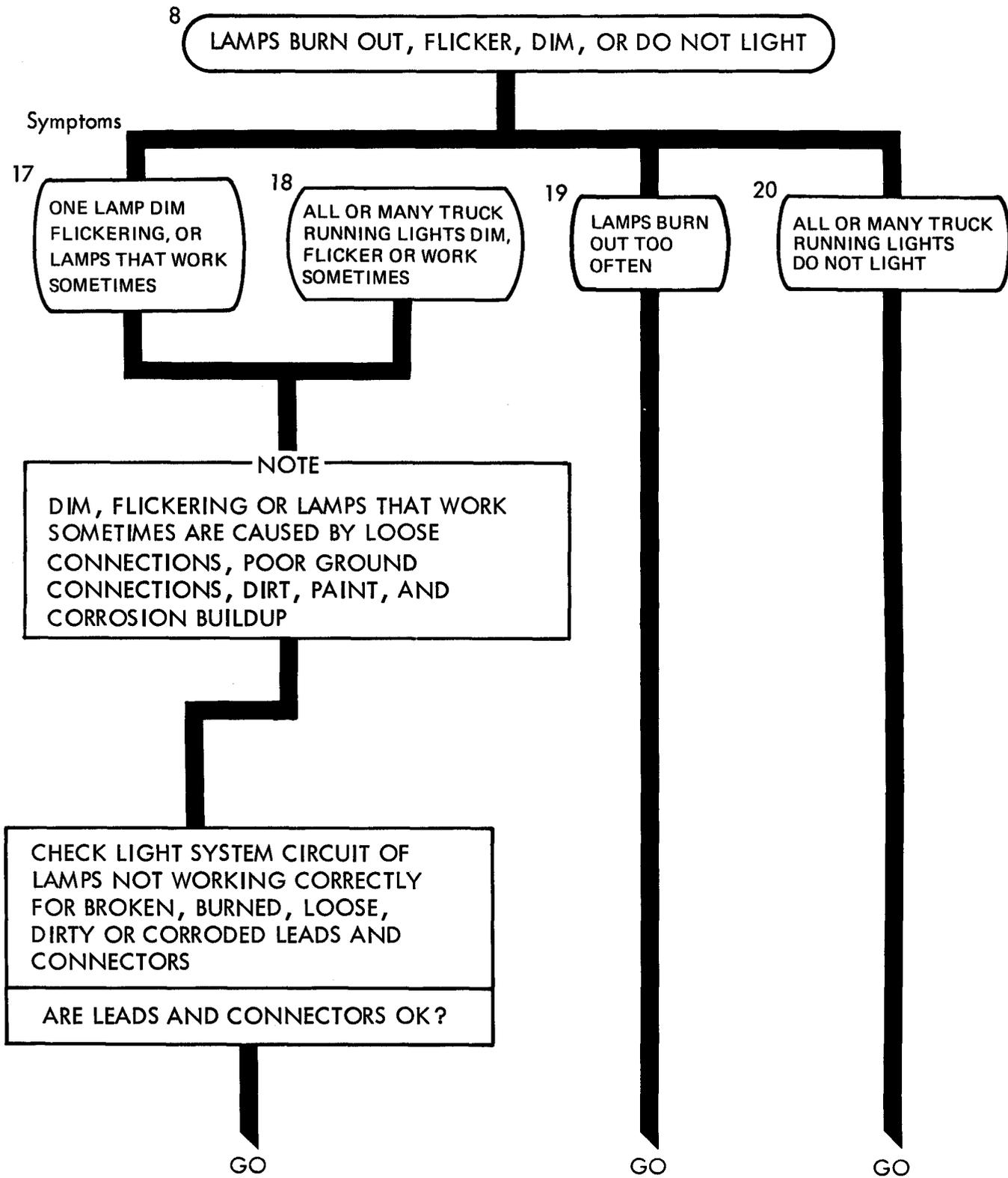
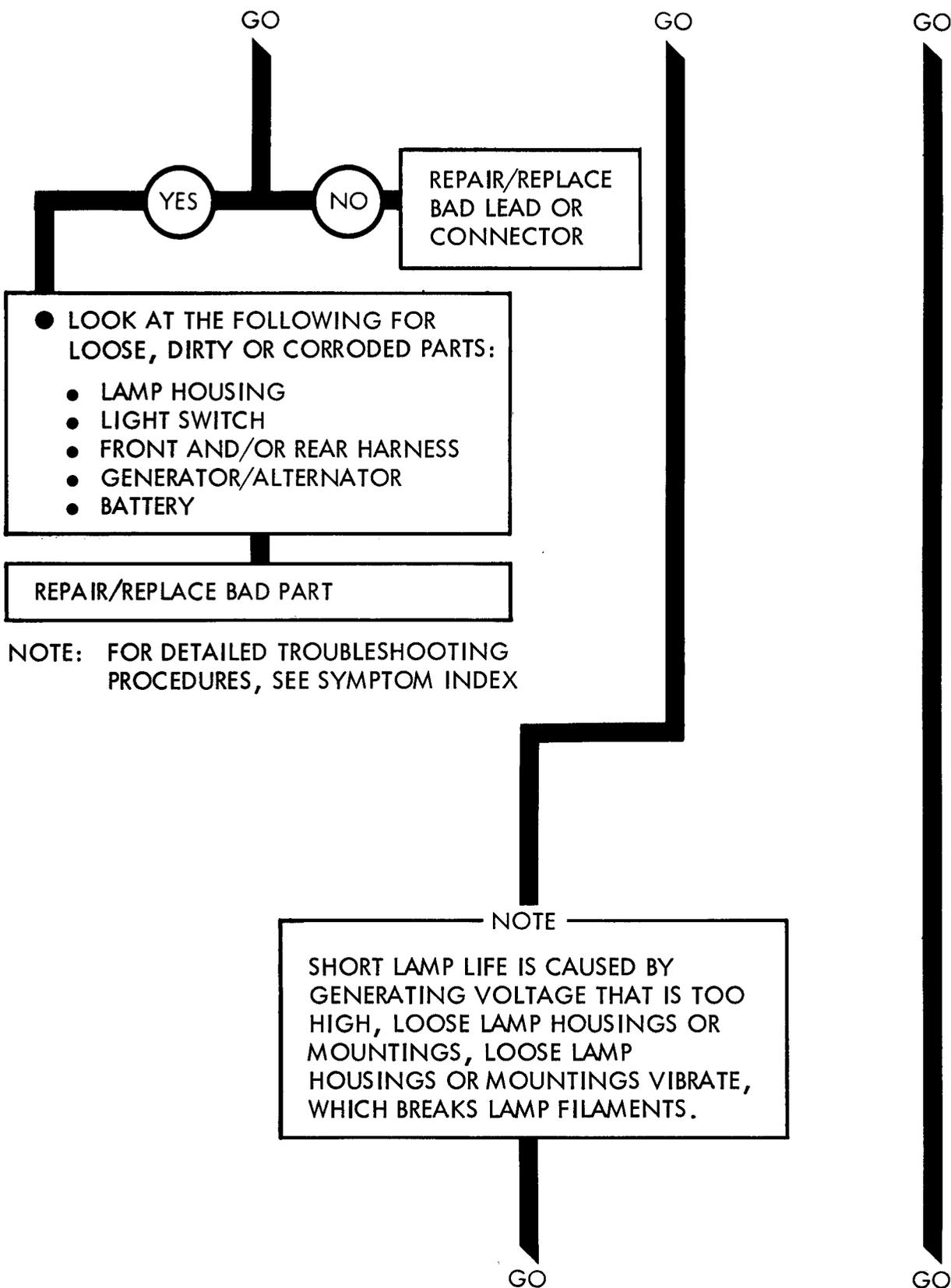

Figure 26-8 (Sheet 1 of 4)



NOTE: FOR DETAILED TROUBLESHOOTING PROCEDURES, SEE SYMPTOM INDEX

NOTE
SHORT LAMP LIFE IS CAUSED BY GENERATING VOLTAGE THAT IS TOO HIGH, LOOSE LAMP HOUSINGS OR MOUNTINGS, LOOSE LAMP HOUSINGS OR MOUNTINGS VIBRATE, WHICH BREAKS LAMP FILAMENTS.

Figure 26-8 (Sheet 2 of 4)

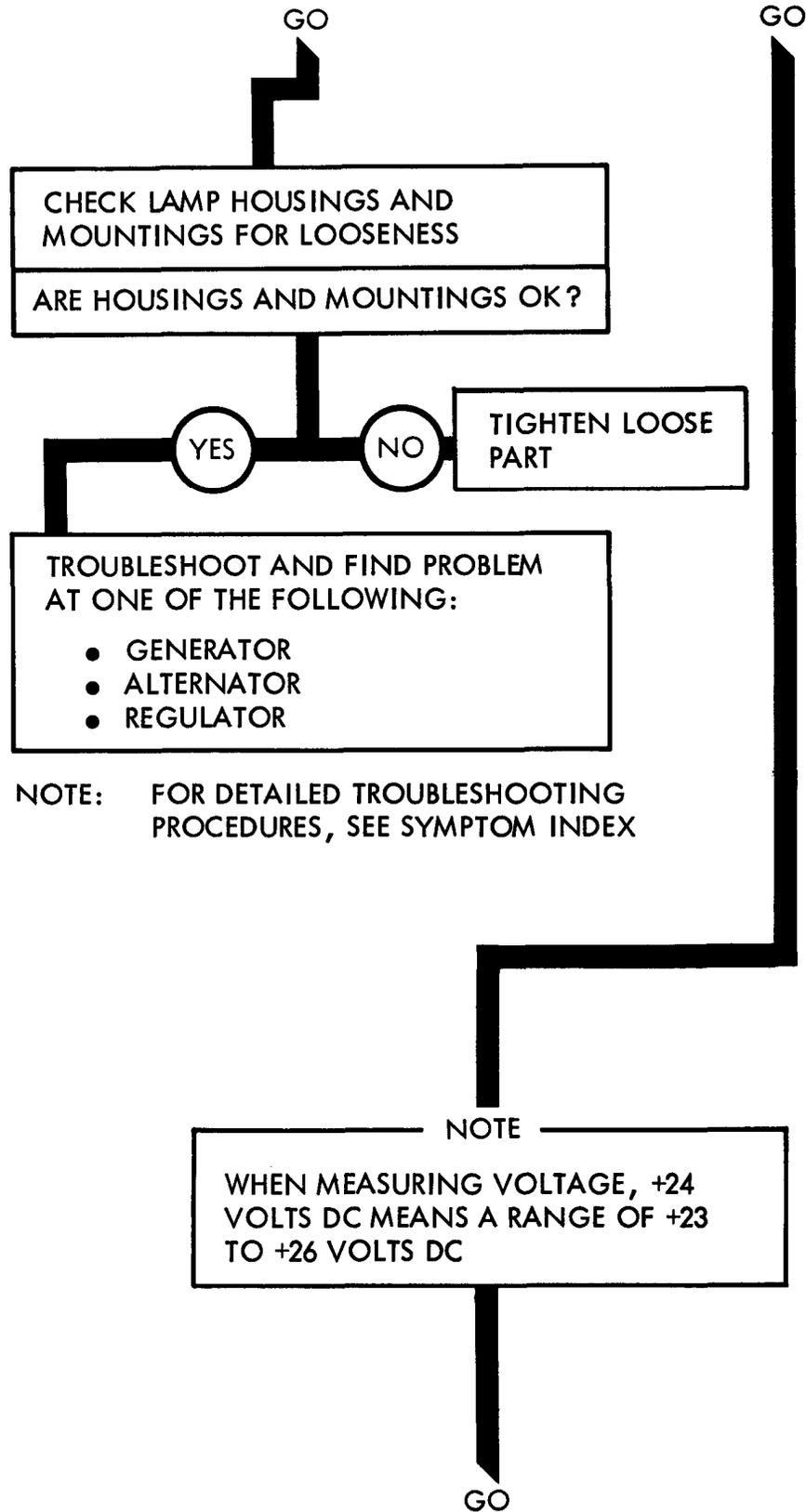

NOTE: FOR DETAILED TROUBLESHOOTING PROCEDURES, SEE SYMPTOM INDEX

NOTE

WHEN MEASURING VOLTAGE, +24 VOLTS DC MEANS A RANGE OF +23 TO +26 VOLTS DC

GO

Figure 26-8 (Sheet 3 of 4)

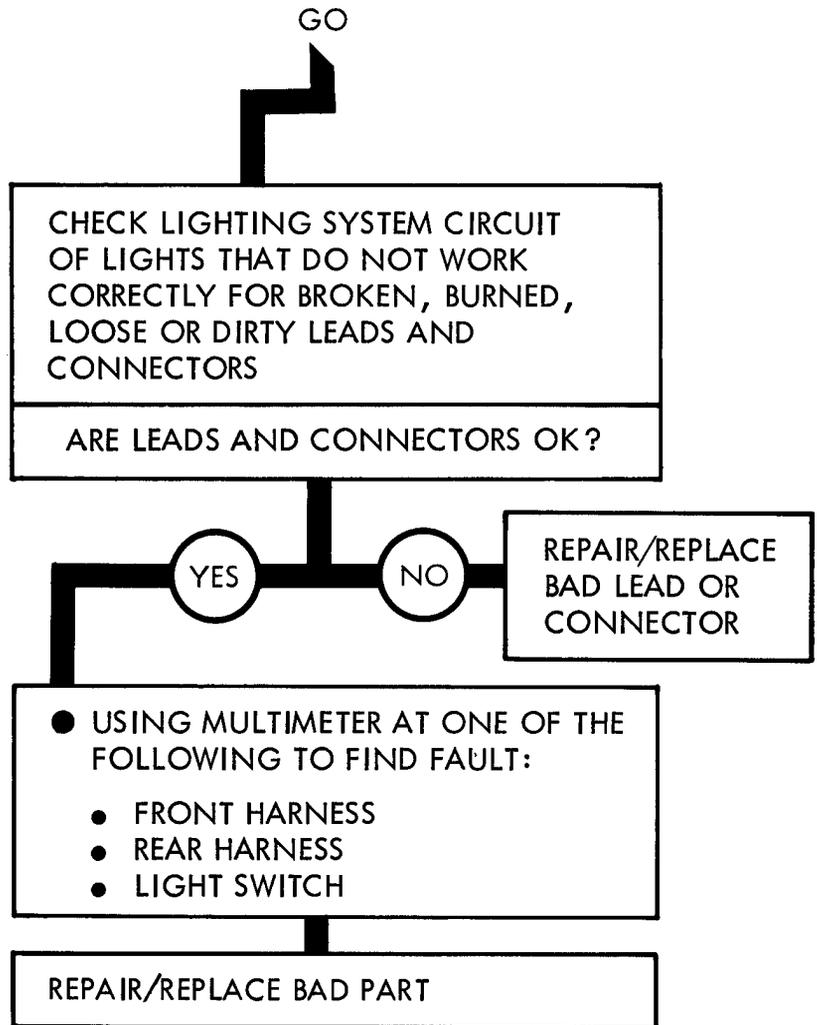

NOTE: FOR DETAILED TROUBLESHOOTING PROCEDURES, SEE SYMPTOM INDEX

Figure 26-8 (Sheet 4 of 4)

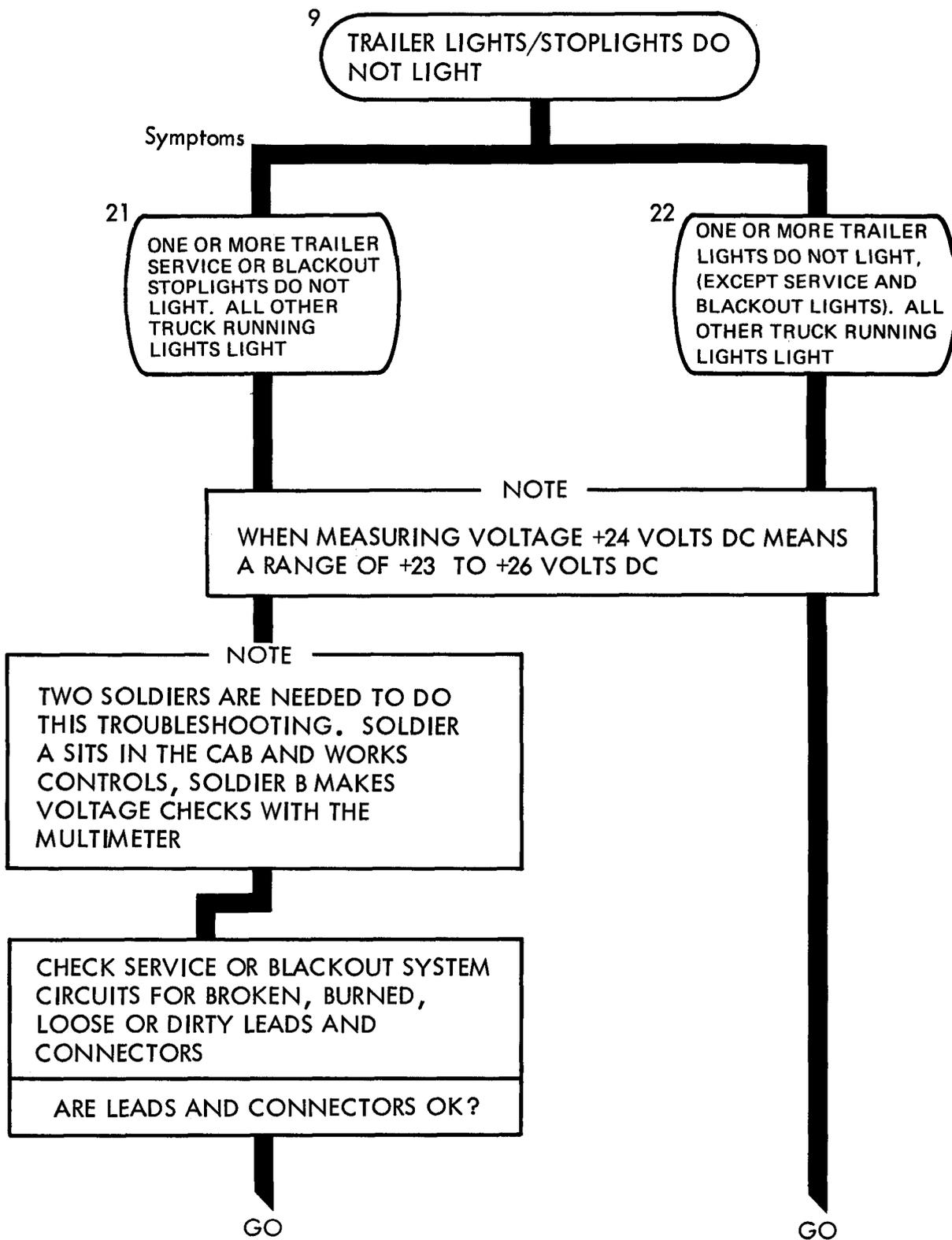

Figure 26-9 (Sheet 1 of 3)

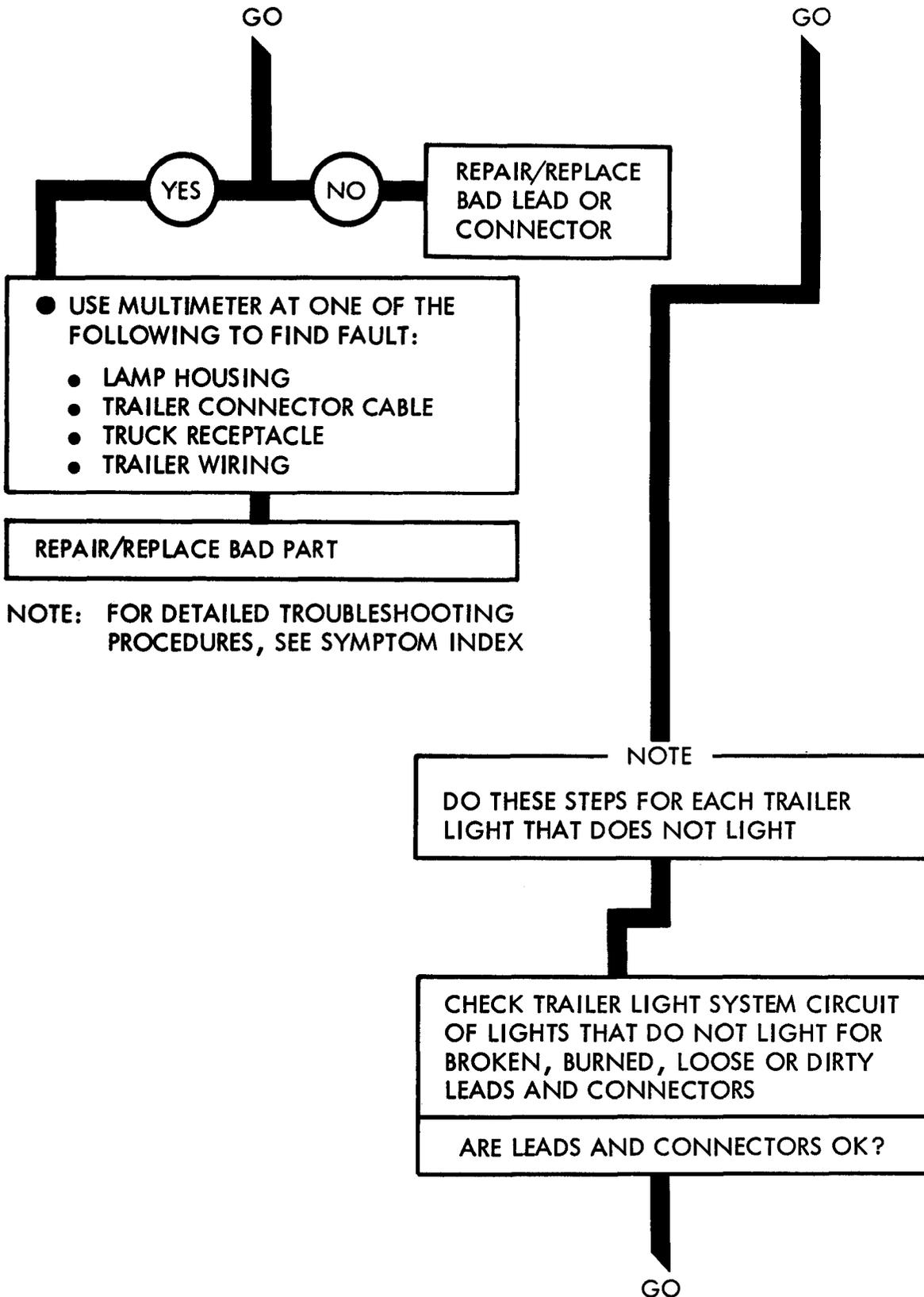
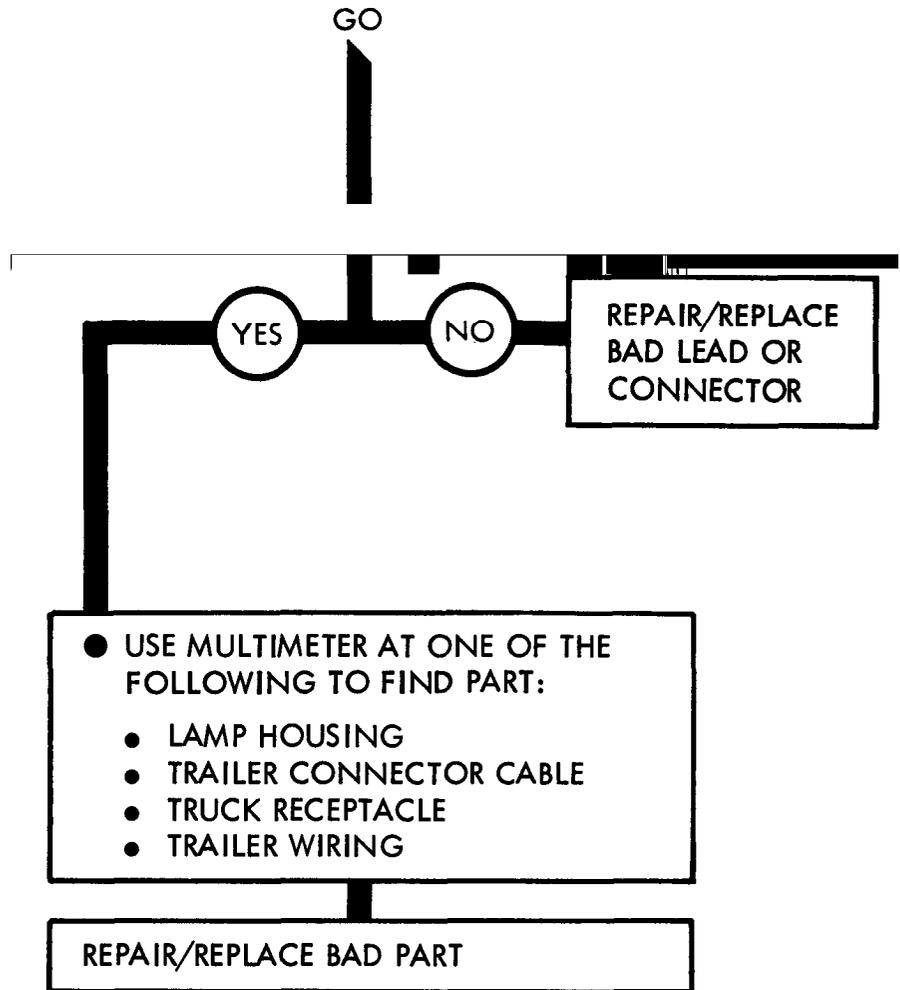

Figure 26-9 (Sheet 2 of 3)



NOTE: FOR DETAILED TROUBLESHOOTING PROCEDURES, SEE SYMPTOM INDEX

Figure 26-9 (Sheet 3 of 3)

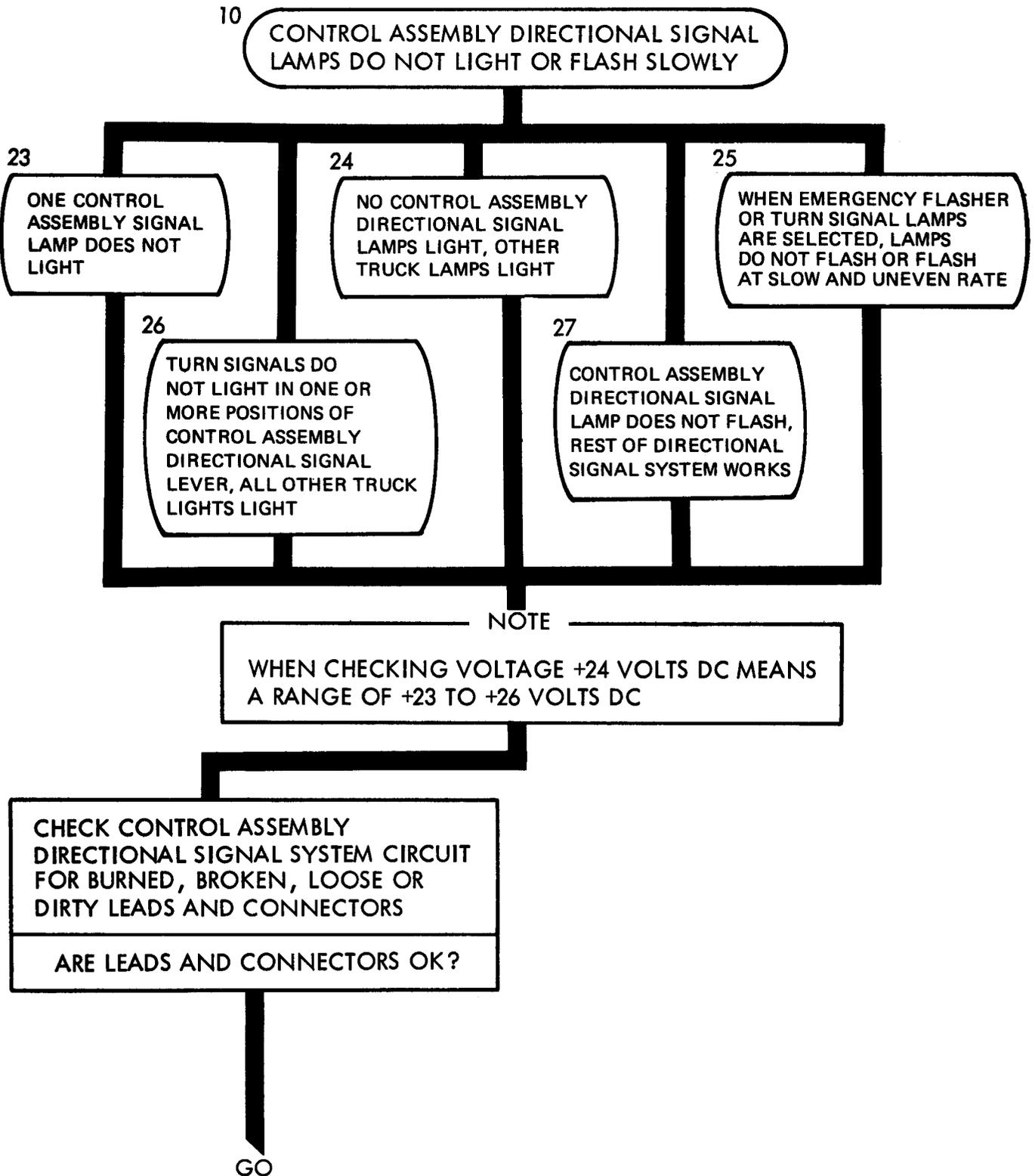
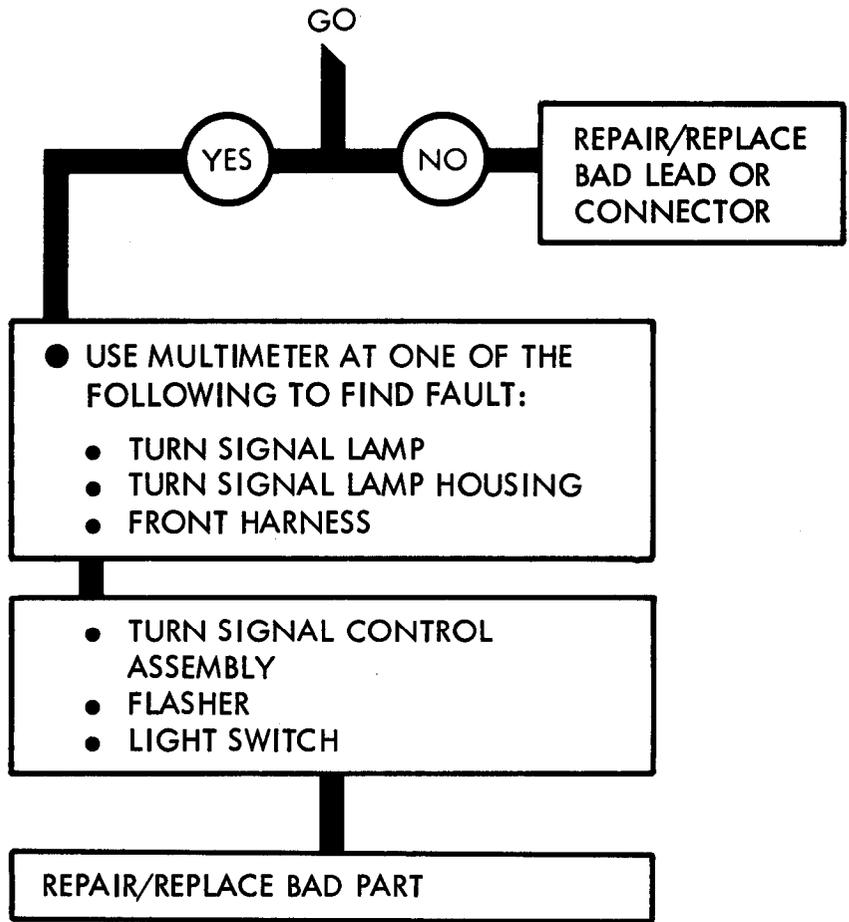

Figure 26-10 (Sheet 1 of 2)



NOTE: FOR DETAILED TROUBLESHOOTING PROCEDURES, SEE SYMPTOM INDEX

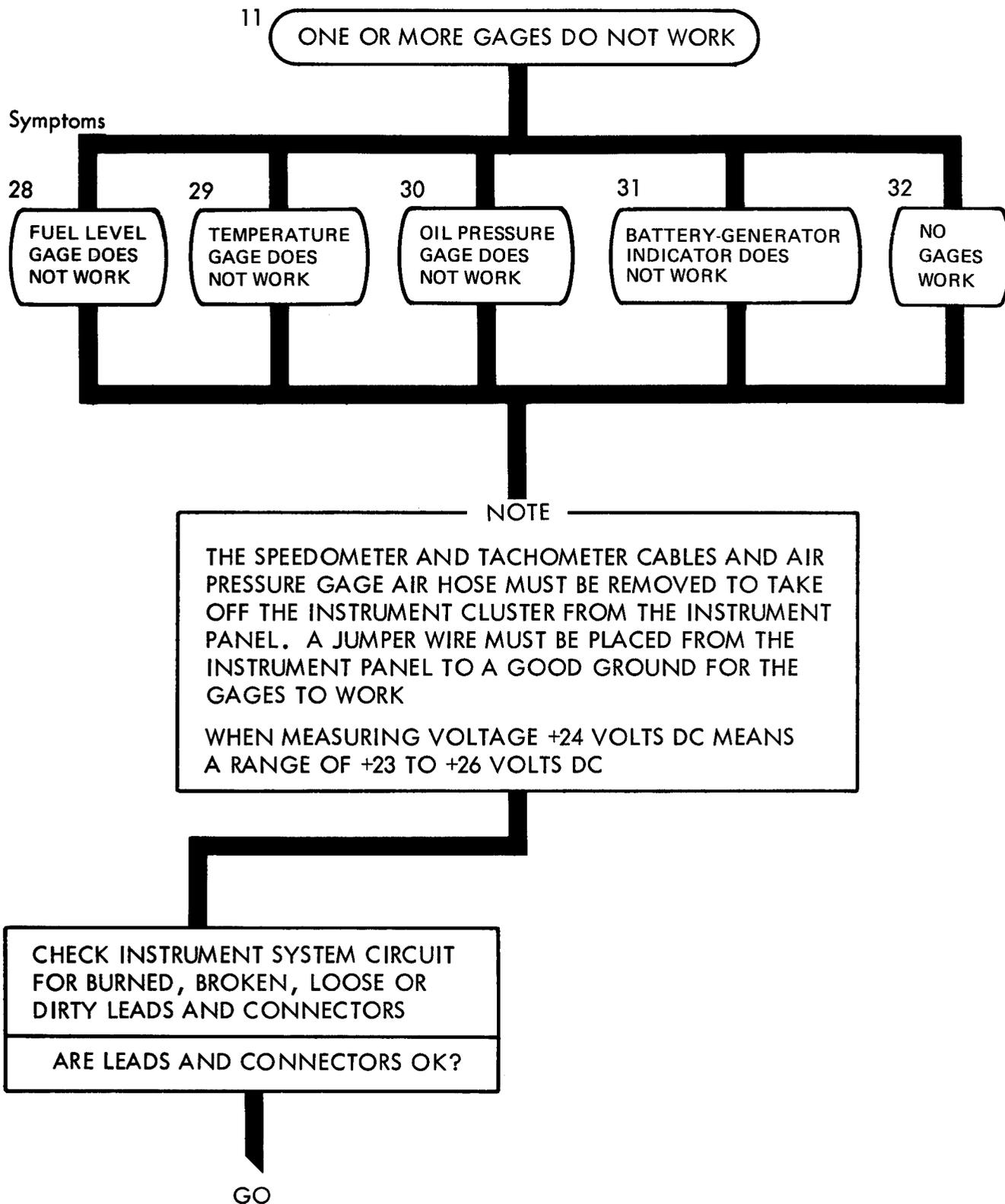
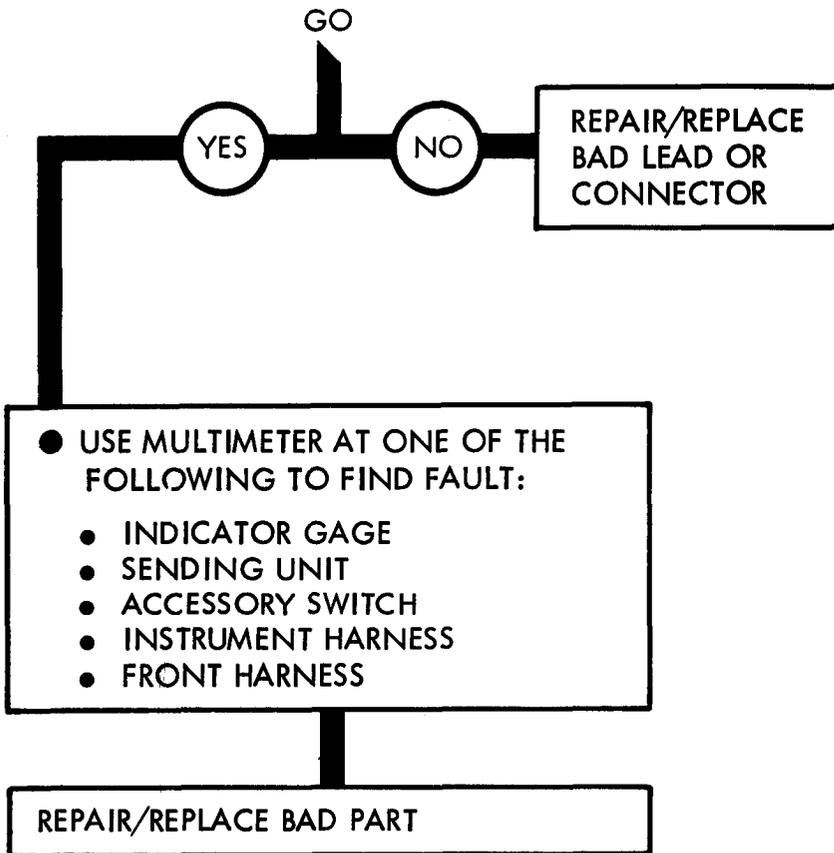

Figure 26-11 (Sheet 1 of 2)



NOTE: FOR DETAILED TROUBLESHOOTING PROCEDURES, SEE SYMPTOM INDEX

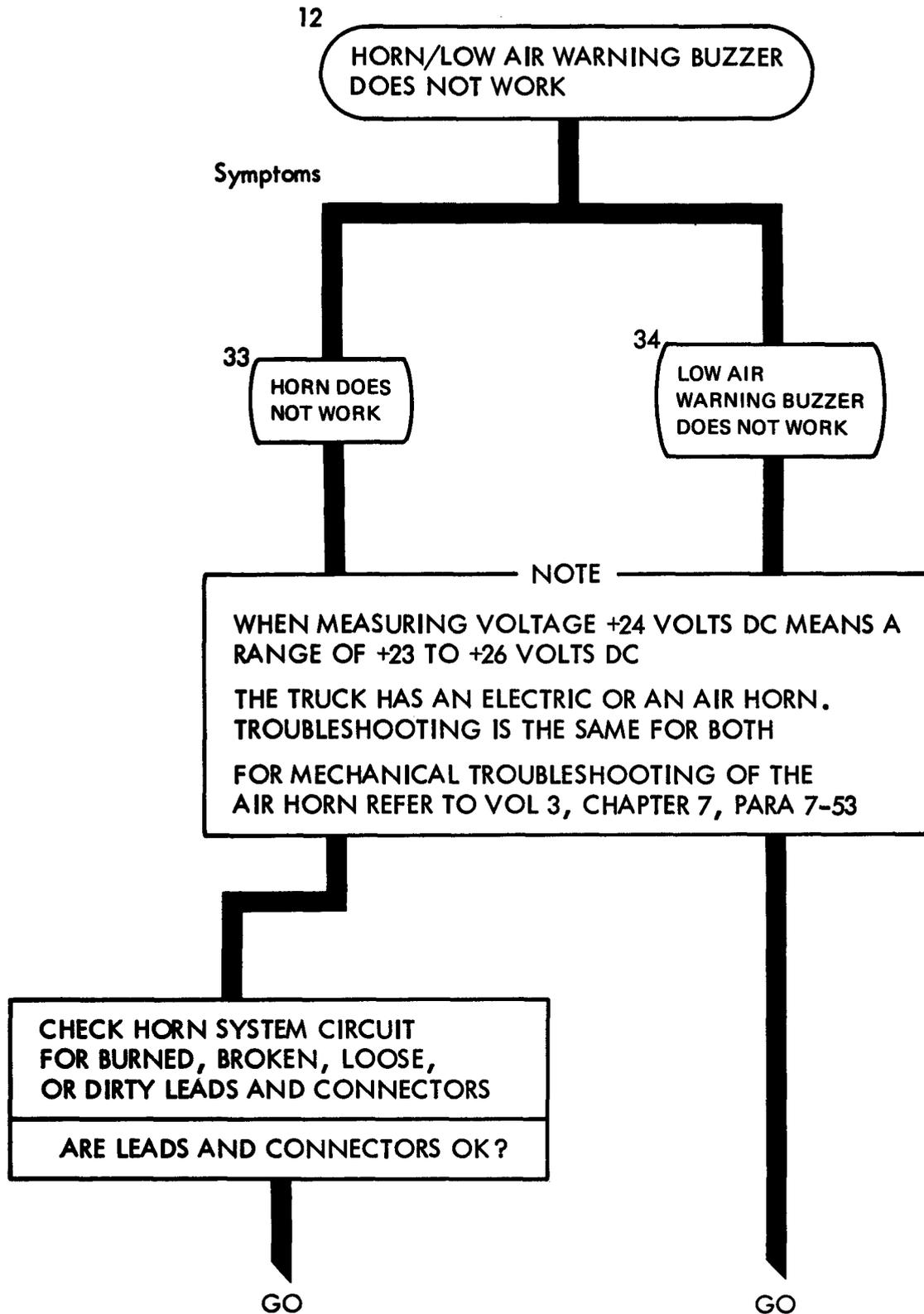
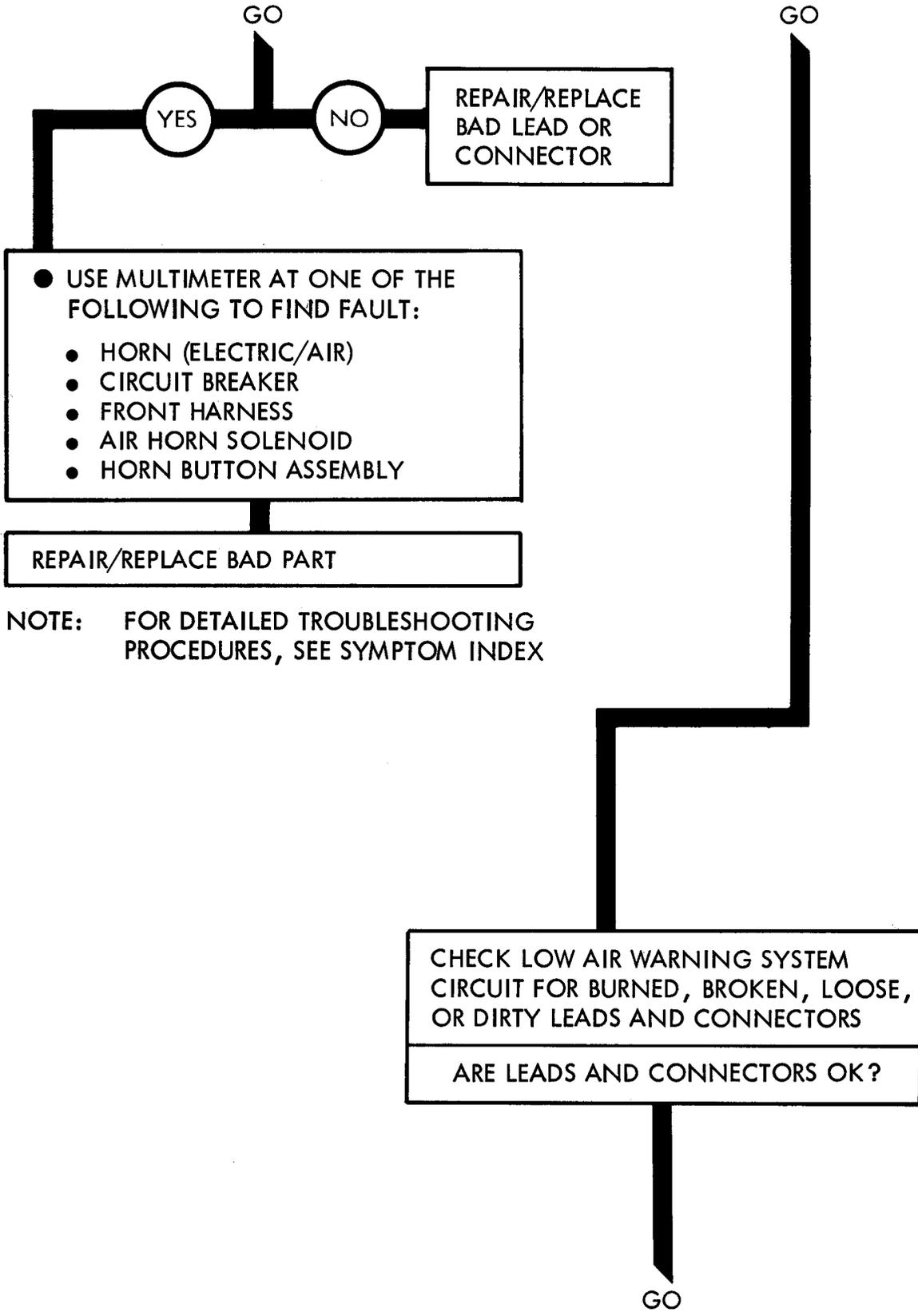
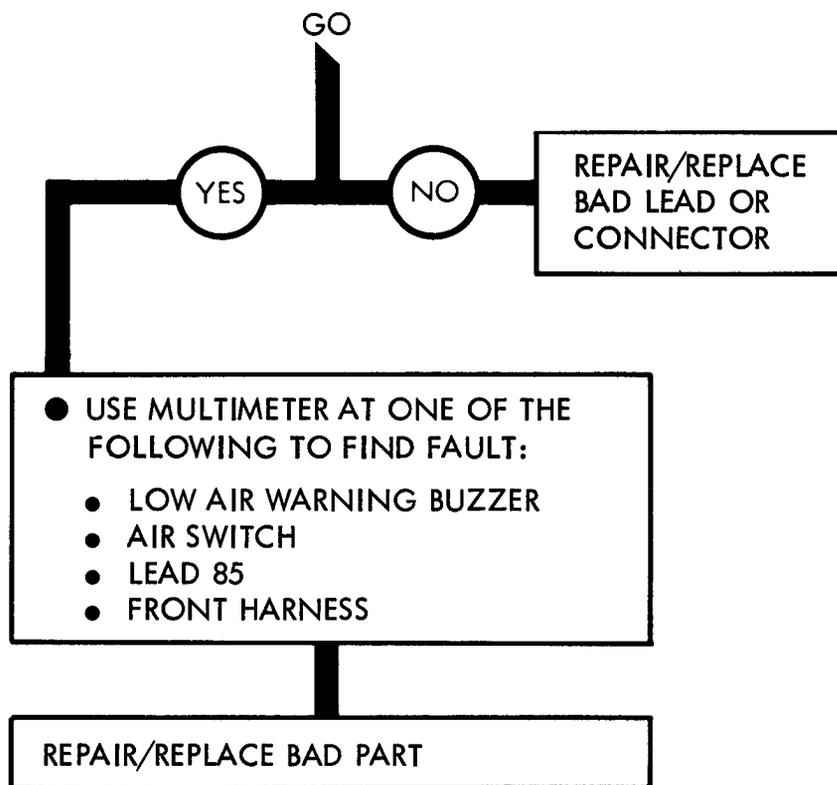

Figure 26-12 (Sheet 1 of 3)



NOTE: FOR DETAILED TROUBLESHOOTING PROCEDURES, SEE SYMPTOM INDEX

Figure 26-12 (Sheet 2 of 3)



NOTE: FOR DETAILED TROUBLESHOOTING PROCEDURES, SEE SYMPTOM INDEX

Figure 26-12 (Sheet 3 of 3)

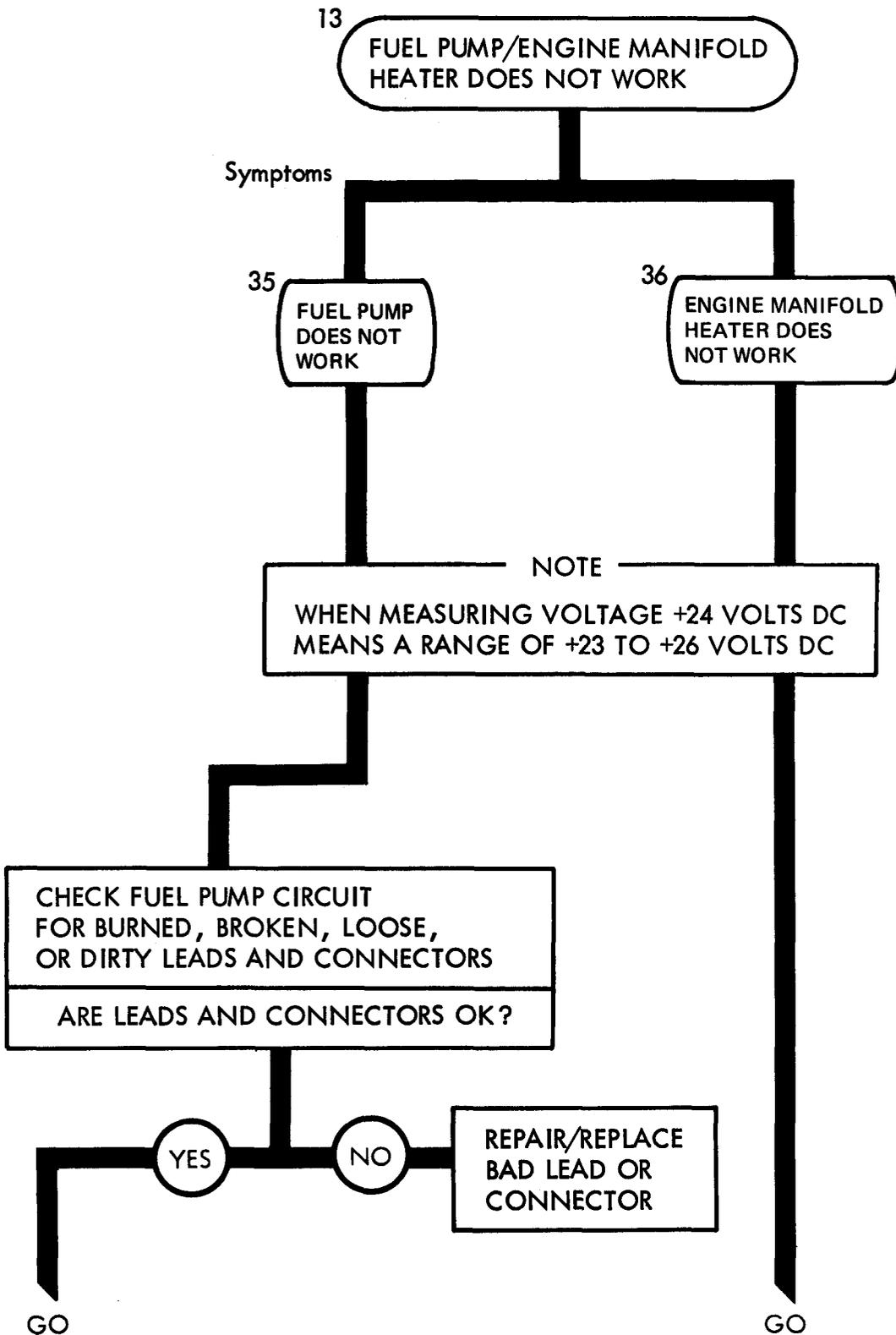
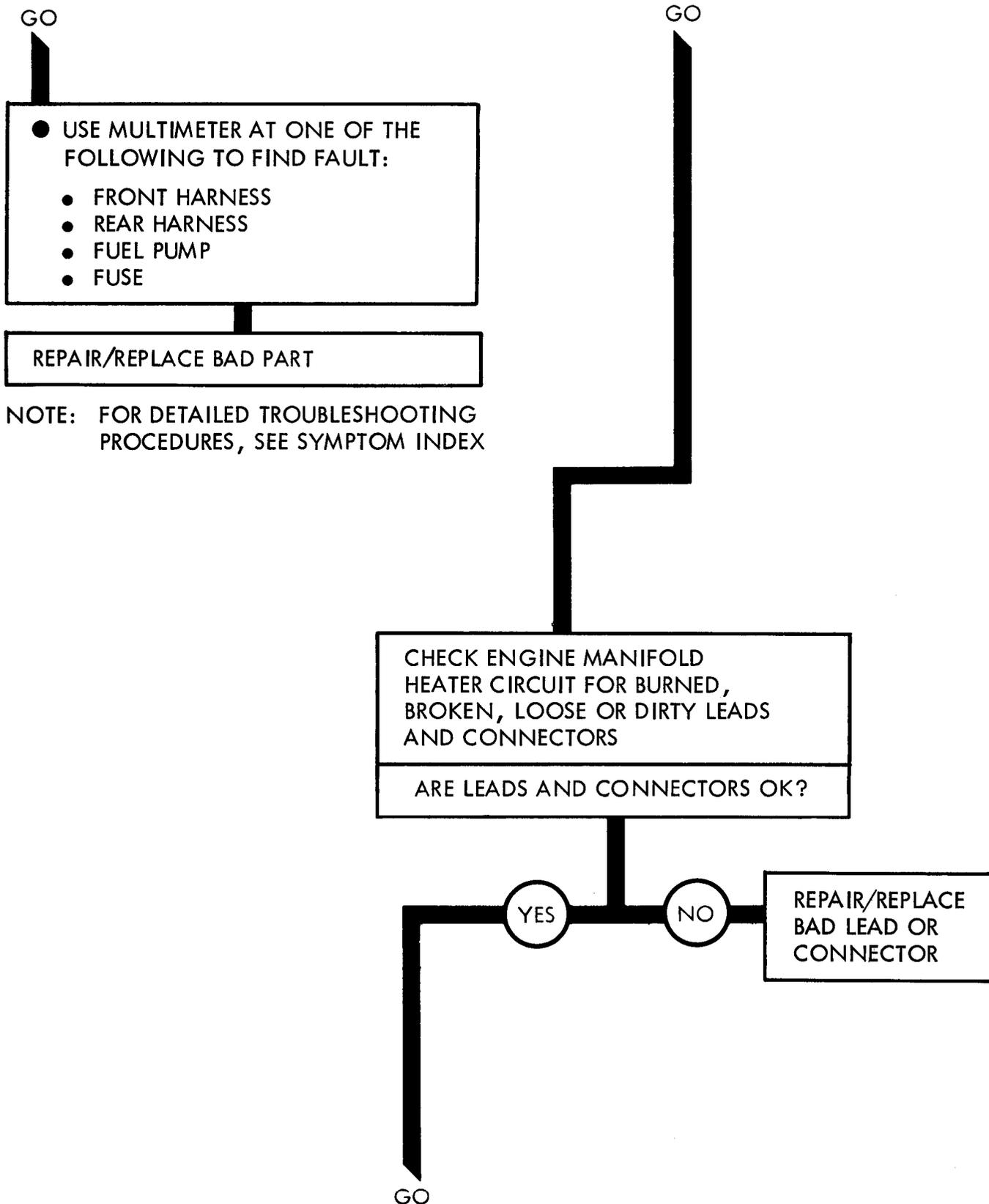
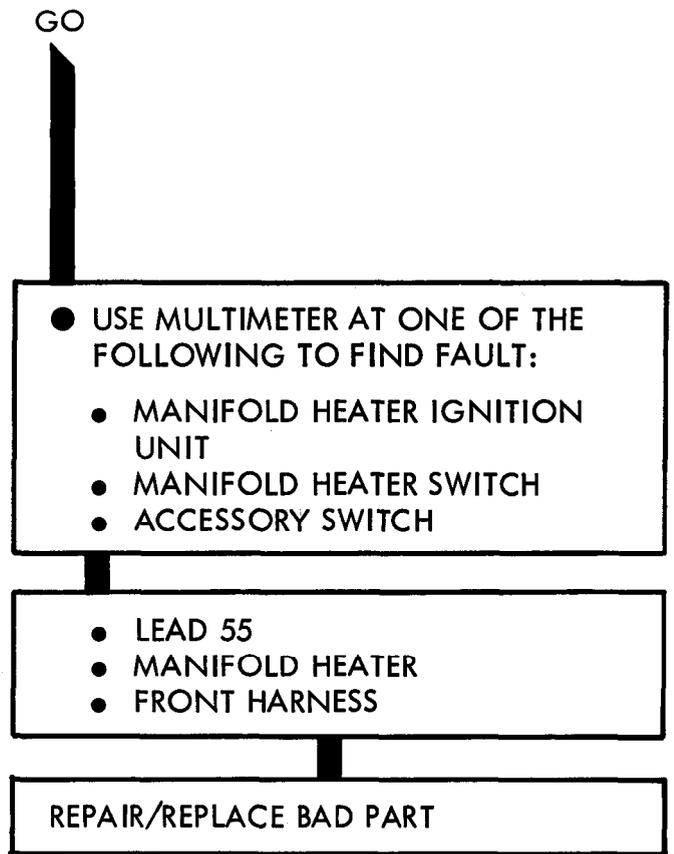

Figure 26-13 (Sheet 1 of 3)



NOTE: FOR DETAILED TROUBLESHOOTING PROCEDURES, SEE SYMPTOM INDEX

Figure 26-13 (Sheet 2 of 3)



NOTE: FOR DETAILED TROUBLESHOOTING PROCEDURES, SEE SYMPTOM INDEX

Figure 26-13 (Sheet 3 of 3)

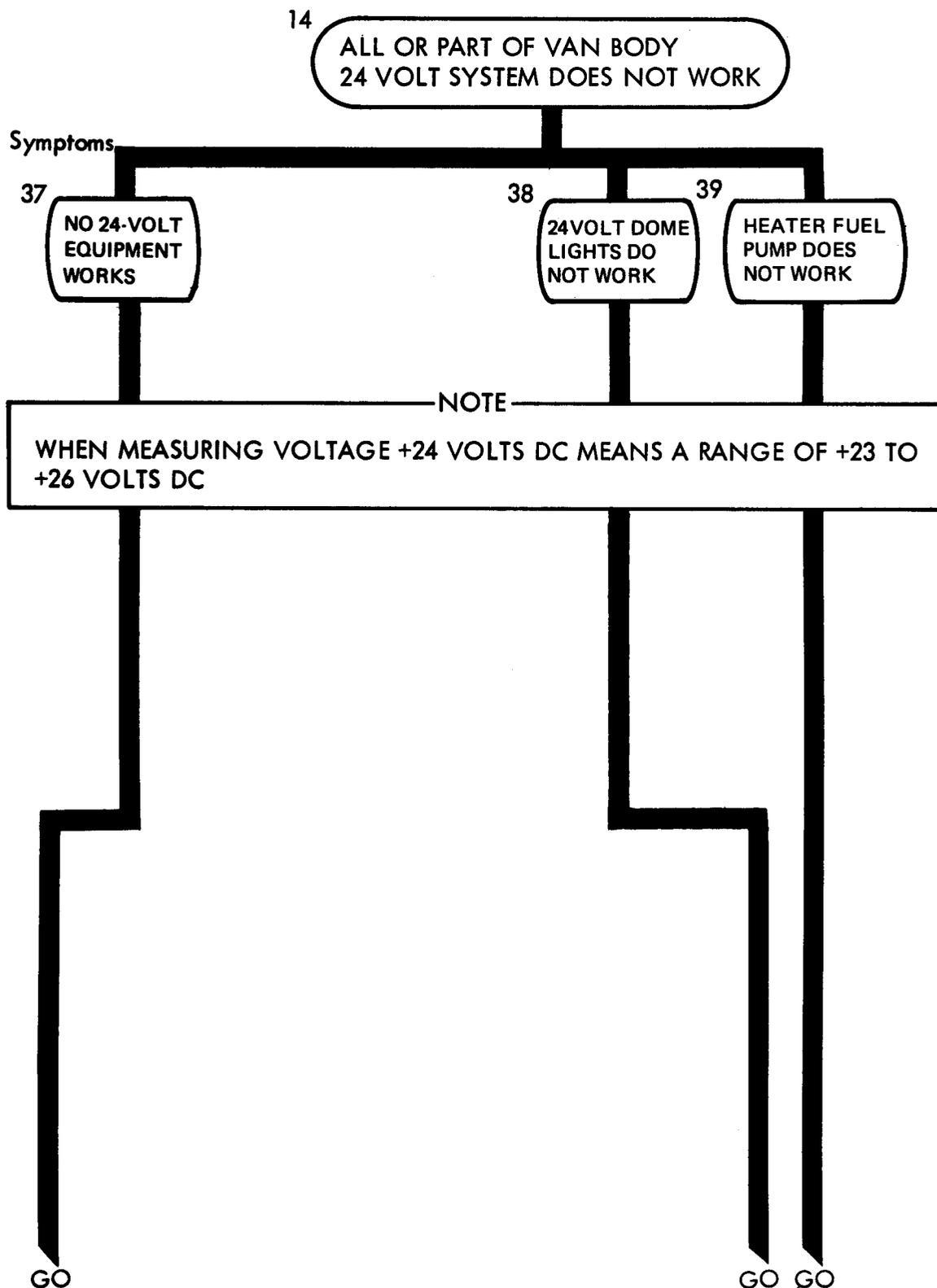

Figure 26-14 (Sheet 1 of 5)

GO

- USE MULTIMETER AT ONE OF THE FOLLOWING TO FIND FAULT:
 - HARNESS TO BATTERIES
 - CIRCUIT BREAKER
 - VAN WIRING HARNESS

REPAIR/REPLACE BAD PART

NOTE: FOR DETAILED TROUBLESHOOTING PROCEDURES, SEE SYMPTOM INDEX

GO GO GO

GO GO

Figure 26-14 (Sheet 2 of 5)

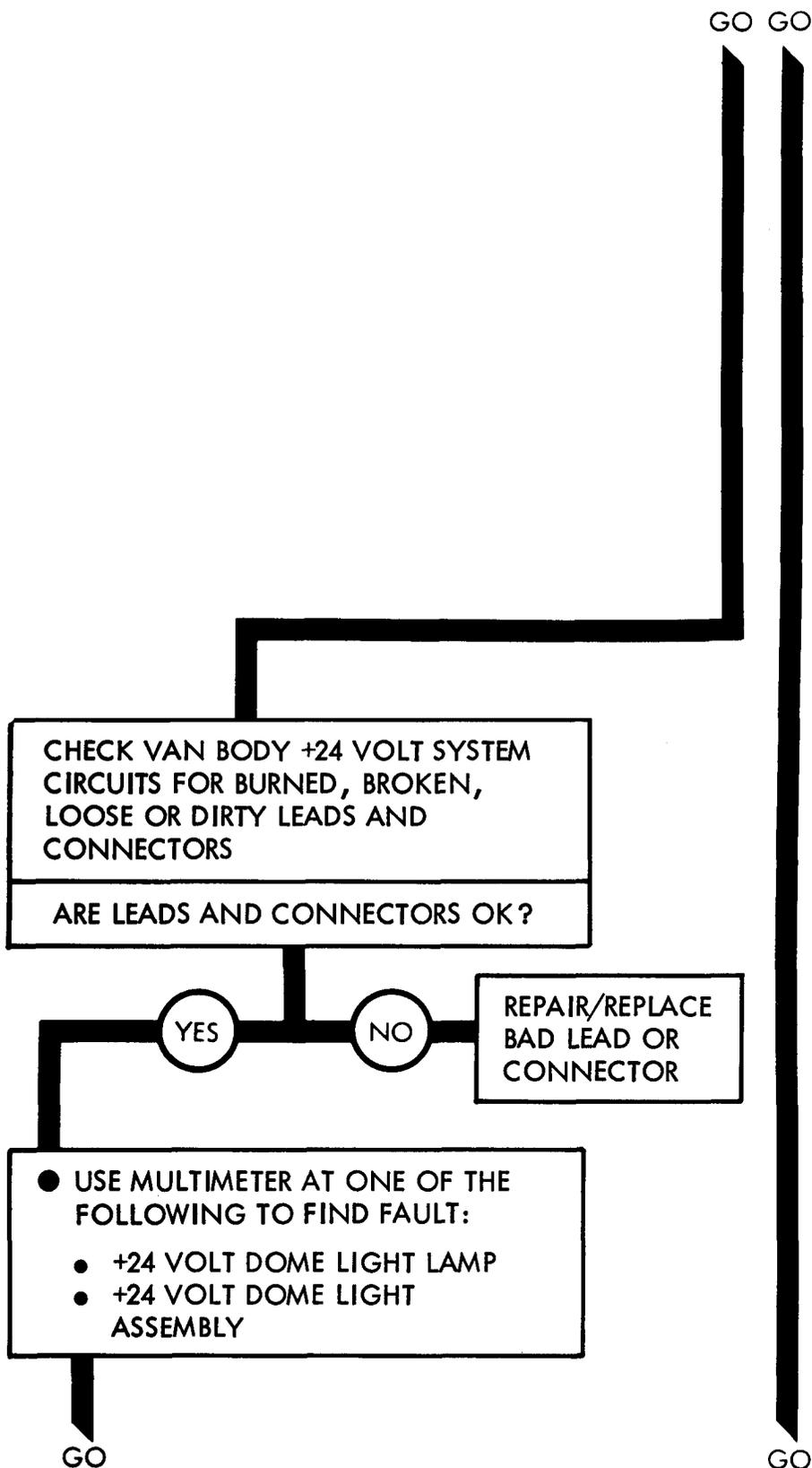

Figure 26-14 (Sheet 3 of 5)

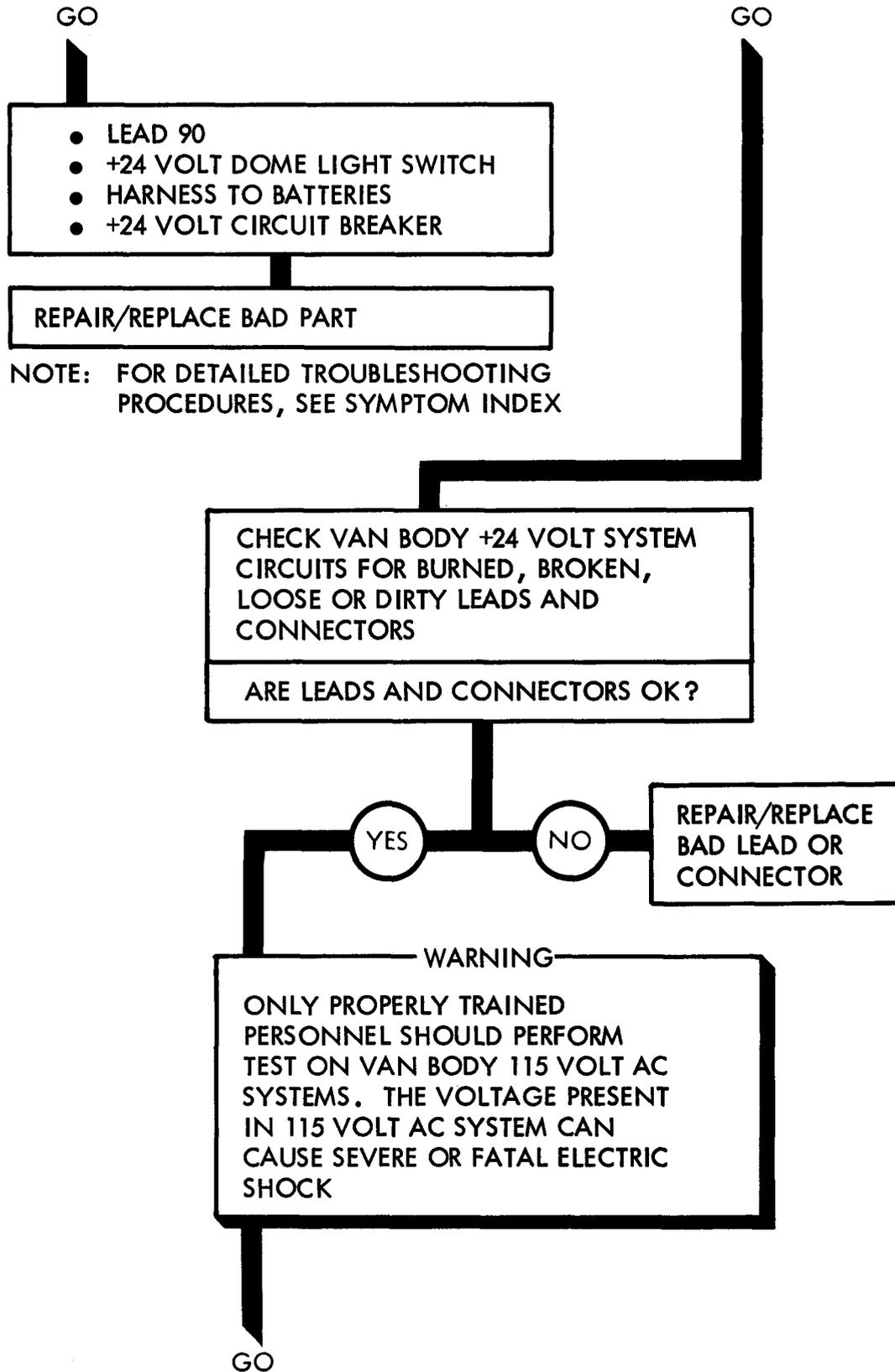

Figure 26-14 (Sheet 4 of 5)

GO

- USE MULTIMETER AT ONE OF THE FOLLOWING TO FIND FAULT:
 - HEATER FUEL PUMP
 - LEAD 25
 - HARNESS TO 115 VOLT AC SOURCE
 - CONVERTER

REPAIR/REPLACE BAD PART

NOTE: FOR DETAILED TROUBLESHOOTING PROCEDURES, SEE SYMPTOM INDEX

Figure 26-14 (Sheet 5 of 5)

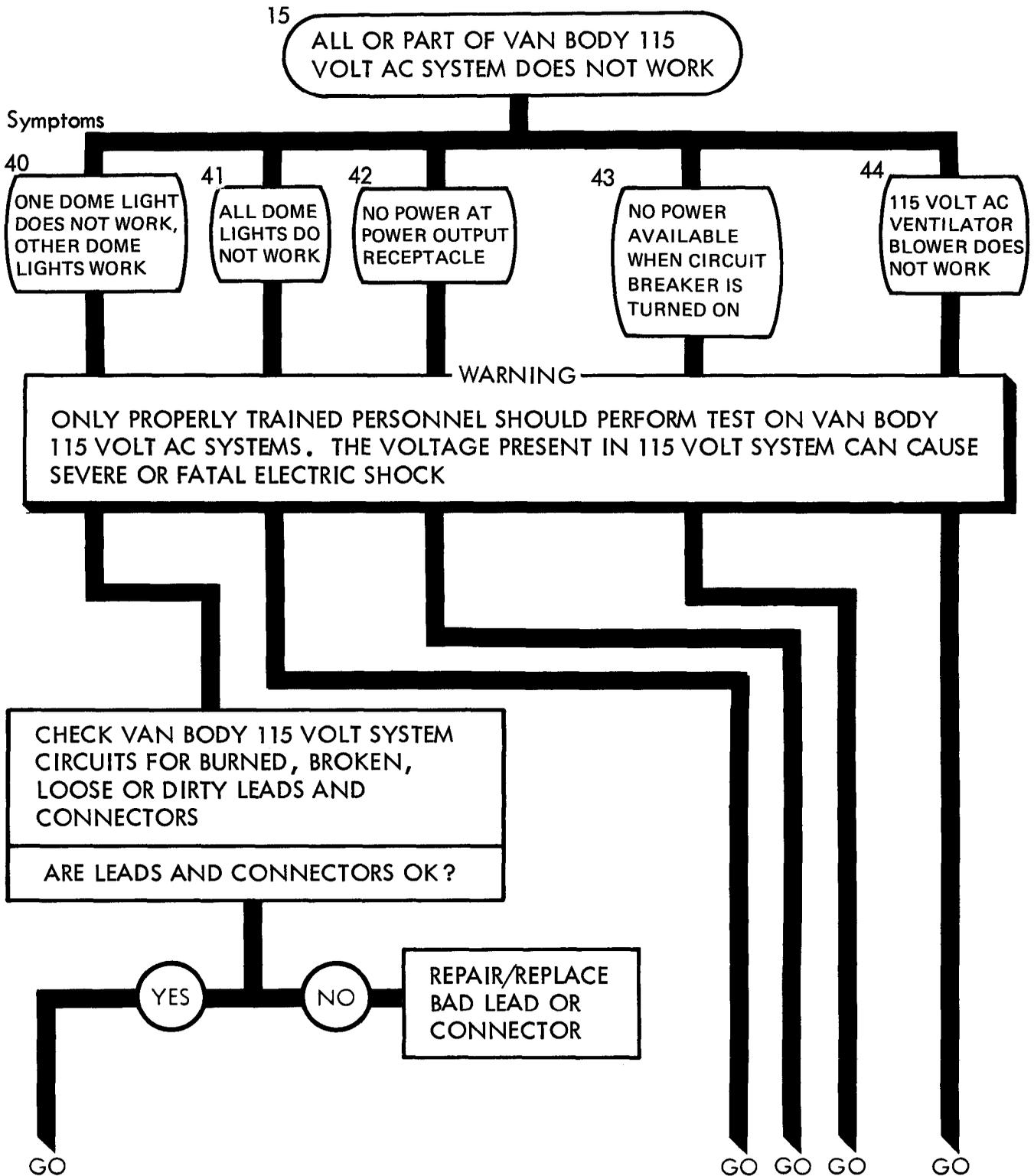

Figure 26-15 (Sheet 1 of 6)

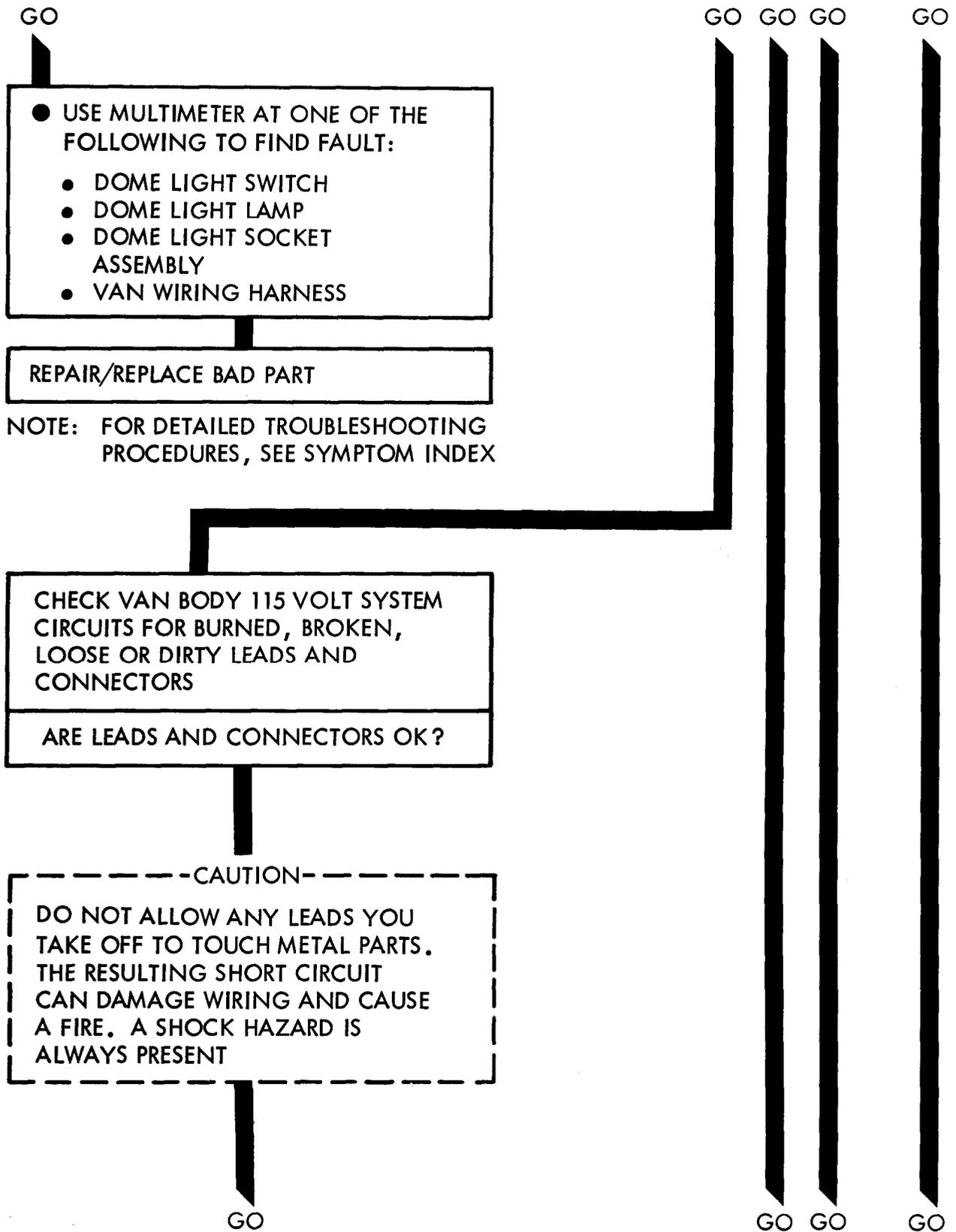

Figure 26-15 (Sheet 2 of 6)

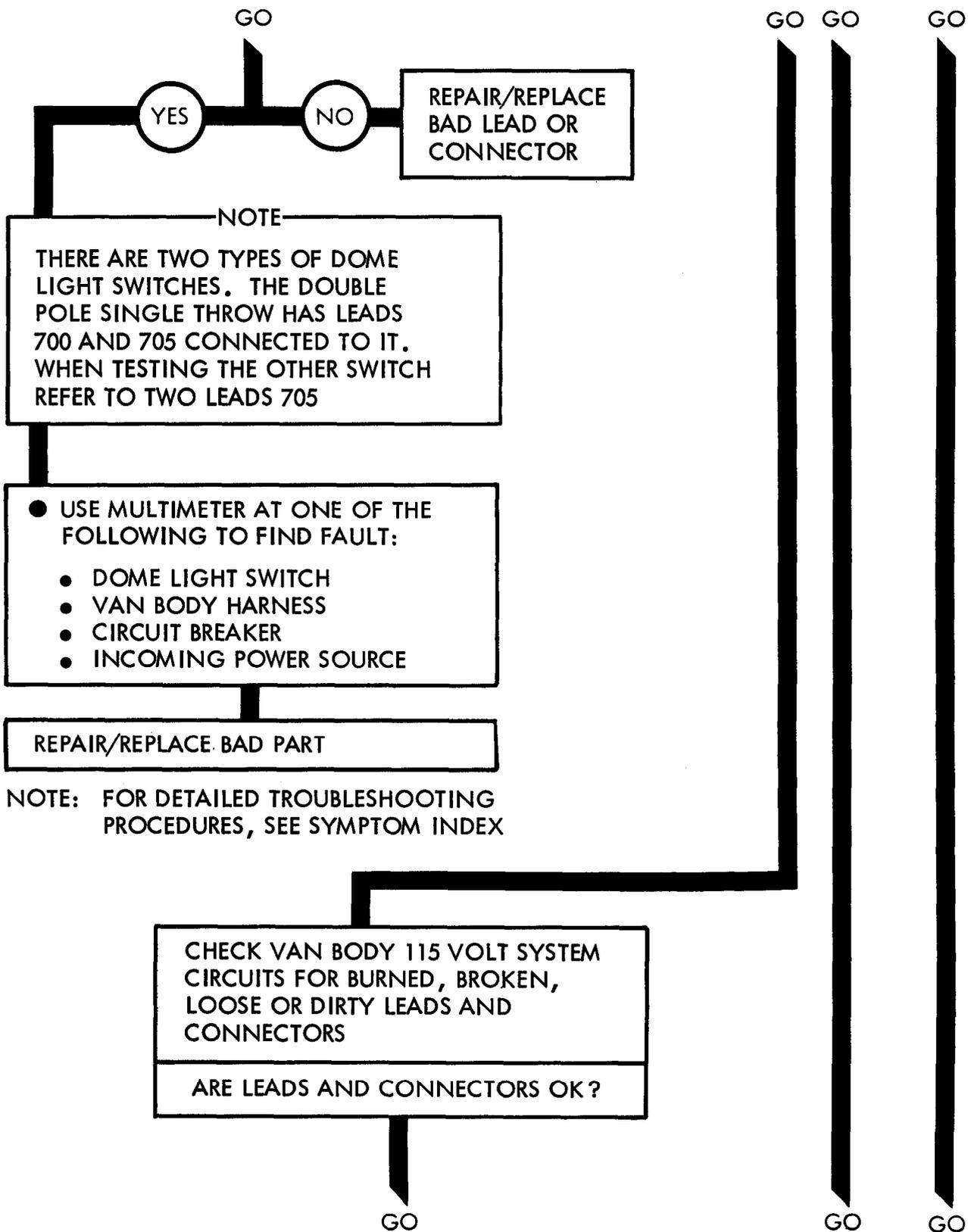

Figure 26-15 (Sheet 3 of 6)

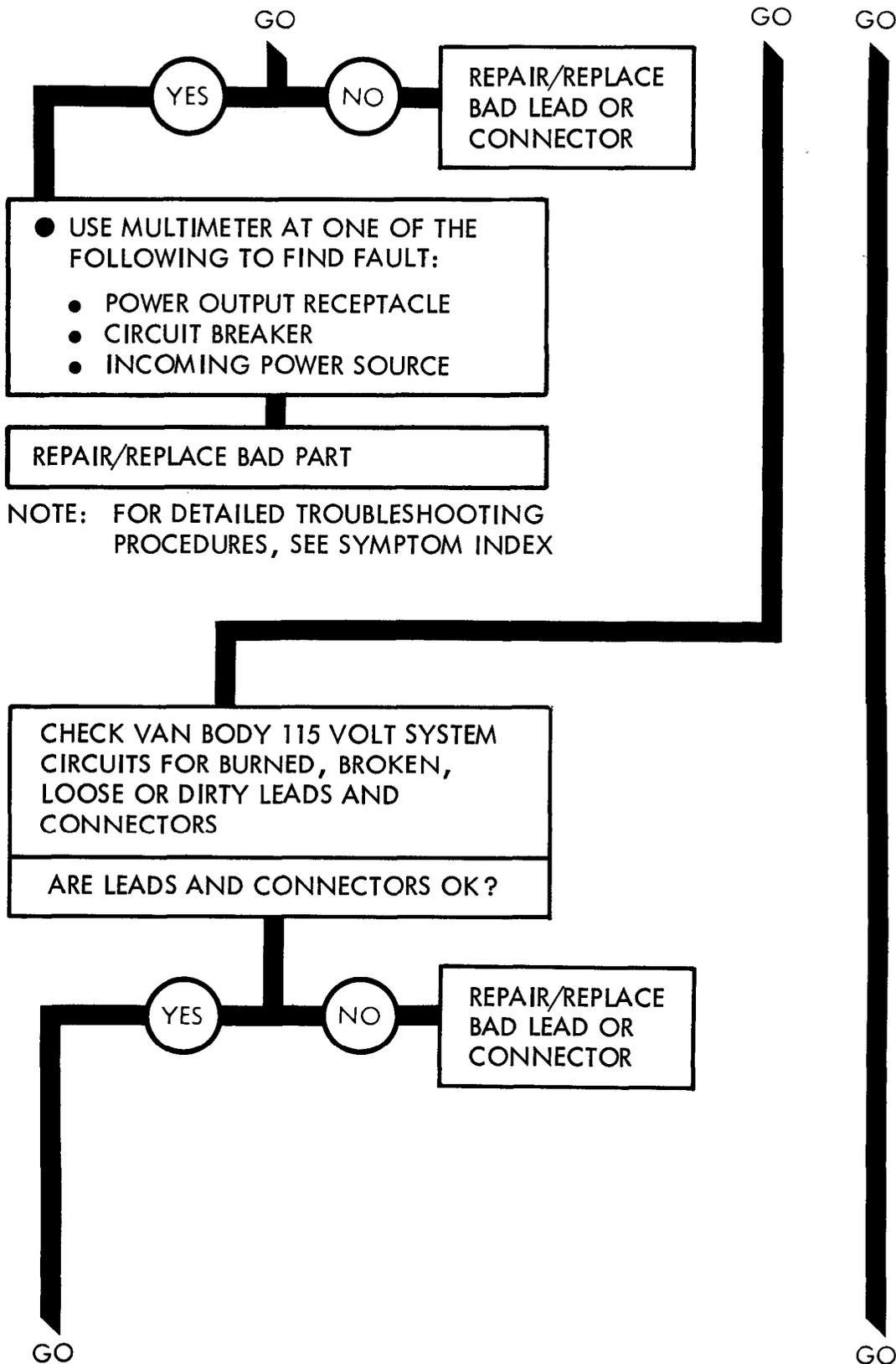

Figure 26-15 (Sheet 4 of 6)

GO



- USE MULTIMETER AT ONE OF THE FOLLOWING TO FIND FAULT:
 - INCOMING POWER SOURCE
 - CIRCUIT BREAKER



REPAIR/REPLACE BAD PART

NOTE: FOR DETAILED TROUBLESHOOTING PROCEDURES, SEE SYMPTOM INDEX

GO



GO

GO

CHECK VAN BODY 115 VOLT SYSTEM
CIRCUITS FOR BURNED, BROKEN,
LOOSE OR DIRTY LEADS AND
CONNECTORS

ARE LEADS AND CONNECTORS OK?

YES

NO

REPAIR/REPLACE
BAD LEAD OR
CONNECTOR

- USE MULTIMETER AT ONE OF THE FOLLOWING TO FIND FAULT:
 - INCOMING POWER SOURCE
 - CIRCUIT BREAKER
 - WIRING HARNESS
 - VENTILATOR BLOWER

REPAIR/ REPLACE BAD PART

NOTE: FOR DETAILED TROUBLESHOOTING
PROCEDURES, SEE SYMPTOM INDEX

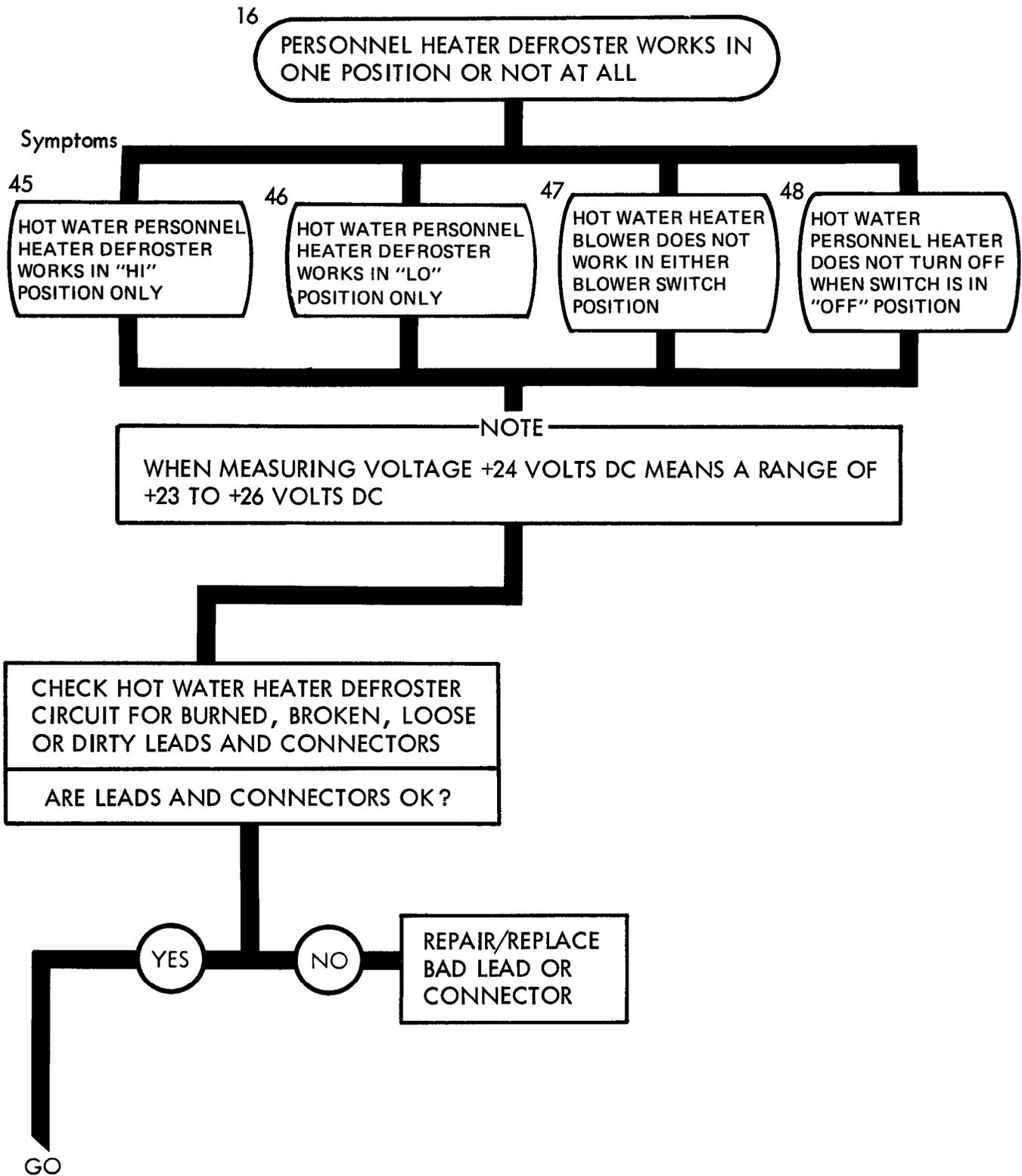

Figure 26-16 (Sheet 1 of 2)

GO

● USE MULTIMETER AT ONE OF THE FOLLOWING TO FIND FAULT:

- HEATER RESISTOR
- HEATER CONTROL SWITCH
- HEATER KIT CIRCUIT BREAKER
- LEAD FROM CONTROL SWITCH TO BLOWER MOTOR
- BLOWER MOTOR

- "Y" CONNECTOR LEAD
- LEAD FROM TRUCK CIRCUIT BREAKER
- TRUCK CIRCUIT BREAKER
- FRONT HARNESS

● LOOK FOR FAULT AT ONE OF THE FOLLOWING:

- CROSSED WIRES AT HEATER CONTROL SWITCH
- CORROSION BETWEEN TERMINALS

REMOVE/REPLACE BAD PART

NOTE: FOR DETAILED TROUBLESHOOTING PROCEDURES, SEE SYMPTOM INDEX

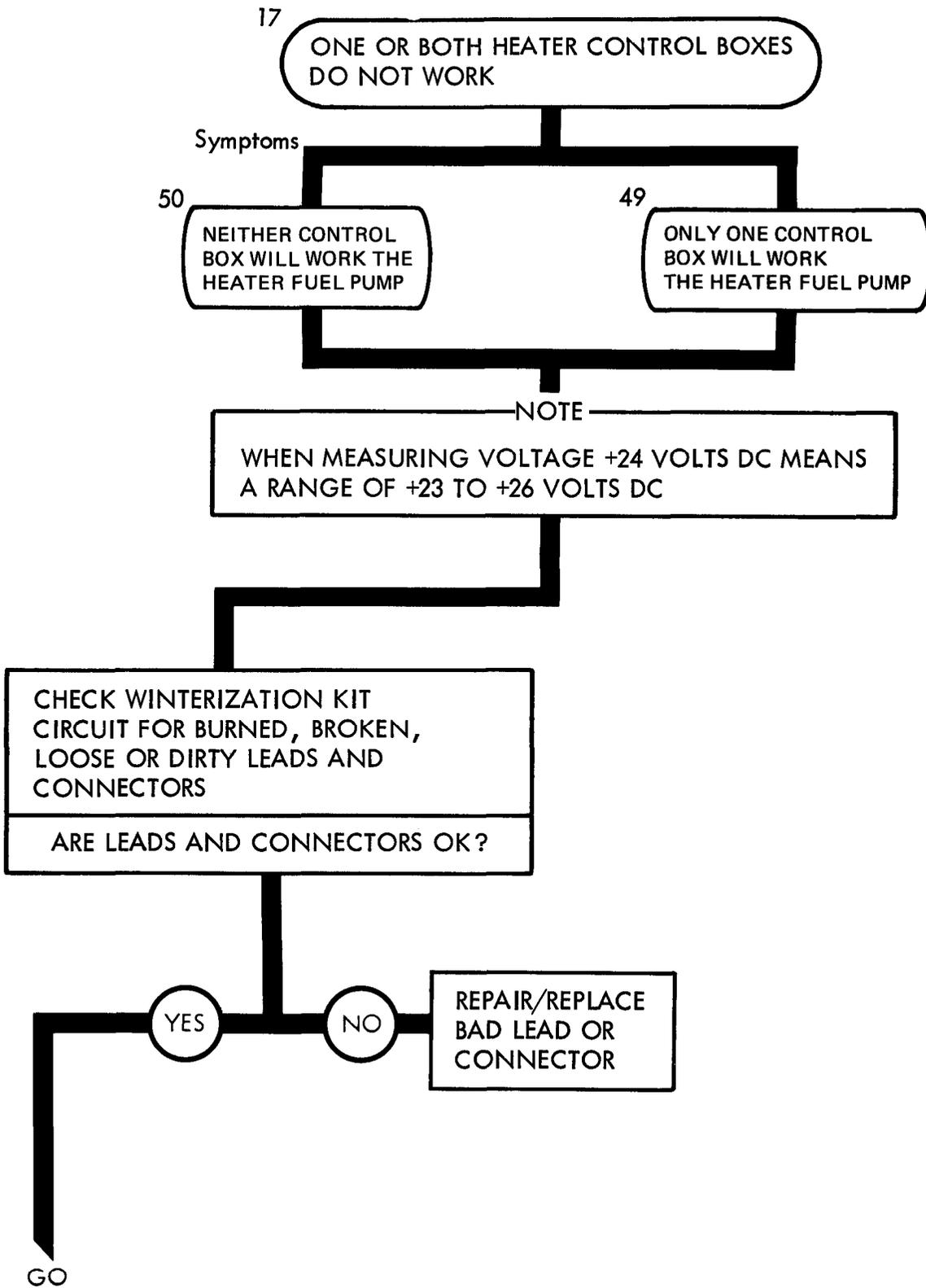
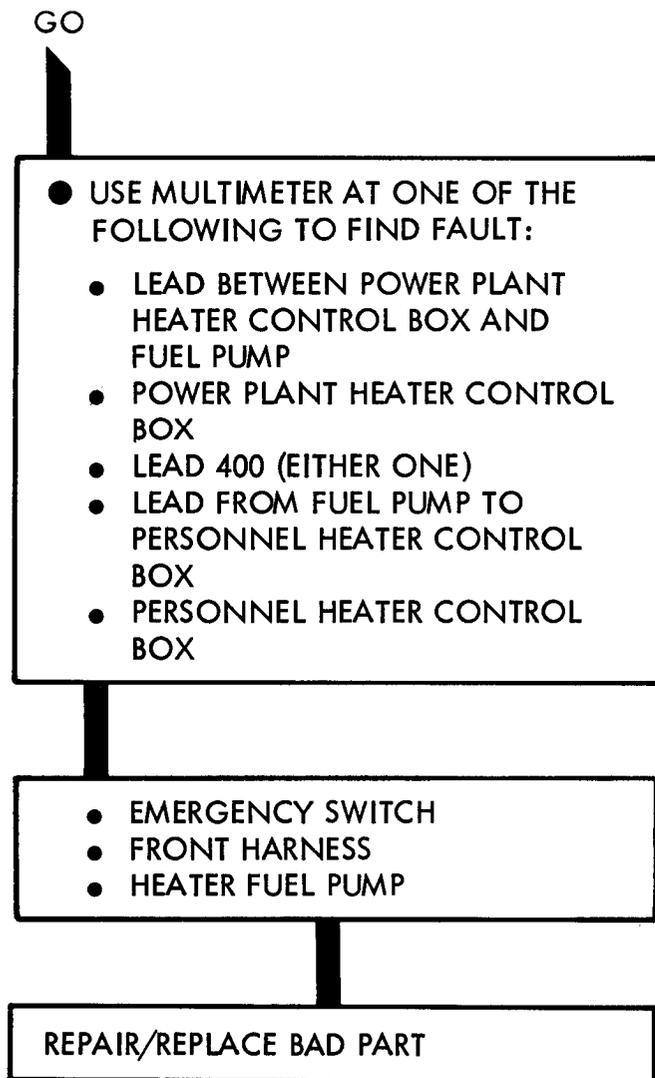

Figure 26-17 (Sheet 1 of 2)



NOTE: FOR DETAILED TROUBLESHOOTING PROCEDURES, SEE SYMPTOM INDEX

CHAPTER 27

ELECTRICAL SYSTEM SUPPORT DIAGRAMS

27-1. GENERAL. This chapter gives the diagrams you need when doing troubleshooting procedures in chapter 25. Table 3-1 is a complete listing of all support diagrams used in this manual.

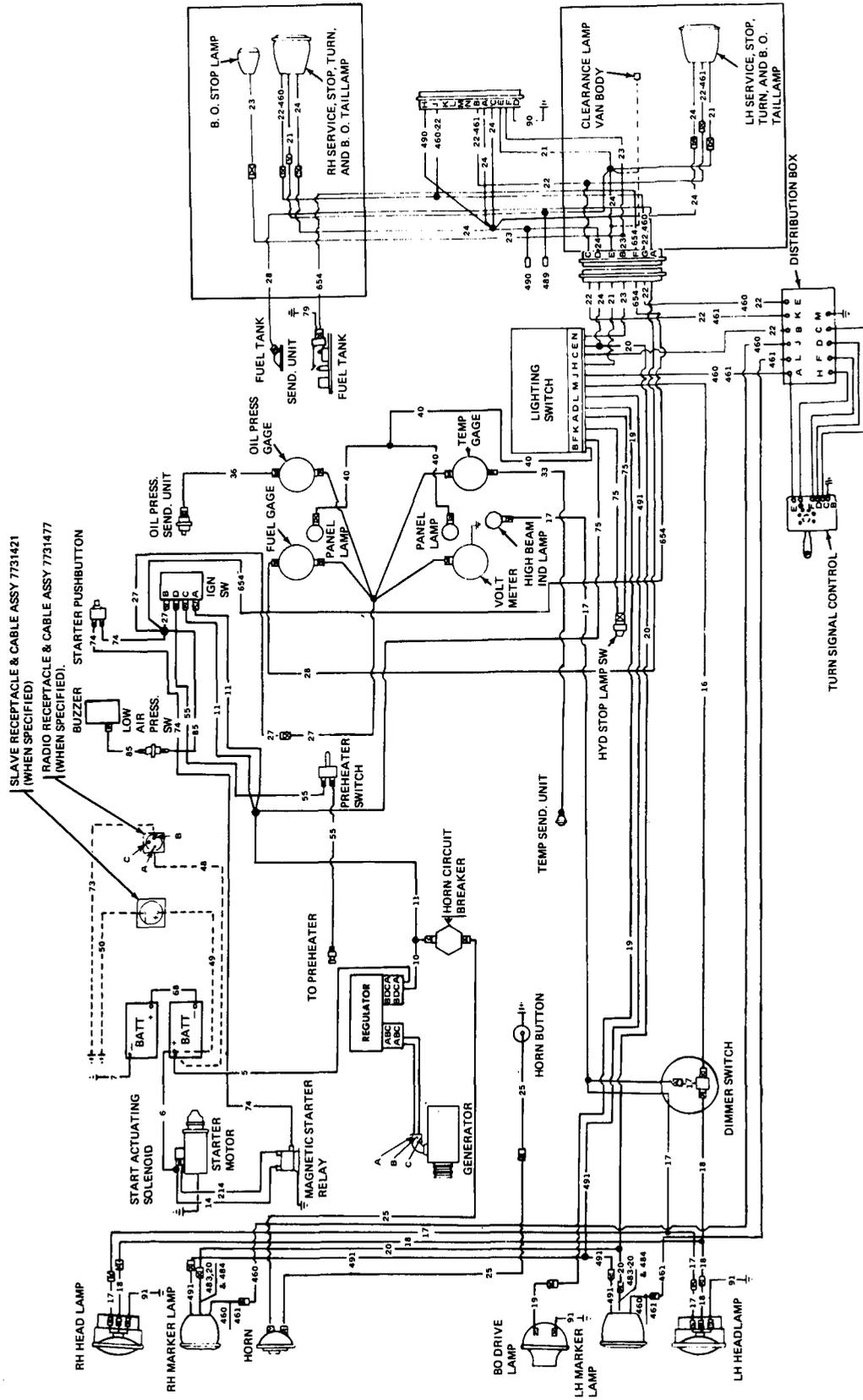

TA 114652

Figure 27-1. Electrical Wiring Diagram

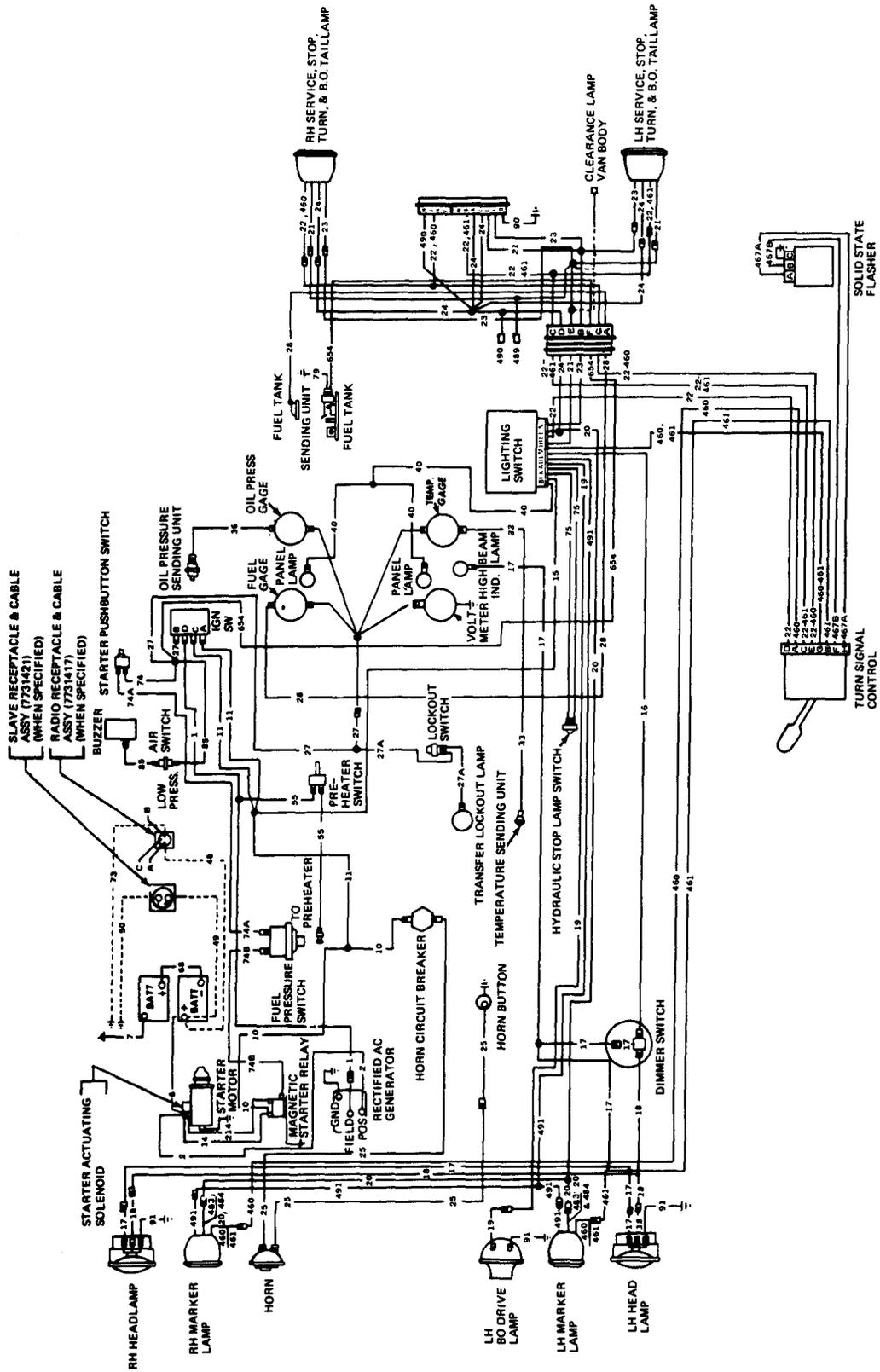

TA 114653

Figure 27-2. Electrical Wiring Diagram

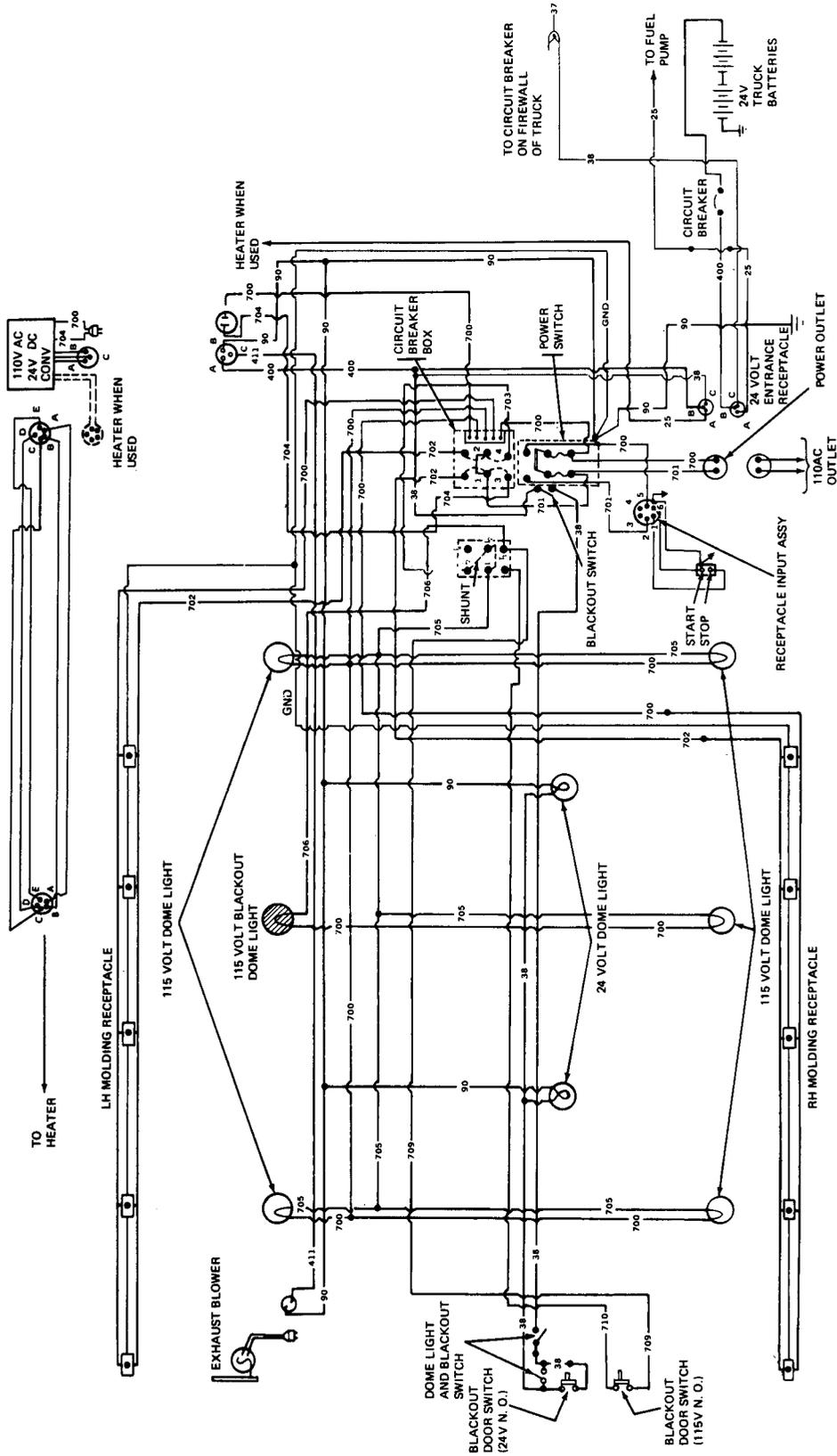

TA 114654

Figure 27-3. Electrical Wiring Diagram

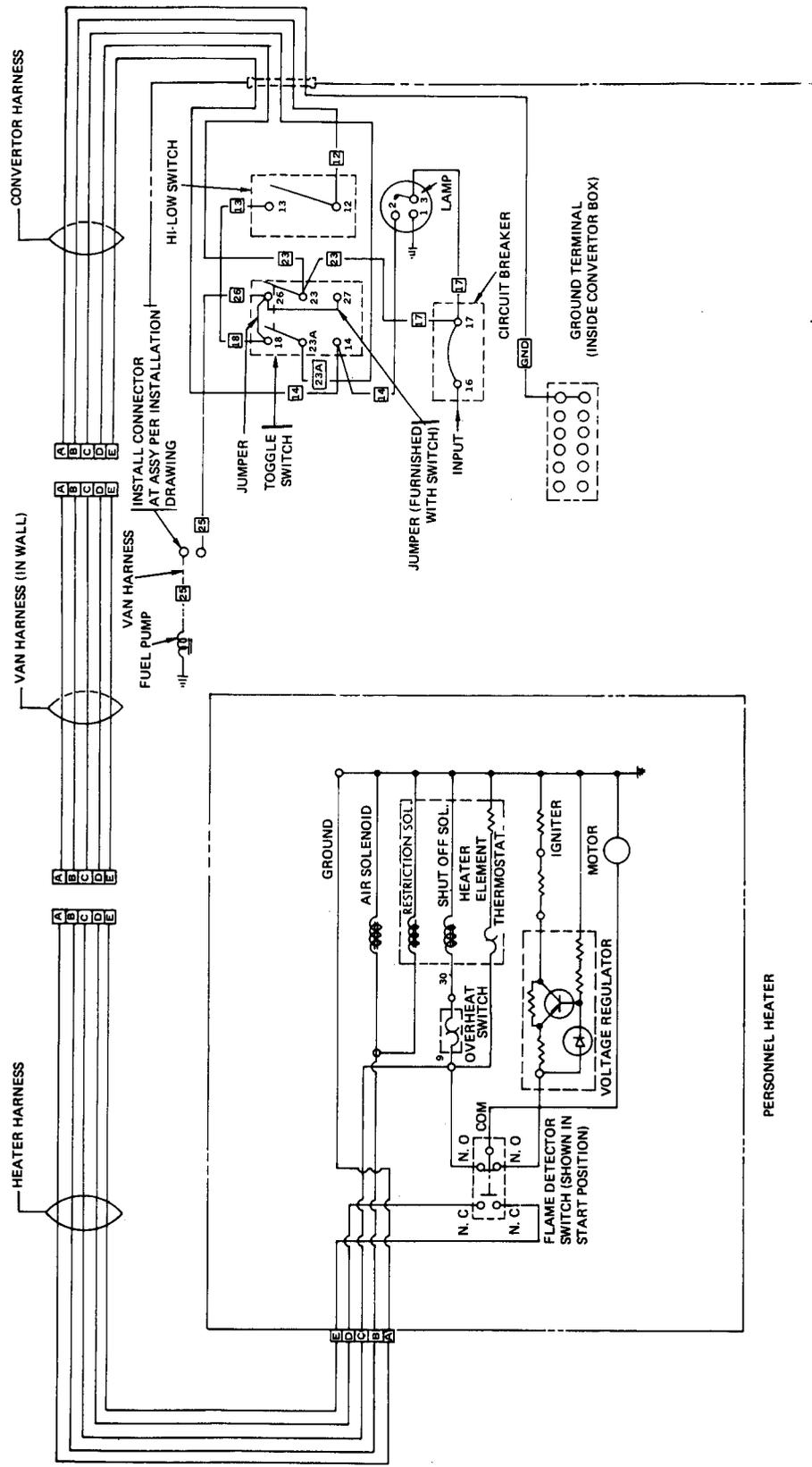

TA 114655

Figure 27-4. Electrical Wiring Diagram

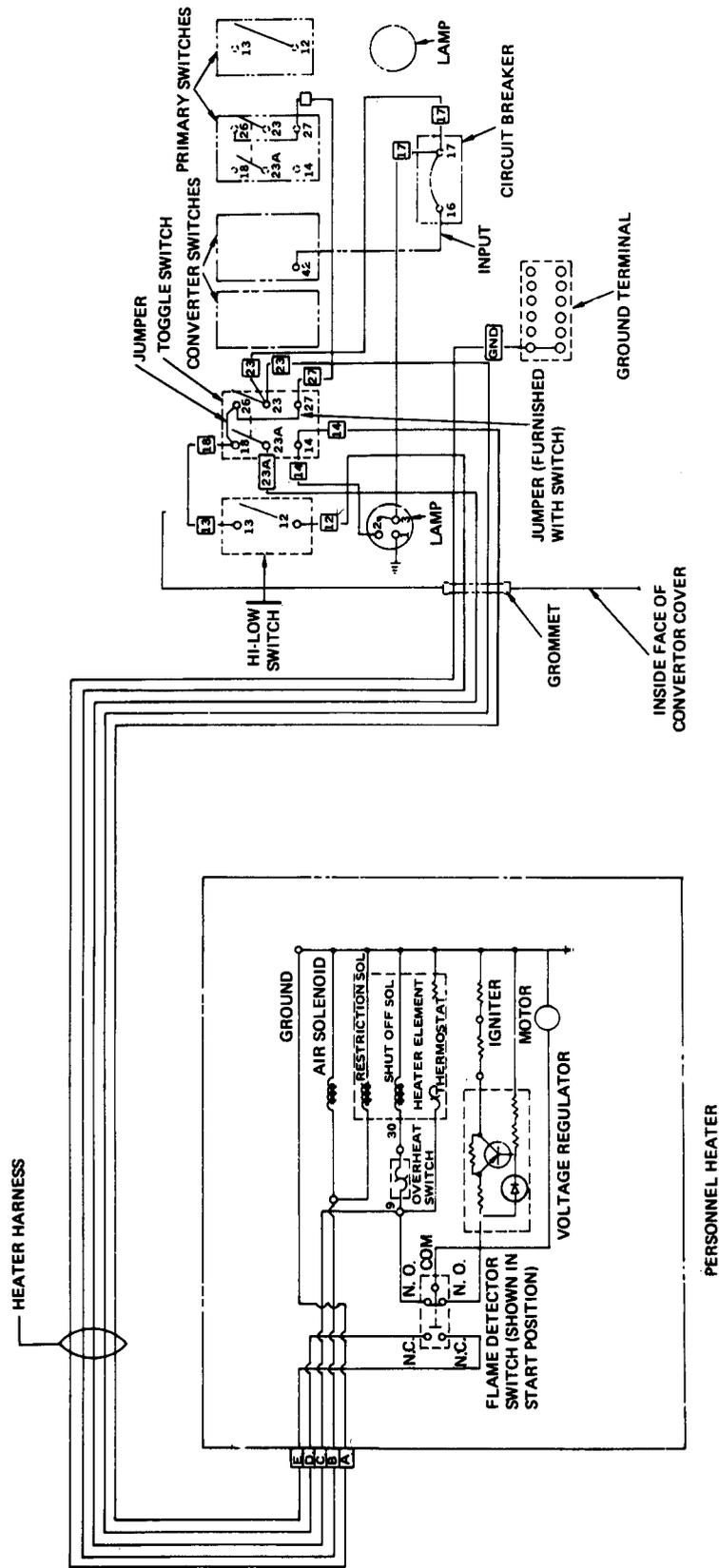

TA 114650

Figure 27-5. Electrical Wiring Diagram

CHAPTER 28

MULTIMETER TEST PROCEDURES

28-1. GENERAL. This chapter gives test procedures for the multimeter troubleshooting.

28-2. TEST SET-UP. Instructions for setup of test equipment and parts to be tested are given before the test procedures. Illustrations are used, when needed, to show you how to hook up the test equipment to the part to be tested.

28-3. TEST PROCEDURE. Detailed step-by-step instructions, in flow chart form, are given for each test. The procedure calls out the type of test and the condition of the truck system for each part of testing. The step-by-step test will lead you to the bad component or to a fault symptom within a related system. Reference is made to the fault symptom index, chapter 6, if the test shows a fault in another system.

MULTIMETER AN/URM-105C TEST PROCEDURES

GENERAL INSTRUCTIONS

- Check that multimeter is ready for use
 - Calibration label - Check to be sure multimeter has been calibrated in the last 12 months.
 - Meter - Glass and pointer not broken. Pointer should be resting over zero mark at left side of scales.
 - Batteries - Not corroded or leaking. Put in right.

- Cables - No cuts, sharp kinks or bad fraying.
- Test prods - Tight on cable, tip free of paint or anything that might be an insulator.
- Switch and knob - Work freely without binding or scraping.
- Alligator clips - Free of paint or anything that might be an insulator.

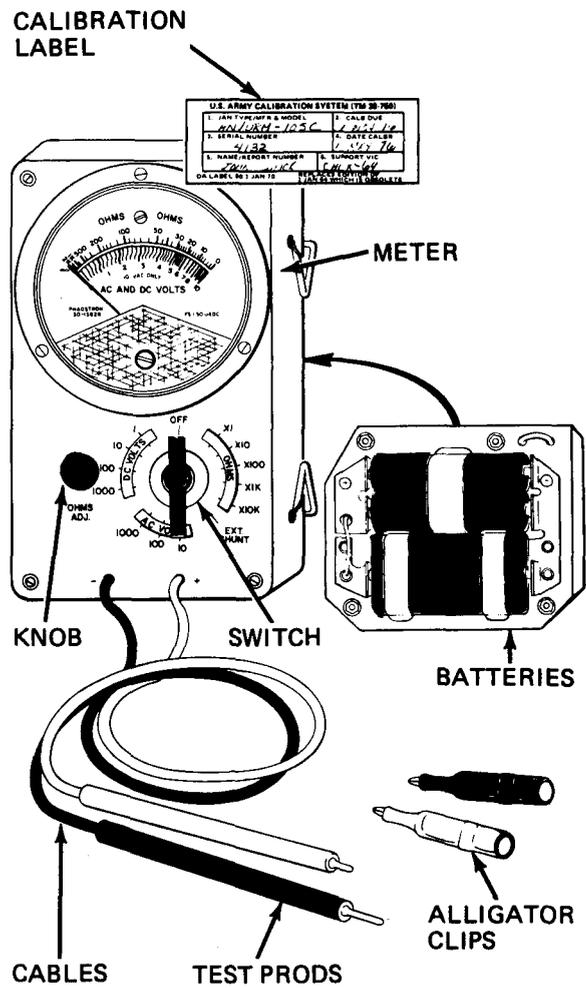

TA 114658

Figure 28-1

1 DC VOLTAGE TEST - To measure battery voltage, charging system output, and voltage drops at various test points.

1

- Set up selector switch
 Note: The highest truck DC voltage that is measured is about 28 volts. Therefore, the selector switch is never set to 1000 DC VOLTS
- See table to find out setting of selector switch. Table shows switch setting when normal value of measured voltage is known or unknown

IF NORMAL VALUE OF VOLTAGE BEING MEASURED IS THIS:	SET SELECTOR SWITCH TO:
0 TO 0.8 VOLTS	1 DC VOLTS
0.8 TO 8 VOLTS	10 DC VOLTS
8 TO 80 VOLTS	100 DC VOLTS
UNKNOWN	100 DC VOLTS

TS 260-20-356

- Set selector switch to setting you picked
 Note: The OHMS ADJ knob is not used for DC voltage tests

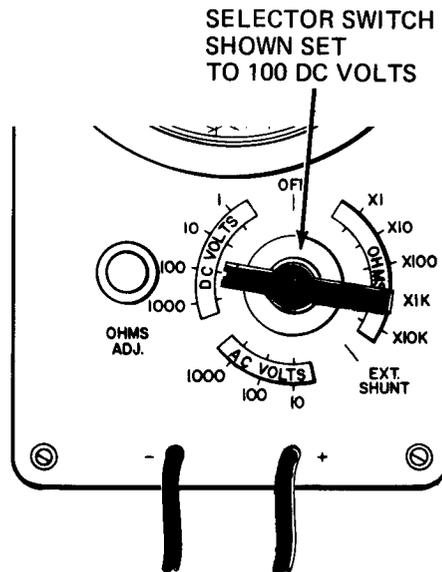

NOTE

When you need to turn on power before measuring DC voltage, the fault isolation procedures gives the turn-on instructions.

GO

TA 114659

Figure 28-2 (Sheet 1 of 5)

GO

2

- Put multimeter leads across (in parallel with) circuit being measured:
 - Put test prod of black lead (-) on negative terminal of circuit being measured.
 - Put test prod of red lead (+) on positive terminal of circuit being measured.

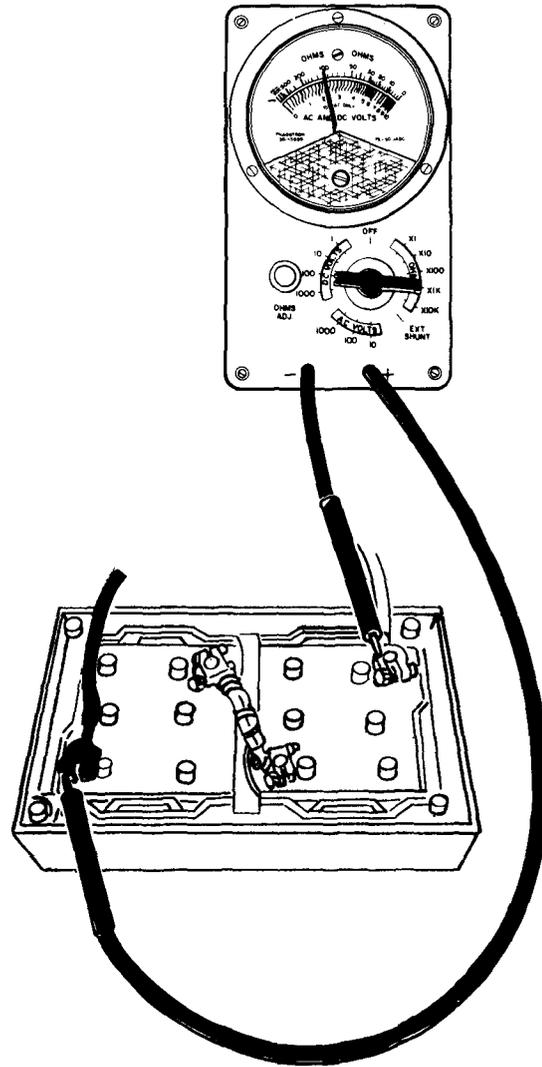

3

- If pointer falls exactly on a numbered line read multimeter as follows:
 - Read upper straight lines of AC AND DC VOLTS scale. See which straight line pointer is on.

GO

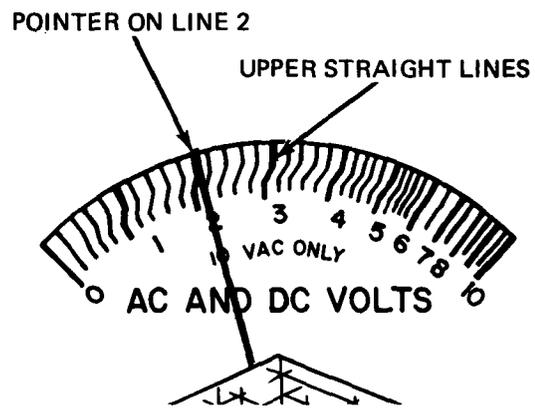

TA 114660

Figure 28-2 (Sheet 2 of 5)

GO

SELECTOR SWITCH SETTING	INSTRUCTION
1 DC VOLTS	DIVIDE BY 10
10 DC VOLTS	USE AS IS
100 DC VOLTS	MULTIPLY BY 10

- Get multimeter reading as follows:

TS 260-20-360

Step A	Step B	Step C	Step D
Read selector switch setting.	From table, pick instruction that is listed next to selector switch setting	See what numbered line pointer is on.	Do the instruction you picked in step B to the number in step C
Example: 100 DC VOLTS	Multiply by 10	2	$10 \times 2 = 20$ volts DC

4

- If pointer is between numbered lines read multimeter as follows:
 - Look at upper straight lines of AC AND DC VOLTS scale. See which two numbered lines the pointer is between. Take smaller number: 2

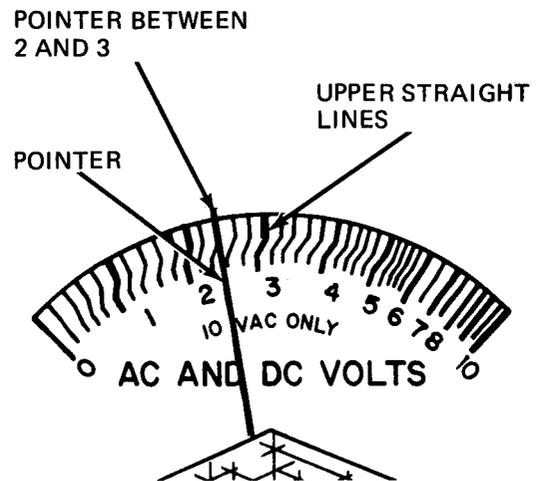

GO

TA 114661

Figure 28-2 (Sheet 3 of 5)

GO

b. Count number of graduations from smaller number to pointer: 2

c. Multiply number from step b by either 0.2 or 0.5 as shown in figure: $0.2 \times 0.2 = 0.4$

d. Add number from step a to number from step c: $2 + 0.4 = 2.4$

GO

NUMBER OF GRADUATIONS FROM 2 TO POINTER IS 2

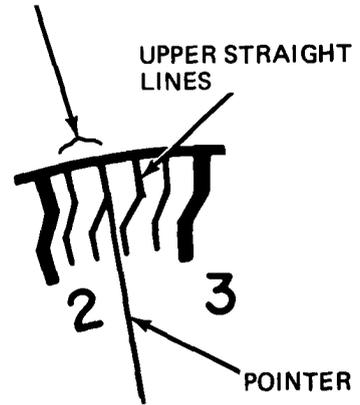

IF POINTER IS ON THIS SIDE OF LINE 6, MULTIPLY BY 0.2

IF POINTER IS ON THIS SIDE OF LINE 6, MULTIPLY BY 0.5

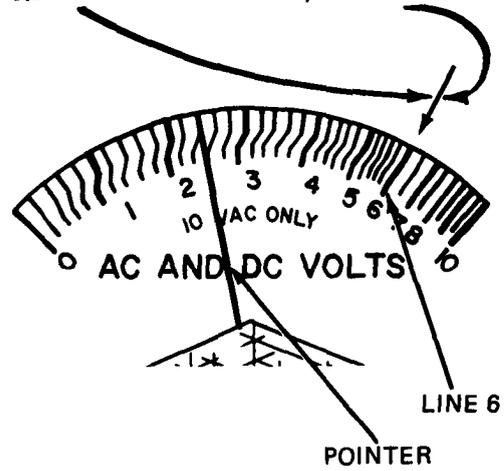

TA 114662

Figure 28-2 (Sheet 4 of 5)

GO

e. Get multimeter reading as follows:

SELECTOR SWITCH	INSTRUCTION
1 DC VOLTS	DIVIDED BY 10
10 DC VOLTS	USE AS IS
100 DC VOLTS	MULTIPLY BY 10

Step A

Read selector switch setting.

Step B

From table, pick instruction that is listed next to selector switch setting.

Step C

See what step 4d number is.

Step D

Do the instruction you picked in step B to the number in step C.

Example: 100 DC VOLTS Multiply by 10 2.4 10 x 2.4=24 volts DC

5

- Make circuit normal again:
 - Take both test prods off measured circuit.

Figure 28-2 (Sheet 5 of 5)

2

AC VOLTAGE TEST - To measure van input and operating voltages.

1

- Set up multimeter:

Note: The truck AC voltages measured are 208 and 120 volts. Therefore, only the 1000 AC VOLTS selector switch position is used.

- Set selector switch to 1000AC VOLTS.

Note: The OHMS ADJ knob is not used for AC voltage tests.

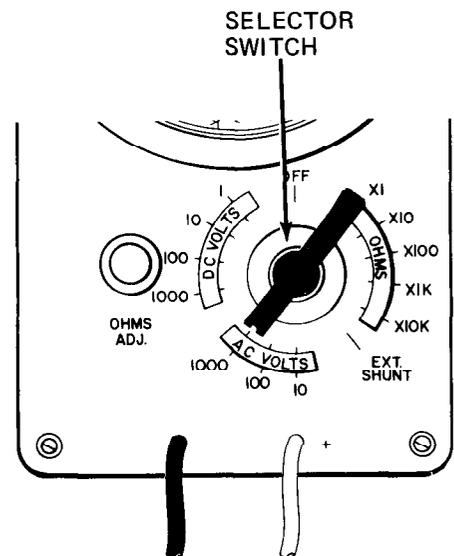

GO

TA 114663

Figure 28-3 (Sheet 1 of 5)

GO

NOTE

When you need to turn on power before measuring AC voltage, the fault isolation procedure gives the turn-on instructions.

2

- Put multimeter leads across (in parallel with) circuit being measured:
 Note: In AC voltage measurement you can hook up the test lead connections to the circuit either way. You will still get correct multimeter readings and no damage will be done to the multimeter. But, when one side of the circuit is electrical ground, it is a good idea to put the black lead on electrical ground
- Put test prod of black lead on ground side or one side of circuit being measured. Put test prod of red lead on other side of circuit being measured.

GO

NOTE: MULTIMETER SHOWN MEASURING 120 VOLTS AC VAN CEILING LIGHT VOLTAGE

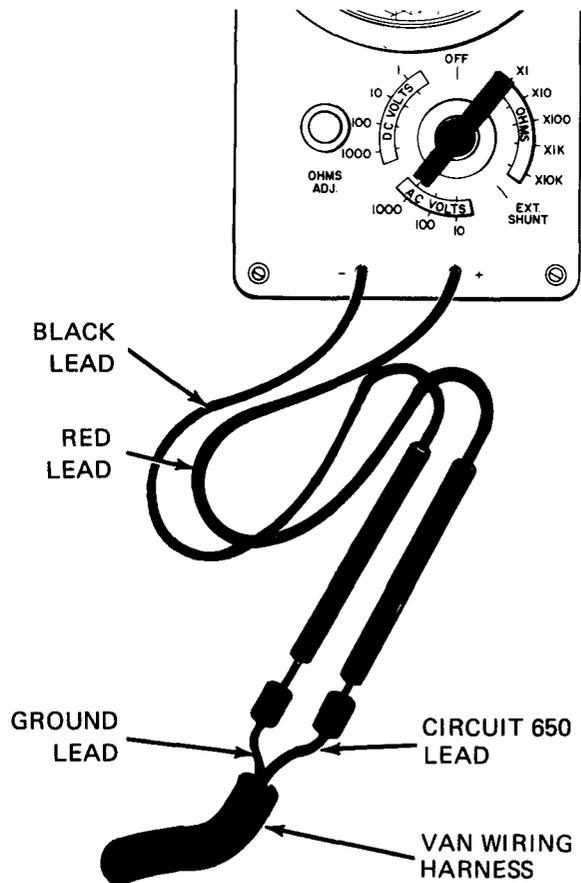

TA 114664

Figure 28-3 (Sheet 2 of 5)

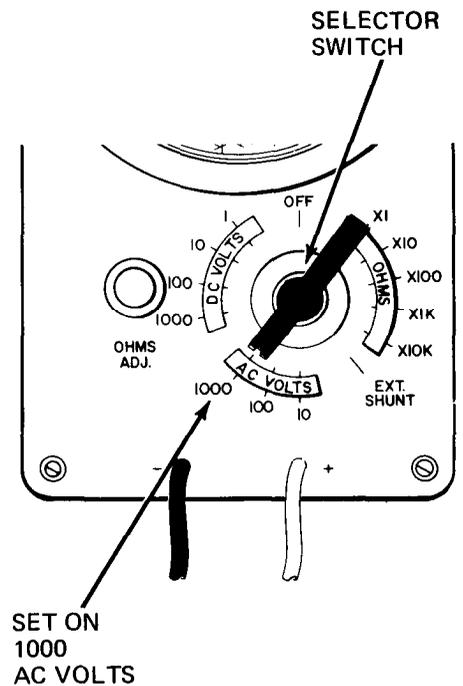
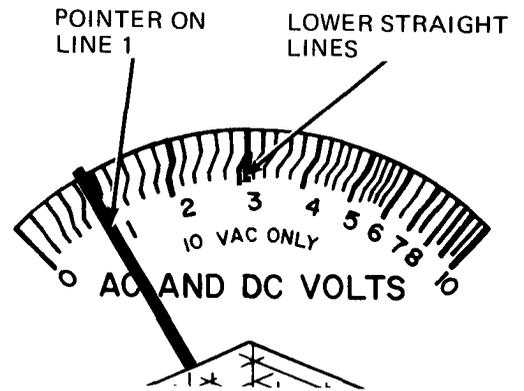
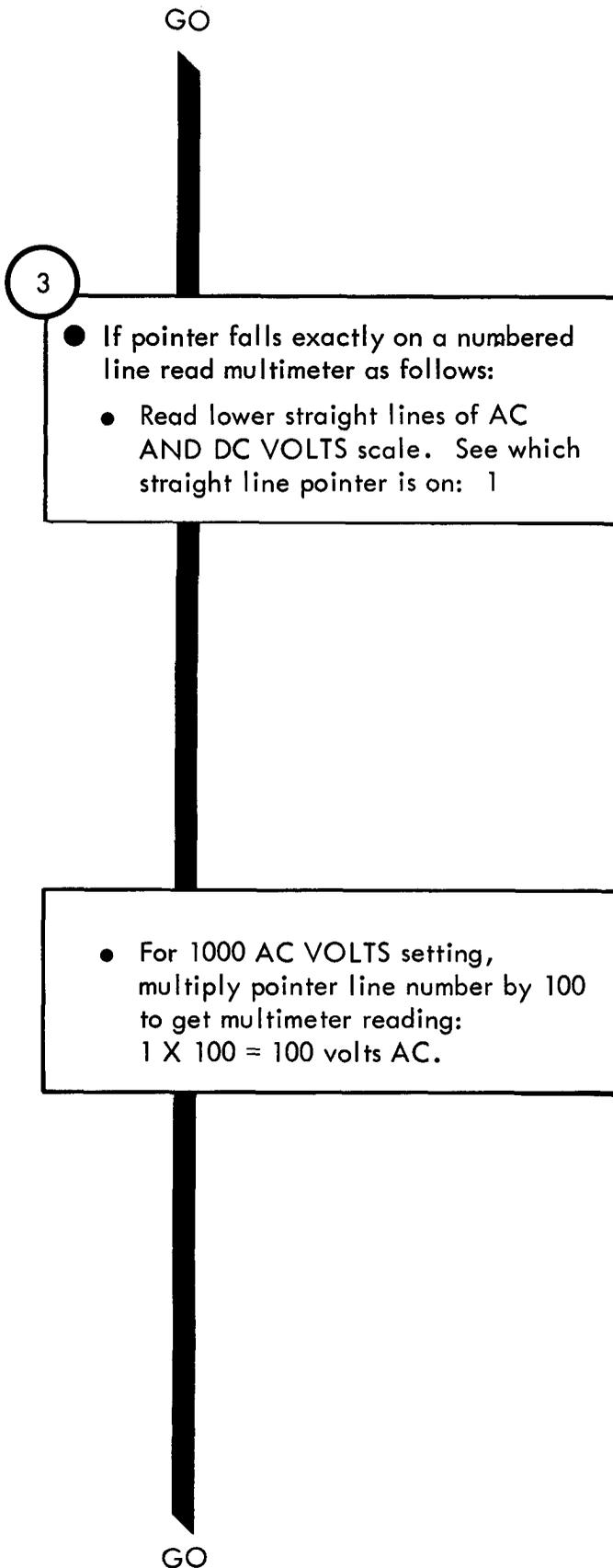
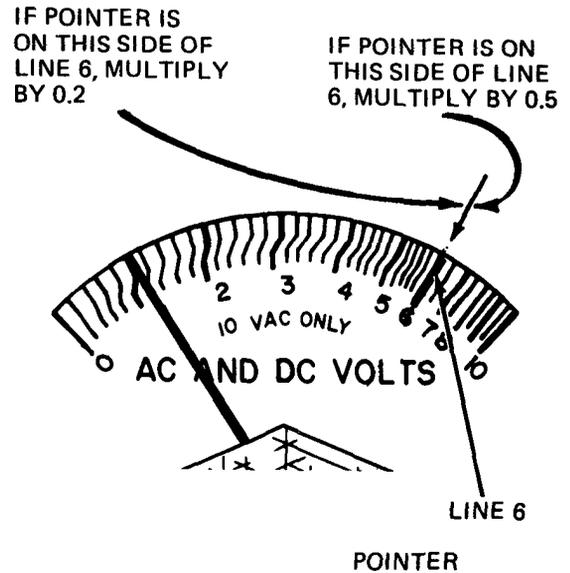
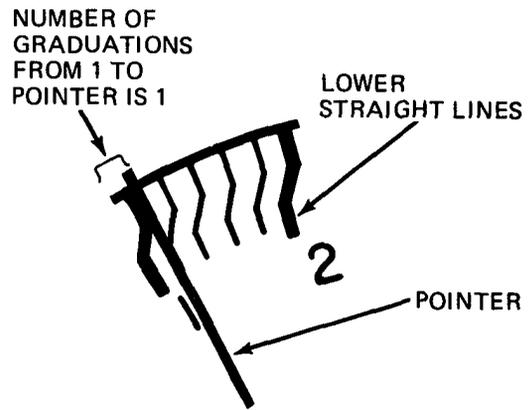
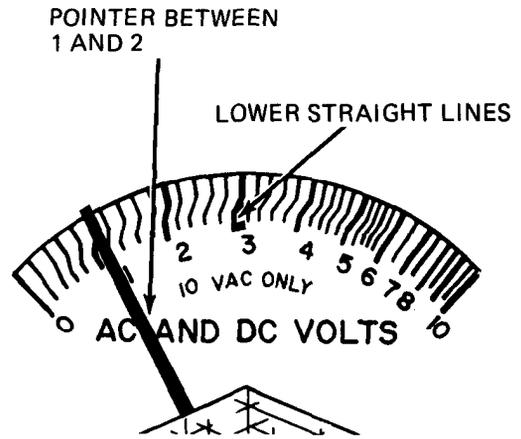
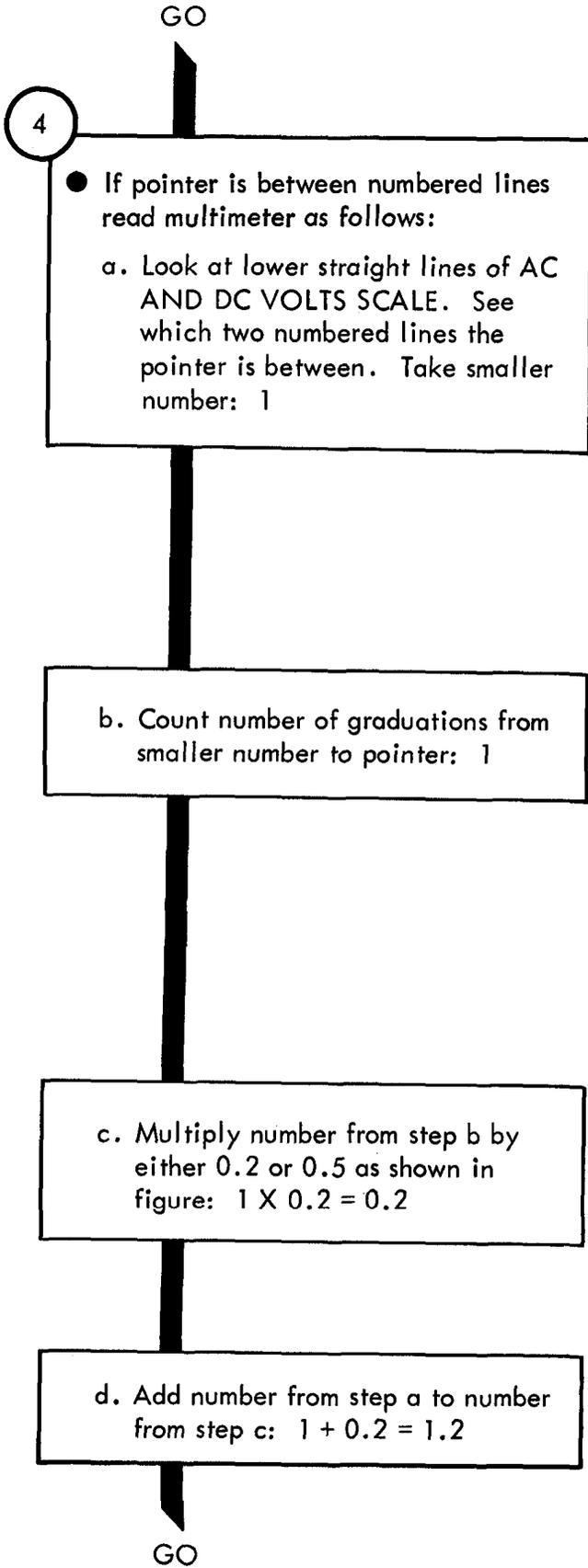

Figure 28-3 (Sheet 3 of 5)

TA 114665



TA 114666

Figure 28-3 (Sheet 4 of 5)

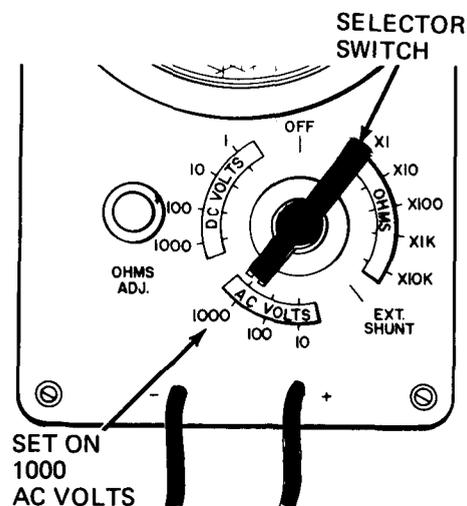
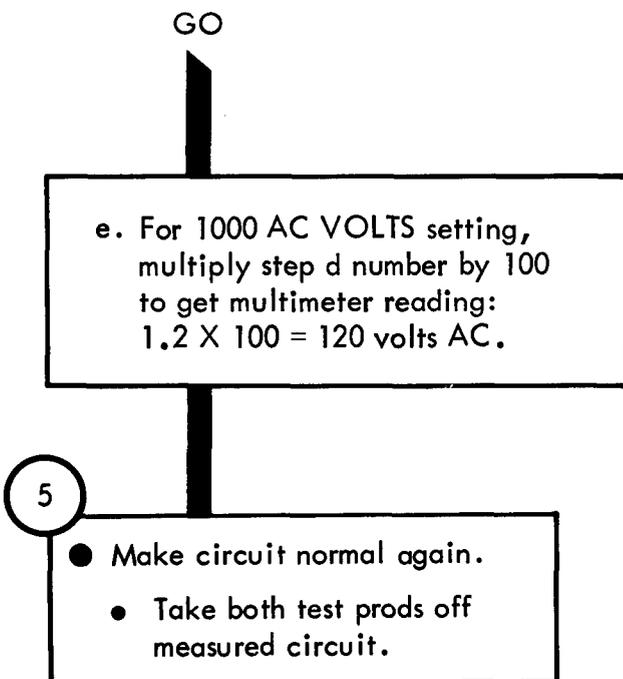
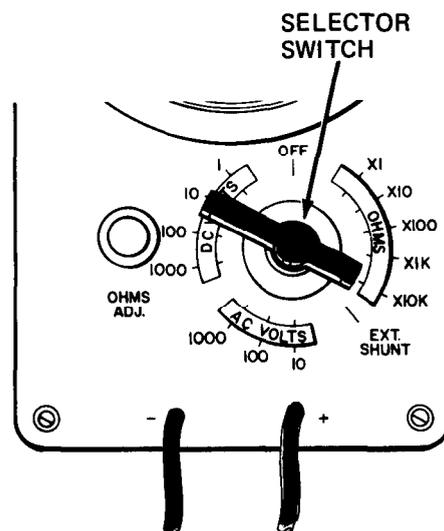
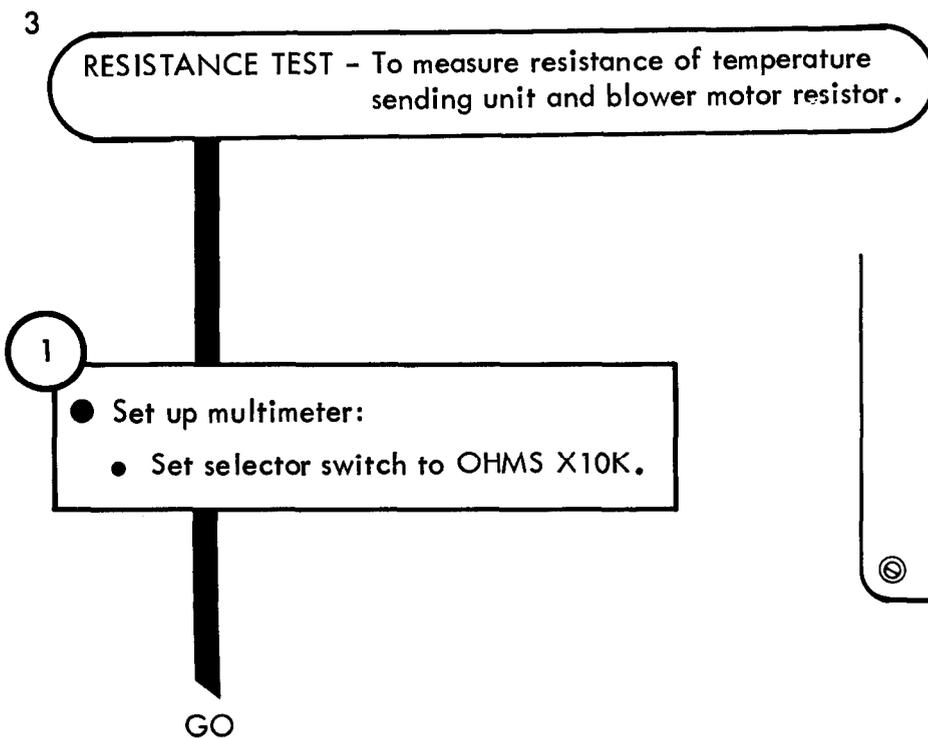
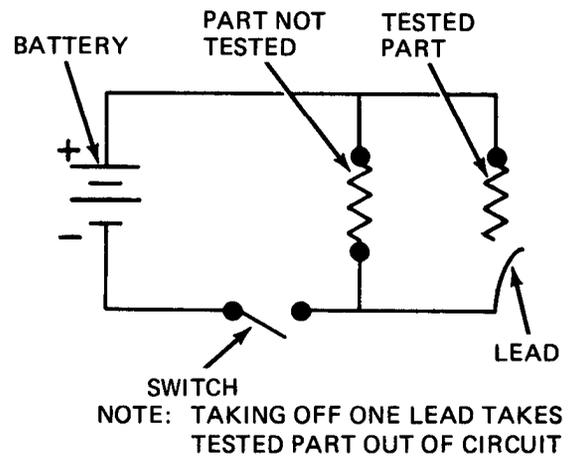
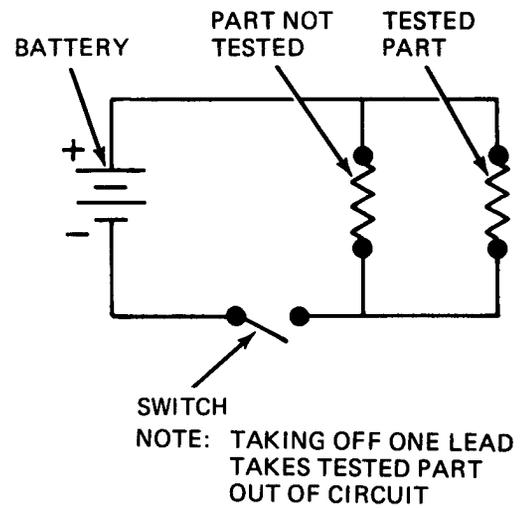
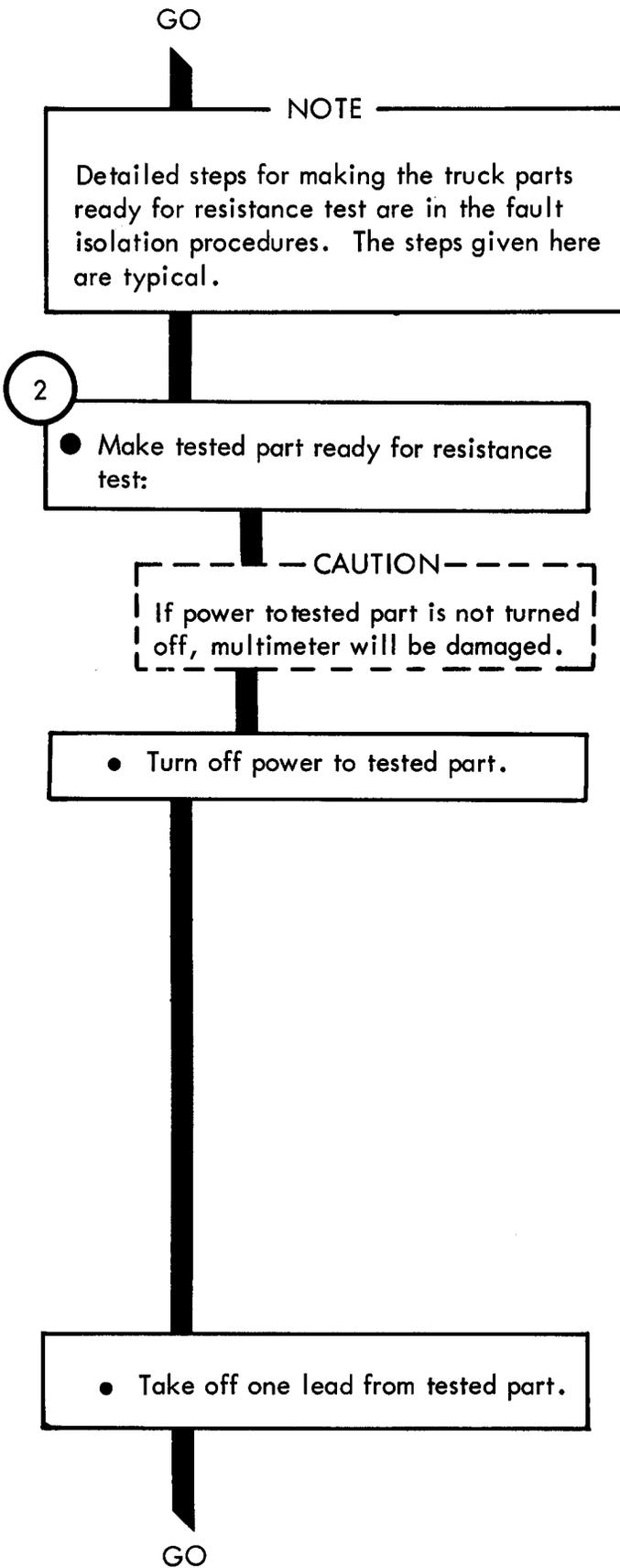

Figure 28-3 (Sheet 5 of 5)



TA 114667

Figure 28-4 (Sheet 1 of 10)



TA 114668

Figure 28-4 (Sheet 2 of 10)

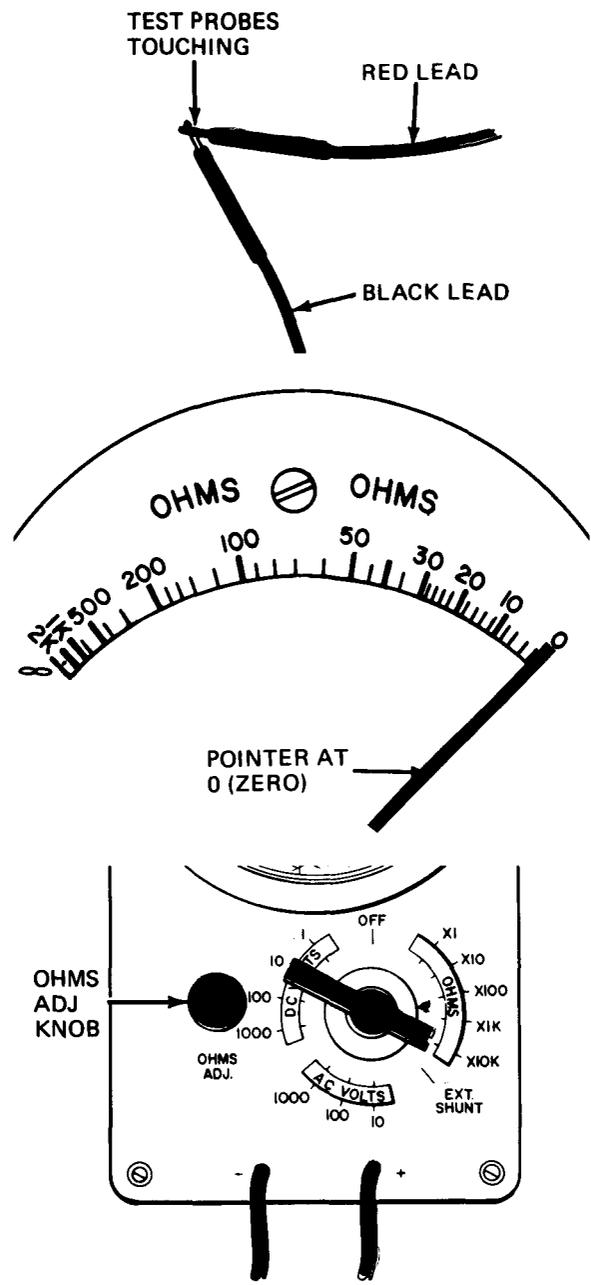
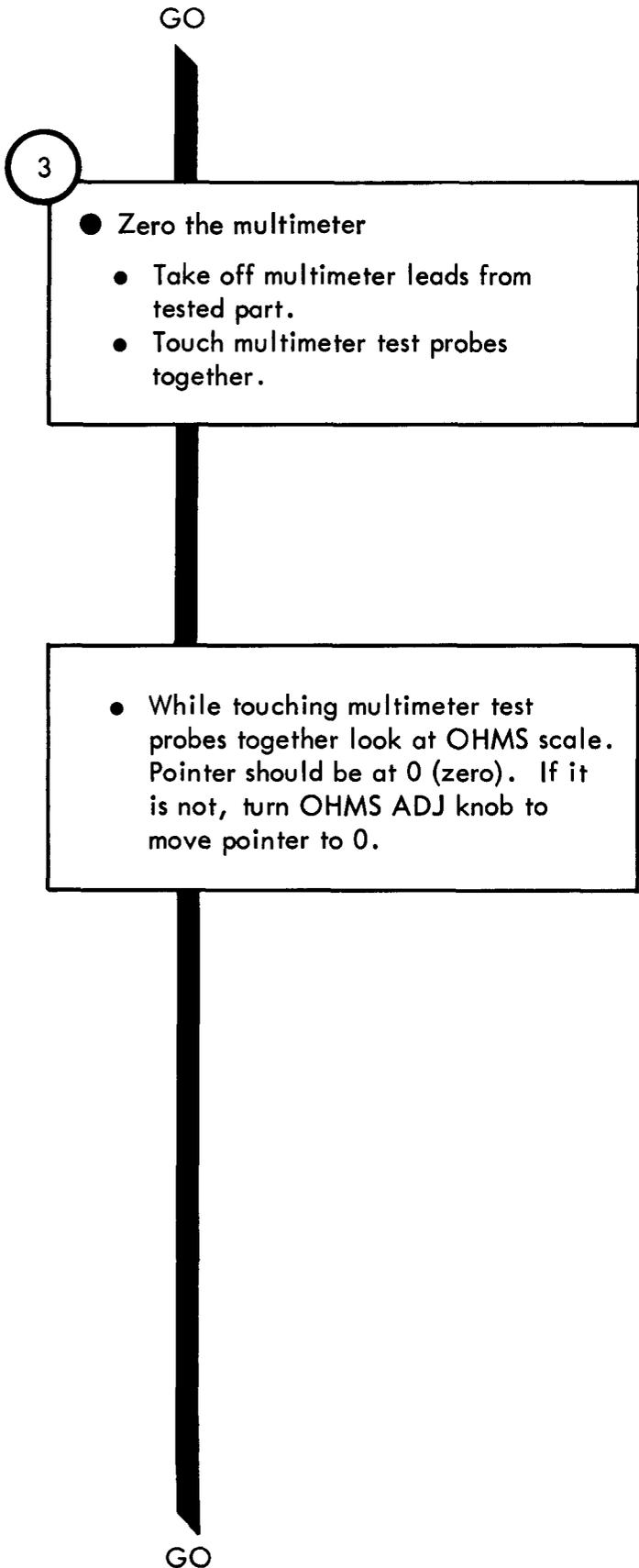

Figure 28-4 (Sheet 3 of 10)

GO

4

- Put multimeter leads across tested part:
 - Put black test prod on one terminal of tested part
 - Put red test prod on other terminal of test part

NOTE
Zero the multimeter each time you turn the selector switch knob to another position. (See step 3.)

GO

NOTE: MULTIMETER SHOWN MEASURING RESISTANCE OF A COLD START RESISTOR.

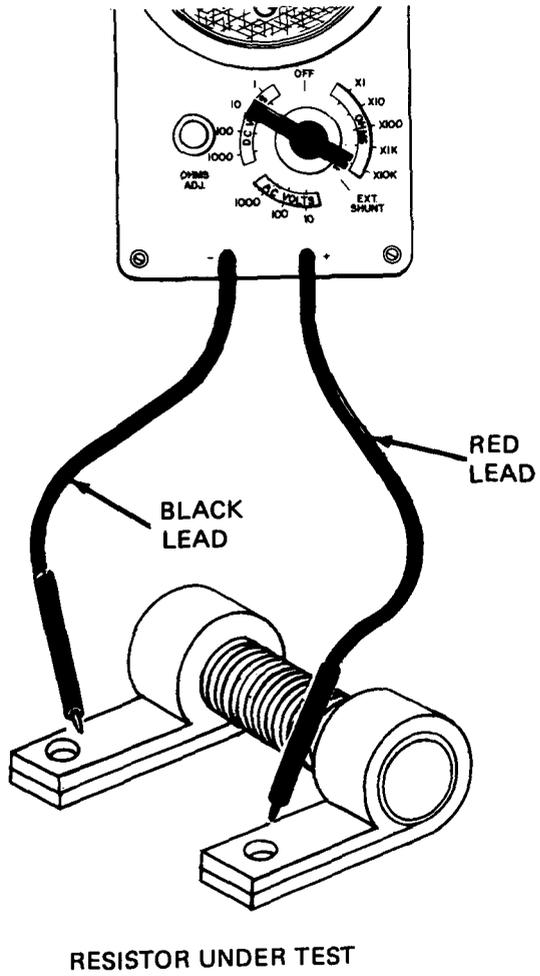

TA 114670

Figure 28-4 (Sheet 4 of 10)

GO

5

- Get the most accurate multimeter reading as follows

Note: The closer the multimeter pointer is to the center of the OHMS scale, the more accurate the reading.

- Note position of pointer on OHMS scale. Turn selector switch knob to left while looking at pointer. Try to find selector switch knob position that gives most centered pointer position.

GO

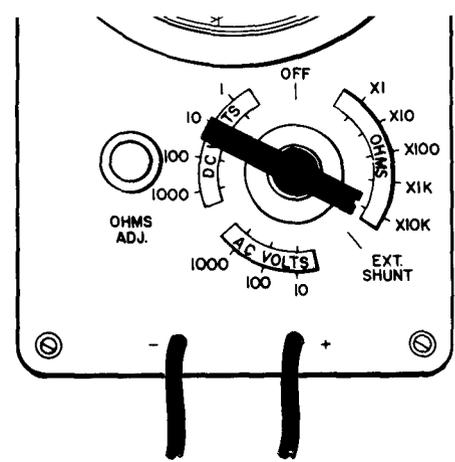
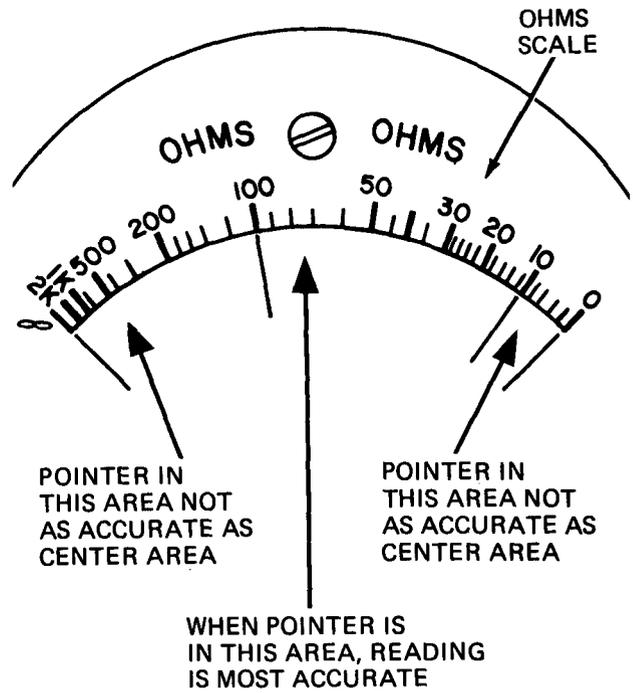

NOTE: MOVING SELECTOR SWITCH KNOB TO LEFT MOVES POINTER TO LEFT

Figure 28-4 (Sheet 5 of 10)

GO

• You may overshoot most centered pointer position. If you do, turn selector switch knob to right to put pointer in most centered position.

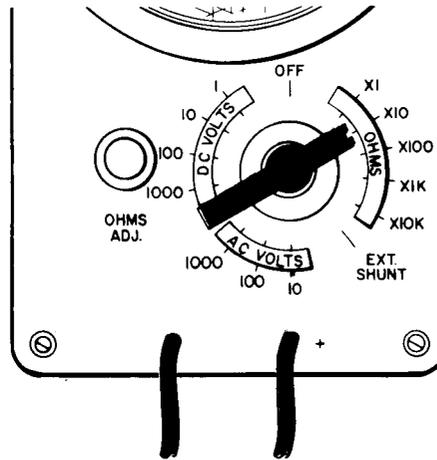

NOTE: MOVING SELECTOR SWITCH KNOB TO RIGHT MOVES POINTER TO RIGHT

• Pointer will stay in right area if resistance is less than 10 ohms. Pointer will stay in left area if resistance is more than 1,000,000 ohms.

• Leave selector switch in position that puts pointer in most centered position.

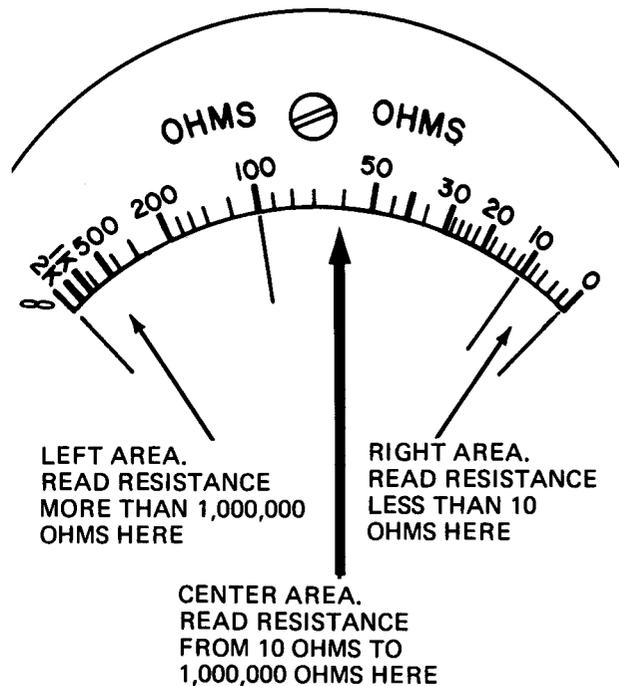

GO

TA 114672

Figure 28-4 (Sheet 6 of 10)

GO

6

- If pointer falls exactly on a numbered line read multimeter as follows:
 - a. Look at OHMS scale and see which numbered line pointer is on: 30

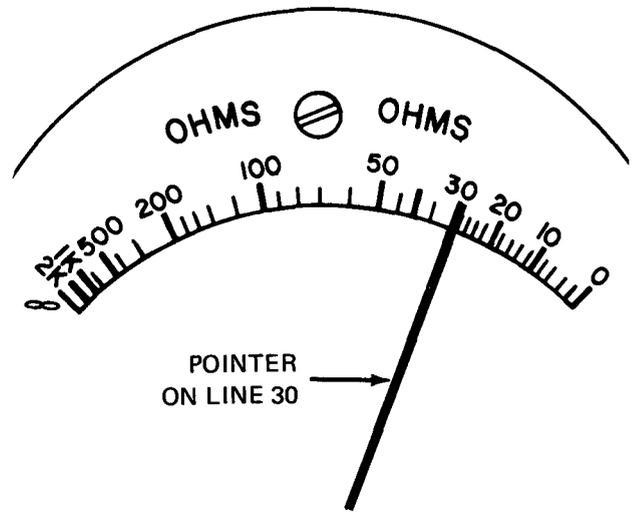

- b. See what selector switch position number is: 10
- c. Multiply number from step a by number from step b to get multimeter reading:
 $30 \times 10 = 300$ ohms

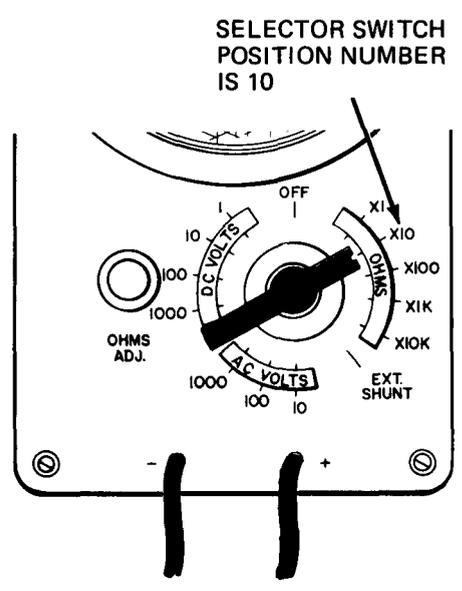

GO

Figure 28-4 (Sheet 7 of 10)

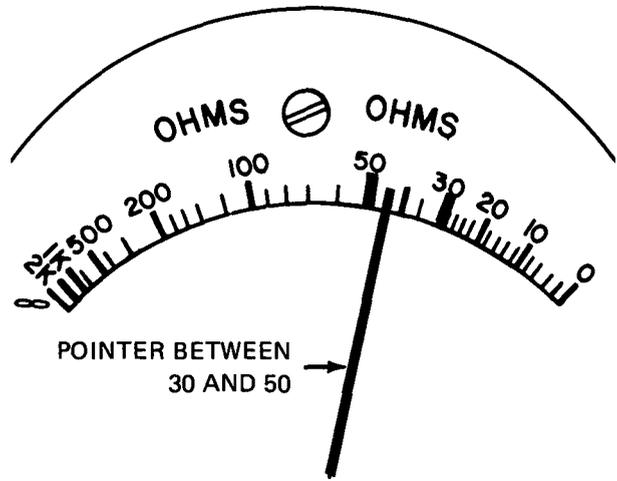
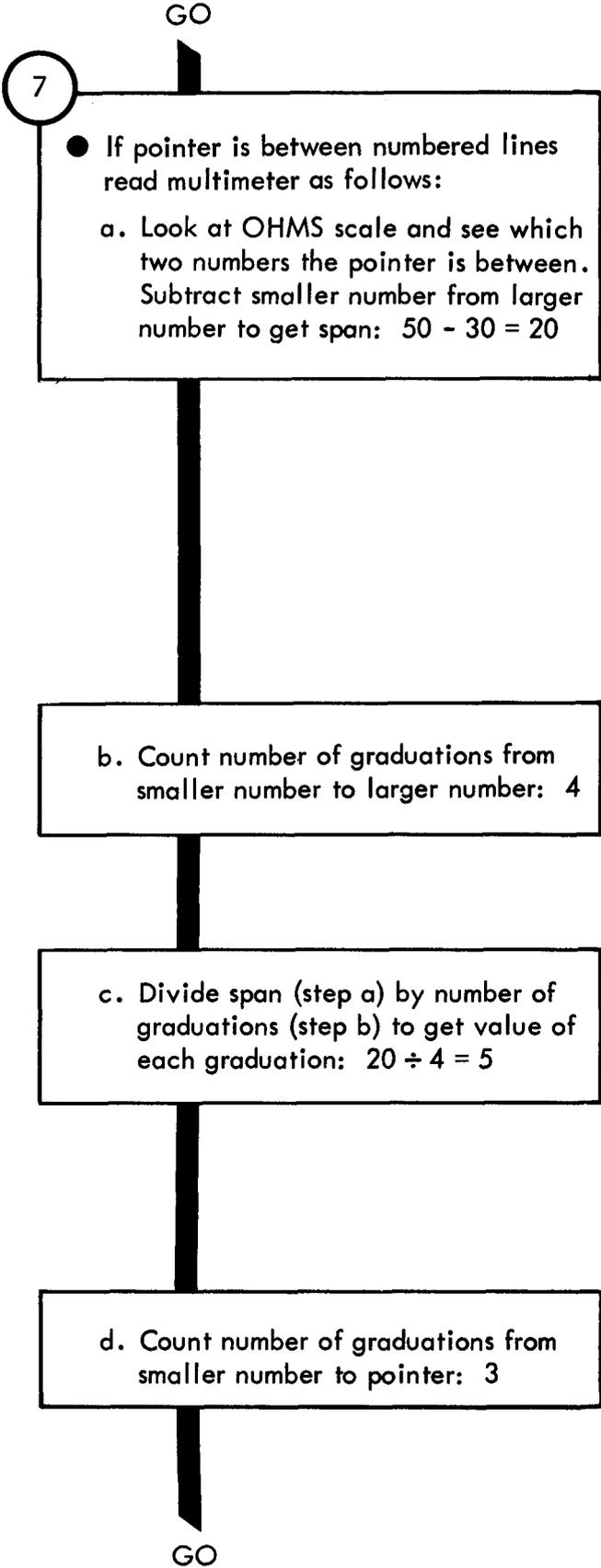

NUMBER OF GRADUATIONS FROM 30 TO 50 IS 4

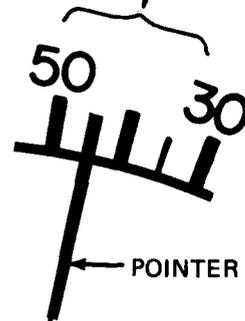

NUMBER OF GRADUATIONS FROM 30 TO POINTER IS 3

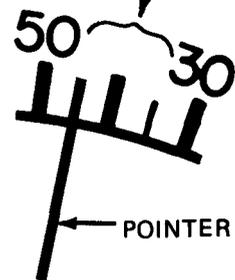

TA 114674

Figure 28-4 (Sheet 8 of 10)

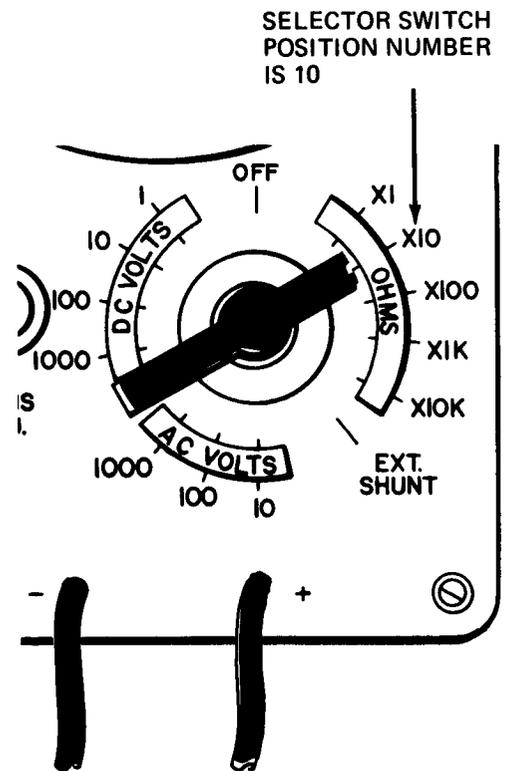
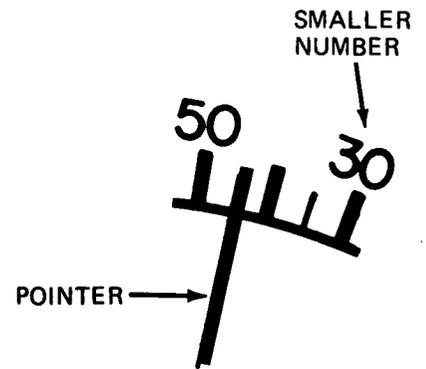
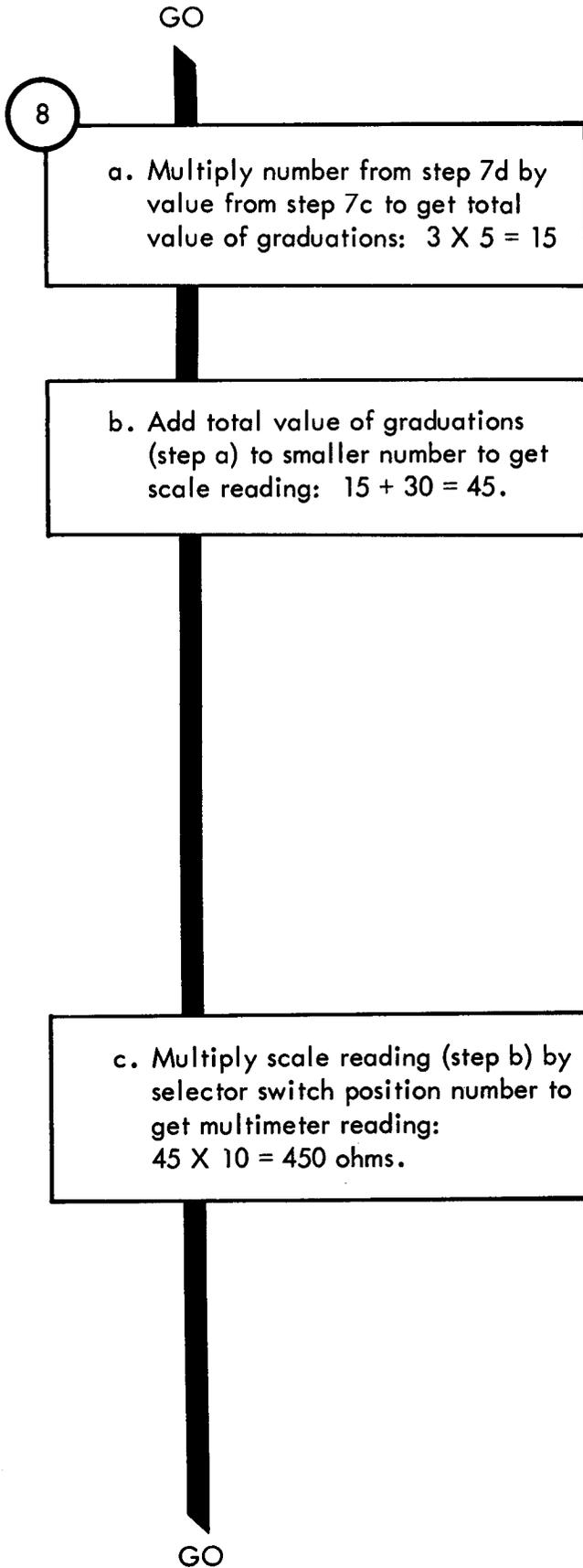

TA 114675

Figure 28-4 (Sheet 9 of 10)

GO

9

- Put isolated tested part back in circuit
- Take off both test prods from across tested part.
- Put lead back on tested part.

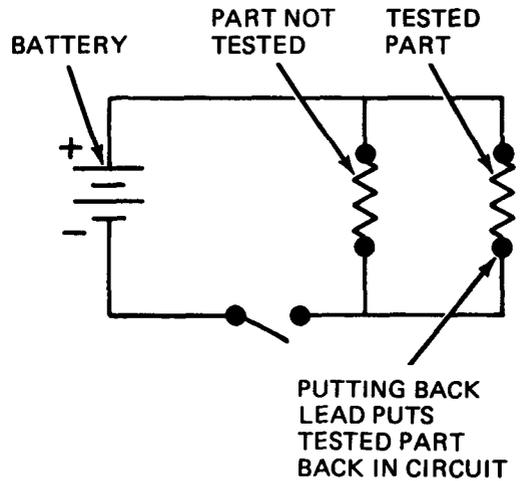

Figure 28-4 (Sheet 10 of 10)

4

CONTINUITY TEST - To check for breaks in a circuit, such as switch, lamp or electrical cable circuits.

1

- Set up multimeter
- Set selector switch to OHMS X1.

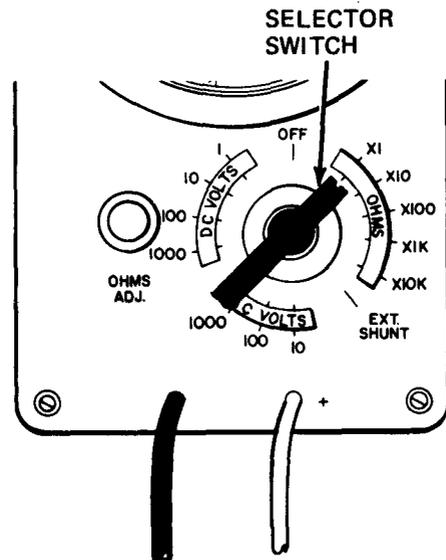

TA 114676

Figure 28-5 (Sheet 1 of 4)

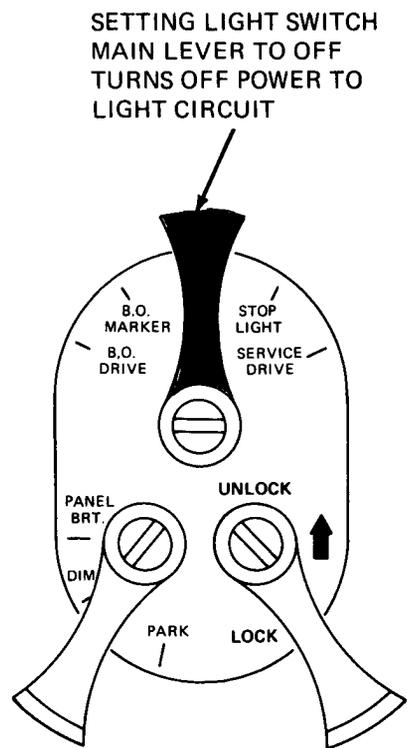
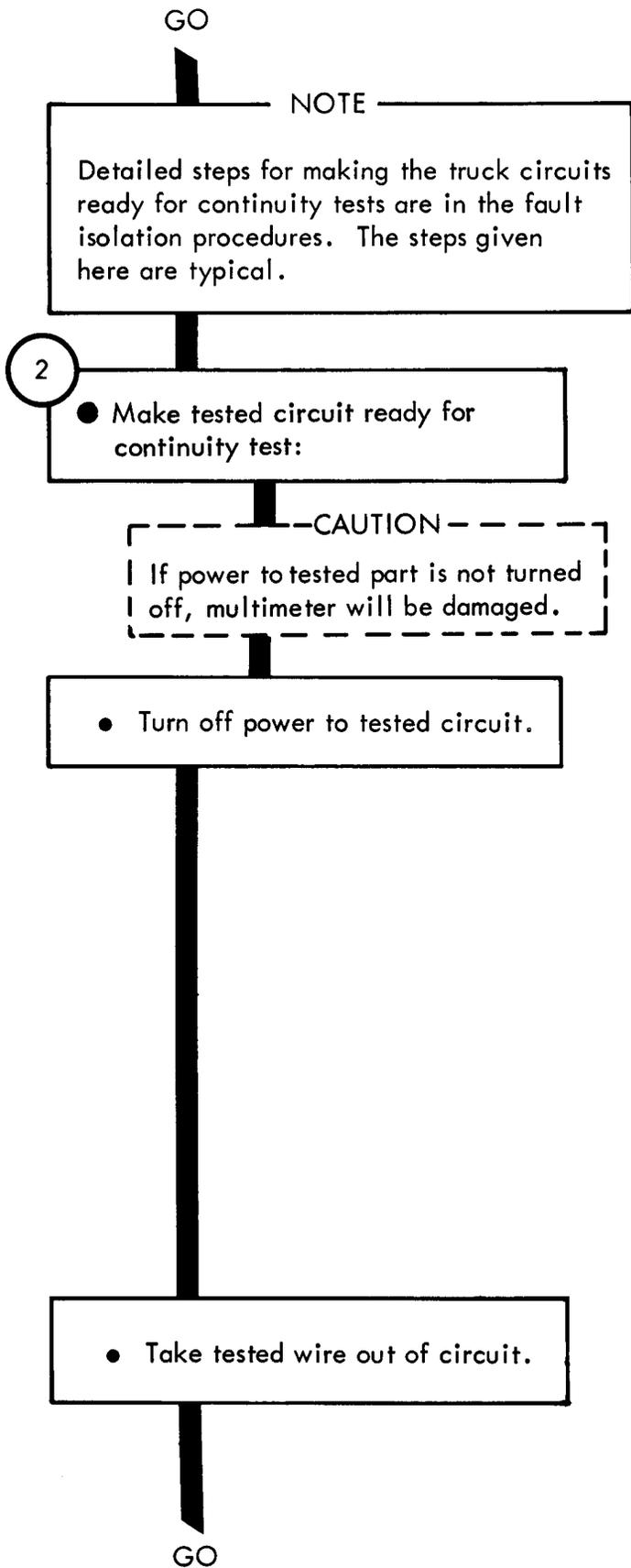

PLUG ON EACH END OF TRAILER CONNECTING CABLE REMOVED FROM MATING RECEPTACLE TO TAKE TESTED WIRE OUT OF CIRCUIT FOR CONTINUITY TEST

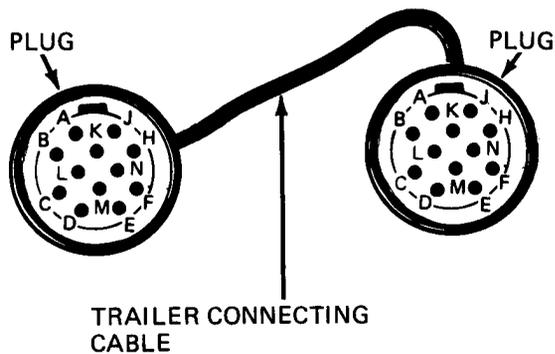

Figure 28-5 (Sheet 2 of 4)

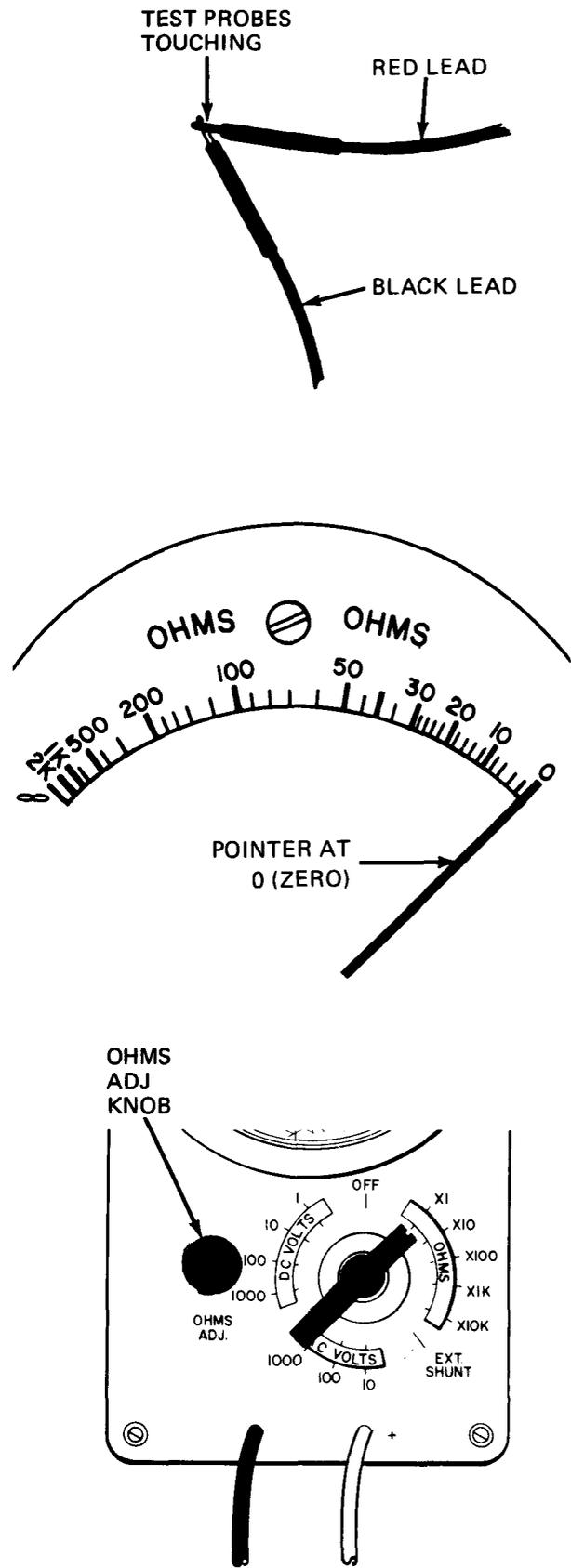
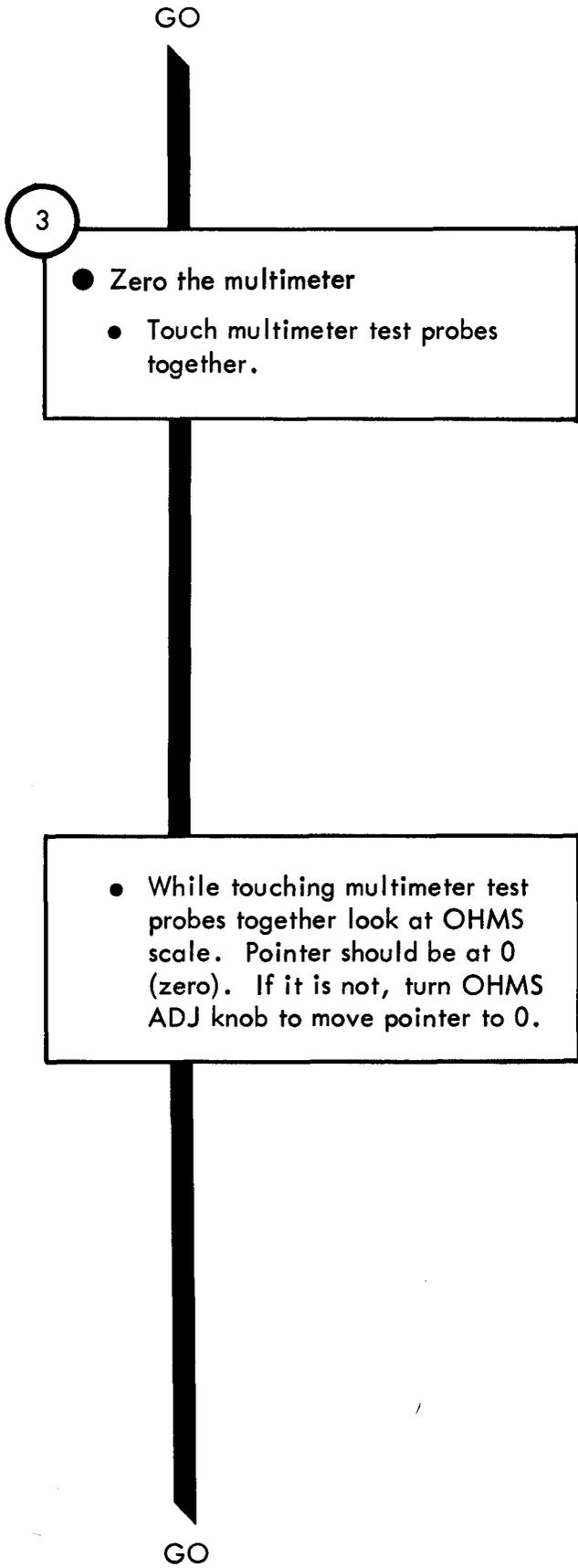

Figure 28-5 (Sheet 3 of 4)

TA 114678

- GO
- 4
 - Put multimeter leads across tested circuit
 - Put test prod of black lead (-) on one contact of tested circuit.
 - Put test prod of red lead (+) on other contact of tested circuit.

 - 5
 - Read multimeter
 - Look at multimeter OHMS scale. For continuity, pointer should be all the way to far right over 0 (zero).
 - If pointer stays all the way to left, tested circuit is open. If pointer jumps or flickers, tested circuit has a loose connection.

 - 6
 - Put tested circuit back in operation
 - Take off both test prods from tested circuit.
 - Put back any plugs or other parts previously removed to take tested wire out of circuit.

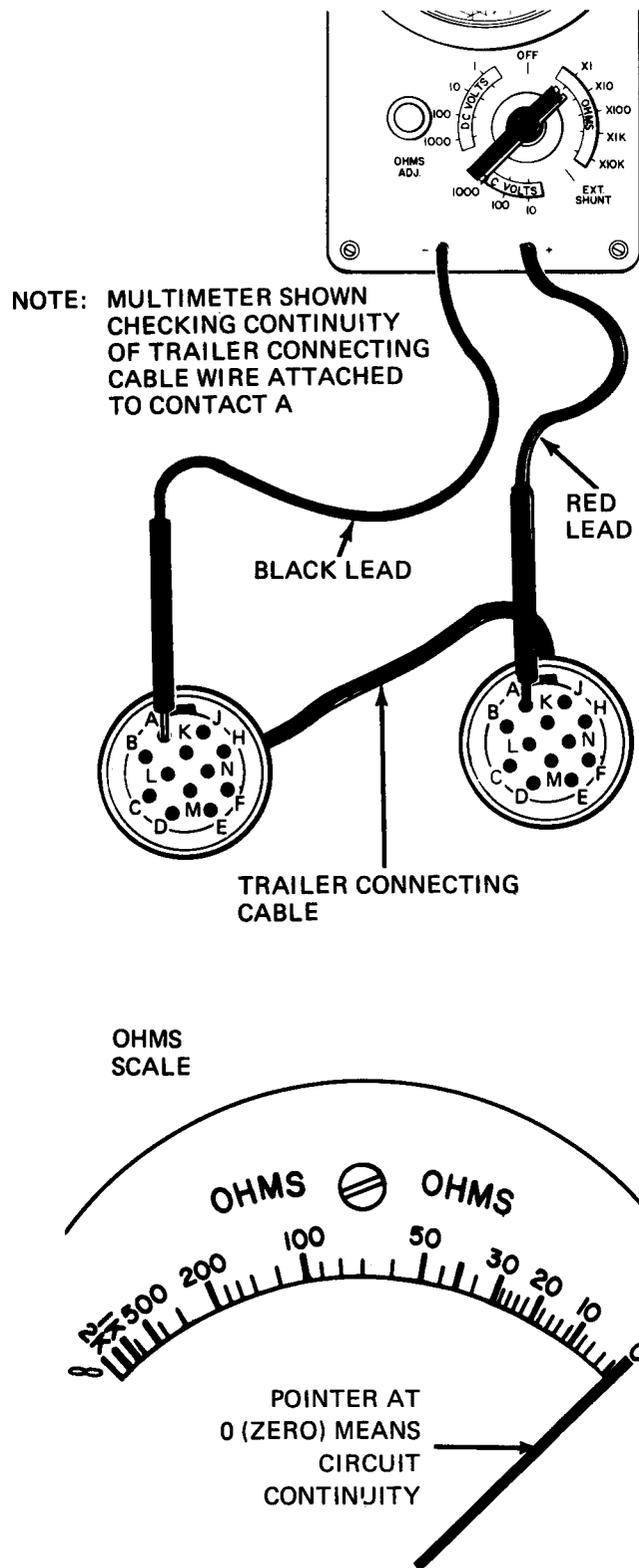

Figure 28-5 (Sheet 4 of 4)

TA 114679

5 SHORT TEST - To check for shorts in electrical cables.

NOTE
 A short (or short circuit) happens when two circuits that should not be connected have metal-to-metal contact with each other. A short also happens when a circuit that should not touch electrical ground has metal-to-metal contact with ground.

- 1
- Set up multimeter
 - Set selector switch to OHMS X10K.

NOTE
 Detailed steps for making the truck circuits ready for short test are in the fault isolation procedures. The steps given here are typical.

- 2
- Make tested circuits ready for short test:

CAUTION
 If power to tested part is not turned off, multimeter will be damaged

GO

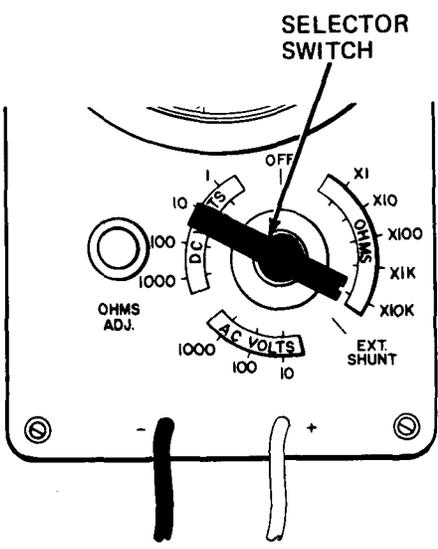
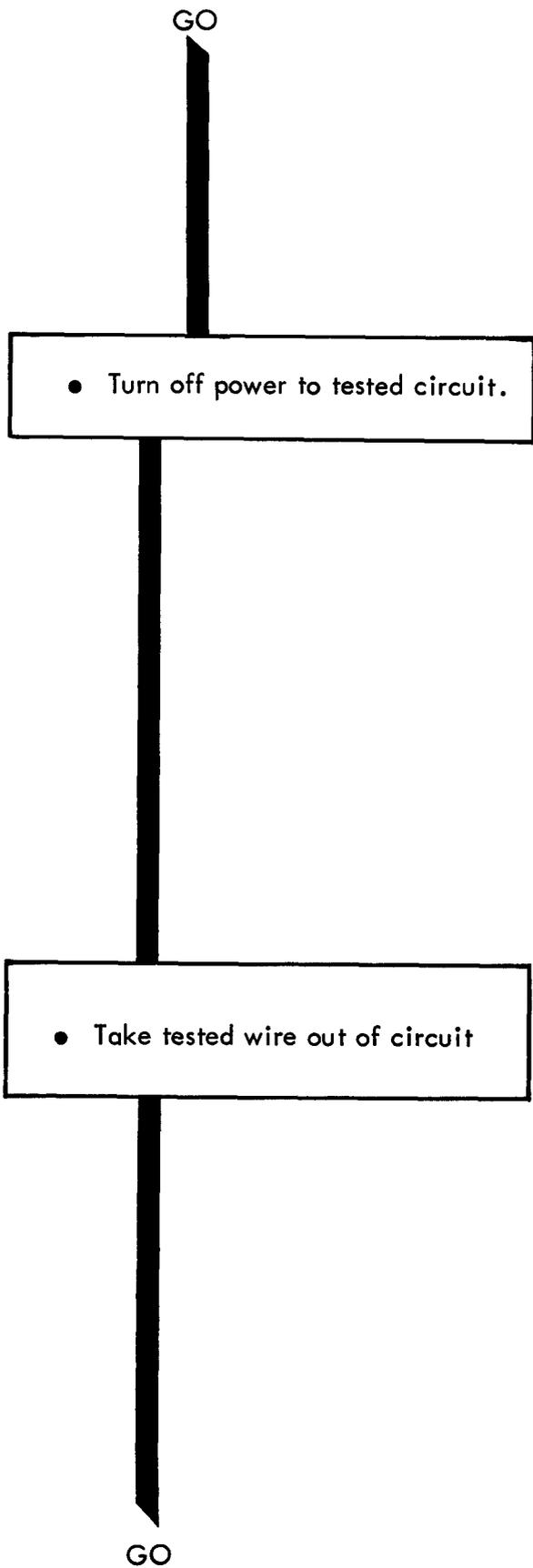
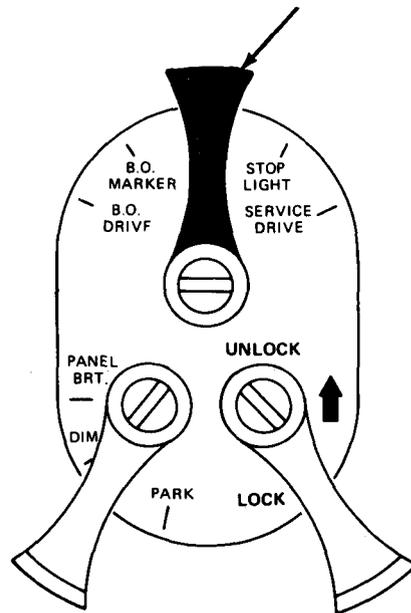

Figure 28-6 (Sheet 1 of 5)

TA 114680



SETTING LIGHT SWITCH MAIN LEVER TO OFF TURNS OFF POWER TO LIGHT CIRCUITS.



PLUG ON EACH END OF TRAILER CONNECTING CABLE REMOVED FROM MATING RECEPTACLE TO TAKE TESTED WIRE OUT OF CIRCUIT FOR SHORT TEST

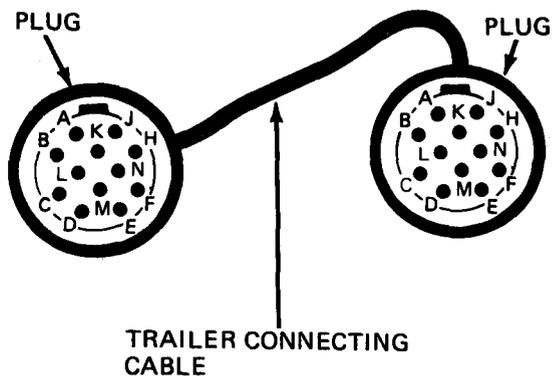

Figure 28-6 (Sheet 2 of 5)

TA 114681

GO

3

- Zero the multimeter
- Touch multimeter test probes together.

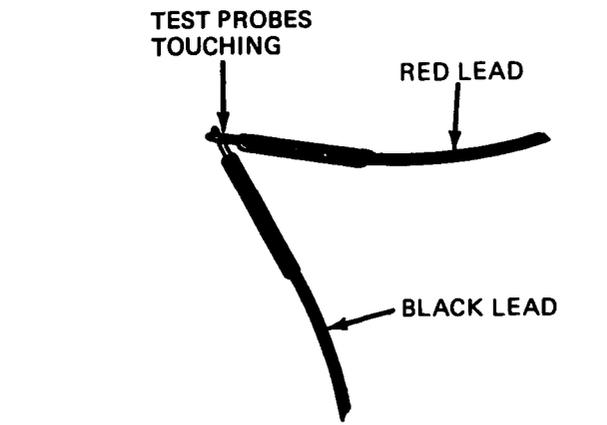

- While touching multimeter test probes together look at OHMS scale. Pointer should be at 0 (zero). If it is not, turn OHMS ADJ knob to move pointer to 0.

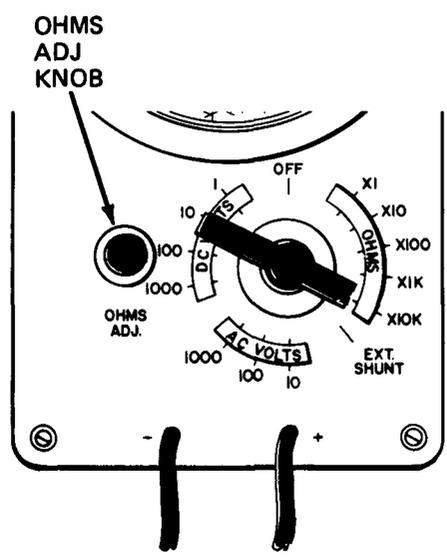
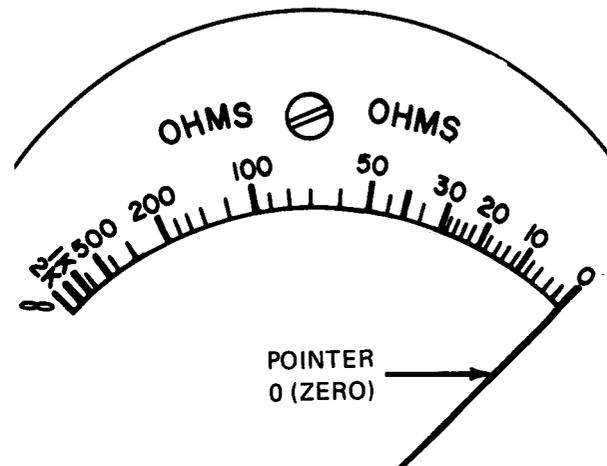

GO

TA 114682

Figure 28-6 (Sheet 3 of 5)

GO

4

- Put multimeter leads across tested circuit
- To test for short between two wires, put test probes on contacts of both wires.

GO

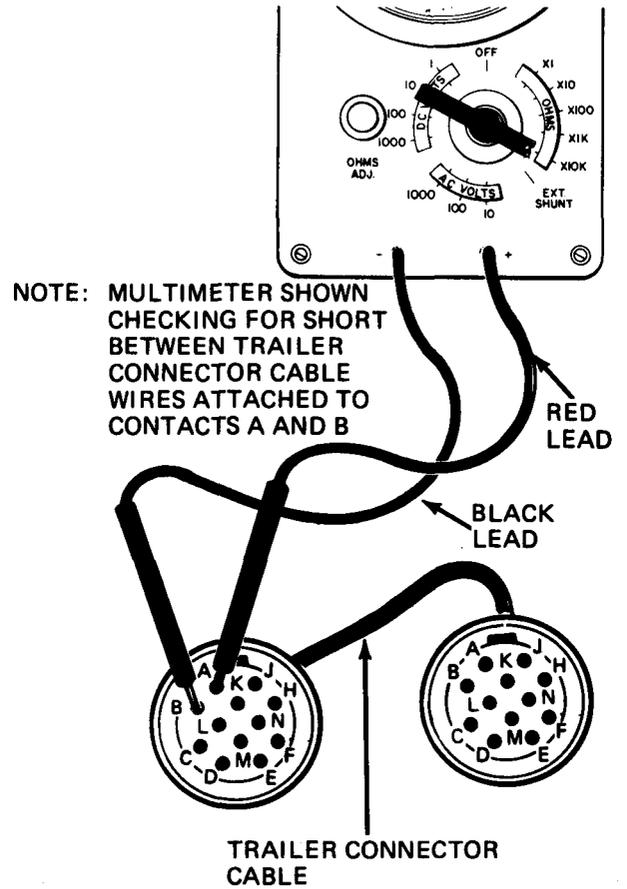

Figure 28-6 (Sheet 4 of 5)

GO

- To test for short between a wire and ground, put test probes on wire contact and ground.

5

- Read multimeter
 - Look at multimeter OHMS scale. If pointer stays all the way to far left without moving, circuits are not shorted.
 - If pointer moves all the way to far right over 0 (zero), circuits are shorted. If pointer jumps or flickers, circuits are sometimes shorted.

6

- Put tested circuit back in operation
 - Take off test prods from contacts and ground.
 - Put back any plugs or other parts previously removed to take tested wire out of circuit.

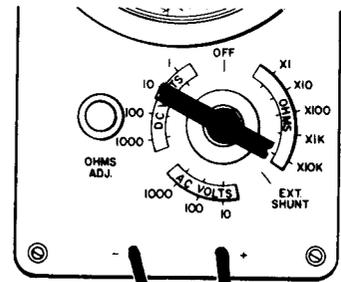

NOTE: MULTIMETER SHOWN CHECKING FOR SHORT BETWEEN TRAILER CONNECTOR CABLE WIRE ATTACHED TO CONTACT B AND GROUND

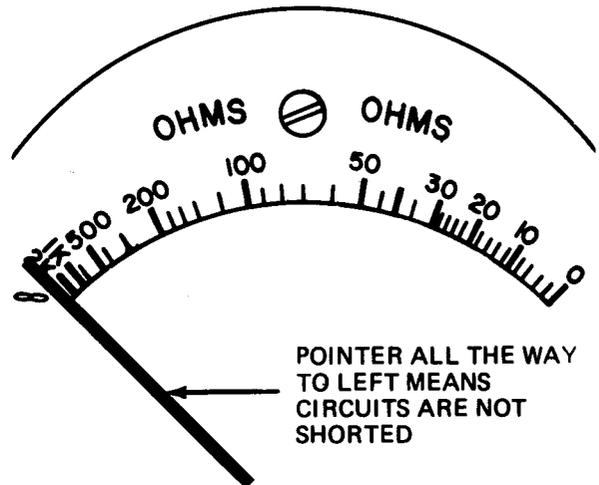
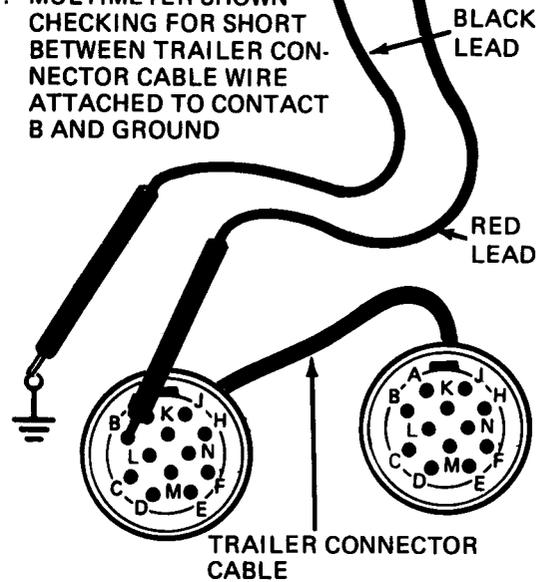

POINTER ALL THE WAY TO LEFT MEANS CIRCUITS ARE NOT SHORTED

Figure 28-6 (Sheet 5 of 5)

MULTIMETER SIMPSON 160 TEST PROCEDURES

GENERAL INSTRUCTIONS

- Check that multimeter is ready for use:
 - Calibration label - Check to be sure multimeter has been calibrated in the last 12 months
 - Meter - Glass and pointer not broken. Pointer should be resting over zero mark at left side of scales
 - Jack sockets - Open and dirt free
 - Batteries - Not corroded or leaking Put in right

- Cables - No cuts, sharp kinks or bad fraying
- Jack plugs - Tight on cable, prods clean
- Test prods - Tight on cable, tip free of paint or anything that might be an insulator
- Switches - Work freely without binding or scraping

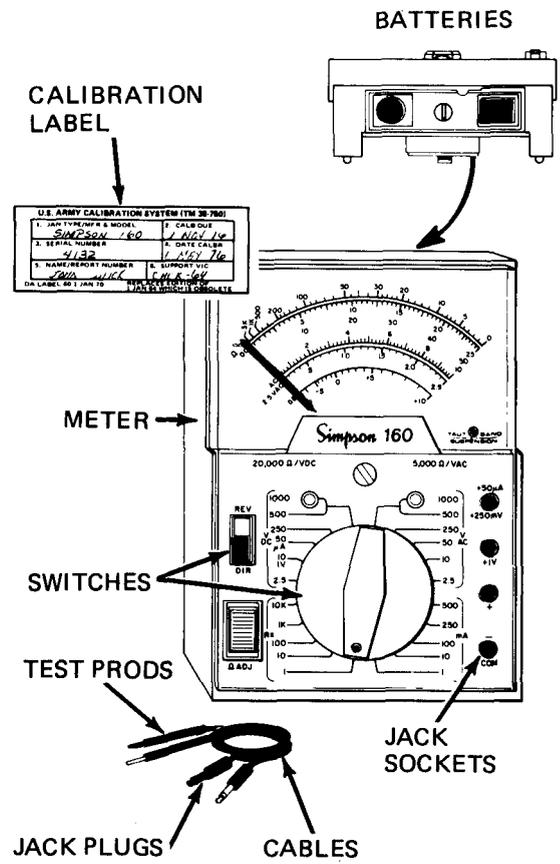
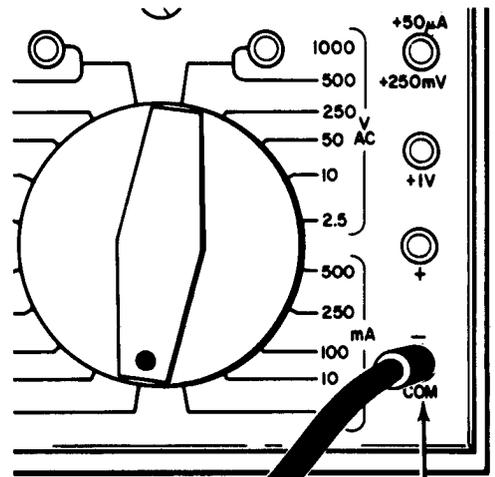

Figure 28-7

1 DC VOLTAGE TEST - To measure battery voltage, charging system output, and voltage drops at various test points

- 1
- Set up multimeter test leads:
 - Put jack plug of black (-) test lead into COM - jack
 - Note: The highest truck DC voltage that is measured is about 28 volts. Therefore, the multimeter red (+) lead is never put into the 1000 VDC jack
 - See table to find out which jack to put red (+) lead into. Table shows which jack to use when normal value of measured voltage is known or unknown



BLACK LEAD
THIS JACK IS THE METER CIRCUIT'S COMMON GROUND

IF NORMAL VALUE OF VOLTAGE BEING MEASURED IS THIS:	PUT RED LEAD INTO THIS JACK ON RIGHT SIDE OF MULTIMETER:
0 TO 230 MILLIVOLTS	+50 µA +250mV
230 MILLIVOLTS TO 0.8 VOLTS	+1V
0.8 TO 2 VOLTS	+
2 TO 8 VOLTS	+
8 TO 40 VOLTS	+
UNKNOWN	+

GO

Figure 28-8 (Sheet 1 of 13)

GO

- Put jack plug of red (+) test lead into jack receptacle you picked on right side of multimeter

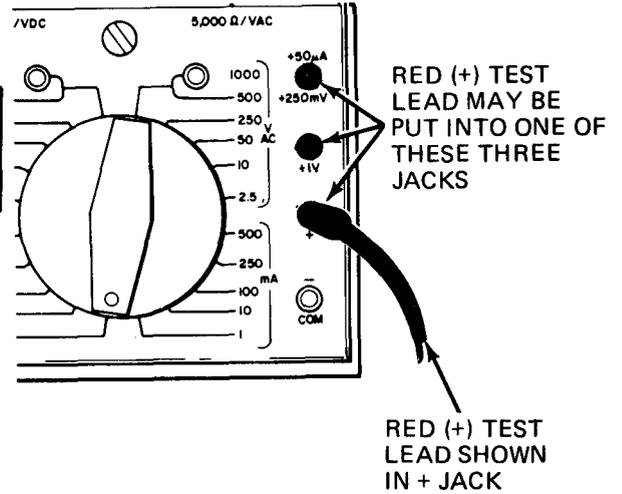

2

- Set up multimeter switches:
 Note: The Ω ADJ knob is not used for DC voltage tests
 - Set REV DIR switch to DIR

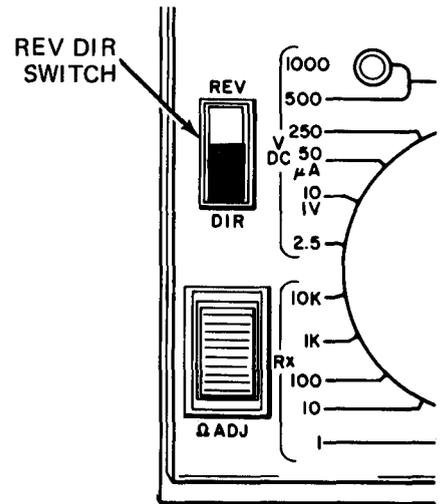

- See table to find out setting of function/range switch. Table shows switch setting when normal value of measured voltage is known or unknown

IF NORMAL VALUE OF VOLTAGE BEING MEASURED IN THIS:	SET FUNCTION/RANGE SWITCH TO:
0 TO 230 MILLIVOLTS	50 μ A
230 MILLIVOLTS TO 0.8 VOLTS	10 1V
0.8 TO 2 VOLTS	2.5
2 TO 8 VOLTS	10 1V
8 TO 40 VOLTS	50 μ A
UNKNOWN	50 μ A

GO

Figure 28-8 (Sheet 2 of 13)

GO

● Set function/range switch to setting you picked

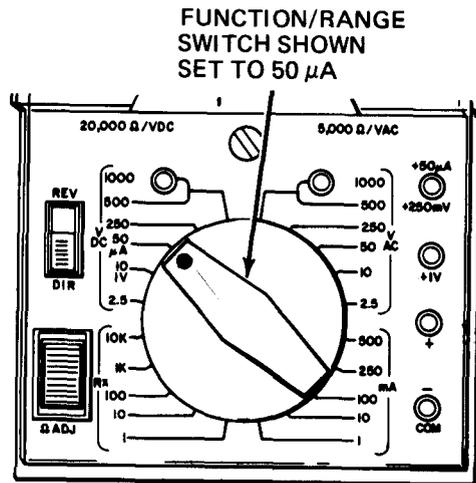

NOTE

When you need to turn on power before measuring DC voltage, the fault isolation procedure gives the turn-on instructions

NOTE: MULTIMETER SHOWN MEASURING +24 VOLTS DC BATTERY VOLTAGE

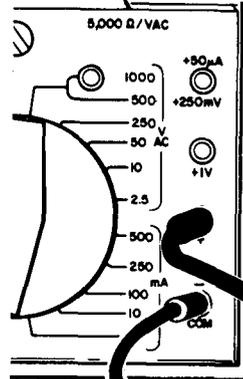

BLACK LEAD

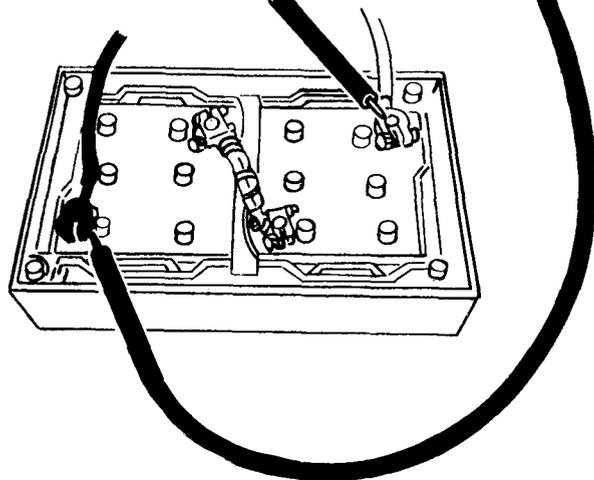

3

- Put multimeter leads across (in parallel with) circuit being measured
- Put test prod of black lead (-) on negative terminal of circuit being tested
- Put test prod of red lead (+) on positive terminal of circuit being measured

GO

4

- If normal value of voltage being measured is 8 to 40 Volts or unknown, read multimeter as follows:
 - Use 50 DC scale. Full scale voltage is 50 volts DC

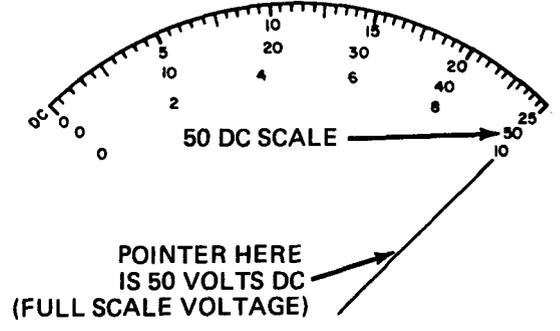

- Read each numbered line as shown

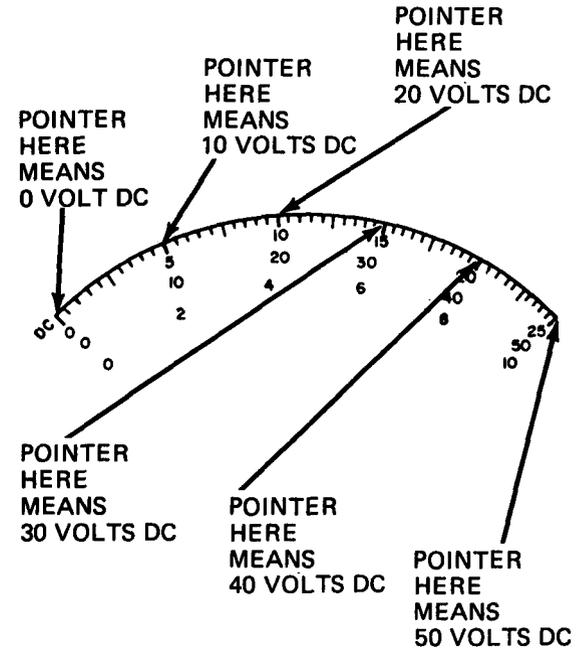

GO

Figure 28-8 (Sheet 4 of 13)

GO

● Each space between lines equals 1 volt

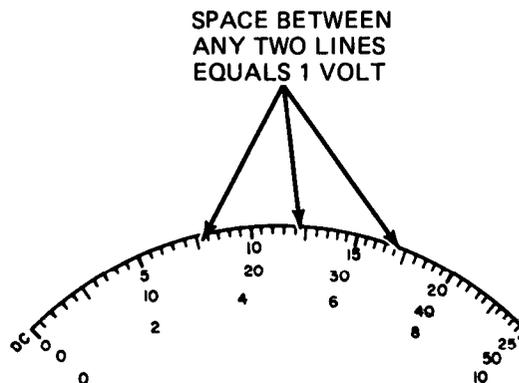

TS 260-20-305

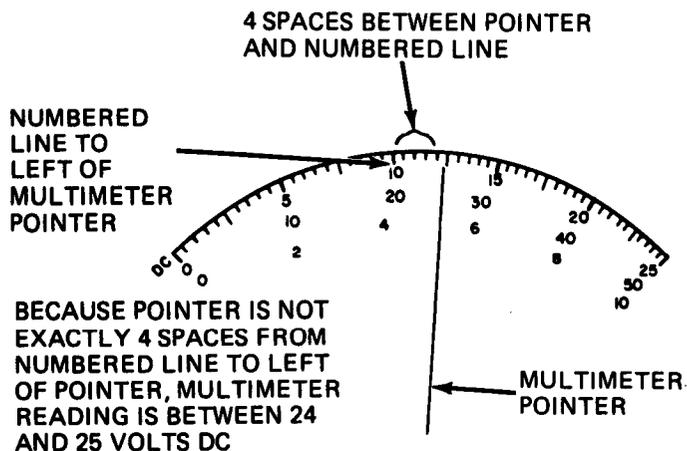

● Get multimeter reading as follows:

<u>Step A</u>	<u>Step B</u>	<u>Step C</u>
Read first numbered line to left of pointer.	Count number of spaces between pointer and numbered line to left of pointer.	Add numbers from steps A and B.
Example: 20	4	$20 + 4 = 24$ volts DC

GO

TA 114690

Figure 28-8 (Sheet 5 of 13)

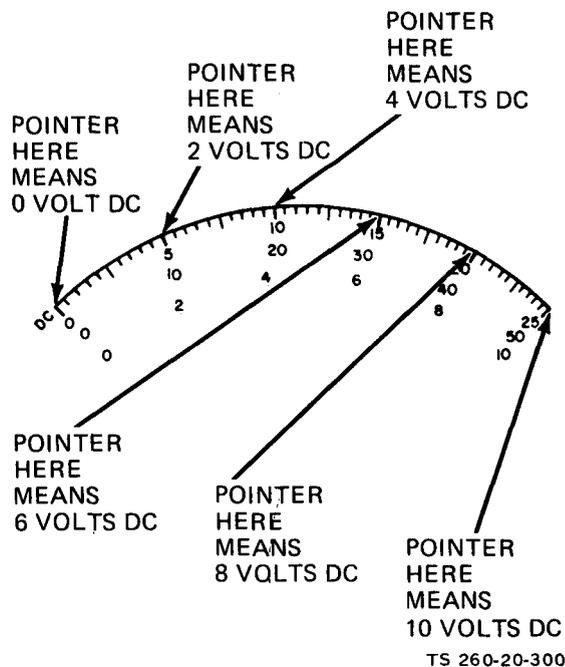
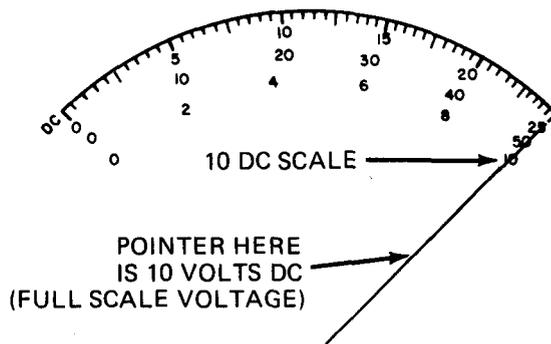
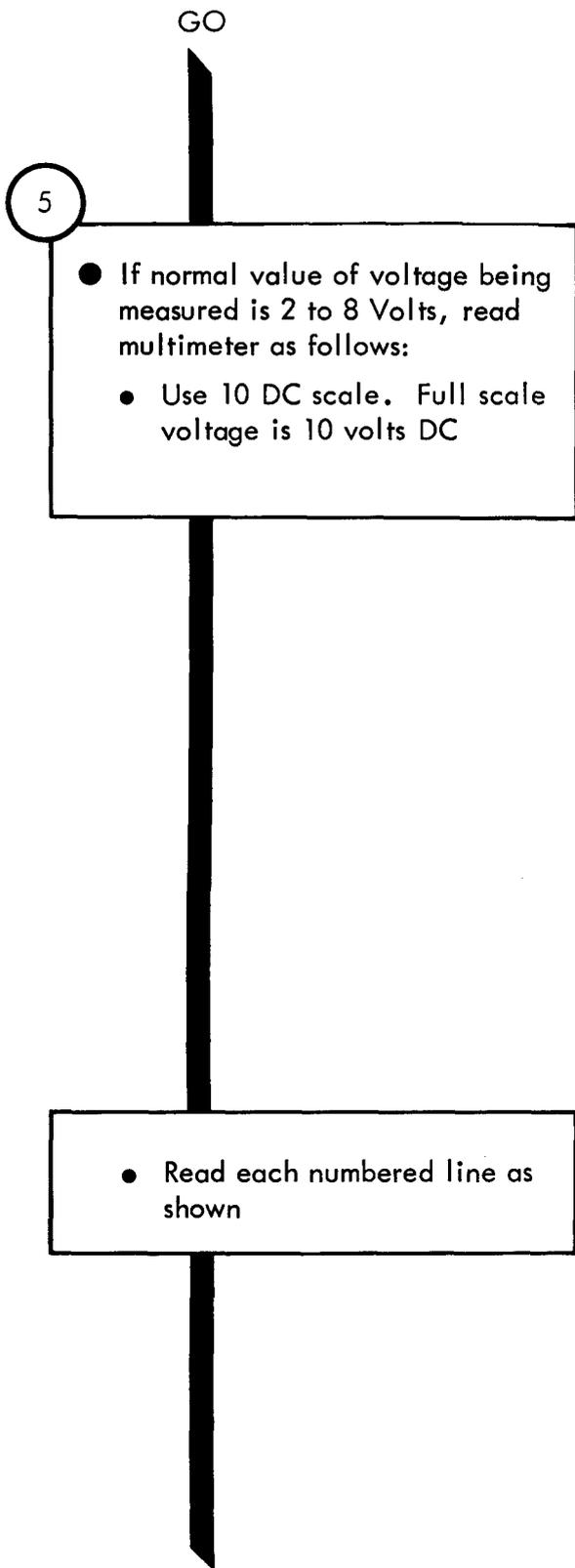

TA 114691

Figure 28-8 (Sheet 6 of 13)

GO

● Each space between lines equals 0.2 volt

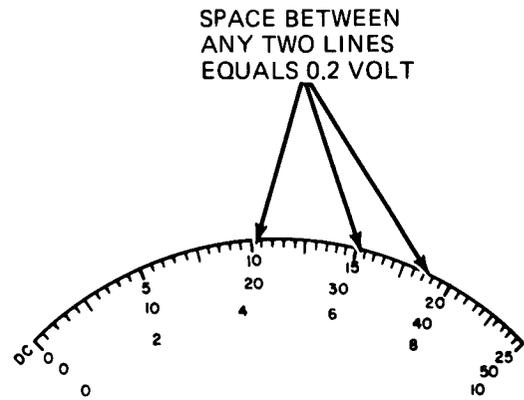

TS 260-20-301

3 SPACES BETWEEN POINTER AND NUMBERED LINE

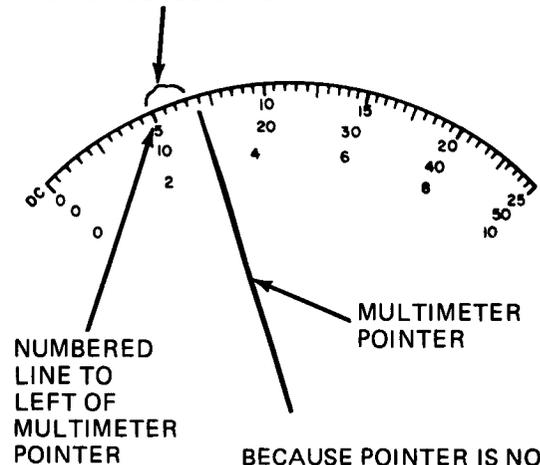

BECAUSE POINTER IS NOT EXACTLY 3 SPACES FROM NUMBERED LINE TO LEFT OF POINTER, MULTIMETER READING IS BETWEEN 2.6 AND 2.8 VOLTS DC

● Get multimeter reading as follows:

<u>Step A</u>	<u>Step B</u>	<u>Step C</u>	<u>Step D</u>
Read first numbered line to left of pointer.	Count number of spaces between pointer and first numbered line to left of pointer.	Multiply number from step B by 0.2.	Add numbers from steps A and C.
Example: 2	3	$3 \times 0.2 = 0.6$	$2 + 0.6 = 2.6$ volts DC

GO

TA 114692

Figure 28-8 (Sheet 7 of 13)

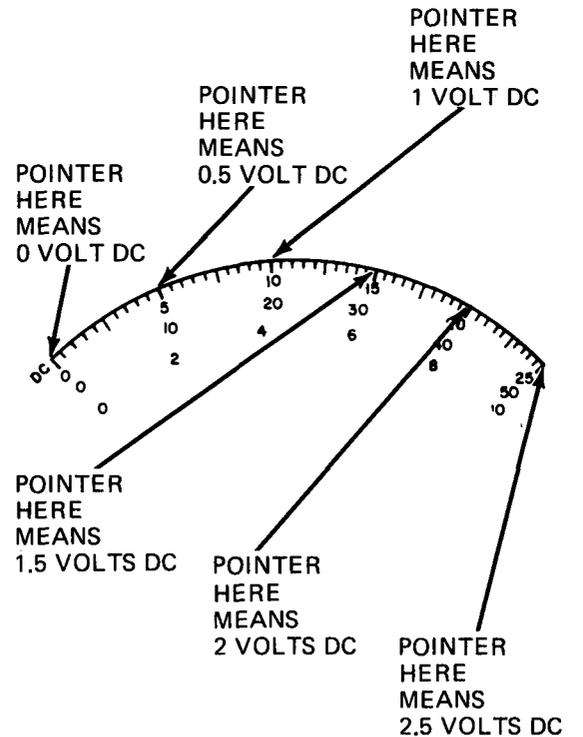
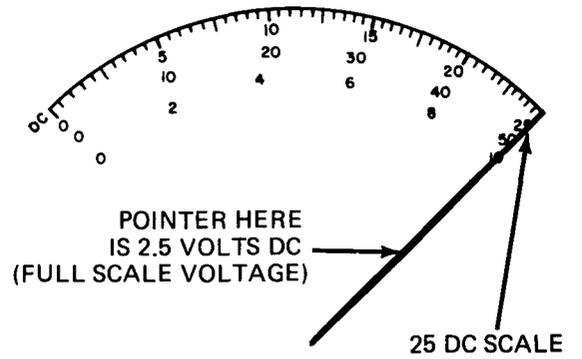
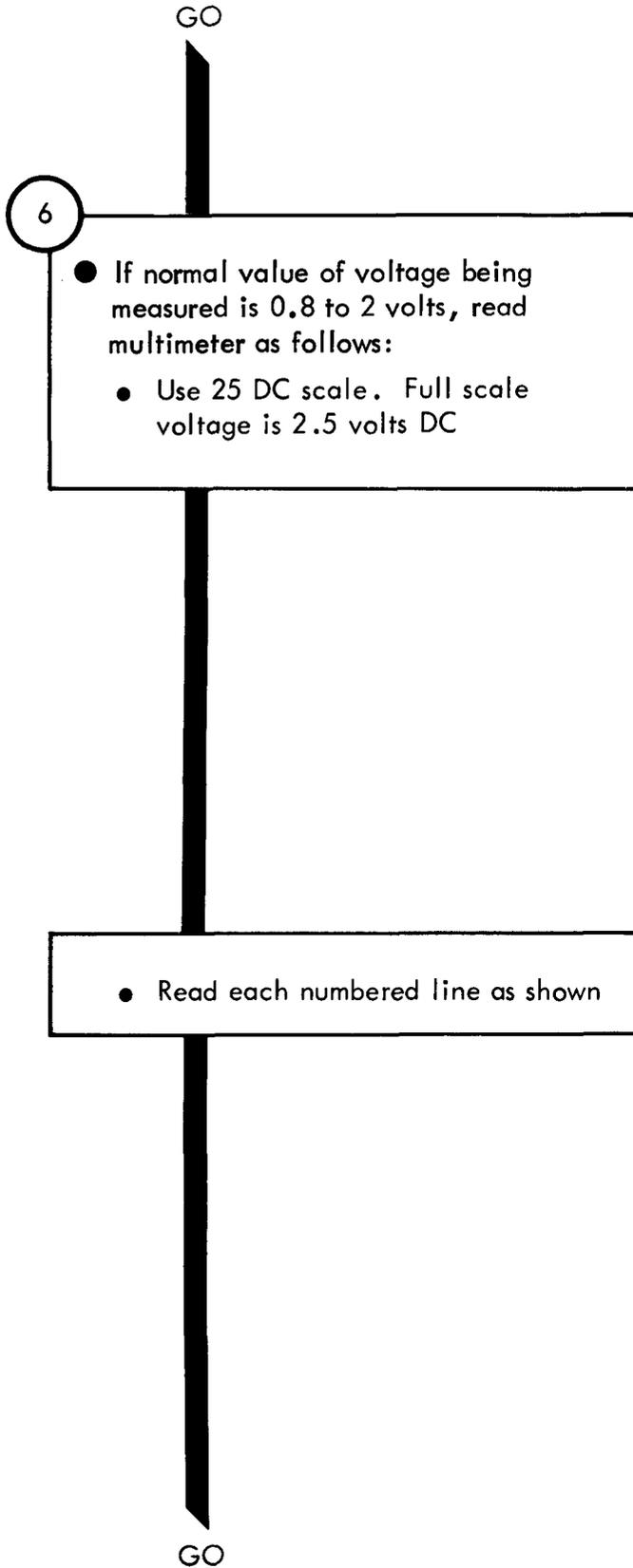
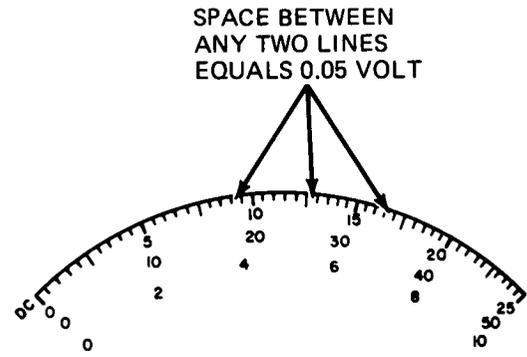

Figure 28-8 (Sheet 8 of 13)

GO

● Each space between lines equals 0.05 volt



3 SPACES BETWEEN POINTER AND NUMBERED LINE

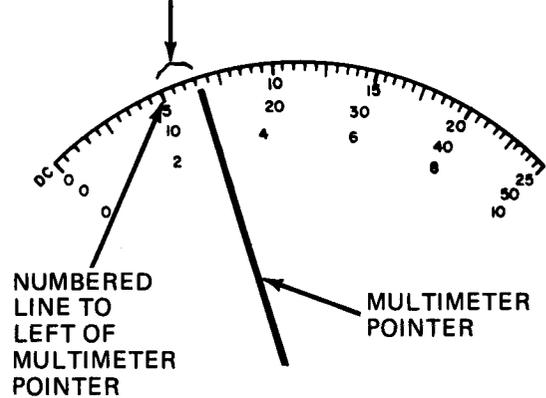

BECAUSE POINTER IS NOT EXACTLY 3 SPACES FROM NUMBERED LINE TO LEFT OF POINTER, MULTIMETER READING IS BETWEEN 0.65 AND 0.7 VOLTS DC.

● Get multimeter reading as follows:

Step A	Step B	Step C	Step D
Read first numbered line to left of pointer. Divide number by 10.	Count number of spaces between pointer and first numbered line to left of pointer.	Multiply number from step B by 0.05.	Add numbers from steps A and C.
Example: 0.5	3	$3 \times 0.05 = 0.15$	$0.5 + 0.15 = 0.65$ volt DC

GO

Figure 28-8 (Sheet 9 of 13)

GO

7

- If normal value of voltage being measured is 230 millivolts to 0.8 volts, read multimeter as follows:
 - Use 10 DC scale. Full scale voltage is 1 volt DC

- Read each numbered line as shown

GO

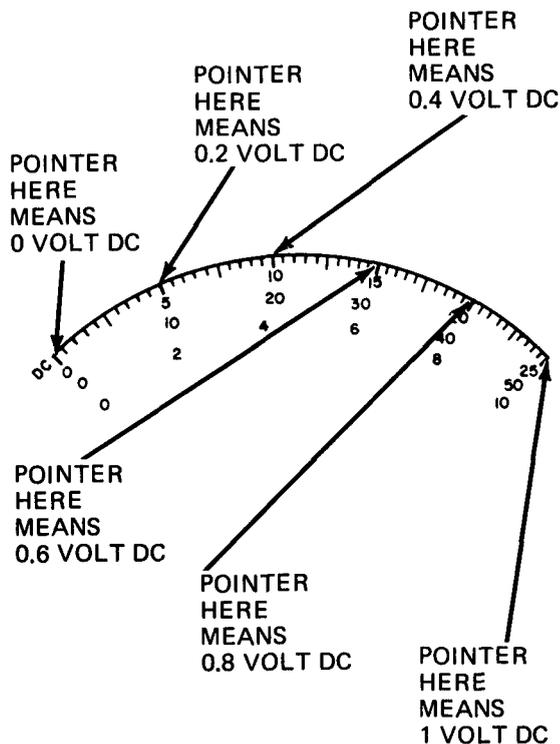
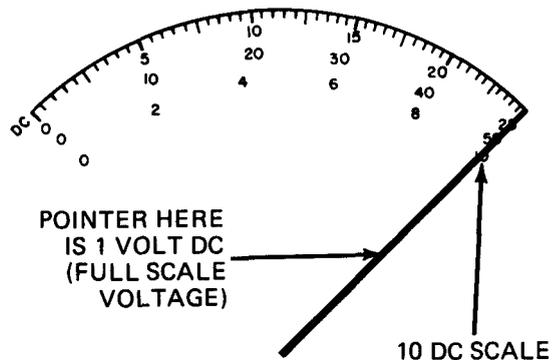

GO

● Each space between lines equals 0.02 volt

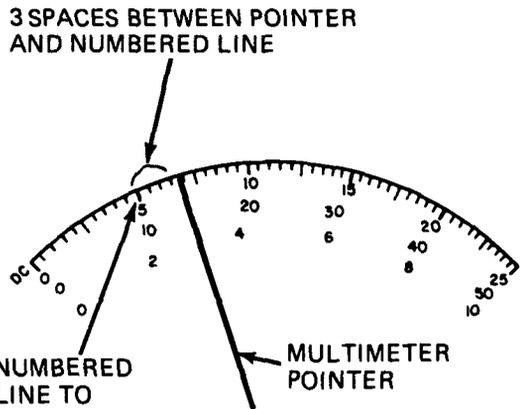
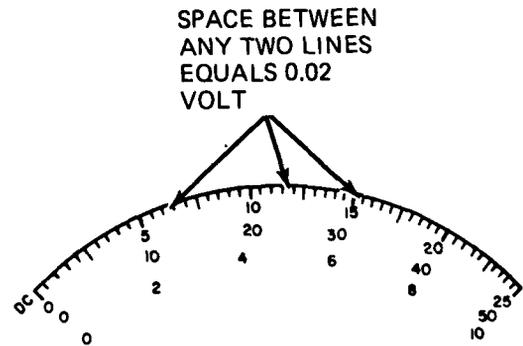

BECAUSE POINTER IS NOT EXACTLY 3 SPACES FROM NUMBERED LINE TO LEFT OF POINTER, MULTIMETER READING IS BETWEEN 0.26 AND 0.28 VOLTS DC

● Get multimeter reading as follows:

<u>Step A</u>	<u>Step B</u>	<u>Step C</u>	<u>Step D</u>
Read first numbered line to left of pointer. Divide number by 10.	Count number of spaces between pointer and first numbered line to left of pointer.	Multiply number from step B by 0.02.	Add numbers from steps A and C.
Example: 0.2	3	$3 \times 0.02 = 0.06$	$0.2 + 0.06 = 0.26$ volt DC

GO

Figure 28-8 (Sheet 11 of 13)

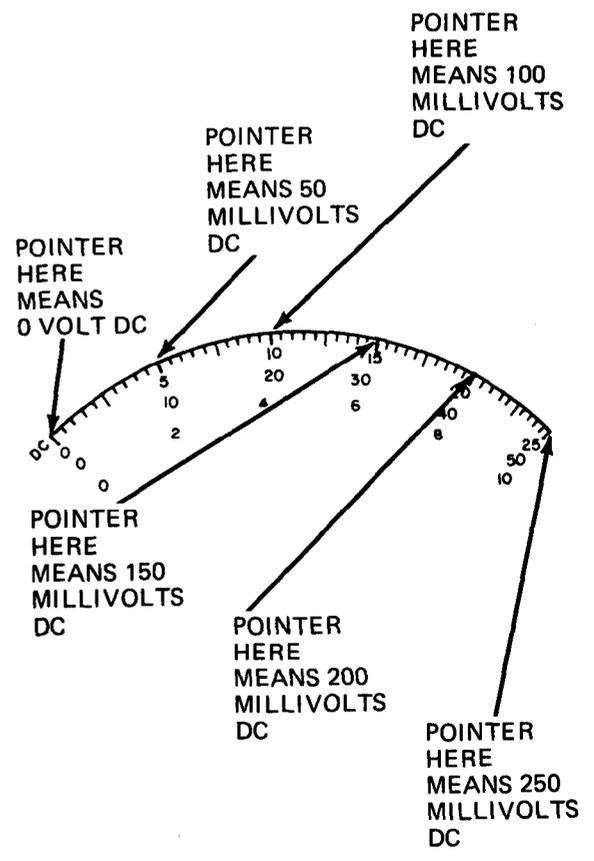
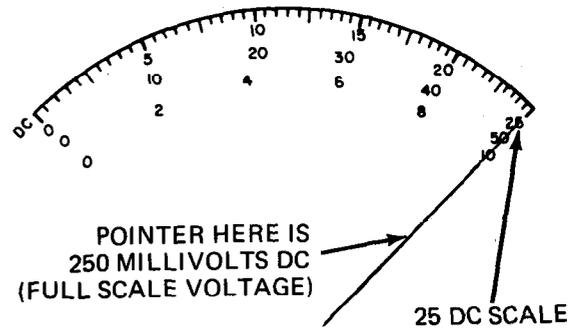
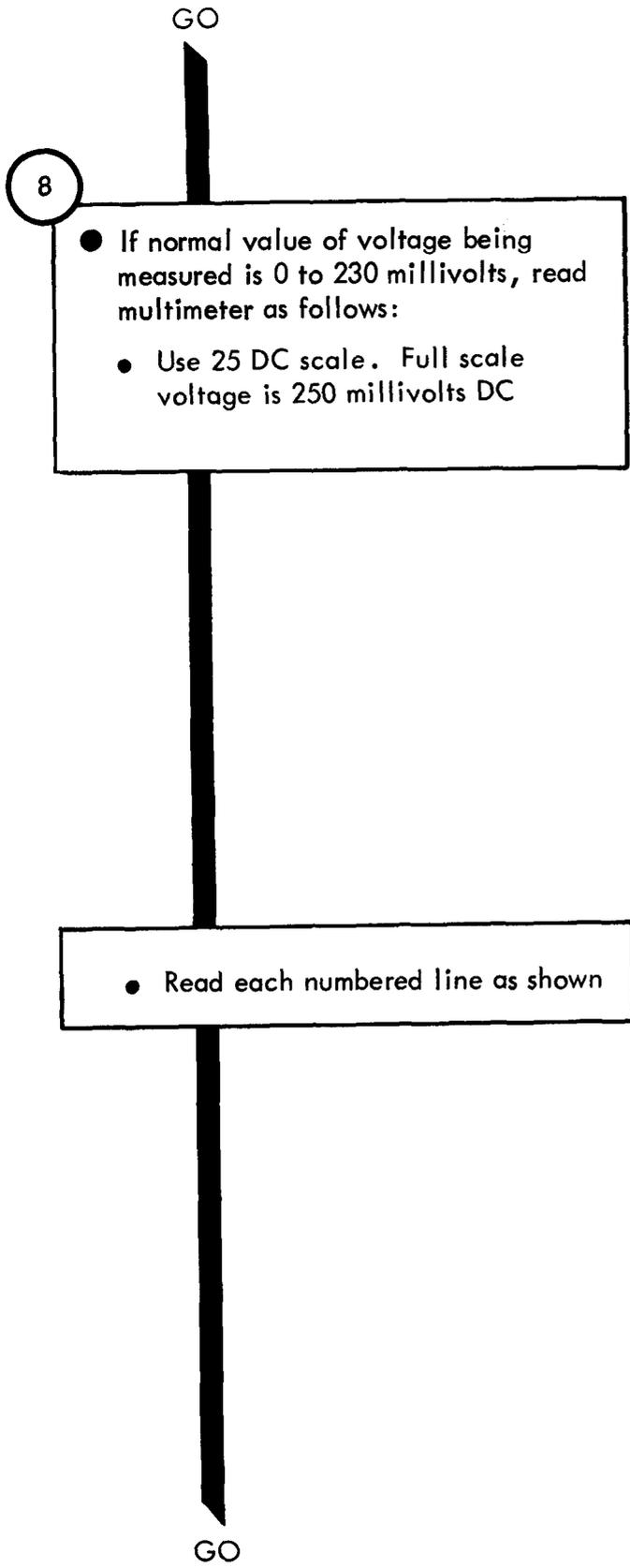

TA 114697

Figure 28-8 (Sheet 12 of 13)

GO

● Each space between lines equals 5 millivolts

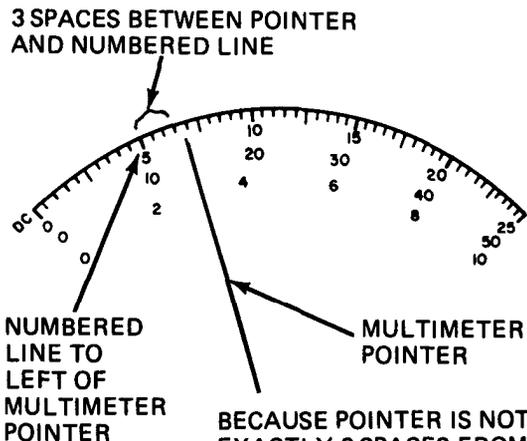
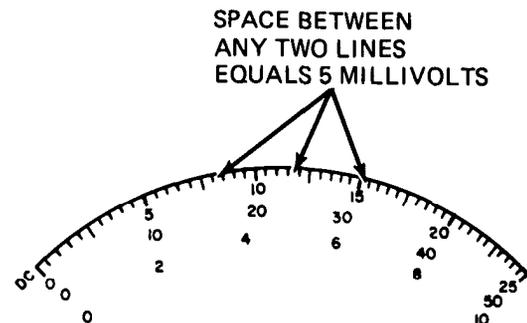

● Get multimeter reading as follows:

Step A	Step B	Step C	Step D
Read first numbered line to left of pointer.	Count number of spaces between pointer and first numbered line to left of pointer.	Multiply number from step B by 5	Add numbers from steps A and C.
Example: 50	3	$3 \times 5 = 15$	$50 + 15 = 65$ millivolts DC

9

● Make circuit normal again.

● Take both test prods off measured circuit

Figure 28-8 (Sheet 13 of 13)

TA 114698

2

AC VOLTAGE TEST - To measure van input and operating voltages

1

- Set Up Multimeter As Follows:
 - Note: The truck AC voltages measured are 208 and 120 volts. Therefore, only the 250 VAC function/range switch position is used
 - Set function/range switch to 250 VAC
 - Set REV DIR switch to DIR
 - Note: The Ω ADJ knob is not used for DC voltage tests
 - Put jack plug of black test lead into COM - jack receptacle
 - Put jack plug of red test lead into + jack receptacle

NOTE

When you need to turn on power before measuring AC voltage, the fault isolation procedure gives the turn-on instructions

GO

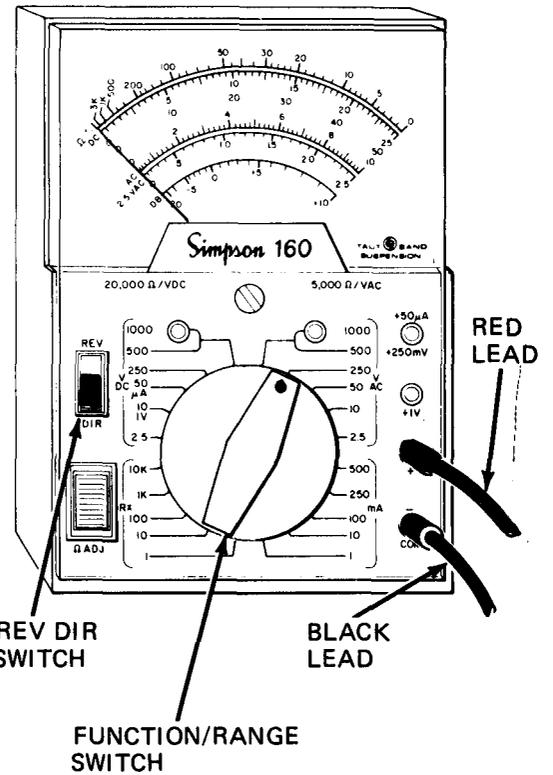

GO

2

- Put multimeter lead across (in parallel with) circuit being measured

Note: In AC voltage measurement you can hook up the test lead connections to the circuit either way. You will still get correct multimeter readings and no damage will be done to the multimeter. But, when one side of the circuit is electrical ground, it is a good idea to put the black lead on electrical ground.

- Put test prod of black lead on ground side or one side of the circuit being tested. Put test prod of red lead on other side of circuit being measured

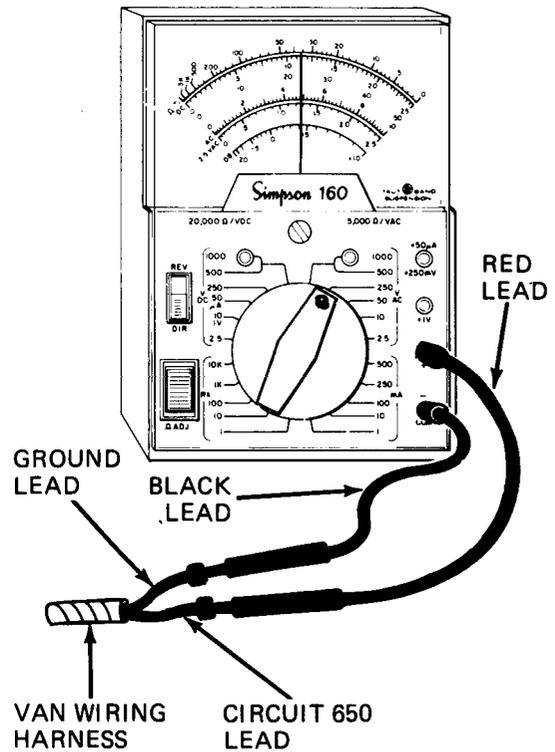

NOTE: MULTIMETER SHOWN MEASURING 120 VOLTS AC VAN CEILING LIGHT VOLTAGE.

GO

3

- Read multimeter
 - Use 25 AC scale. Full scale voltage is 250 volts AC

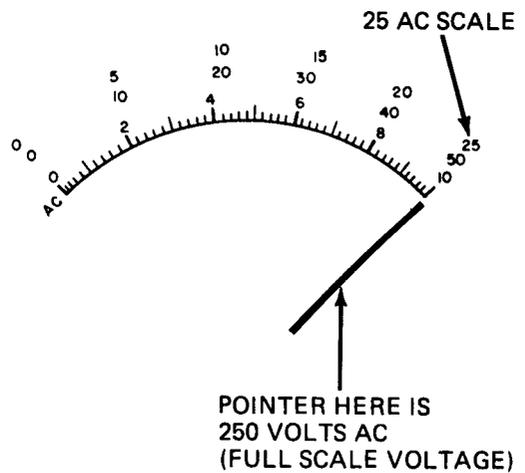

GO

TA 114700

Figure 28-9 (Sheet 2 of 4)

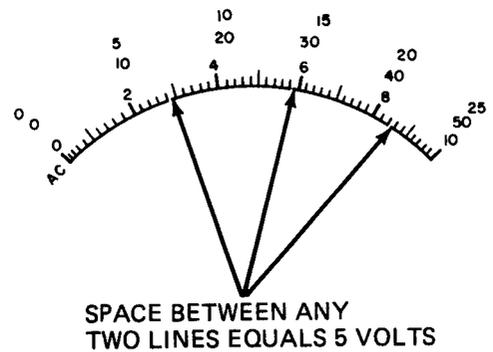
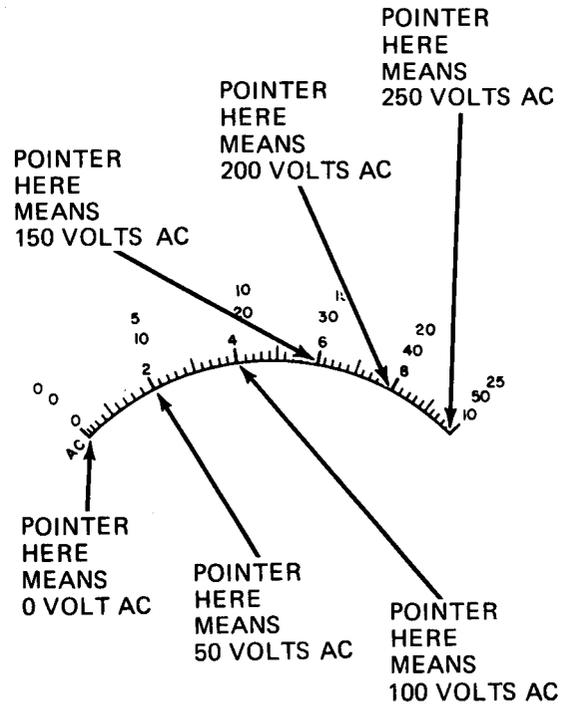
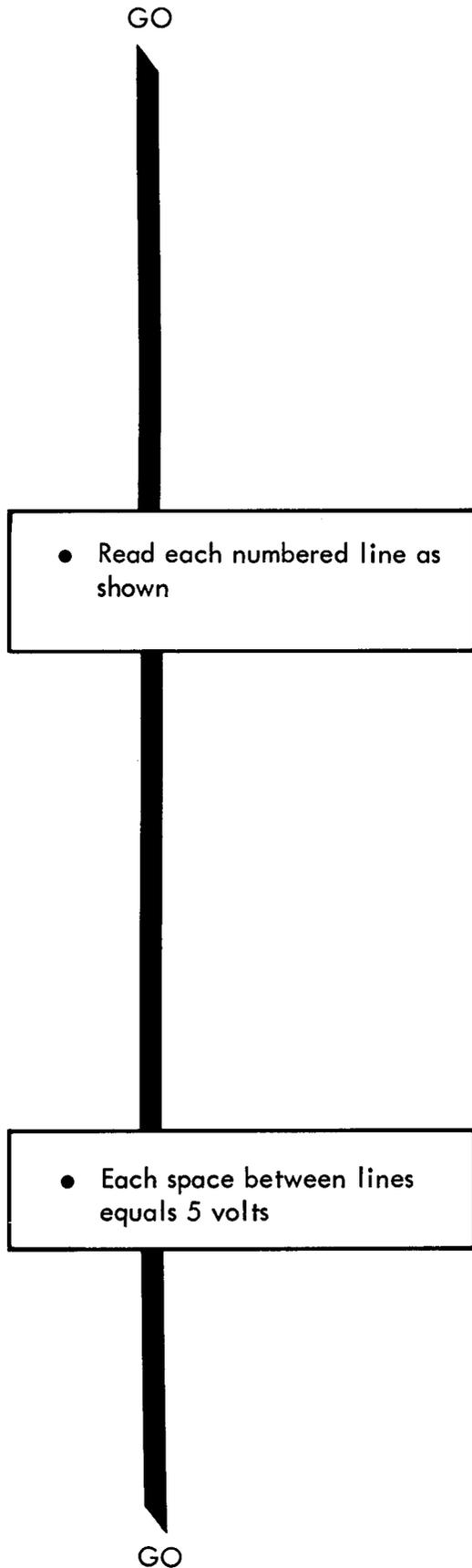

TA 114701

Figure 28-9 (Sheet 3 of 4)

GO

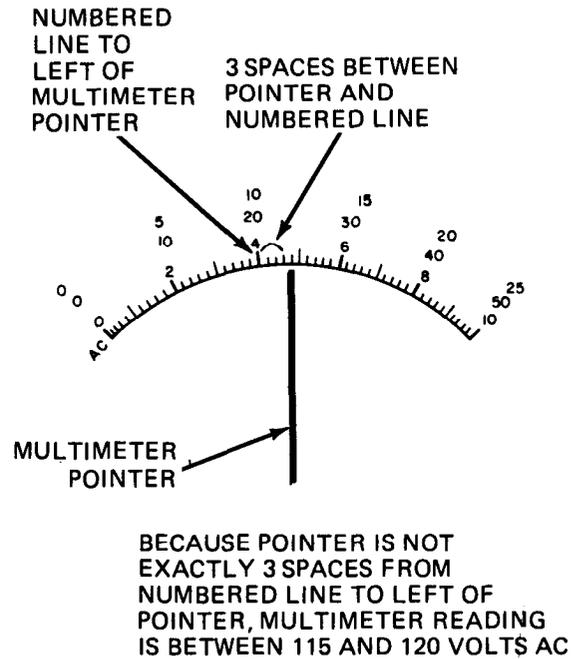

- Get multimeter reading as follows:

Step A	Step B	Step C	Step D
Read first numbered line to left of pointer. Multiply number by 10.	Count number of spaces between pointer and first numbered line to left of pointer.	Multiply number from step B by 5.	Add numbers from steps A and C.
Example: 100	3	$3 \times 5 = 15$	$100 + 15 = 115$ volts AC

4

- Make circuit normal again
 - Take both test prods off measured circuit

TA 114702

Figure 28-9 (Sheet 4 of 4)

3

RESISTANCE TEST- To measure resistance of temperature sending unit and blower motor resistor

1

- Set up multimeter:
 - Set REV DIR switch to REV
 - Set function/range switch to 10K
 - Put jack plug of black test lead into COM - jack receptacle
 - Put jack plug of red test lead into + jack

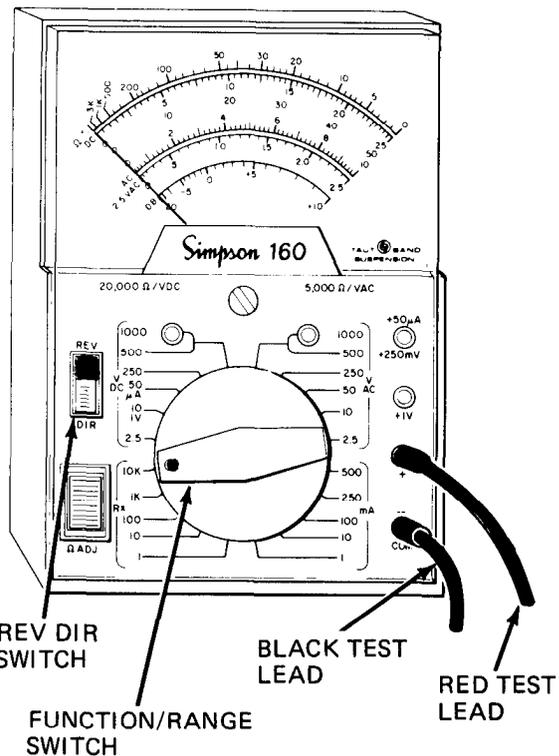

NOTE

Detailed steps for making the truck parts ready for resistance test are in the fault isolation procedures. The steps given here are typical

2

- Make tested part ready for resistance test

GO

TA 114703

Figure 28-10 (Sheet 1 of 10)

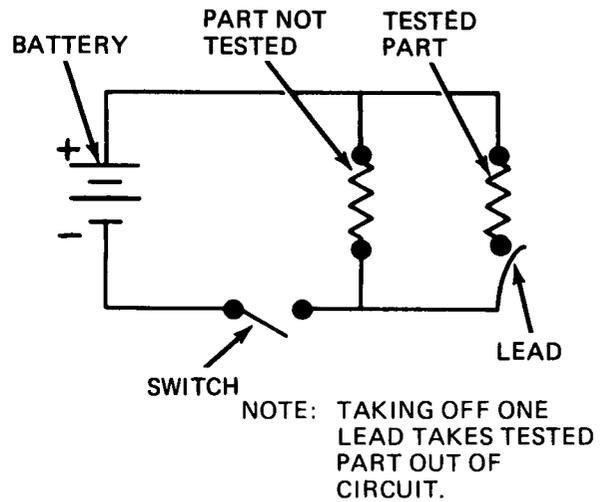
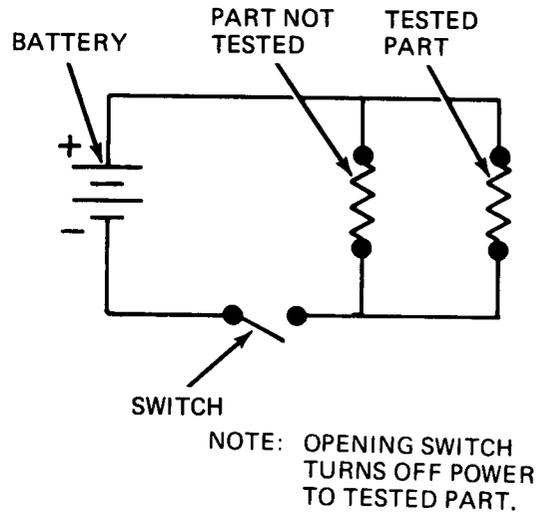
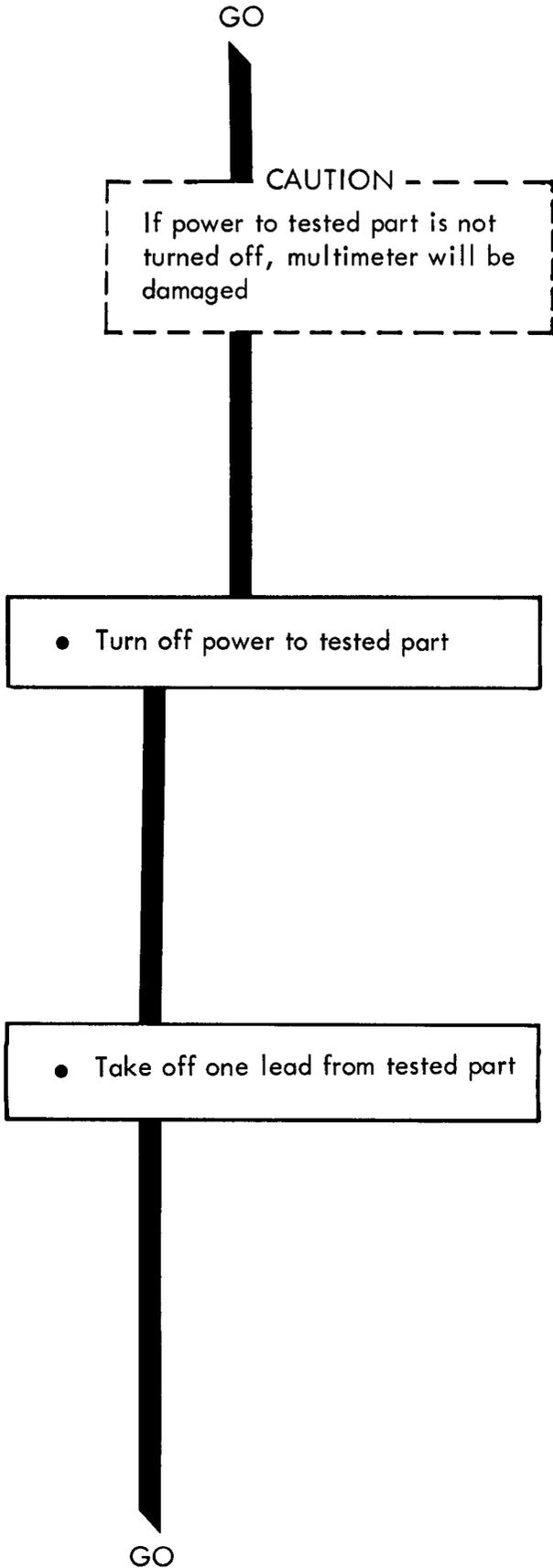

TA 114704

Figure 28-10 (Sheet 2 of 10)

GO

3

- Zero the multimeter:
 - Touch multimeter test probes together

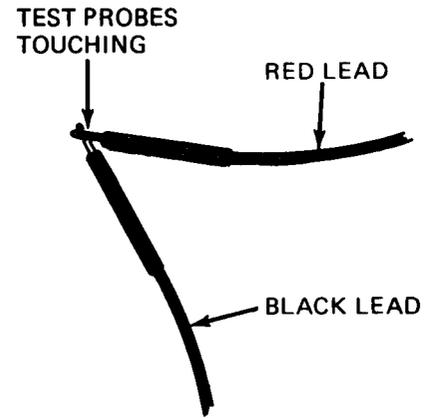

- While touching multimeter test probes together look at ohms scale. Pointer should be at 0 (zero). If it is not, turn Ω ADJ knob to move pointer to 0

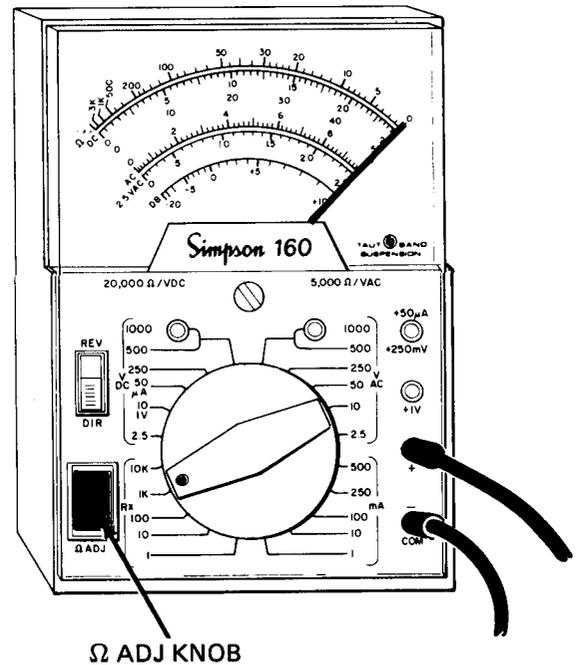
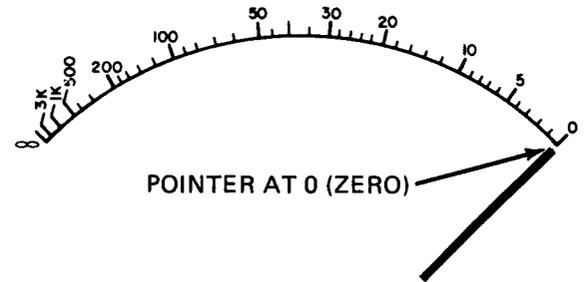

GO

TA 114705

Figure 28-10 (Sheet 3 of 10)

GO

NOTE: MULTIMETER SHOWN MEASURING RESISTANCE OF A COLD START RESISTOR.

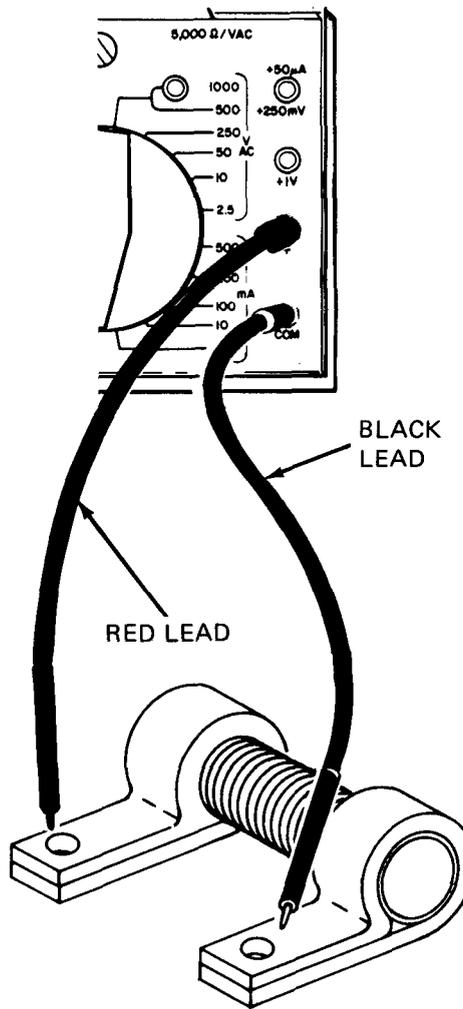

BLACK LEAD

RED LEAD

RESISTOR UNDER TEST

4

- Put multimeter leads across tested part
- Put one test prod on one terminal of tested part
- Put other test prod on other terminal of tested part

NOTE

Zero the multimeter each time you turn the function/range switch knob to another position. (See step 3)

GO

Figure 28-10 (Sheet 4 of 10)

GO

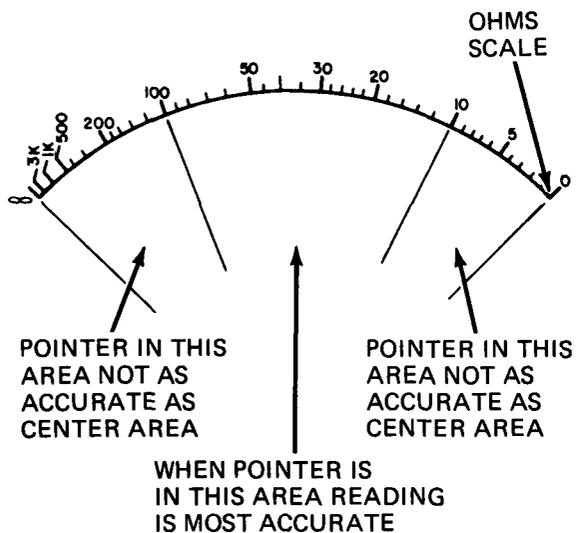

5

- Get the most accurate multimeter reading as follows:
 - Note: The closer the multimeter pointer is to the center of the ohms scale, the more accurate the reading.
- Note position of pointer on ohms scale. Turn function/range knob to left while looking at pointer. Try to find function/range switch knob position that gives most centered pointer position

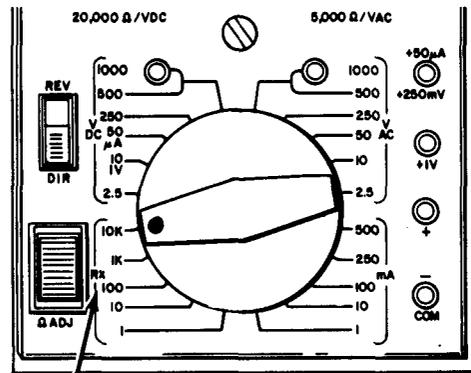

ONLY THESE SWITCH POSITIONS USED FOR RESISTANCE MEASUREMENTS

NOTE: MOVING FUNCTION/RANGE SWITCH KNOB TO LEFT MOVES POINTER TO LEFT

TA 114707

GO

Figure 28-10 (Sheet 5 of 10)

GO

- You may overshoot most centered pointer position. If you do, turn function/range switch knob to right to put pointer in most centered position

- Pointer will stay in right area if resistance is less than 10 ohms. Pointer will stay in left area if resistance is more than 1,000,000 ohms
- Leave function/range switch in position that puts pointer in most centered position

GO

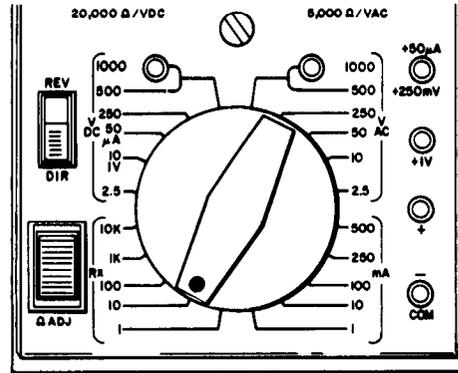

NOTE: MOVING FUNCTION/RANGE SWITCH KNOB TO RIGHT MOVES POINTER TO RIGHT

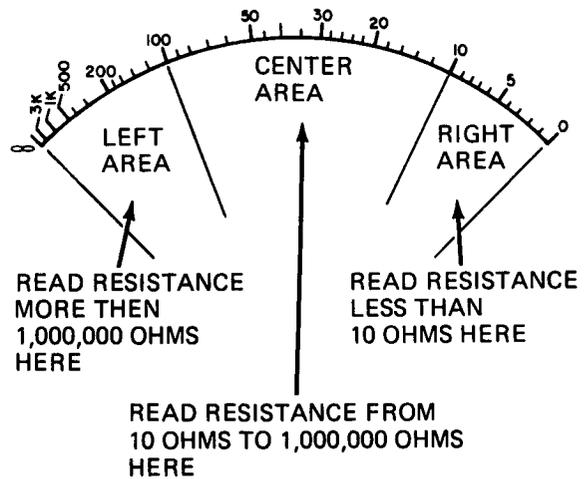

TA 114708

Figure 28-10 (Sheet 6 of 10)

GO

6

- If pointer falls exactly on a numbered line read multimeter as follows:
 - a. Look at ohms scale and see which numbered line pointer is on: 50

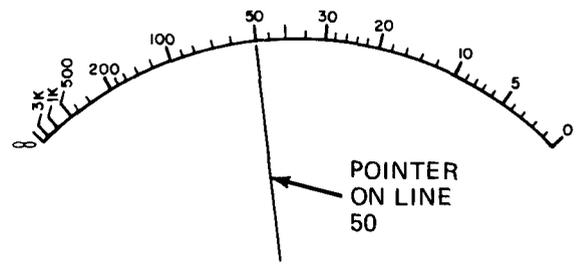

- b. See what function/range switch position number is: 10
- c. Multiply number from step a by number from step b to get multimeter reading: $50 \times 10 = 500$ ohms

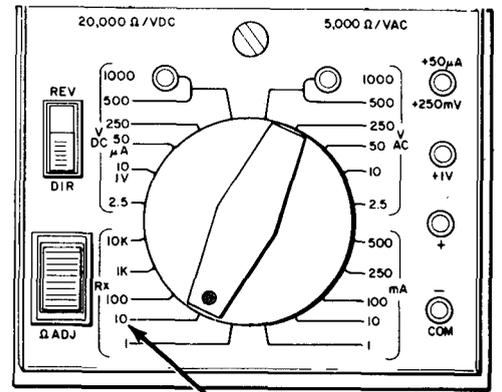

GO

TA 114709

Figure 28-10 (Sheet 7 of 10)

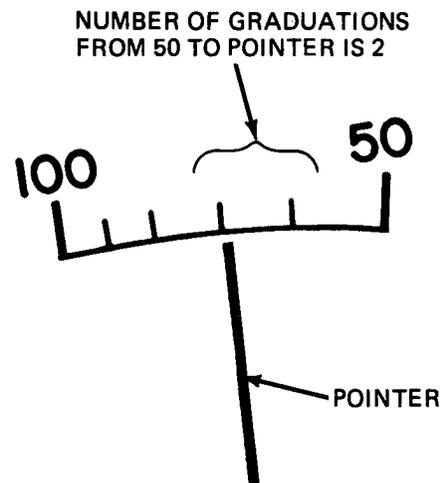
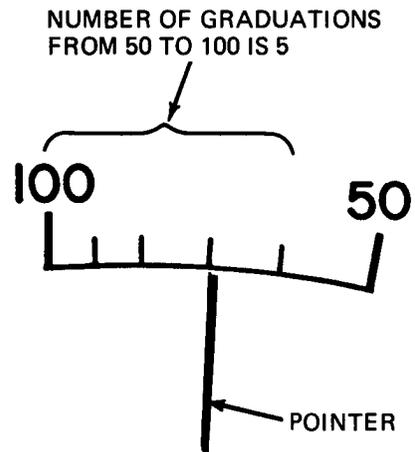
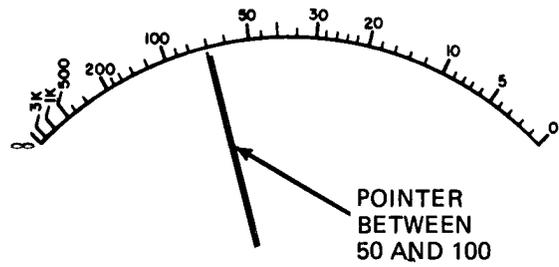
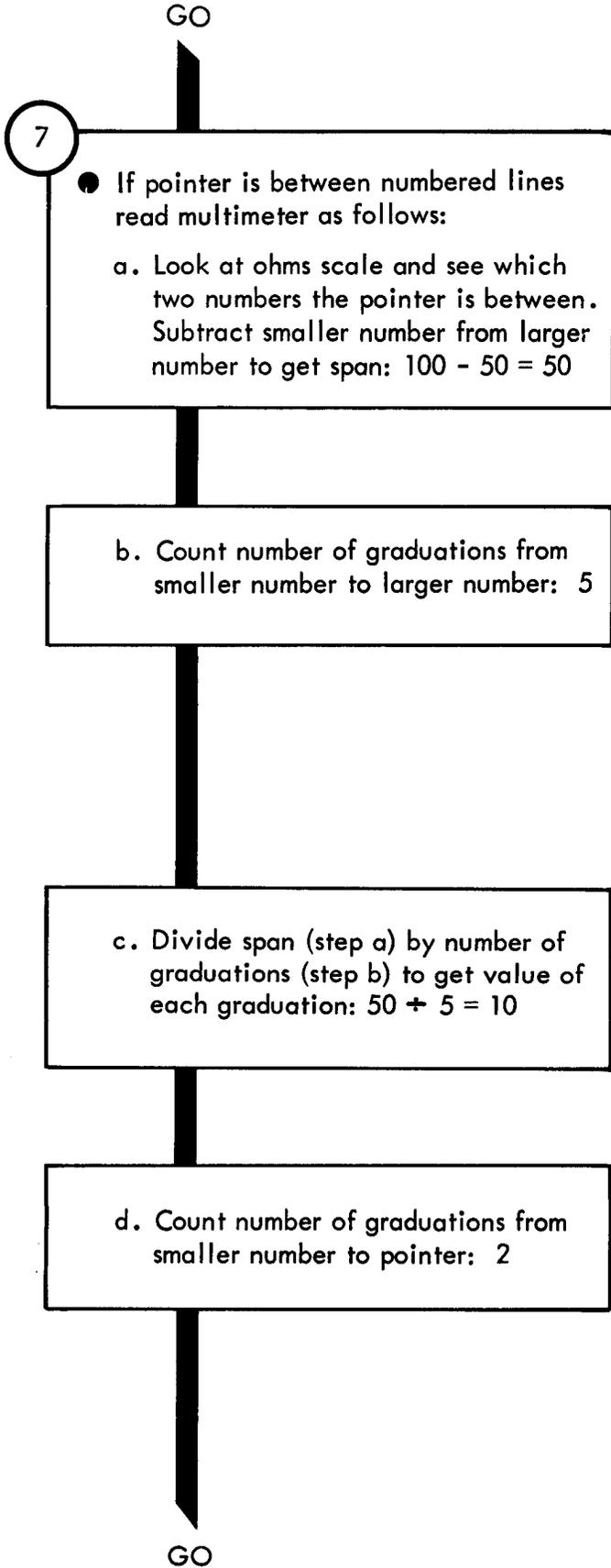

TA 114710

Figure 28-10 (Sheet 8 of 10)

GO

e. Multiply number from step 7d by value from step 7c to get total value of graduations:
 $2 \times 10 = 20$

f. Add total value of graduations (step e) to smaller number to get scale reading:
 $20 + 50 = 70$

g. Multiply scale reading (step f) by function/range switch position number to get multimeter reading:
 $70 \times 10 = 700 \text{ ohms}$

GO

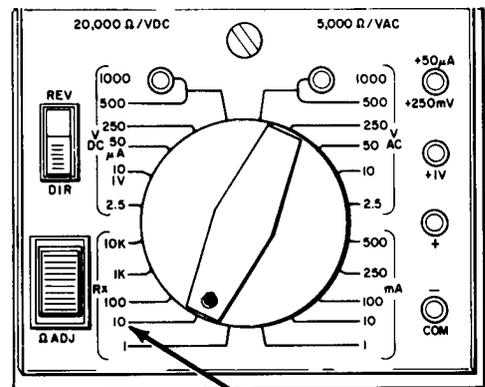
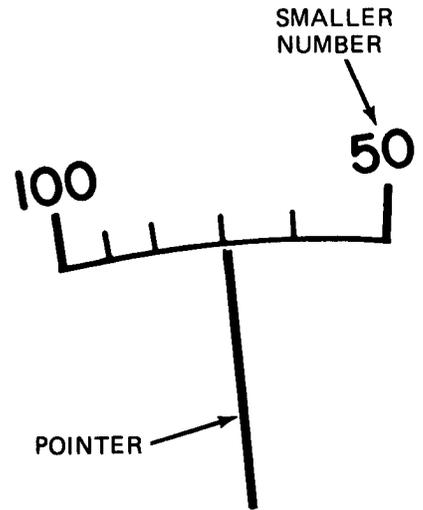

FUNCTION/RANGE SWITCH POSITION NUMBER IS 10

TA 114711

Figure 28-10 (Sheet 9 of 10)

GO

8

- Put tested part back in circuit
- Take off both test prods from across tested part
- Put lead back on tested part

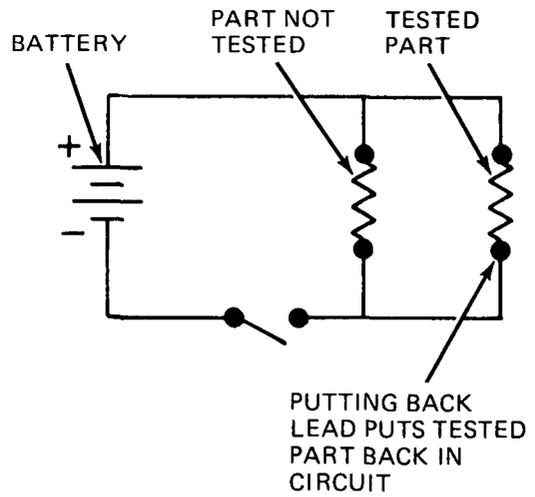

Figure 28-10 (Sheet 10 of 10)

4

CONTINUITY TEST - To check for breaks in a circuit, such as switch, lamp or electrical cable circuits

1

- Set up multimeter
- Set REV DIR switch to DIR
- Set function/range switch to RX1
- Put jack plug of black (-) test lead into COM - jack
- Put jack plug of red (+) test lead into + jack

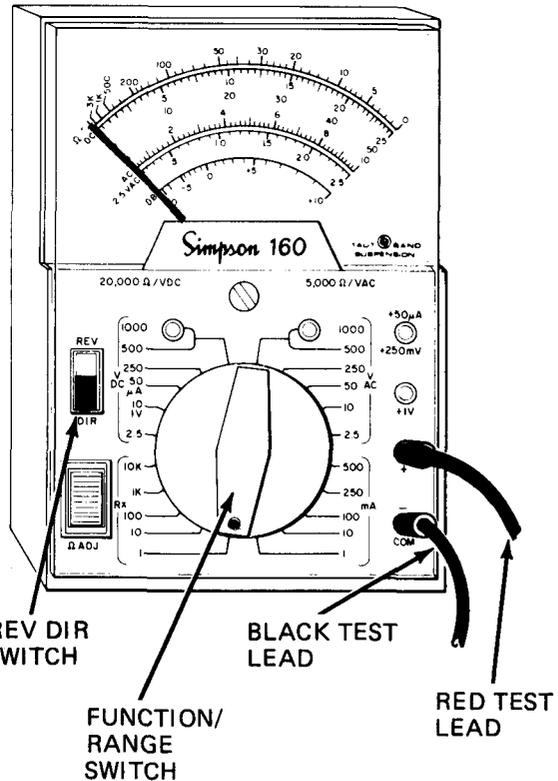

TA 114712

Figure 28-11 (Sheet 1 of 6)

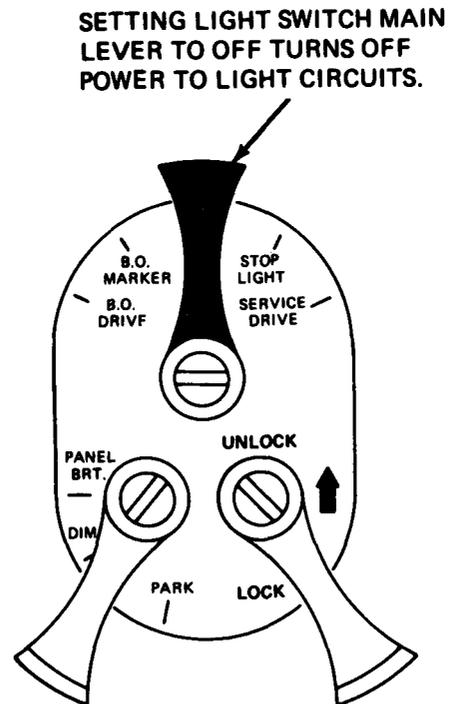
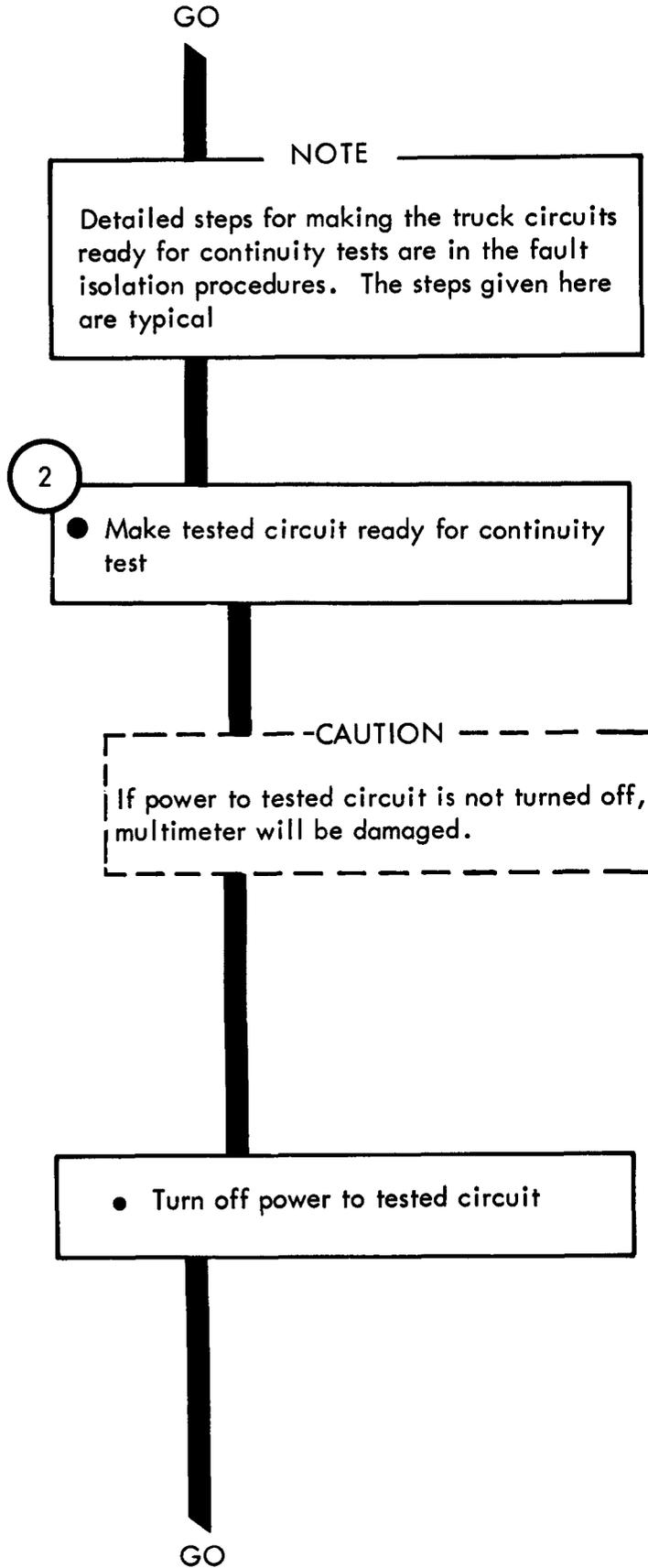

TA 114713

Figure 28-11 (Sheet 2 of 6)

GO

- Take plug on each end of trailer connecting cable off mating receptacle

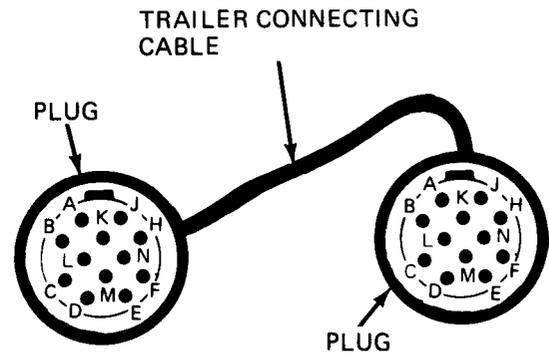

TAKING CABLE PLUGS OFF MATING RECEPTACLES LETS YOU TEST CONTINUITY OF CABLE WIRES

3

- Zero the multimeter
- Touch multimeter test probes together

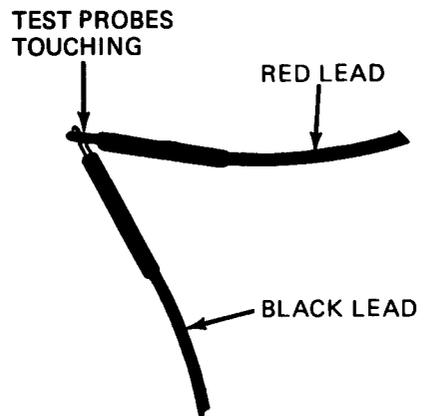

GO

TA 114714

Figure 28-11 (Sheet 3 of 6)

GO

- While touching multimeter test probes together look at ohms scale. Pointer should be at 0 (zero). If it is not, turn Ω ADJ knob to move pointer to 0

GO

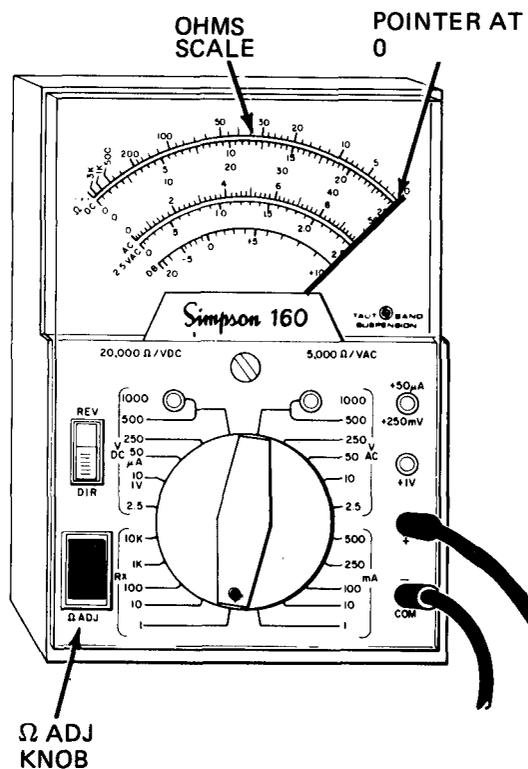
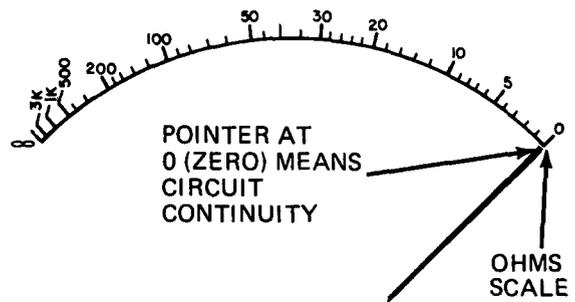
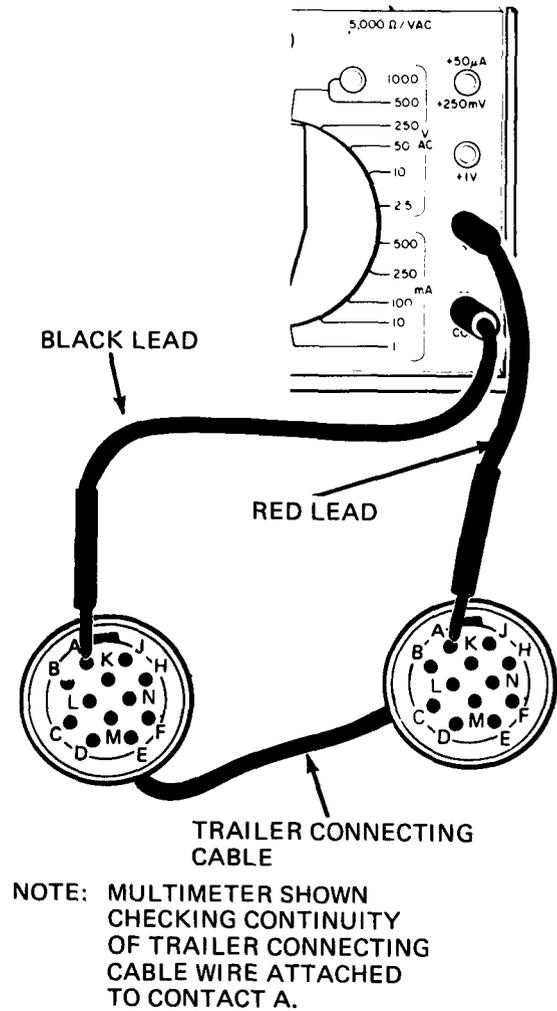
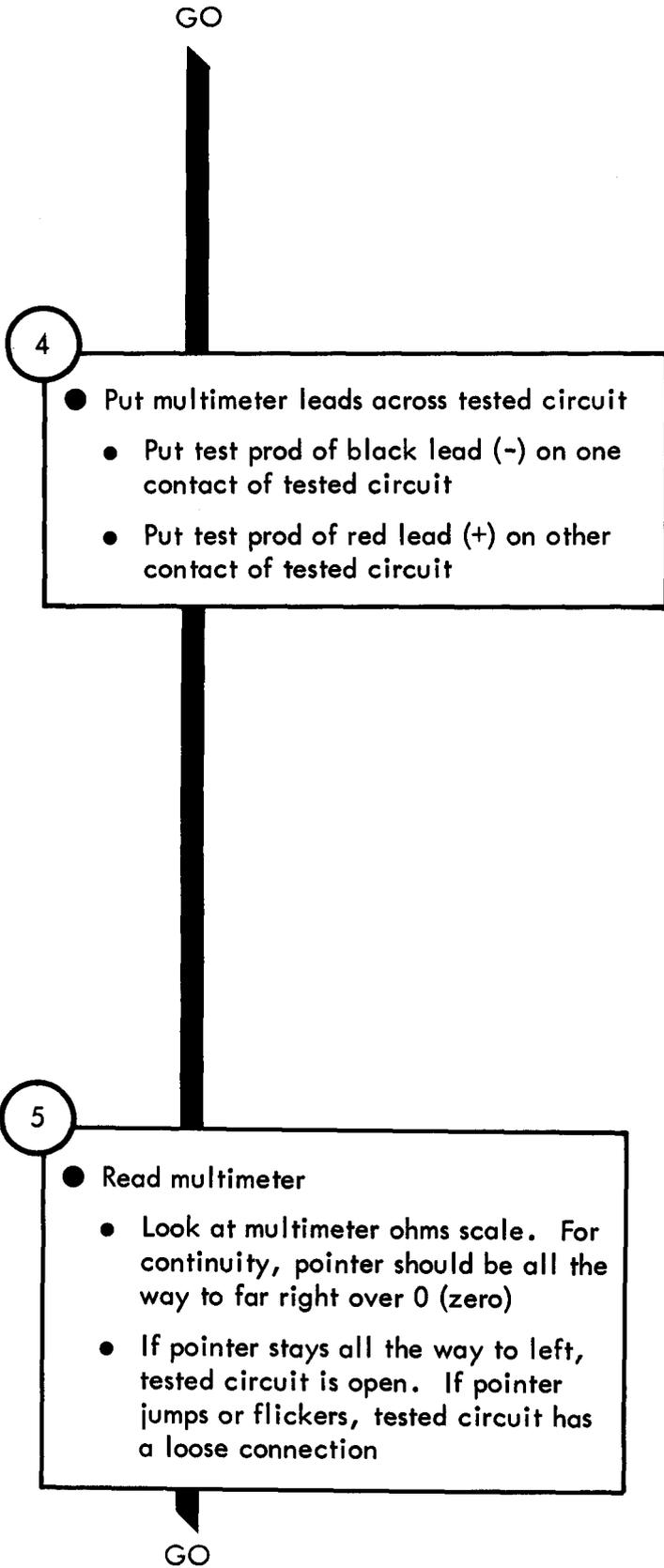

Figure 28-11 (Sheet 4 of 6)



TA 114716

Figure 28-11 (Sheet 5 of 6)

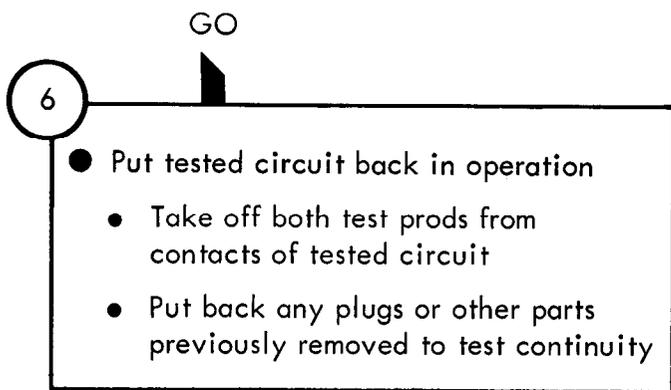

Figure 28-11 (Sheet 6 of 6)

5

SHORT TEST - To check for shorts in electrical cables

NOTE

A short (or short circuit) happens when two circuits that should not be connected have metal-to-metal contact with each other. A short also happens when a circuit that should not touch electrical ground has metal-to-metal contact with ground

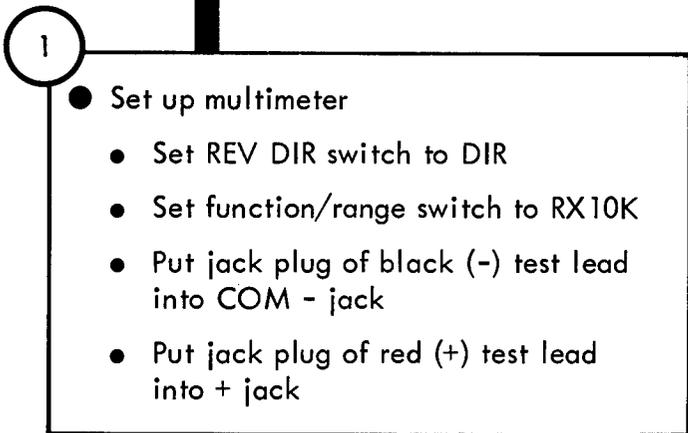

GO

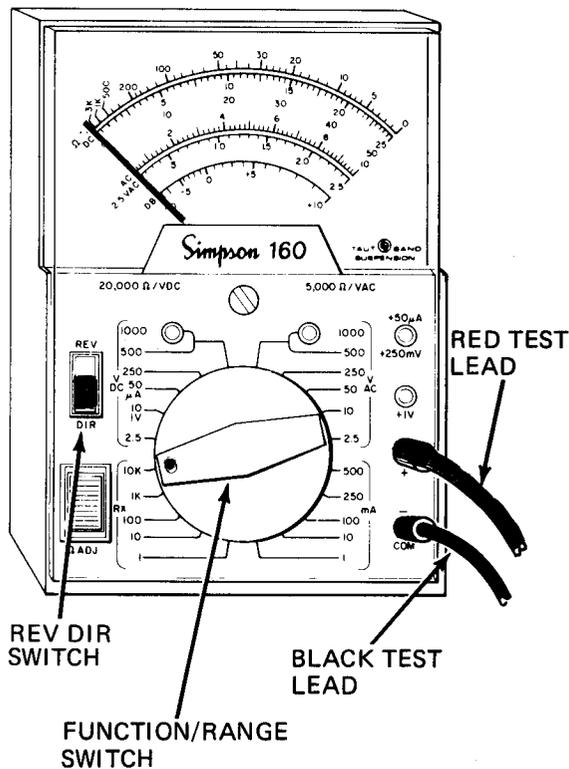

TA 114717

Figure 28-12 (Sheet 1 of 7)

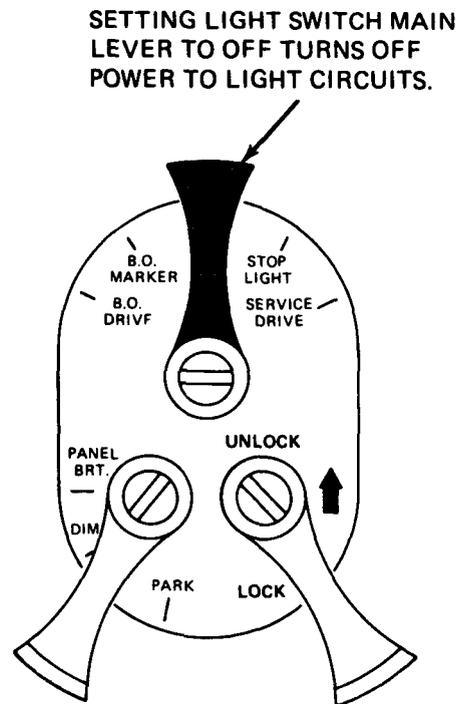
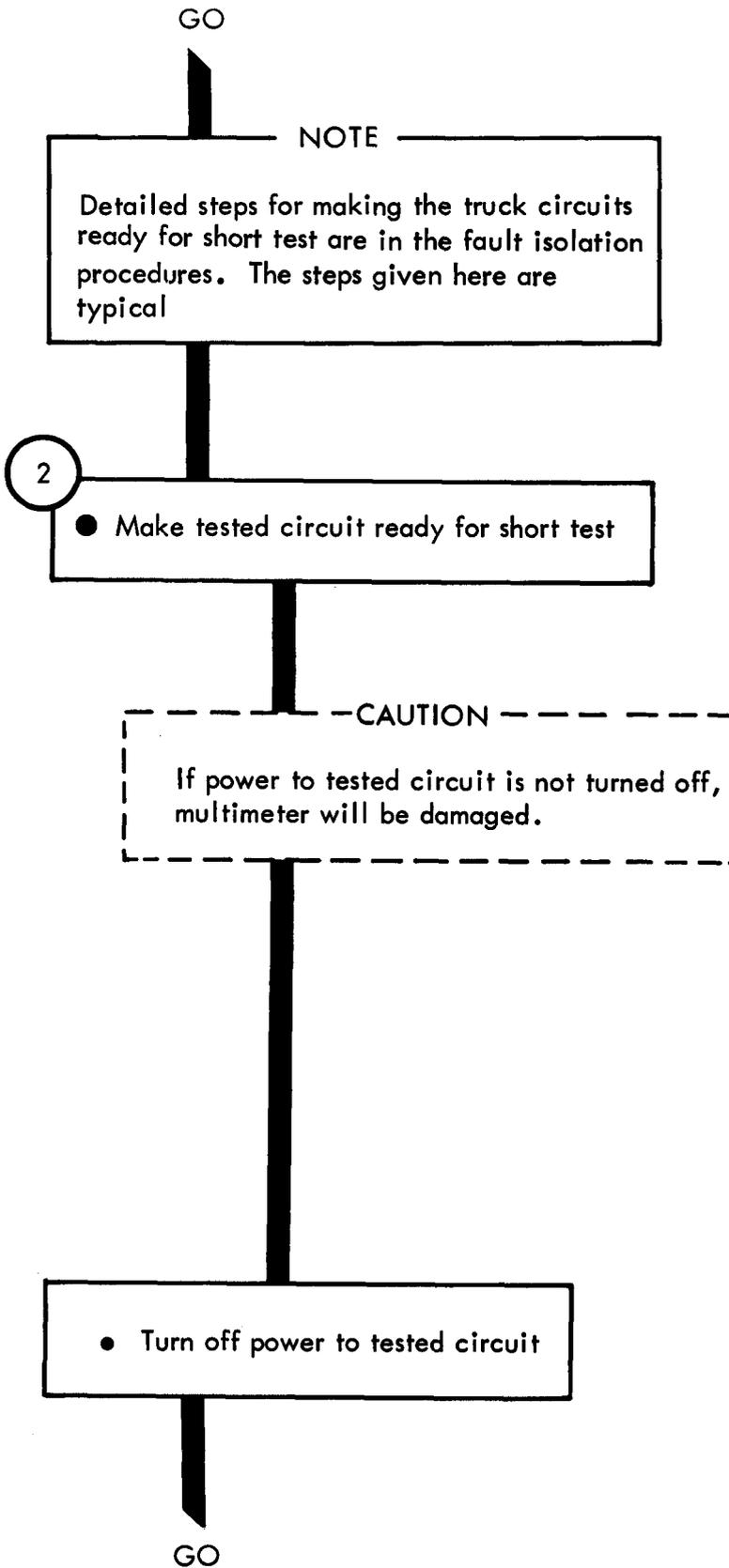

TA 114718

Figure 28-12 (Sheet 2 of 7)

GO

- Take plug on each end of trailer connecting cable off mating receptacle

3

- Zero the multimeter
- Touch multimeter test probes together

GO

TAKING CABLE PLUGS OFF MATING RECEPTACLES LETS YOU TEST CABLE WIRES FOR SHORTS

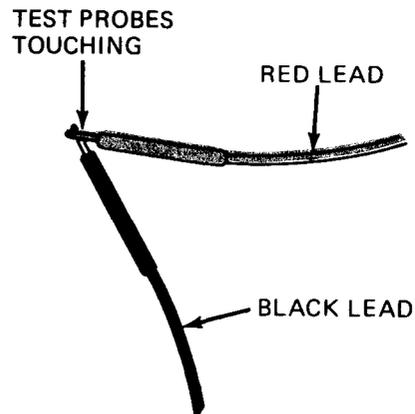
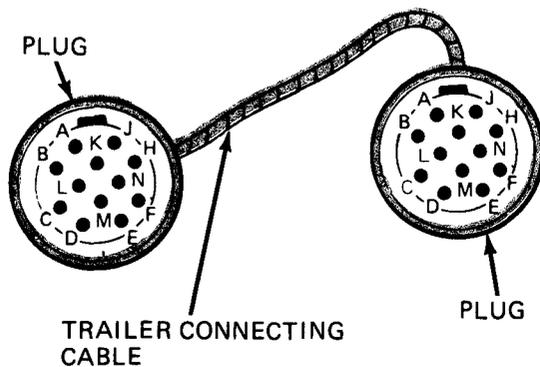

TA 114719

Figure 28-12 (Sheet 3 of 7)

GO

- While touching multimeter test probes together look at ohms scale. Pointer should be at 0 (zero). If it is not, turn Ω ADJ knob to move pointer to 0

GO

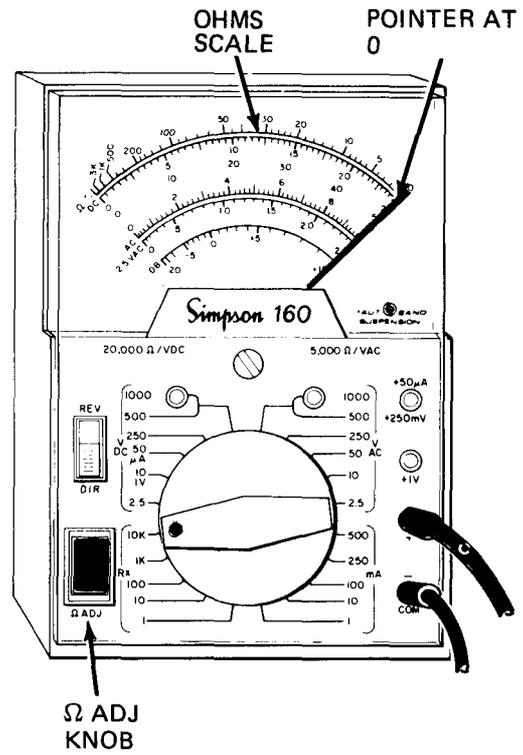

TA 114720

Figure 28-12 (Sheet 4 of 7)

GO

4

- Put multimeter leads across tested circuits
- To test for short between two circuits, put test probes on contacts of both circuits

GO

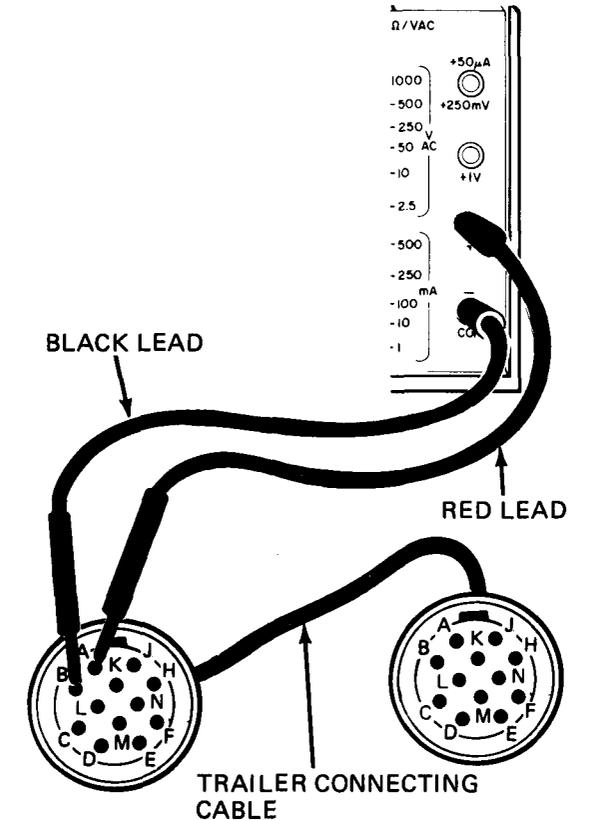

NOTE: MULTIMETER SHOWN CHECKING FOR SHORT BETWEEN TRAILER CONNECTOR CABLE WIRES ATTACHED TO CONTACTS A AND B.

GO

• To test for short between a circuit and ground, put one test probe on circuit contact and other test probe on ground

GO

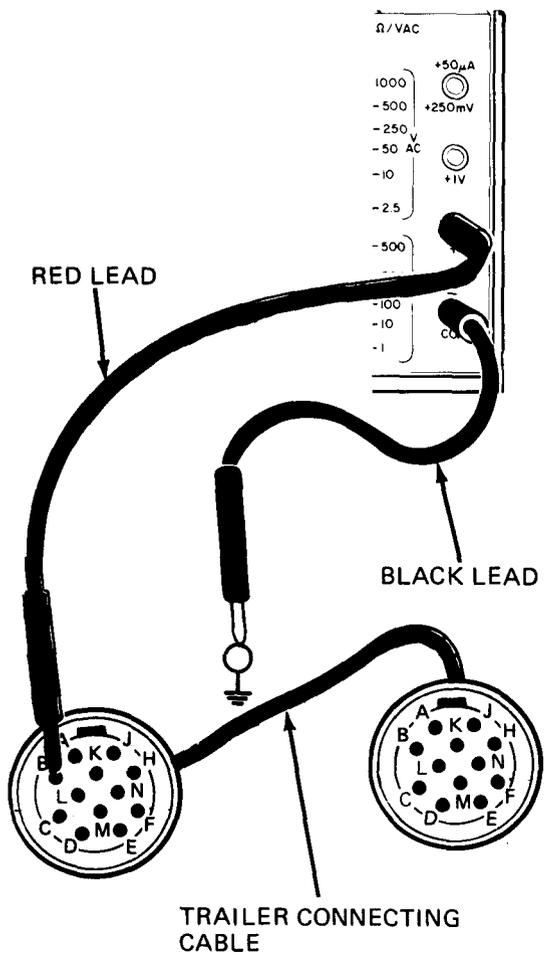

NOTE: MULTIMETER SHOWN CHECKING FOR SHORT BETWEEN TRAILER CONNECTOR CABLE WIRE ATTACHED TO CONTACT B AND GROUND.

Figure 28-12 (Sheet 6 of 7)

GO

5

- Read multimeter

- Look at multimeter ohms scale. If pointer stays all the way to far left without moving, circuits are not shorted
- If pointer moves all the way to far right over 0 (zero), circuits are shorted. If pointer jumps or flickers, circuits are sometimes shorted

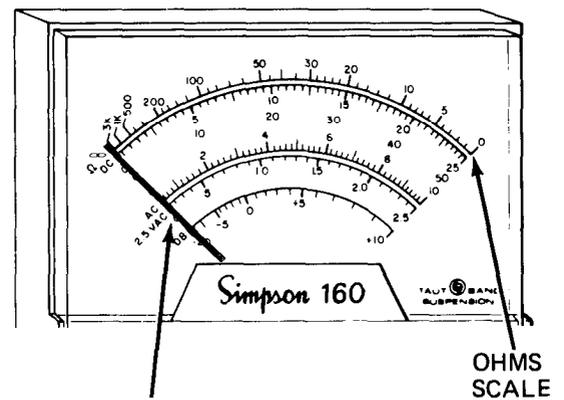

POINTER ALL THE WAY TO LEFT MEANS CIRCUITS ARE NOT SHORTED

OHMS SCALE

6

- Put tested circuit back in operation

- Take off both test prods from contacts of tested circuit and from ground
- Put back any plugs or other parts previously removed to test for shorts

MULTIMETER TS-352B/U TEST PROCEDURES

GENERAL INSTRUCTIONS

- Check that multimeter is ready to use
 - Calibration label - Check to be sure multimeter has been calibrated in the last 12 months.
 - Meter - Glass and pointer not broken. Pointer should be resting over zero mark at left side of scales.
 - Jack sockets - Open and dirt free
 - Batteries - Not corroded or leaking Put in right

- Cables - No cuts, sharp kinks or bad fraying.
- Jack plugs - Tight on cable, prods clean.
- Test prods - Tight on cable, tip free of paint or anything that might be an insulator.
- Switches - Work freely without binding or scraping.
- Alligator clips - free of paint or anything that might be an insulator

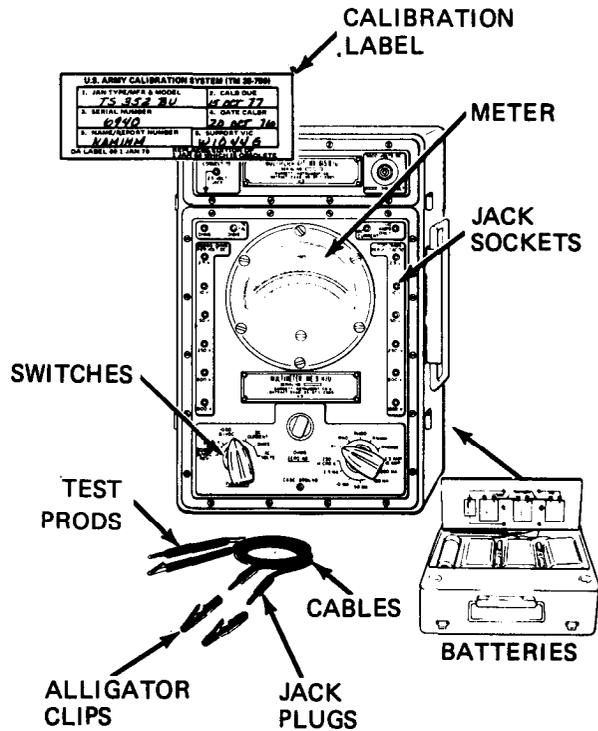

TA 114724

Figure 28-13

1 DC VOLTAGE TEST - To measure battery voltage, charging system output, and voltage drops at various test points

- 1
- Set up multimeter FUNCTION switch and black test lead
- Note: The range switch and OHMS ZERO ADJ knob are not used for DC voltage tests.
- Set FUNCTION switch to 1000 Ω / VDC.
 - Put jack plug of black (-) test lead into -DC \pm AC OHMS jack

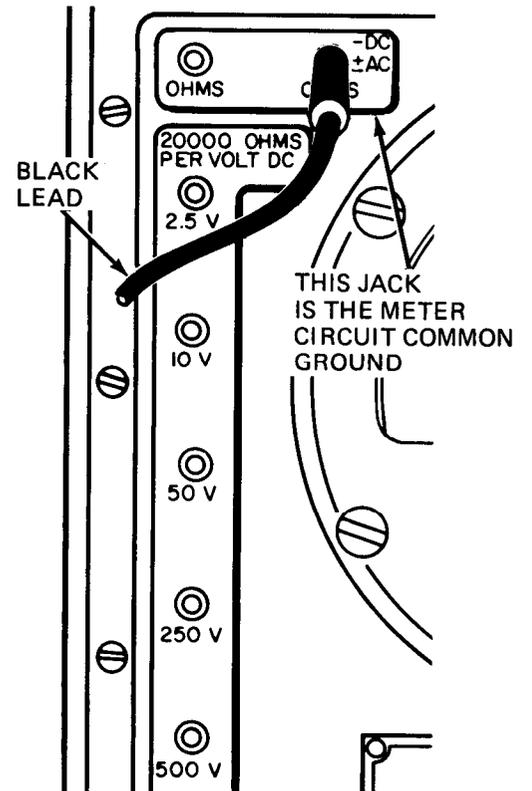
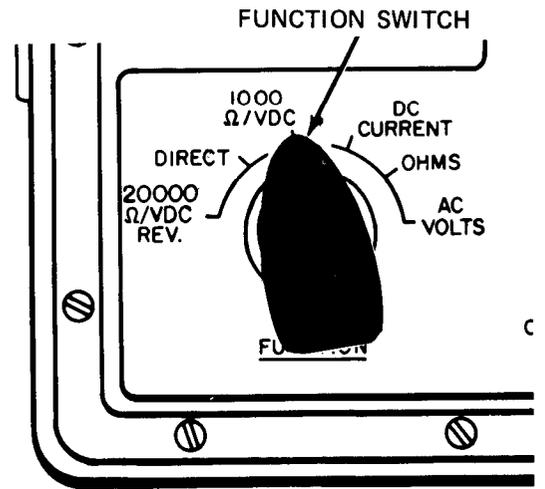

GO

GO

2

● Set up red test lead

Note: The highest truck DC voltage that is measured is about 28 volts. Therefore, the multimeter red (+) lead is never put into the 250V, 500V, and 1000V jacks

- See table to find out which jack to put red (+) lead into. Table shows which jack to use when normal value of measured voltage is known or unknown.

THE JACK USED IS ALWAYS MARKED HIGHER THAN THE VOLTAGE YOU WANT TO MEASURE

IF NORMAL VALUE OF VOLTAGE BEING MEASURED IS THIS:	PUT RED LEAD INTO THIS JACK ON RIGHT SIDE OF MULTIMETER:
0 TO 2 VOLTS	2.5V
2 TO 8 VOLTS	10V
8 TO 40 VOLTS	50V
UNKNOWN	50V

- Put jack plug of red (+) test lead into jack you picked on right side of multimeter. The jacks are in the 1000 OHMS PER VOLT AC DC column of multimeter

RED (+) TEST LEAD MAY BE PUT INTO ONE OF THESE THREE JACKS

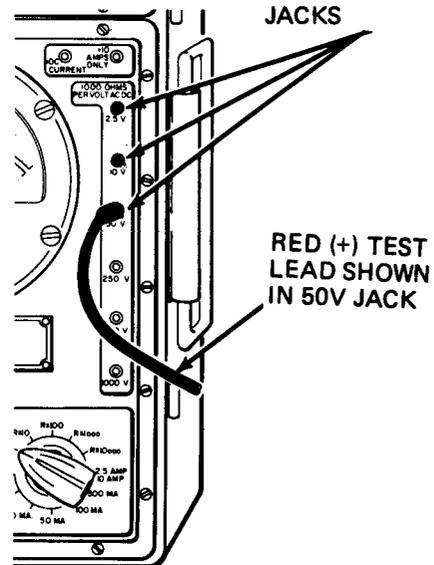

NOTE

When you need to turn on power before measuring DC voltage, the fault isolation procedure gives the turn-on instructions.

GO

TA 114726

Figure 28-14 (Sheet 2 of 9)

GO

3

- Put multimeter leads across (in parallel with) circuit being measured
- Put test prod of black lead (-) on negative terminal of circuit being measured
- Put test prod of red lead (+) on positive terminal of circuit being measured.

NOTE: MULTIMETER SHOWN MEASURING +24 VOLTS DC BATTERY VOLTAGE.

BLACK LEAD

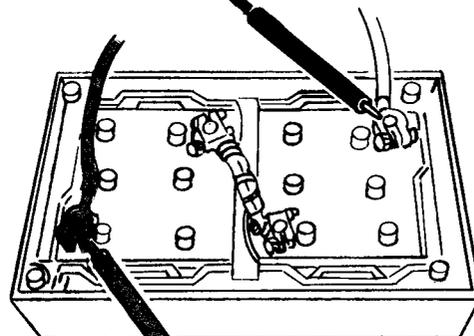
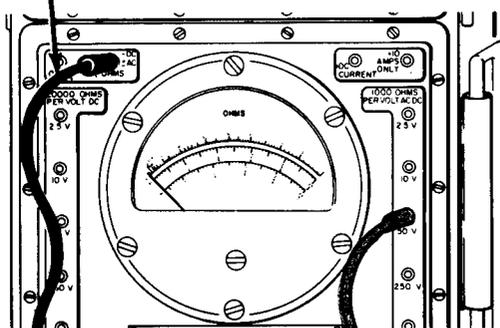

4

- If multimeter red test lead is on 50V jack, read multimeter as follows
- Use 5DC scale. Full scale voltage is 50 volts DC

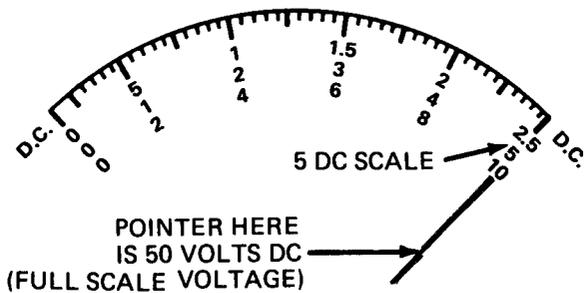

GO

TA 114727

Figure 28-14 (Sheet 3 of 9)

GO

● Read each numbered line as shown

● Each space between lines equals 1 volt

GO

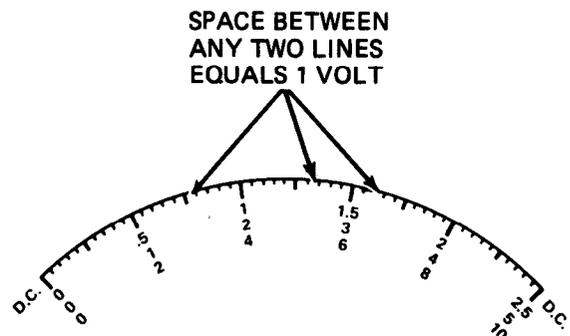
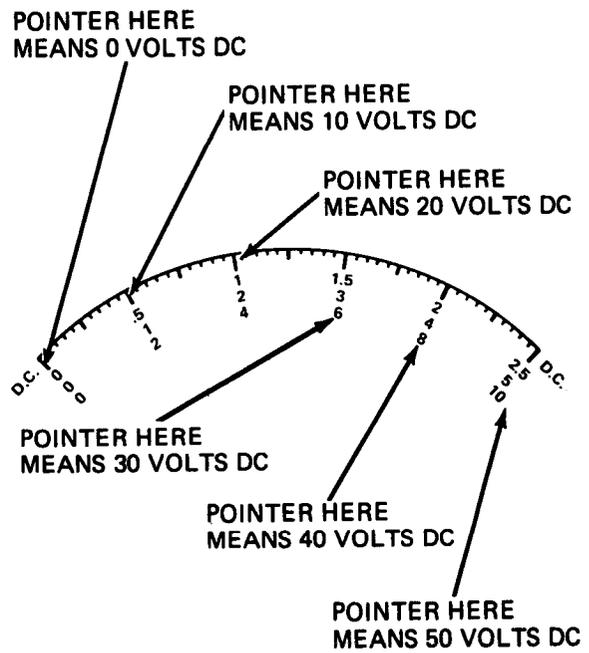

TA 114728

Figure 28-14 (Sheet 4 of 9)

GO

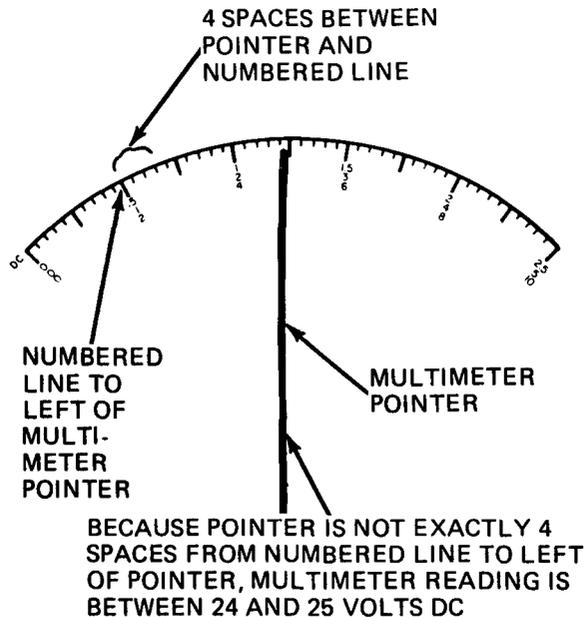

- Get multimeter reading as follows

Step A	Step B	Step C
Read first numbered line to left of pointer. Multiply number by 10.	Count number of spaces between pointer and first numbered line to left of pointer.	Add the numbers from steps A and B.
Example: $2 \times 10 = 20 +$	4	$= 24$ volts DC

5

- If multimeter red test lead is in 10 V jack, read multimeter as follows
 - Use 10 DC scale. Full scale voltage is 10 volts DC

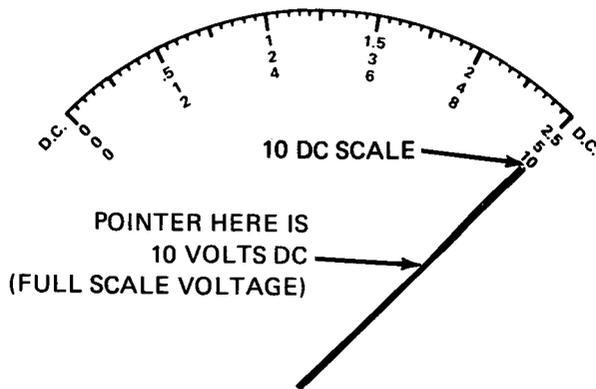

GO

Figure 28-14 (Sheet 5 of 9)

GO

● Read each numbered line as shown

● Each space between lines equals 0.2 volt

GO

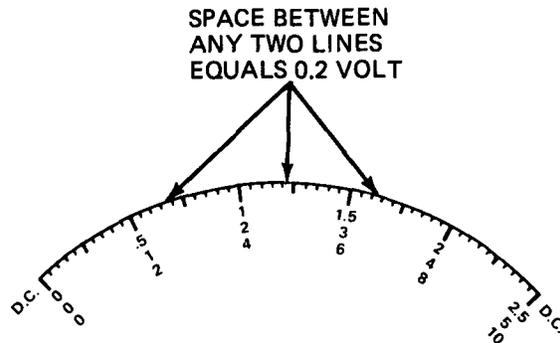
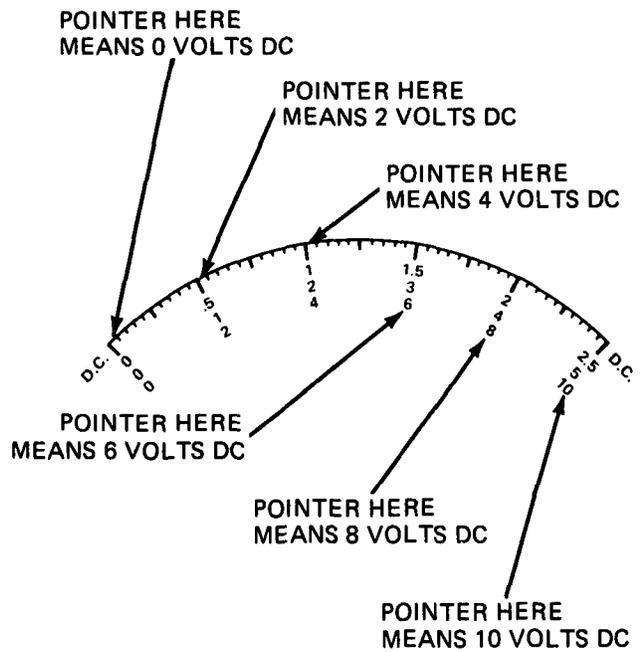

TA 114730

Figure 28-14 (Sheet 6 of 9)

GO

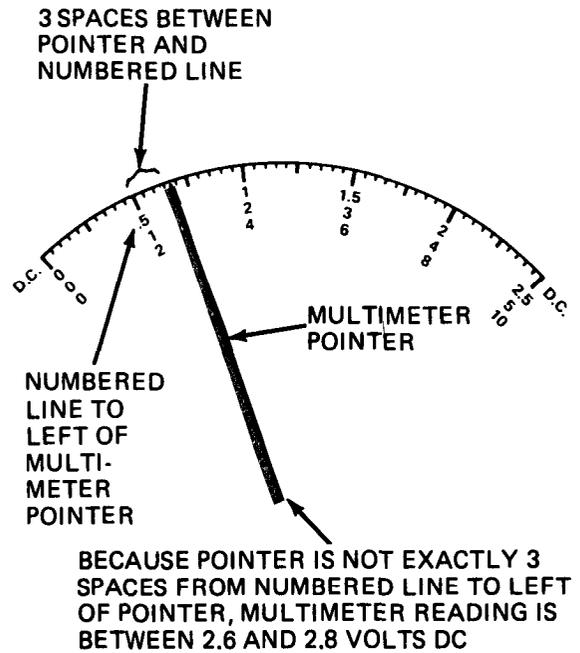

- Get multimeter reading as follows:

Step A

Read first numbered line to left of pointer.

Step B

Count number of spaces between pointer and first numbered line to left of pointer. Multiply number of spaces by 0.2.

Step C

Add the numbers from steps A and B.

Example 2 + $0.2 \times 3 = 0.6$ = 2.6volts DC

6

- If multimeter red test lead is in 50V jack, read multimeter as follows:
 - Use 5 DC scale. Full scale voltage is 50 volts DC

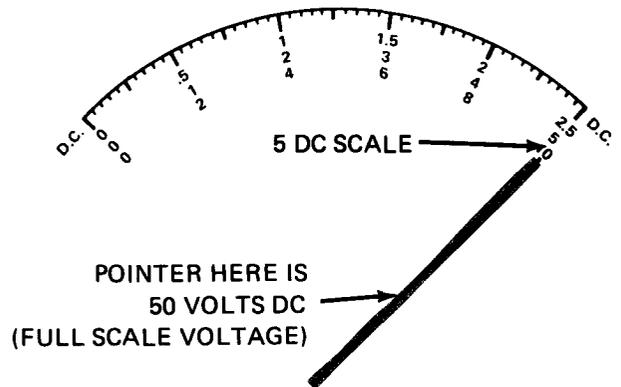

GO

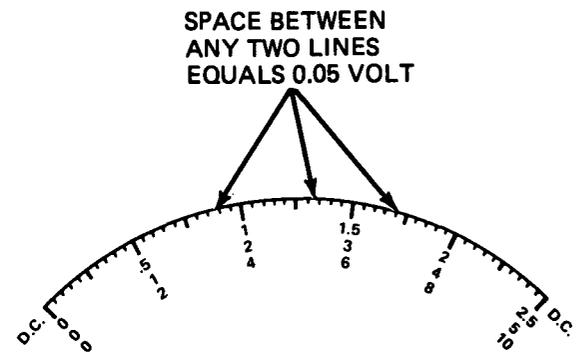
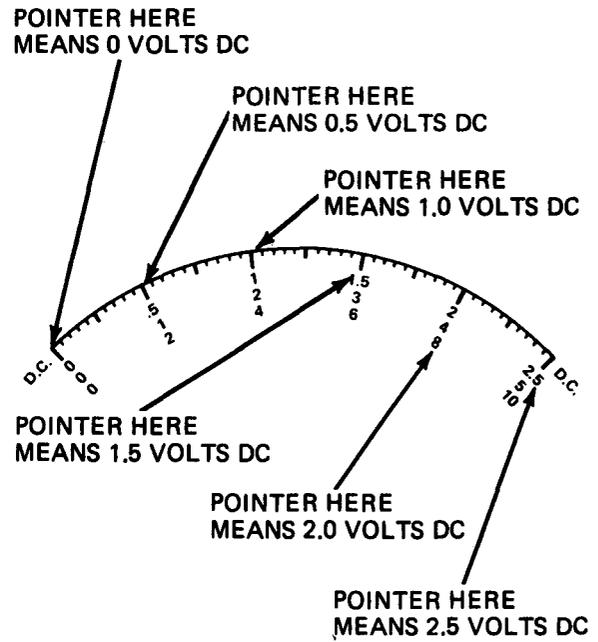
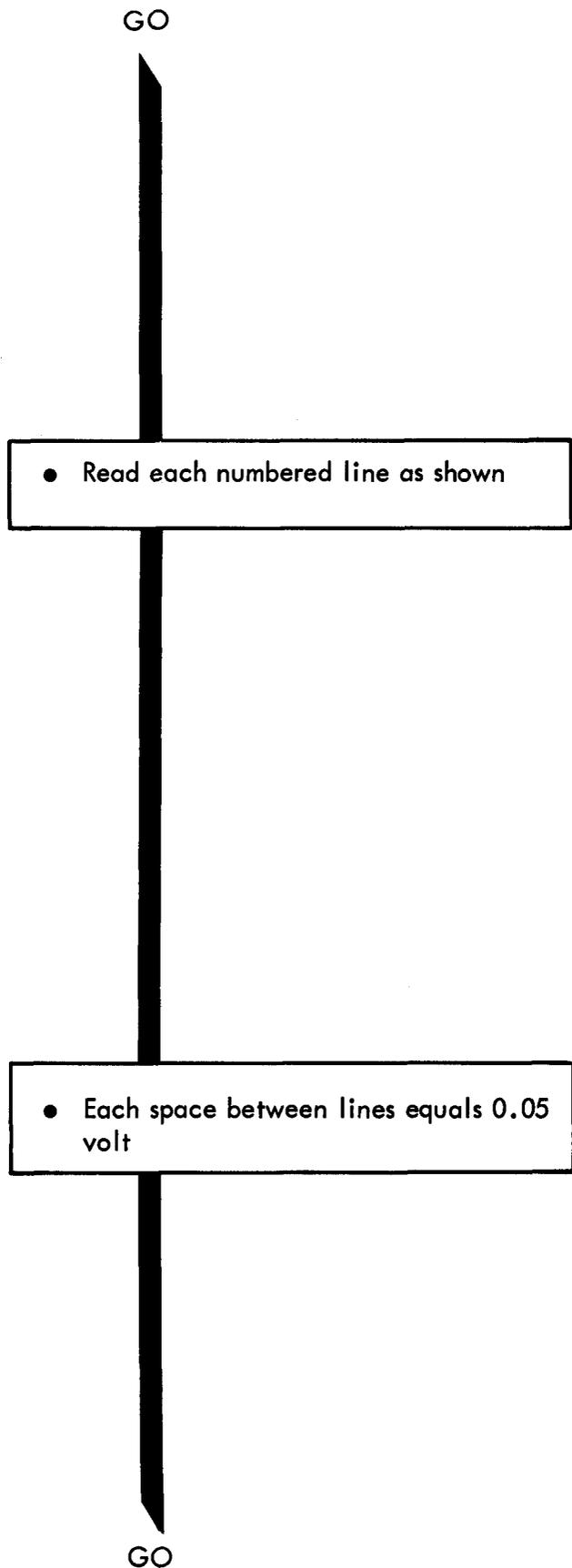
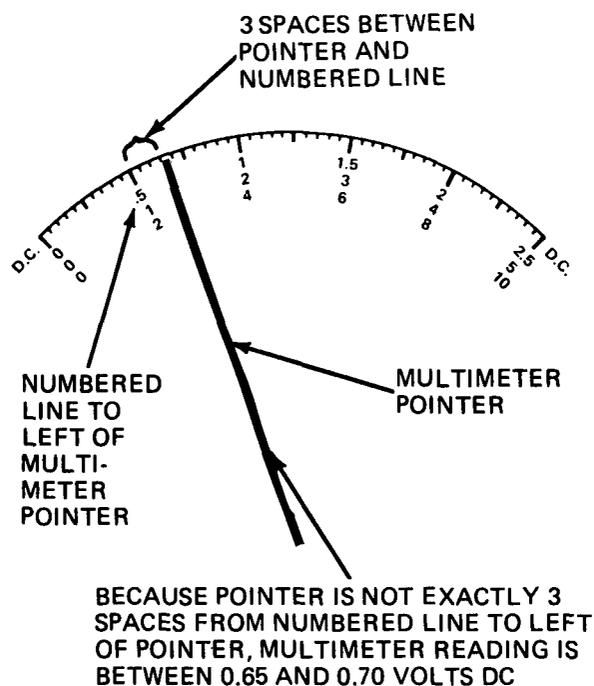

Figure 28-14 (Sheet 6 of 9)

GO



- Get multimeter reading as follows:

Step A	Step B	Step C
Read first numbered line to left of pointer.	Count number of spaces between pointer and first numbered line to left of pointer. Multiply number of spaces by 0.05.	Add the numbers from steps A and B.
Example: 0.5	+ 0.05 × 3 = 0.15	= 0.65 volts DC

7

- Make circuit normal again
- Take both test prods off measured circuit

2 AC VOLTAGE TEST - To measure van input and operating voltages

- 1
- Set up multimeter as follows
 - Note: The range switch and OHMS ZERO ADJ knob are not used for AC voltage tests
 - Set FUNCTION switch to AC VOLTS

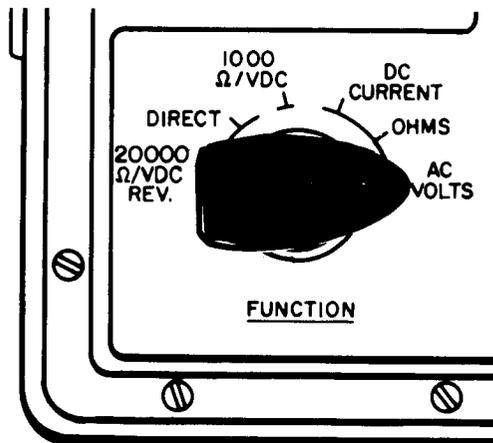

- Put jack plug of black test lead into -DC ±AC OHMS jack

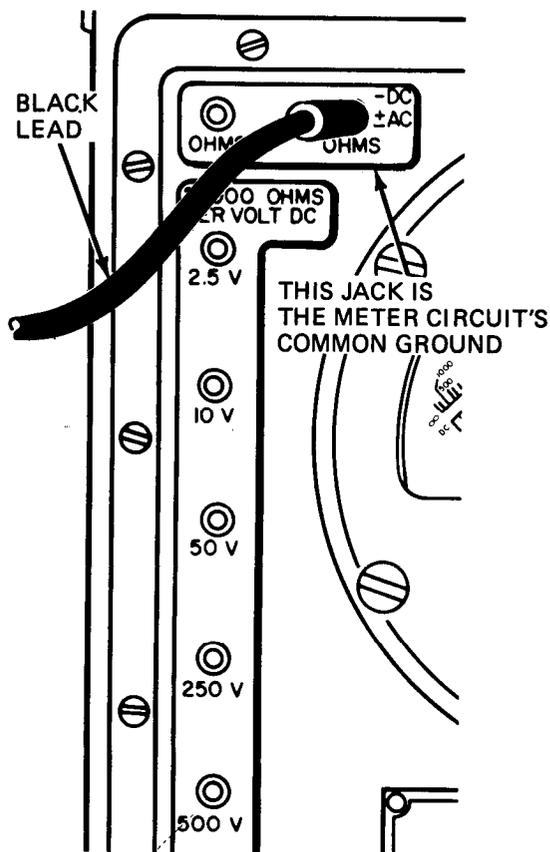

GO

TA 114734

Figure 28-15 (Sheet 1 of 5)

- Put jack plug of red test lead into 250 V jack on right side of multimeter. The jack is in the 1000 OHMS PER VOLT AC DC column

Note: The truck AC voltages measured are 208 and 120 volts. Therefore, the multimeter red lead is never put into the 2.5 V, 10 V, 50 V, 500 V, and 1000 V jacks

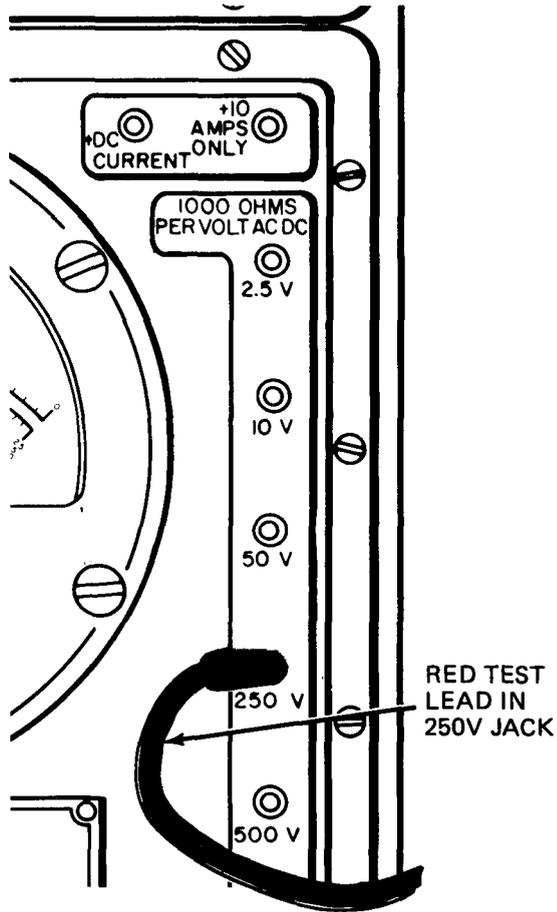

NOTE

When you need to turn on power before measuring AC voltage, the fault isolation procedure gives the turn-on instructions.

GO

Figure 28-15 (Sheet 2 of 5)

GO

2

- Put multimeter leads across (in parallel with) circuit being measured

Note: In AC voltage measurement you can hook up the test lead connections to the circuit either way. You will still get correct multimeter readings and no damage will be done to the multimeter. But, when one side of the circuit is electrical ground, it is a good idea to put the black lead on electrical ground

- Put test prod of black lead on ground side or one side of circuit being measured. Put test prod of red lead on other side of circuit being measured

NOTE: MULTIMETER SHOWN MEASURING 120 VOLTS AC VAN CEILING LIGHT VOLTAGE.

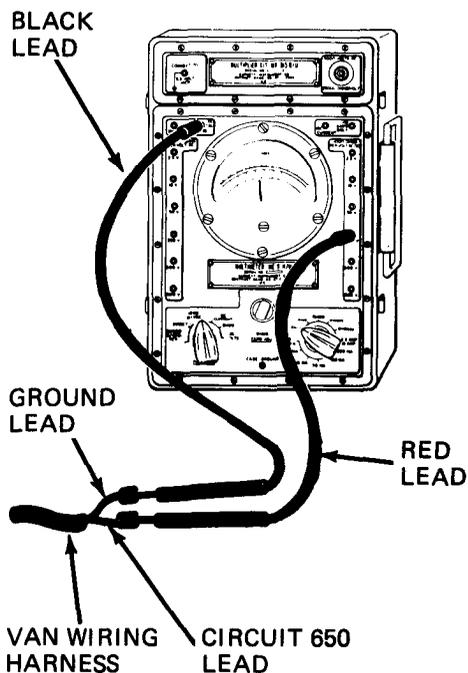

3

- Read multimeter
 - Use 2.5 AC scale. Full scale voltage is 250 volts AC

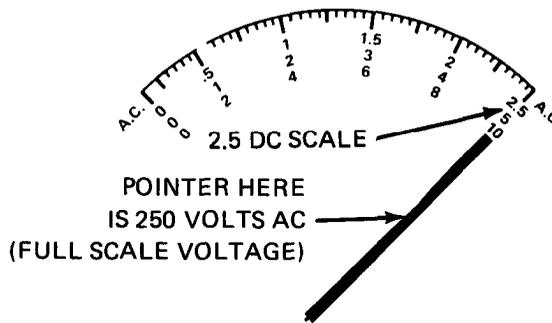

GO

TA 114736

Figure 28-15 (Sheet 3 of 5)

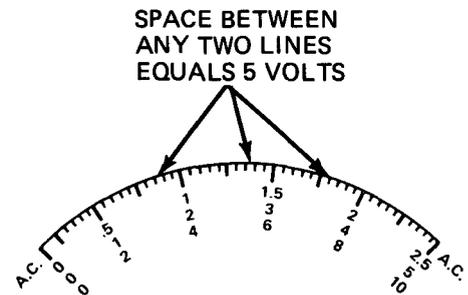
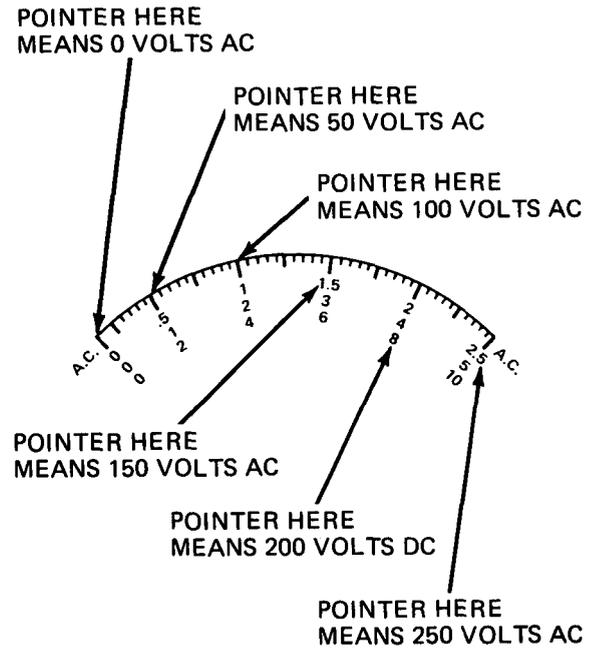
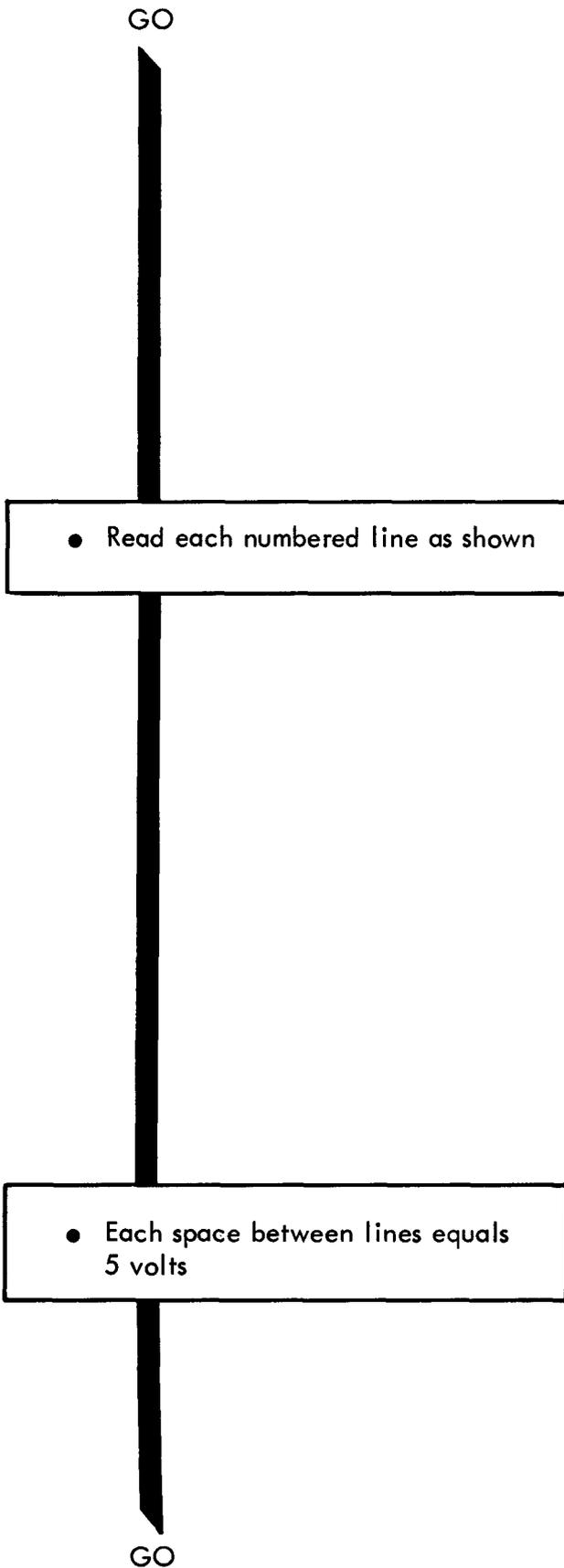
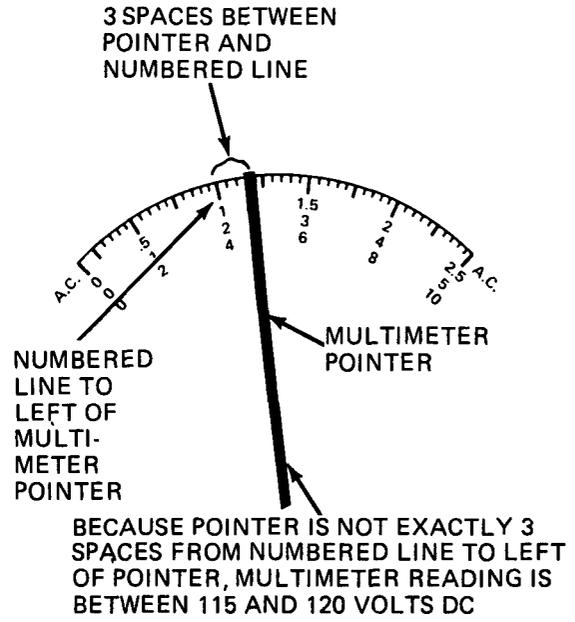

Figure 28-15 (Sheet 4 of 5)

TA 114737

GO



- Get multimeter reading as follows:

Step A

Read first numbered line to left of pointer. Multiply number by 100.

Step B

Count number of spaces between pointer and first numbered line to left of pointer. Multiply number of spaces by 5.

Step C

Add the numbers from steps A and B.

Example: $1 \times 100 = 100 + 5 \times 3 = 15 = 115 \text{ volts AC}$

4

- Make circuit normal again
 - Take both test prods off measured circuit

Figure 28-15 (Sheet 5 of 5)

3 RESISTANCE TEST - To measure resistance of cold start resistors, temperature sending unit, and blower motor resistor

- 1
- Set up multimeter
 - Set FUNCTION switch to OHMS

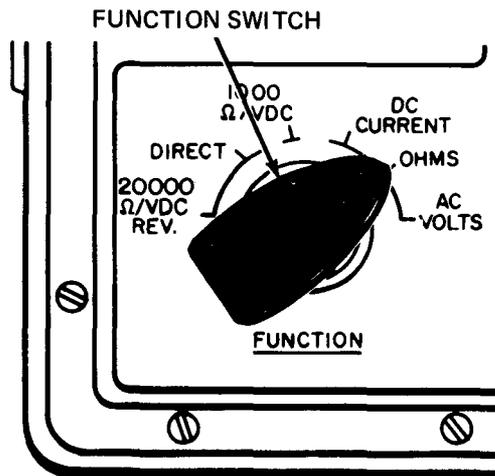

- Set range switch to RX10000

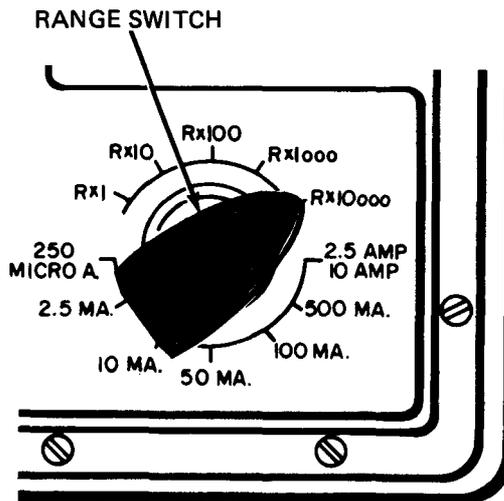

GO

TA 114739

Figure 28-16 (Sheet 1 of 10)

GO

- Put jack plug of black (-) test lead into -DC ±AC OHMS jack
- Put jack plug of red (+) test lead into OHMS jack .

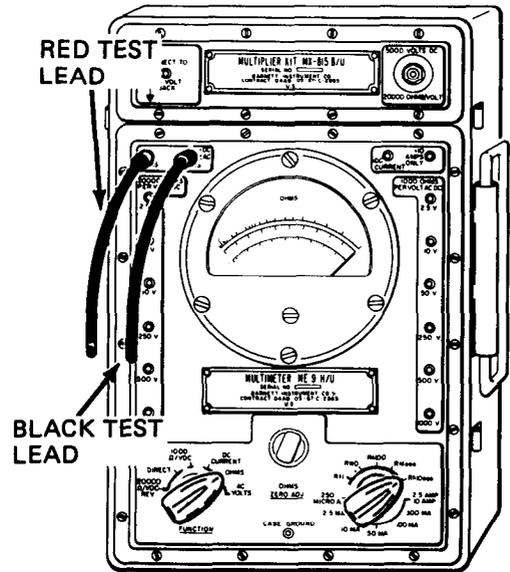

NOTE

Detailed steps for making the truck parts ready for resistance test are in the fault isolation procedures. The steps given here are typical

2

- Make tested part ready for resistance test

CAUTION

If power to tested part is not turned off, multimeter will be damaged

GO

TA 114740

Figure 28-16 (Sheet 2 of 10)

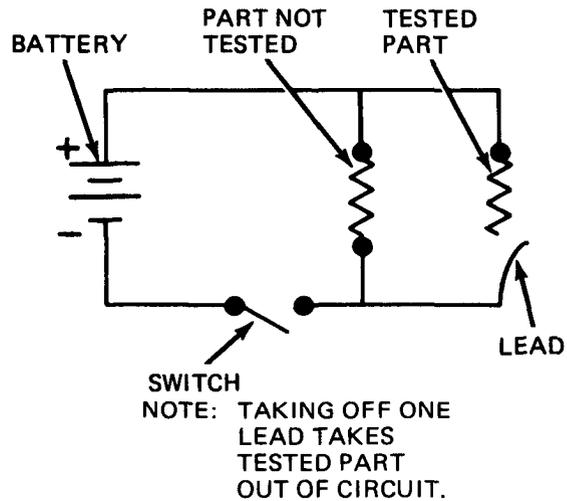
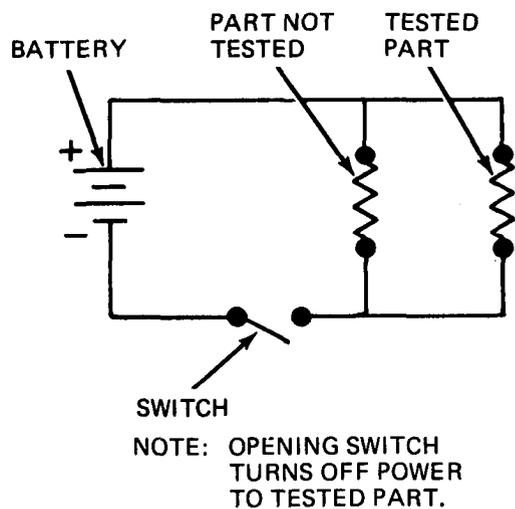
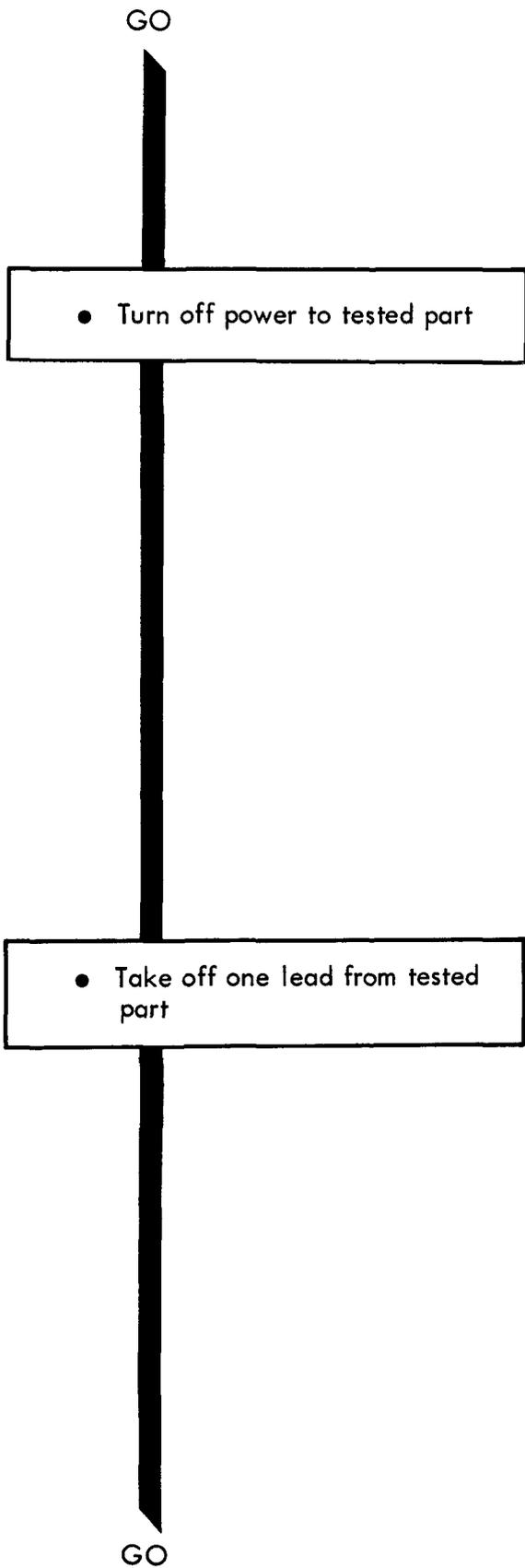

TA 114741

Figure 28-16 (Sheet 3 of 10)

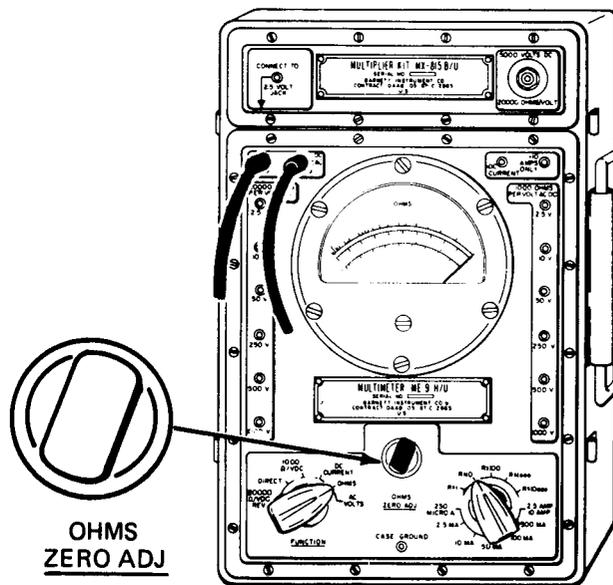
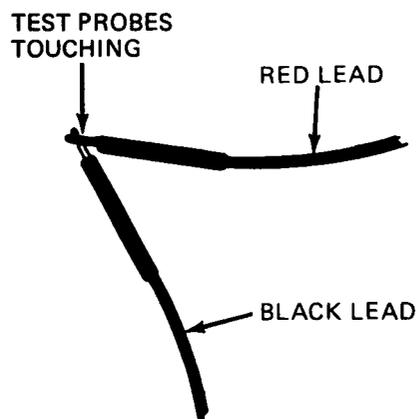
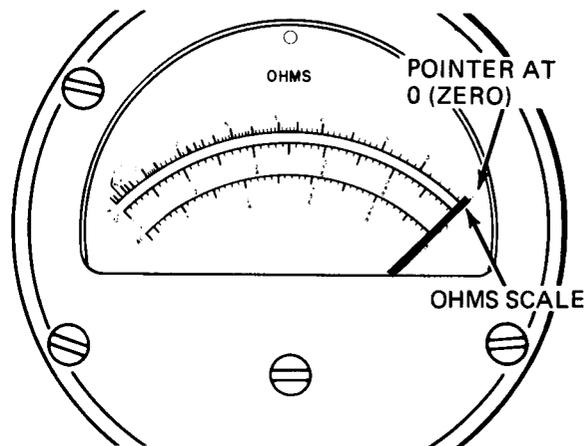
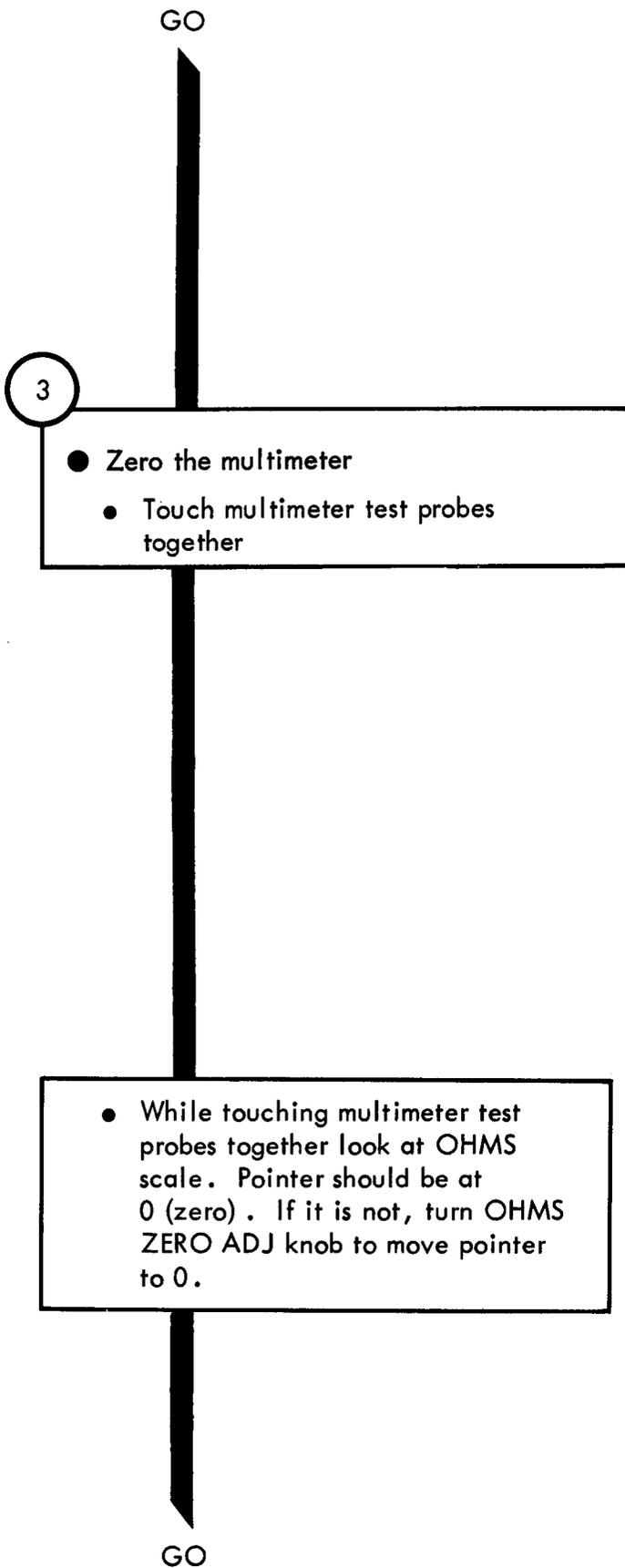

TA 114742

Figure 28-16 (Sheet 4 of 10)

GO

4

- Put multimeter leads across tested part
- Put one test prod on one terminal of tested part
- Put other test prod on other terminal of tested part

NOTE

Zero the multimeter each time you turn the range switch knob to another position. (See step 3)

5

- Get the most accurate multimeter reading as follows
- Note: The closer the multimeter pointer is to the center of the OHMS scale, the more accurate the reading
- Note position of pointer on OHMS scale. Turn range switch knob to left while looking at pointer. Try to find range switch knob position that gives most centered pointer position

GO

NOTE: MULTIMETER SHOWN MEASURING RESISTANCE OF A COLD START RESISTOR

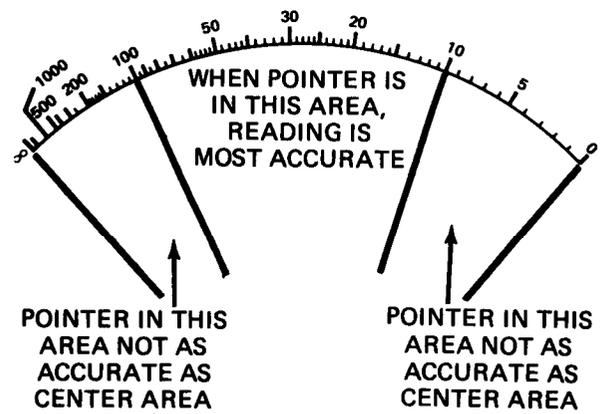
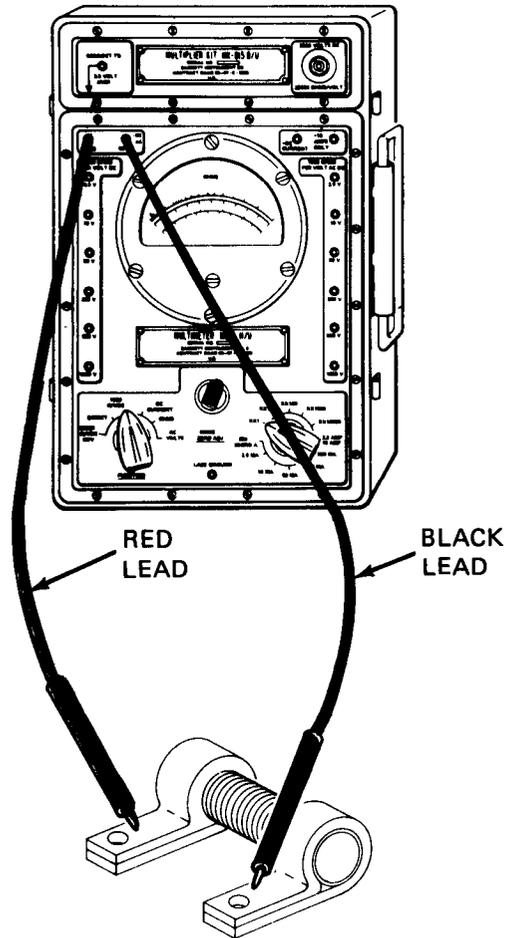

TA 114743

Figure 28-16 (Sheet 5 of 10)

GO

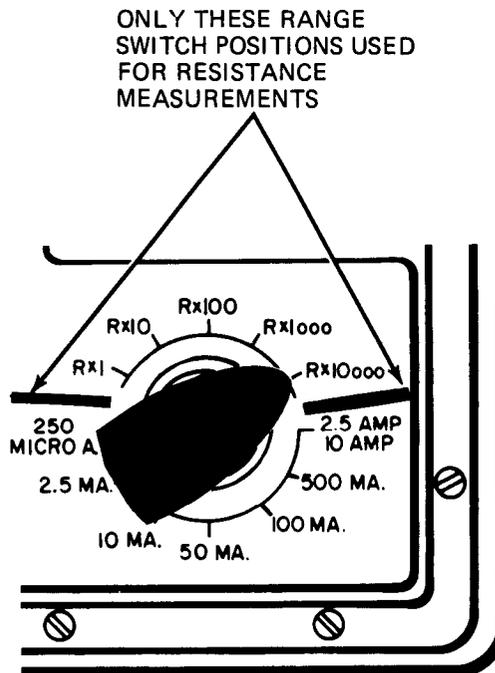

NOTE: MOVING RANGE SWITCH KNOB TO LEFT MOVES POINTER TO LEFT.

- You may overshoot most centered pointer position. If you do, turn range switch knob to right to put pointer in most centered position

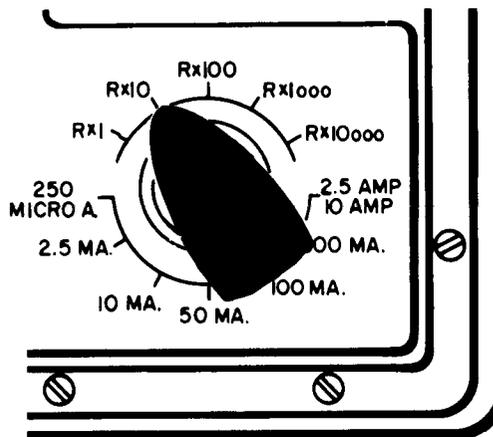

NOTE: MOVING RANGE SWITCH KNOB TO RIGHT MOVES POINTER TO RIGHT.

GO

TA 114744

Figure 28-16 (Sheet 6 of 10)

GO

- Pointer will stay in right area if resistance is less than 10 ohms. Pointer will stay in left area if resistance is more than 1,000,000 ohms
- Leave range switch in position that puts pointer in most centered position

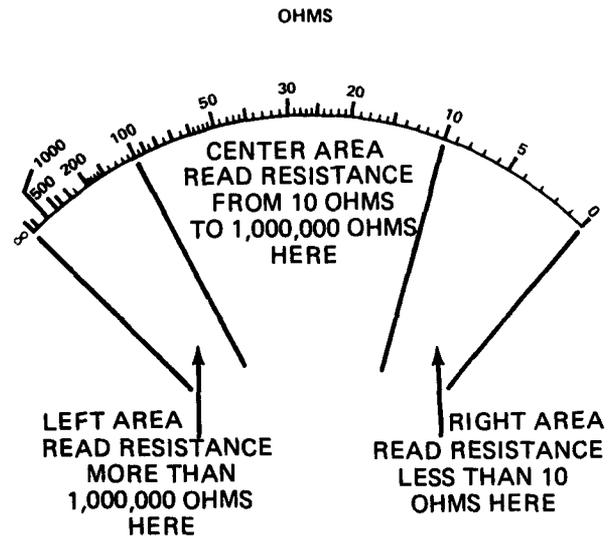

6

- If pointer falls exactly on a numbered line read multimeter as follows:
 - Look at OHMS scale and see which numbered line pointer is on: 50

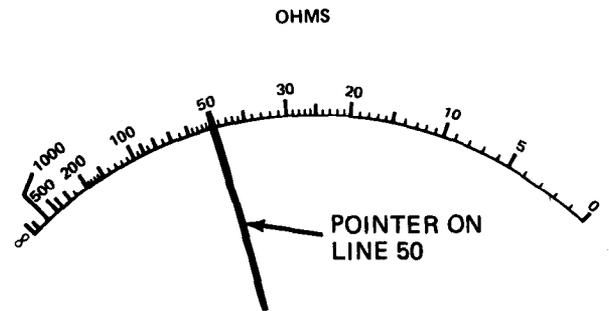

- See what range switch position number is: 10
- Multiply number from step a by number from step b to get multimeter reading:
 $50 \times 10 = 500 \text{ Ohms}$

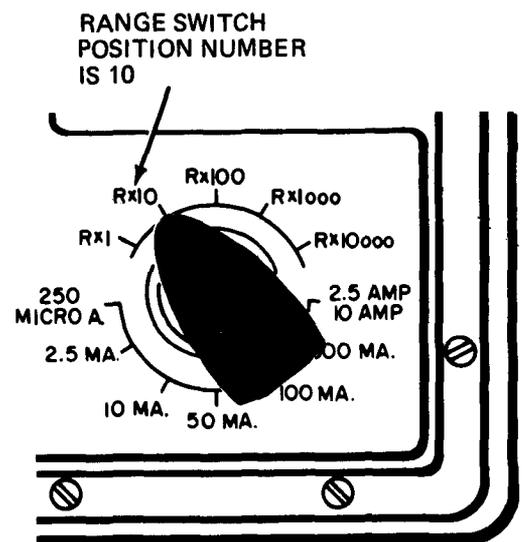
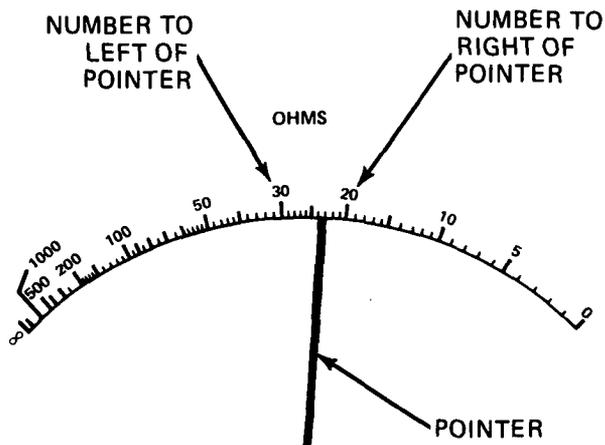

Figure 28-16 (Sheet 7 of 10)

GO

7

- If pointer falls between numbered lines read multimeter as follows
 - a. Look at OHMS scale and note the numbers to left and right of pointer: 30 and 20
 - b. Subtract lower number from higher number:
 $30 - 20 = 10$



- c. Count number of graduations from lower number to higher number. (If pointer is to left of number 50, count only the longer graduations): 10

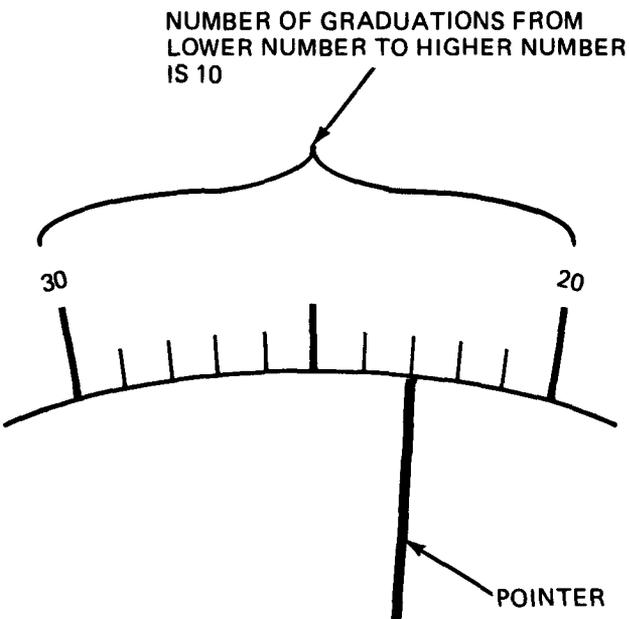

GO

TA 114746

Figure 28-16 (Sheet 8 of 10)

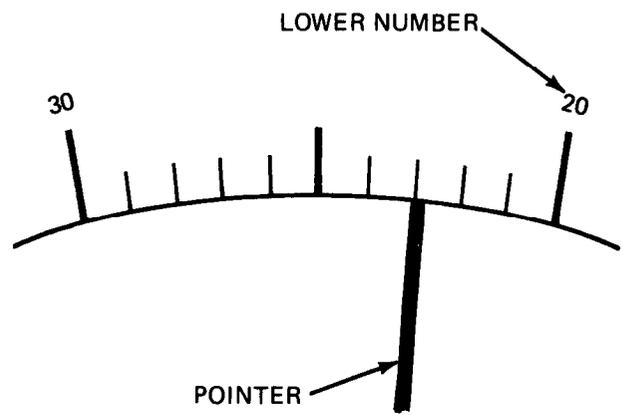
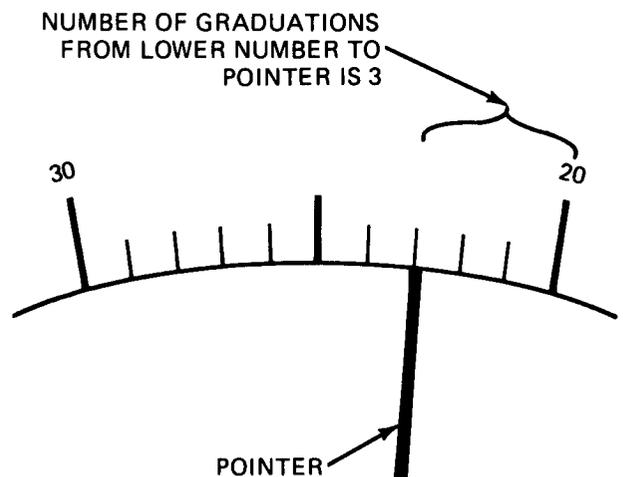
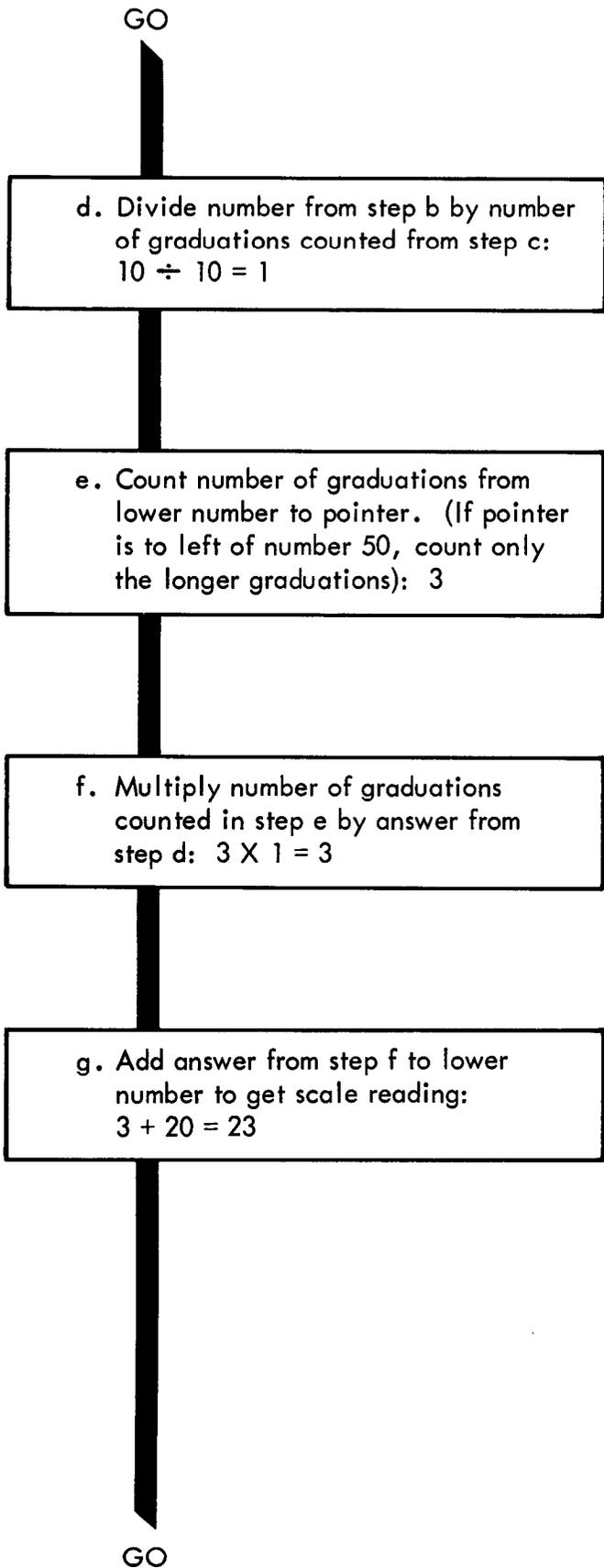
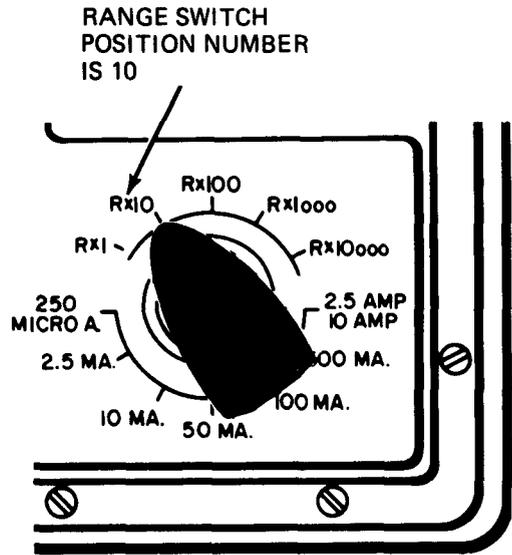

Figure 28-16 (Sheet 9 of 10)

GO

h. Multiply scale reading (step g) by range switch position number to get multimeter reading:
 $23 \times 10 = 230$ ohms



8

- Put tested part back in circuit:
 - Take off both test prods from across tested part
 - Put lead back on tested part

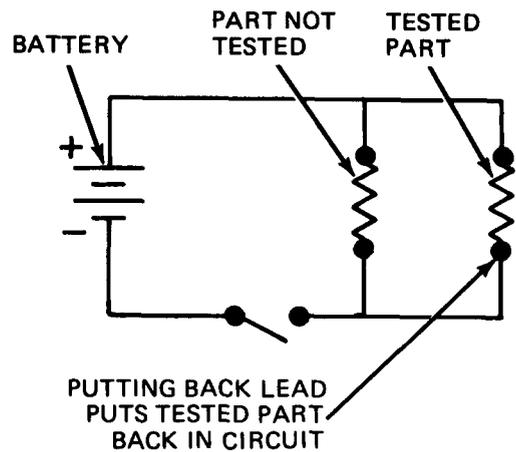

TA 114748

Figure 28-16 (Sheet 10 of 10)

Test

4

CONTINUITY TEST - To check for breaks in a circuit, such as switch, lamp or electrical cable circuits

1

- Set up multimeter
- Set FUNCTION switch to OHMS

- Set range switch to RX1.

GO

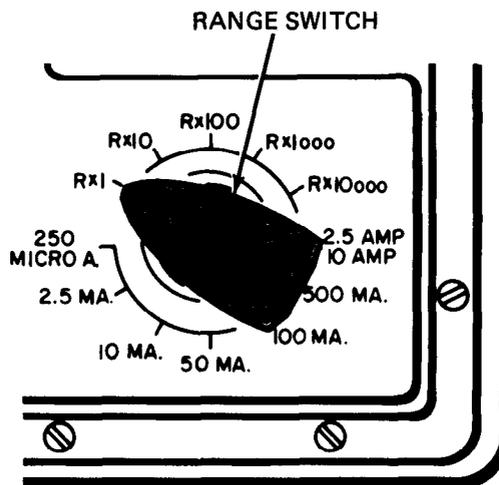
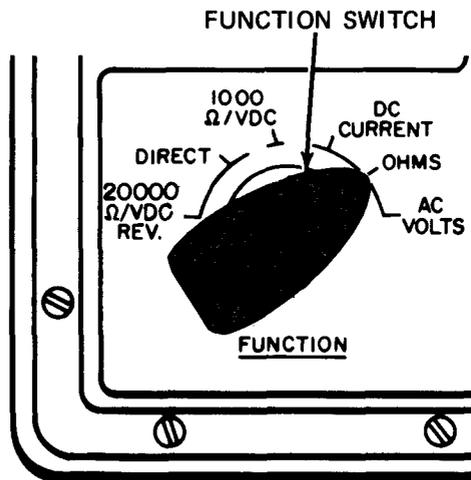

GO

- Put jack plug of black (-) test lead into -DC ±AC OHMS jack
- Put jack plug of red (+) test lead into OHMS jack

NOTE

Detailed steps for making the truck circuits ready for continuity tests are in the fault isolation procedures. The steps given here are typical.

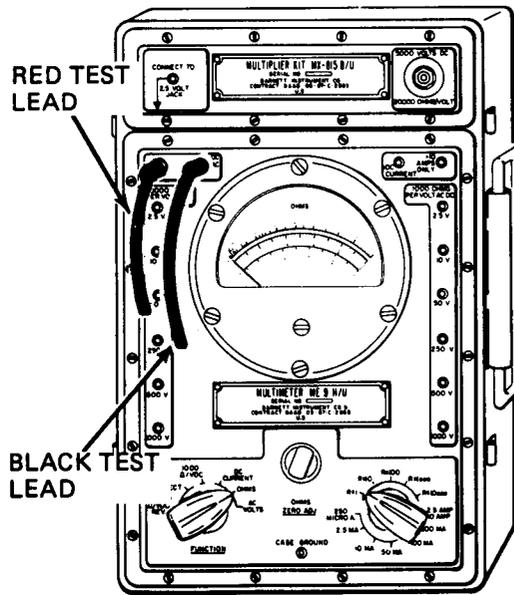

2

- Make tested circuit ready for continuity test

CAUTION

If power to tested circuit is not turned off, multimeter will be damaged.

- Turn off power to tested circuit

GO

SETTING LIGHT SWITCH MAIN LEVER TO OFF TURNS OFF POWER TO LIGHT CIRCUITS.

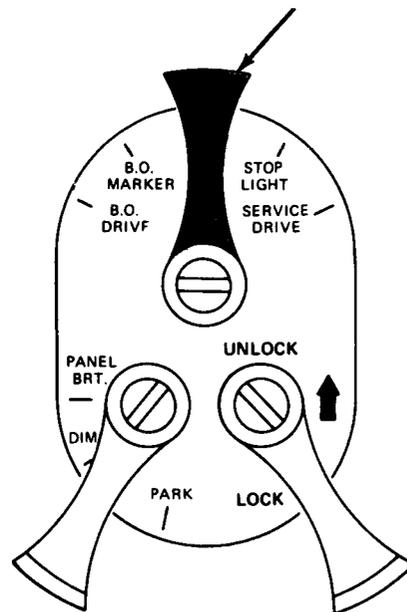

TA 114750

Figure 28-17 (Sheet 2 of 6)

GO

- Take plug on each end of trailer connecting cable off mating receptacle.

3

- Zero the multimeter
- Touch multimeter test probes together

GO

TAKING CABLE PLUGS OFF MATING RECEPTACLES LETS YOU TEST CONTINUITY OF CABLE WIRES

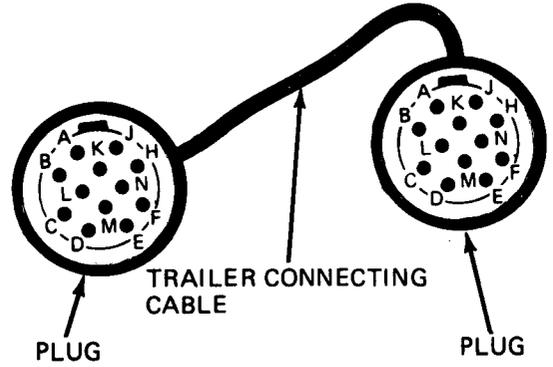

TEST PROBES TOUCHING

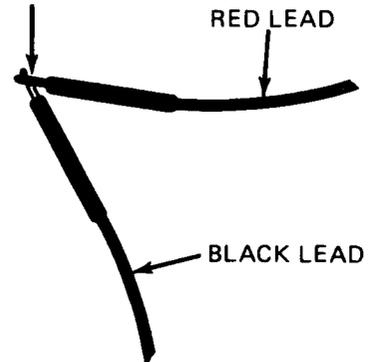

GO

- While touching multimeter test probes together look at OHMS scale. Pointer should be at 0 (zero). If it is not, turn OHMS ZERO ADJ knob to move pointer to 0

GO

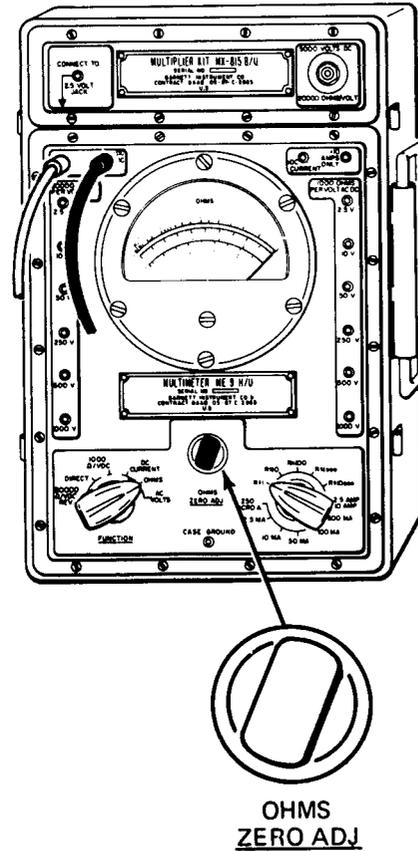
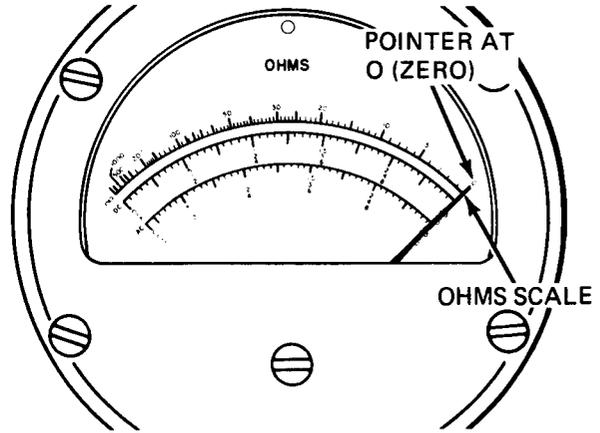

TA 114752

Figure 28-17 (Sheet 4 of 6)

GO

4

- Put multimeter leads across tested circuit
- Put test prod of black lead (-) on one contact of tested circuit
- Put test prod of red lead (+) on other contact of tested circuit

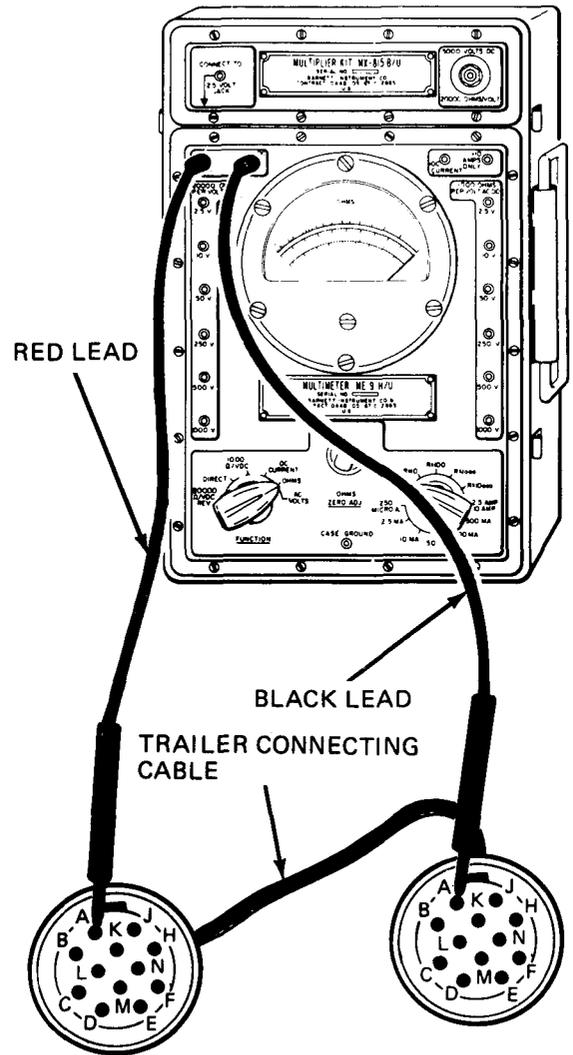

NOTE: MULTIMETER SHOWN CHECKING CONTINUITY OF TRAILER CONNECTING CABLE WIRE ATTACHED TO CONTACT A.

GO

Figure 28-17 (Sheet 5 of 6)

GO

5

- Read multimeter
 - Look at multimeter OHMS scale. For continuity, pointer should be all the way to far right over 0 (zero)
 - If pointer stays all the way to left, tested circuit is open. If pointer jumps or flickers, tested circuit has a loose connection

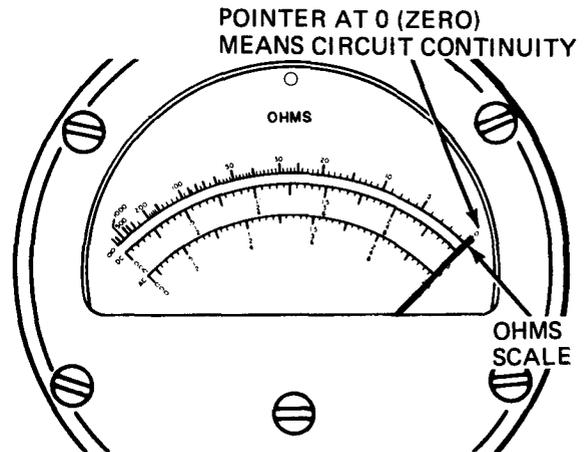

6

- Put tested circuit back in operation
 - Take off both test prods from contacts of tested circuit
 - Put back any plugs or other parts previously removed to test continuity

Figure 28-17 (Sheet 6 of 6)

5 SHORT TEST - To check for shorts in electrical cables

NOTE

A short (or short circuit) happens when two circuits that should not be connected have metal-to-metal contact with each other. A short also happens when a circuit that should not touch electrical ground has metal-to-metal contact with ground

1

- Set up multimeter
 - Set FUNCTION switch to OHMS

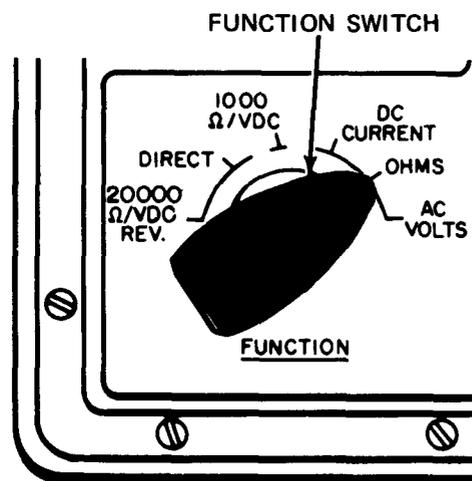

GO

TA 114754

Figure 28-18 (Sheet 1 of 8)

GO

• Set range switch to RX10000

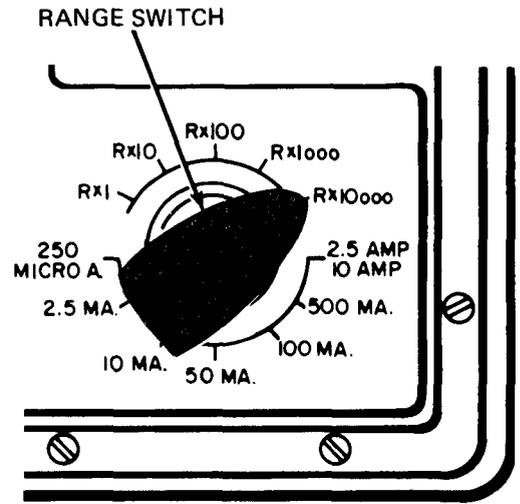

• Put jack plug of black (-) test lead into -DC ±AC OHMS jack .
 • Put jack plug of red (+) test lead into OHMS jack

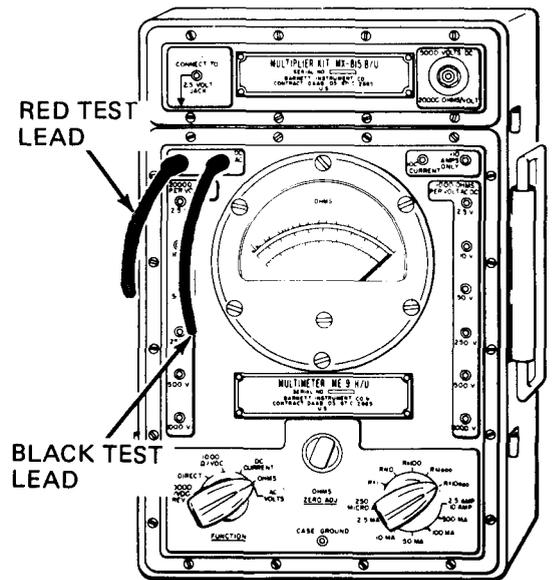

GO

TA 114755

Figure 28-18 (Sheet 2 of 8)

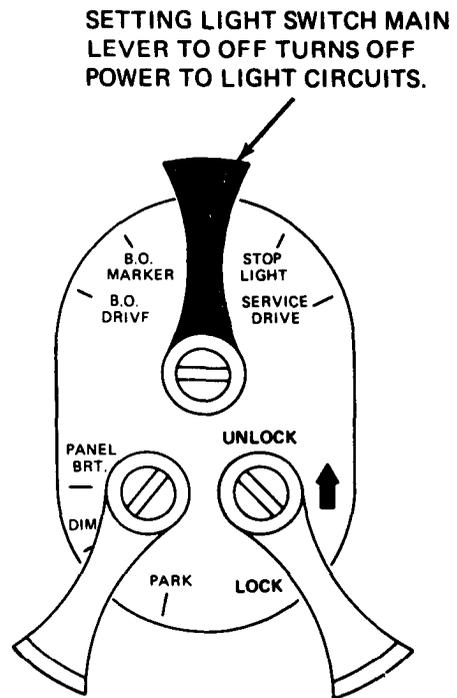
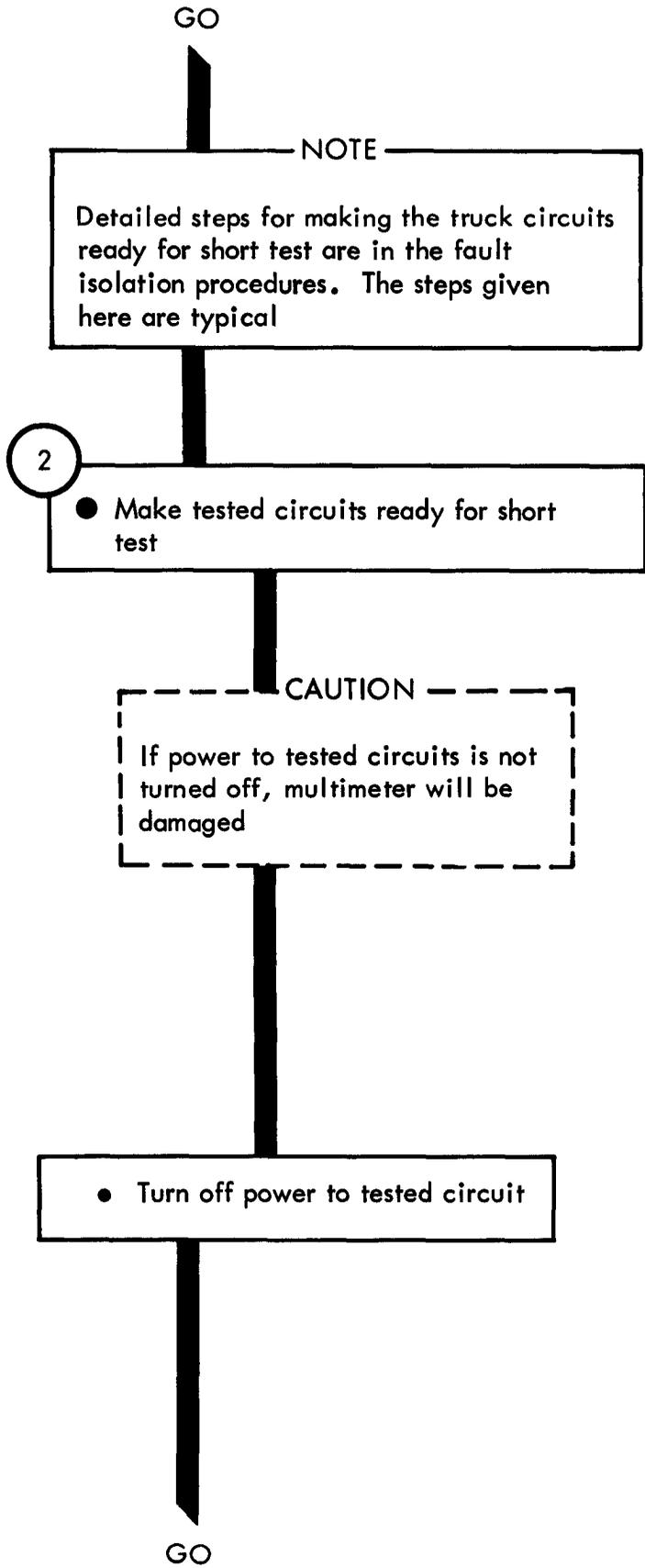

TA 114756

Figure 28-18 (Sheet 3 of 8)

GO

- Take plug on each end of trailer connecting cable off mating receptacle

3

- Zero the multimeter:
 - Touch multimeter test probes together

GO

TAKING CABLE PLUGS OFF MATING RECEPTACLES LETS YOU TEST CABLE WIRES FOR SHORTS

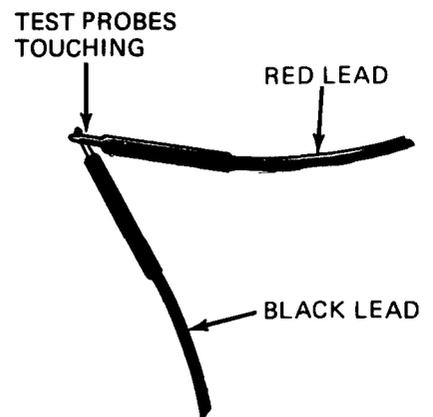
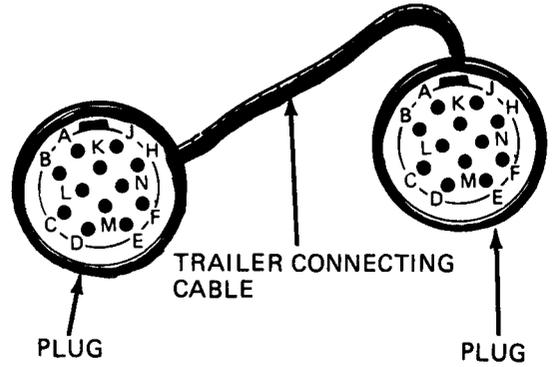
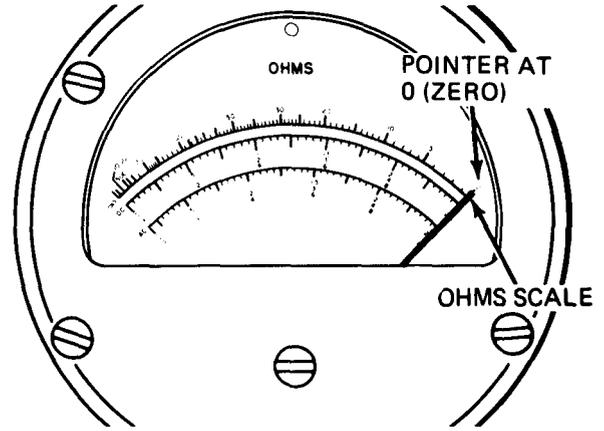
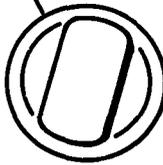
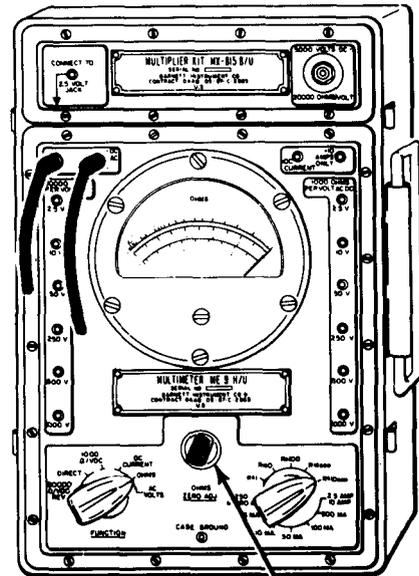

Figure 28-18 (Sheet 4 of 8)

GO



- While touching multimeter test probes together look at OHMS scale. Pointer should be at 0 (zero). If it is not, turn OHMS ZERO ADJ knob to move pointer to 0



OHMS ZERO ADJ

GO

TA 114758

Figure 28-18 (Sheet 5 of 8)

GO

4

- Put multimeter leads across tested circuits
- To test for short between two circuits, put test probes on contacts of both circuits

GO

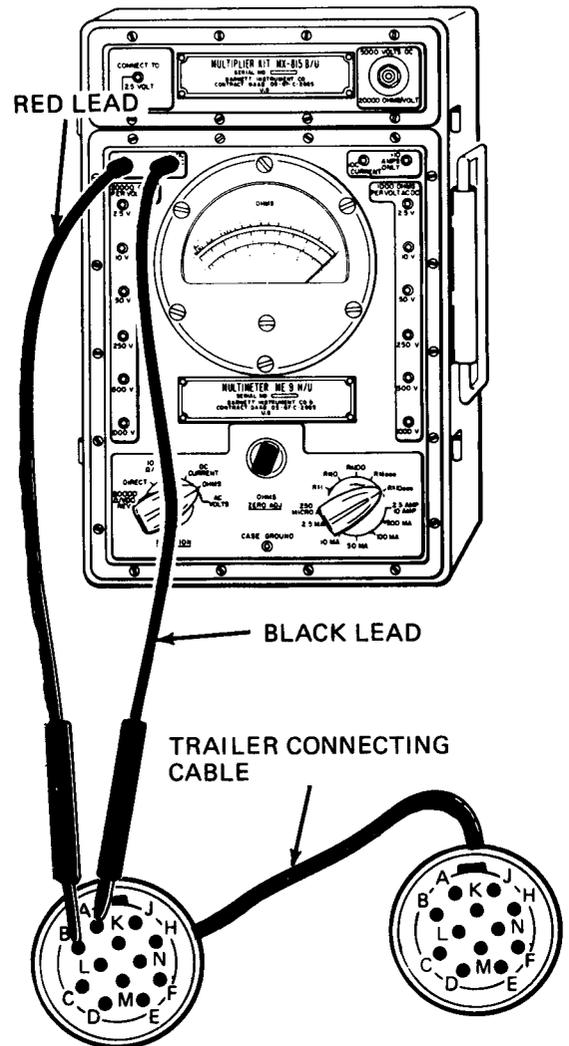

NOTE: MULTIMETER SHOWN CHECKING FOR SHORT BETWEEN TRAILER CONNECTOR CABLE WIRES ATTACHED TO CONTACTS A AND B.

GO

- To test for short between a circuit and ground, put one test probe on circuit contact and other test probe on ground

GO

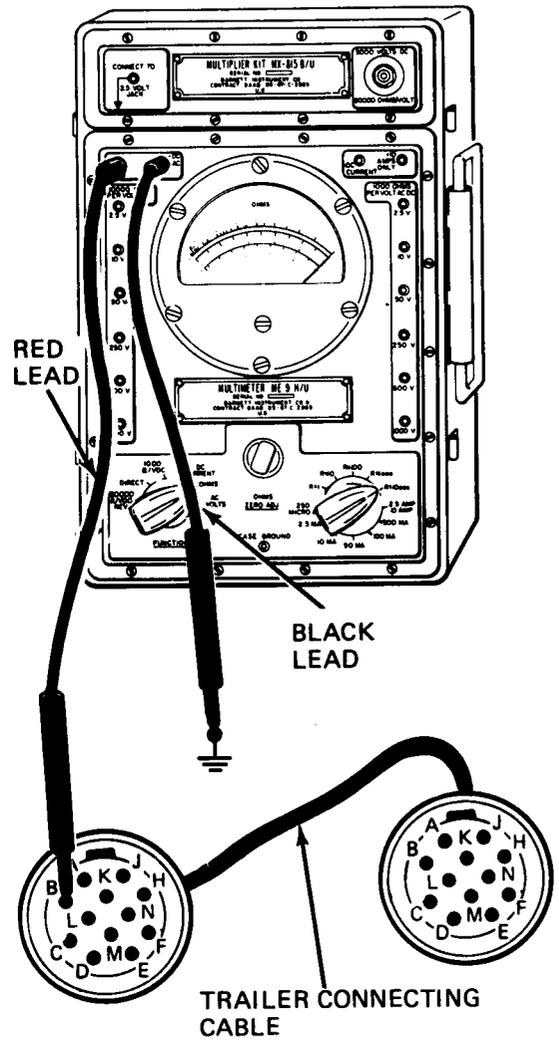

NOTE: MULTIMETER SHOWN CHECKING FOR SHORT BETWEEN TRAILER CONNECTOR CABLE WIRE ATTACHED TO CONTACT B AND GROUND.

GO

5

- Read multimeter
 - Look at multimeter OHMS scale. If pointer stays all the way to far left without moving, circuits are not shorted
 - If pointer moves all the way to far right over 0 (zero), circuits are shorted. If pointer jumps or flickers, circuits are sometimes shorted

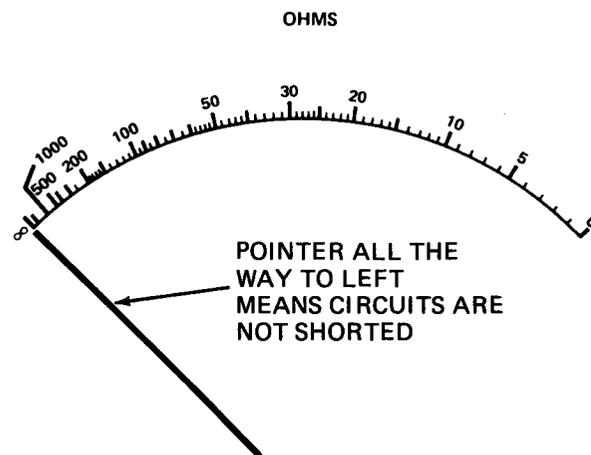

6

- Put tested circuit back in operation
 - Take off both test prods from contacts of tested circuit and from ground
 - Put back any plugs or other parts previously removed to test for shorts

Figure 28-18 (Sheet 8 of 8)

CHAPTER 29

OPERATING AND PRELIMINARY PROCEDURES

29-1. EQUIPMENT ITEMS COVERED. This chapter gives equipment operating and preliminary procedures for the system, for which there are authorized corrective maintenance tasks at the organizational maintenance level.

29-2. EQUIPMENT ITEMS NOT COVERED. All equipment items for which corrective maintenance is authorized at the organizational maintenance level are covered in this chapter.

GENERAL INFORMATION

NOTE

When making light switch main lever selections from OFF to any ON position except B. O. MARKER, unlock switch must be lifted to UNLOCK position

To activate brake lights (service or blackout) air pressure in system must be up

The condition of the batteries should always be checked before troubleshooting any system in the truck

The truck has two 12 volt DC batteries connected in series, to furnish 24 volts DC to the electrical system which uses a negative (-) ground and positive (+) power feed to the electrical components

To test the condition of batteries, set BATTERY SWITCH to ON. (Do not start engine)

The battery indicator should be in position as shown in view A

Start engine and run at 1200 RPM. See view B

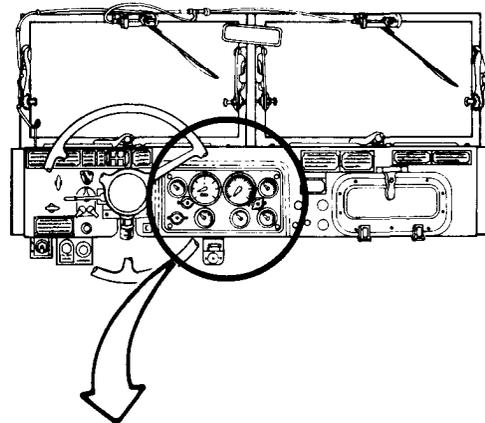

Readings here indicate a dead battery. Could be undercharged, a short in electrical system or battery is worn out or defective

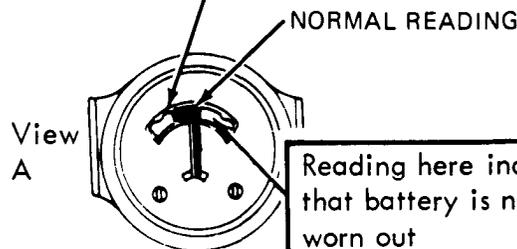

NORMAL READING

Reading here indicates that battery is nearly worn out

Engine running at 1200 RPM for several minutes, and pointer rests in this area, means battery is not charging. Refer to generator (alternator) system. Refer to troubleshooting index.

With all electrical units off, run engine to maximum charging rate. If voltage regulator is properly set, pointer will fall in top half of green section

Engine running at maximum charging speed long enough to charge battery, with all electrical units turned on, pointer should stay in green section. If not, voltage regulator is set too low, or battery is worn out

Readings here show battery was recently charged at high rate (overcharged)

View B

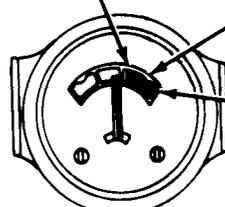
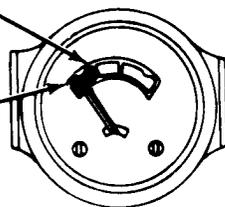

Overcharge section. Check for maladjusted or defective voltage regulator. Refer to troubleshooting index.

TA 114762

Figure 29-1

CHAPTER 30

ELECTRICAL SYSTEM CHECKOUT PROCEDURES

30-1. GENERAL. This chapter gives procedures for checking out the system after troubleshooting and repair have been done. Procedures are set up in flow chart form showing the checkout steps in order and referring to the fault symptom index when the system does not check out.

INDICATOR GAGE CHECKOUT

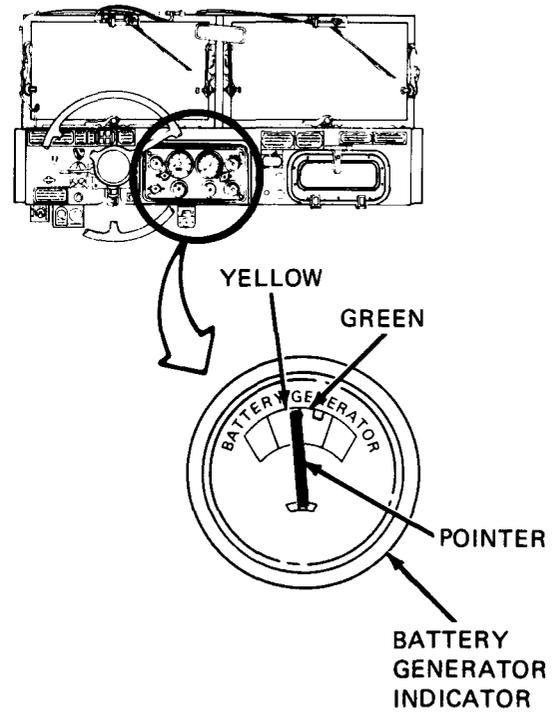
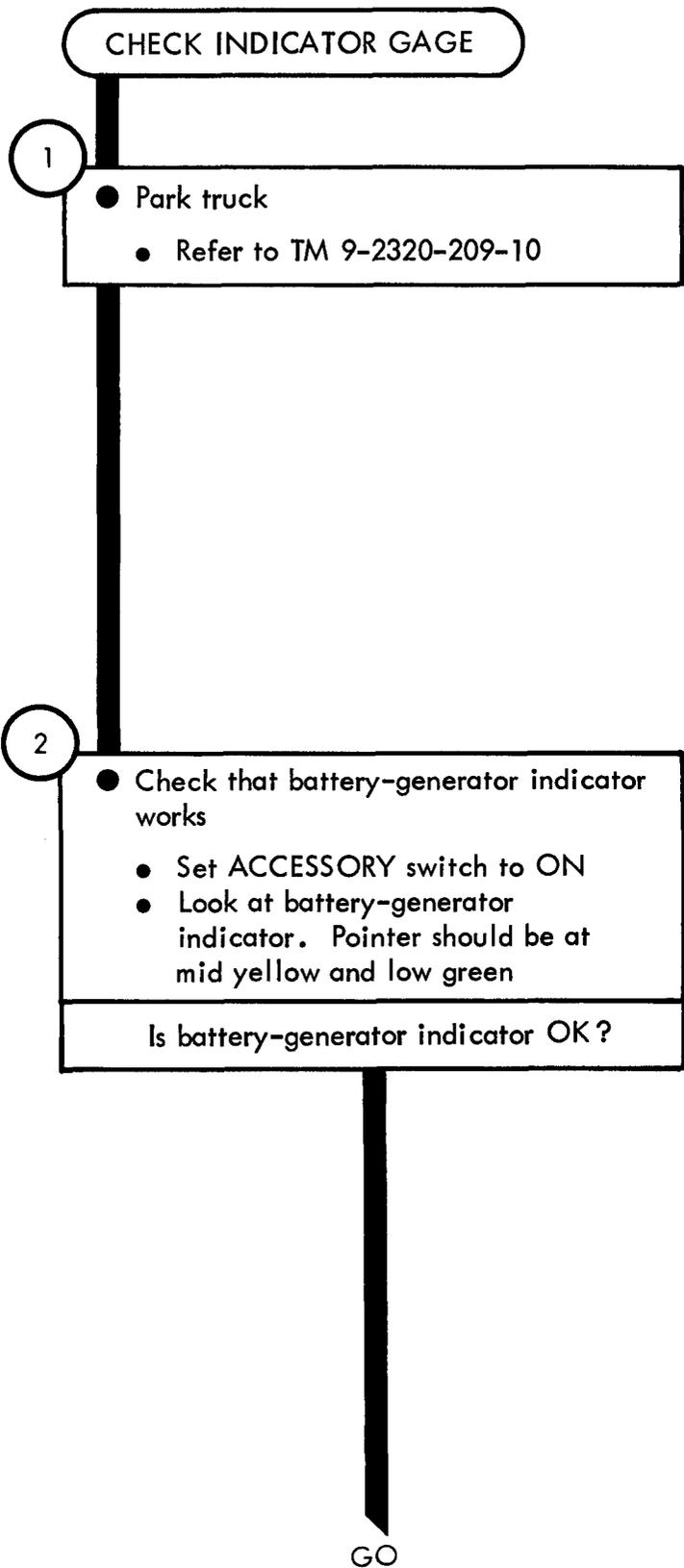

Figure 30-1 (Sheet 1 of 6)

TA 114763

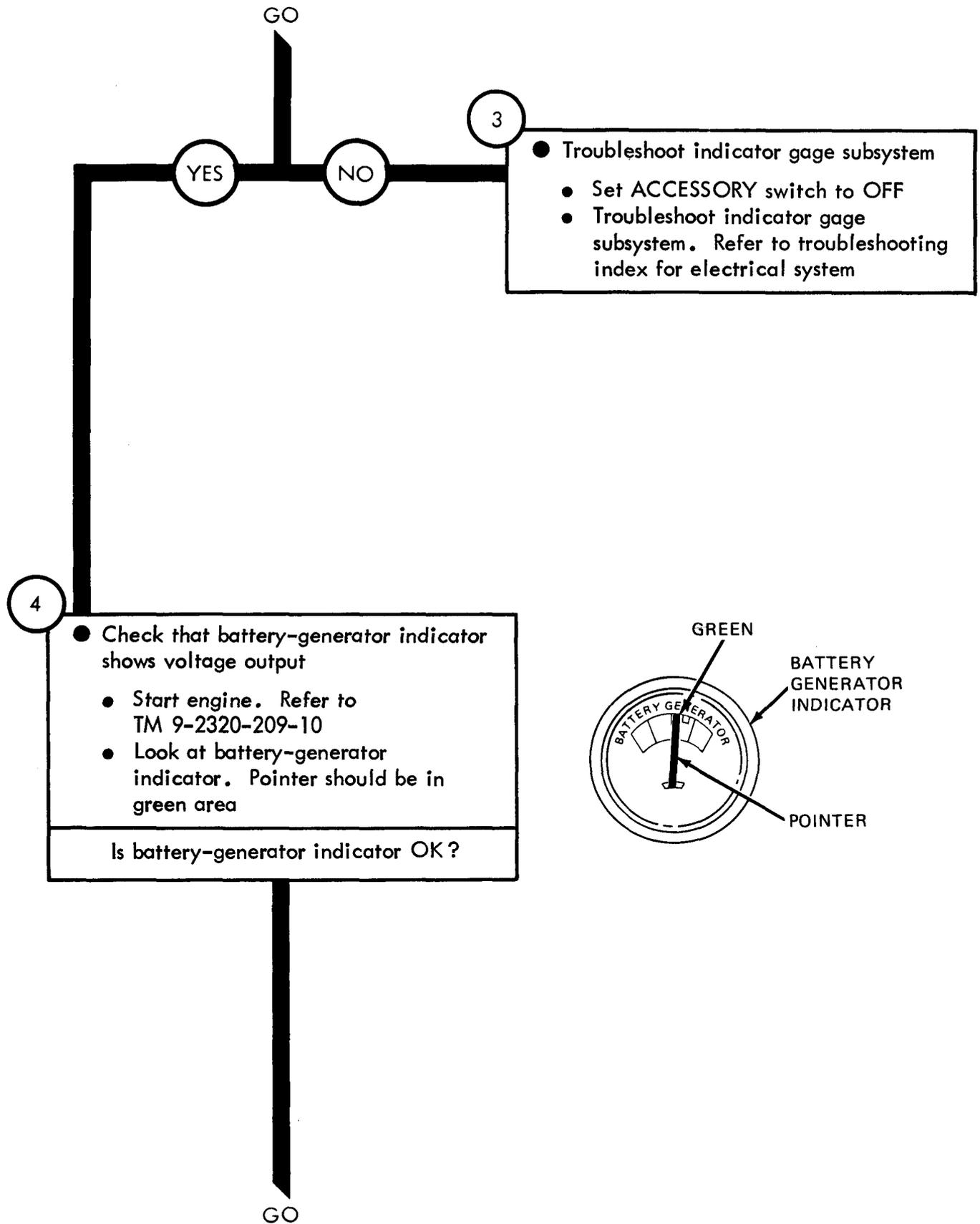
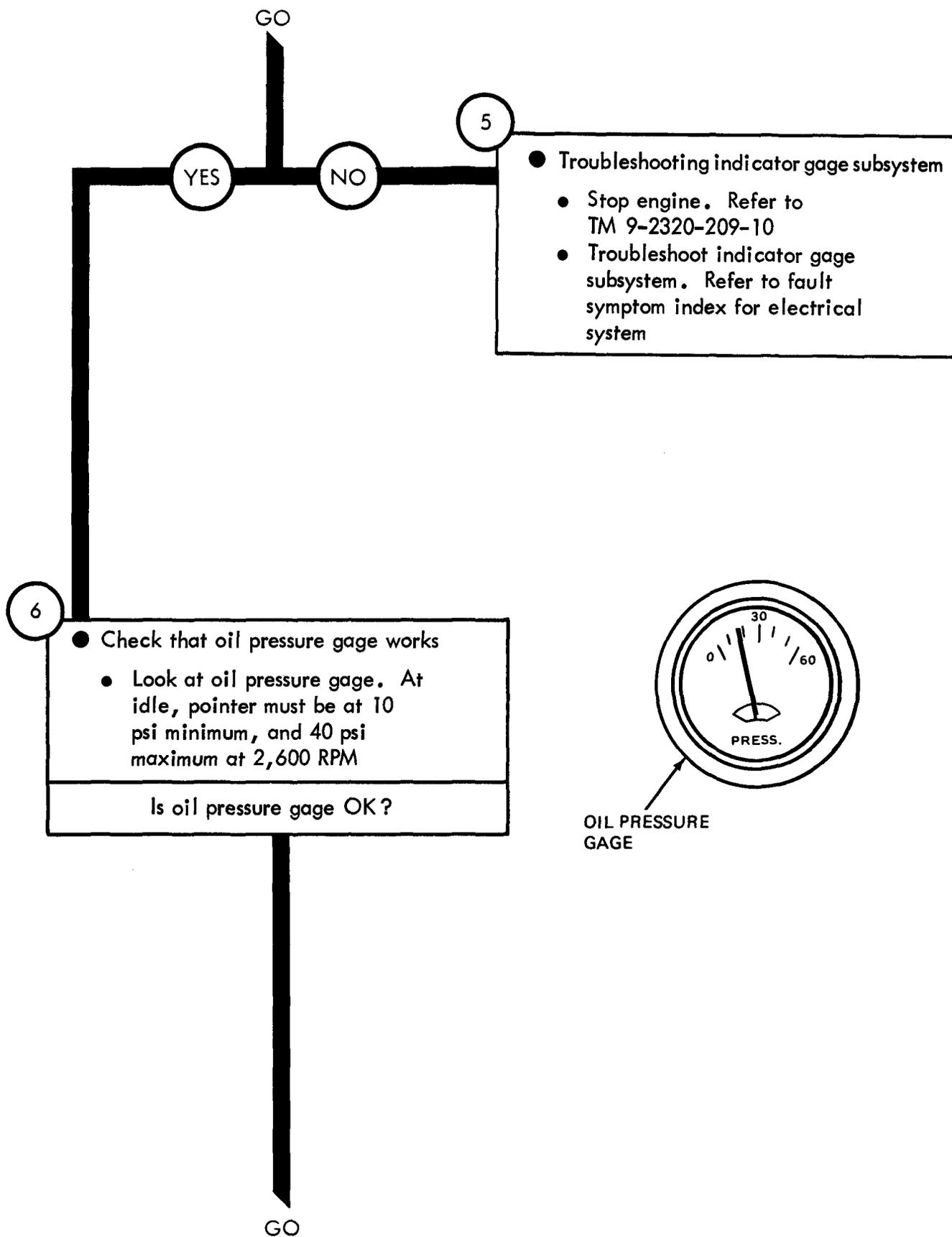

Figure 30-1 (Sheet 2 of 6)



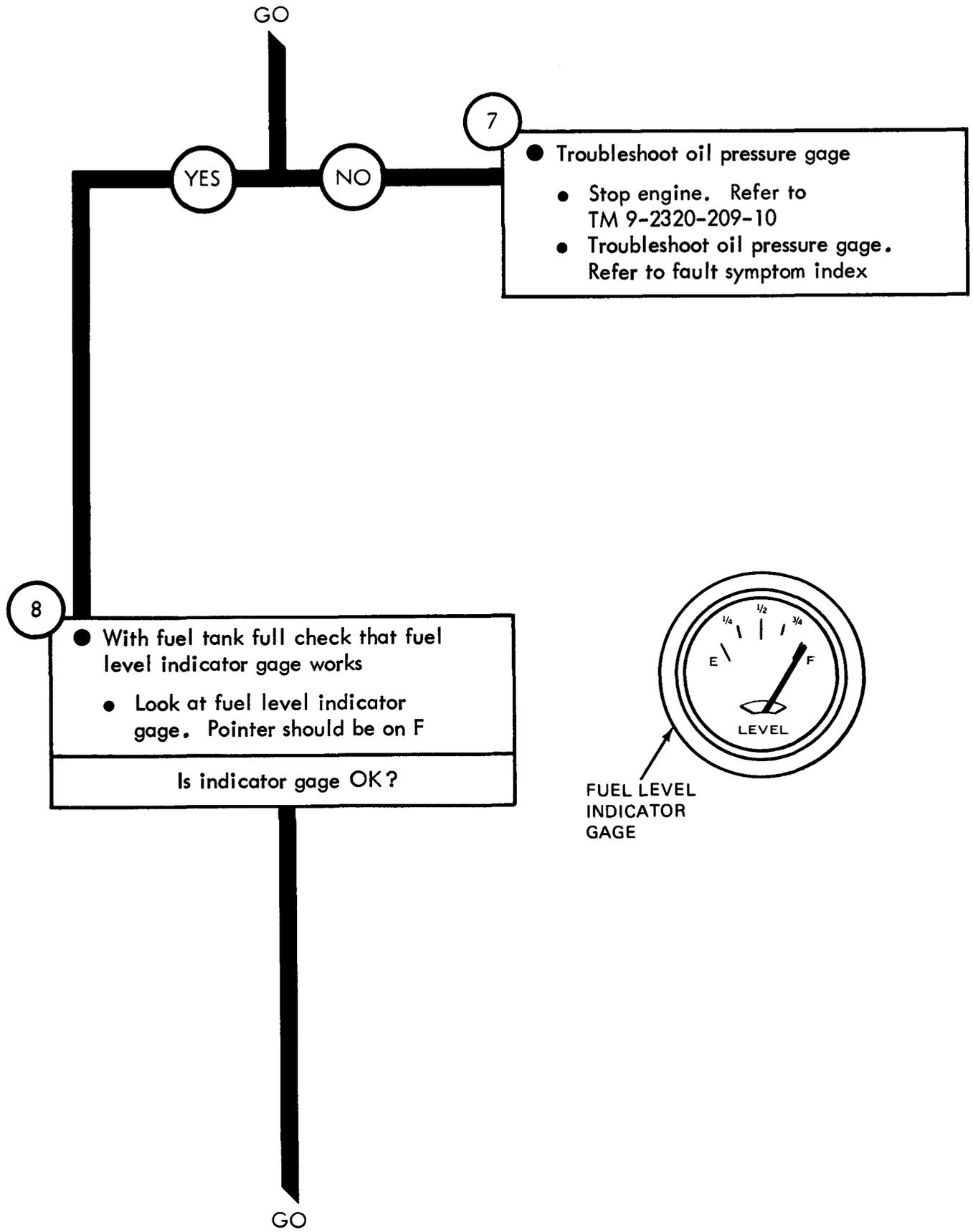
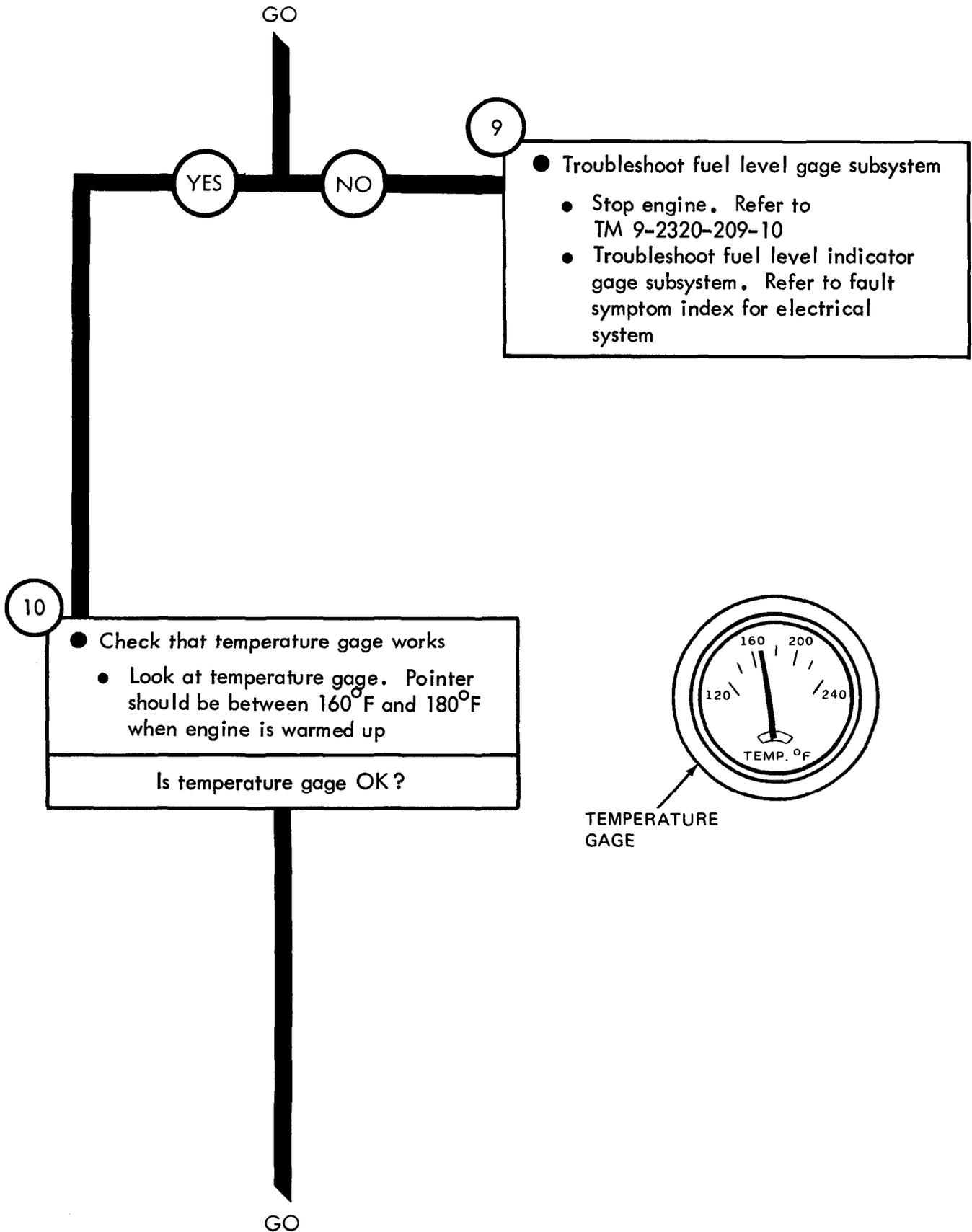

Figure 30-1 (Sheet 4 of 6)



LIGHTING CHECKOUT

CHECK IF ALL LIGHTS WORK

NOTE

Two soldiers are needed to checkout lighting subsystem and are noted as Soldier A and Soldier B

Check TM 9-2320-209-10 to see which lights go on for each position of light switch levers

1

- Park truck
- Refer to TM 9-2320-209-10

2

- Check if all lights work
- SOLDIER A
- Move light switch levers to lights being tested
 - Tell Soldier B which lights are being tested
- SOLDIER B
- Look at each light being tested
 - Write down if light works or not

Do all lights work?

GO

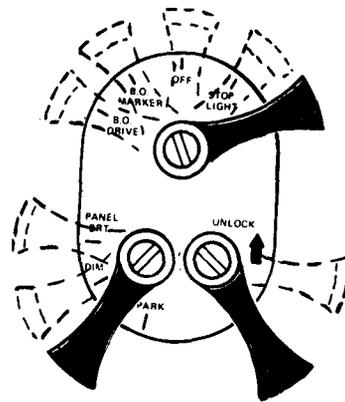

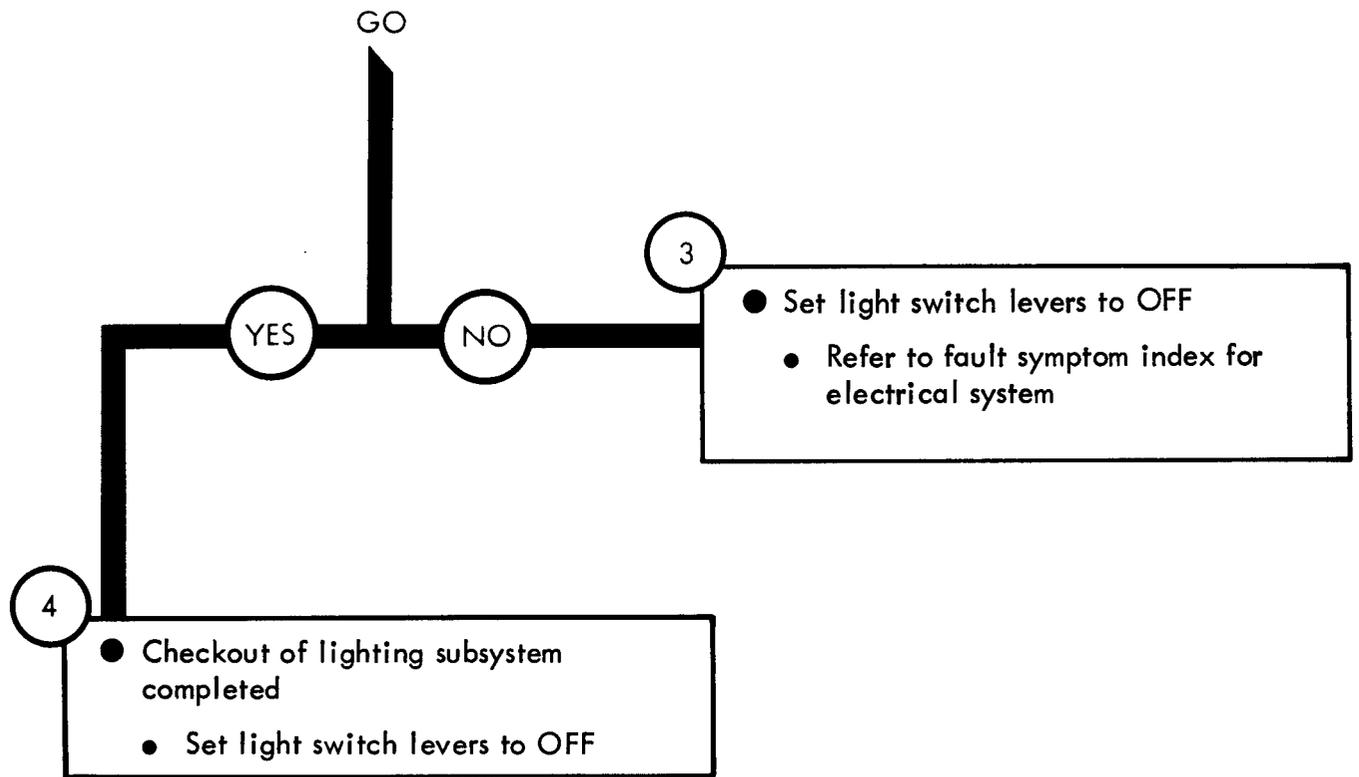
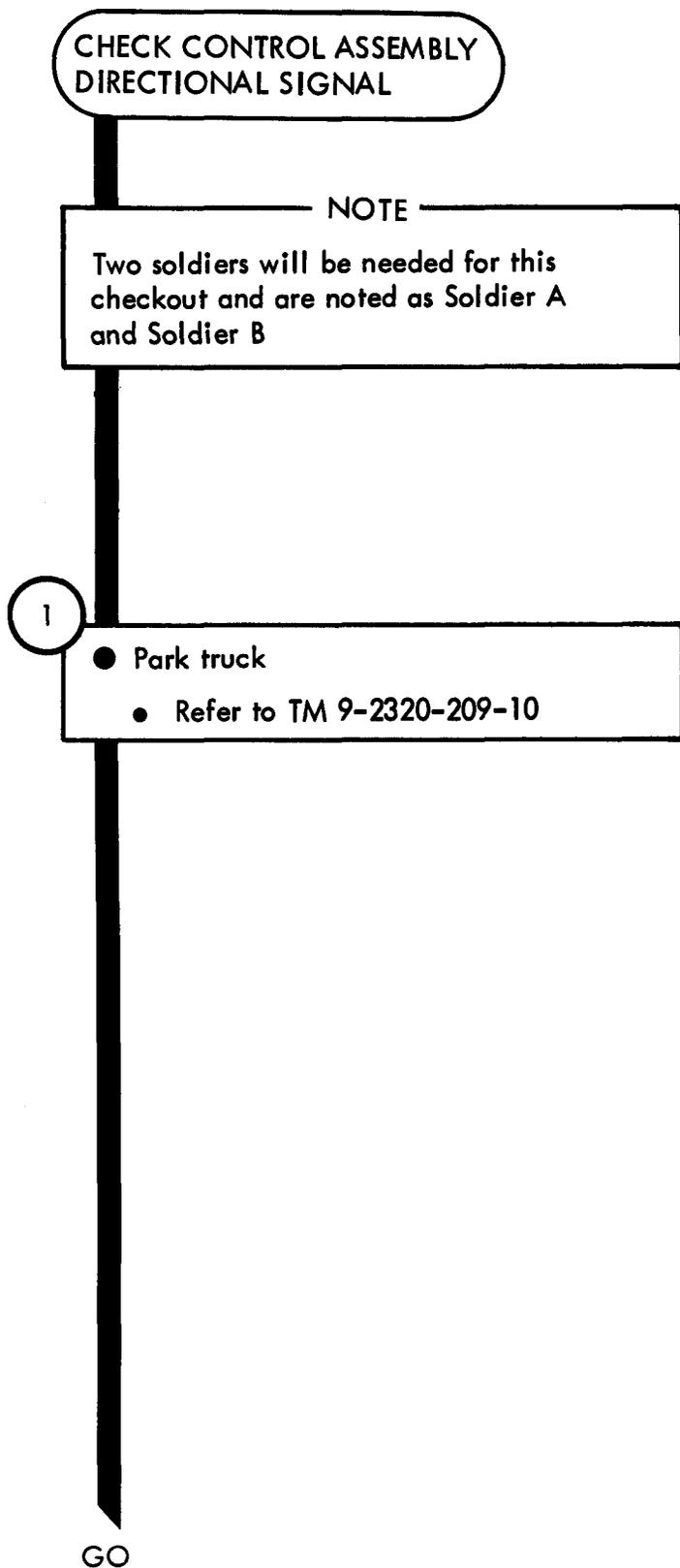

Figure 30-2 (Sheet 2 of 2)

DIRECTIONAL SIGNAL CHECKOUT



TA 114771

Figure 30-3 (Sheet 1 of 5)

GO

2

- Check that hazard warning lights work

SOLDIER A

- Set light switch main lever to STOPLIGHT
- Set turn signal control arm to hazard warning position
- Check that turn signal control lamp flashes 1 to 2 times per second

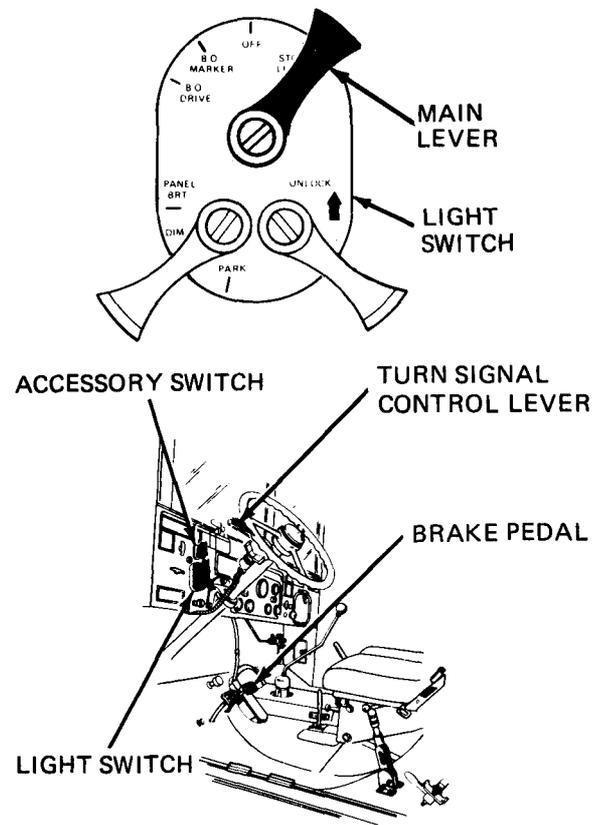

SOLDIER B

- Check that two front signal lamps and two rear signal lamps flash together at 1 to 2 times per second

SOLDIER A

- Step on brake pedal and hold it down
- Check that turn signal control arm lamp flashes 1 to 2 time per second

SOLDIER B

- While Soldier A holds down brake pedal check that rear turn signal lamps flash 1 to 2 times per second

Do hazard warning lamps checkout OK?

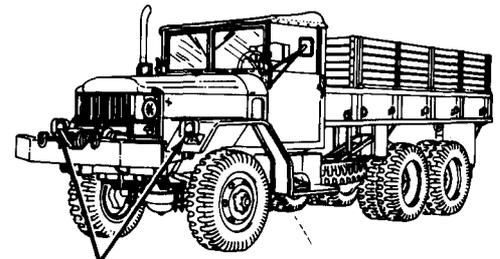

FRONT SIGNAL LIGHTS

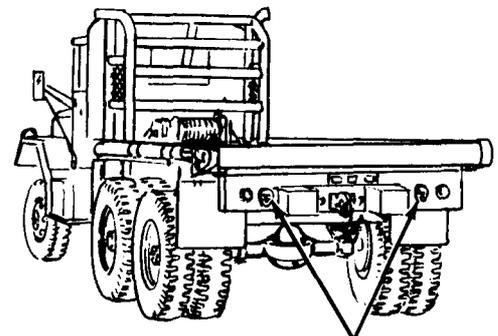

REAR SIGNAL LIGHTS

GO

TA 114772

Figure 30-3 (Sheet 2 of 5)

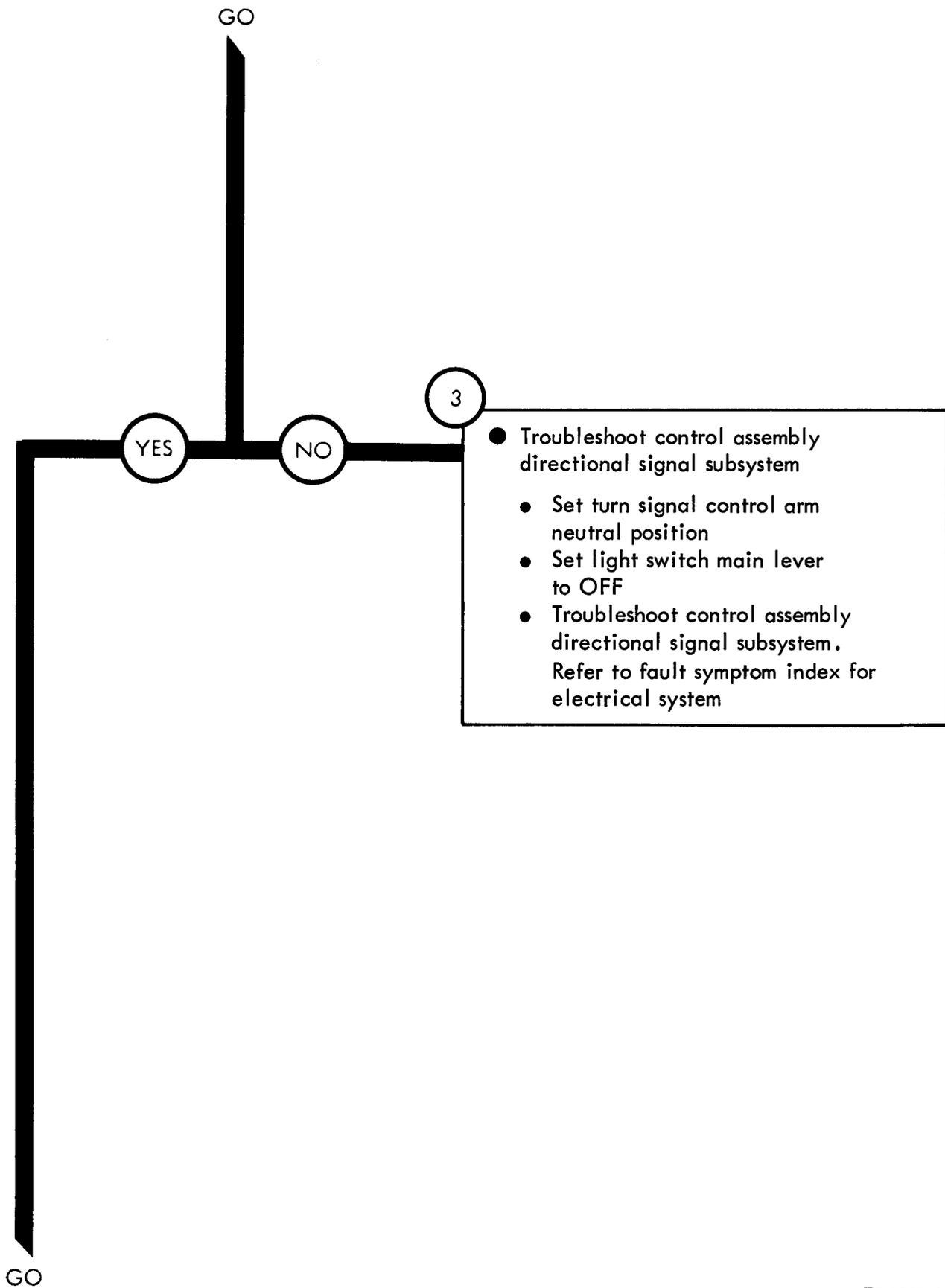

Figure 30-3 (Sheet 3 of 5)

TA 114773

GO

4

- Check that turn signal control lamps light
- SOLDIER A ● Set turn signal control arm to left turn
- SOLDIER B ● Check that front and rear left turn signals work
- SOLDIER A ● Step on brake pedal and hold it down
- SOLDIER B ● Check that left turn signal flashes with brake on

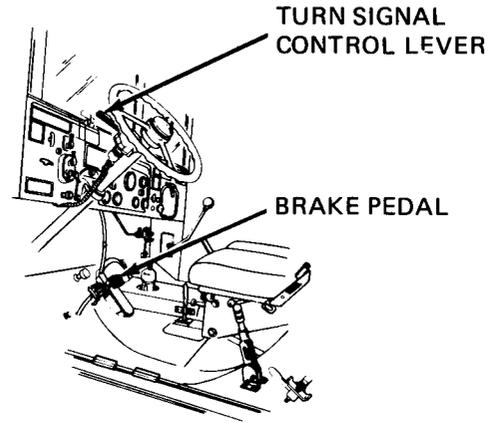

- SOLDIER A ● Keep brake pedal held down and set turn signal control arm to right turn
- SOLDIER B ● Check that right rear turn signal works with brake on
- SOLDIER A ● Release brake pedal
- SOLDIER B ● Check that right rear and front turn signal lights work

RIGHT TURN SIGNAL LIGHT

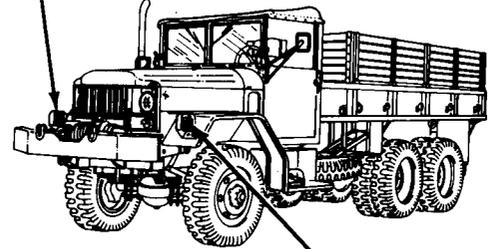

LEFT TURN SIGNAL LIGHT

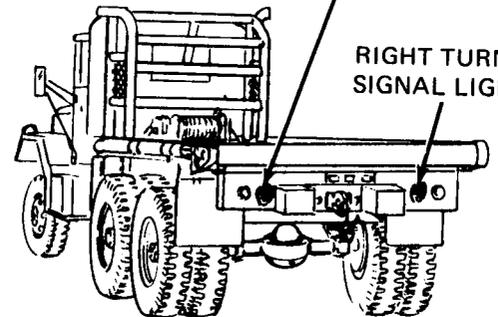

Do all turn signal lights work OK?

GO

Figure 30-3 (Sheet 4 of 5)

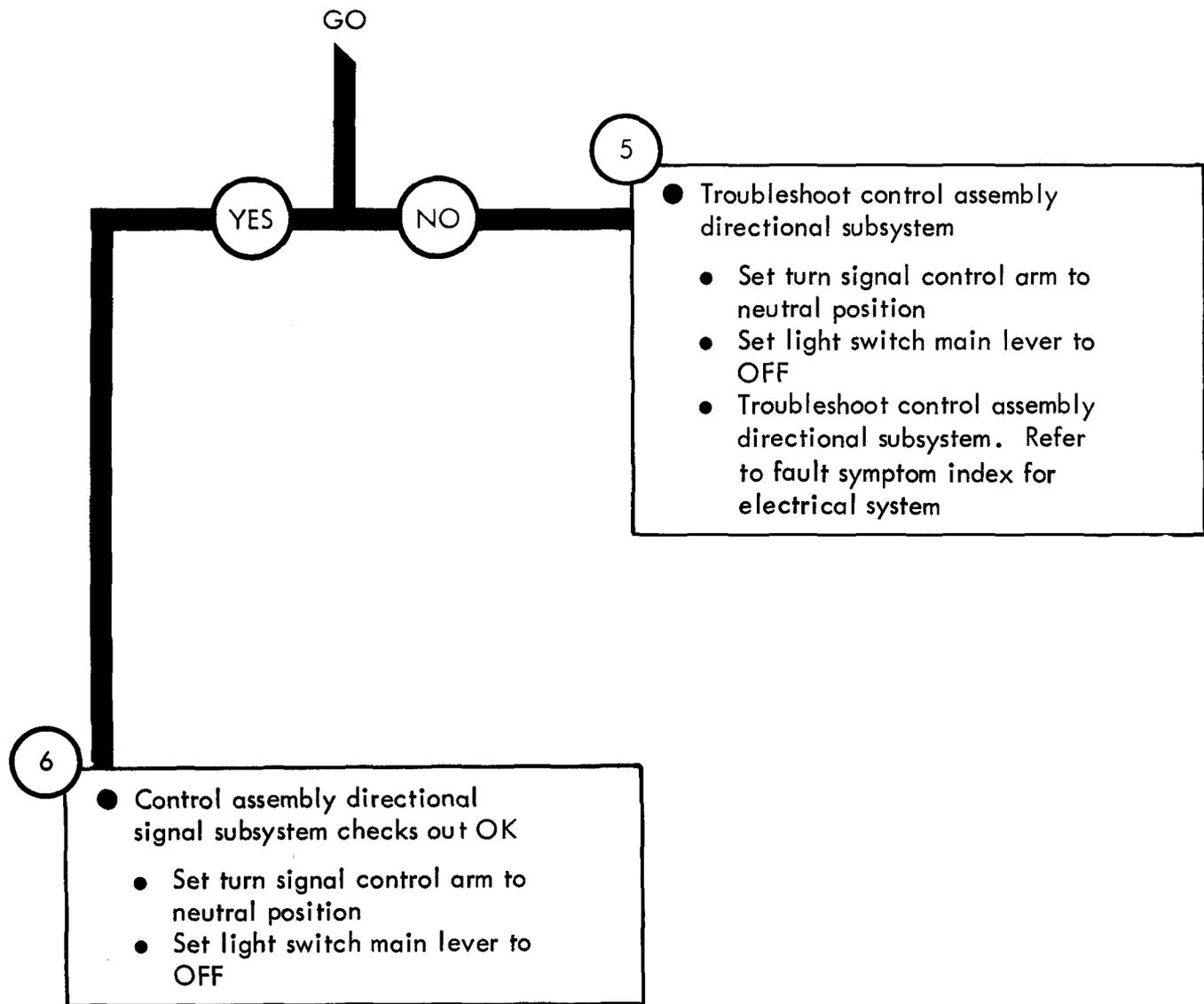

Figure 30-3 (Sheet 5 of 5)

TA 114775

CHAPTER 31

TRANSMISSION SYSTEM TROUBLESHOOTING

31-1. EQUIPMENT ITEMS COVERED. This chapter gives equipment troubleshooting procedures for the transmission system, for which there are authorized corrective maintenance tasks at the organizational maintenance level.

31-2. EQUIPMENT ITEMS NOT COVERED. All equipment items for which corrective maintenance is authorized at the organizational maintenance level are covered in this chapter.

TRANSMISSION TROUBLESHOOTING

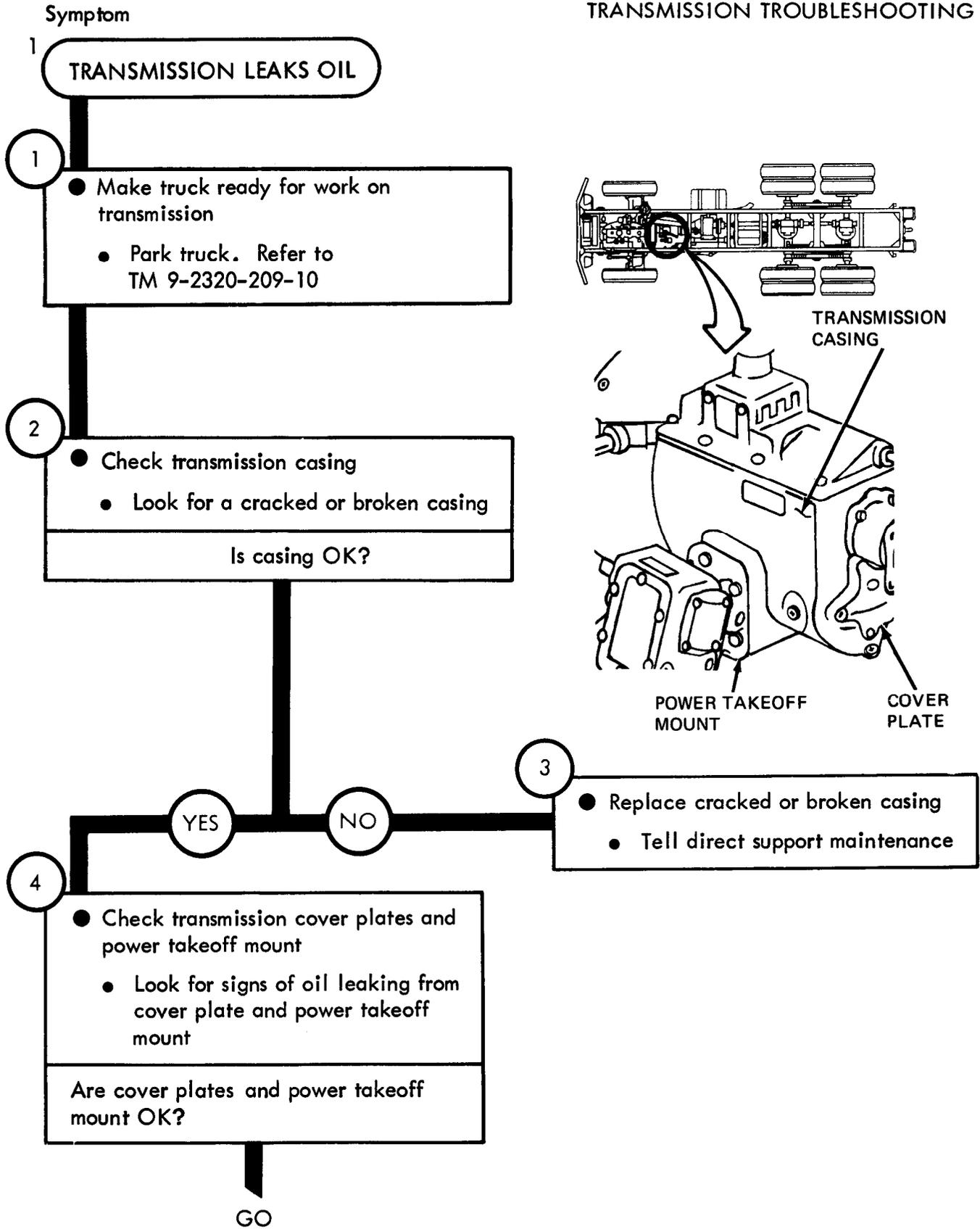

Figure 31-1 (Sheet 1 of 2)

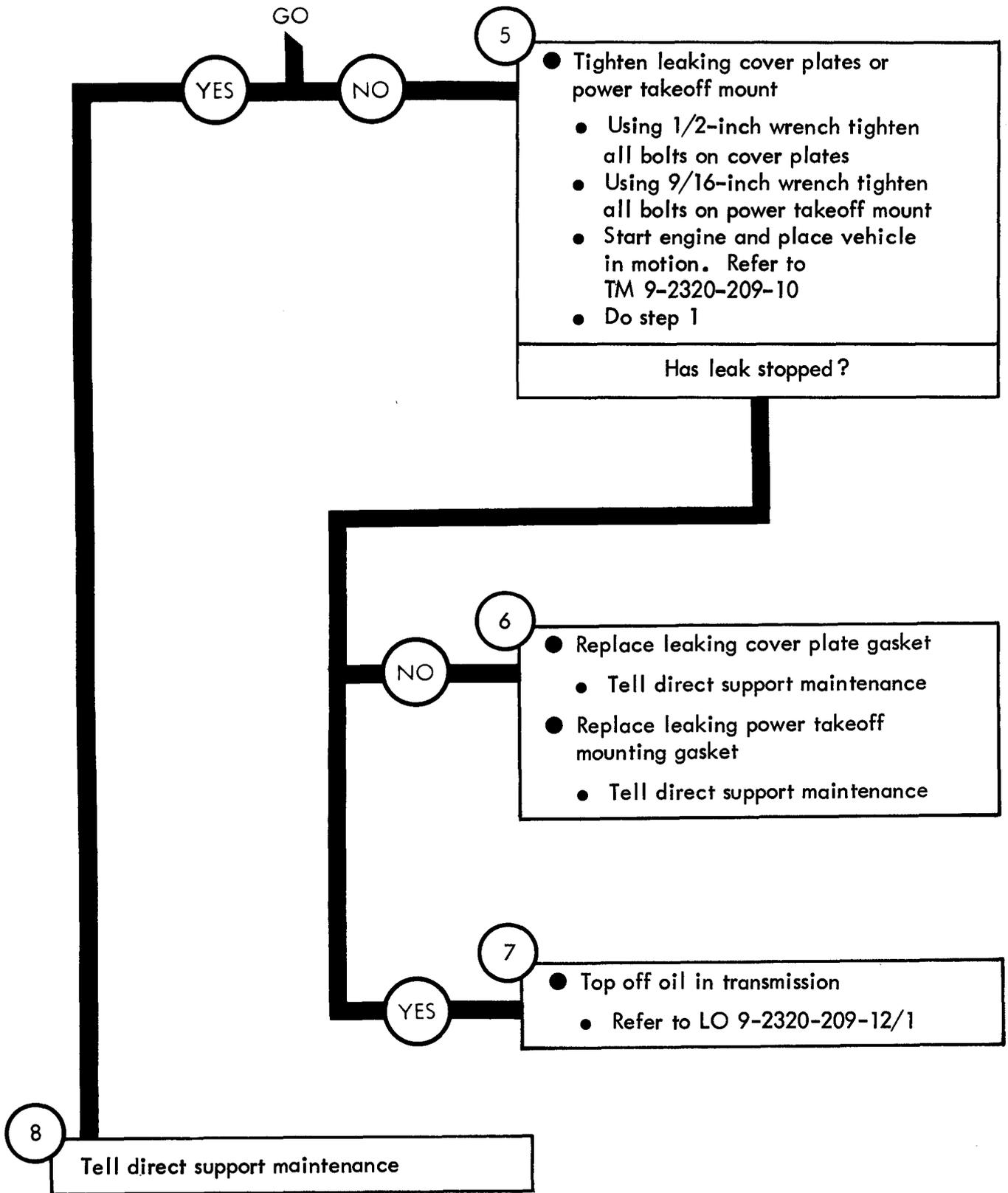
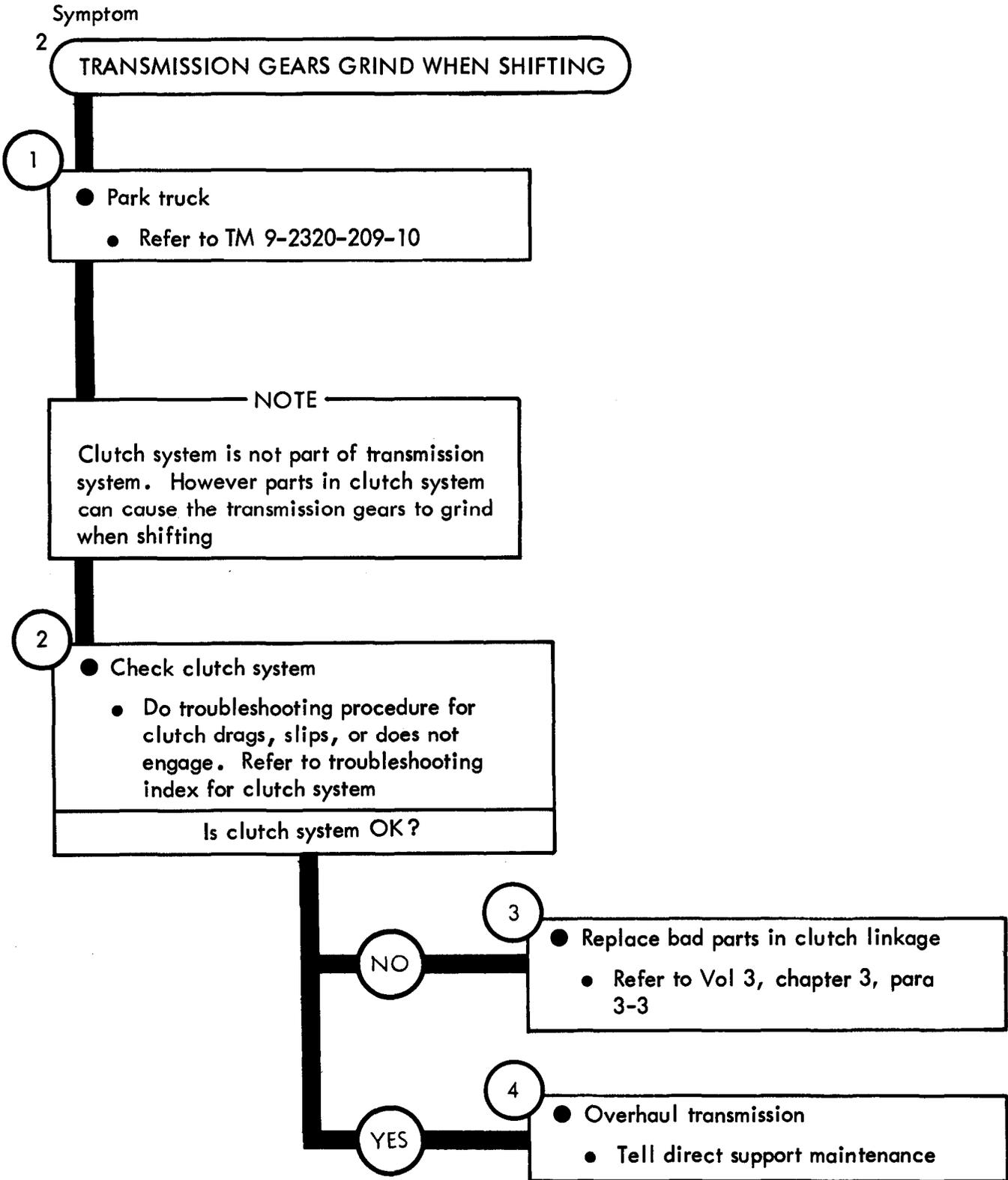

Figure 31-1 (Sheet 2 of 2)



TA 114778

Figure 31-2

CHAPTER 32

TRANSMISSION SYSTEM TROUBLESHOOTING SUMMARY

32-1. GENERAL. This chapter gives a summary of troubleshooting procedures given in chapter 31 for the transmission system.

32-2. PROCEDURES. The summary in this chapter covers all fault symptoms found in the detailed troubleshooting procedures. Chapter 7 outlines a sample troubleshooting procedure. The summary procedures are based on the "what-to-do" portions of the detailed procedures and do not include the "how-to-do-it" instructions. Warnings, cautions, and notes are given where needed.

TRANSMISSION SYSTEM TROUBLESHOOTING SUMMARY

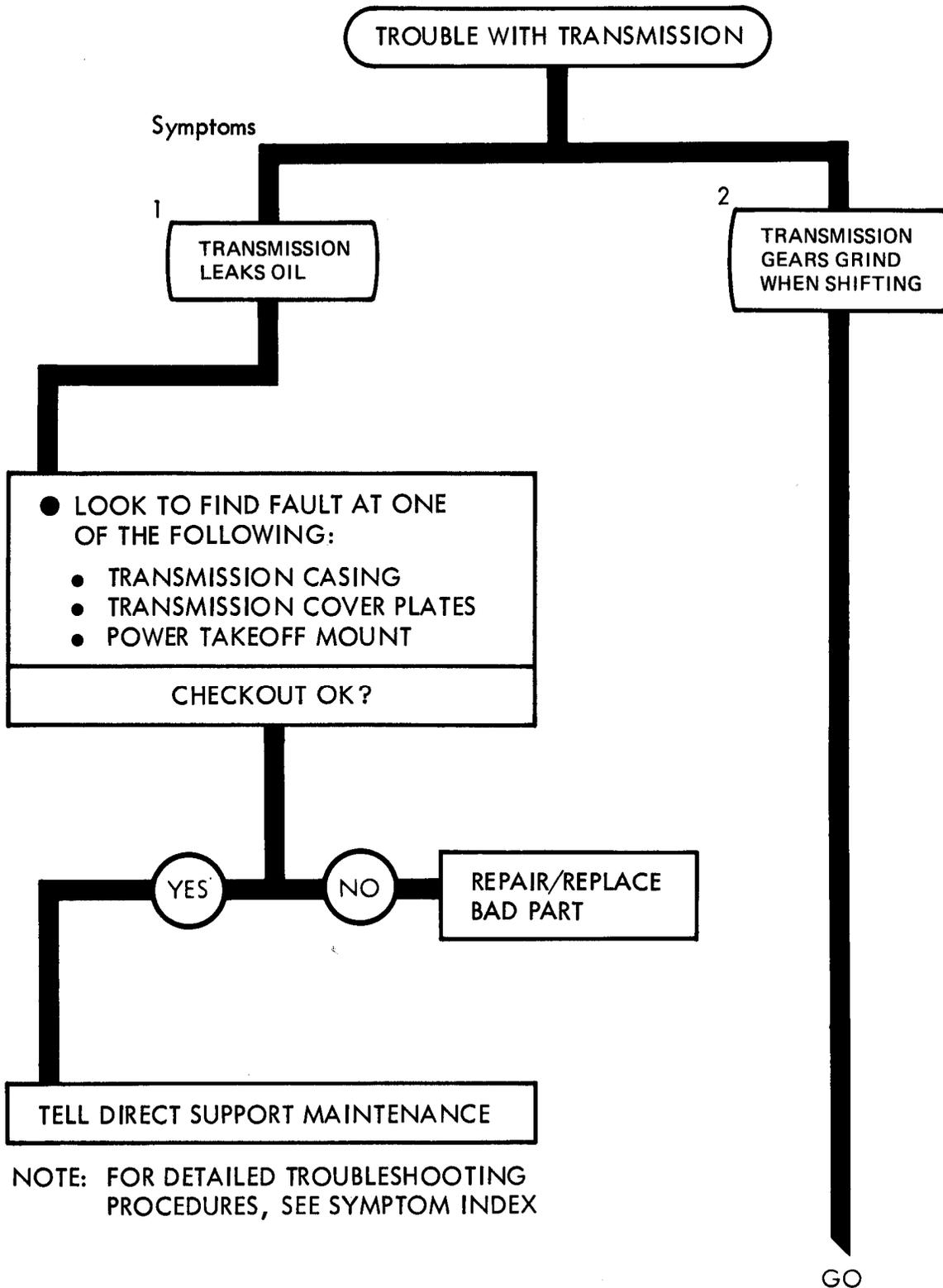

NOTE: FOR DETAILED TROUBLESHOOTING PROCEDURES, SEE SYMPTOM INDEX

Figure 32-1 (Sheet 1 of 2)

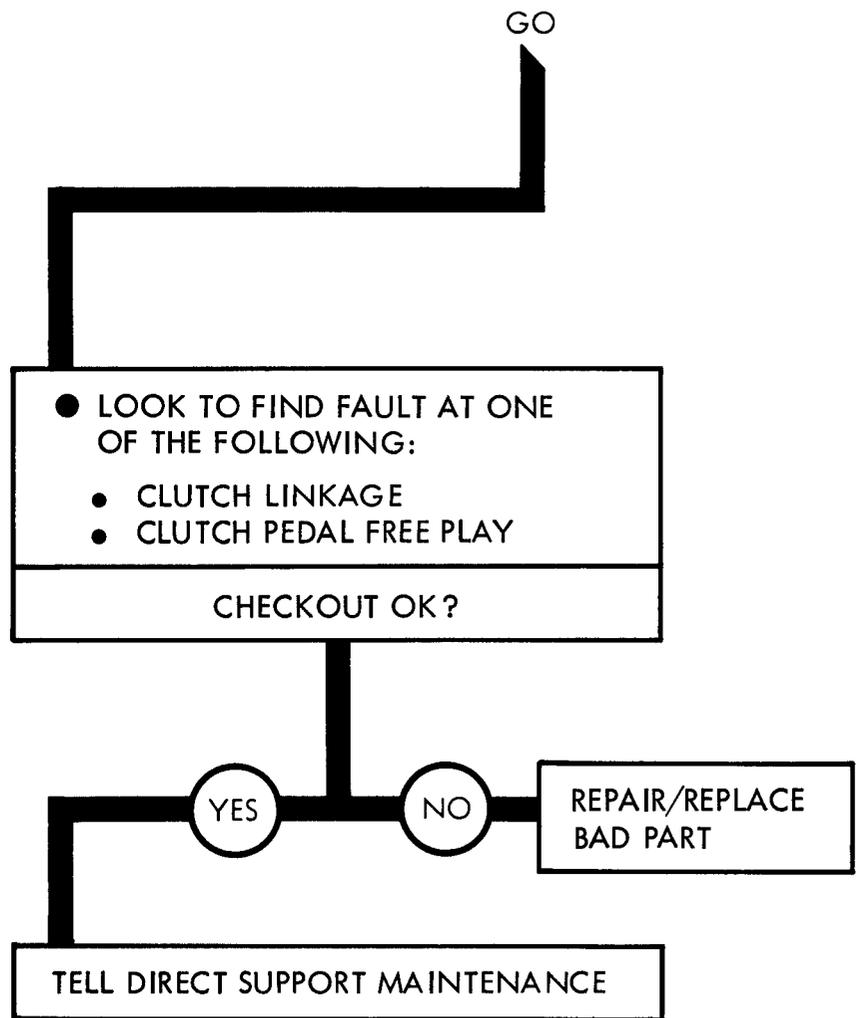

NOTE: FOR DETAILED TROUBLESHOOTING PROCEDURES, SEE SYMPTOM INDEX.

Figure 32-1 (Sheet 2 of 2)

CHAPTER 33

TRANSFER SYSTEM TROUBLESHOOTING

33-1. EQUIPMENT ITEMS COVERED. This chapter gives equipment troubleshooting procedures for the transfer system, for which there are authorized corrective maintenance tasks at the organizational maintenance level.

33-2. EQUIPMENT ITEMS NOT COVERED. All equipment items for which corrective maintenance is authorized at the organizational maintenance level are covered in this chapter.

TRANSFER SYSTEM TROUBLESHOOTING

Symptom

1 TRANSFER LEAKS OIL

- 1
- Make truck ready for work on transfer
 - Park truck. Refer to TM 9-2320-209-10

- 2
- Check transfer gaskets, seals, and casing
 - Crawl under truck
 - Look for a cracked or broken casing
 - Look for signs of gear oil leaking from gaskets
 - Look at propeller shaft flanges to see if gear oil is leaking from seals
- Are gaskets and seals OK, and casing not cracked or broken?

GO

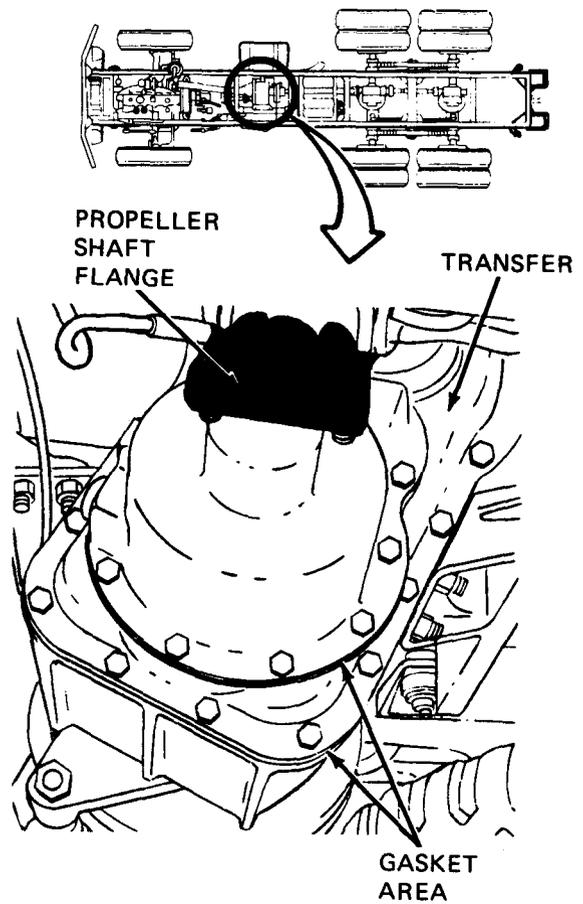

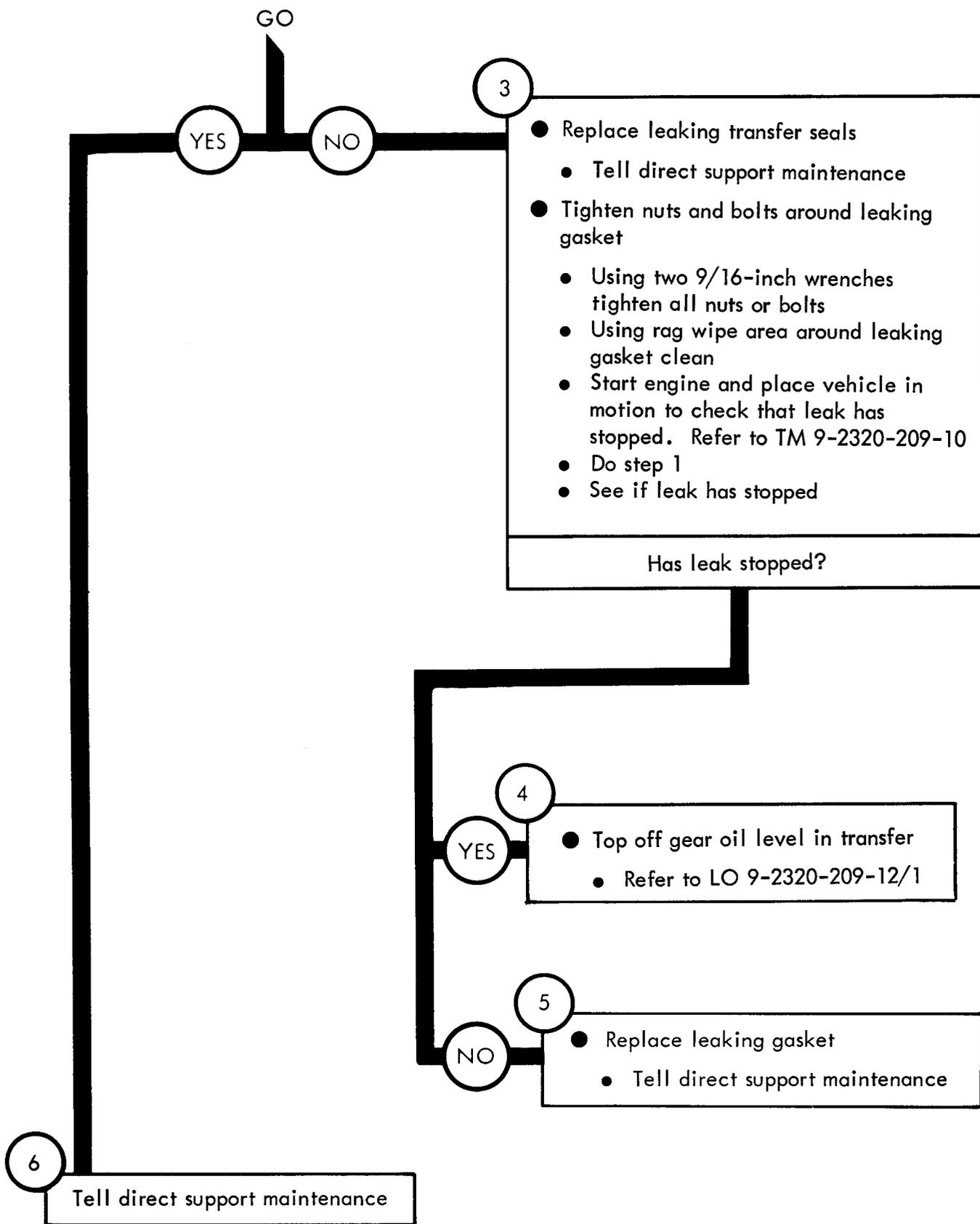

Figure 33-1 (Sheet 2 of 2)

Symptom

2 TRANSFER IS HARD TO SHIFT, OR POPS OUT OF GEAR

1

- Make truck ready for work on transfer
 - Park truck. Refer to TM 9-2320-209-10

2

- Check for bent transfer linkage
 - Remove cab tunnels. Refer to Vol 3, chapter 18, para 18-5
 - Look closely for signs of bent linkage

Is linkage OK?

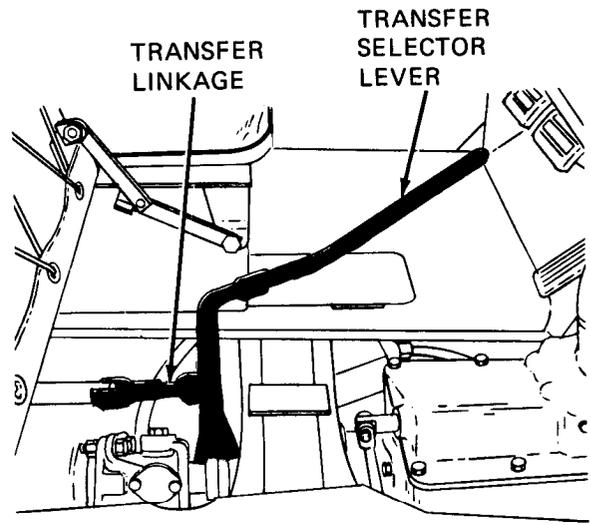

YES NO

3

- Replace bent transfer linkage
 - Refer to Vol 3, chapter 9, para 9-3 or 9-4

GO

Figure 33-2 (Sheet 1 of 2)

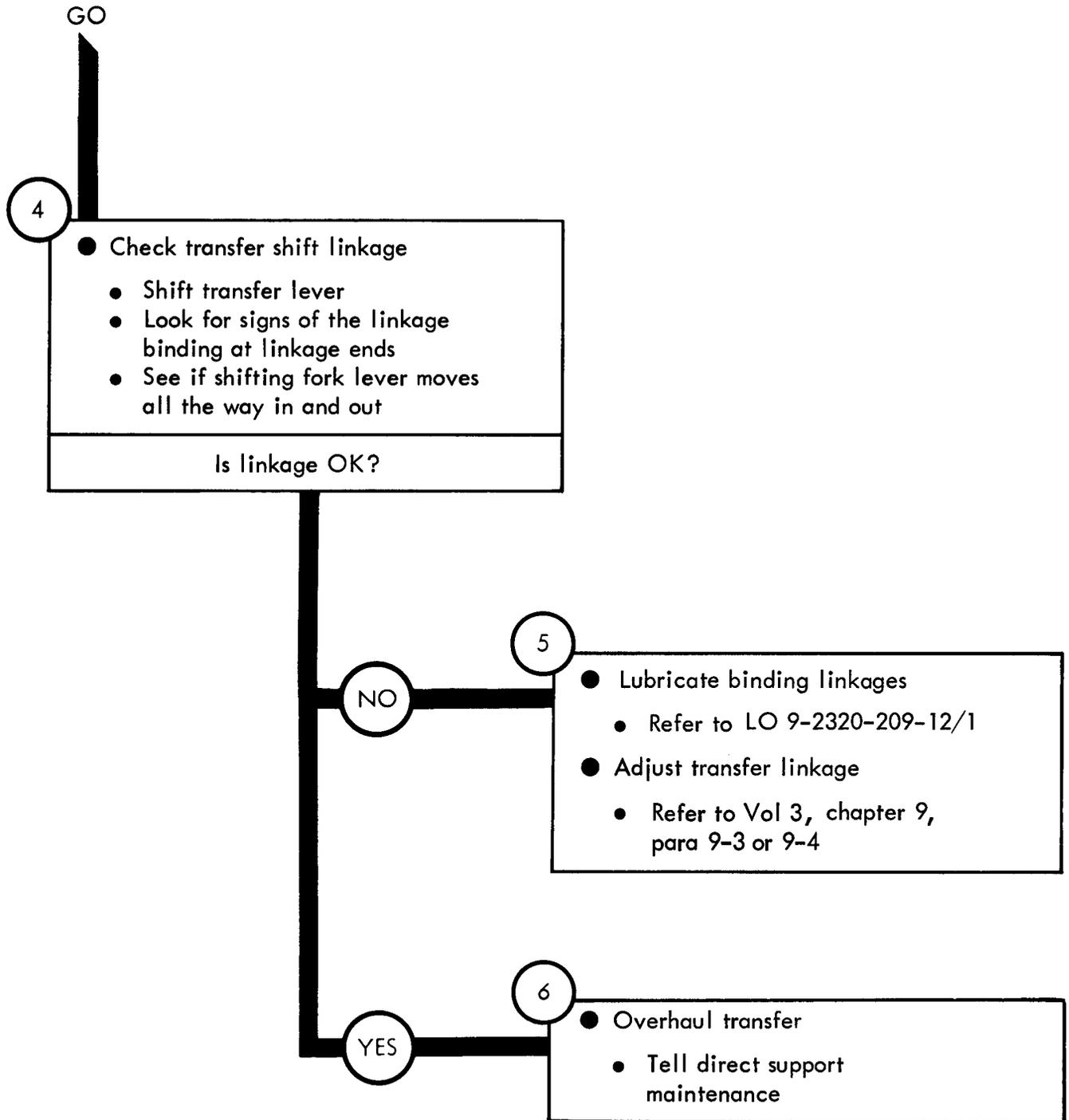

Figure 33-2 (Sheet 2 of 2)

Symptom

3 CLUNKING NOISE HEARD DURING ACCELERATION ON TRUCKS M36A2 AND M342A2

1

- Make truck ready for work on propeller shafts
 - Park truck. Refer to TM 9-2320-209-10

2

- Check transfer mounts
 - Crawl under truck
 - Look for signs that the transfer is shifted to position
 - Look for a broken transfer mount
 - Look for missing transfer mounting nuts or bolts
 - Feel for loose transfer mount nuts

Are transfer mounts OK?

GO

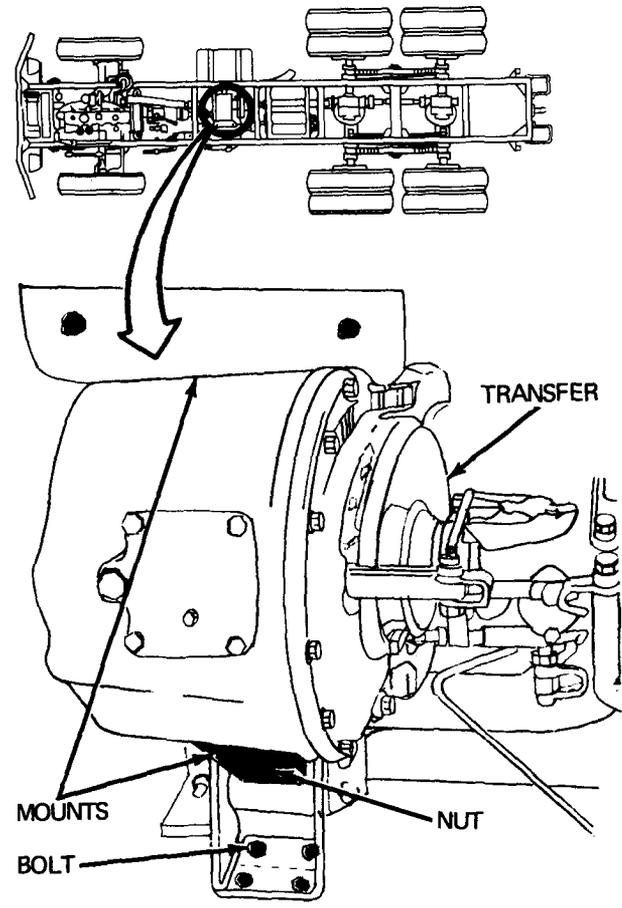

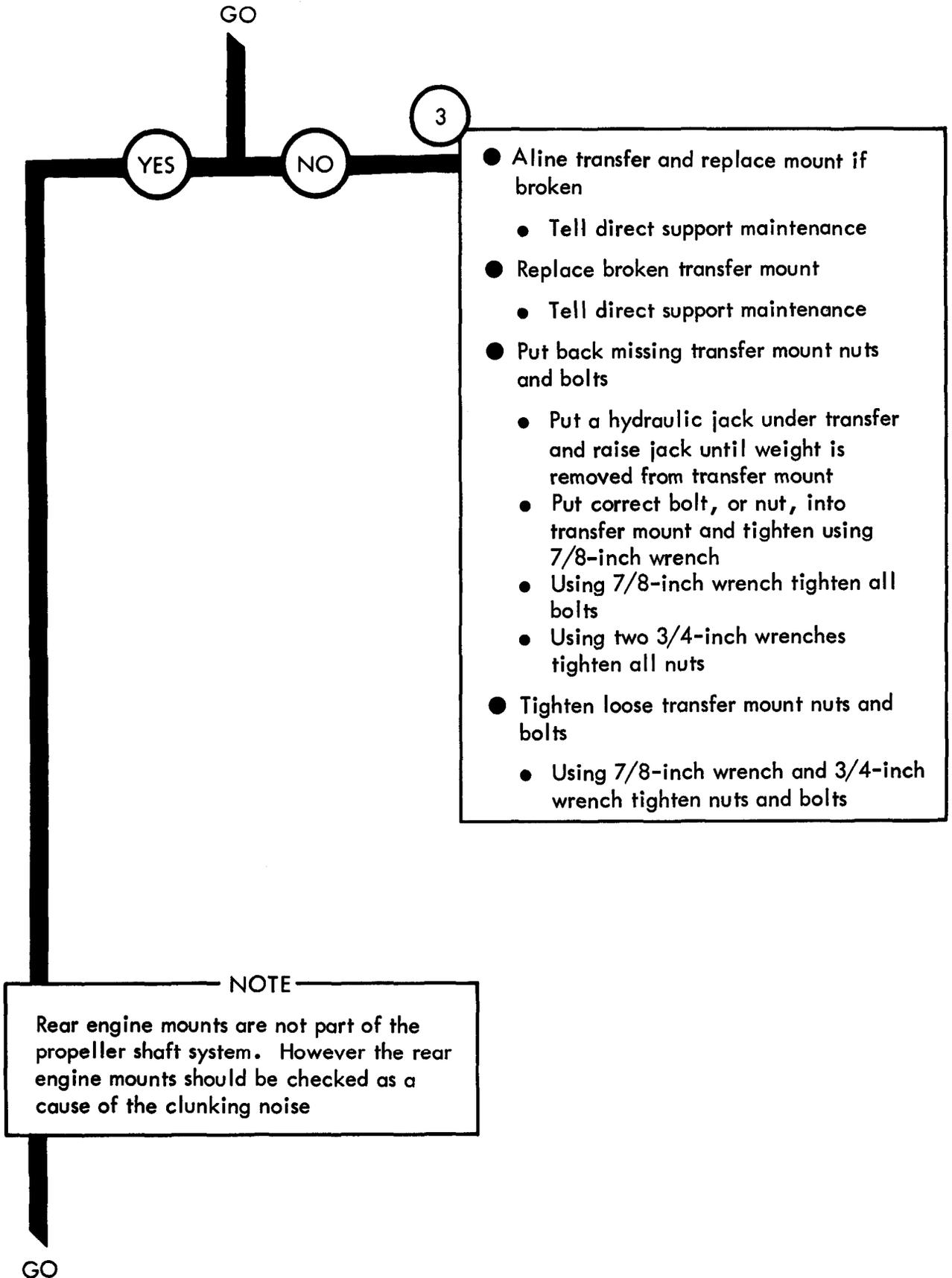

Figure 33-3 (Sheet 2 of 5)

GO

4

- Check rear engine mounts
 - Look for a broken engine mount
 - Look for a missing engine mount nut
 - Using 15/16-inch wrench feel for a loose nut

Are engine mounts OK?

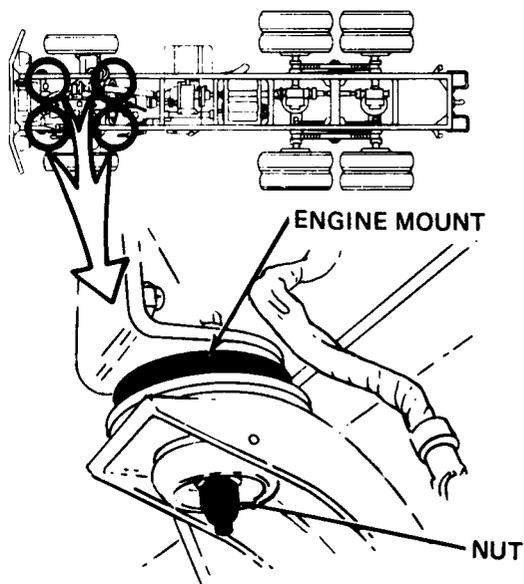

5

YES NO

- Replace broken engine mount
 - Refer to Vol 3, chapter 2, para 2-4
- Put back missing engine mount nut
 - Put a hydraulic jack under jacking point and raise jack until weight is removed from engine mount
 - Put correct nut onto engine mount and screw on until hand tight
 - Using two 7/8-inch wrenches tighten engine mount
- Tighten loose engine mount nut
 - Using two 7/8-inch wrenches tighten engine mount

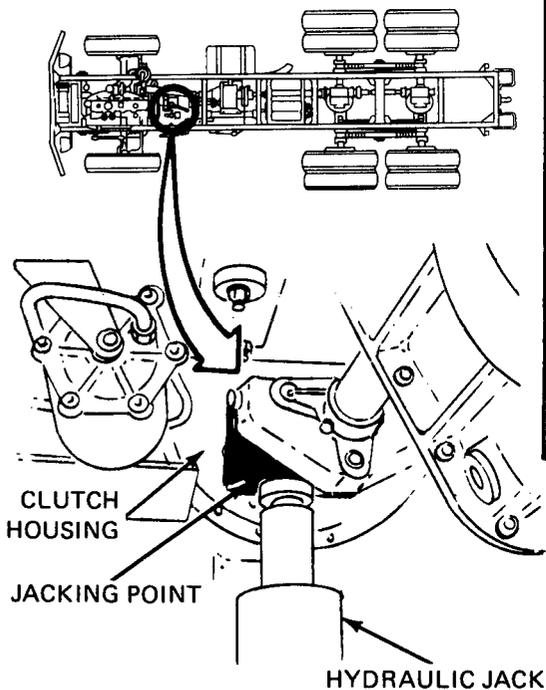

GO

Figure 33-3 (Sheet 3 of 5)

TA 114787

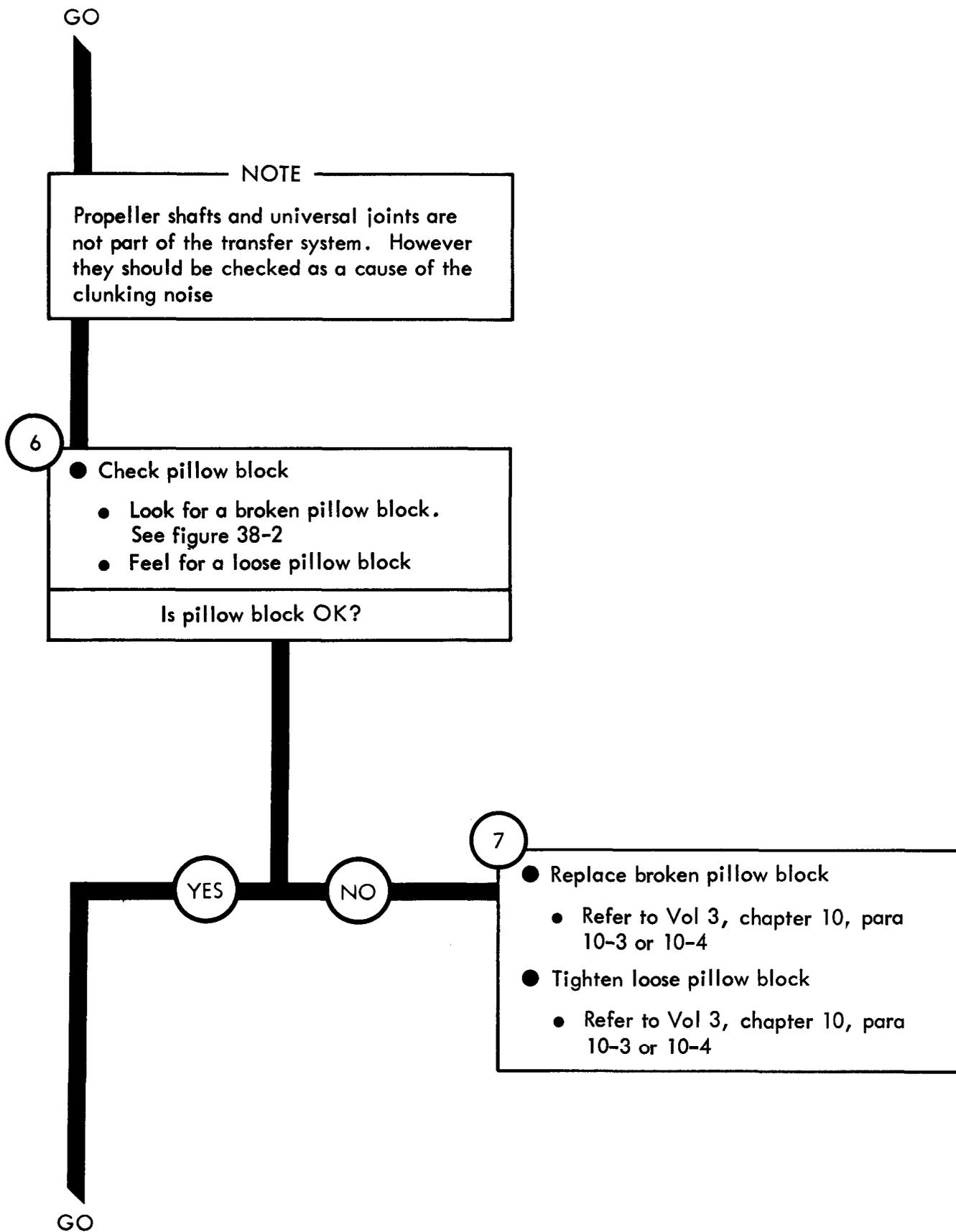

Figure 33-3 (Sheet 4 of 5)

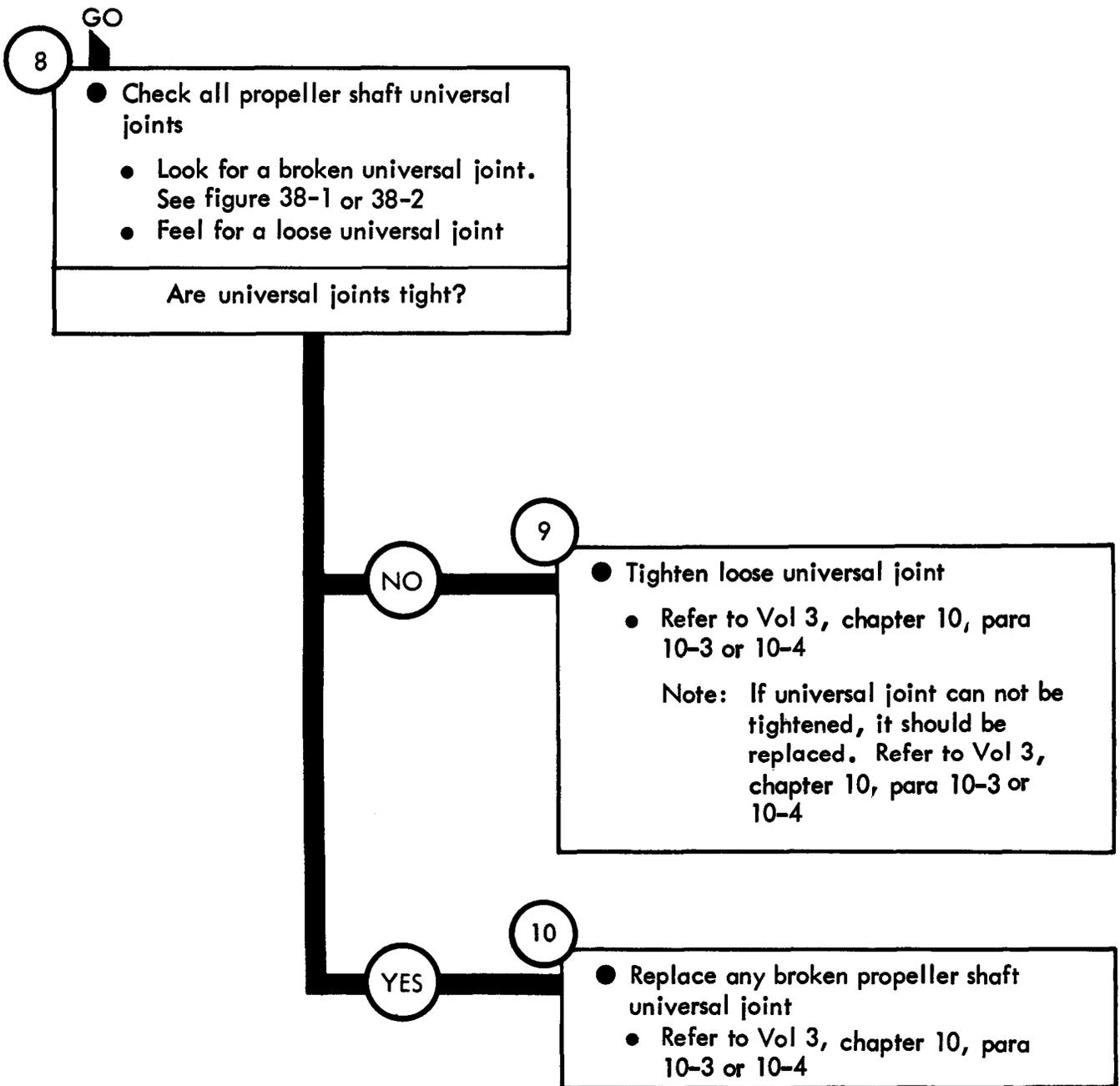

Figure 33-3 (Sheet 5 of 5)

Symptom

4

CLUNKING NOISE HEARD DURING ACCELERATION ON ALL TRUCKS EXCEPT M36A2 AND M342A2

1

- Make truck ready for work on propeller shafts
 - Park truck. Refer to TM 9-2320-209-10

2

- Check transfer mounts
 - Crawl under truck
 - Look for signs that the transfer shifted its position
 - Look for a broken transfer mount
 - Look for missing transfer mounting nuts or bolts
 - Feel for loose transfer mount nuts

Are transfer mounts OK?

GO

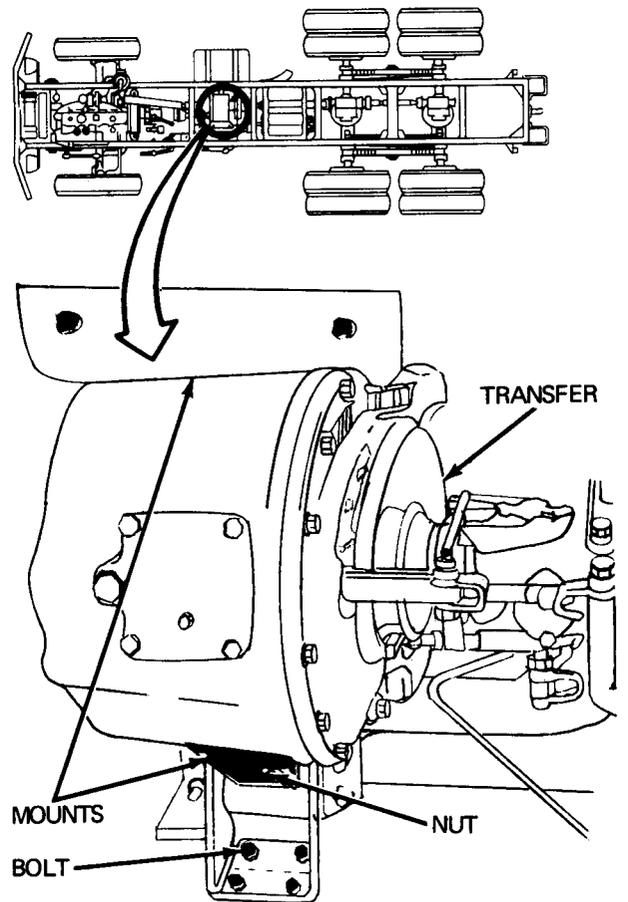

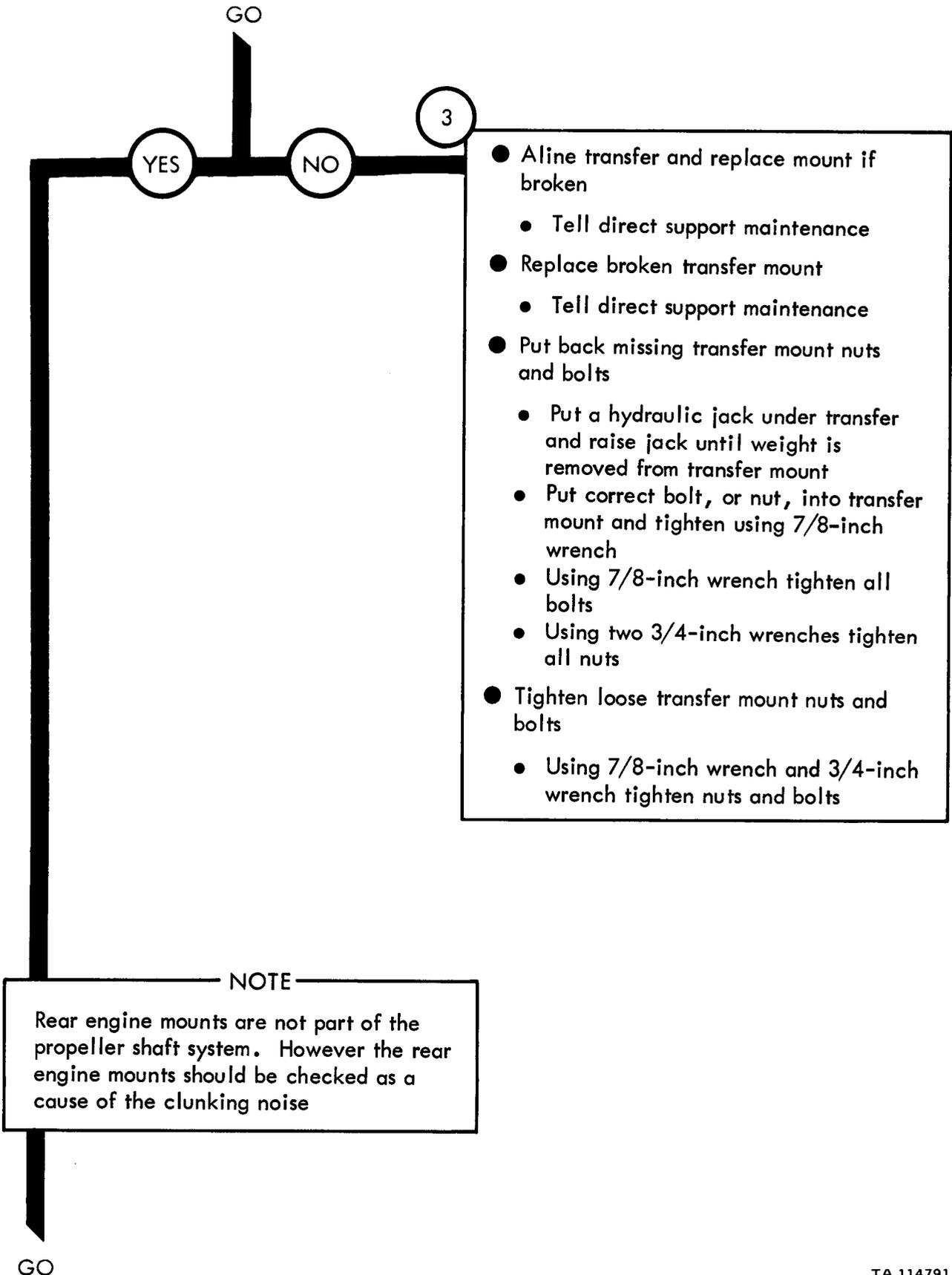

Figure 33-4 (Sheet 2 of 4)

GO

4

- Check rear engine mounts
 - Look for a broken engine mount
 - Look for a missing engine mount nut
 - Using 15/16-inch wrench feel for a loose nut

Are engine mounts OK?

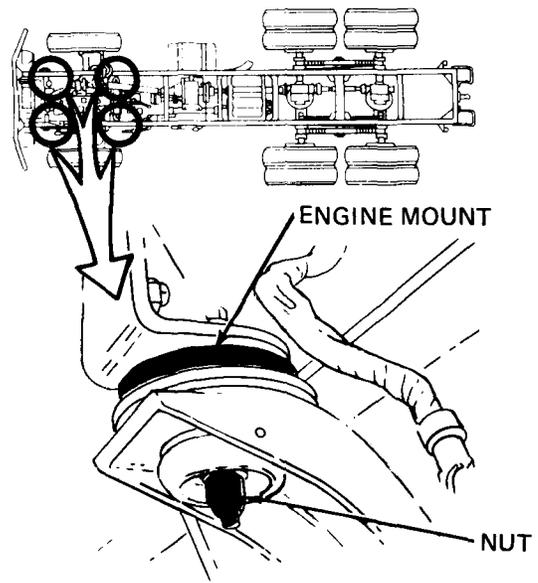

YES

NO

5

Diagram showing the engine being jacked up with a hydraulic jack. Labels include 'CLUTCH HOUSING', 'JACKING POINT', and 'HYDRAULIC JACK'. A 'YES' and 'NO' path is shown at the top of the diagram.

- Replace broken engine mount
 - Refer to Vol 3, chapter 2, para 2-4
- Put back missing engine mount nut
 - Put a hydraulic jack under jacking point and raise jack until weight is removed from engine mount
 - Put correct nut onto engine mount and screw on until hand tight
 - Using two 7/8-inch wrenches tighten engine mount
- Tighten loose engine mount nut
 - Using two 7/8-inch wrenches tighten engine mount

Figure 33-4 (Sheet 3 of 4)

GO

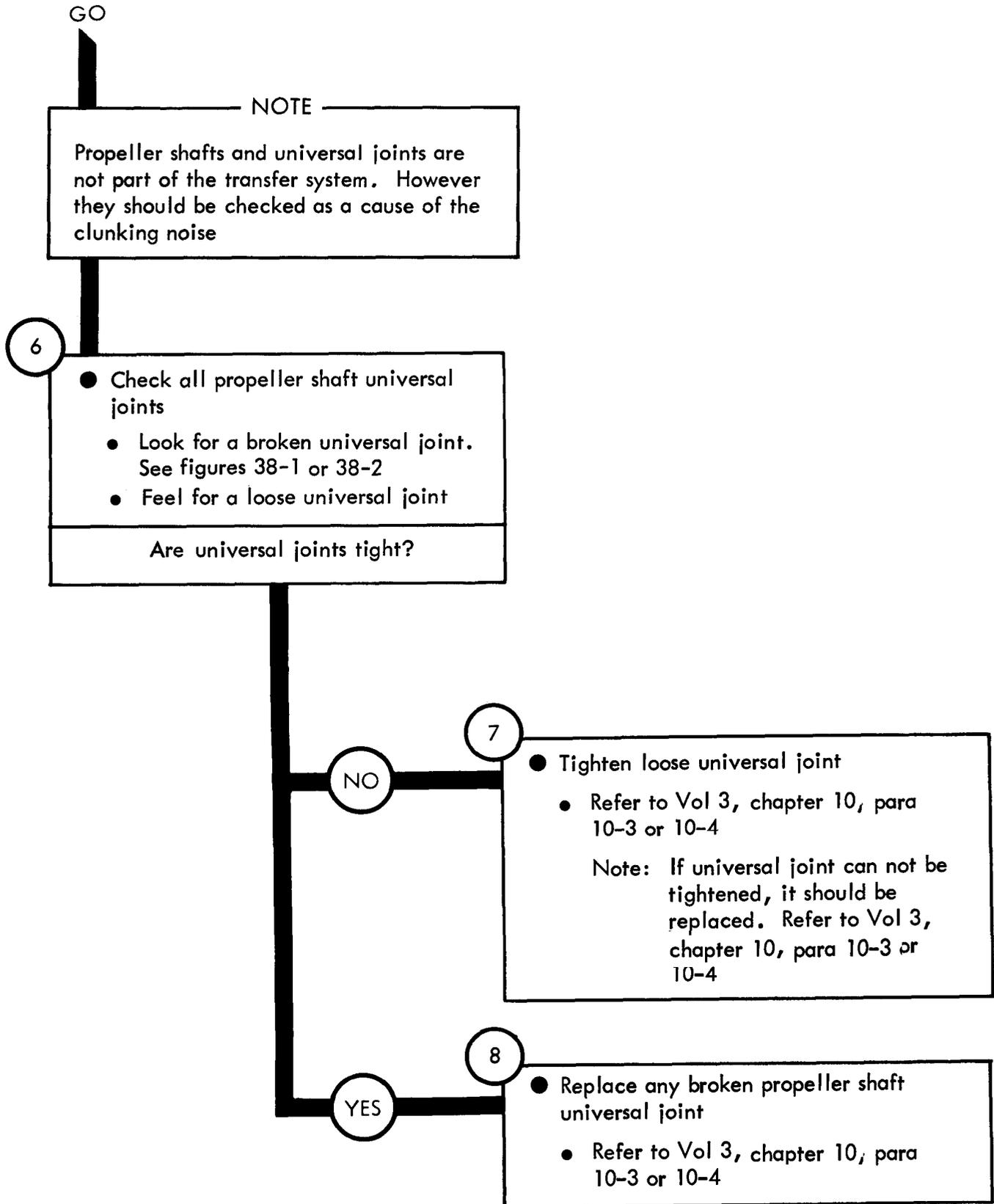

TA 114793

Figure 33-4 (Sheet 4 of 4)

CHAPTER 34

TRANSFER SYSTEM TROUBLESHOOTING SUMMARY

34-1. GENERAL. This chapter gives a summary of troubleshooting procedures given in chapter 33 for the transfer system.

34-2. PROCEDURES. The summary in this chapter covers all fault symptoms found in the detailed troubleshooting procedures. Chapter 7 outlines a sample troubleshooting procedure. The summary procedures are based on the "what-to-do" portions of the detailed procedures and do not include the "how-to-do-it" instructions. Warnings, cautions, and notes are given where needed.

TRANSFER SYSTEM TROUBLESHOOTING SUMMARY

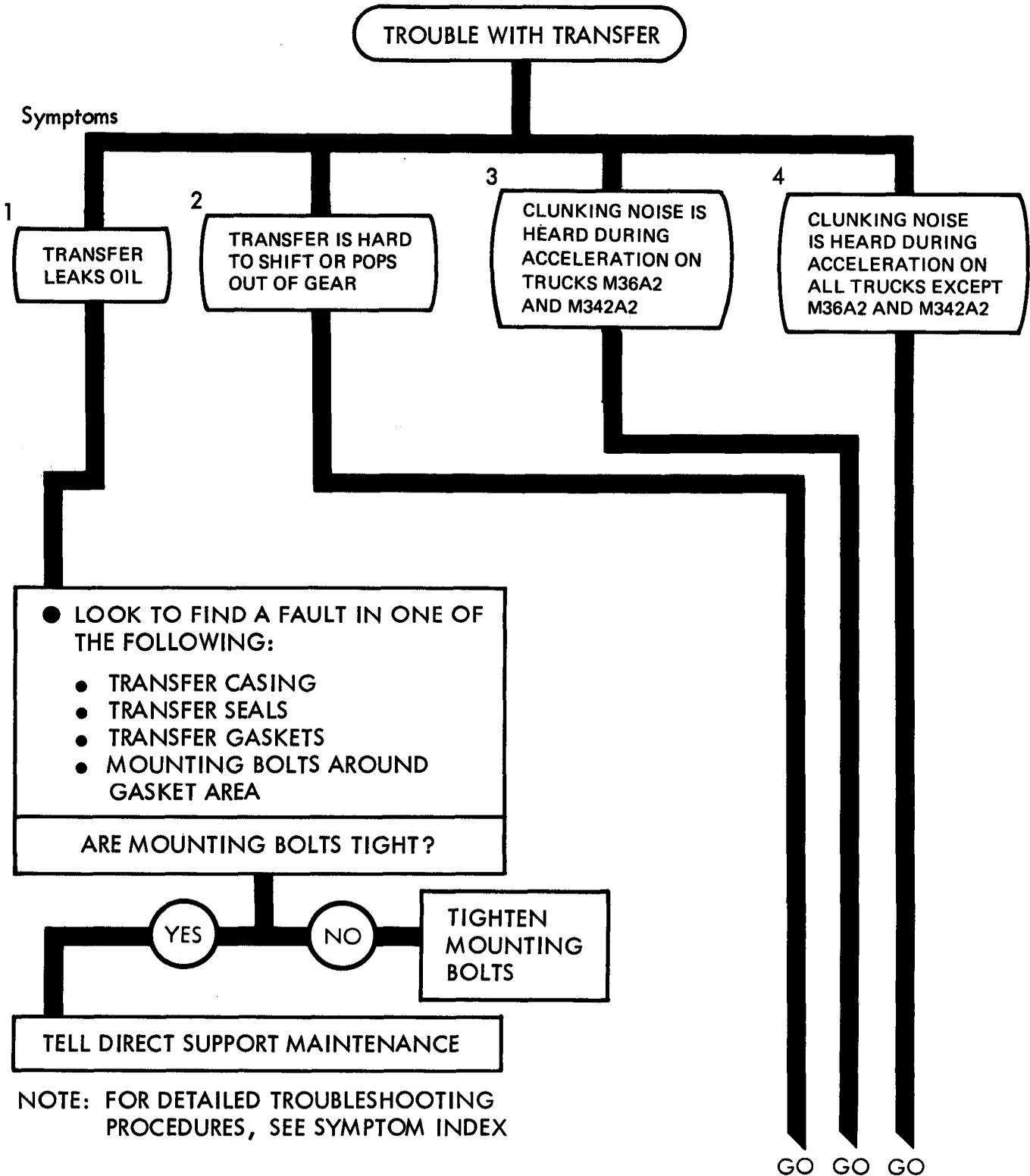
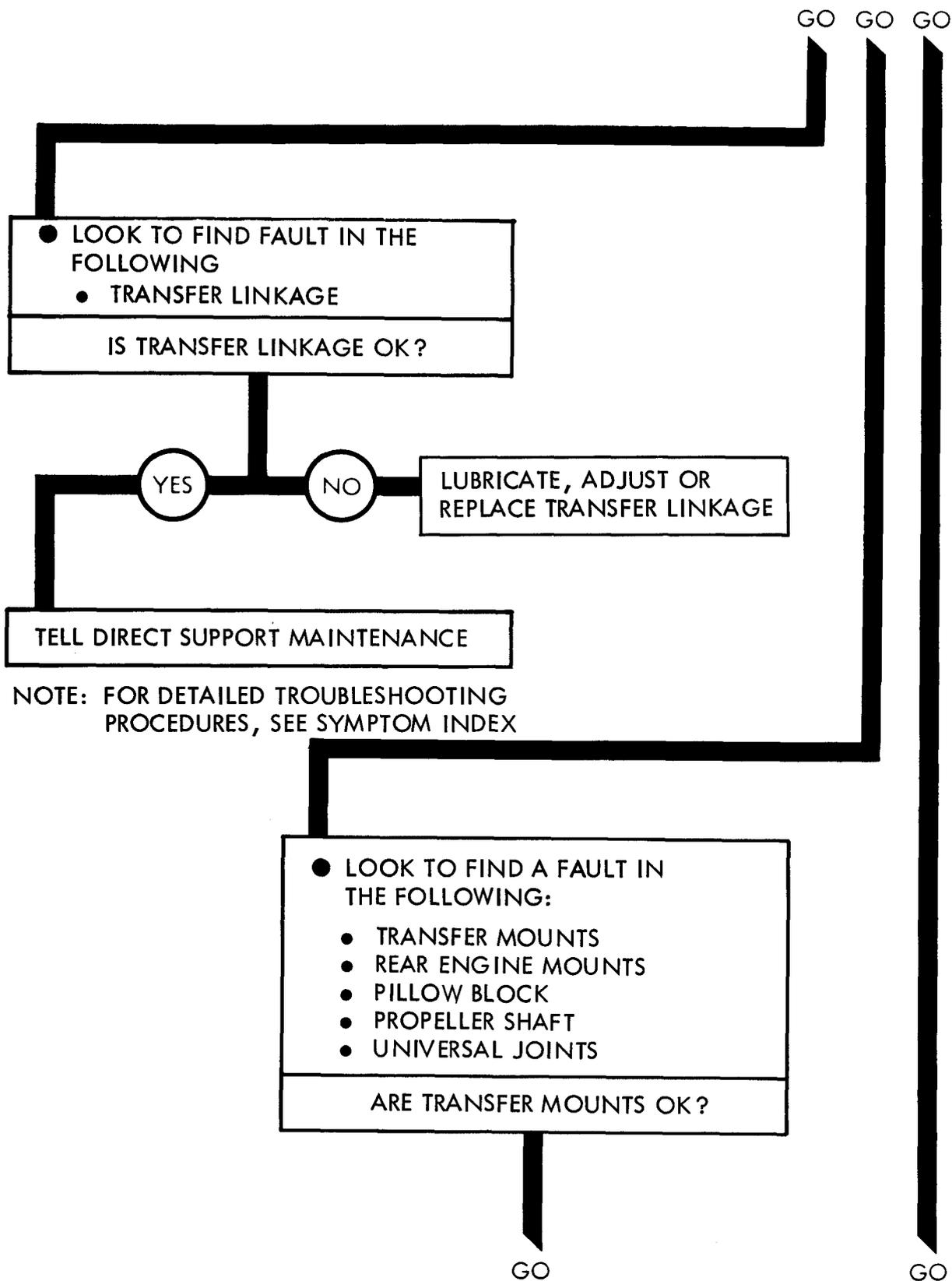

Figure 34-1 (Sheet 1 of 3)

TA 114794



NOTE: FOR DETAILED TROUBLESHOOTING PROCEDURES, SEE SYMPTOM INDEX

Figure 34-1 (Sheet 2 of 3)

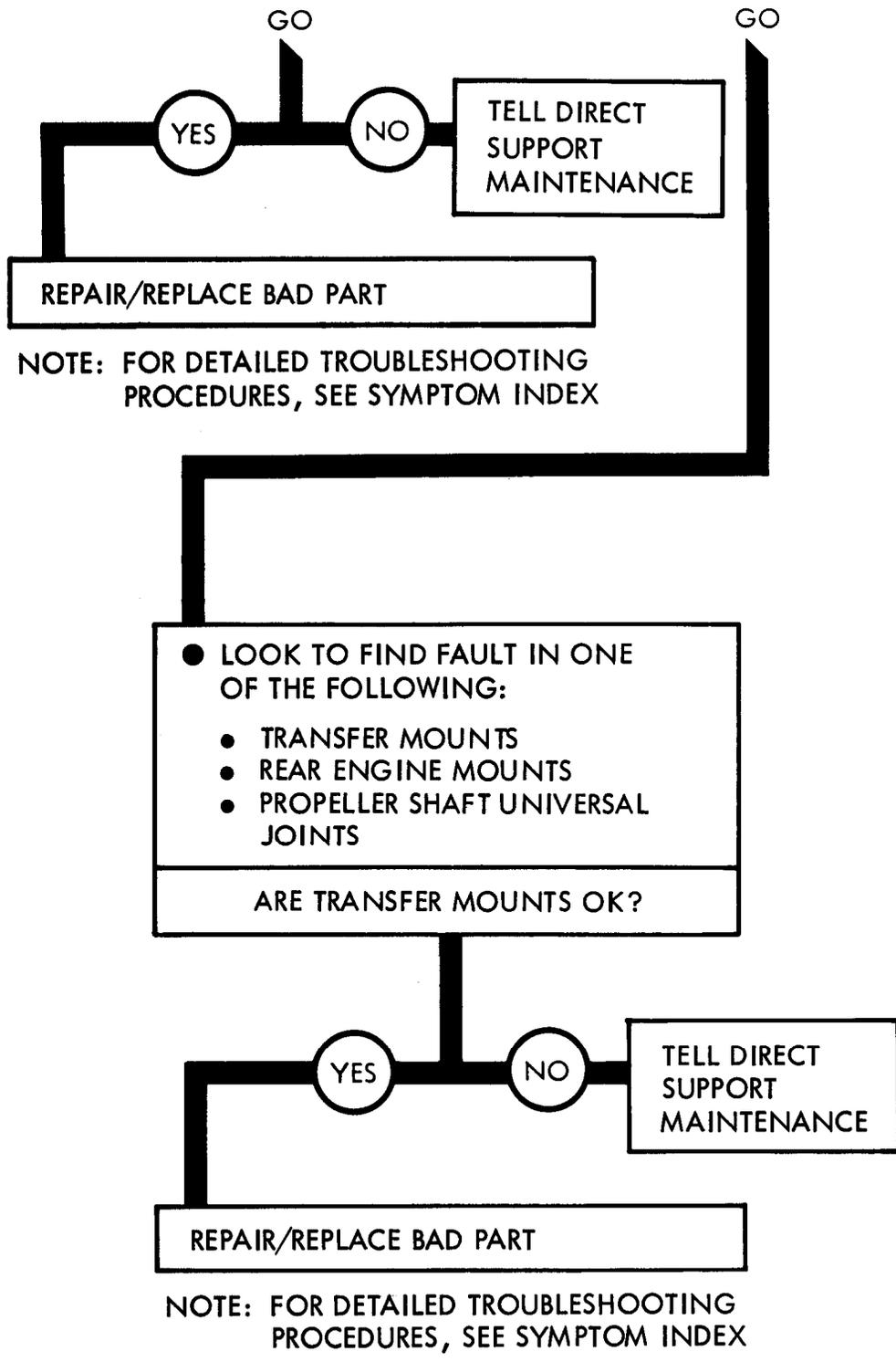

Figure 34-1 (Sheet 3 of 3)

CHAPTER 35

TRANSFER SYSTEM CHECKOUT PROCEDURES

35-1. GENERAL. This chapter gives procedures for checking out the system after troubleshooting and repair have been done. Procedures are set up in flow chart form showing the checkout steps in order and referring to the fault symptom index when the system does not check out.

TRANSFER SYSTEM CHECKOUT

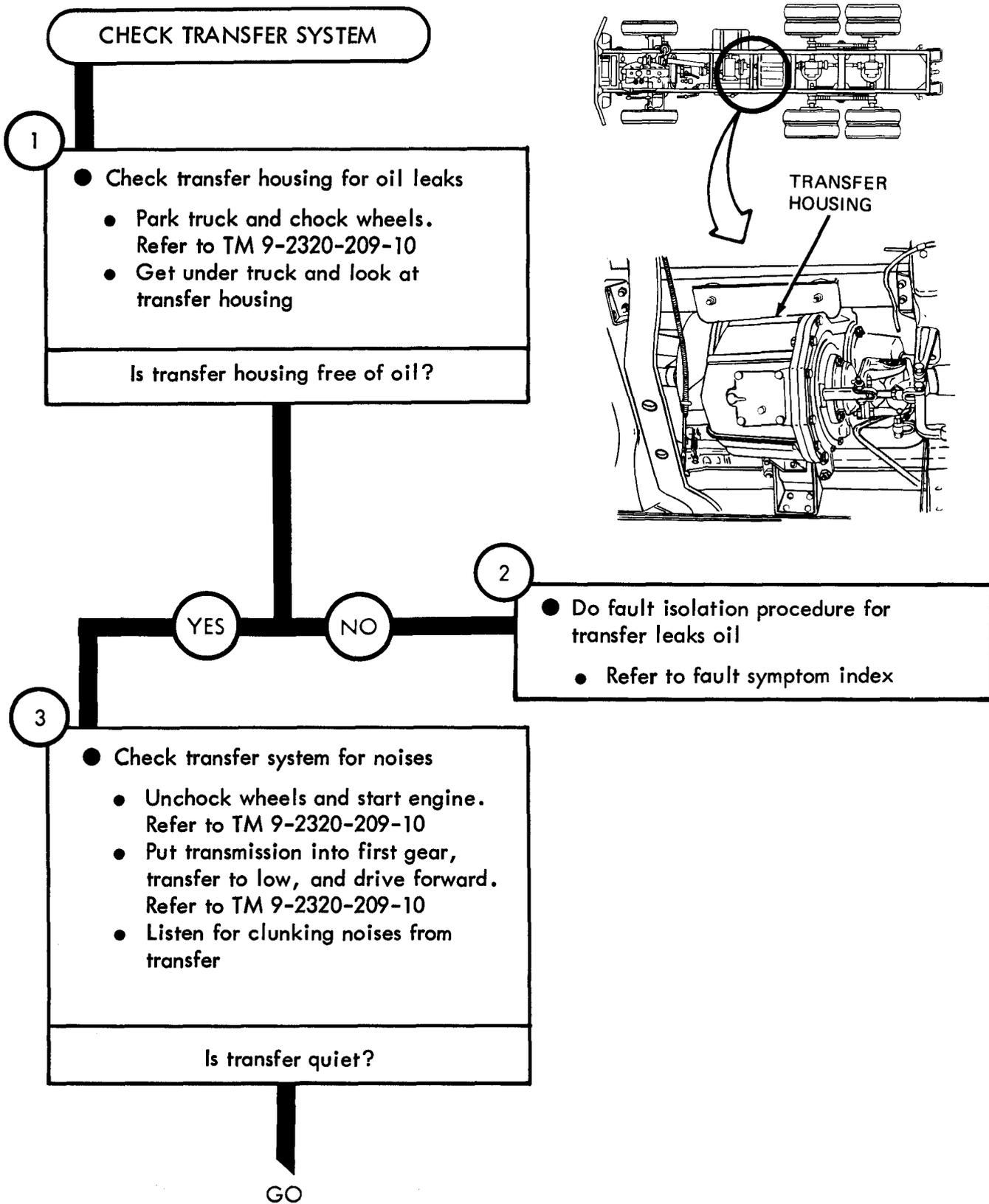

Figure 35-1 (Sheet 1 of 2)

TA 114797

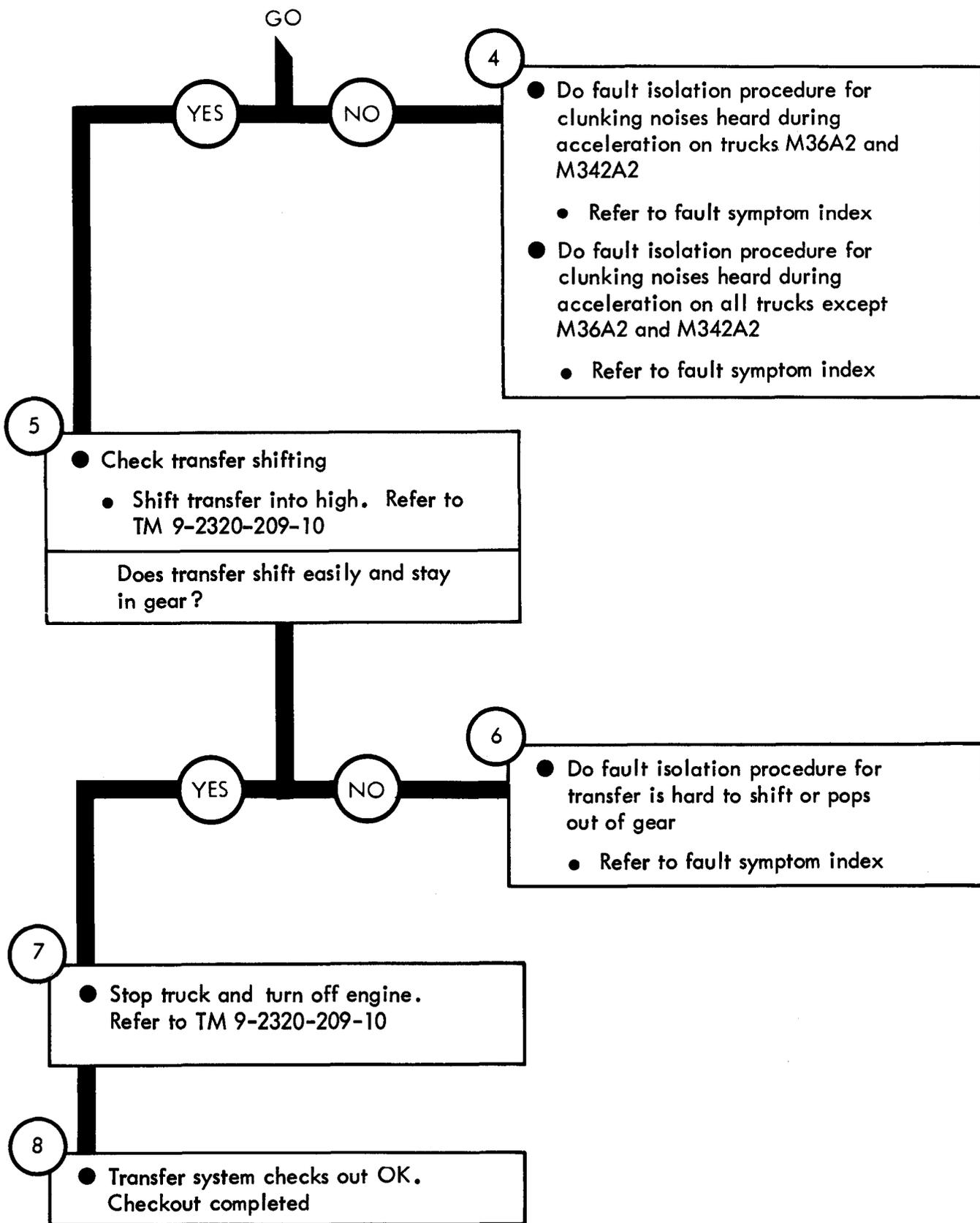

Figure 35-1 (Sheet 2 of 2)

CHAPTER 36

PROPELLER SHAFT SYSTEM TROUBLESHOOTING

36-1. EQUIPMENT ITEMS COVERED. This chapter gives equipment troubleshooting procedures for the propeller shaft system, for which there are authorized corrective maintenance tasks at the organizational maintenance level.

36-2. EQUIPMENT ITEMS NOT COVERED. All equipment items for which corrective maintenance is authorized at the organizational maintenance level are covered in this chapter.

PROPELLER SHAFT SYSTEM TROUBLESHOOTING

Symptom

1 CLUNKING NOISE HEARD DURING ACCELERATION ON TRUCKS M36A2 AND M342A2

- 1
- Make truck ready for work on propeller shafts
 - Park truck. Refer to TM9-2320-209-10
 - Chock wheels

NOTE

Transfer mounts are not part of the propeller shaft system. However they should be checked as a cause of the clunking noise

- 2
- Check transfer mounts
 - Crawl under truck
 - Look for signs that the transfer shifted its position
 - Look for a broken transfer mount
 - Look for missing transfer mounting nuts or bolts
 - Feel for loose transfer mount nuts
- Are transfer mounts OK?

GO

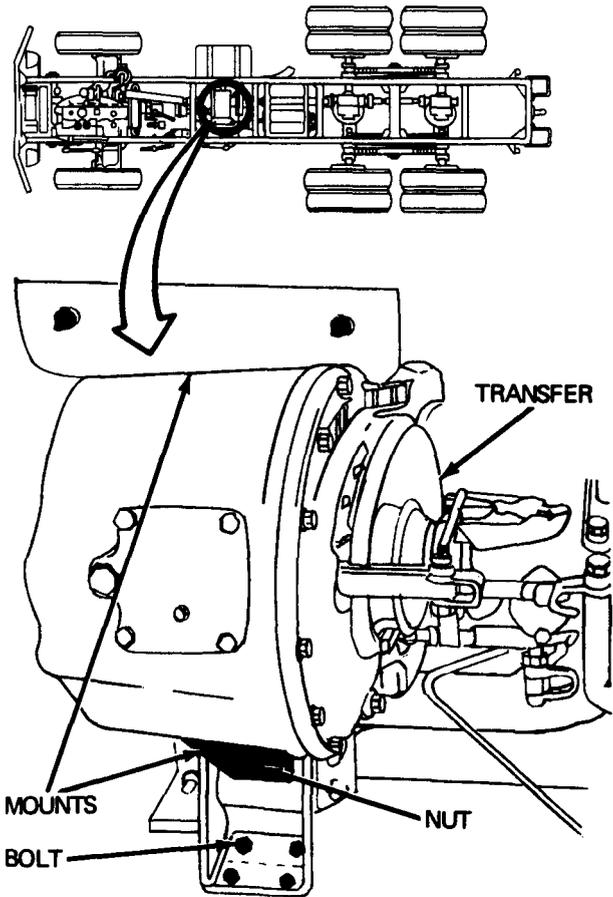

Figure 36-1 (Sheet 1 of 5)

TA 114799

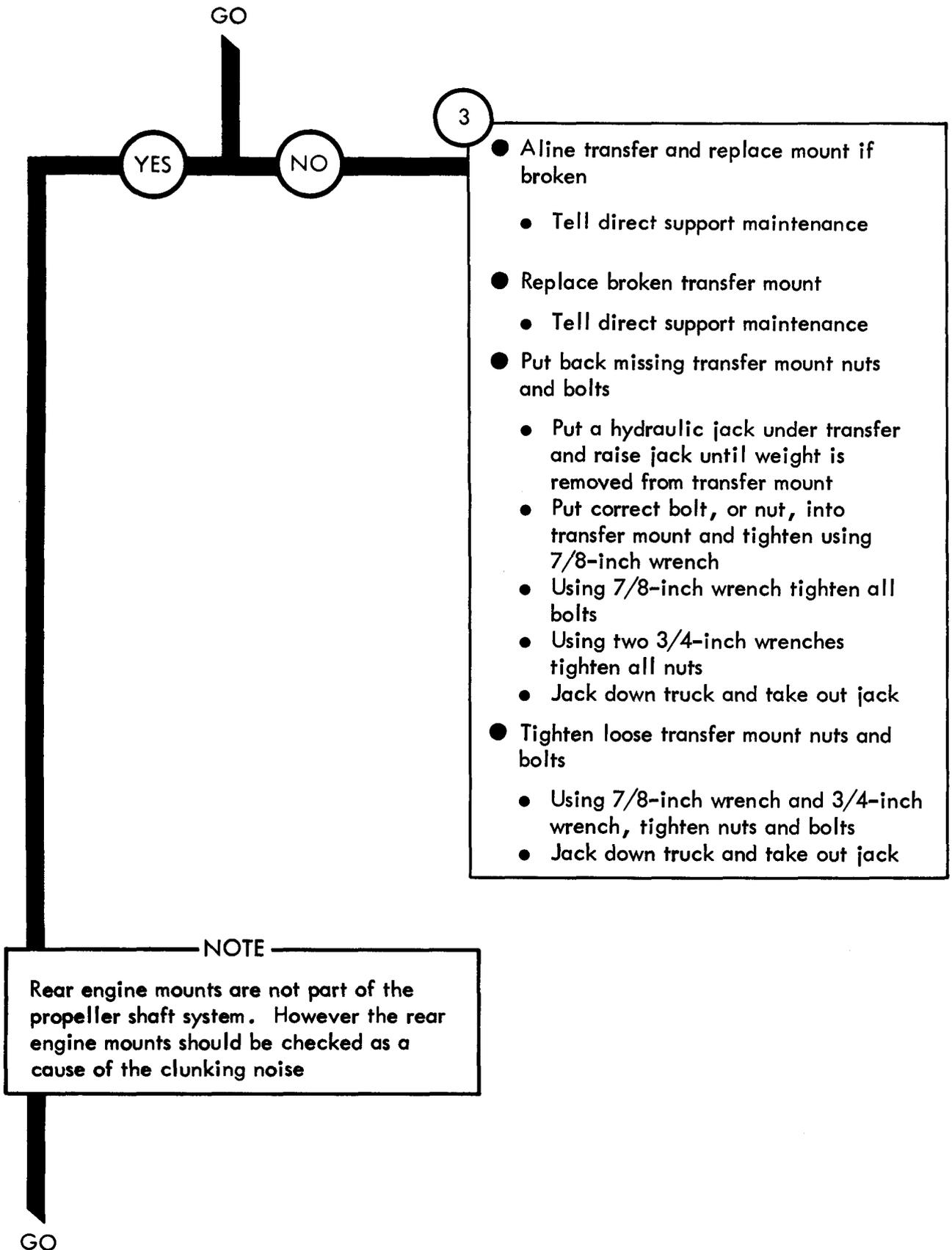
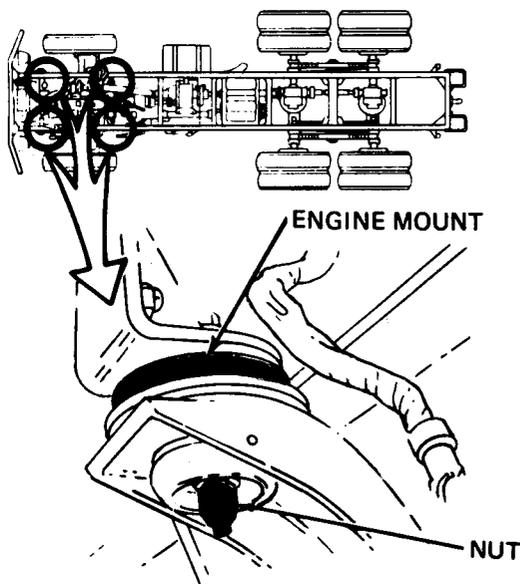

Figure 36-1 (Sheet 2 of 5)

GO

4

- Check rear engine mounts
 - Look for a broken engine mount
 - Look for a missing engine mount nut
 - Using 15/16-inch wrench feel for a loose nut
- Are engine mounts OK?



5

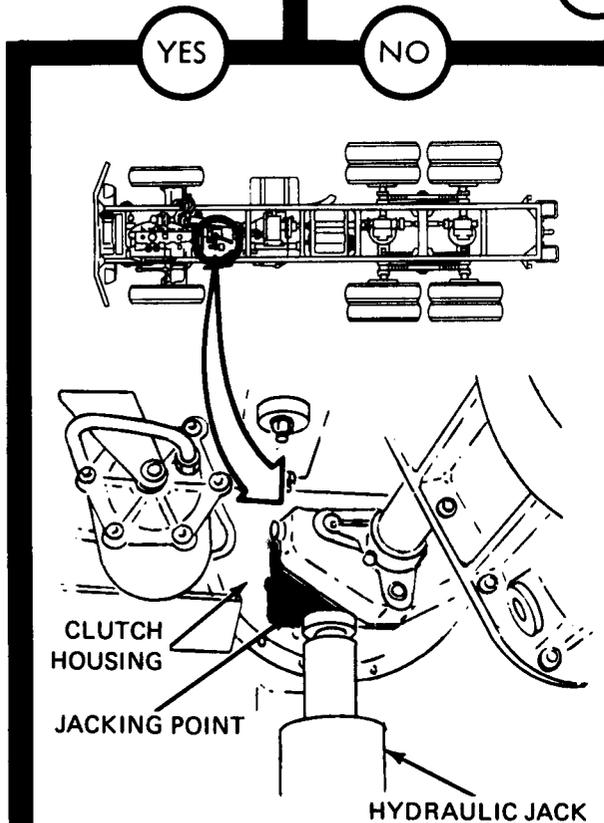

- Replace broken engine mount
 - Refer to Vol 3, chapter 2, para 2-4
- Put back missing engine mount nut
 - Put a hydraulic jack under jacking point and raise jack until weight is removed from engine mount
 - Put correct nut onto engine mount and screw on until hand tight
 - Using two 7/8-inch wrenches tighten engine mount
- Tighten loose engine mount nut
 - Using two 7/8-inch wrenches tighten engine mount

GO

Figure 36-1 (Sheet 3 of 5)

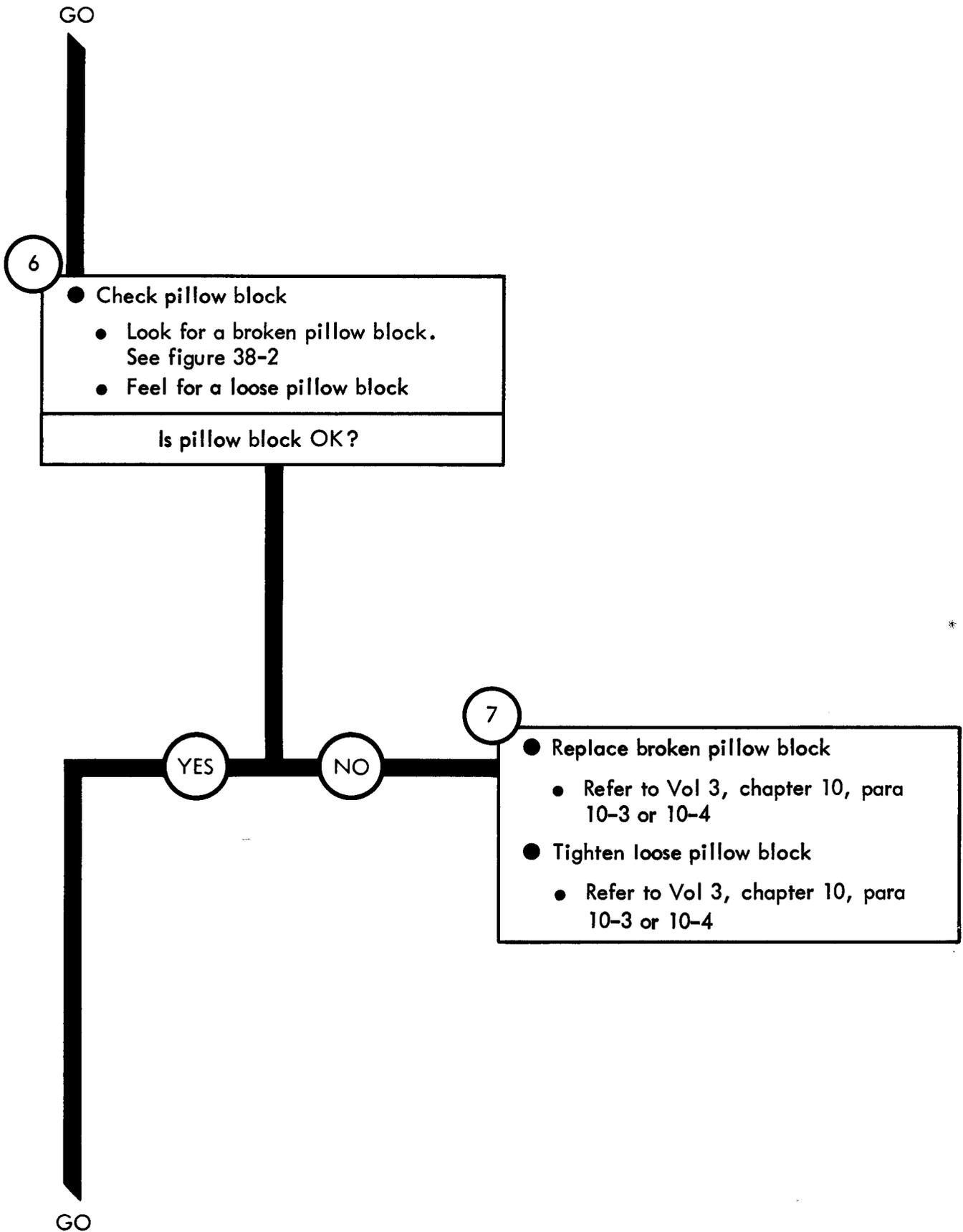

Figure 36-1 (Sheet 4 of 5)

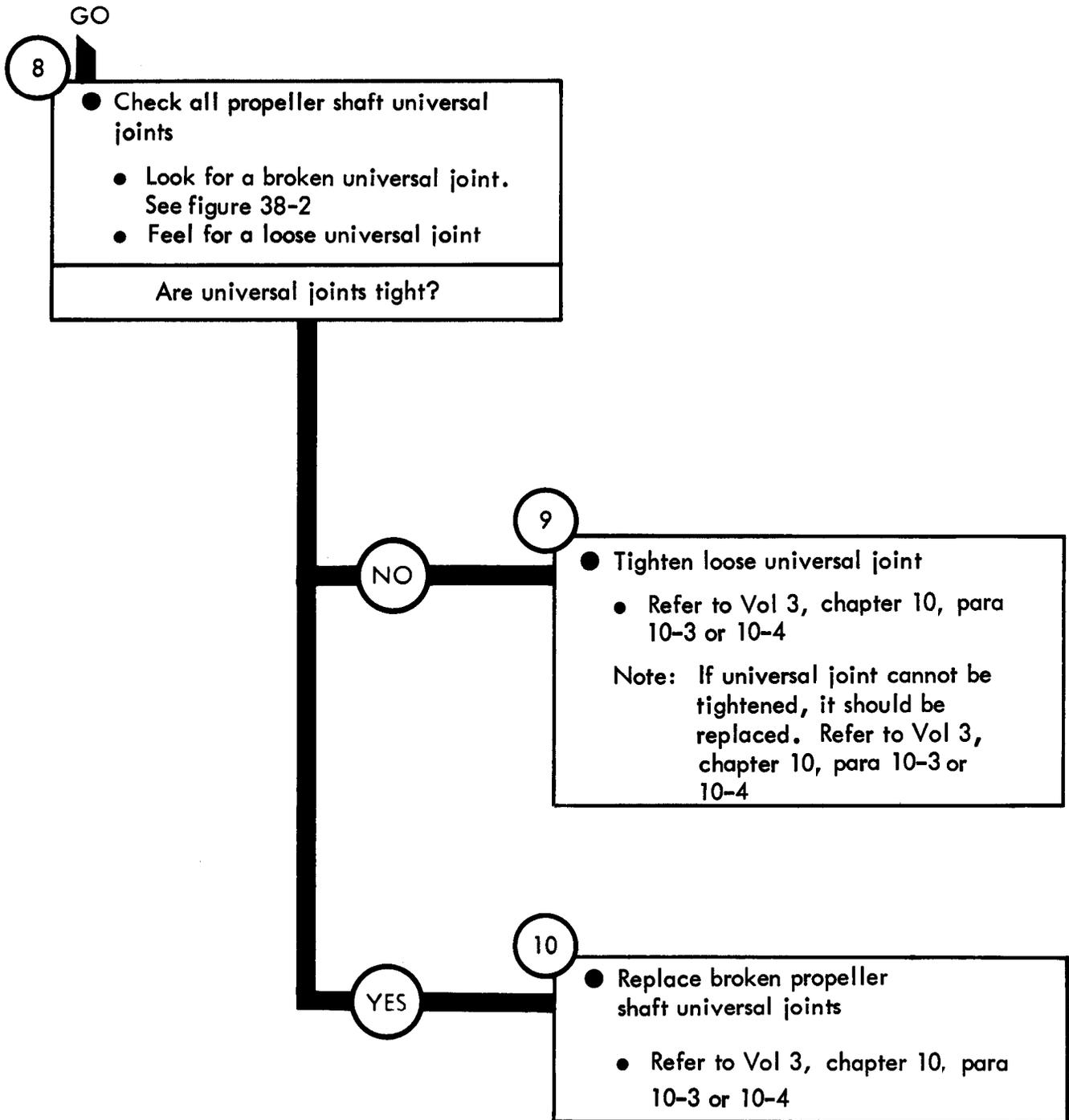

Figure 36-1 (Sheet 5 of 5)

Symptom

2

CLUNKING NOISE HEARD DURING ACCELERATION ON ALL TRUCKS EXCEPT M36A2 AND M342A2

1

- Make truck ready for work on propeller shafts
 - Park truck. Refer to TM 9-2320-209-10

NOTE

Transfer mounts are not part of the propeller shaft system. However the transfer mounts should be checked as a cause of the clunking noise

2

- Check transfer mounts
 - Crawl under truck
 - Look for signs that the transfer shifted its position
 - Look for a broken transfer mount
 - Look for missing transfer mounting nuts or bolts
 - Feel for loose transfer mount nuts

Are transfer mounts OK?

GO

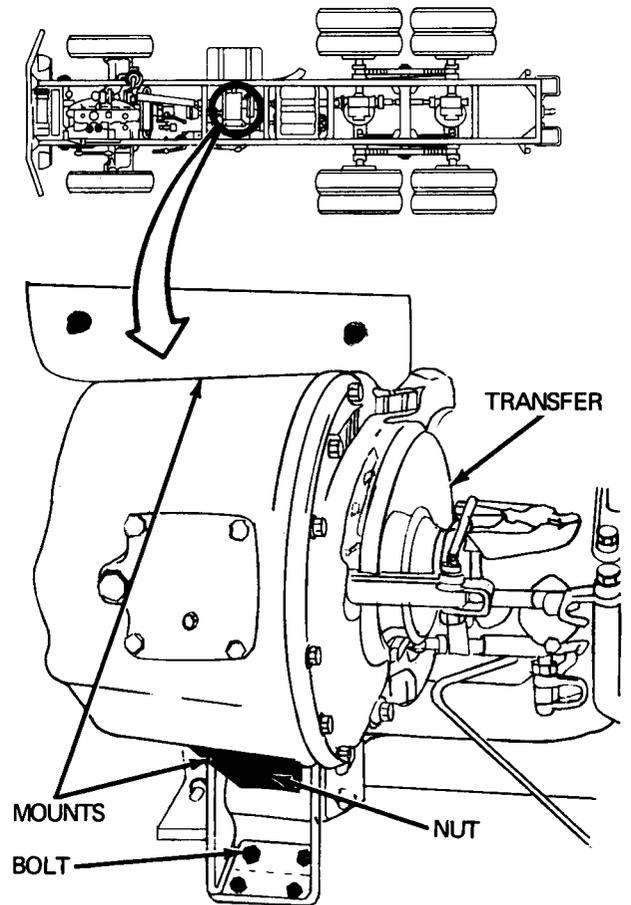
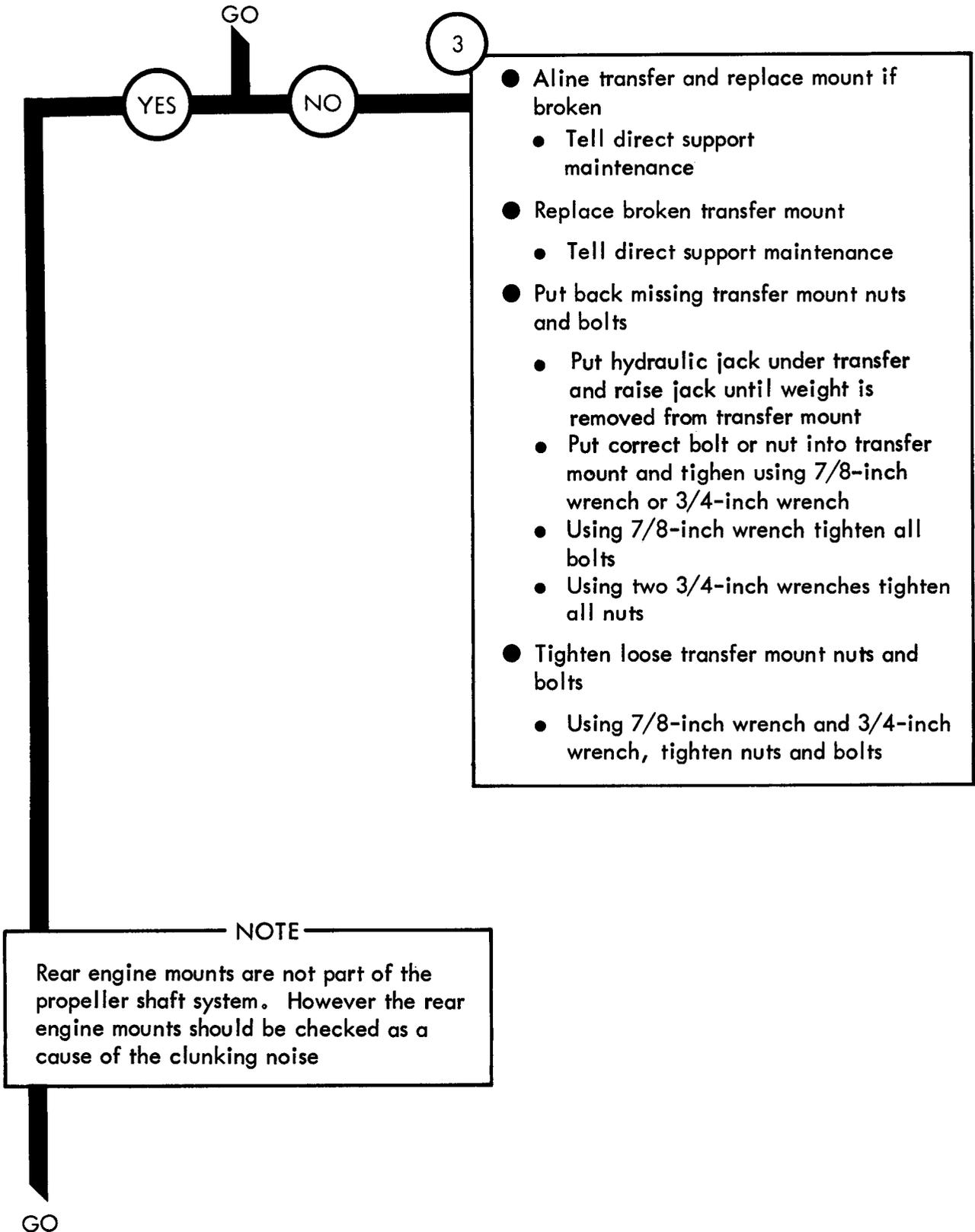
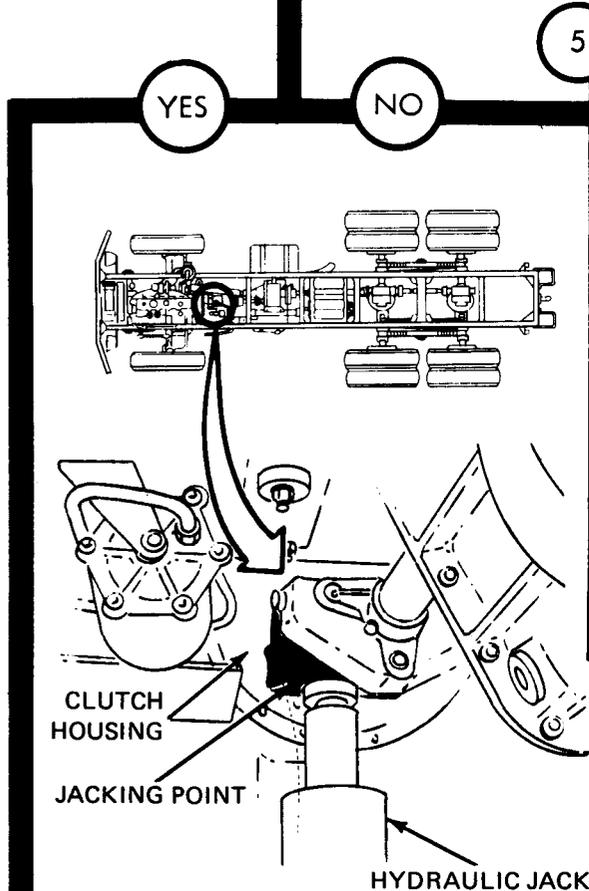
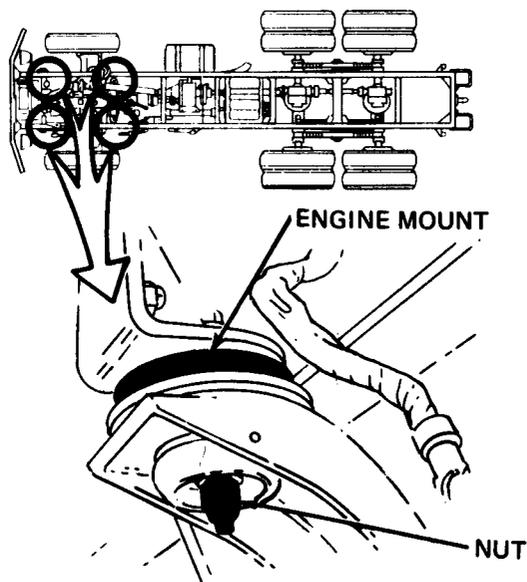
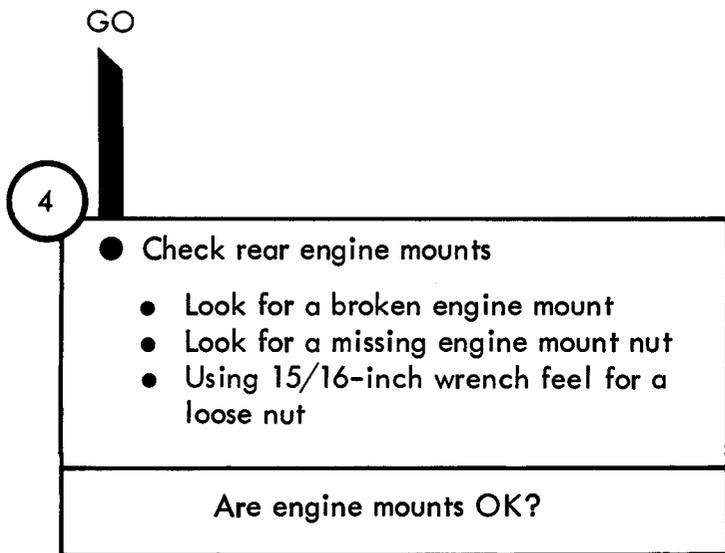

Figure 36-2 (Sheet 1 of 4)





- Replace broken engine mount
 - Refer to Vol 3, chapter 2, para 2-4
- Put back missing engine mount nut
 - Put a hydraulic jack under jacking point and raise jack until weight is removed from engine mount
 - Put correct nut onto engine mount and screw on until hand tight
 - Using two 7/8-inch wrenches tighten engine mount
- Tighten loose engine mount nut
 - Using two 7/8-inch wrenches tighten engine mount

GO

Figure 36-2 (Sheet 3 of 4)

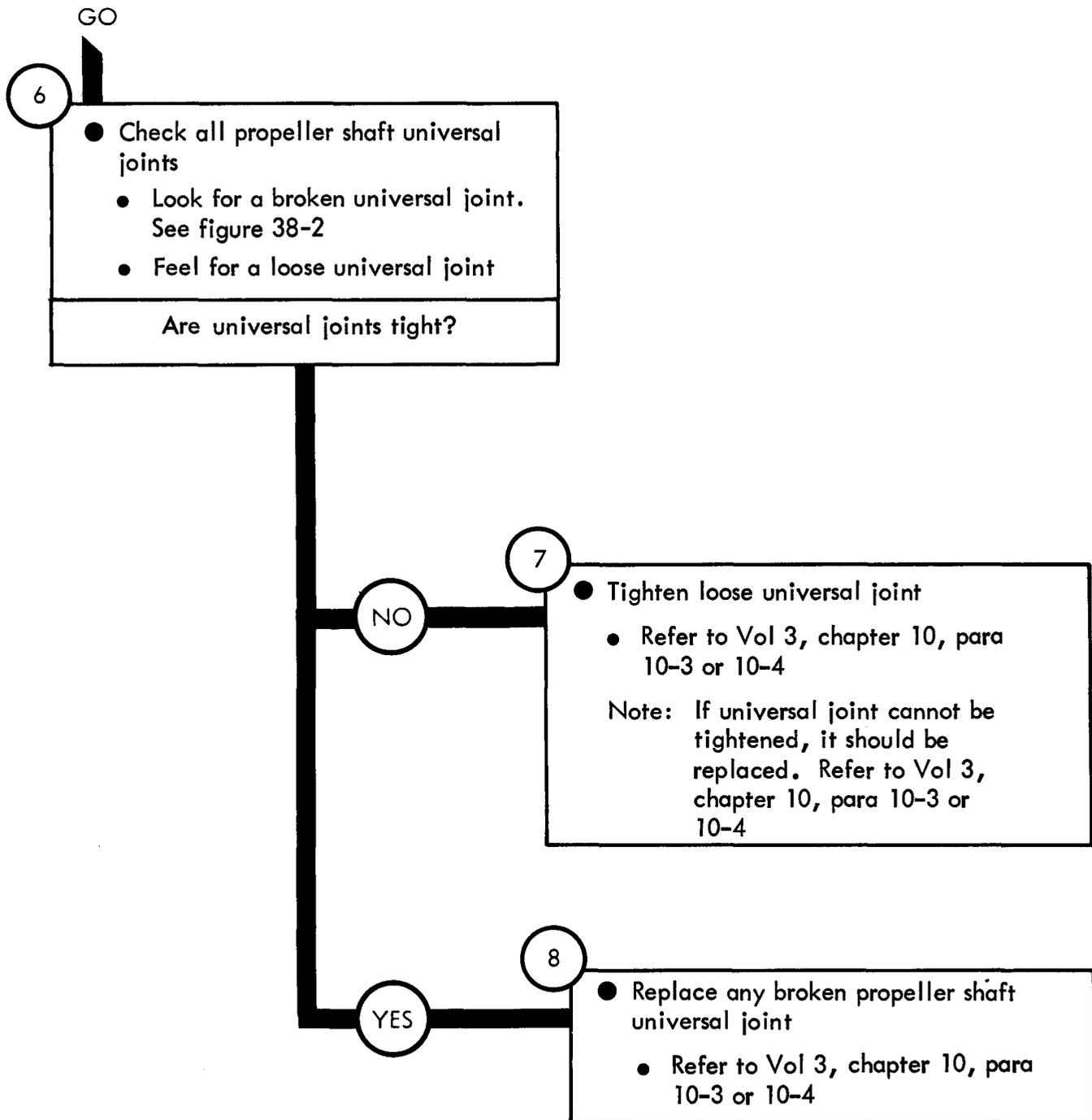

Figure 36-2 (Sheet 4 of 4)

CHAPTER 37

PROPELLER SHAFT SYSTEM TROUBLESHOOTING SUMMARY

37-1. GENERAL. This chapter gives a summary of troubleshooting procedures given in chapter 36 for the propeller shaft system.

37-2. PROCEDURES. The summary in this chapter covers all fault symptoms found in the detailed troubleshooting procedures. Chapter 7 outlines a sample troubleshooting procedure. The summary procedures are based on the "what-to-do" portions of the detailed procedures and do not include the "how-to-do-it" instructions. Warnings, cautions, and notes are given where needed.

PROPELLER SHAFT SYSTEM TROUBLESHOOTING SUMMARY

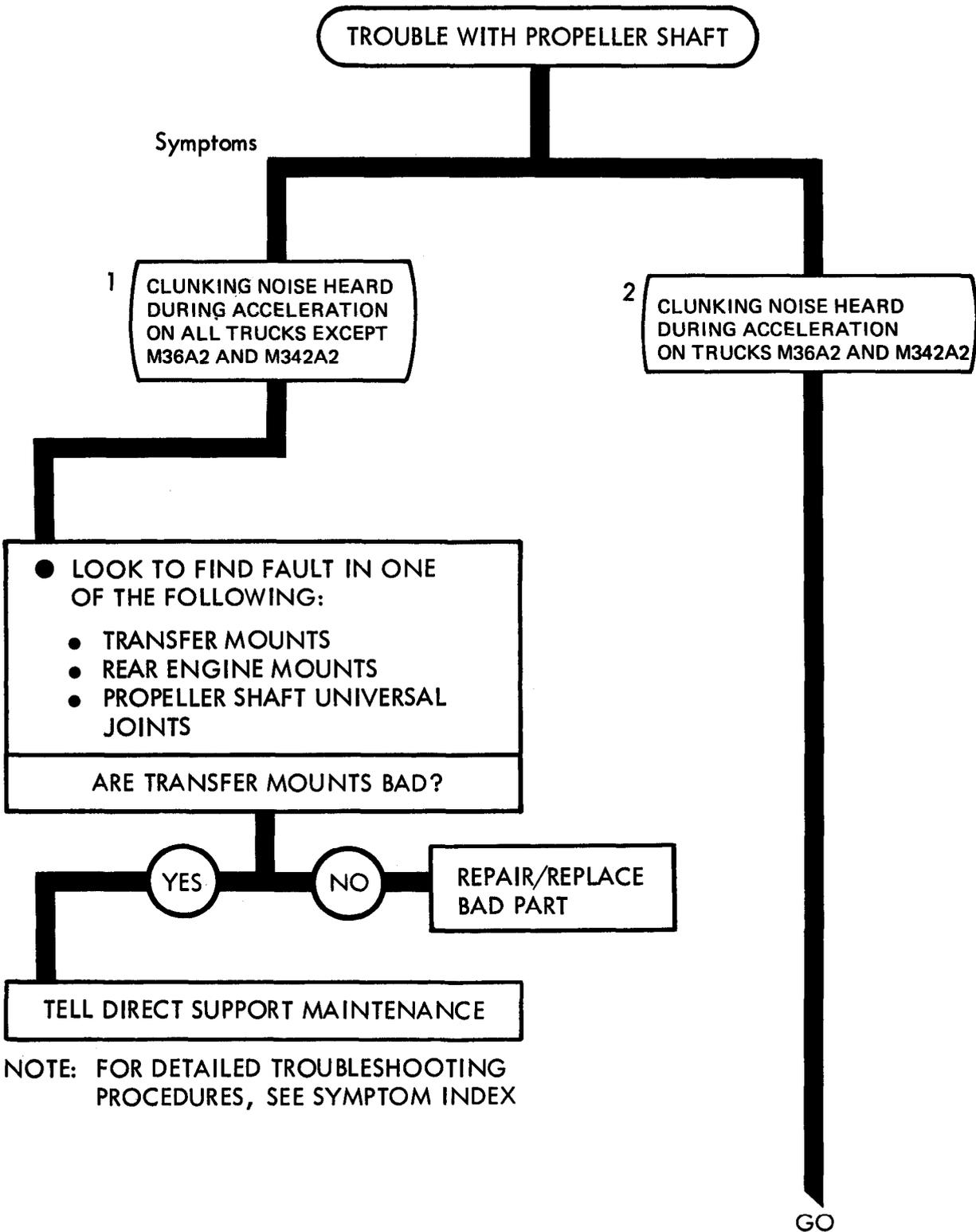

NOTE: FOR DETAILED TROUBLESHOOTING PROCEDURES, SEE SYMPTOM INDEX

Figure 37-1 (Sheet 1 of 2)

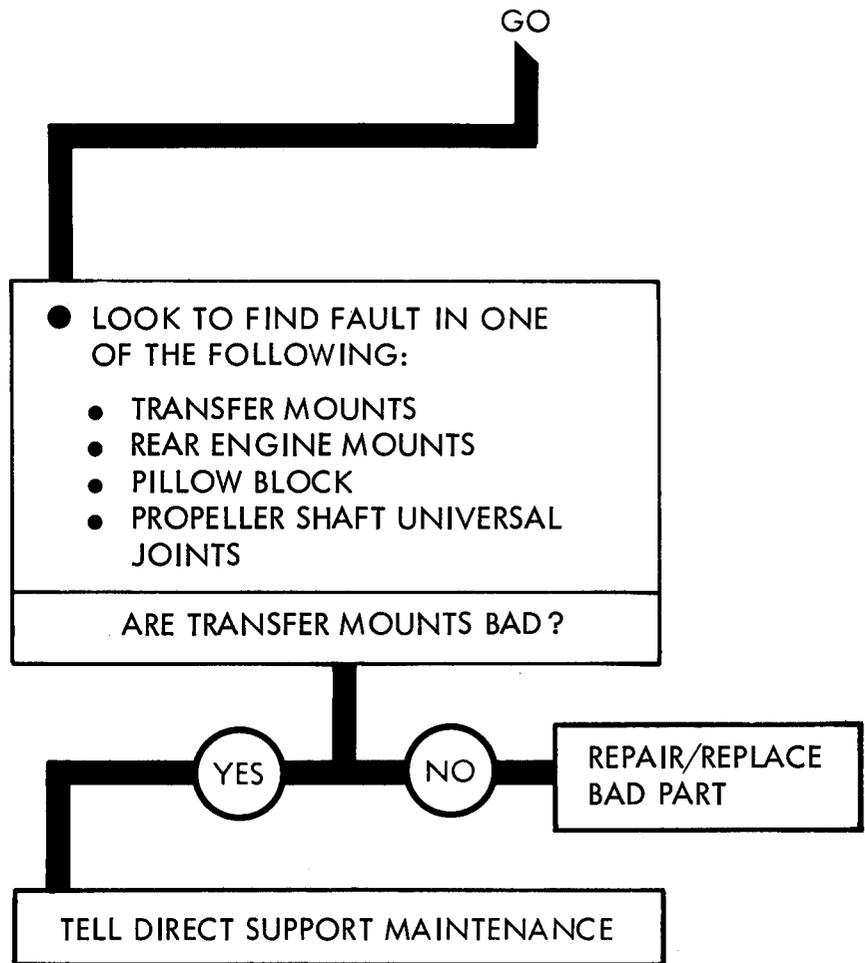

NOTE: FOR DETAILED TROUBLESHOOTING PROCEDURES, SEE SYMPTOM INDEX

CHAPTER 38

PROPELLER SHAFT SYSTEM SUPPORT DIAGRAMS

38-1. GENERAL. This chapter gives the diagrams you need when doing troubleshooting procedures in chapter 36. Table 3-1 is a complete listing of all support diagrams used in this manual.

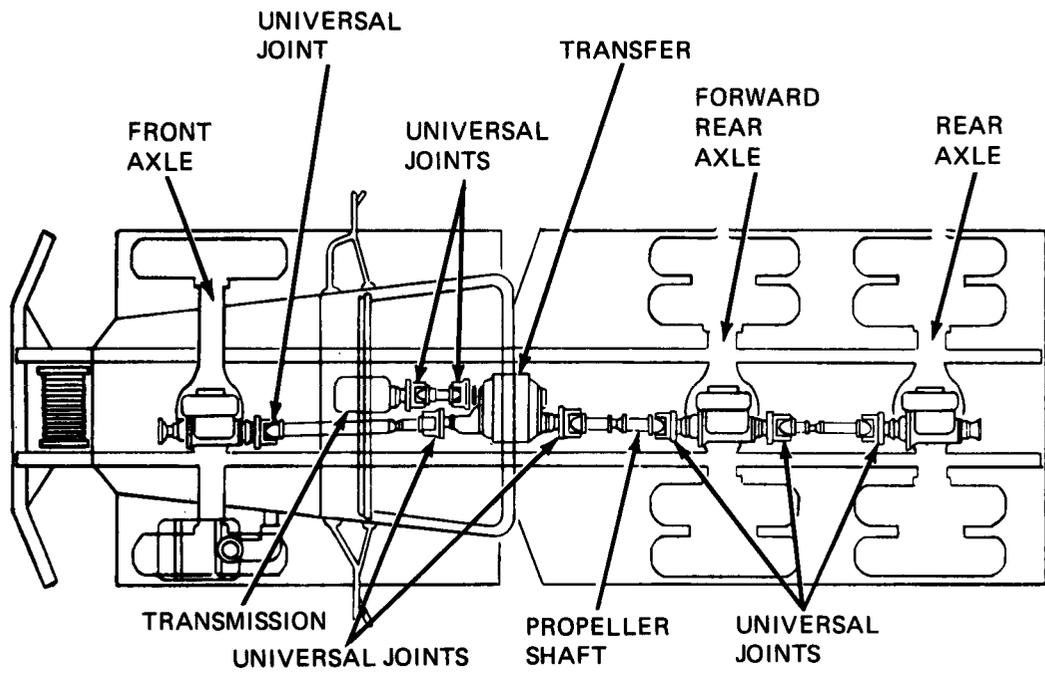

ON ALL TRUCKS EXCEPT M36A2 AND M342A2

TA 114810

Figure 38-1. Propeller Shaft System Support Diagram

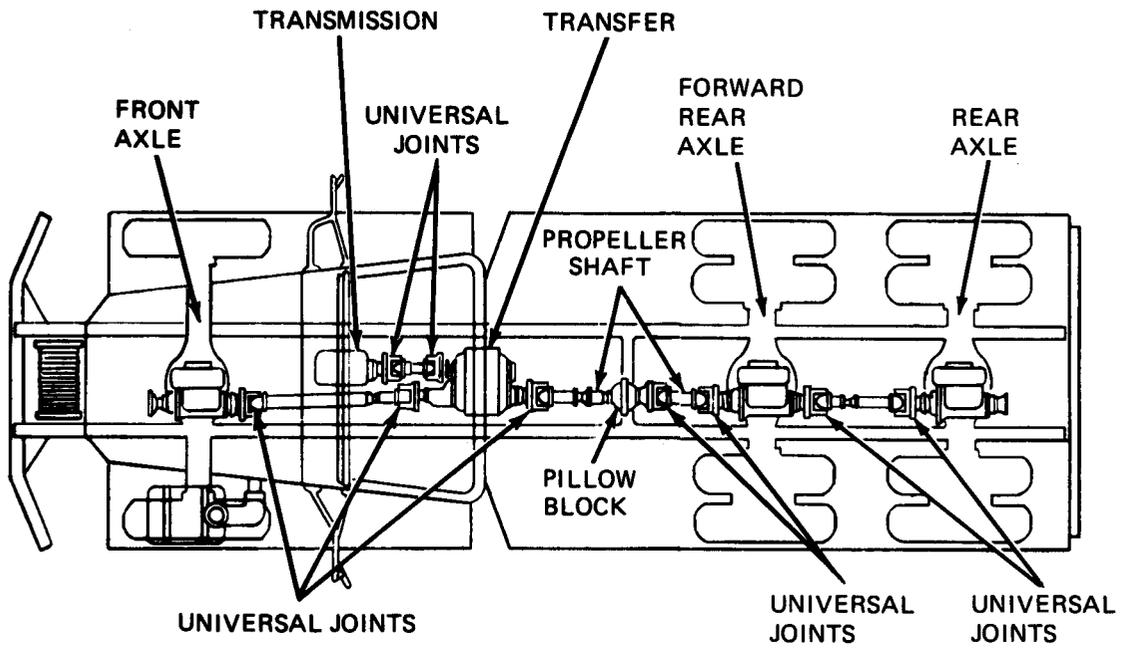

ON TRUCKS M36A2 AND M342A2

TA 114811

Figure 38-2. Propeller Shaft System Support Diagram

CHAPTER 39

FRONT AXLE SYSTEM TROUBLESHOOTING

39-1. EQUIPMENT ITEMS COVERED. This chapter gives equipment troubleshooting procedures for the front axle system, for which there are authorized corrective maintenance tasks at the organizational maintenance level.

39-2. EQUIPMENT ITEMS NOT COVERED. All equipment items for which corrective maintenance is authorized at the organizational maintenance level are covered in this chapter.

FRONT AXLE SYSTEM TROUBLESHOOTING

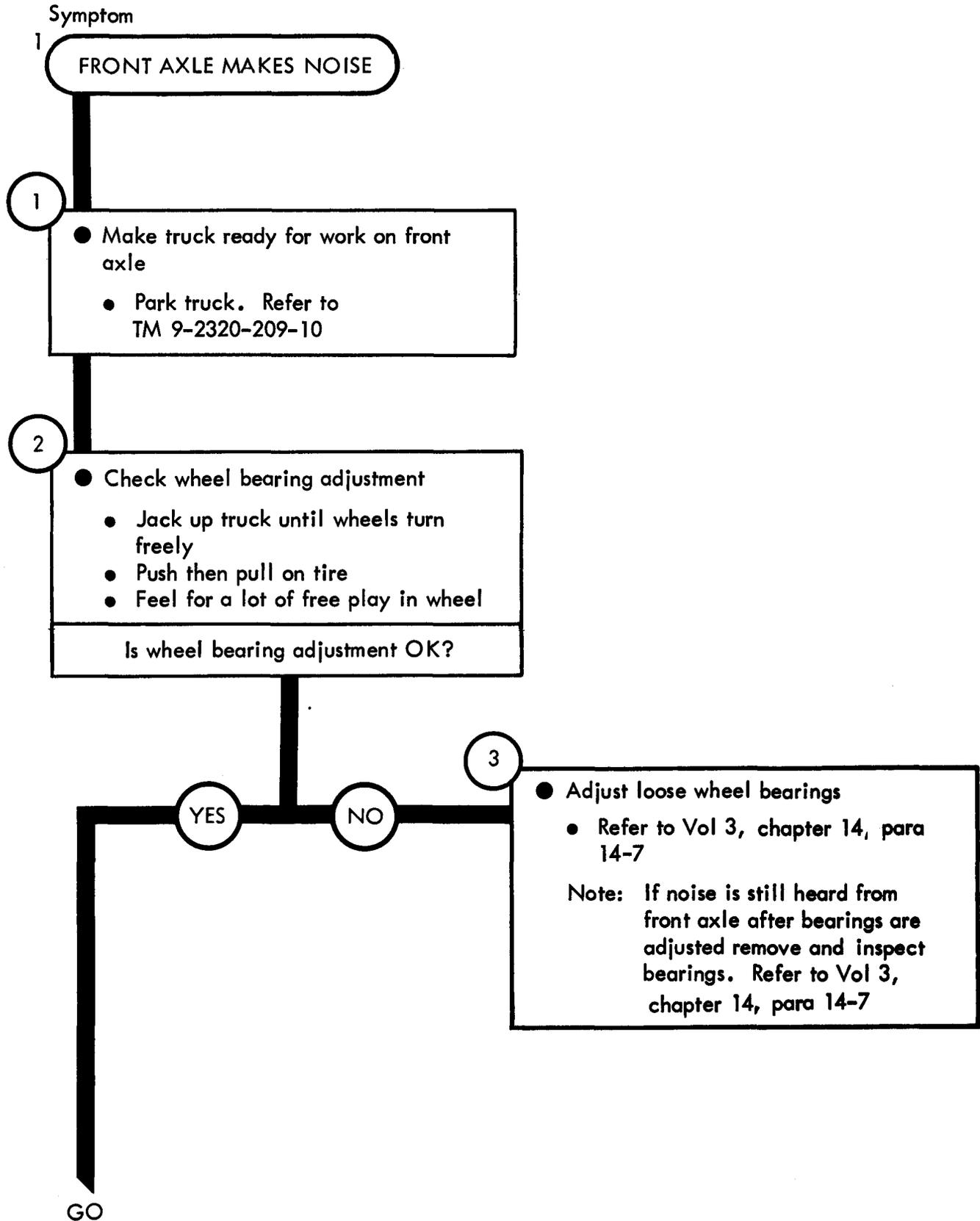

TA 114812

Figure 39-1 (Sheet 1 of 3)

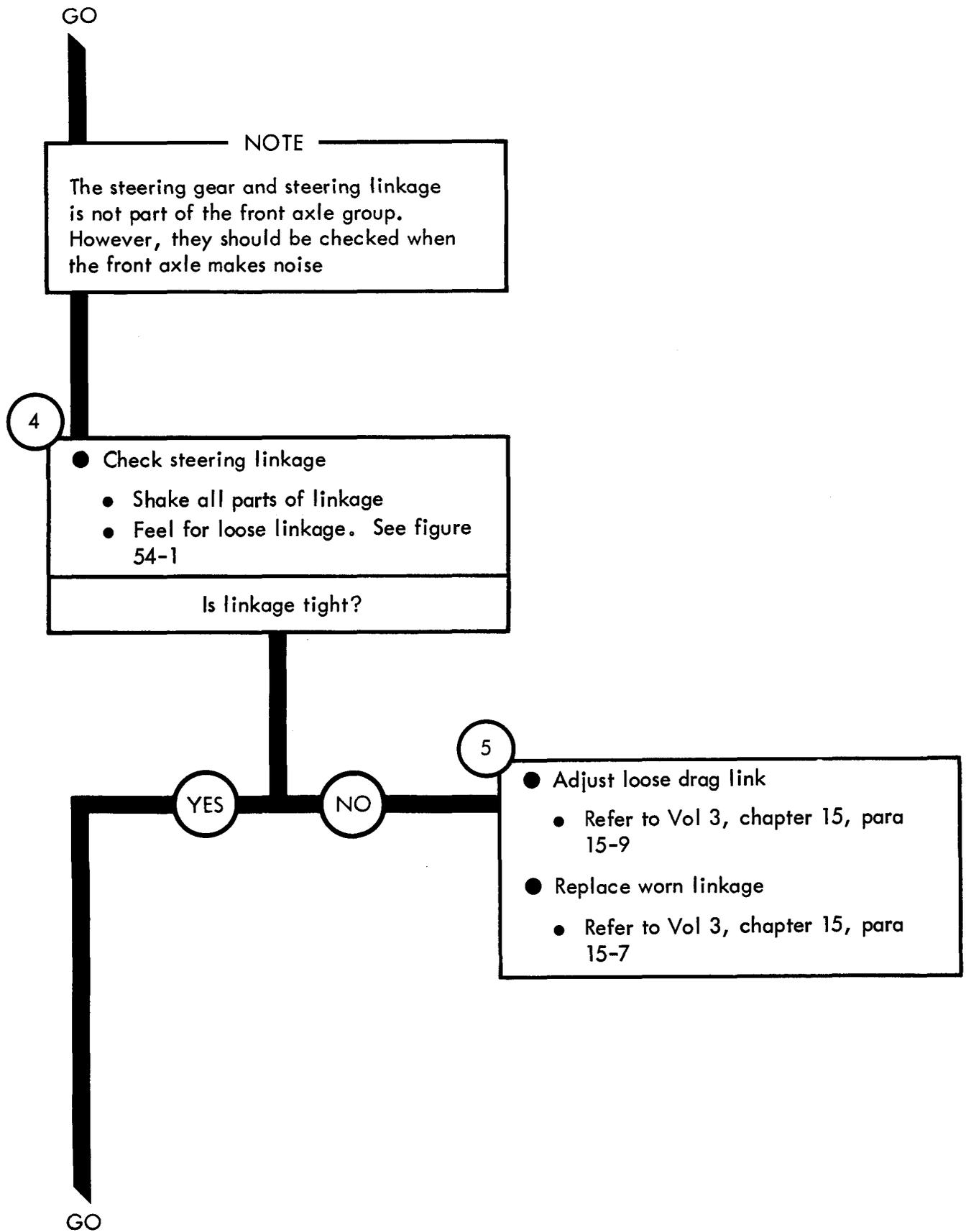

Figure 39-1 (Sheet 2 of 3)

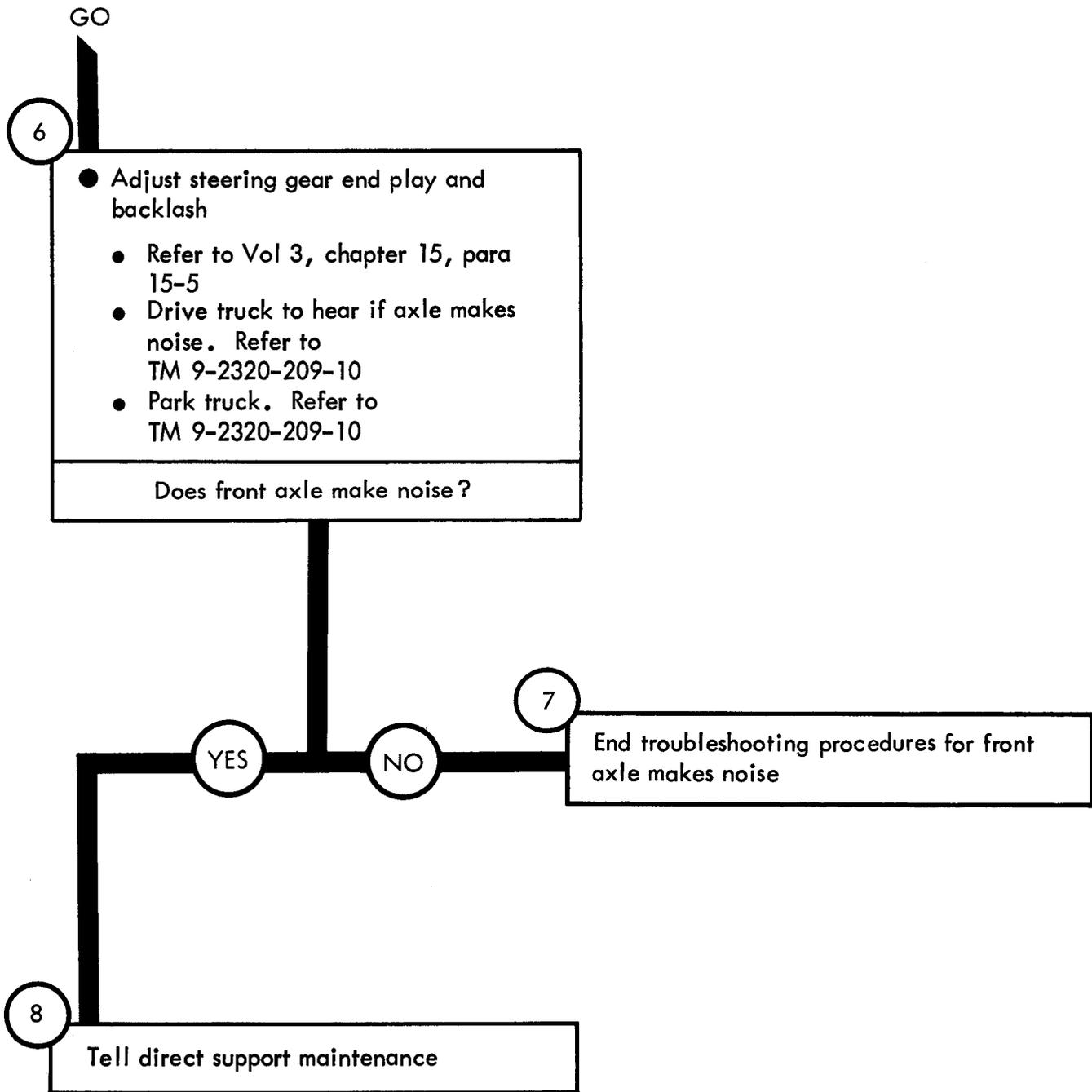

Figure 39-1 (Sheet 3 of 3)

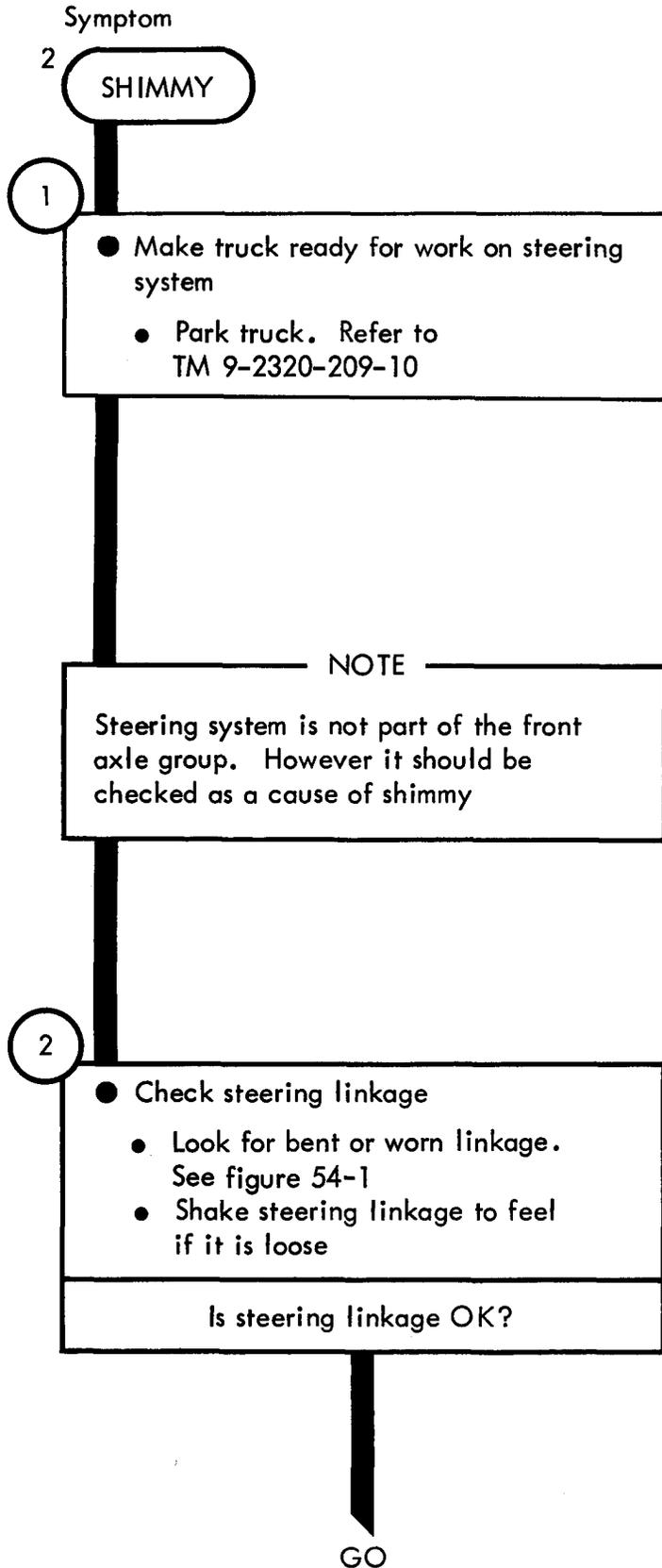

Figure 39-2 (Sheet 1 of 4)

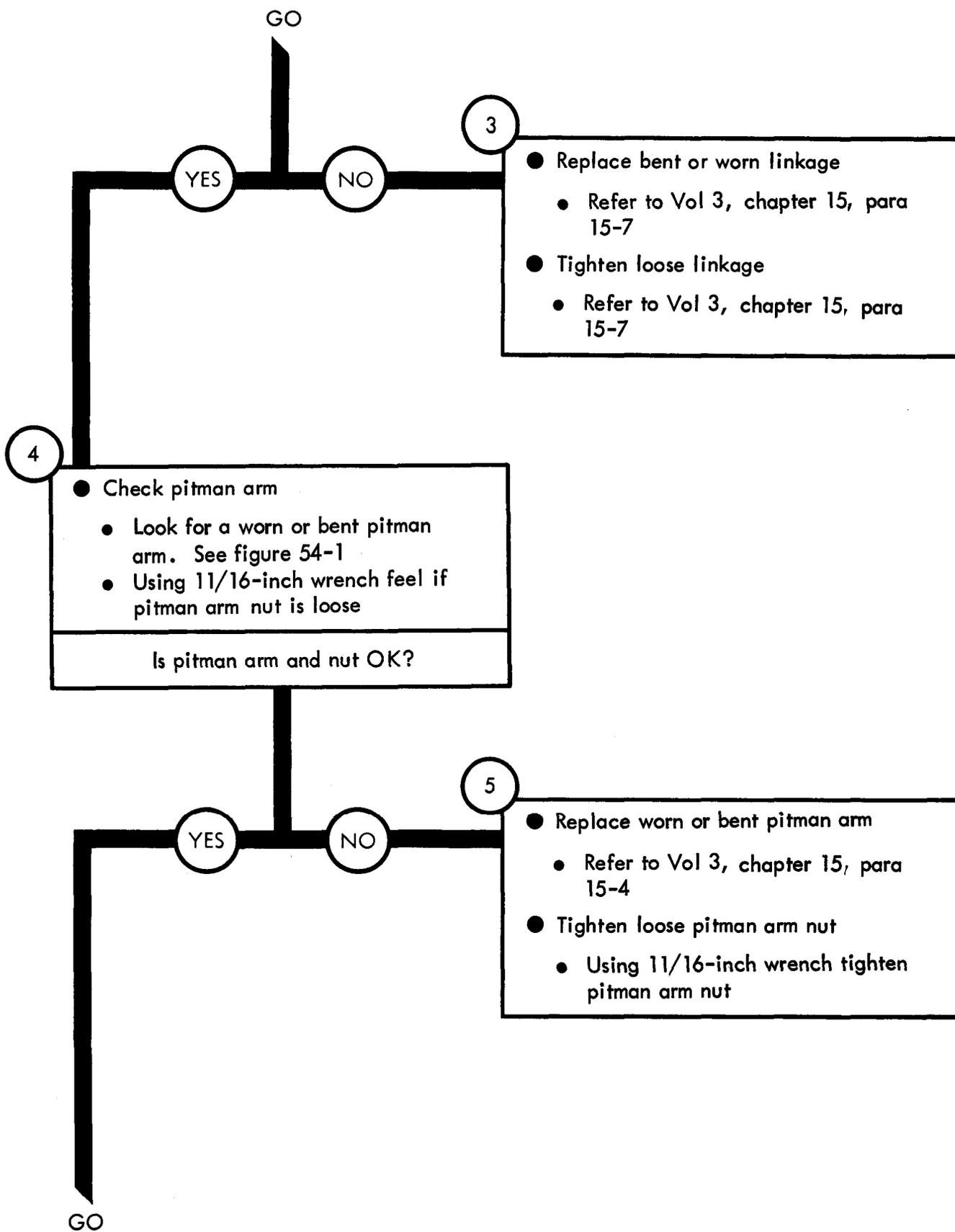

Figure 39-2 (Sheet 2 of 4)

TA 114816

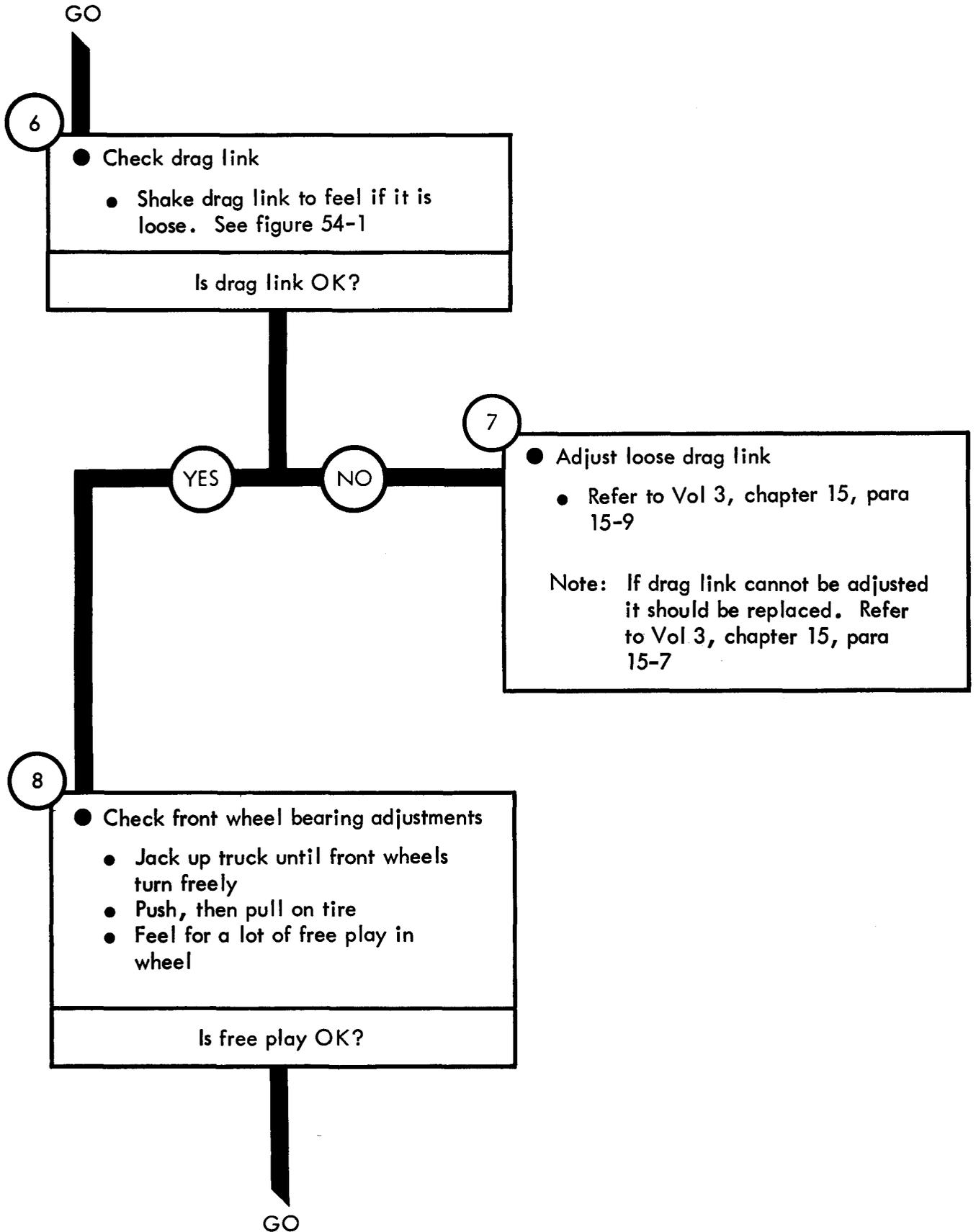
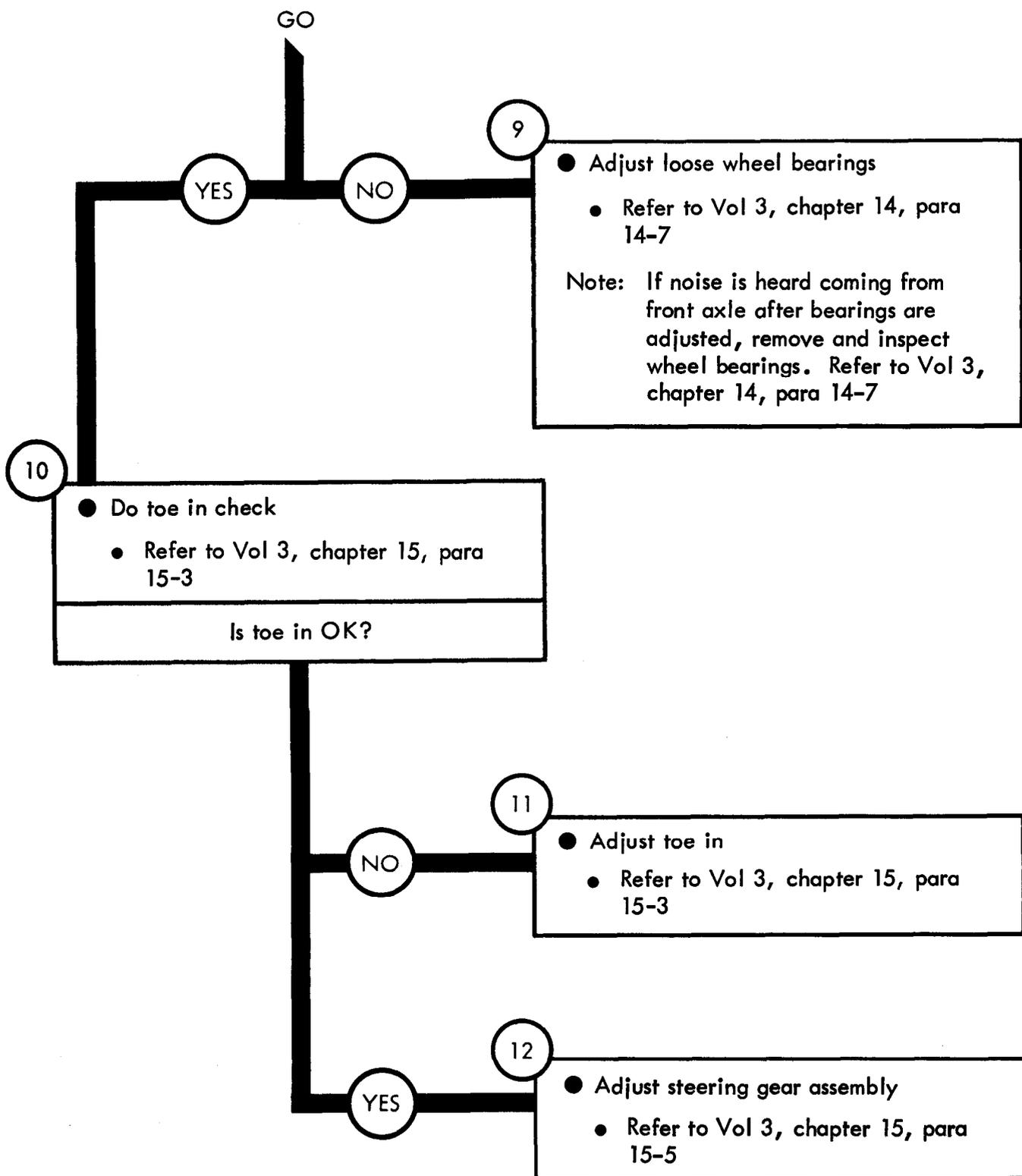

Figure 39-2 (Sheet 3 of 4)



TA 114818

Figure 38-2 (Sheet 4 of 4)

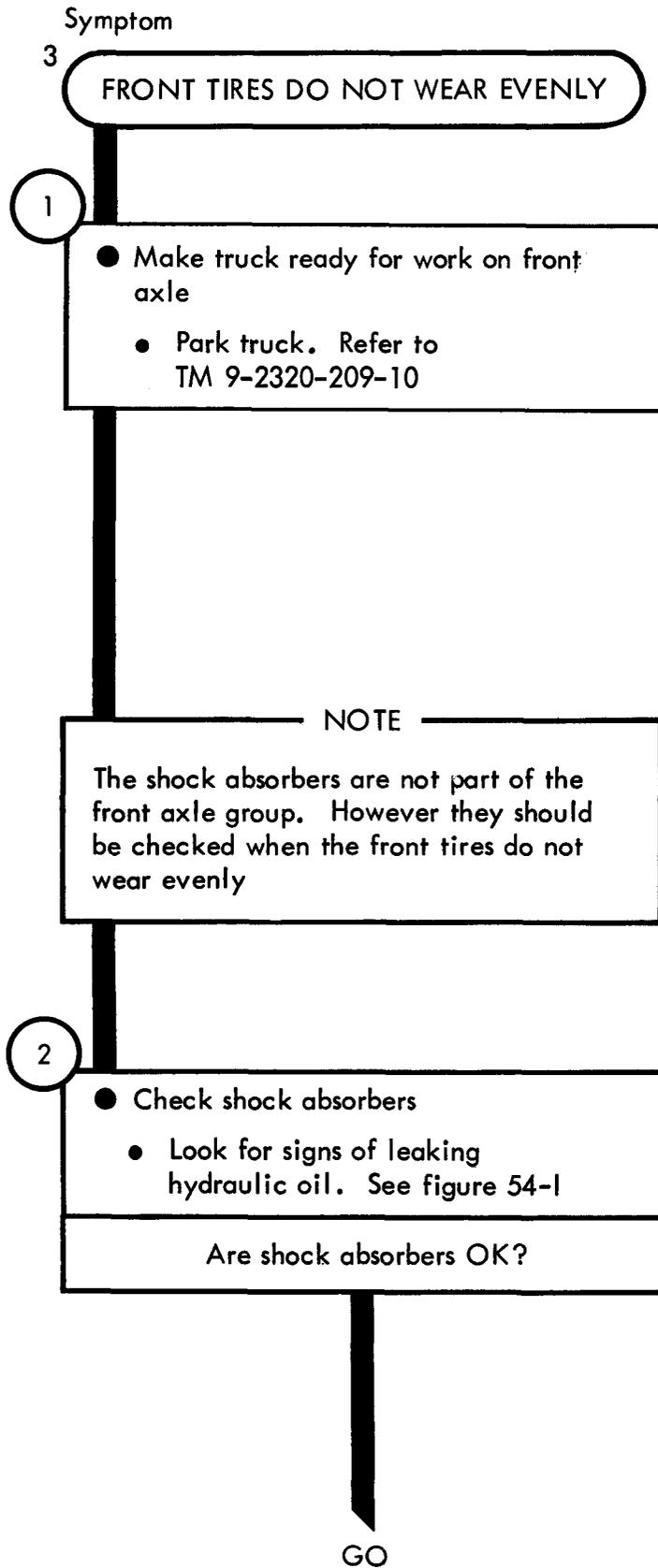
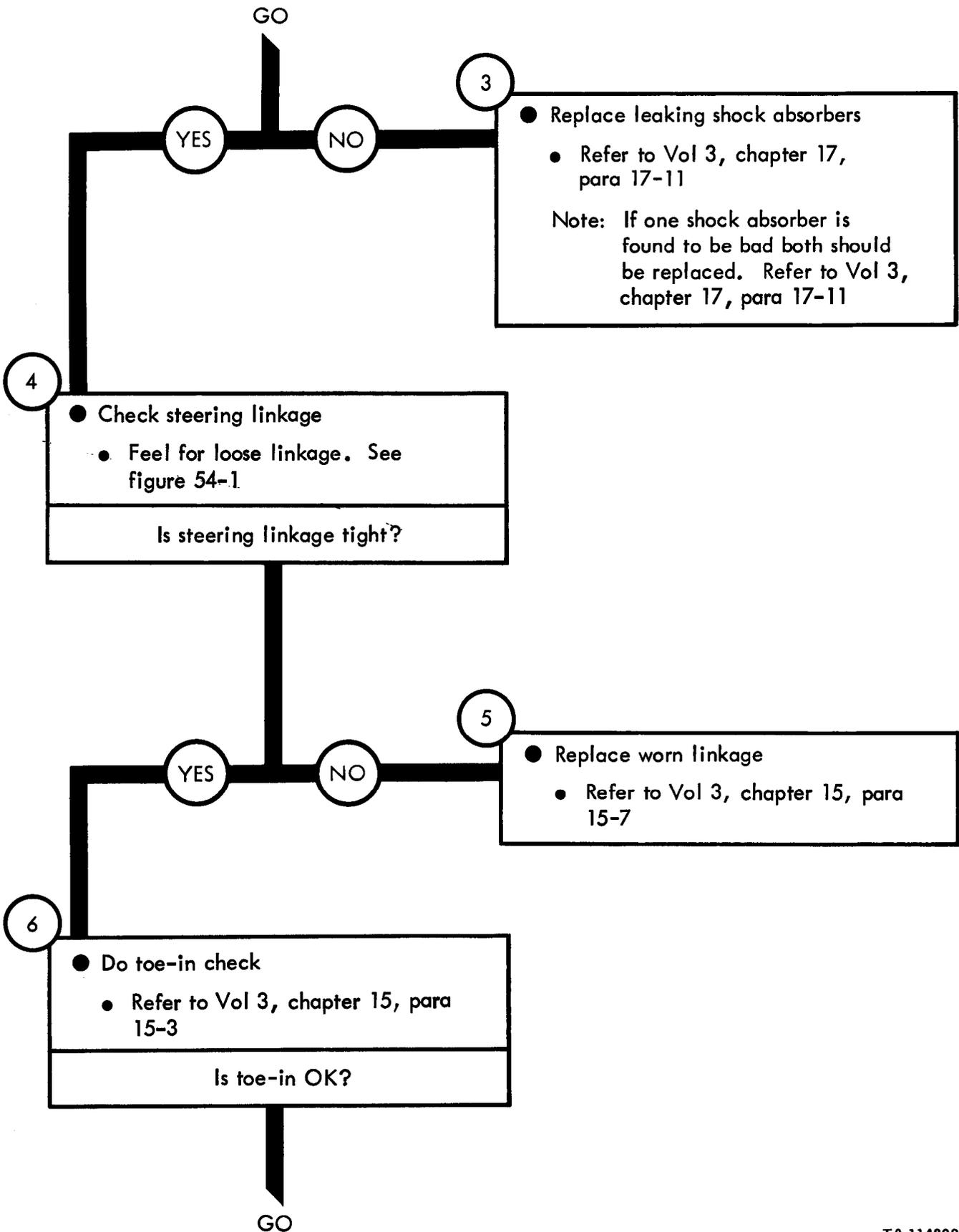
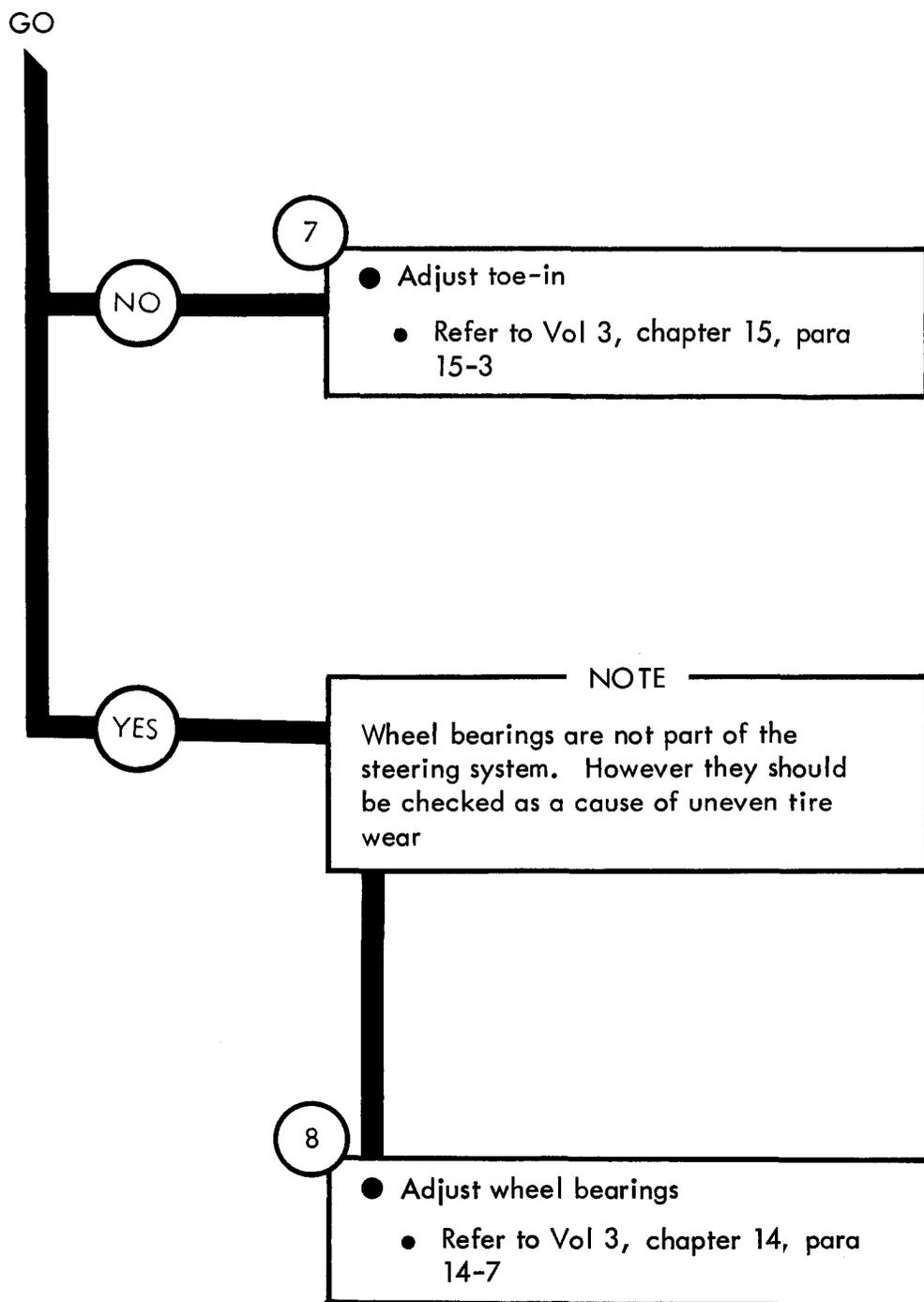

Figure 39-3 (Sheet 1 of 3)



TA 114820

Figure 39-3 (Sheet 2 of 3)



TA 114821

Figure 39-3 (Sheet 3 of 3)

CHAPTER 40

FRONT AXLE SYSTEM TROUBLESHOOTING SUMMARY

40-1. GENERAL. This chapter gives a summary of troubleshooting procedures given in chapter 39 for the front axle system.

40-2. PROCEDURES. The summary in this chapter covers all fault symptoms found in the detailed troubleshooting procedures. Chapter 7 outlines a sample troubleshooting procedure. The summary procedures are based on the "what-to-do" portions of the detailed procedures and do not include the "how-to-do-it" instructions. Warnings, cautions, and notes are given where needed.

FRONT AXLE SYSTEM TROUBLESHOOTING SUMMARY

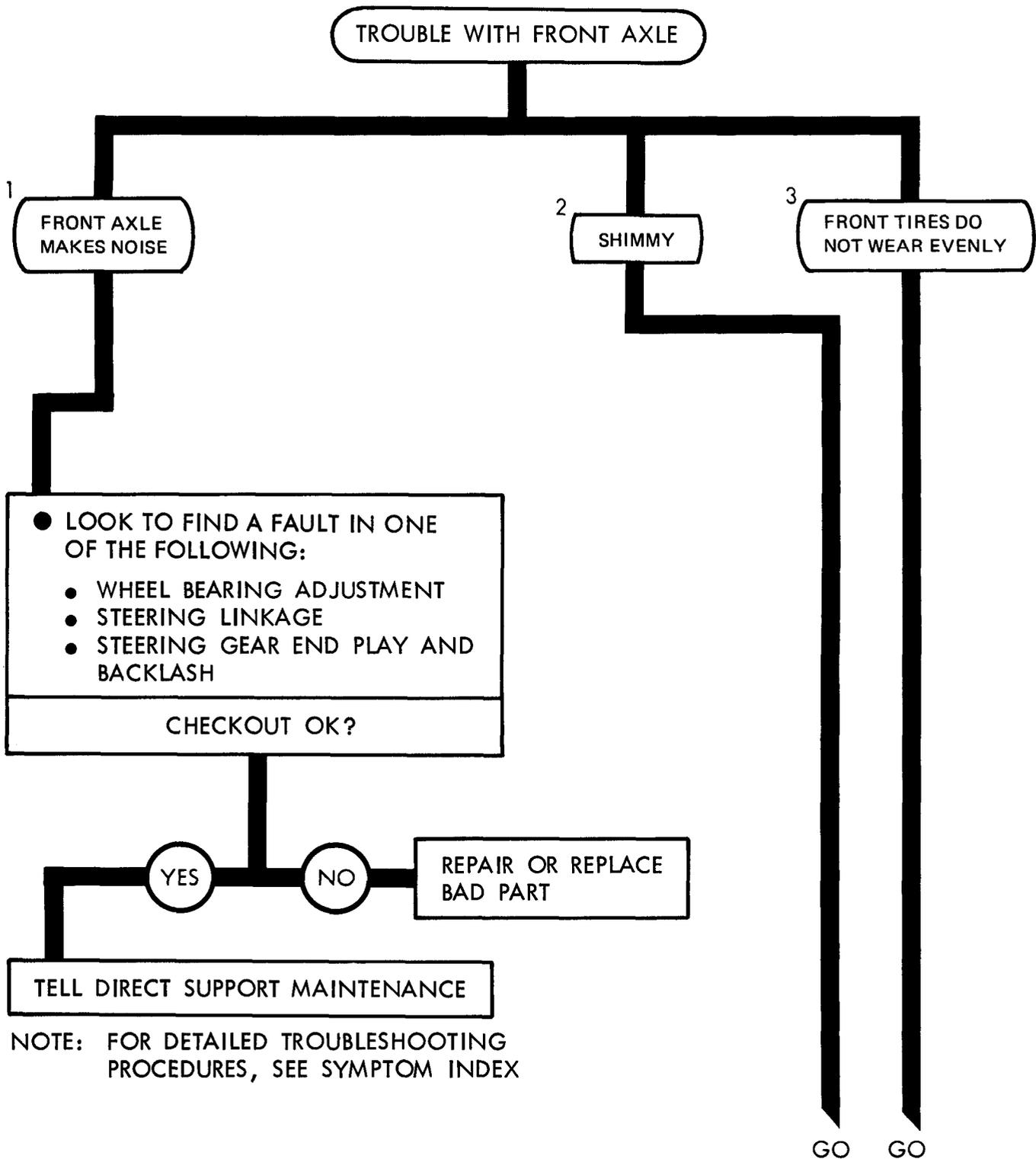

NOTE: FOR DETAILED TROUBLESHOOTING PROCEDURES, SEE SYMPTOM INDEX

TA 114822

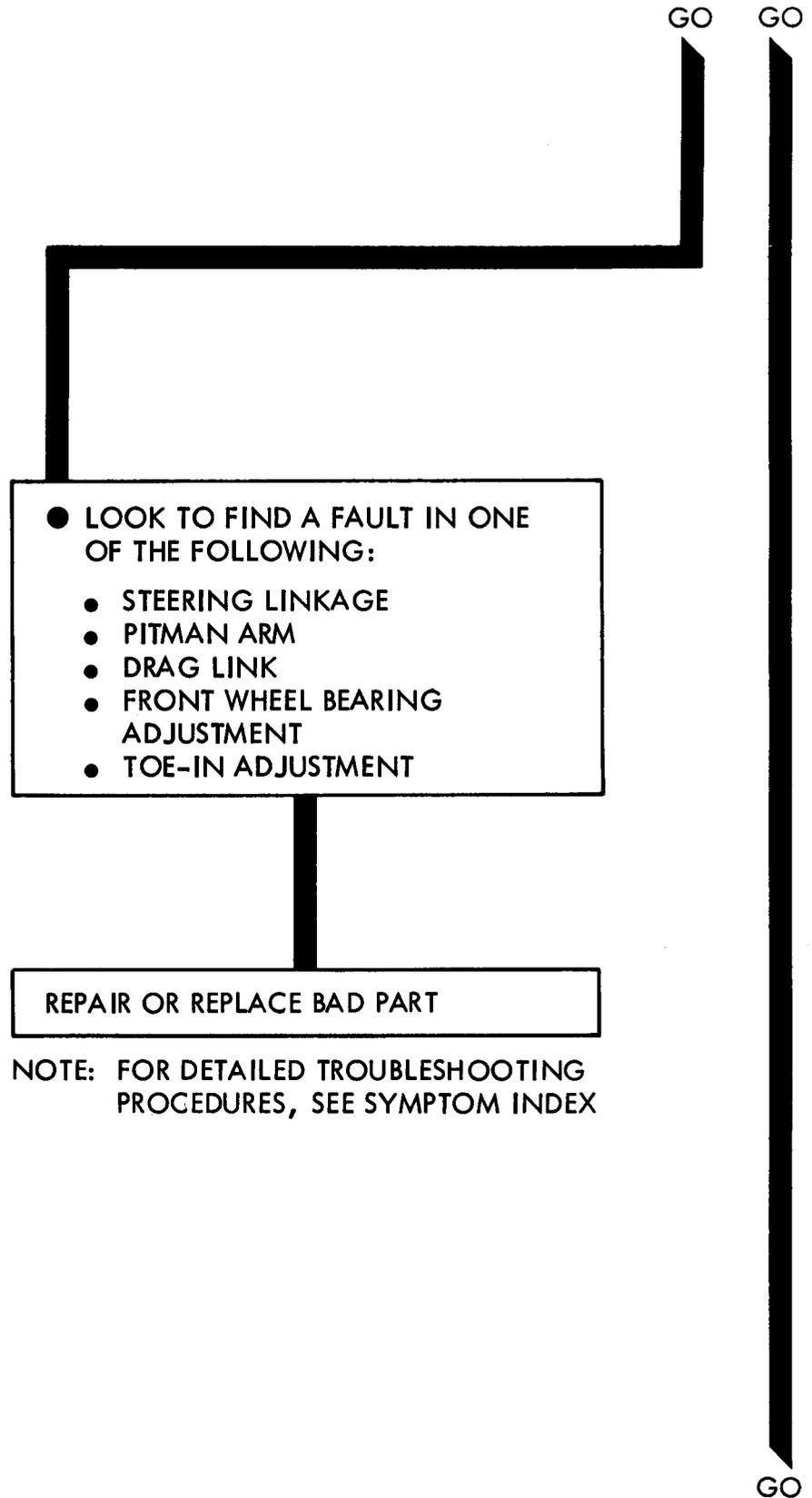

TA 114823

Figure 40-1 (Sheet 2 of 3)

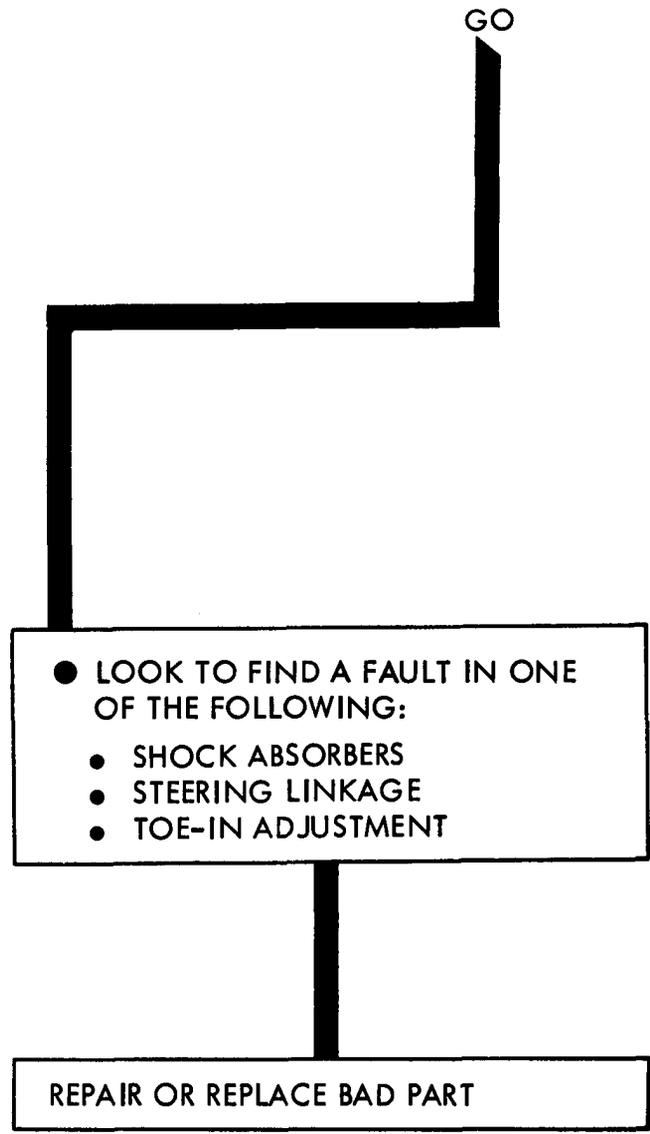

NOTE: FOR DETAILED TROUBLESHOOTING PROCEDURES, SEE SYMPTOM INDEX

TA 114824

Figure 40-1 (Sheet 3 of 3)

CHAPTER 41

FRONT AXLE SYSTEM CHECKOUT PROCEDURES

41-1. GENERAL. This chapter gives procedures for checking out the system after troubleshooting and repair have been done. Procedures are set up in flow chart form showing the checkout steps in order and referring to the fault symptom index when the system does not check out.

FRONT AXLE SYSTEM CHECKOUT

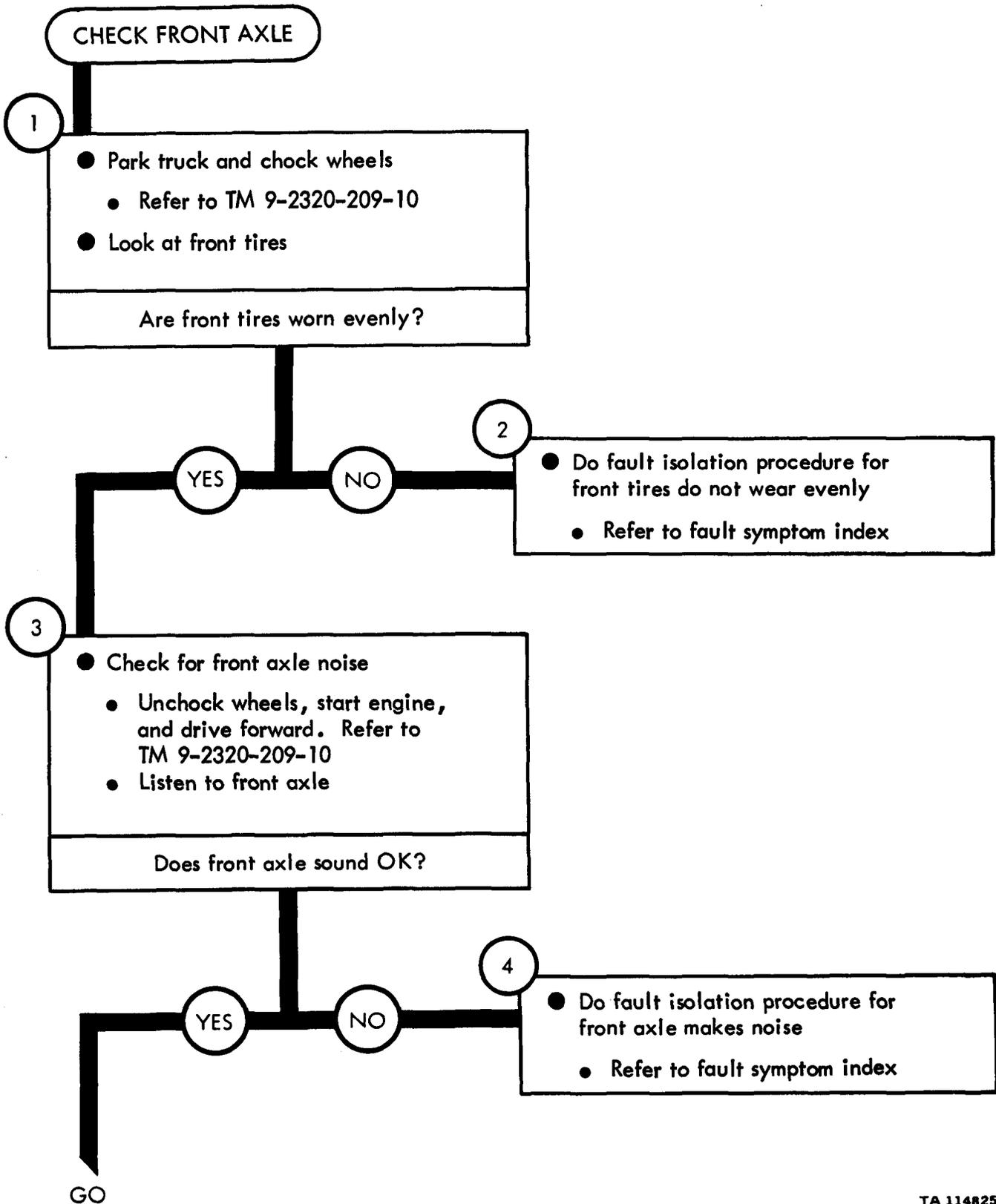

TA 114825

Figure 41-1 (Sheet 1 of 2)

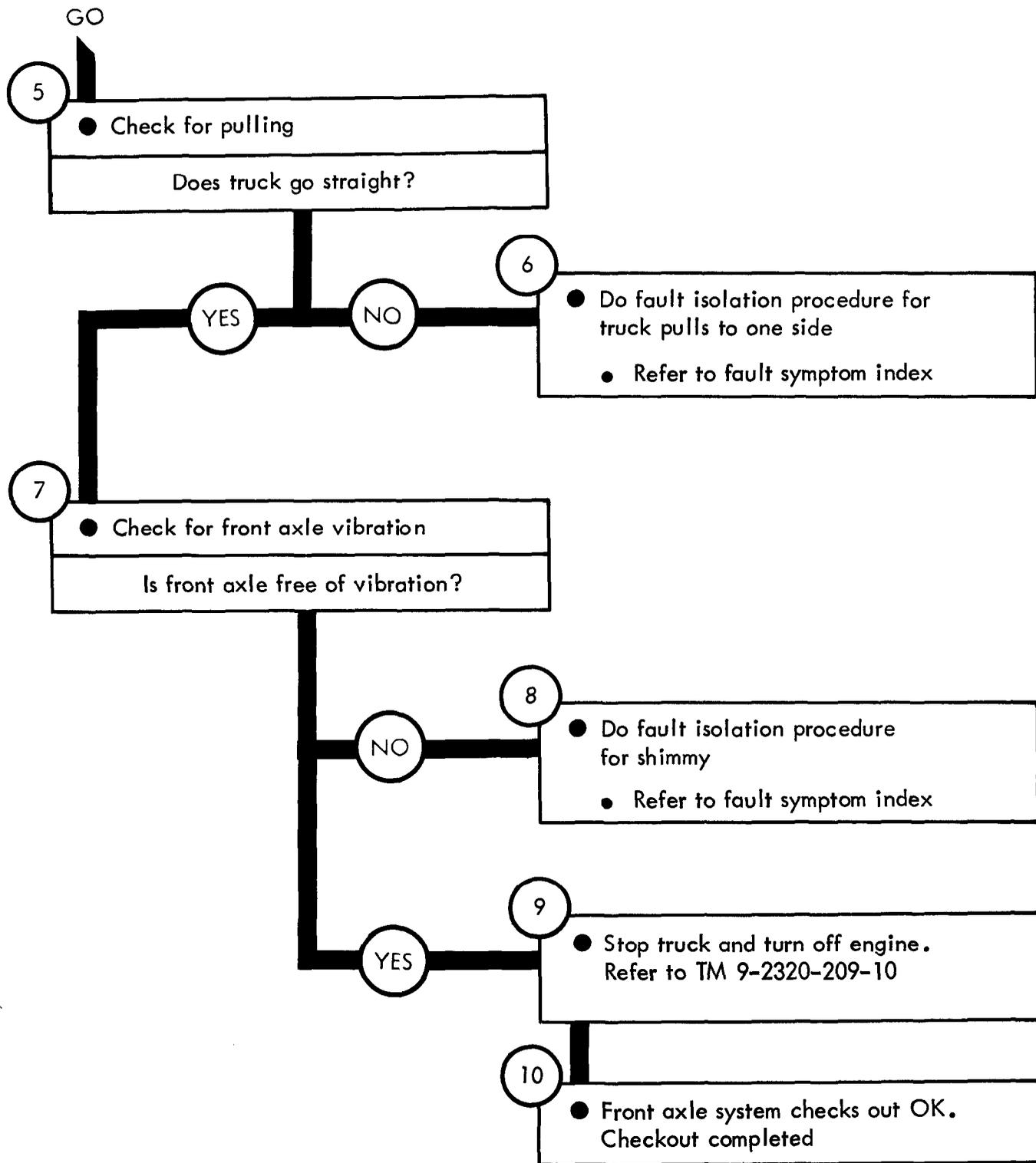

TA 114826

Figure 41-1 (Sheet 2 of 2)

CHAPTER 42

REAR AXLE SYSTEM TROUBLESHOOTING

42-1. EQUIPMENT ITEMS COVERED. This chapter gives equipment troubleshooting procedures for the rear axle system, for which there are authorized corrective maintenance tasks at the organizational maintenance level.

42-2. EQUIPMENT ITEMS NOT COVERED. All equipment items for which corrective maintenance is authorized at the organizational maintenance level are covered in this chapter.

REAR AXLE TROUBLESHOOTING

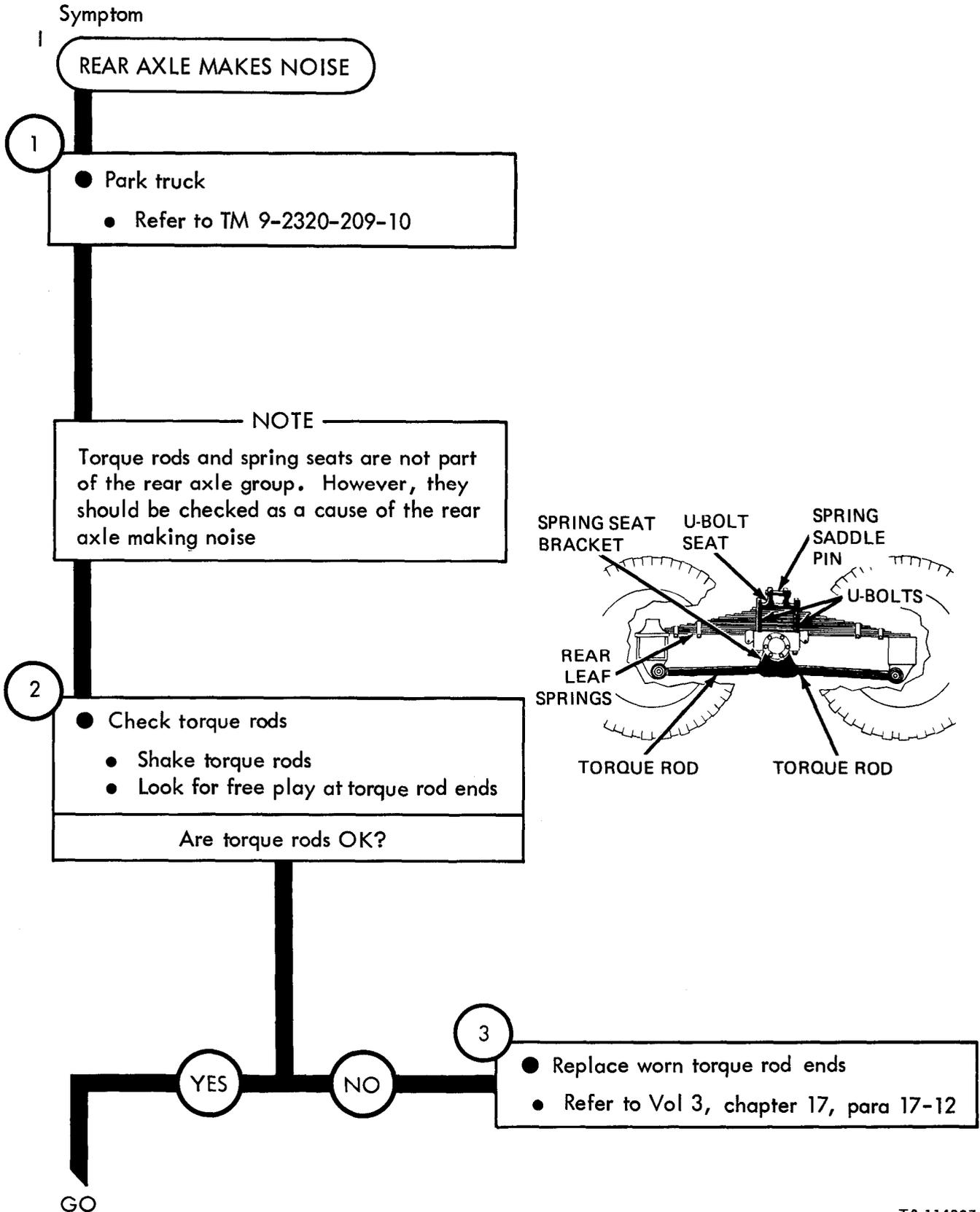

TA 114827

Figure 42-1 (Sheet 1 of 4)

4 **GO**

- Check spring seat bearing free play
 - Jack up and support truck so that wheels are off ground. Refer to TM 9-2320-209-10
 - Take off spring seat bearing cap. Refer to Vol 3, chapter 17, para 17-10
 - Put pry bar between spring saddle pin and U-bolt seat
 - Push bar up and down and look for too much movement in adjusting nut

Is adjusting nut OK?

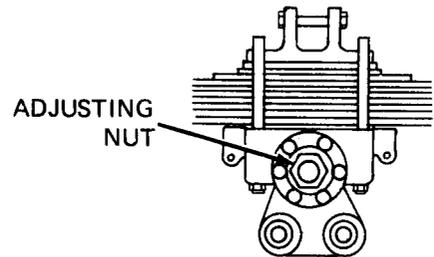
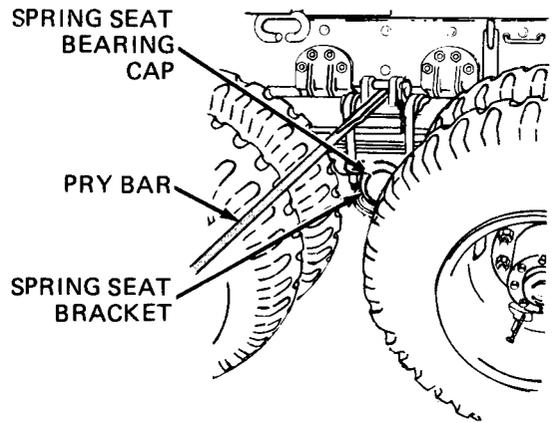

YES NO

5

- Tighten adjusting nut
 - Refer to Vol 3, chapter 17, para 17-10

6

- Check wheel bearing adjustment
 - Slide a pry bar under rear wheels

NOTE: Bar is used as a lever to push up on the tire using the floor for support

- Push up on tire and feel for a lot of free play in wheel

Is wheel bearing adjustment OK?

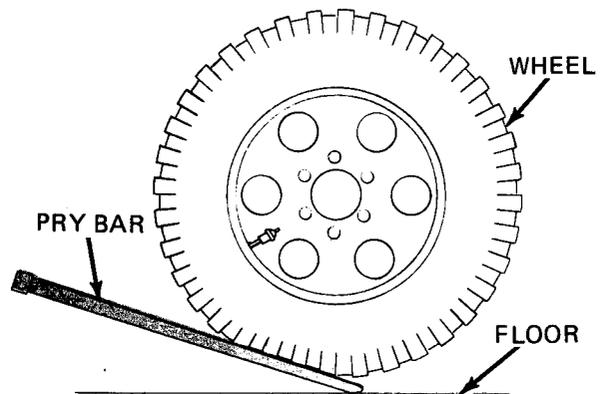

GO

Figure 42-1 (Sheet 2 of 4)

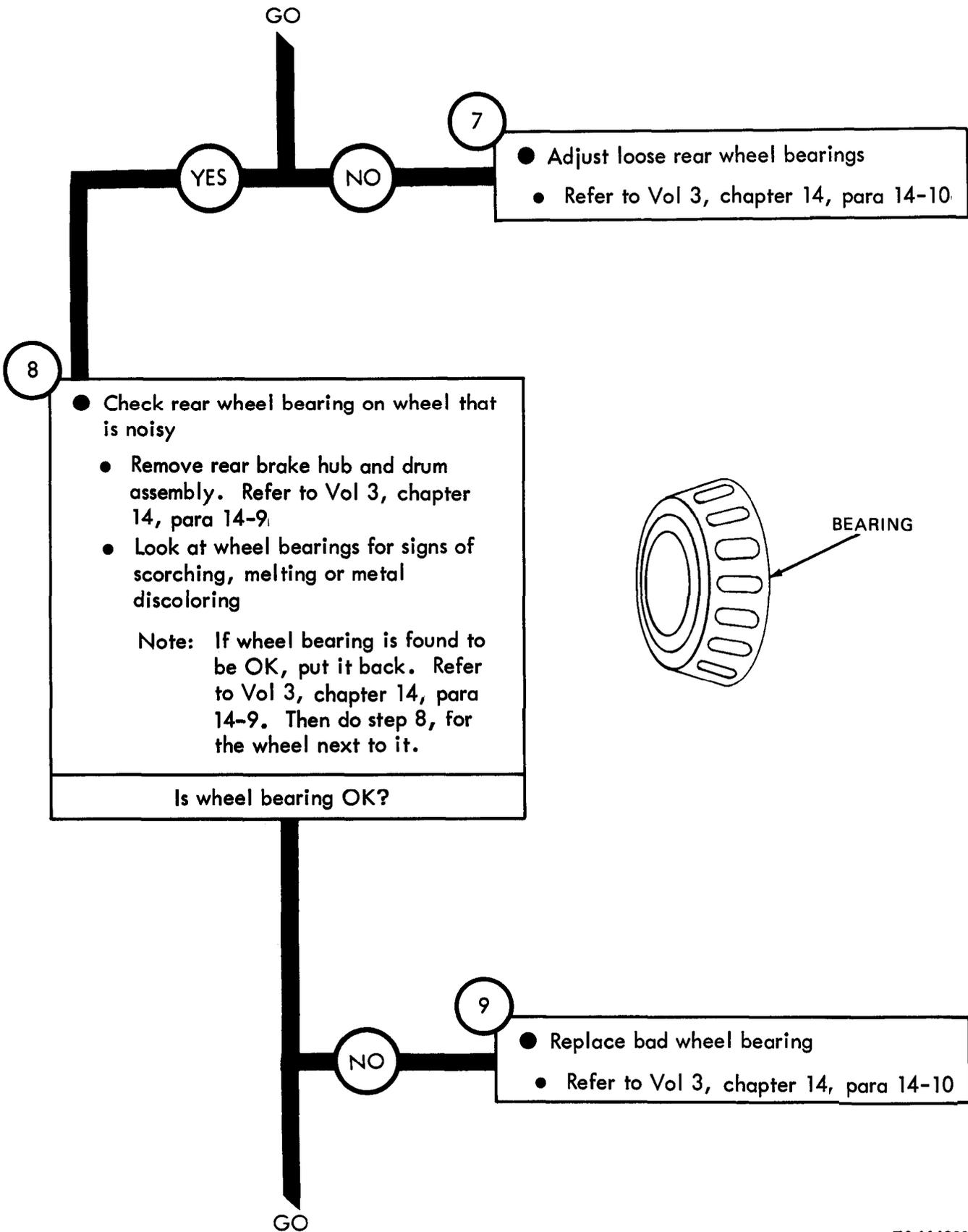

TA 114829

Figure 42-1 (Sheet 3 of 4)

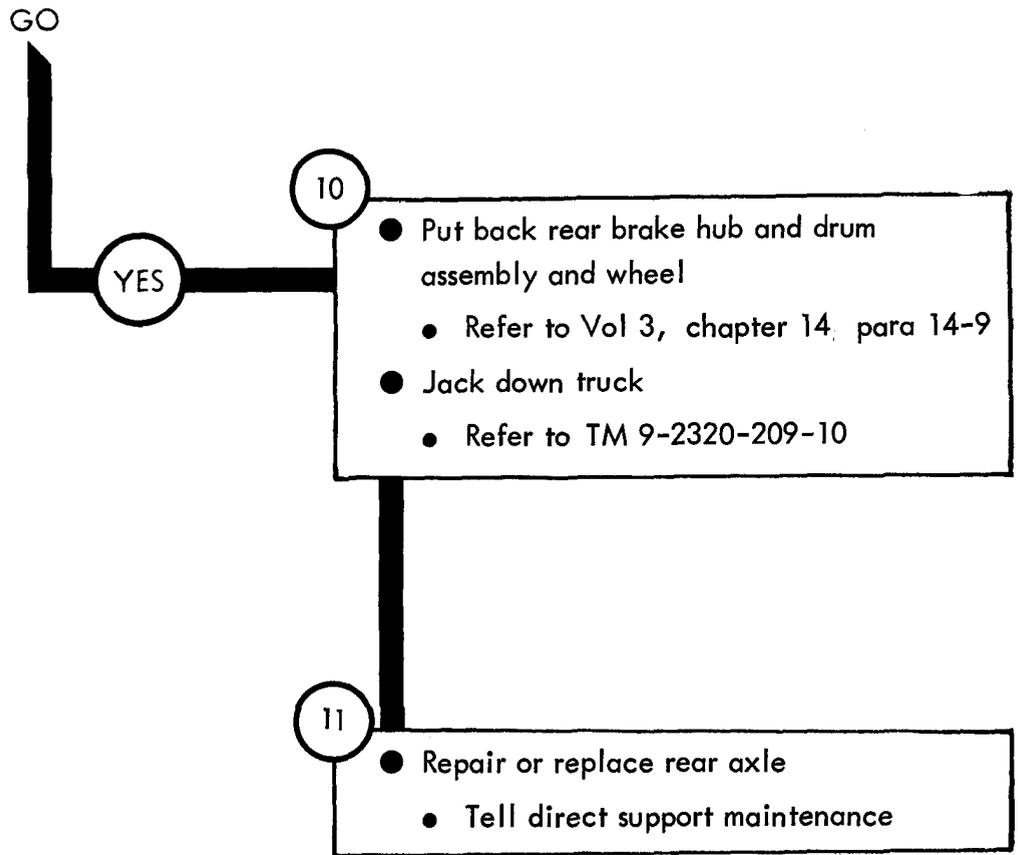

CHAPTER 43

REAR AXLE SYSTEM SUPPORT DIAGRAMS

43-1. GENERAL. This chapter gives the diagrams you need when doing troubleshooting procedures in chapter 42. Table 3-1 is a complete listing of all support diagrams used in this manual.

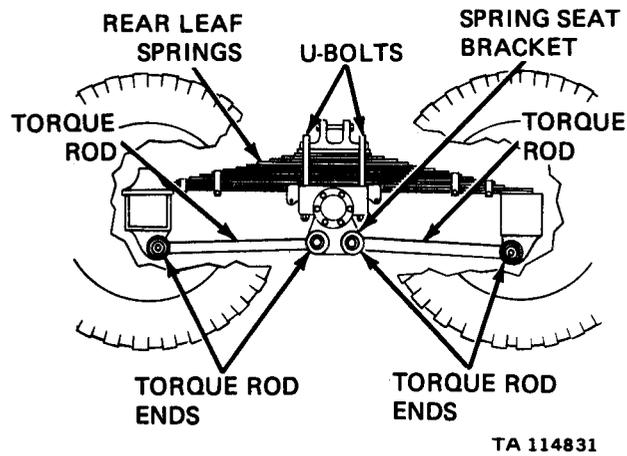

Figure 43-1. Rear Axle Support Diagram

CHAPTER 44

BRAKE SYSTEM TROUBLESHOOTING

44-1. EQUIPMENT ITEMS COVERED. This chapter gives equipment troubleshooting procedures for the brake system, for which there are authorized corrective maintenance tasks at the organizational maintenance level.

44-2. EQUIPMENT ITEMS NOT COVERED. All equipment items for which corrective maintenance is authorized at the organizational maintenance level are covered in this chapter.

BRAKE SYSTEM TROUBLESHOOTING

Symptom

1
BRAKE PEDAL PRESSURE IS SPONGY

- 1
- Make truck ready for work on brake system
 - Park truck. Refer to TM 9-2320-209-10

- 2
- Check hydraulic brake fluid in master cylinder
 - Open master cylinder access hatch
 - Using 3/8-inch open end wrench, unscrew tube nut and take off hydraulic tube
 - Using 3/4-inch open end wrench, unscrew and take off master cylinder filler cap
 - Using a flashlight, shine light into master cylinder reservoir to see if fluid level is low
- Is the hydraulic brake fluid level OK?

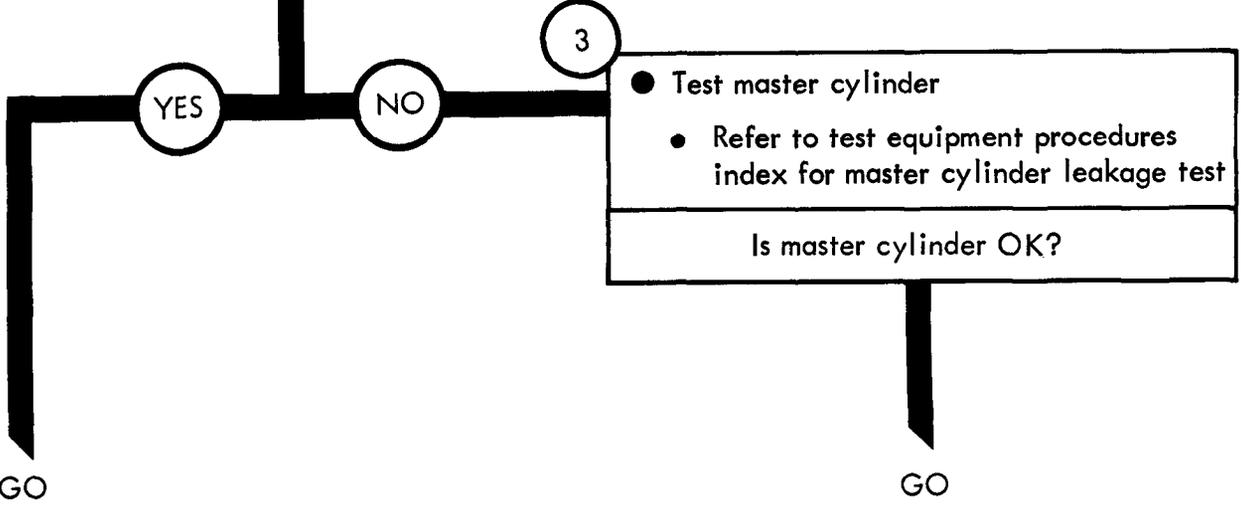
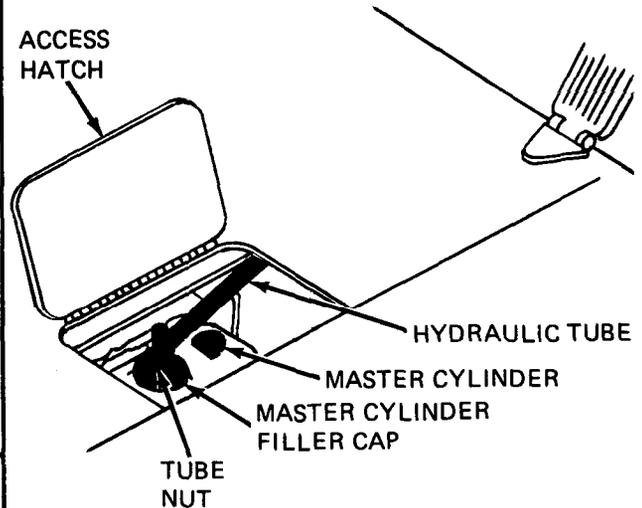

TA 114832

Figure 44-1 (Sheet 1 of 7)

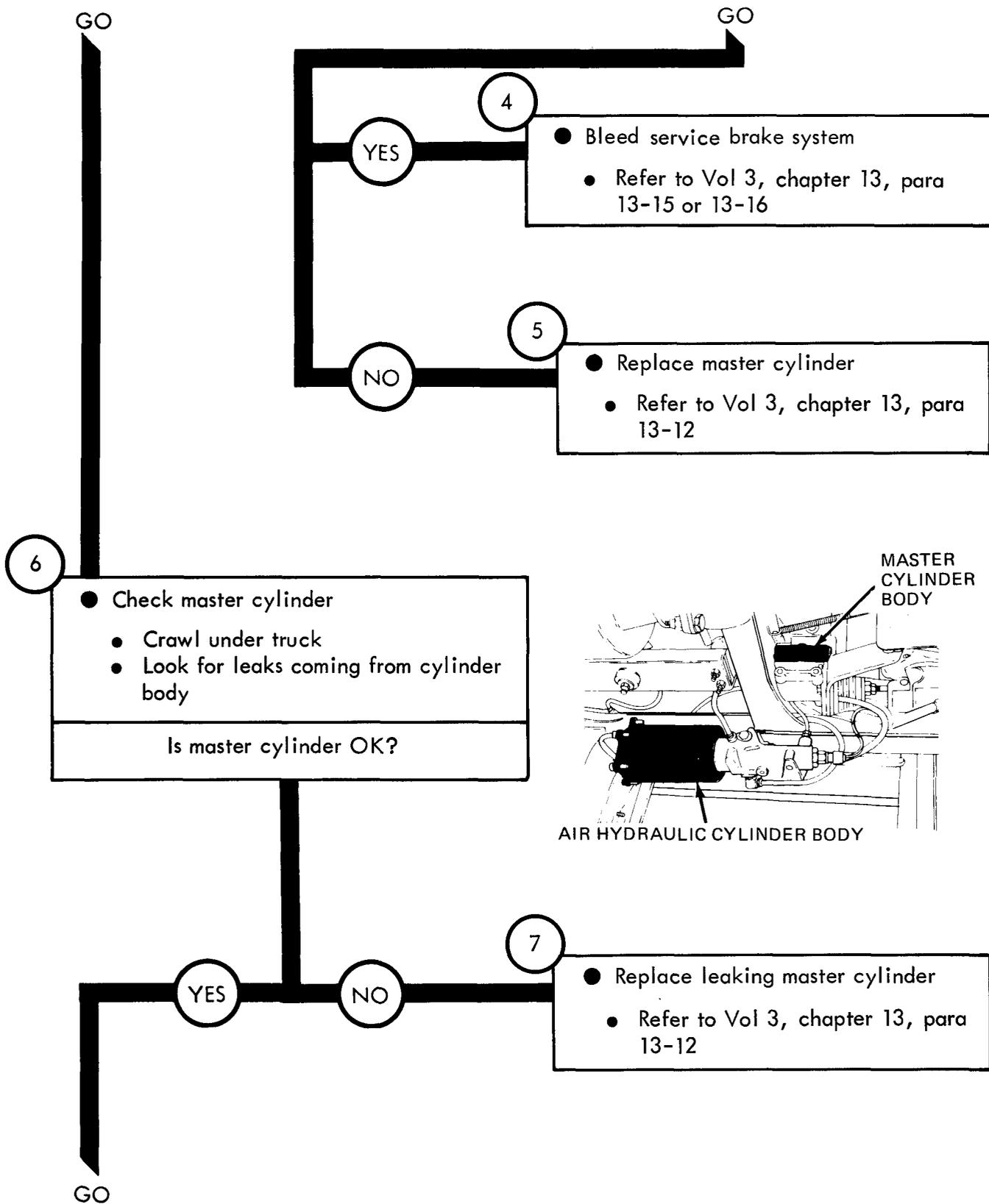

TA 114833

Figure 44-1 (Sheet 2 of 7)

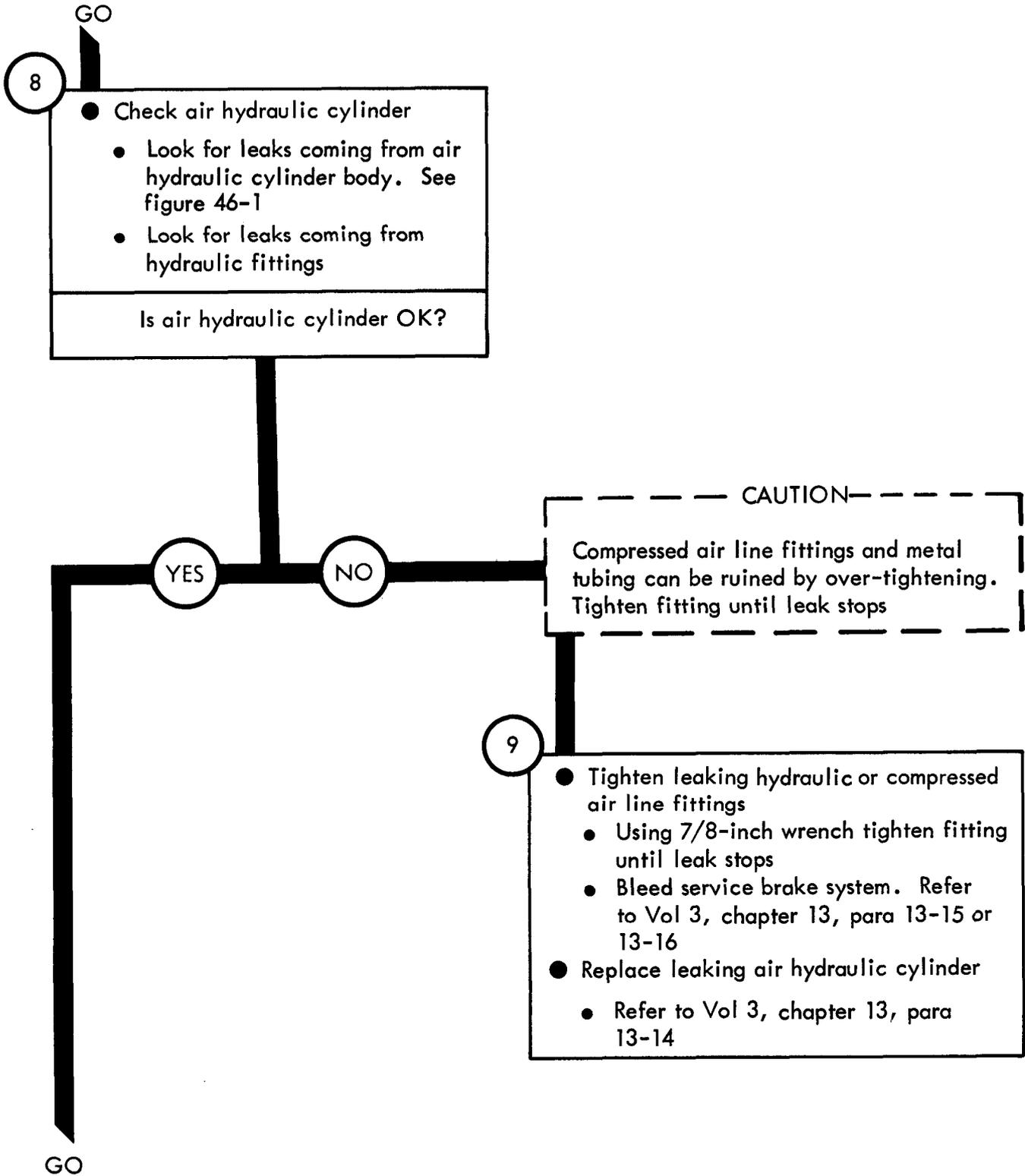

TA 114834

Figure 44-1 (Sheet 3 of 7)

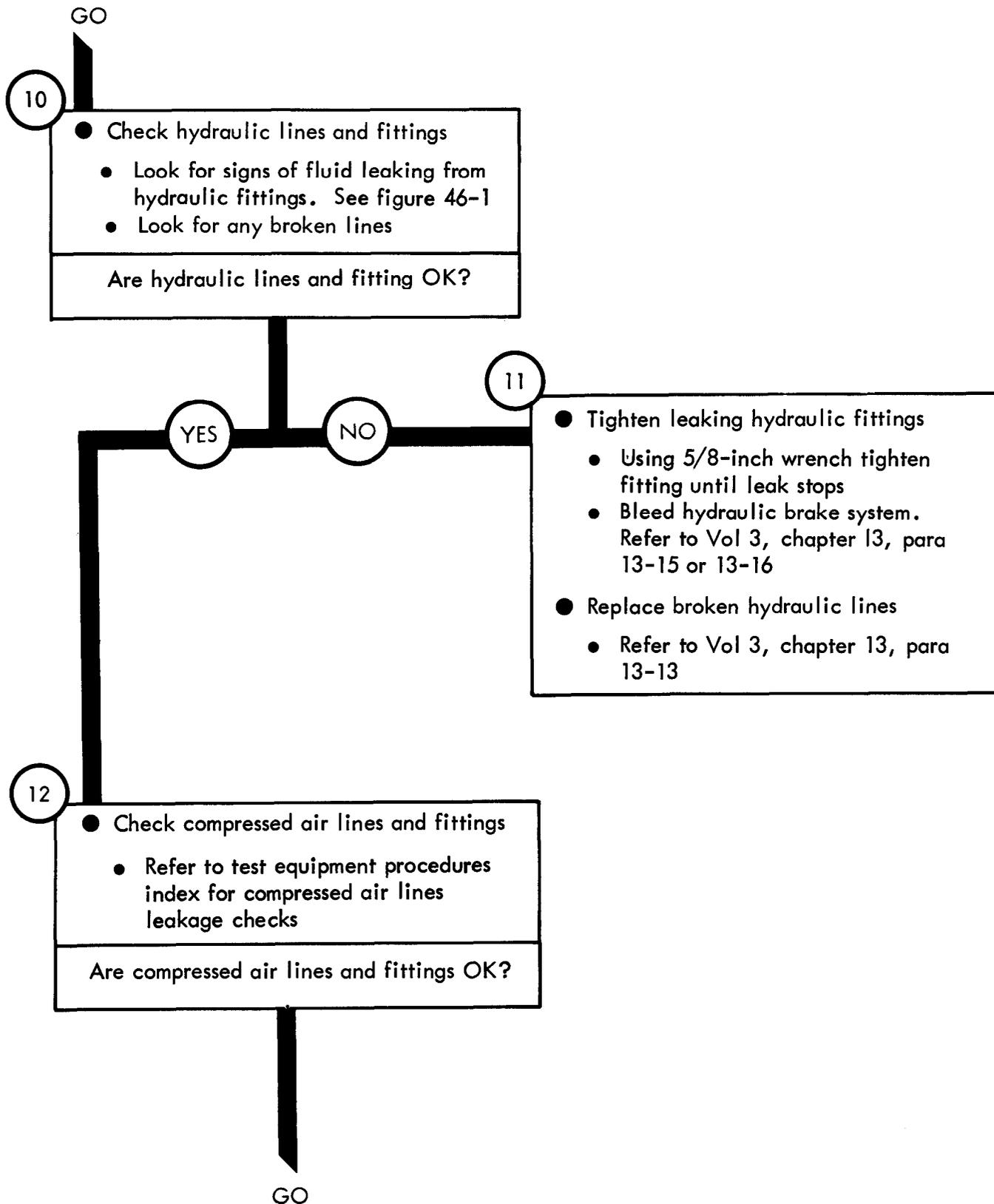

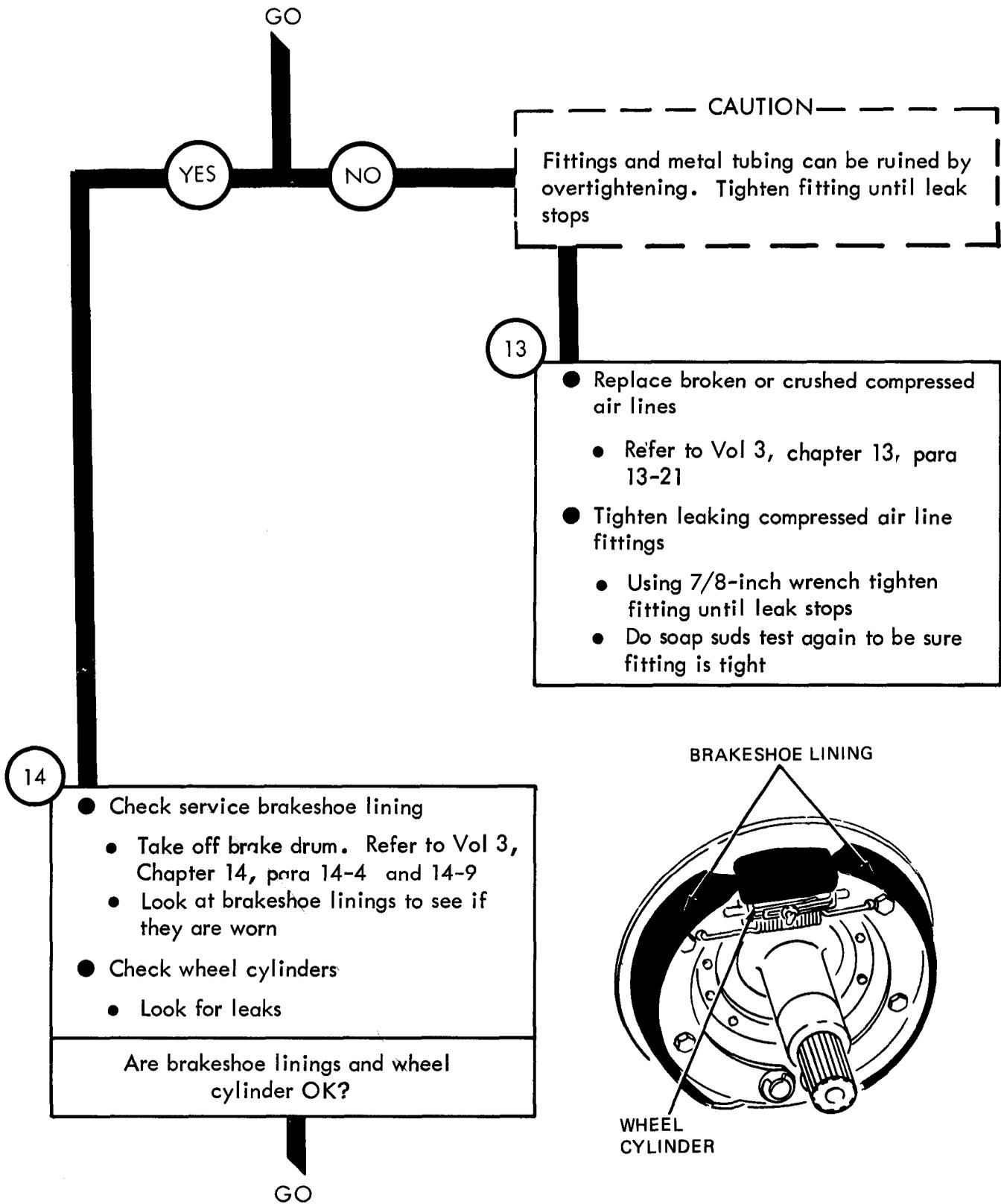

TA 114836

Figure 44-1 (Sheet 5 of 7)

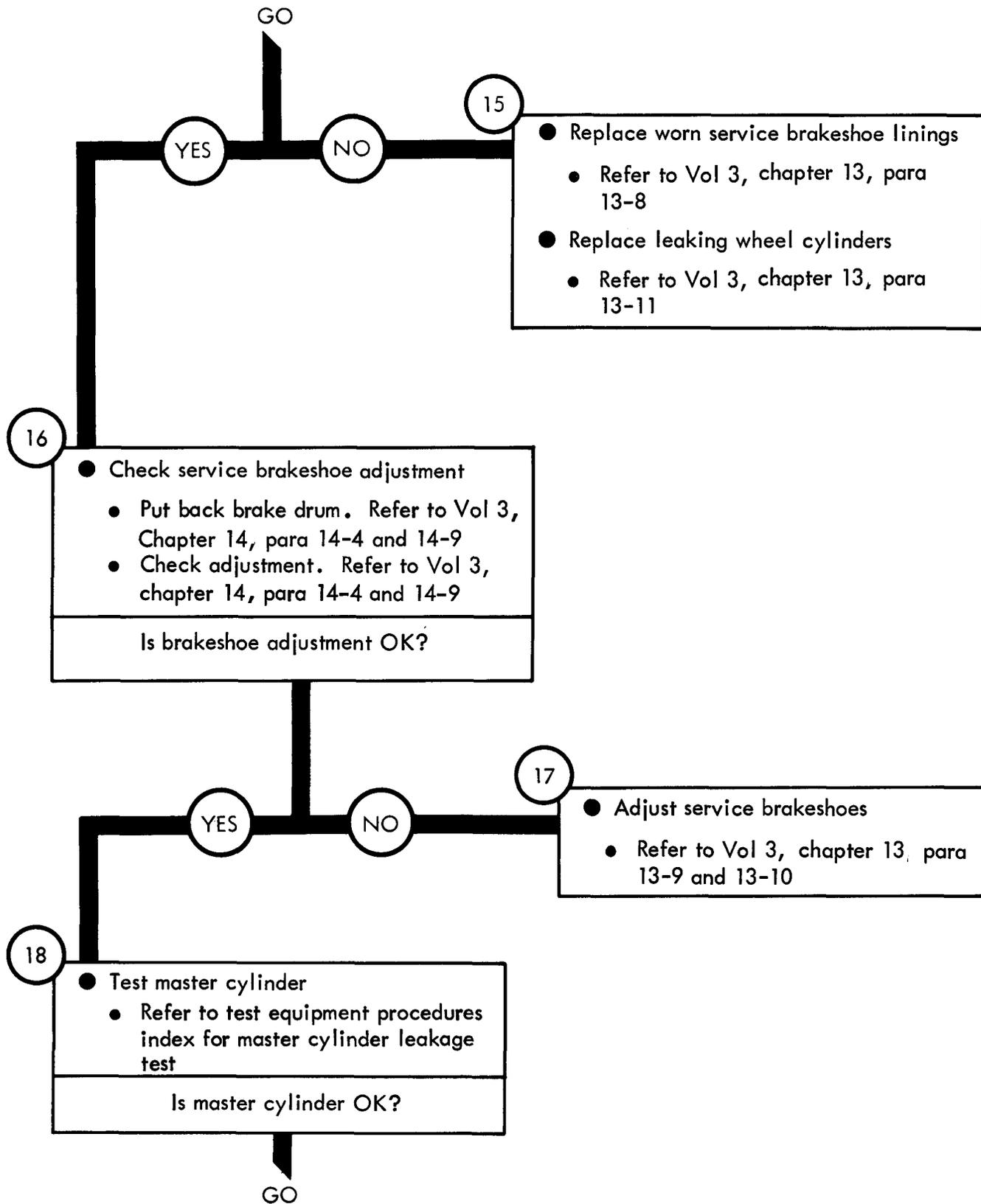
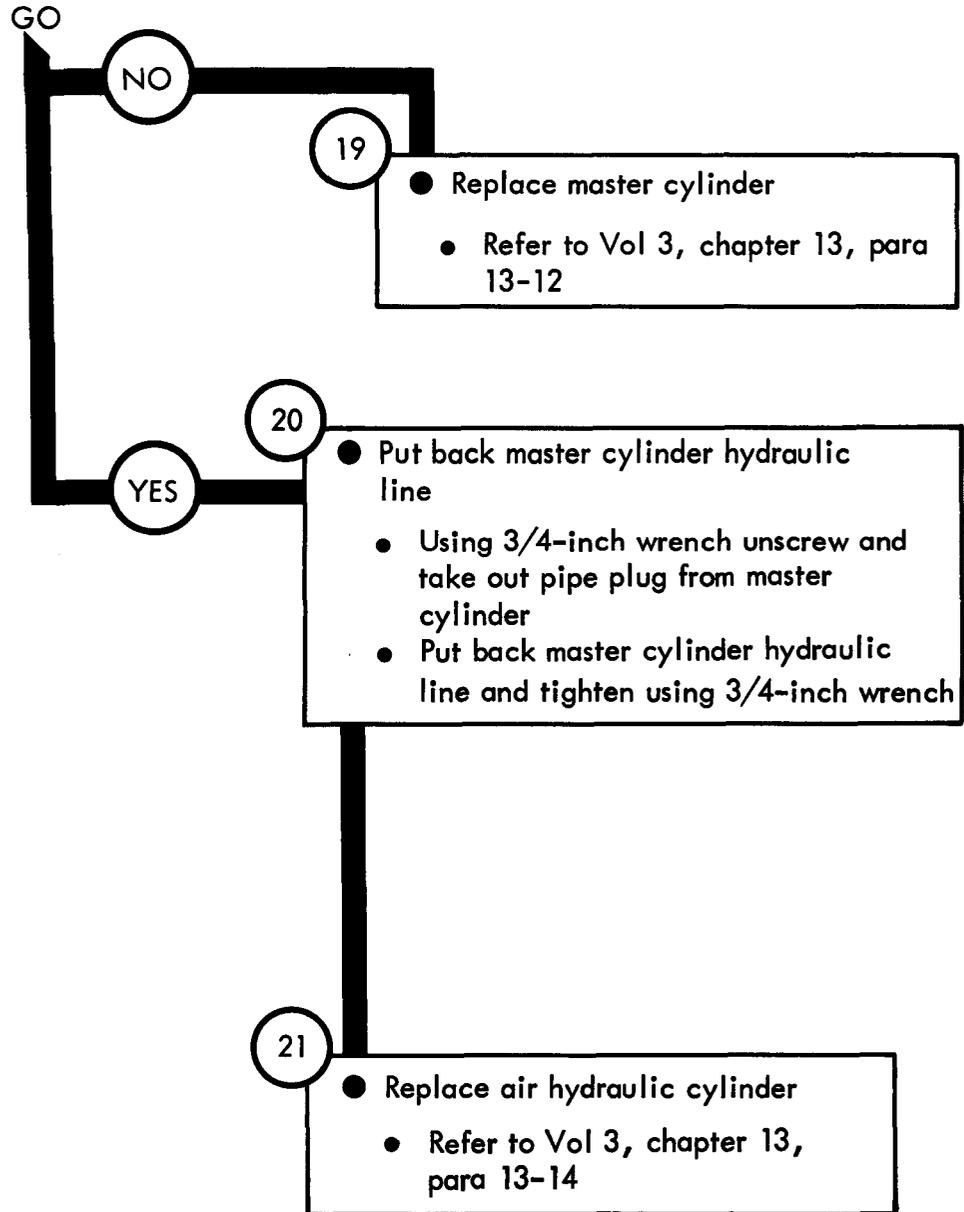
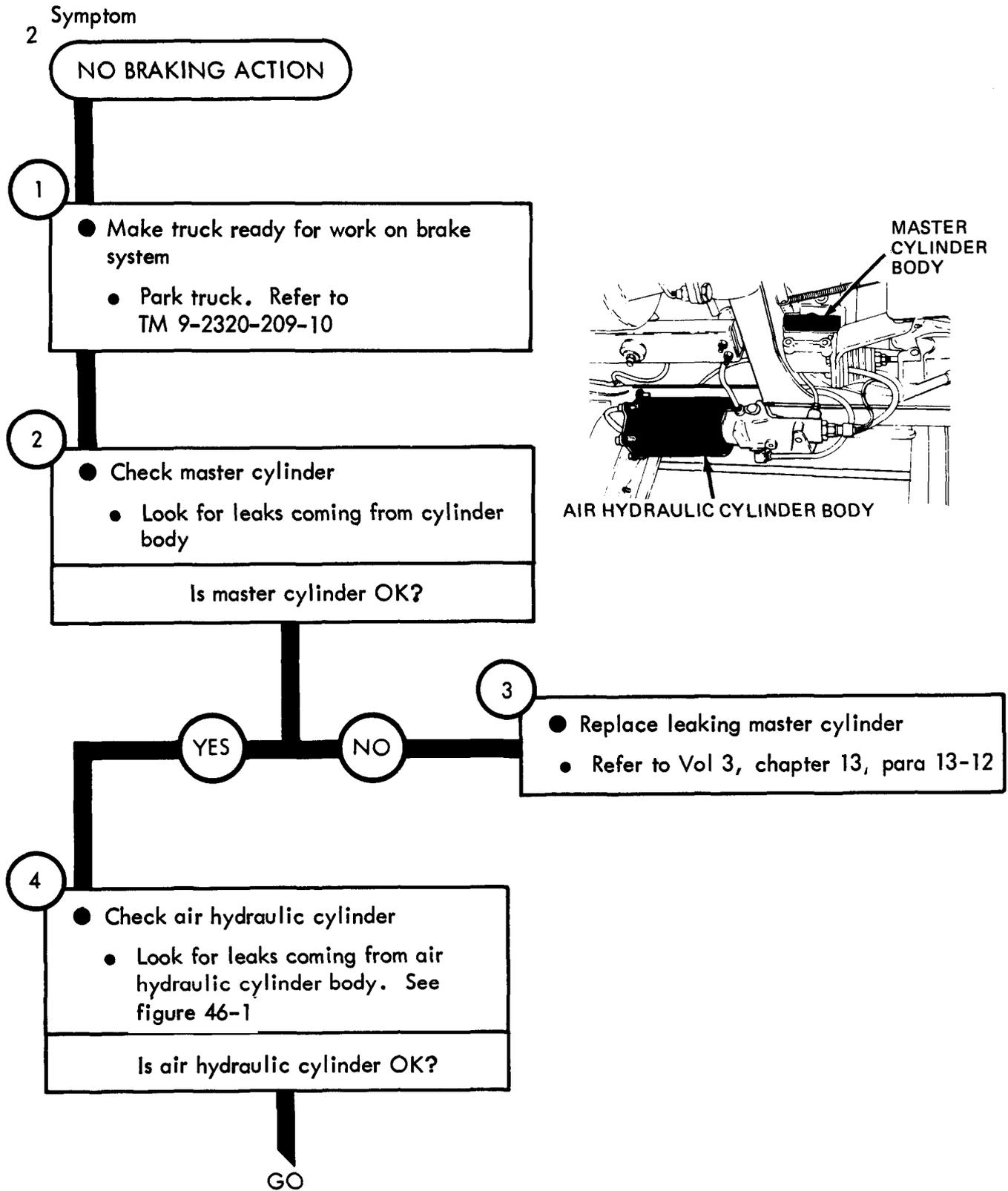

Figure 44-1 (Sheet 6 of 7)



TA 114838

Figure 44-1 (Sheet 7 of 7)



TA 114839

Figure 44-2 (Sheet 1 of 2)

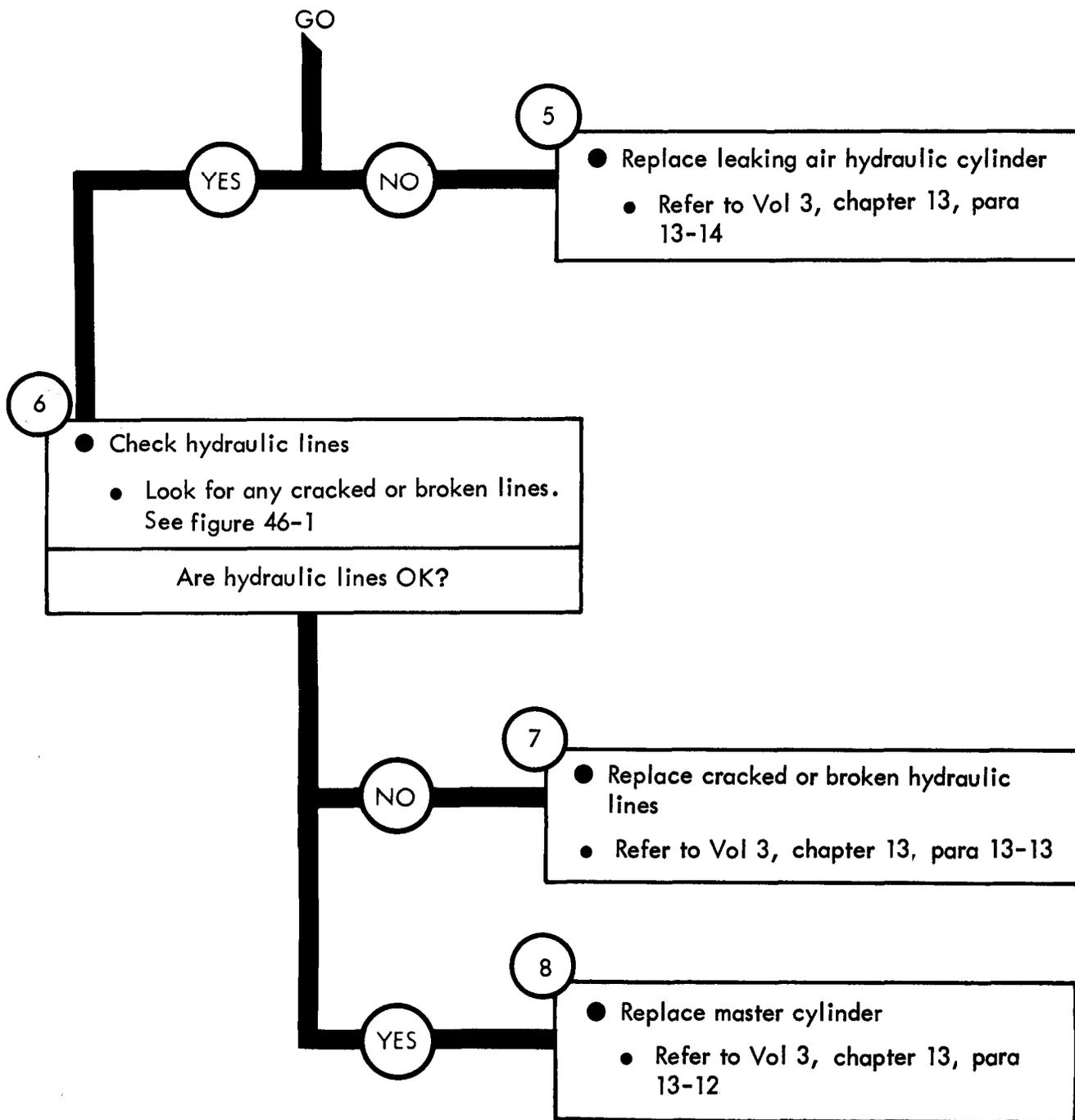

Figure 44-2 (Sheet 2 of 2)

TA 114840

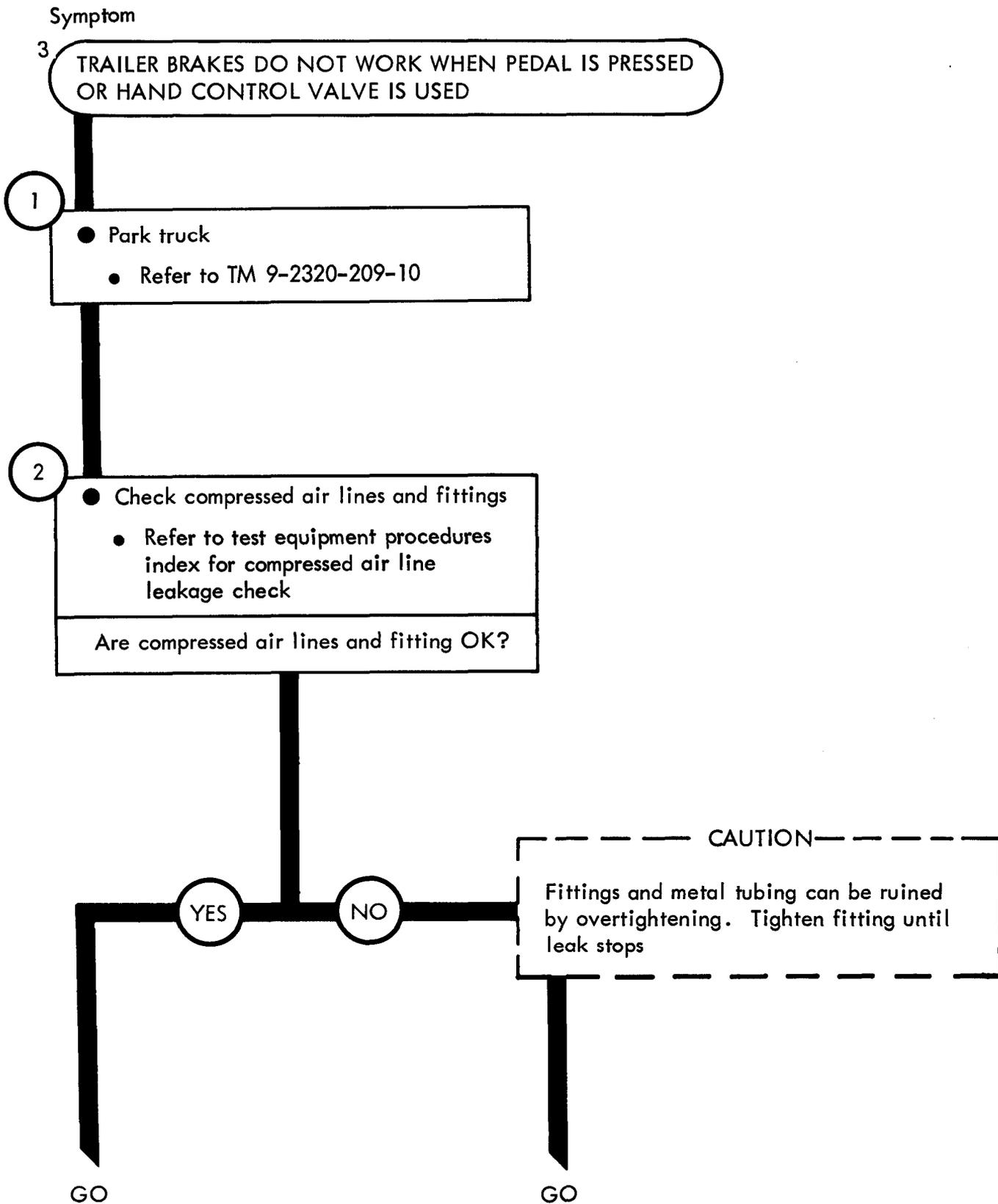

Figure 44-3 (Sheet 1 of 2)

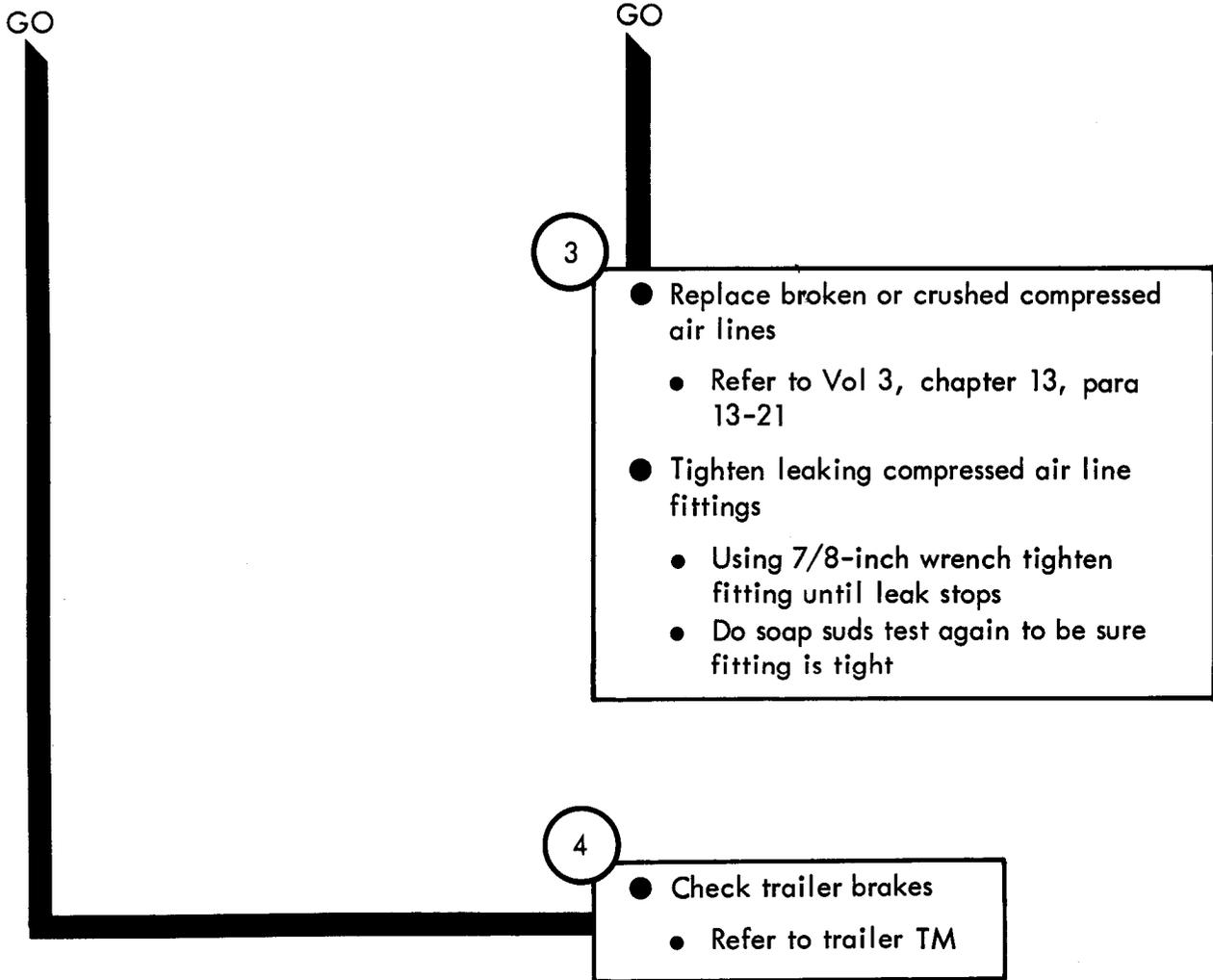
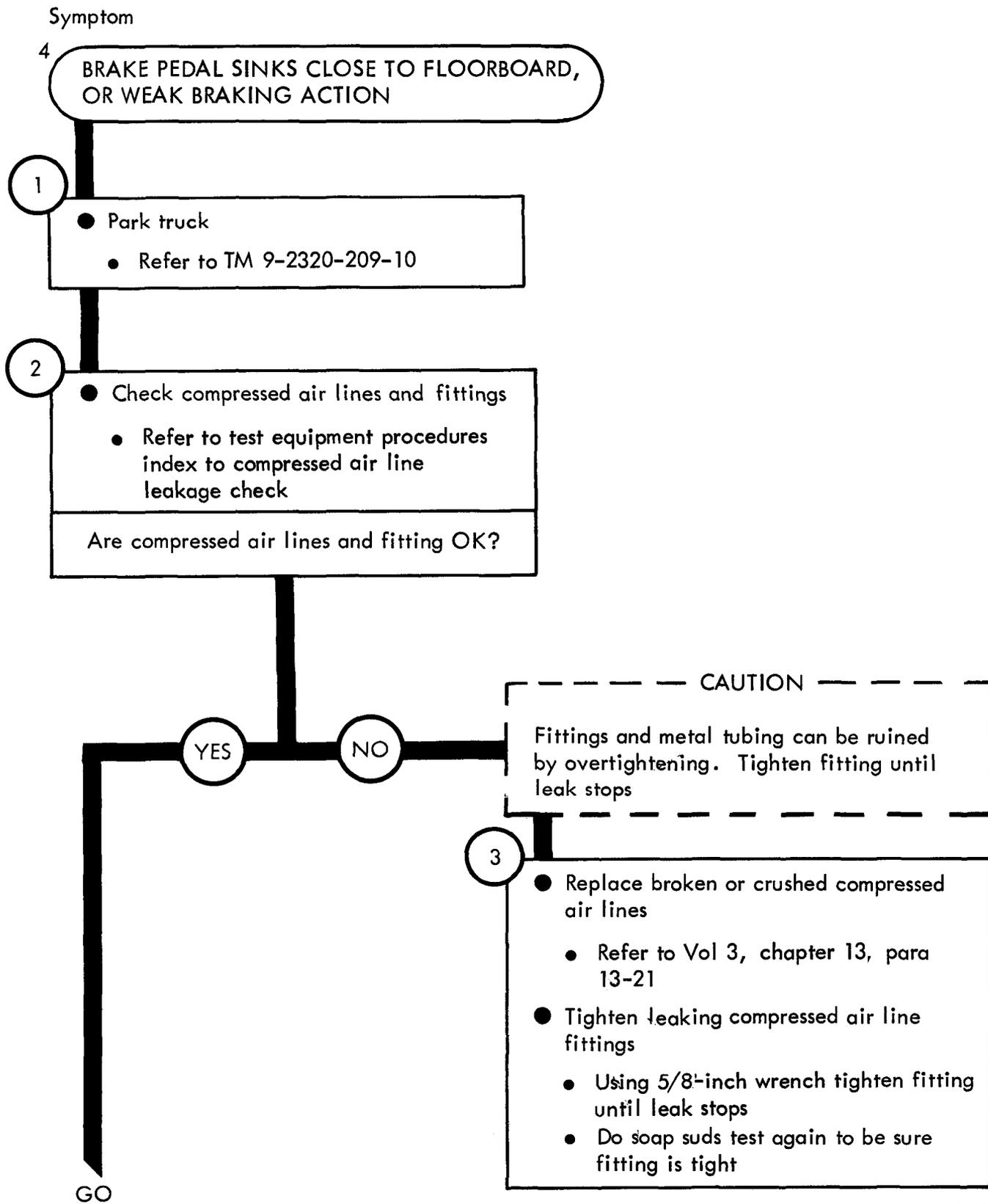

Figure 44-3 (Sheet 2 of 2)

TA 114842



TA 114843

Figure 44-4 (Sheet 1 of 3)

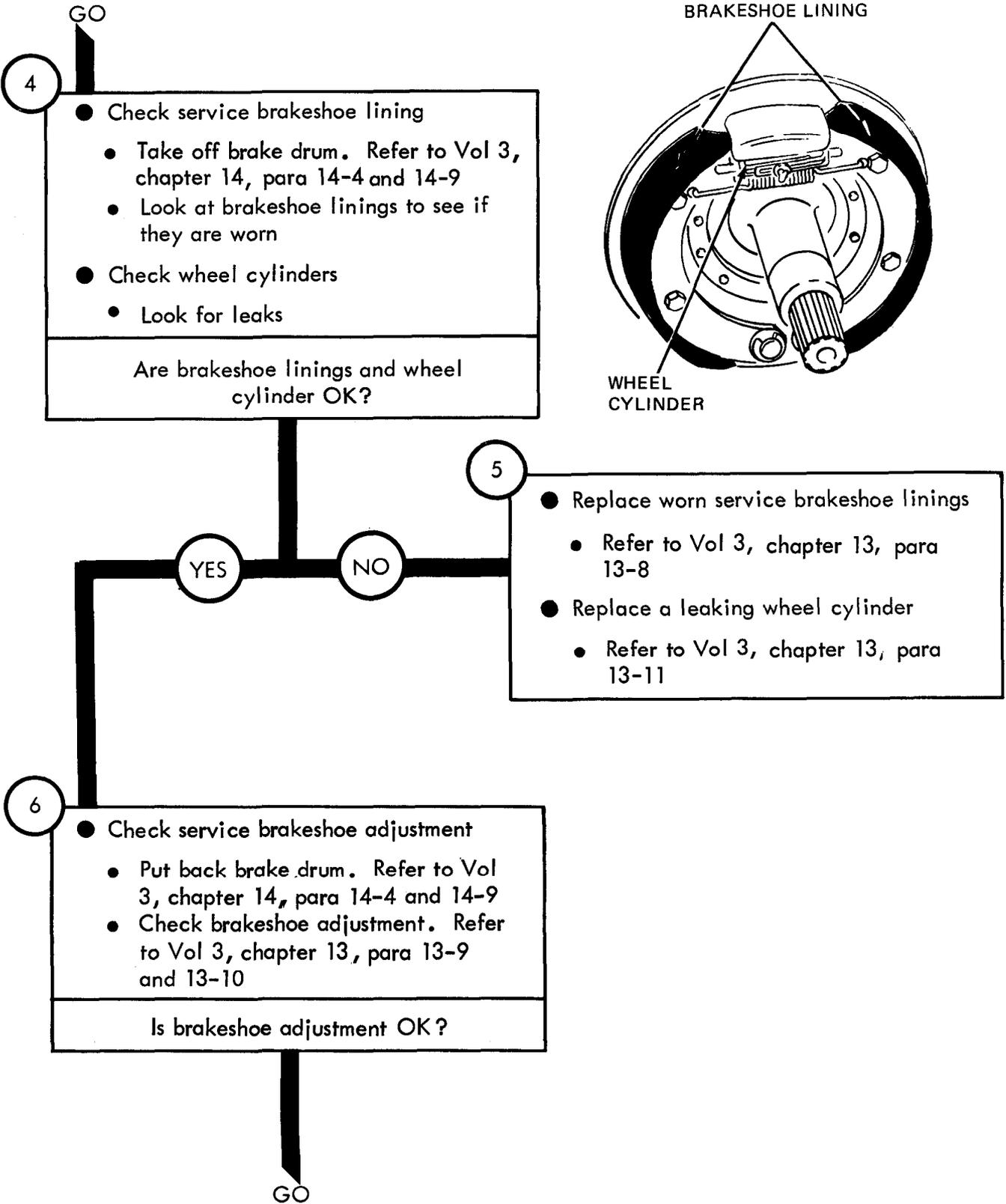
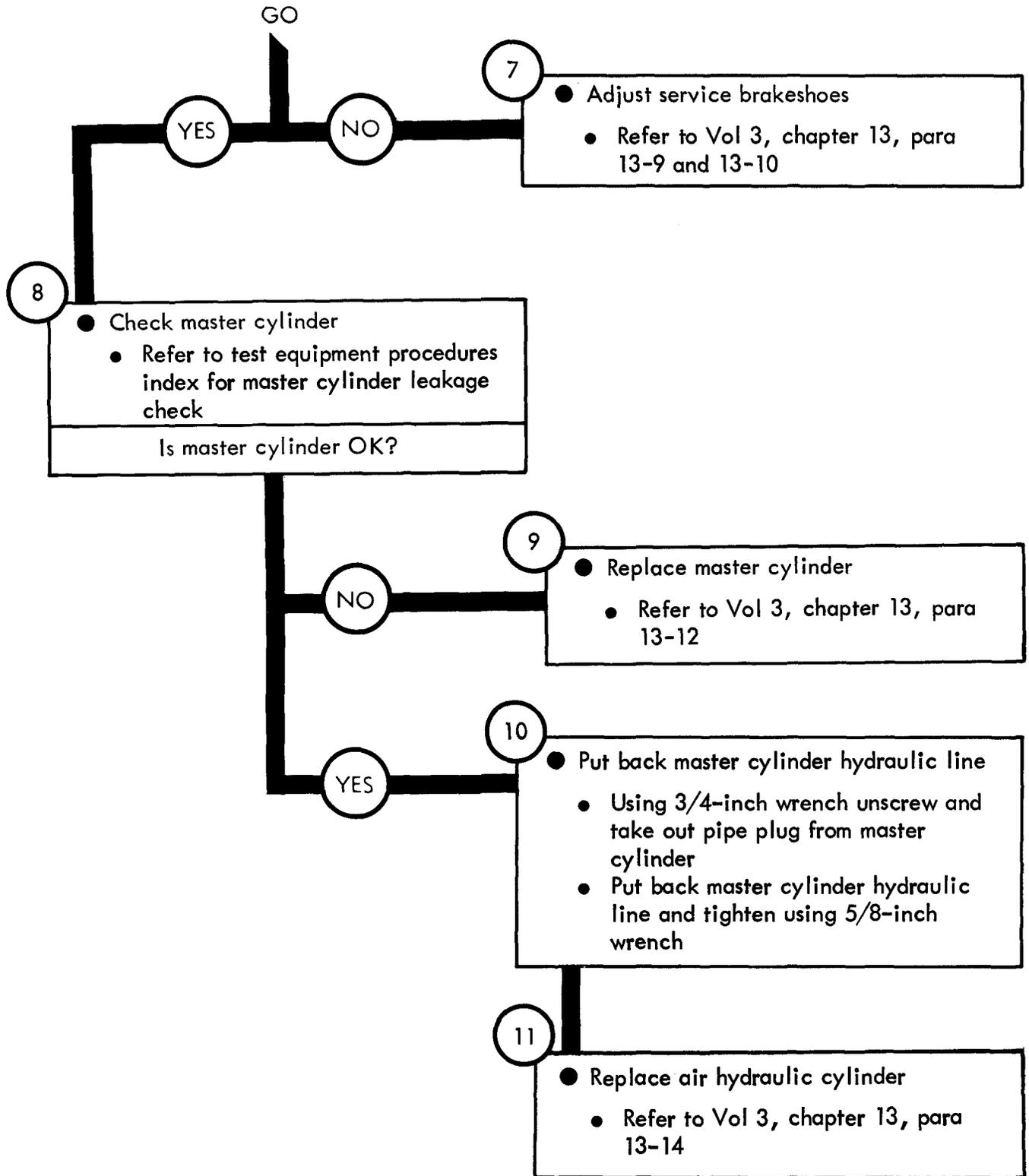

Figure 44-4 (Sheet 2 of 3)

TA 114844



TA 114845

Figure 44-4 (Sheet 3 of 3)

Symptom

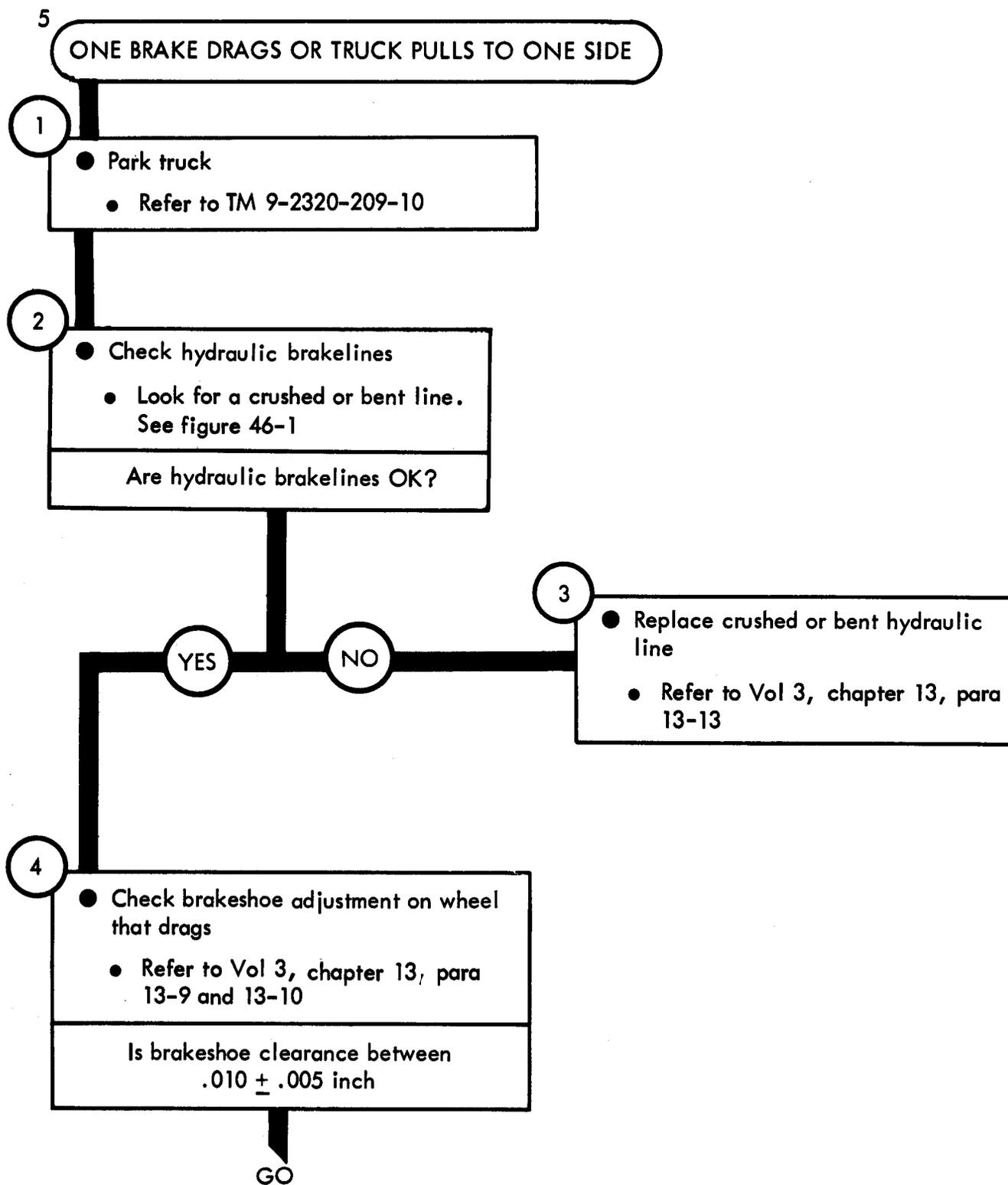

Figure 44-5 (Sheet 1 of 3)

TA 114846

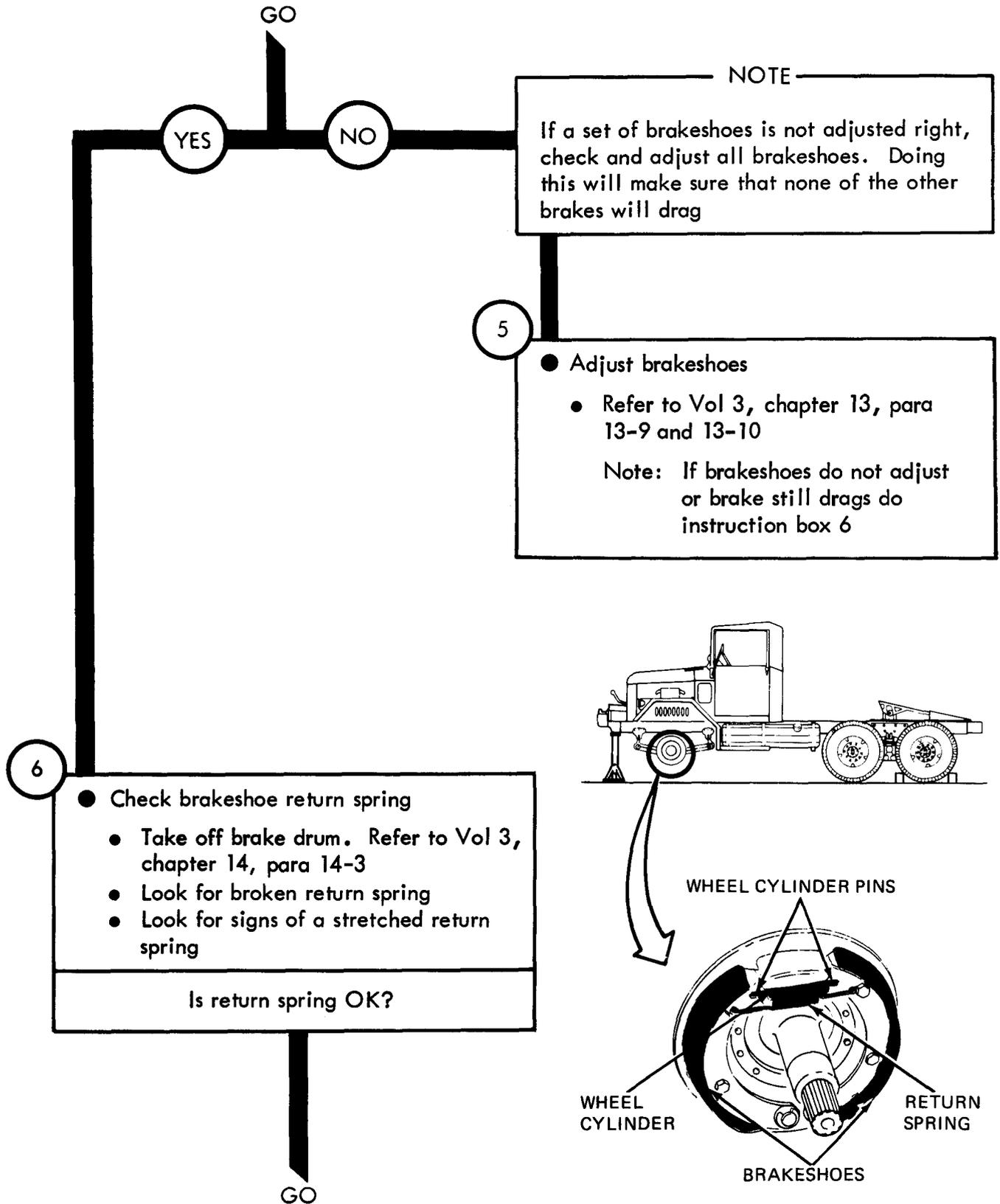

Figure 44-5 (Sheet 2 of 3)

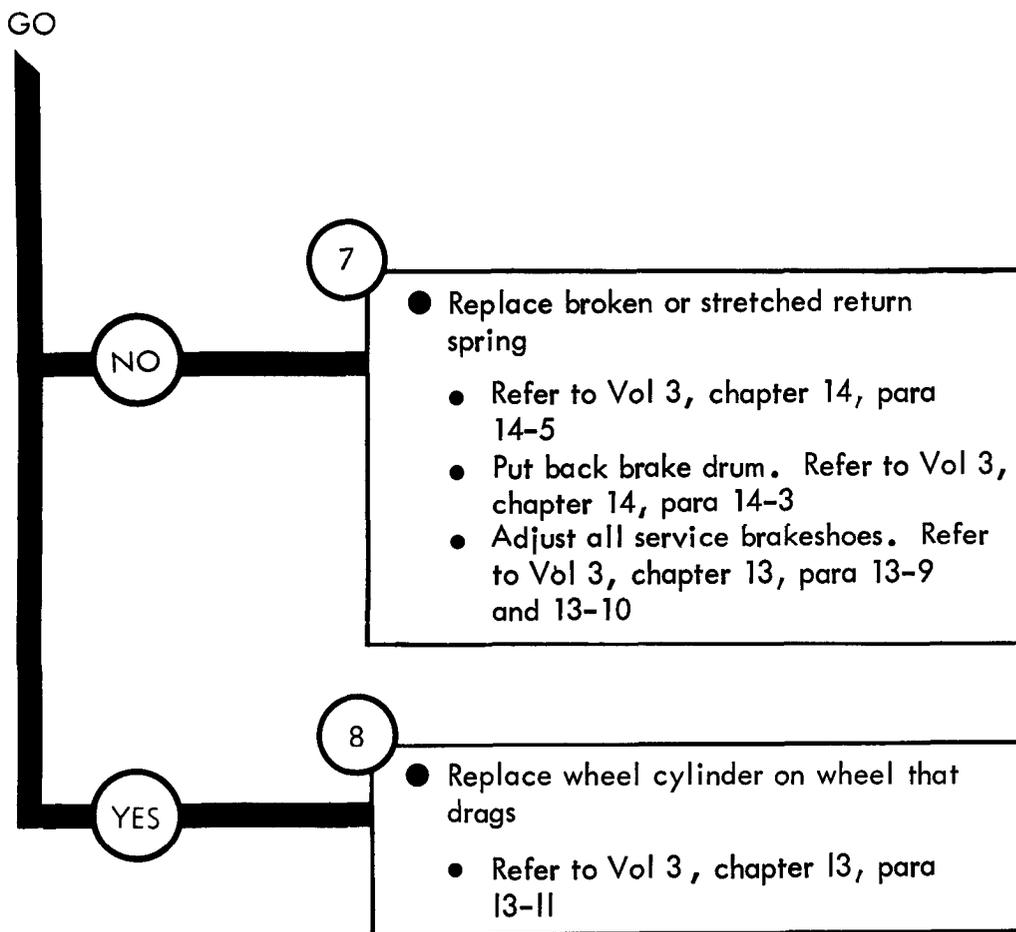

Figure 44-5 (Sheet 3 of 3)

TA 114848

Symptom

6

BRAKES DRAG

1

- Park truck
- Refer to TM 9-2320-209-10

2

- Check brake pedal free play
 - Slowly push down on brake pedal
 - Feel if pedal travels freely 1/4 or 1/2-inch before brake pressure is felt
- Is pedal free play OK?

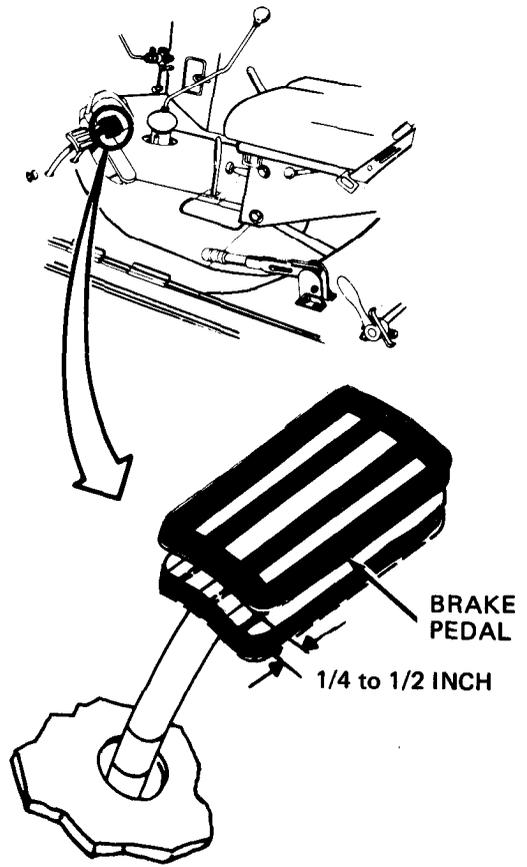

3

- Adjust brake pedal free play
- Refer to Vol 3, chapter 13, para 13-19

YES

NO

4

- Check master cylinder hydraulic line
 - Look for a crushed or kinked line. See figure 46-1
- Is hydraulic line OK?

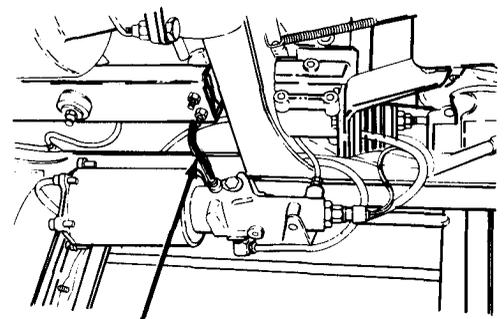

GO

Figure 44-6 (Sheet 1 of 5)

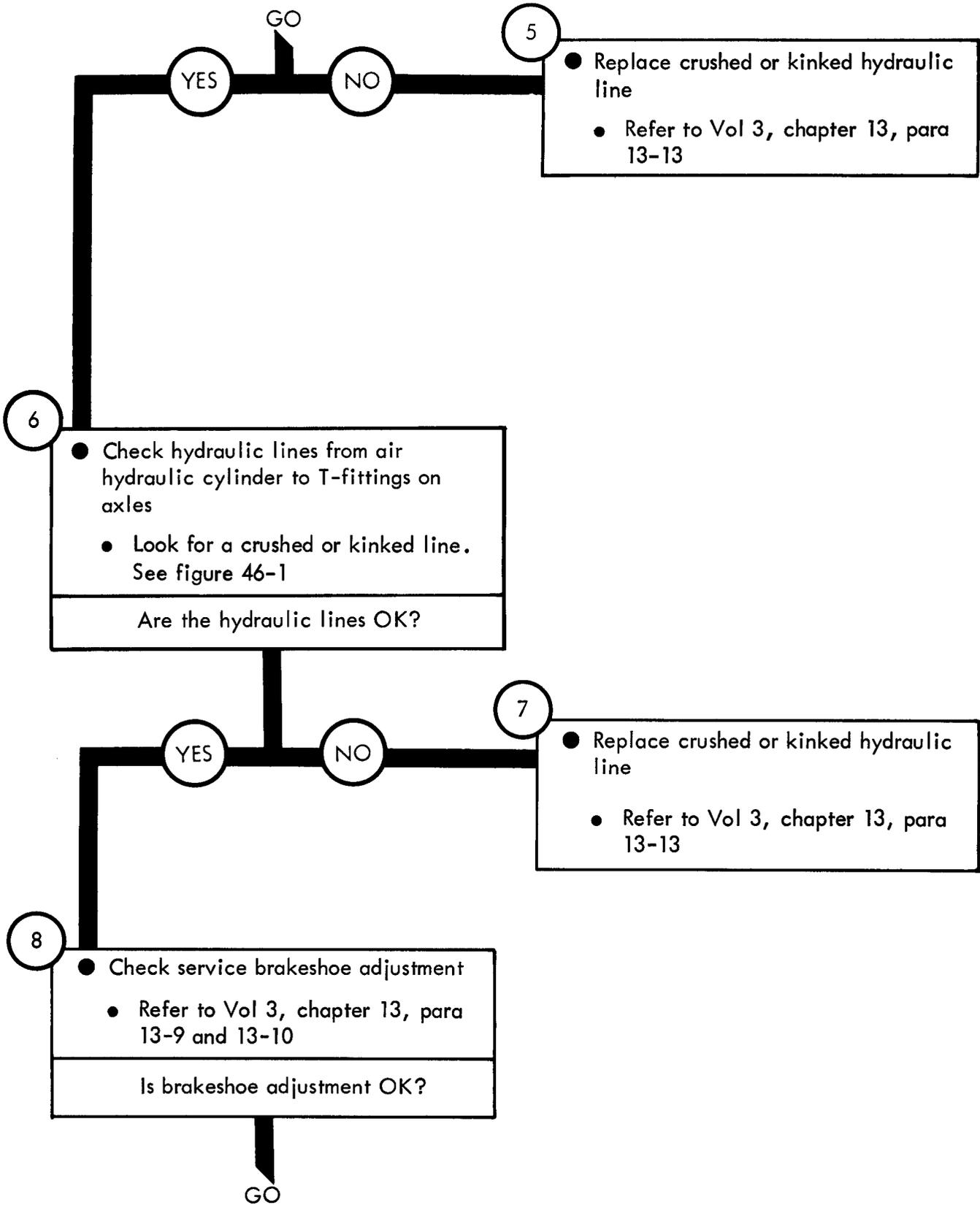

Figure 44-6 (Sheet 2 of 5)

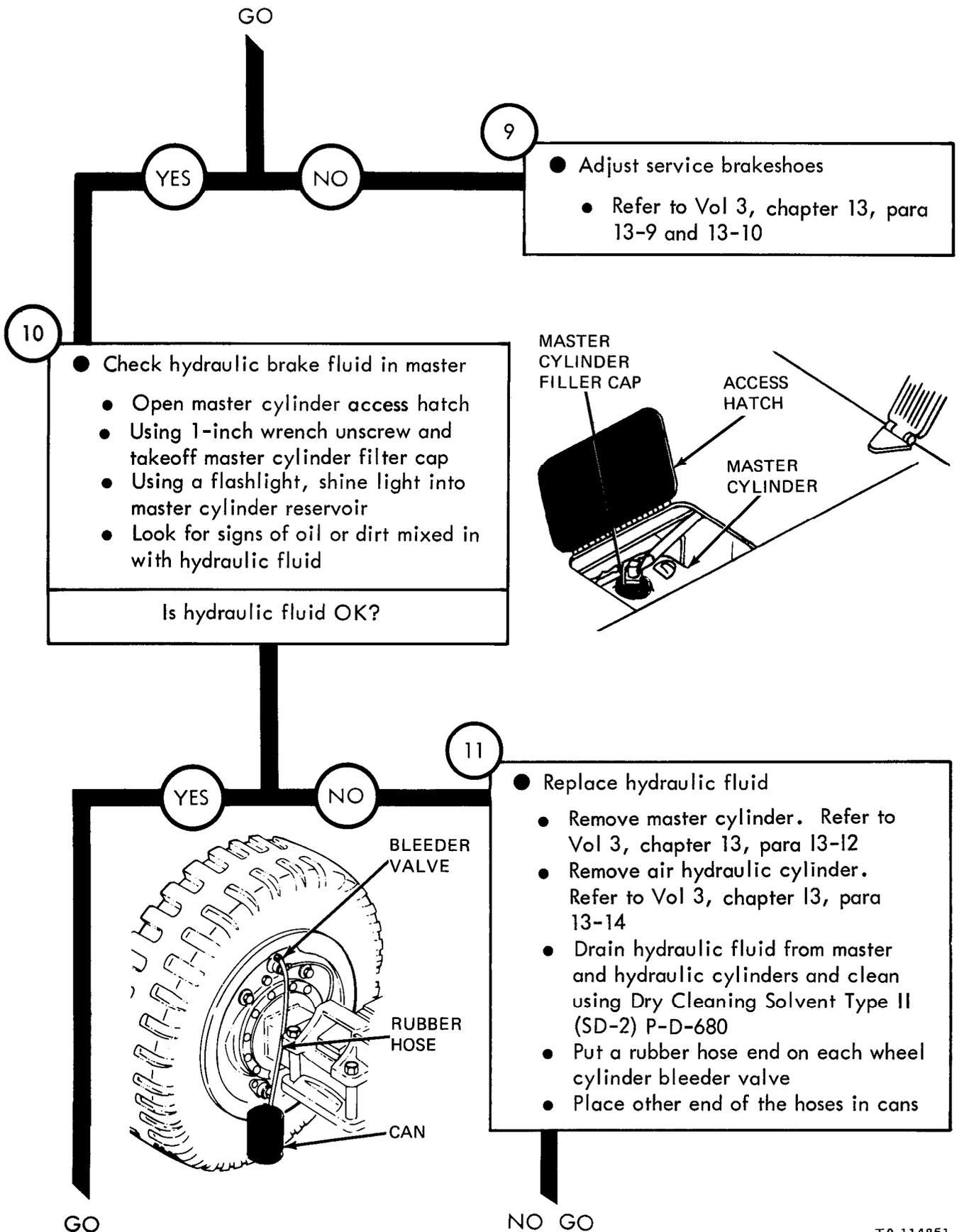

Figure 44-6 (Sheet 3 of 5)

TA 114851

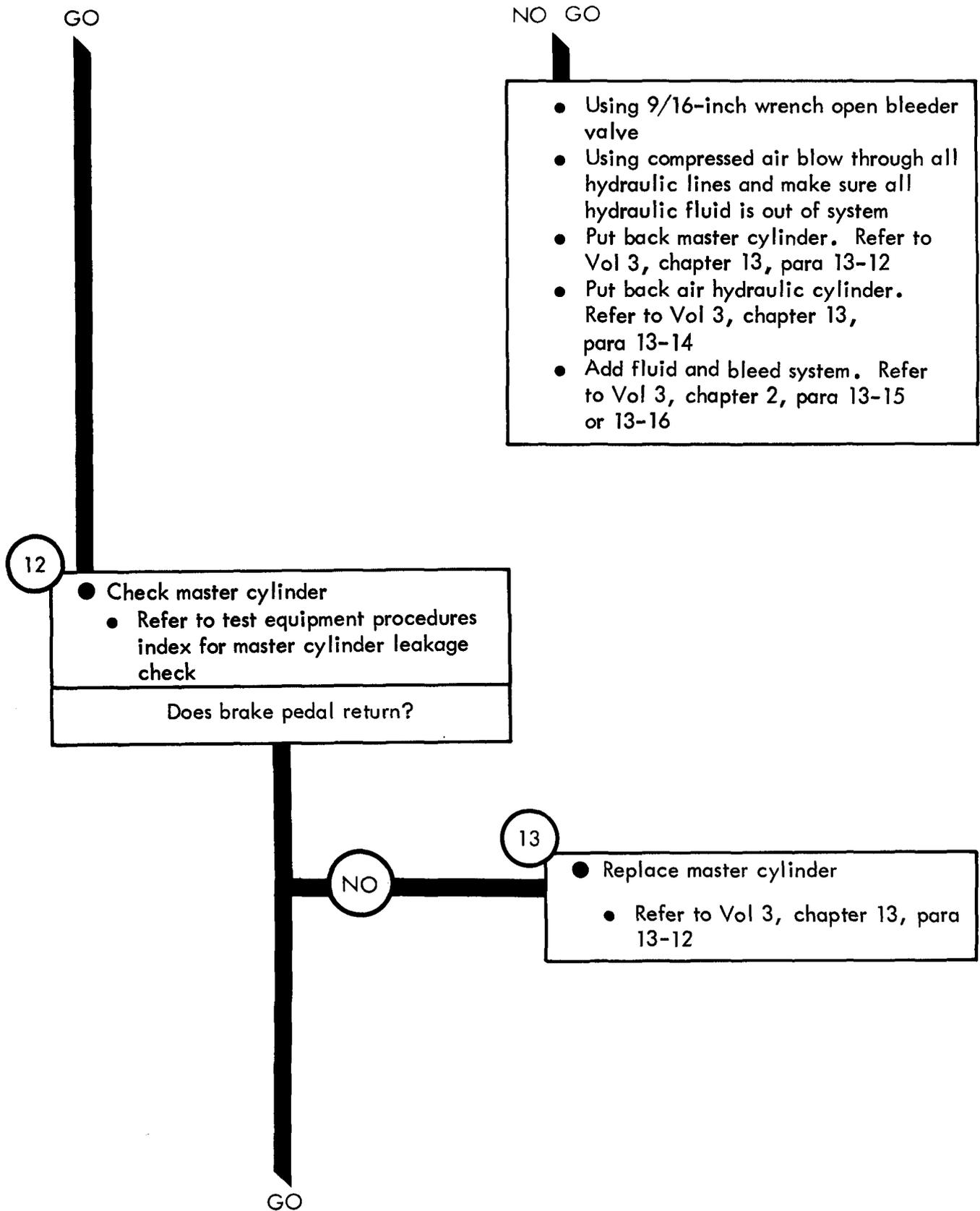

Figure 44-6 (Sheet 4 of 5)

TA 114852

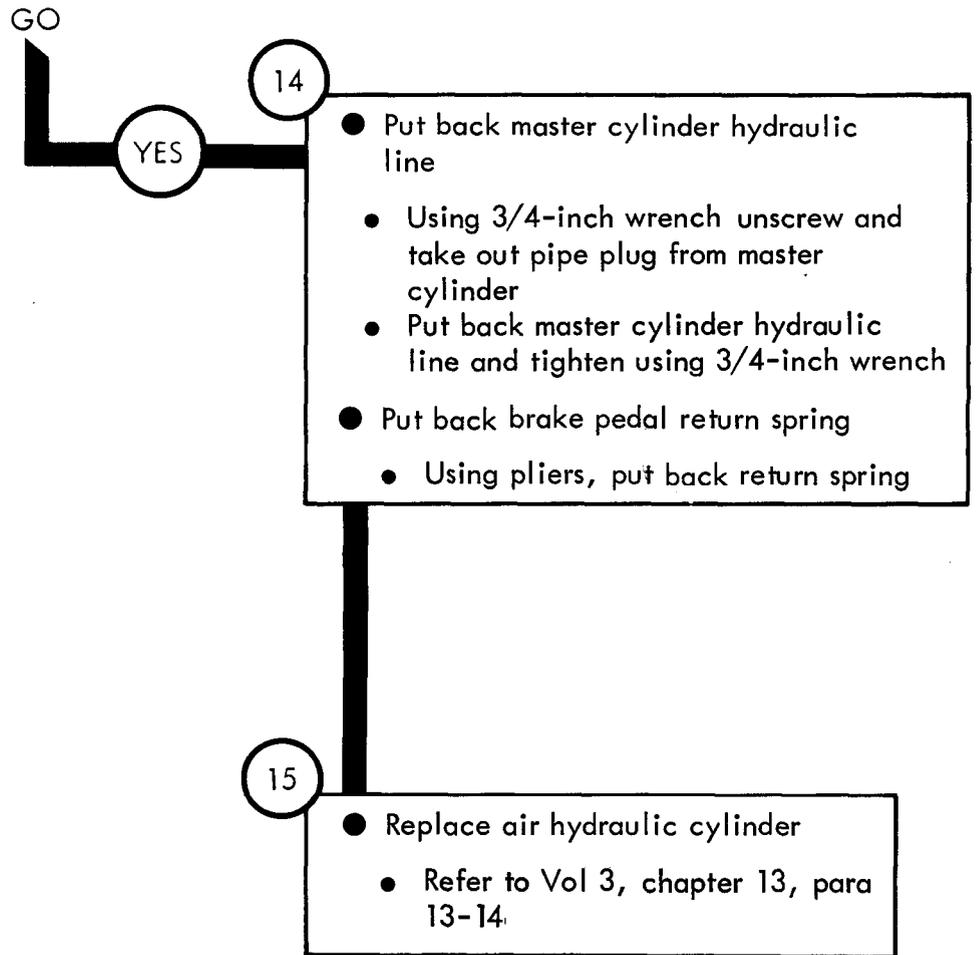

Figure 44-6 (Sheet 5 of 5)

TA 114853

44-23/(44-24 blank)

CHAPTER 45

BRAKE SYSTEM TROUBLESHOOTING SUMMARY

45-1. GENERAL. This chapter gives a summary of troubleshooting procedures given in chapter 44 for the brake system.

45-2. PROCEDURES. The summary in this chapter covers all fault symptoms found in the detailed troubleshooting procedures. Chapter 7 outlines a sample troubleshooting procedure. The summary procedures are based on the "what-to-do" portions of the detailed procedures and do not include the "how-to-do-it" instructions. Warnings, cautions, and notes are given where needed.

BRAKE SYSTEM TROUBLESHOOTING SUMMARY

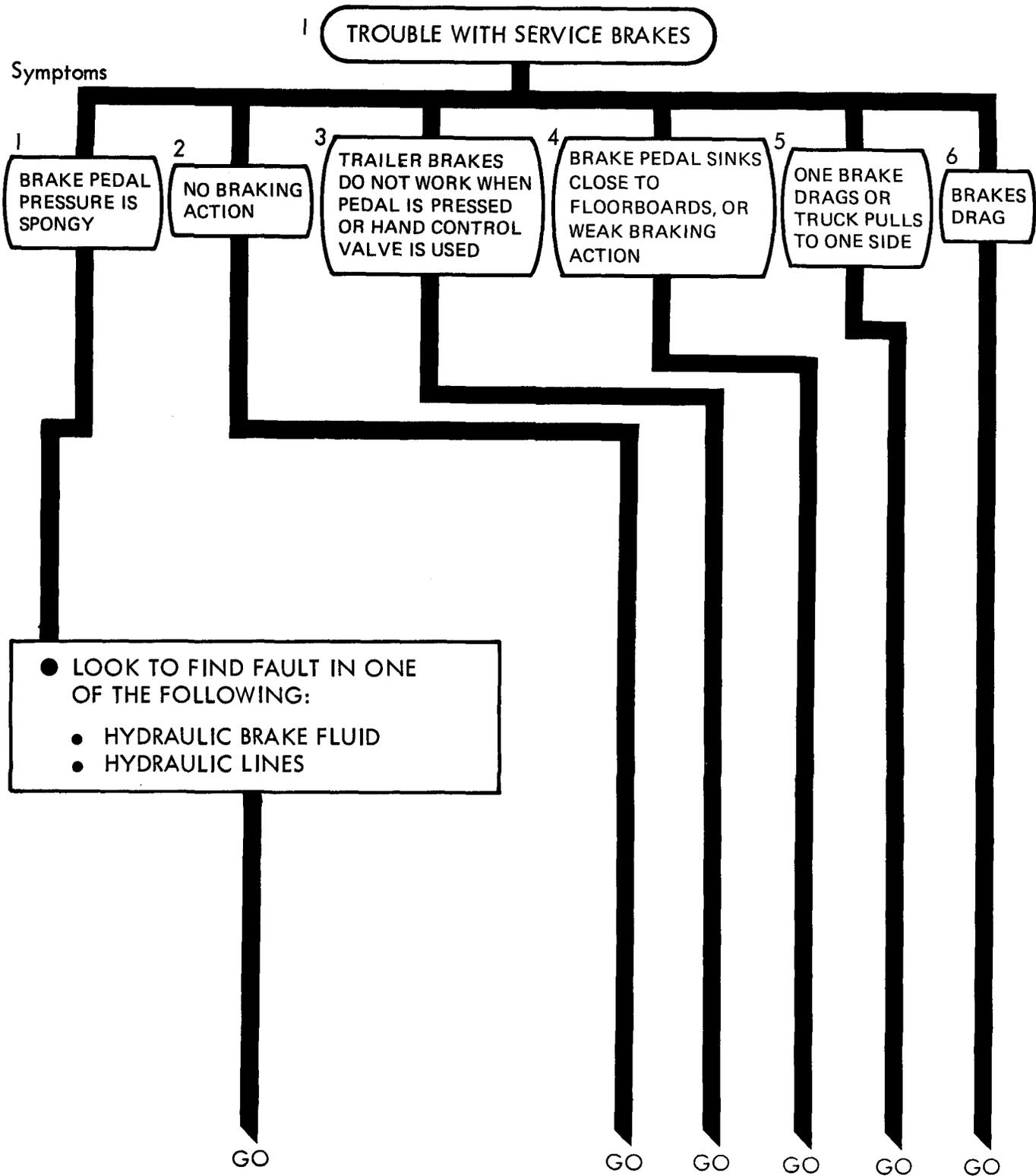

Figure 45-1 (Sheet 1 of 4)

TA 114854

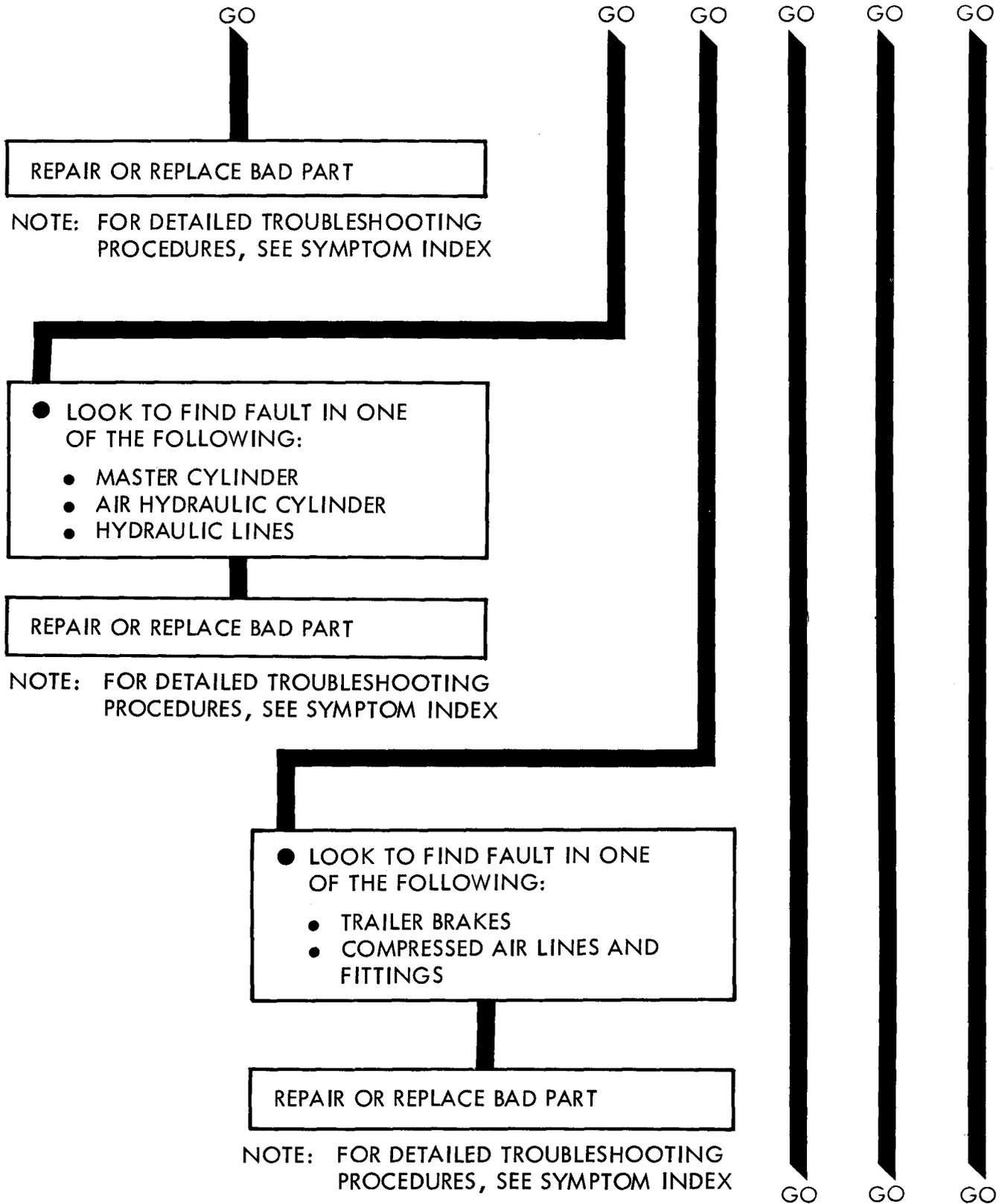

Figure 45-1 (Sheet 2 of 4)

TA 114855

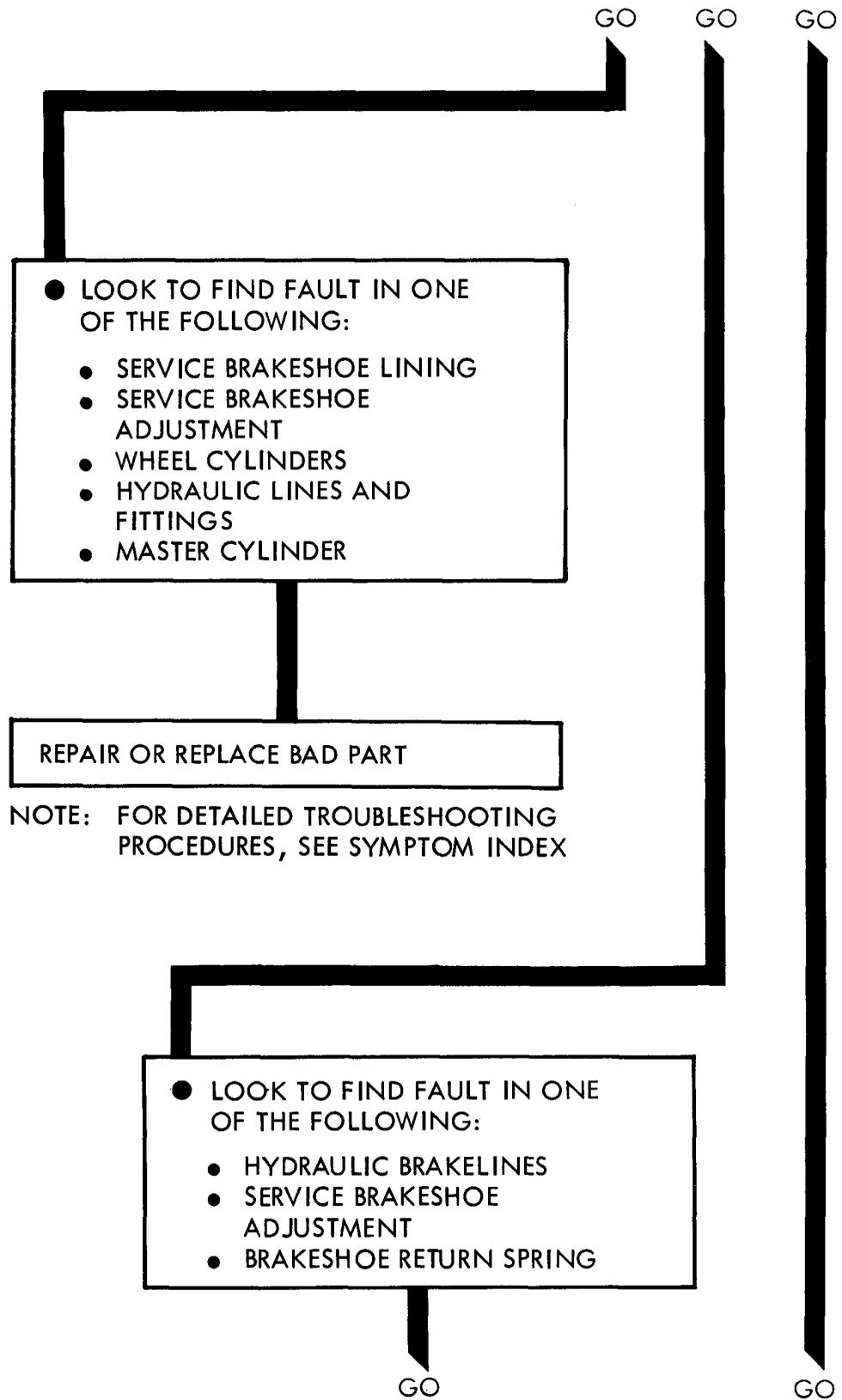

Figure 45-1 (Sheet 3 of 4)

TA 114856

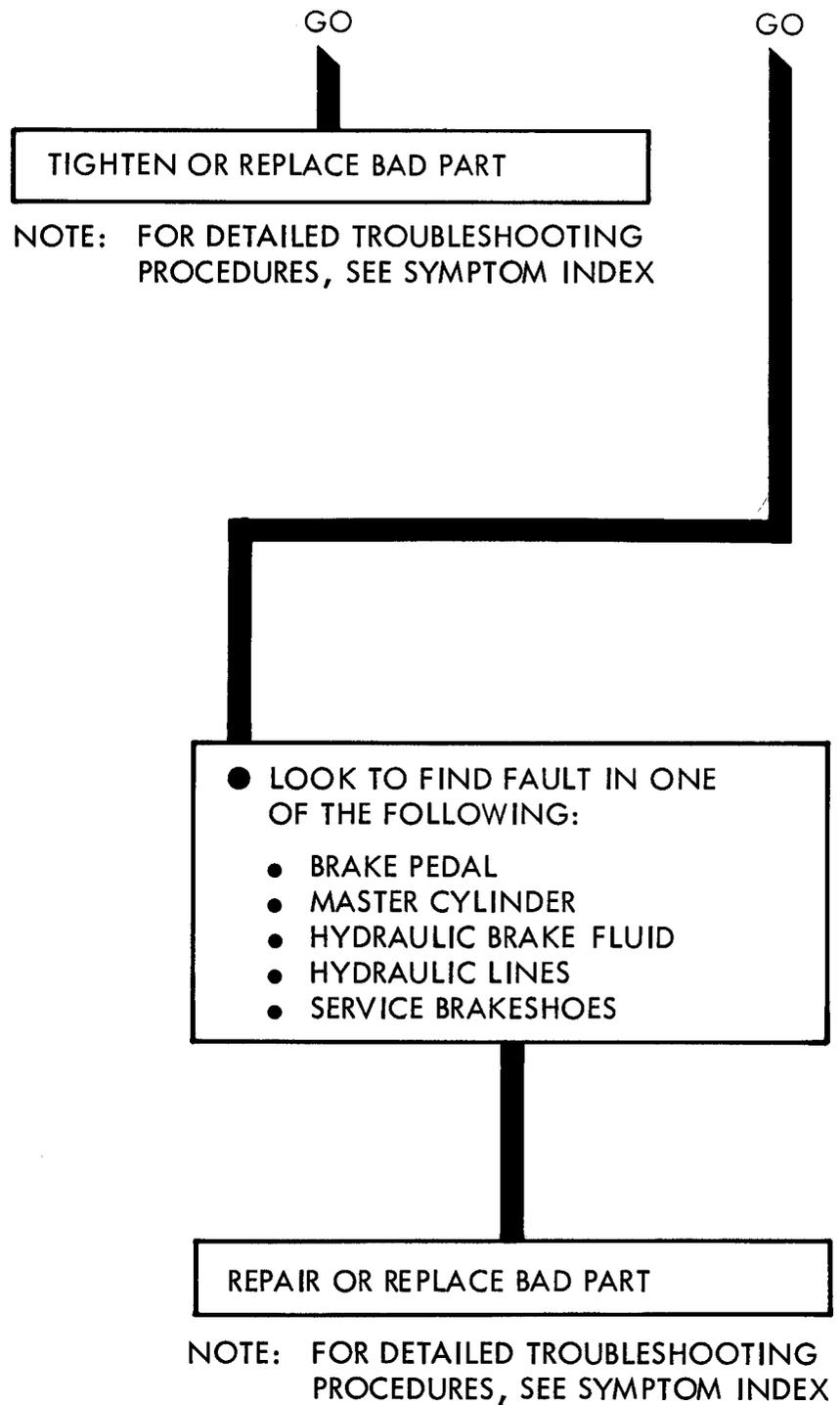
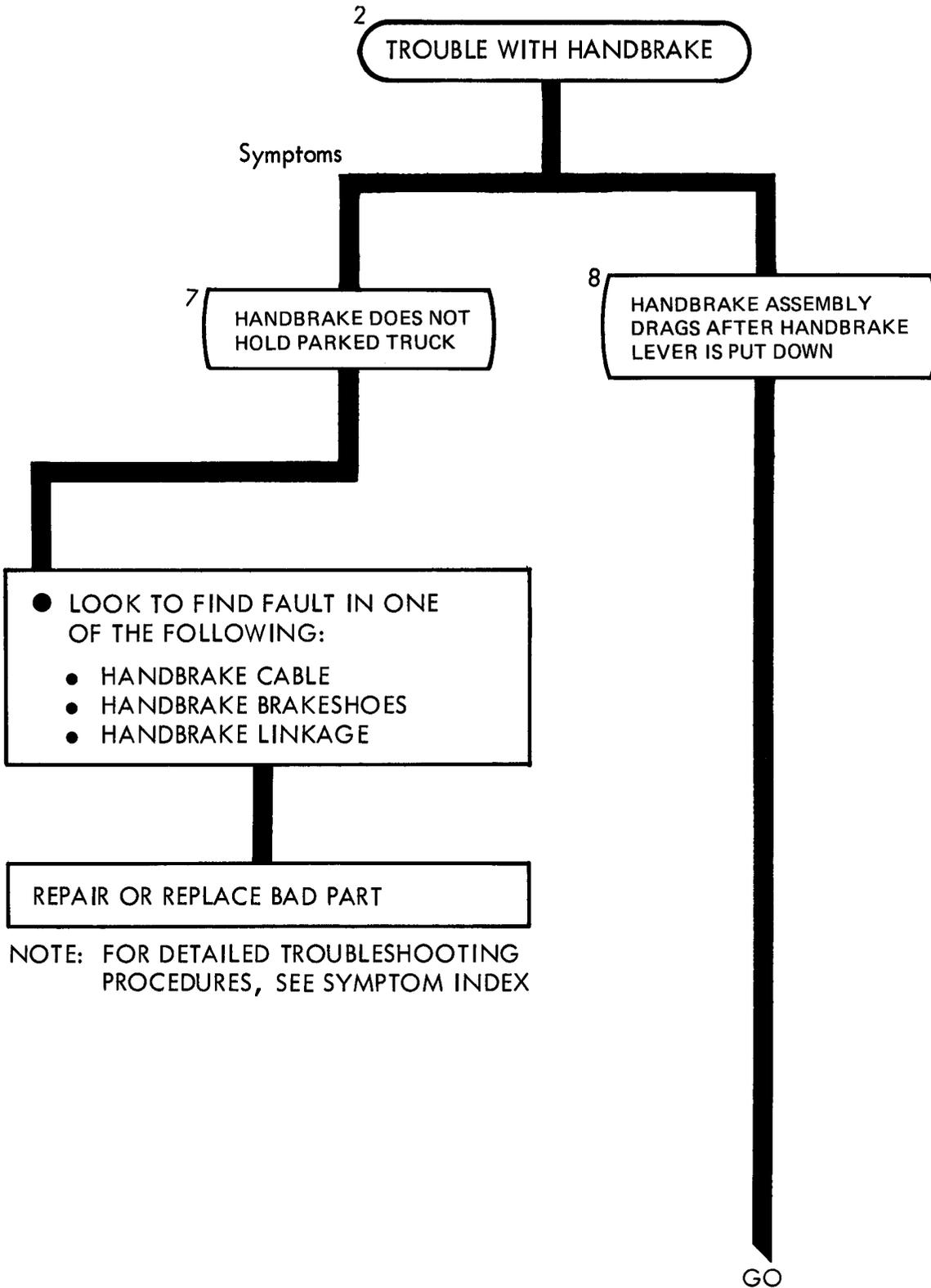
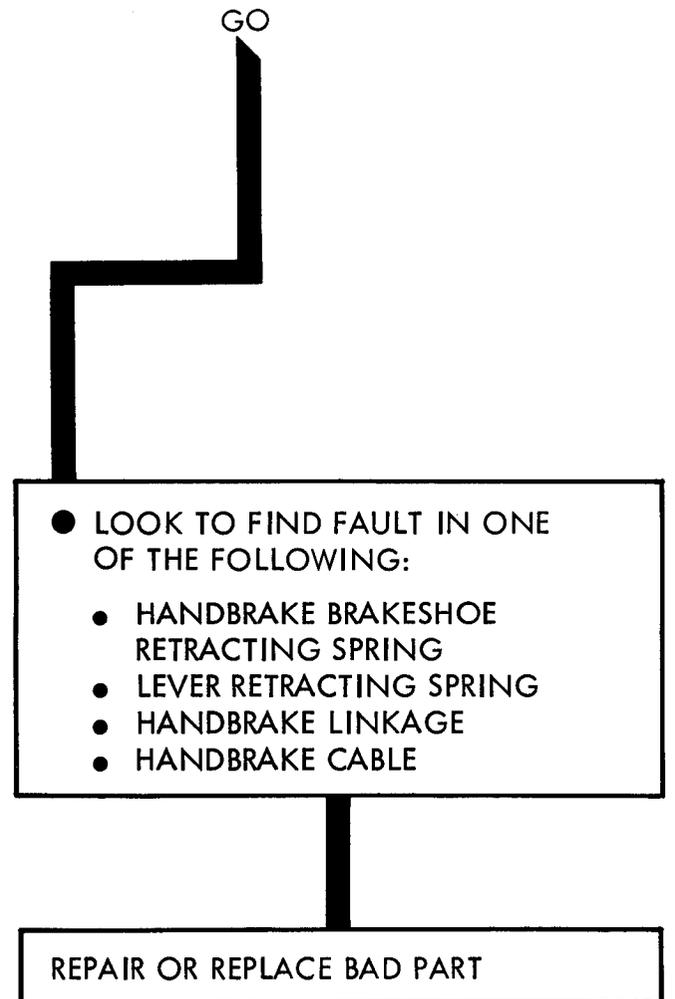

Figure 45-1 (Sheet 4 of 4)



NOTE: FOR DETAILED TROUBLESHOOTING PROCEDURES, SEE SYMPTOM INDEX

Figure 45-2 (Sheet 1 of 2)



NOTE: FOR DETAILED TROUBLESHOOTING PROCEDURES, SEE SYMPTOM INDEX

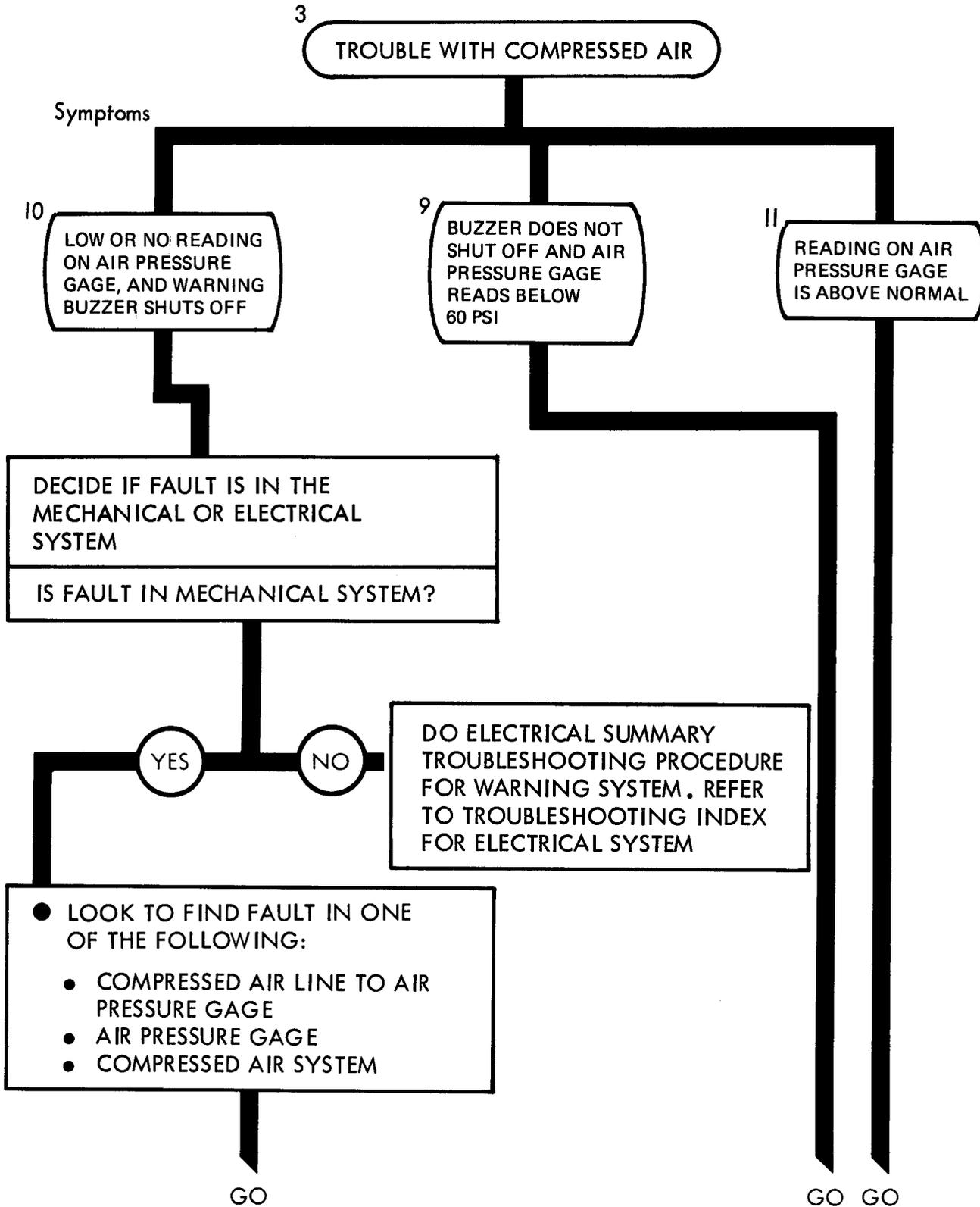

Figure 45-3 (Sheet 1 of 3)

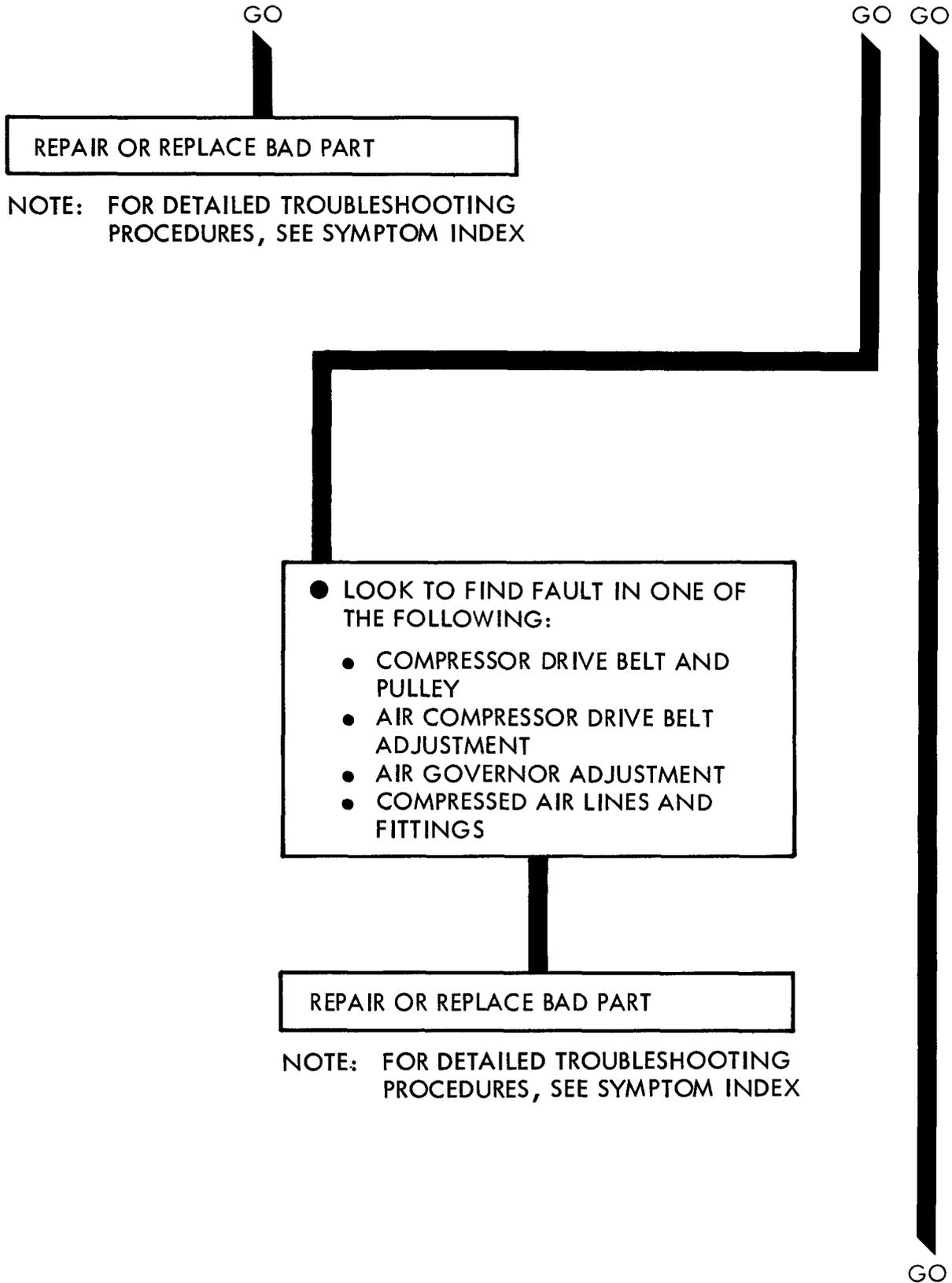
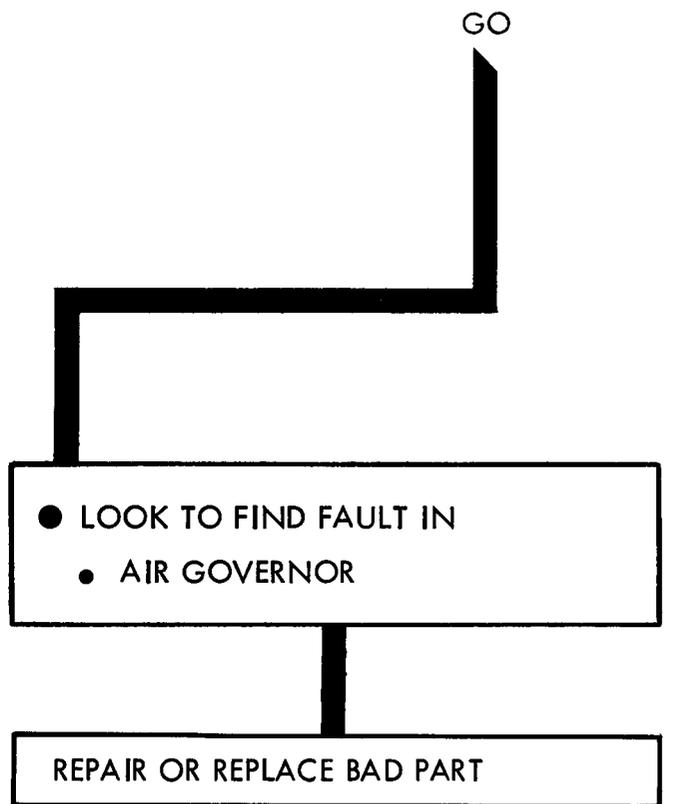

Figure 45-3 (Sheet 2 of 3)



NOTE: FOR DETAILED TROUBLESHOOTING PROCEDURES, SEE SYMPTOM INDEX

Figure 45-3 (Sheet 3 of 3)

CHAPTER 46

BRAKE SYSTEM SUPPORT DIAGRAMS

46-1. GENERAL. This chapter gives the diagrams you need when doing troubleshooting procedures in chapter 44. Table 3-1 is a complete listing of all support diagrams used in this manual.

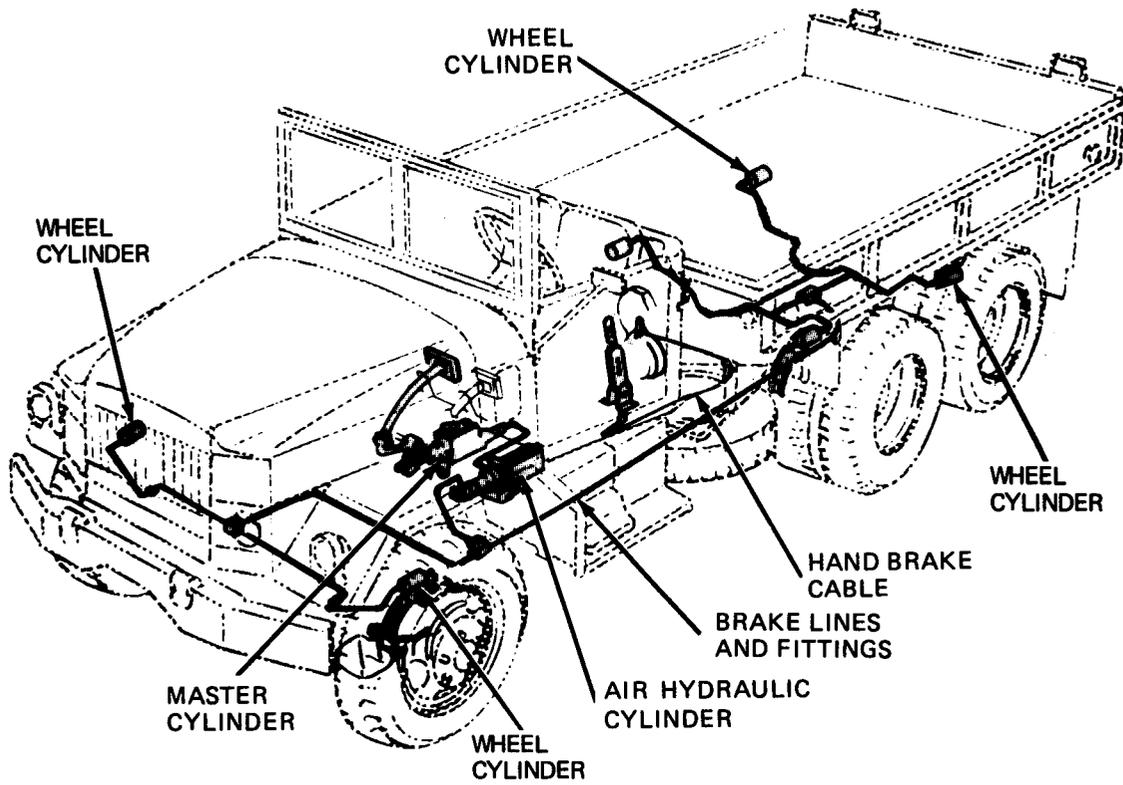

TA 114863

Figure 46-1. Brake System Support Diagram

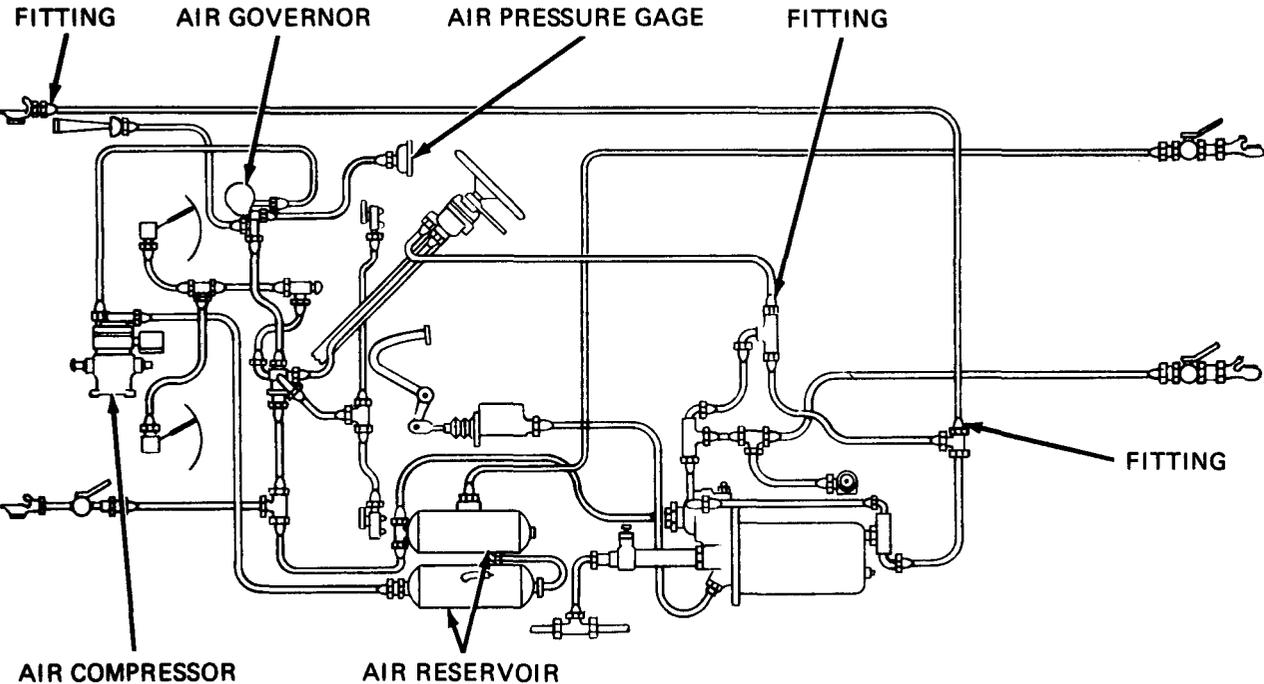

TA 114864

Figure 46-2. Compressed Air Subsystem Support Diagram

CHAPTER 47

HANDBRAKE SUBSYSTEM TROUBLESHOOTING

47-1. EQUIPMENT ITEMS COVERED. This chapter gives equipment troubleshooting procedures for the handbrake subsystem, for which there are authorized corrective maintenance tasks at the organizational maintenance level.

47-2. EQUIPMENT ITEMS NOT COVERED. All equipment items for which corrective maintenance is authorized at the organizational maintenance level are covered in this chapter.

HANDBRAKE SUBSYSTEM TROUBLESHOOTING

Symptom

7 HANDBRAKE DOES NOT HOLD PARKED TRUCK

1

- Make truck ready for work on handbrake
 - Park truck. Refer to TM 9-2320-209-10

2

- Check handbrake cable
 - Crawl under truck
 - Feel for loose cable end joints. See figure 46-1
 - Look for a broken cable

Is handbrake cable OK?

YES

NO

3

- Tighten loose cable end joints
 - Refer to Vol 3, chapter 13, para 13-7
- Replace broken handbrake cable
 - Refer to Vol 3, chapter 13, para 13-5

GO

Figure 47-1 (Sheet 1 of 3)

GO

4

- Check brakeshoes on handbrake assembly
 - Look for oil on linings or drum
 - Look for worn linings
 - Feel if brakeshoes are loose

Are the brakeshoe linings and drum OK?

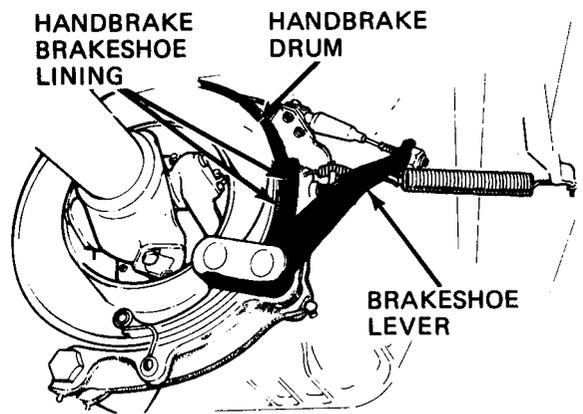

YES

NO

5

- Clean oily handbrake drum
 - Using dry cleaning solvent, type II (SD-2) Fed Spec P-D-680, on a rag wipe drum surface clean of oil
 - Wait about 30 minutes before doing next step
- Replace worn or oily brakeshoes
 - Refer to Vol 3, chapter 13, para 13-4
- Tighten loose brakeshoes
 - Refer to Vol 3, chapter 13, para 13-4

GO

Figure 47-1 (Sheet 2 of 3)

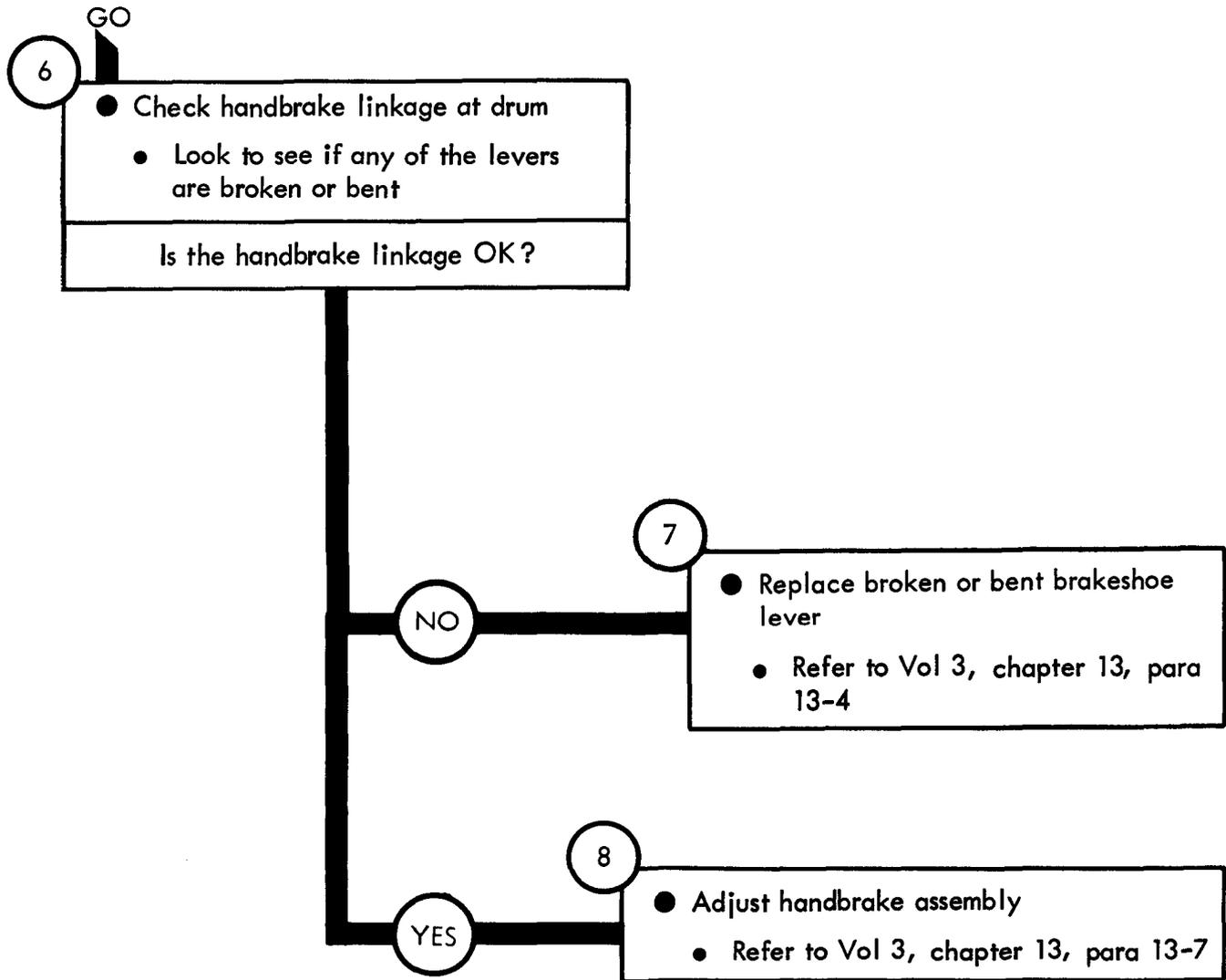

Figure 47-1 (Sheet 3 of 3)

Symptom

8 **HANDBRAKE ASSEMBLY DRAGS AFTER HANDBRAKE LEVER HAS BEEN PUT DOWN**

1

- Make truck ready for work on brake system
- Park truck. Refer to TM 9-2320-209-10

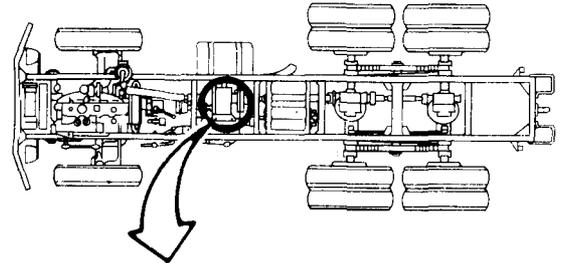

2

- Check brakeshoe retracting spring, and lever retracting spring at rear of transfer
 - Crawl under truck
 - Look for retracting springs that have come off mount
 - Look for worn or broken retracting spring

Are retracting springs OK?

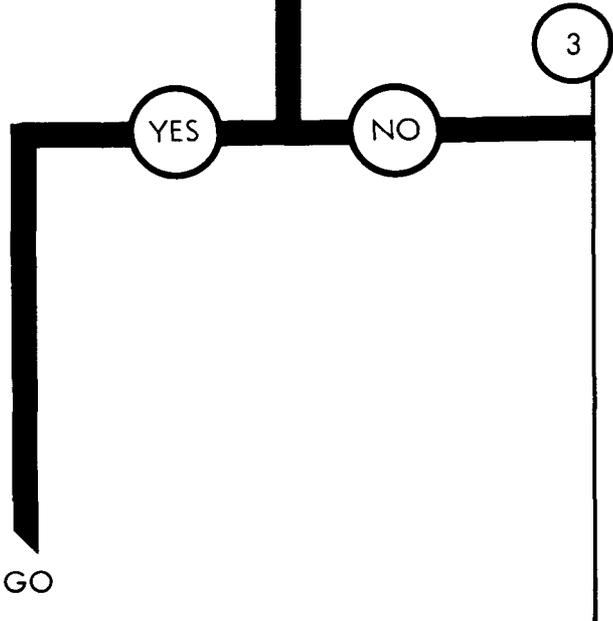
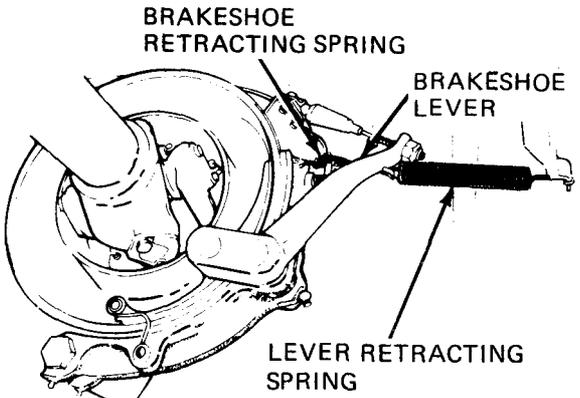

3

- Put back retracting spring that has come off mount
 - Using pliers stretch spring and hook on mounting eye
- Replace worn or broken hook on mounting eye brakeshoe retracting spring
 - Refer to Vol 3, chapter 13, para 13-4
- Replace worn or broken lever retracting spring
 - Refer to Vol 3, chapter 13, para 13-4

TA 114868

Figure 47-2 (Sheet 1 of 2)

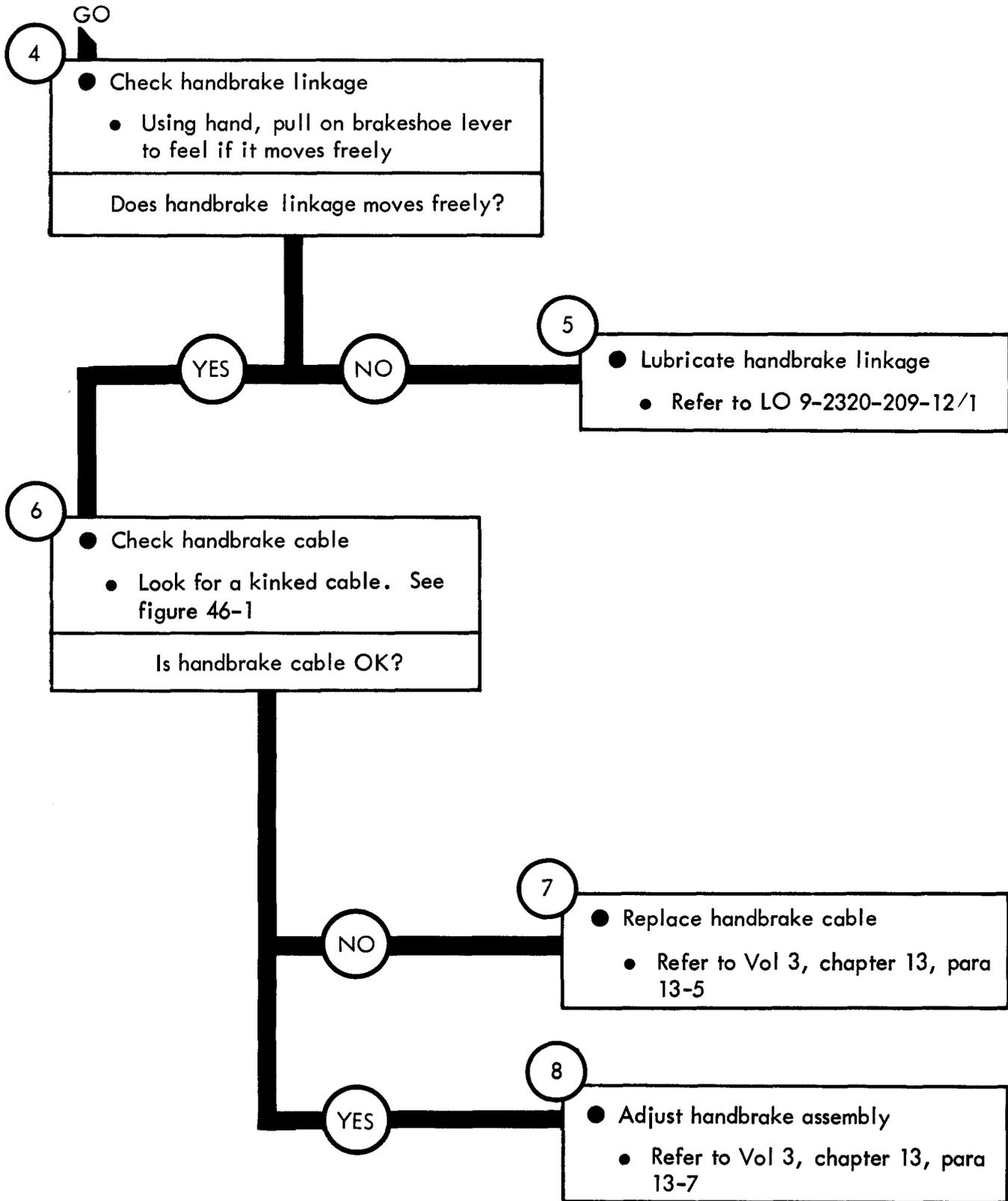

TA 114869

Figure 47-2 (Sheet 2 of 2)

CHAPTER 48

COMPRESSED AIR SUBSYSTEM TROUBLESHOOTING

48-1. EQUIPMENT ITEMS COVERED. This chapter gives equipment troubleshooting procedures for the compressed air subsystem, for which there are authorized corrective maintenance tasks at the organizational maintenance level.

48-2. EQUIPMENT ITEMS NOT COVERED. All equipment items for which corrective maintenance is authorized at the organizational maintenance level are covered in this chapter.

COMPRESSED AIR SUBSYSTEM TROUBLESHOOTING

Symptom

9 BUZZER DOES NOT SHUT OFF AND AIR PRESSURE GAGE READS BELOW 60 PSI

1

- Park truck
 - Refer to TM 9-2320-209-10

2

- Check air compressor drive belt and pulley
 - Take off battery ground cable. Refer to Vol 3, chapter 7, para 7-58
 - Look for a broken belt
 - Look for signs of oil on belt and compressor pulley
- Check air compressor drive belt adjustment
 - Refer to Vol 3, chapter 13, para 13-34

Is air compressor drive belt OK?

AIR COMPRESSOR DRIVE BELT

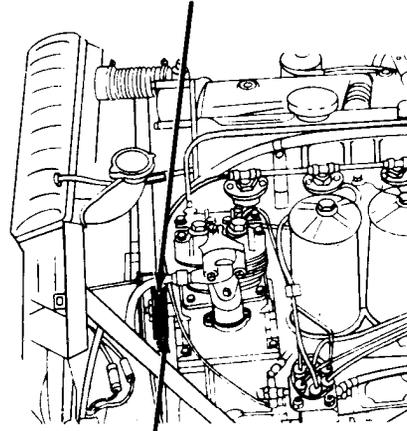

COMPRESSOR PULLEY

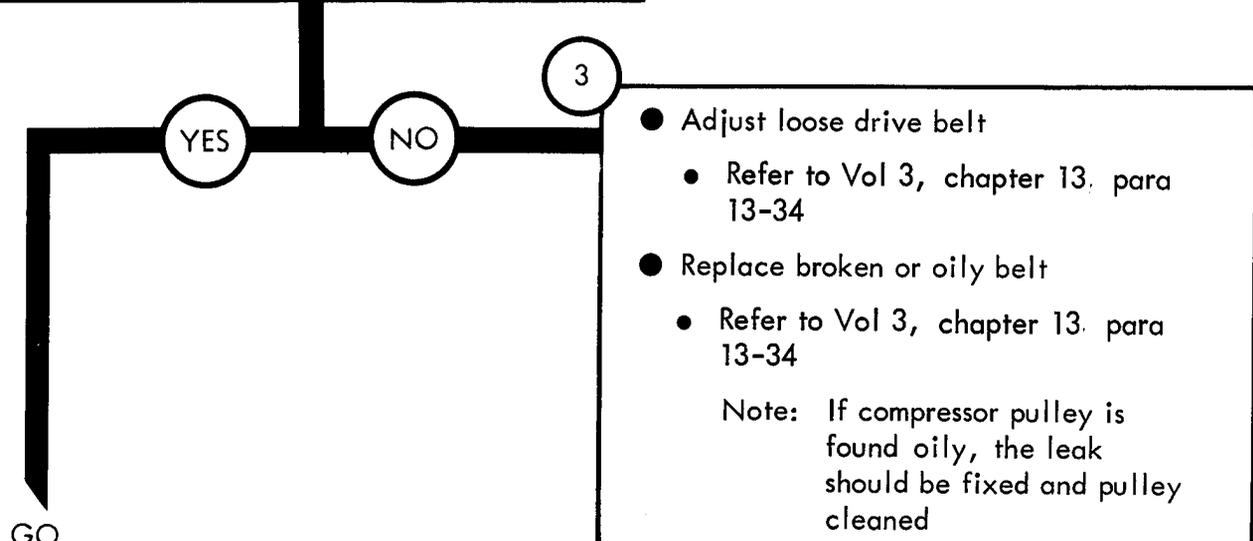

TA 114870

Figure 48-1 (Sheet 1 of 3)

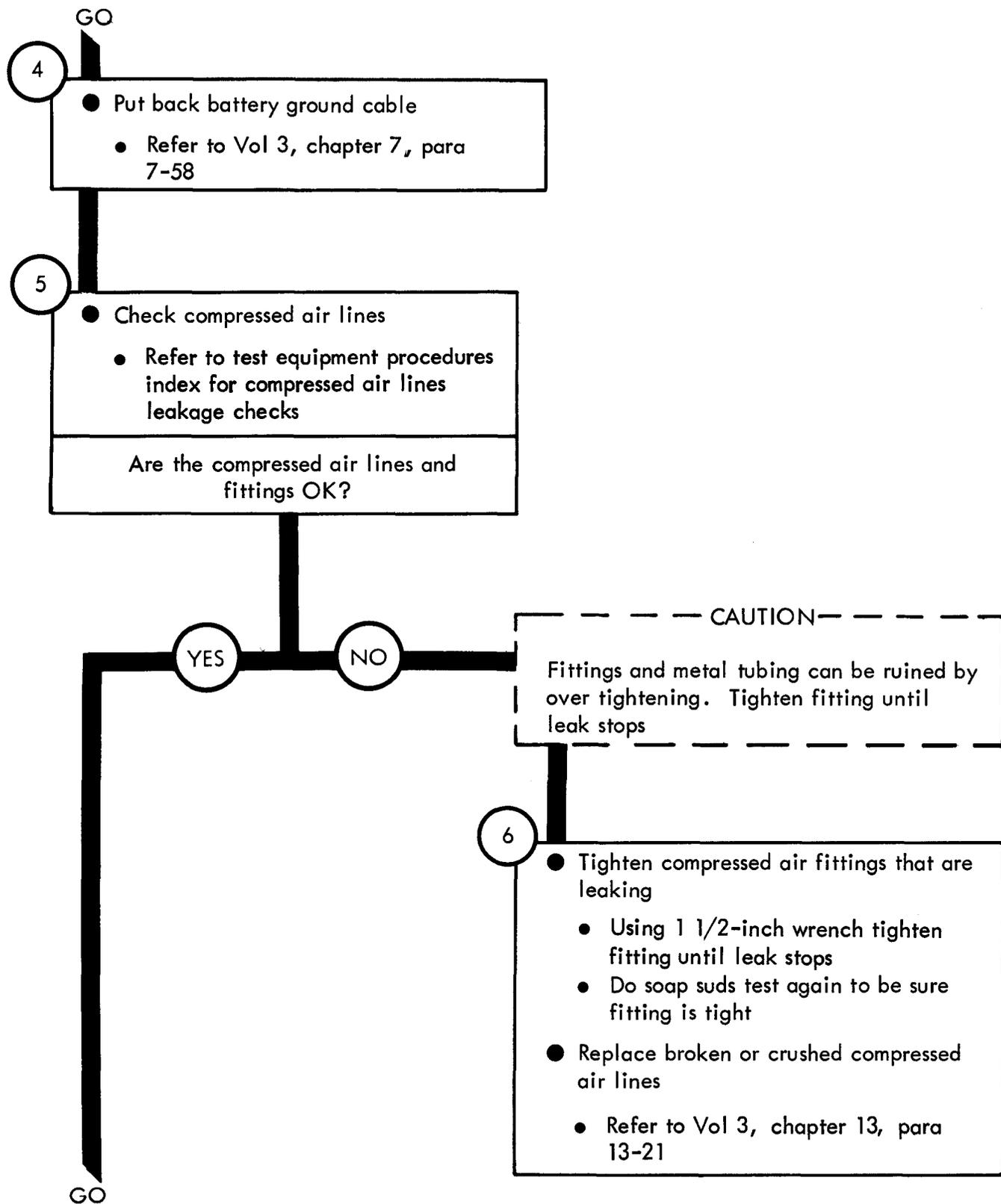

Figure 48-1 (Sheet 2 of 3)

TA 114871

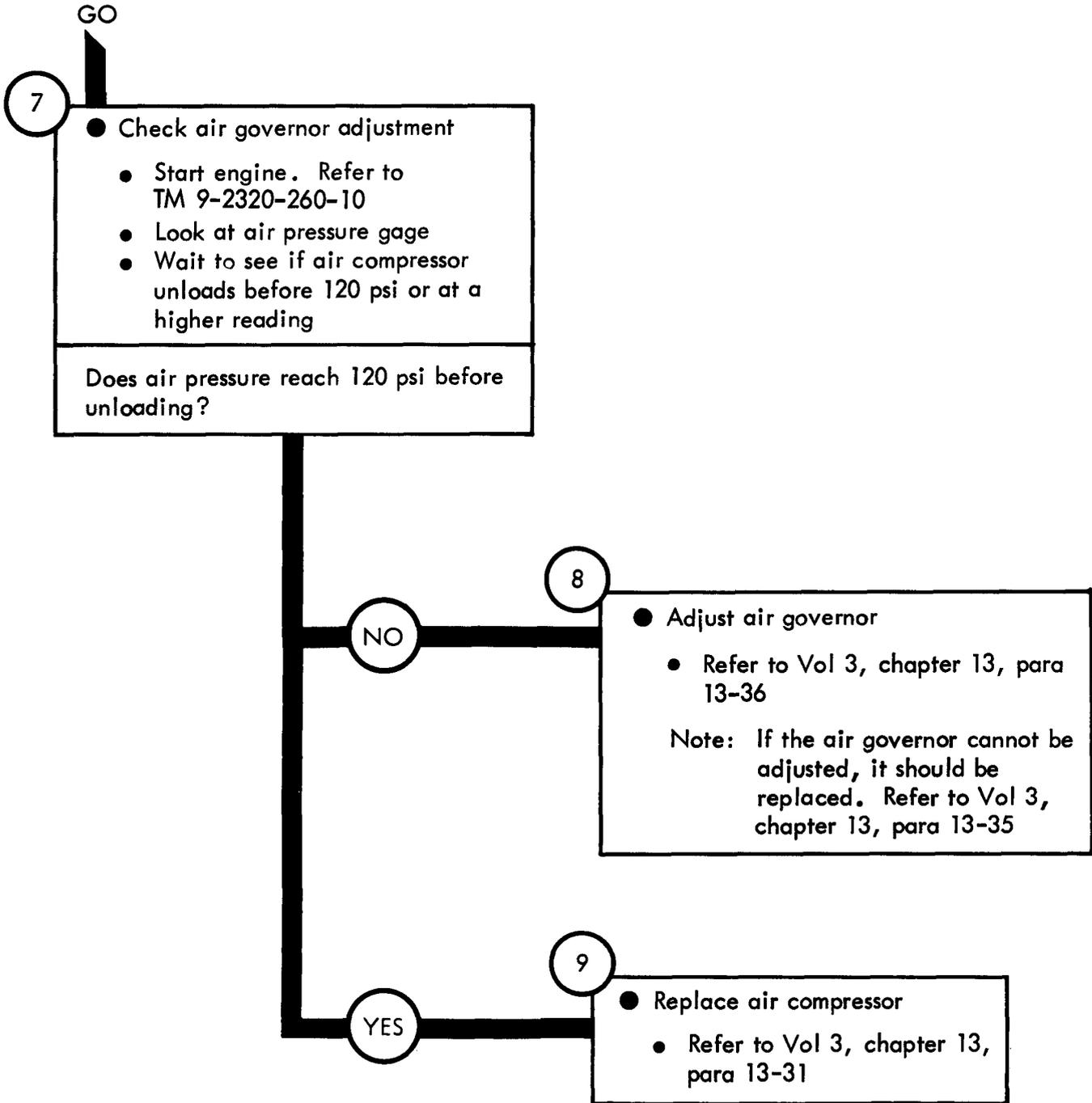

Figure 48-1 (Sheet 3 of 3)

Symptom

10
 LOW, OR NO READING ON AIR PRESSURE GAGE,
 AND WARNING BUZZER SHUTS OFF

- 1
- Turn engine off
 - Refer to TM 9-2320-209-10

NOTE

Air pressure gage is not part of the brake system functional group. The air pressure gage is part of the non-electrical gages group. Troubleshooting for the air pressure gage will be under the brake system. Air pressure gage fitting is behind instrument cluster

- 2
- Check compressed air line to air pressure gage
 - Using soapy water coat the fitting and look for air bubbles. See figure 49-1
- Is the air line fitting tight?

GO

Figure 48-2 (Sheet 1 of 2)

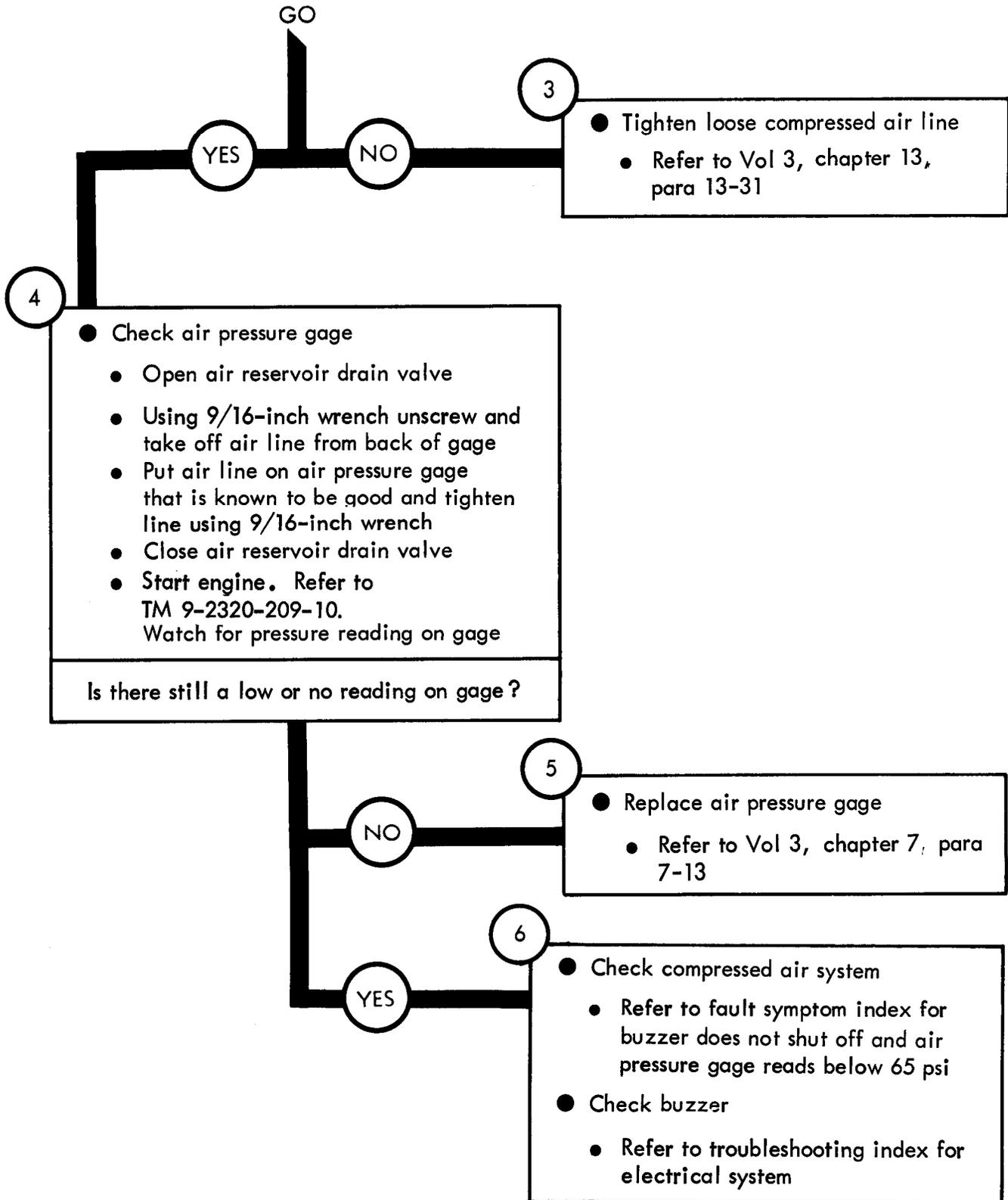

TA 114874

Figure 48-2 (Sheet 2 of 2)

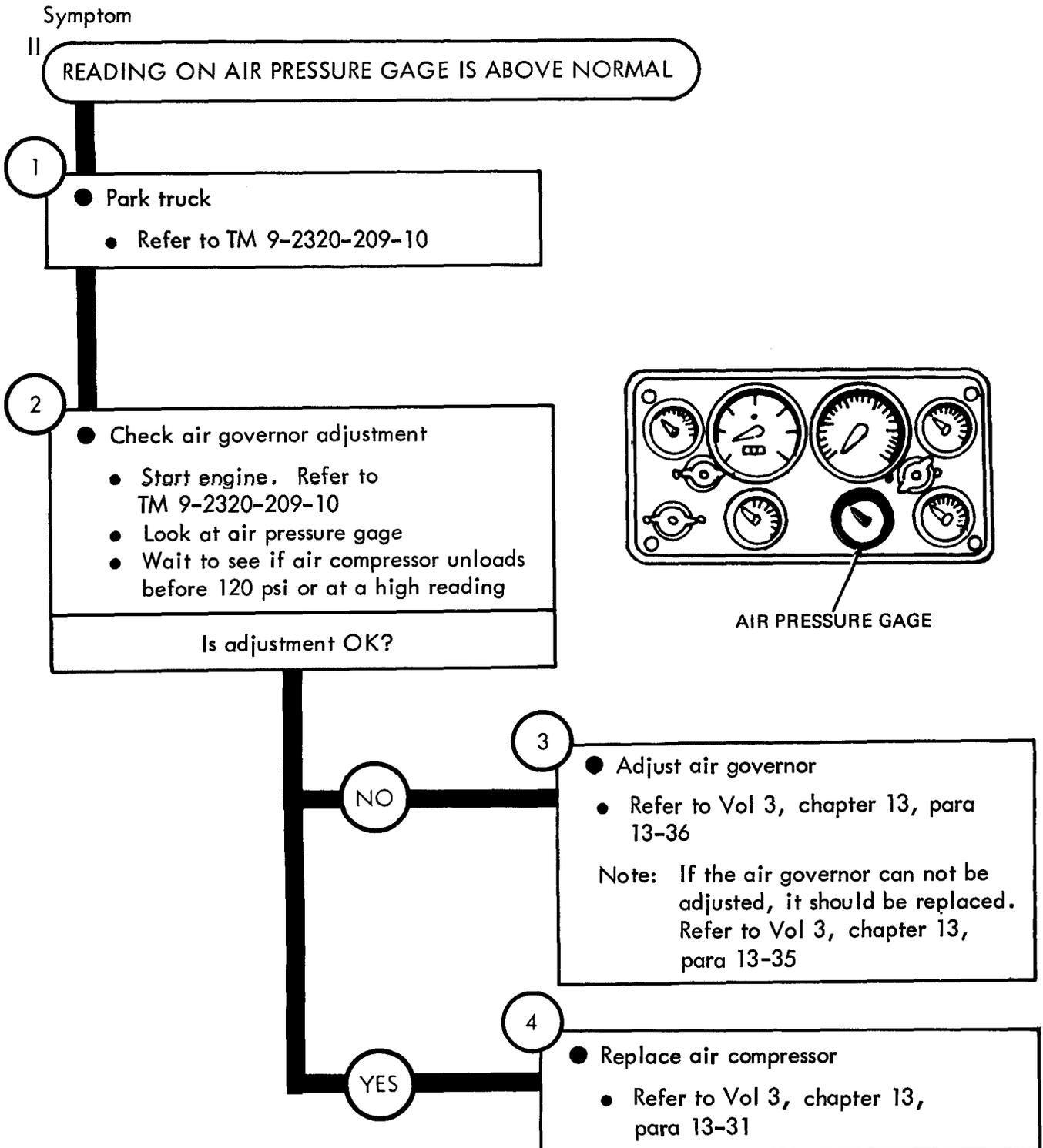

TA 114875

Figure 48-3

CHAPTER 49

BRAKE SYSTEM TEST PROCEDURES

49-1. GENERAL. This chapter gives test procedures for the tests given in chapter 44, for the brake system.

49-2. TEST SET-UP. Instructions for setup of test equipment and parts to be tested are given before the test procedures. Illustrations are used, when needed, to show you how to hook up the test equipment to the part to be tested.

49-3. TEST PROCEDURE. Detailed step-by-step instructions, in flow chart form, are given for each test. The procedure calls out the type of test and the condition of the truck system for each part of testing. The step-by-step test will lead you to the bad component or to a fault symptom within a related system. Reference is made to the fault symptom index, chapter 6, if the test shows a fault in another system.

BRAKE SYSTEM TROUBLESHOOTING TESTS

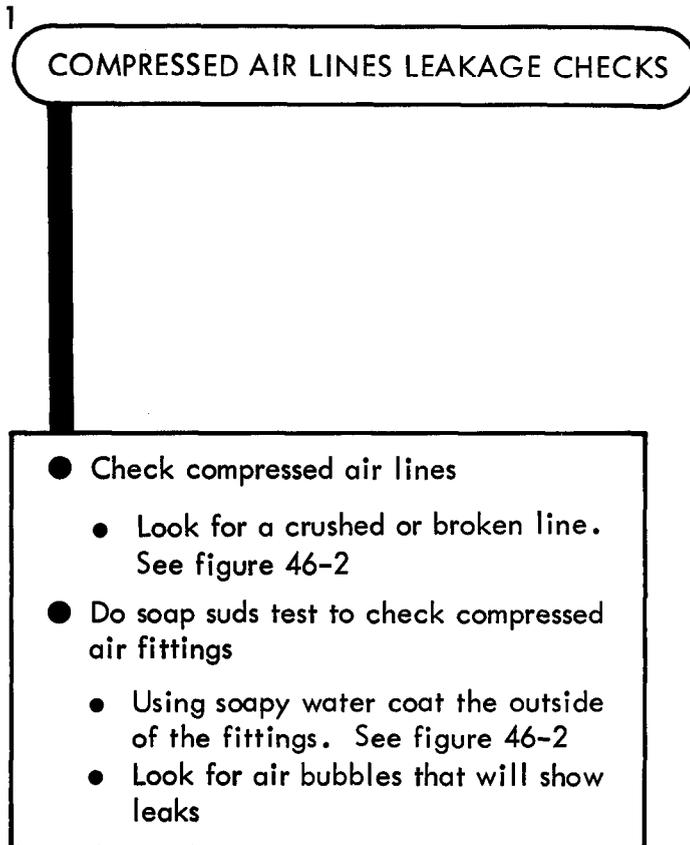

Figure 49-1

TA 114876

2

MASTER CYLINDER LEAKAGE TEST

- Check master cylinder

Note: These next two steps should be done quickly so that very little air enters master cylinder

- Using 5/8-inch wrench unscrew and take out hydraulic line from master cylinder. See figure 46-1
- Screw in a pipe plug and tighten using 3/4-inch wrench
- Using pliers take off brake pedal return spring
- Notice pedal position with spring off

- Push down on brake pedal as far as it will go
- Let go of brake pedal and see if pedal stays down, or comes back very slowly

TA 114877

Figure 49-2

3

AIR GOVERNOR ADJUSTMENT CHECK

- Check air governor adjustment
 - Start engine. Refer to TM 9-2320-209-10
 - Look at air pressure gage
 - Wait to see if air compressor unloads before 120 psi or at a higher reading

TA 114878

Figure 49-3

CHAPTER 50

BRAKE SYSTEM CHECKOUT PROCEDURES

50-1. GENERAL. This chapter gives procedures for checking out the system after troubleshooting and repair have been done. Procedures are set up in flow chart form showing the checkout steps in order and referring to the fault symptom index when the system does not check out.

BRAKE SYSTEM CHECKOUT

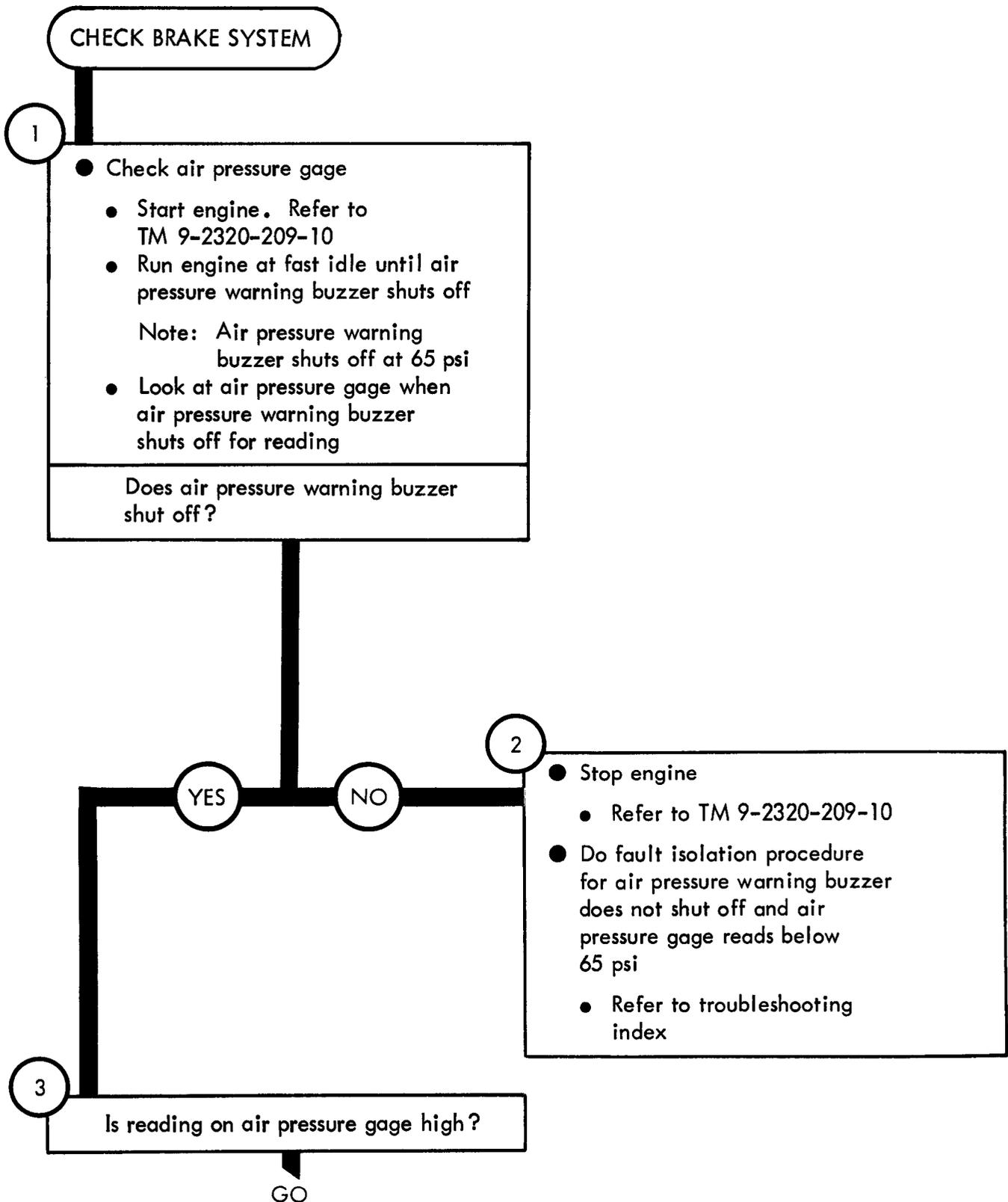

Figure 50-1 (Sheet 1 of 7)

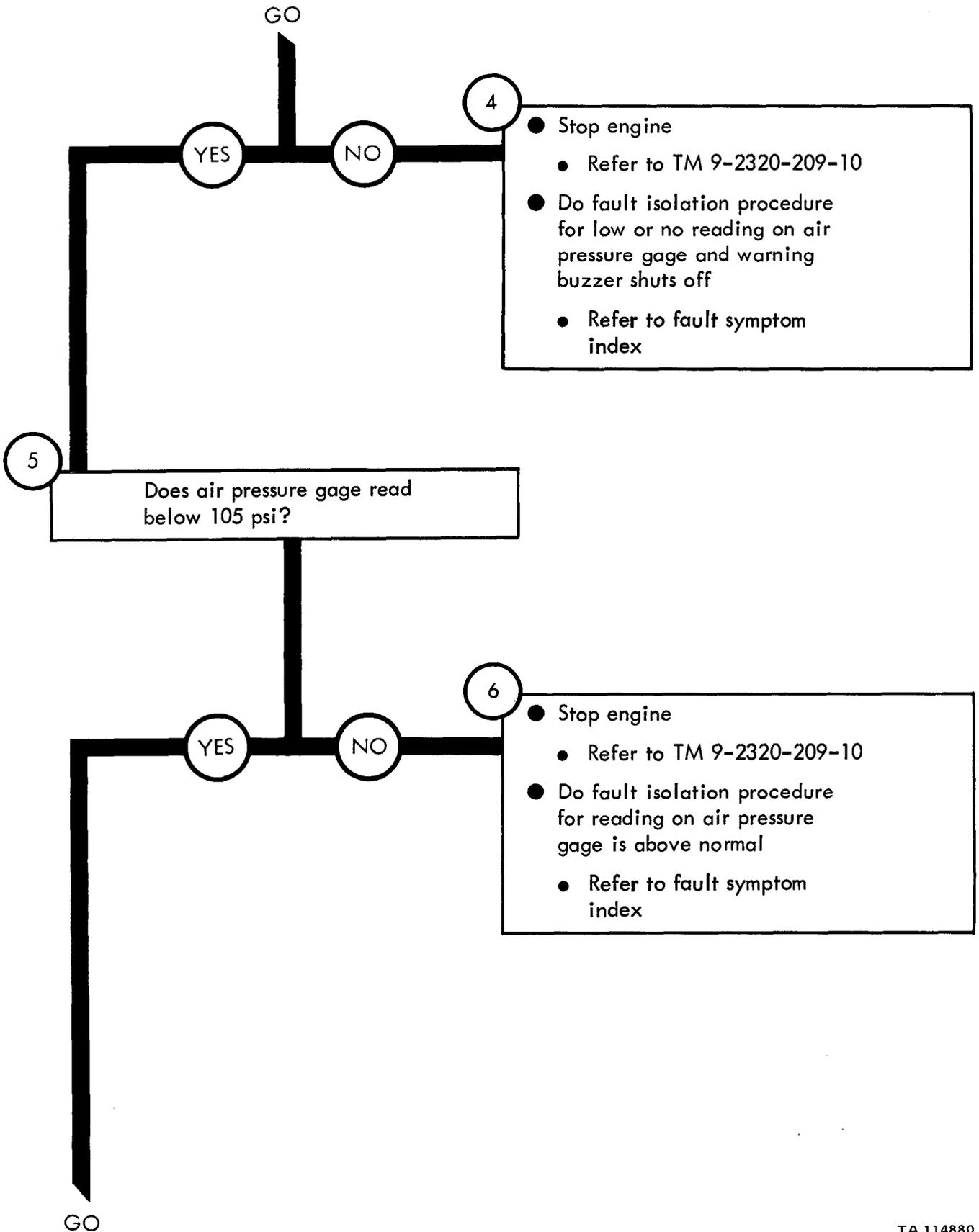

Figure 50-1 (Sheet 2 of 7)

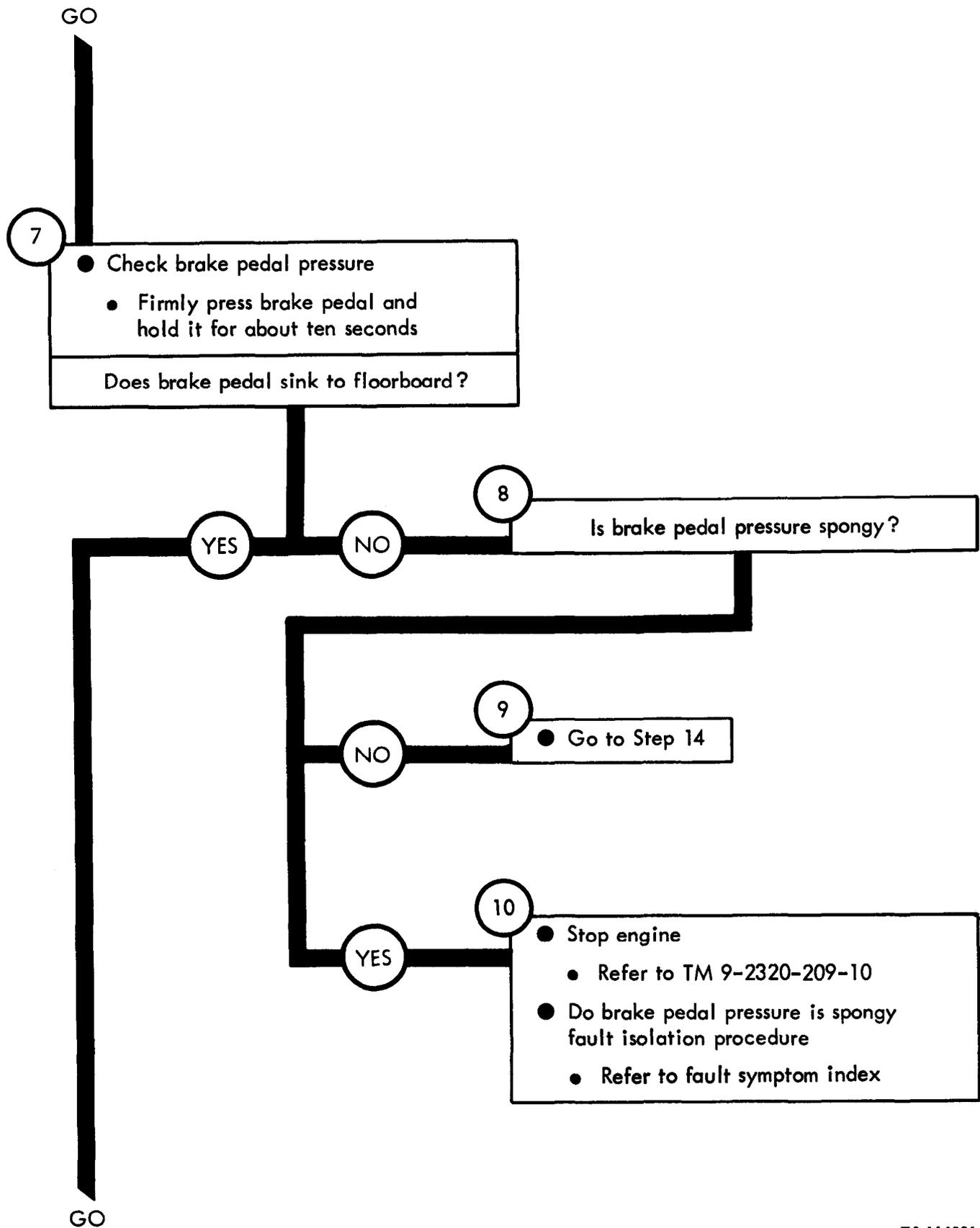
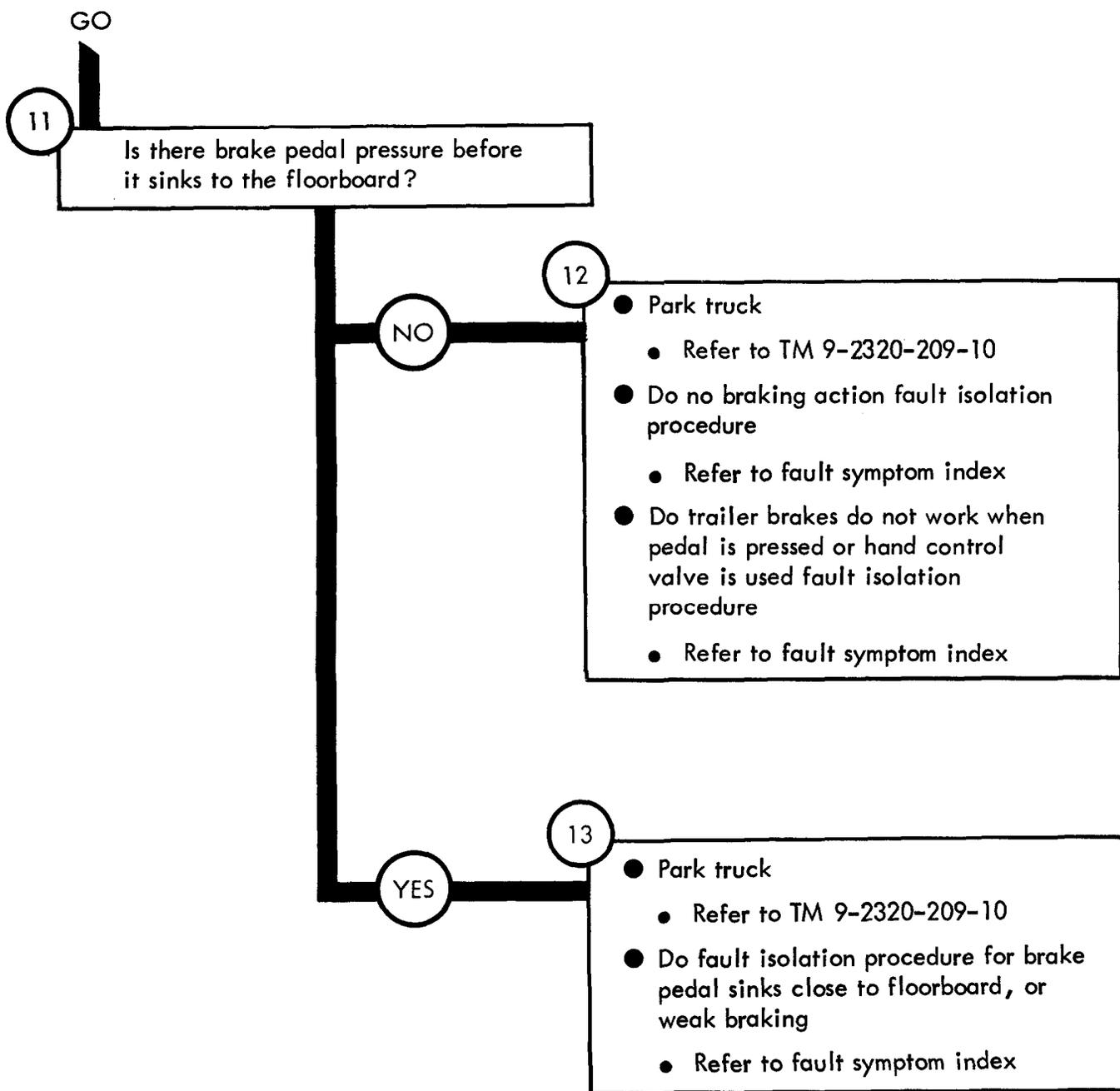
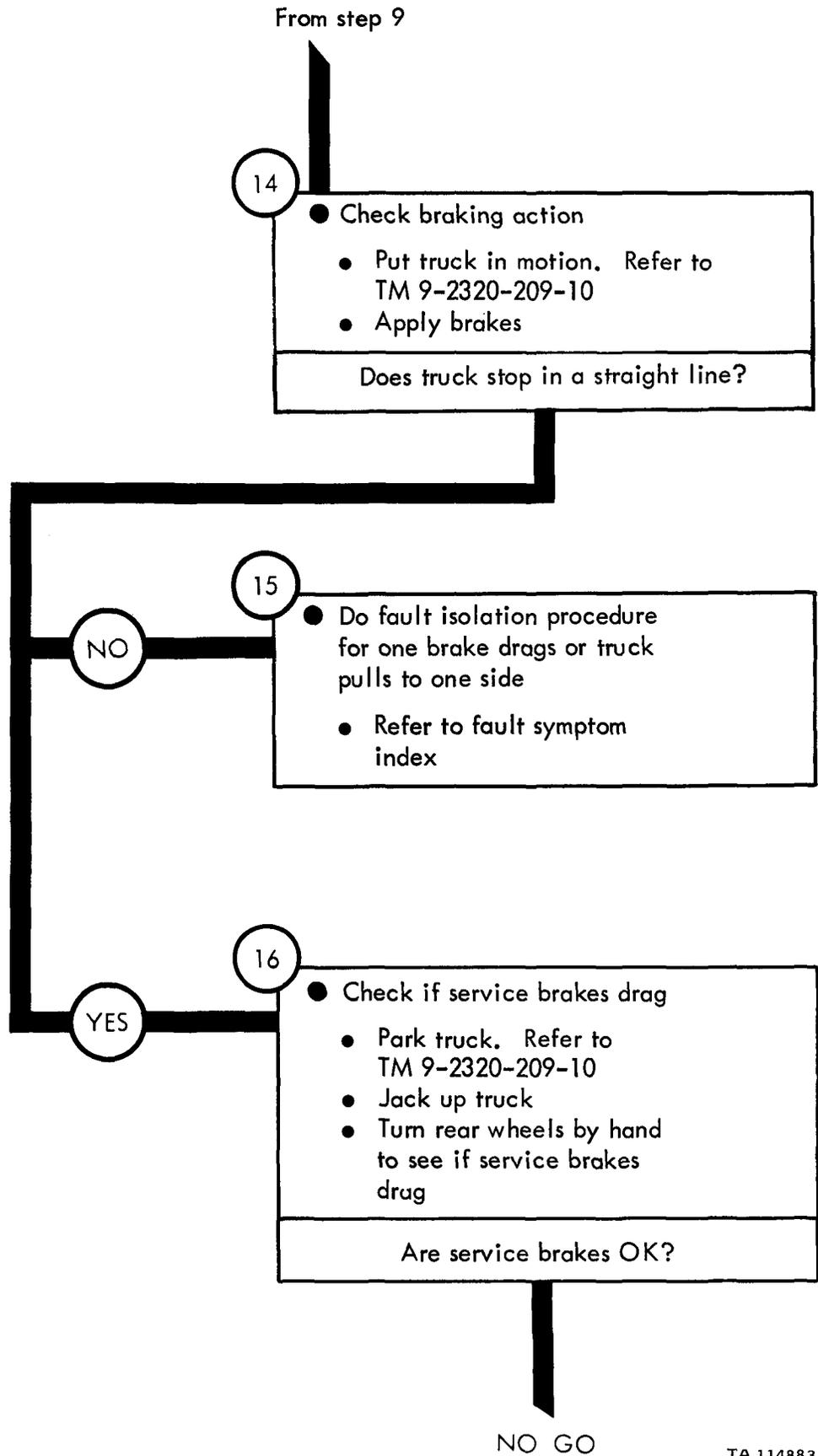

Figure 50-1 (Sheet 3 of 7)

TA 114881





NO GO

TA 114883

Figure 50-1 (Sheet 5 of 7)

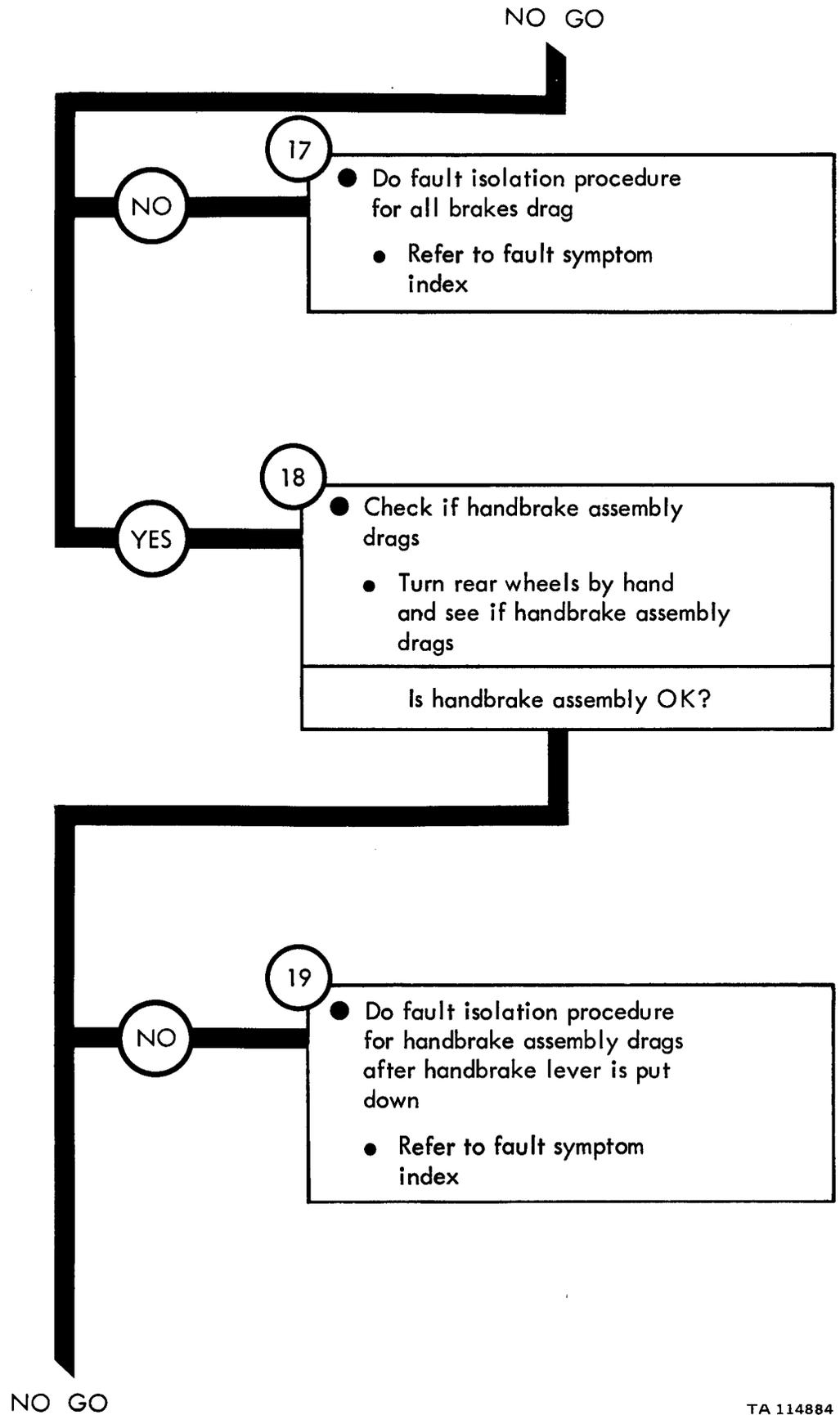
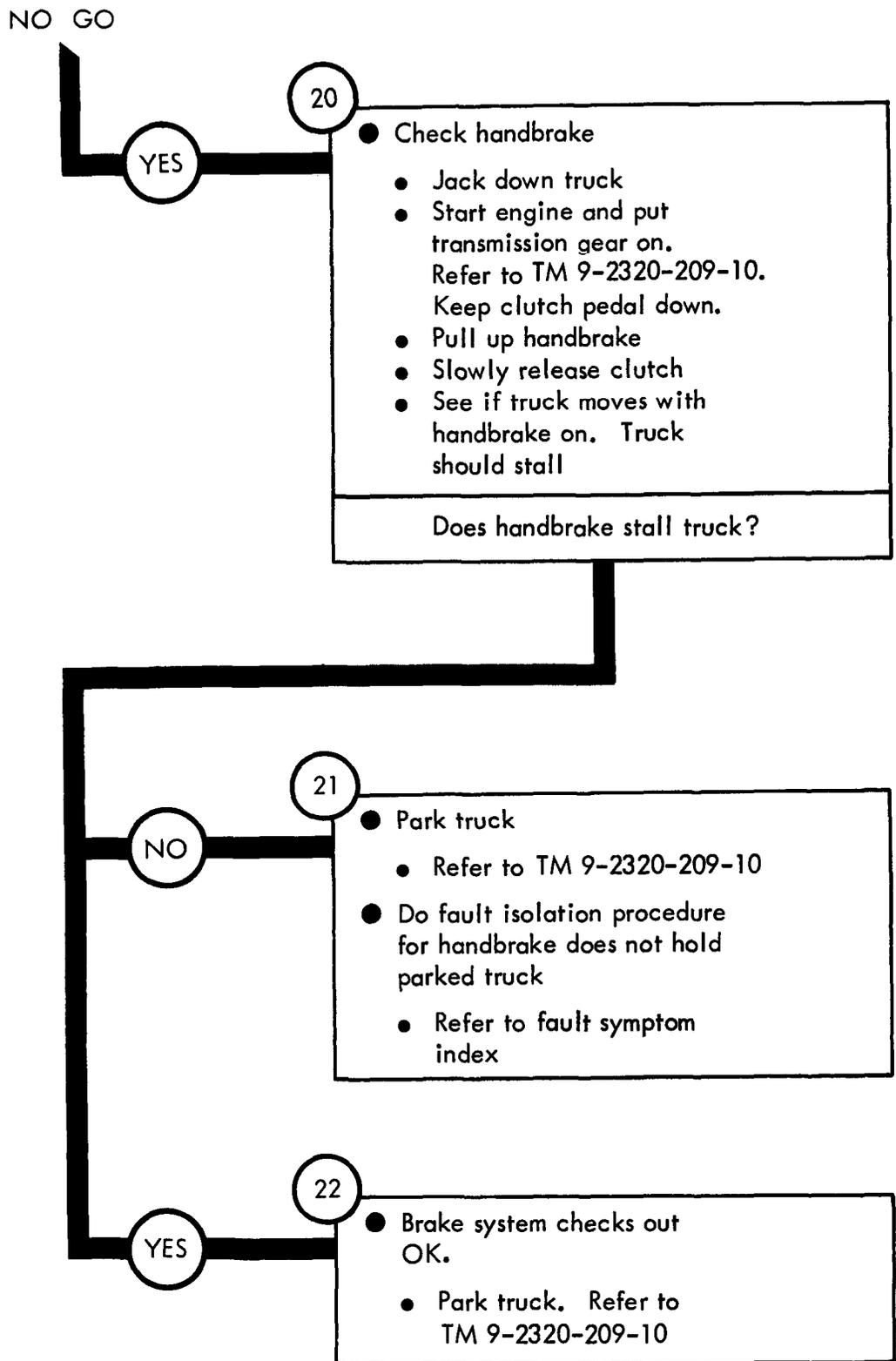

Figure 50-1 (Sheet 6 of 7)



TA 114885

Figure 50-1 (Sheet 7 of 7)

CHAPTER 51

WHEEL SYSTEM TROUBLESHOOTING

51-1. EQUIPMENT ITEMS COVERED. This chapter gives equipment troubleshooting procedures for the wheel system, for which there are authorized corrective maintenance tasks at the organizational maintenance level.

51-2. EQUIPMENT ITEMS NOT COVERED. All equipment items for which corrective maintenance is authorized at the organizational maintenance level are covered in this chapter.

WHEEL SYSTEM TROUBLESHOOTING

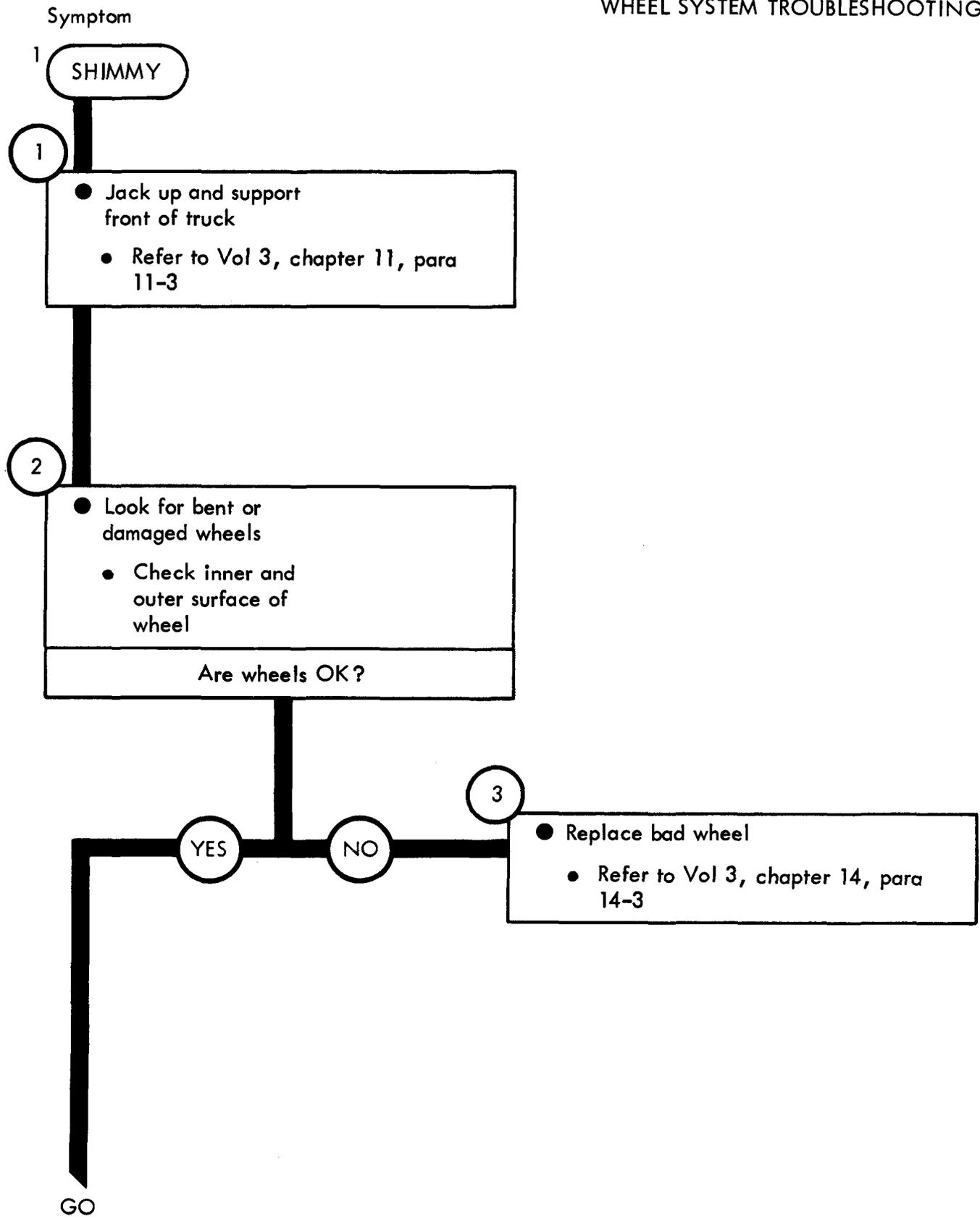

TA 114886

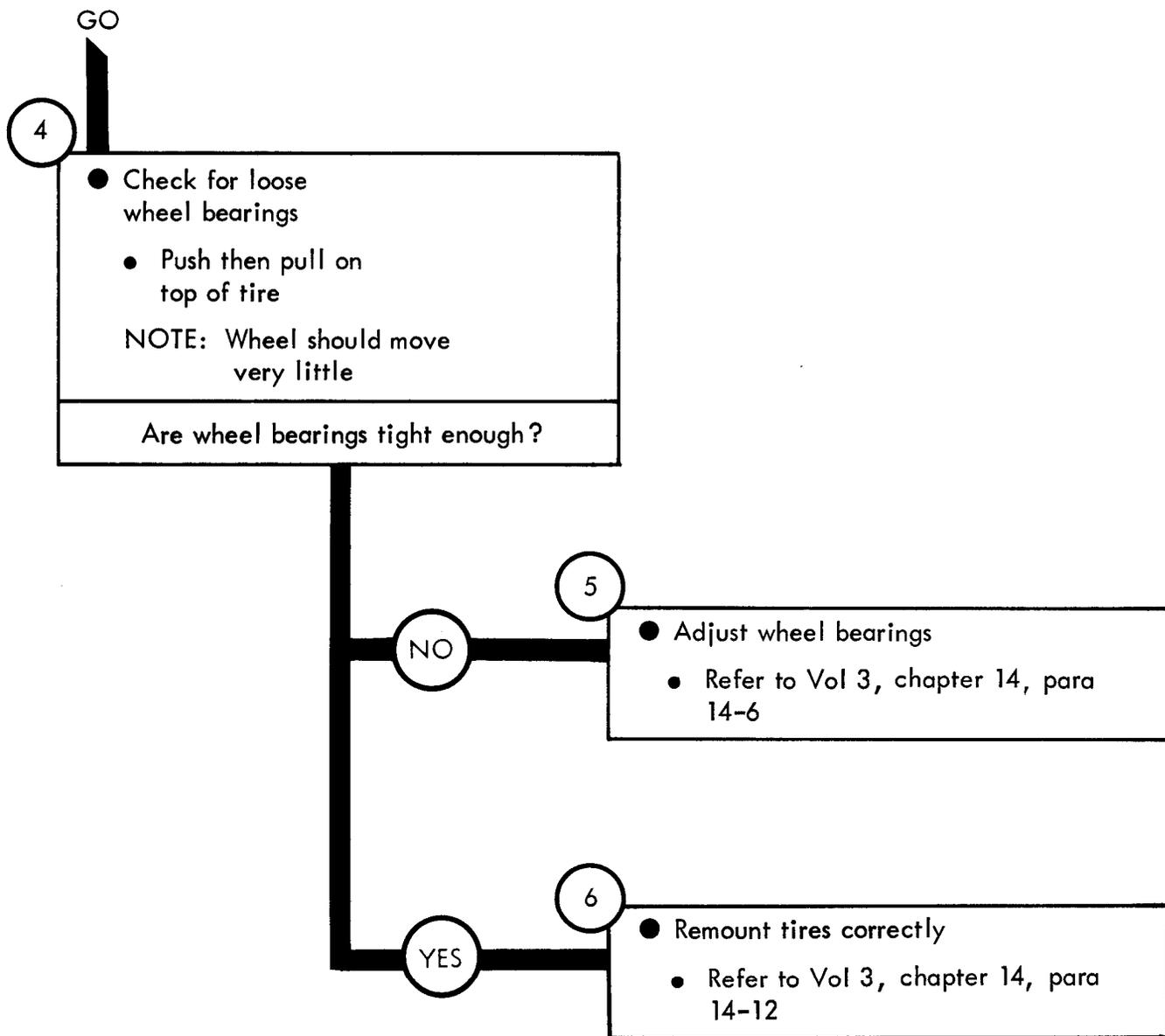

Figure 51-1 (Sheet 2 of 2)

Symptom

2 FRONT TIRES DO NOT WEAR EVENLY

1

- Jack up and support front of truck
- Refer to Vol 3, chapter 11, para 11-3

2

- Check for bent or damaged wheels
- Look at inner and outer surface of wheels

Are wheels ok?

YES

NO

3

- Replace bad wheel
- Refer to Vol 3, chapter 14, para 14-3

GO

TA 114888

Figure 51-2 (Sheet 1 of 2)

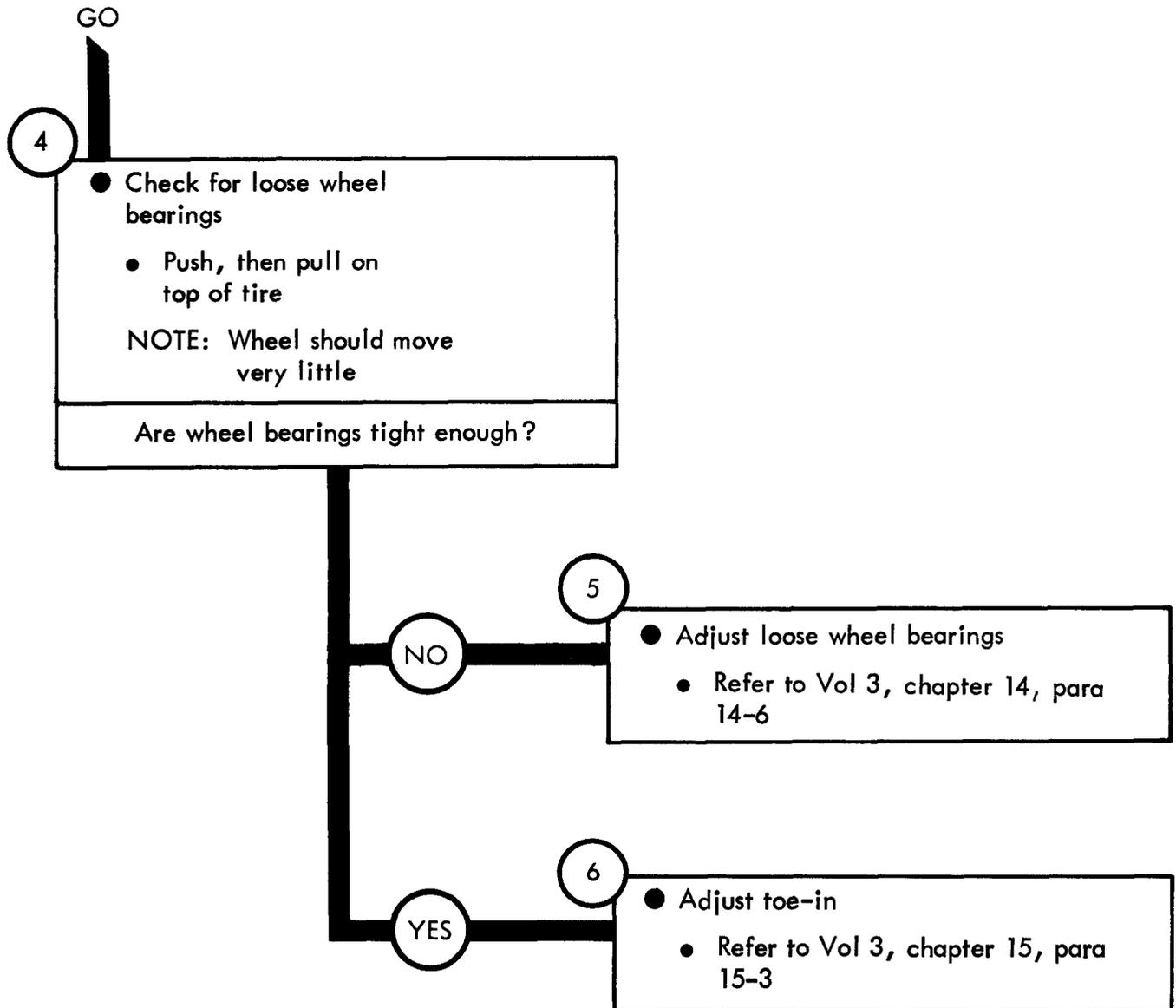

CHAPTER 52

STEERING SYSTEM TROUBLESHOOTING

52-1. EQUIPMENT ITEMS COVERED. This chapter gives equipment troubleshooting procedures for the steering system, for which there are authorized corrective maintenance tasks at the organizational maintenance level.

52-2. EQUIPMENT ITEMS NOT COVERED. All equipment items for which corrective maintenance is authorized at the organizational maintenance level are covered in this chapter.

STEERING SYSTEM TROUBLESHOOTING

Symptom

1 HARD STEERING

1

- Make truck ready for work on steering system
 - Park truck. Refer to TM 9-2320-209-10

2

- Check steering column
 - Using 9/16-inch wrench turn column bracket clamp bolt two turns to the left
 - See if steering column changes its position from side to side

Does steering column stay in position?

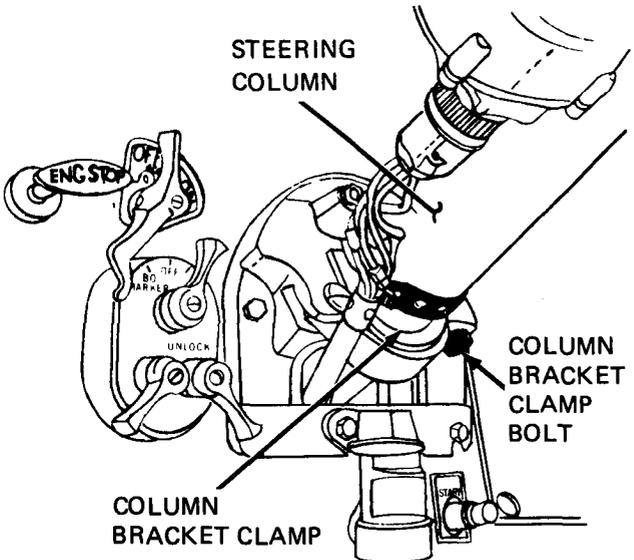

NO

3

- Adjust steering column
 - Using 9/16-inch wrench turn column bracket clamp bolt—two more turns to the left
 - Hold column in position and tighten column bracket clamp bolt using 9/16-inch wrench

GO

Figure 52-1 (Sheet 1 of 2)

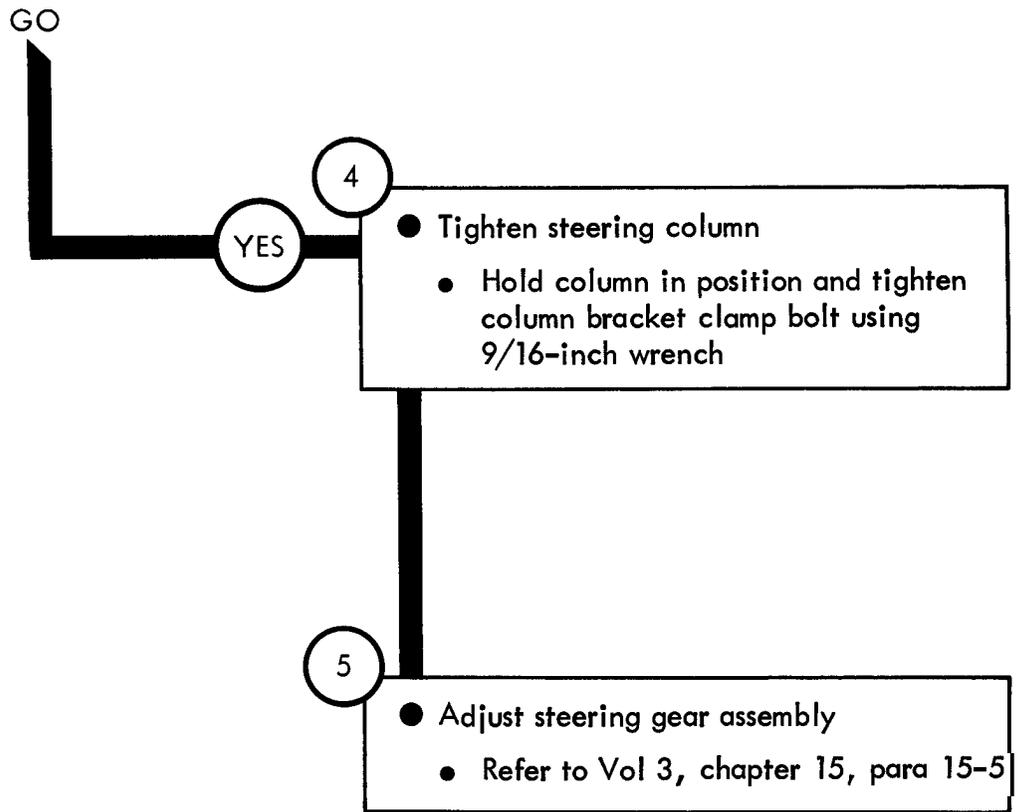

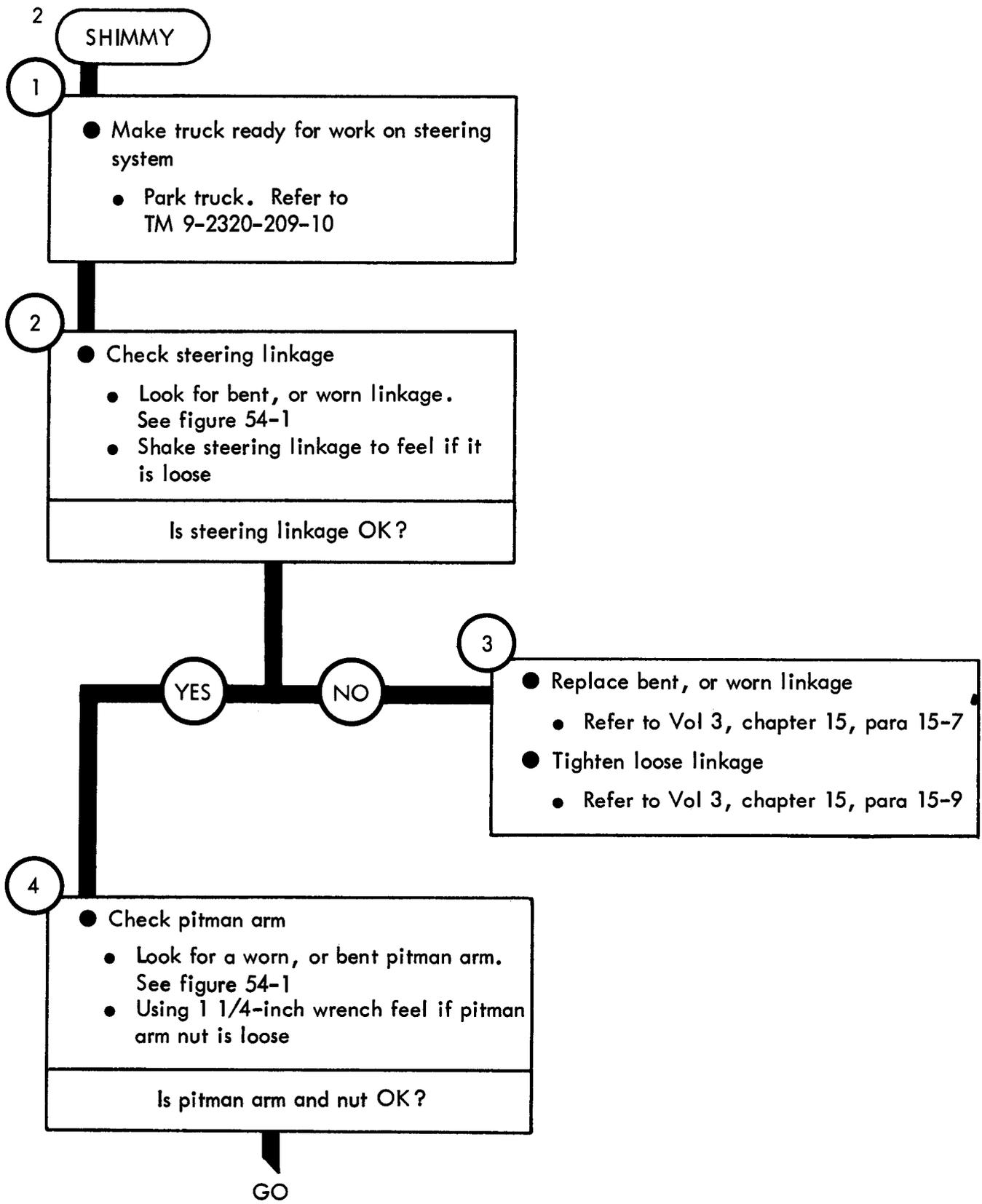

Figure 52-2 (Sheet 1 of 4)

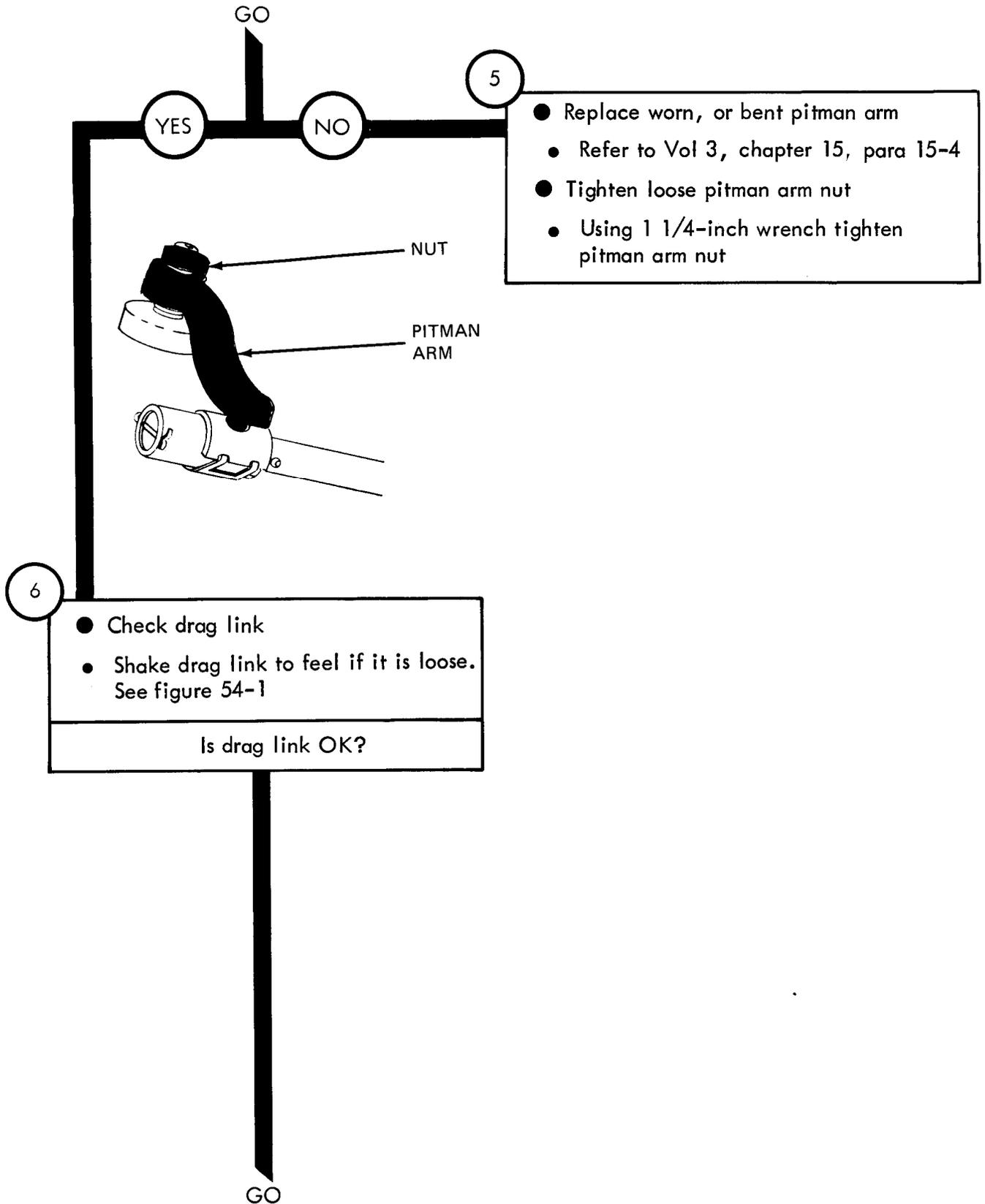
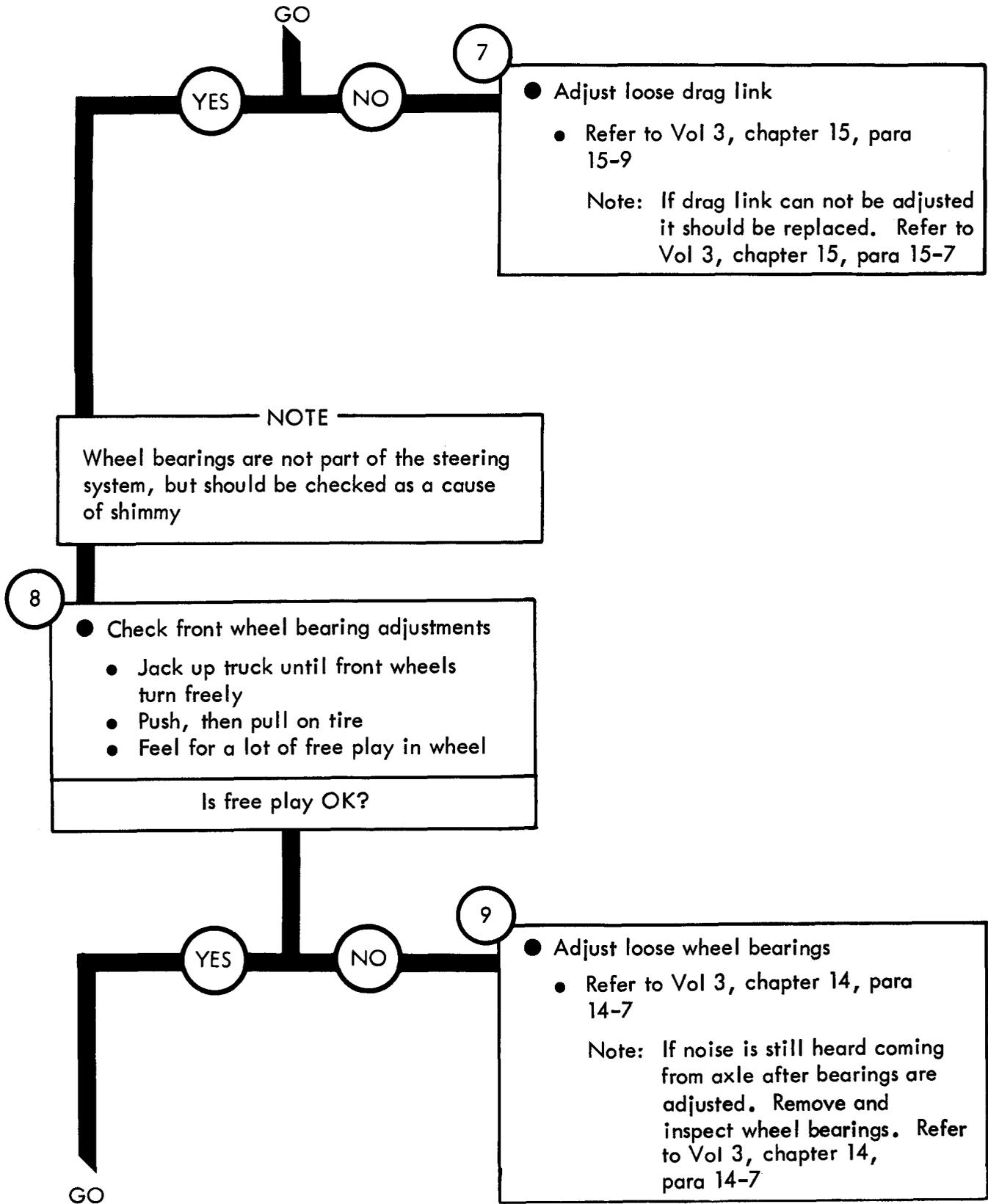
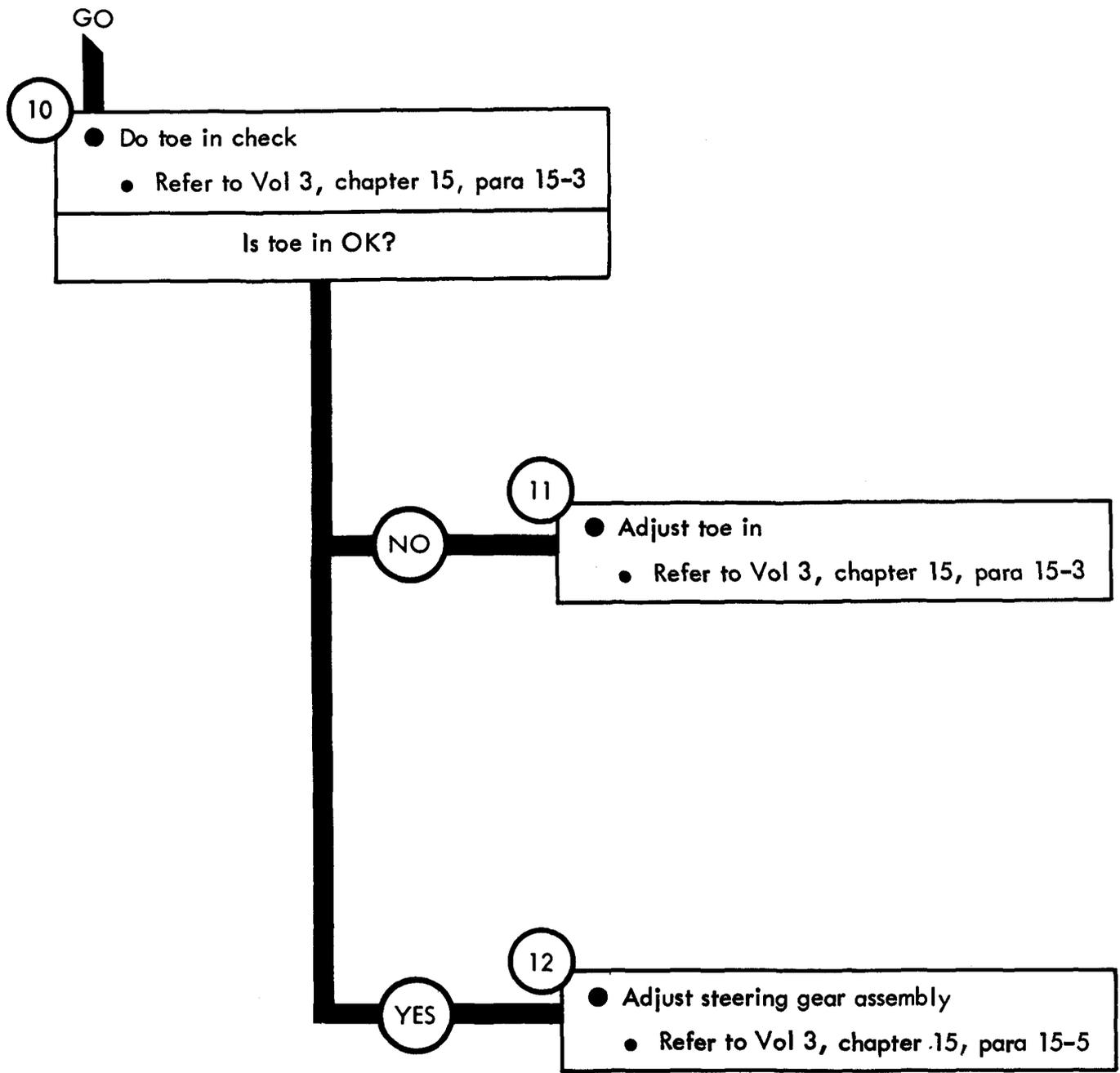

Figure 52-2 (Sheet 2 of 4)



TA 114894

Figure 52-2 (Sheet 3 of 4)



TA 114895

Figure 52-2 (Sheet 4 of 4)

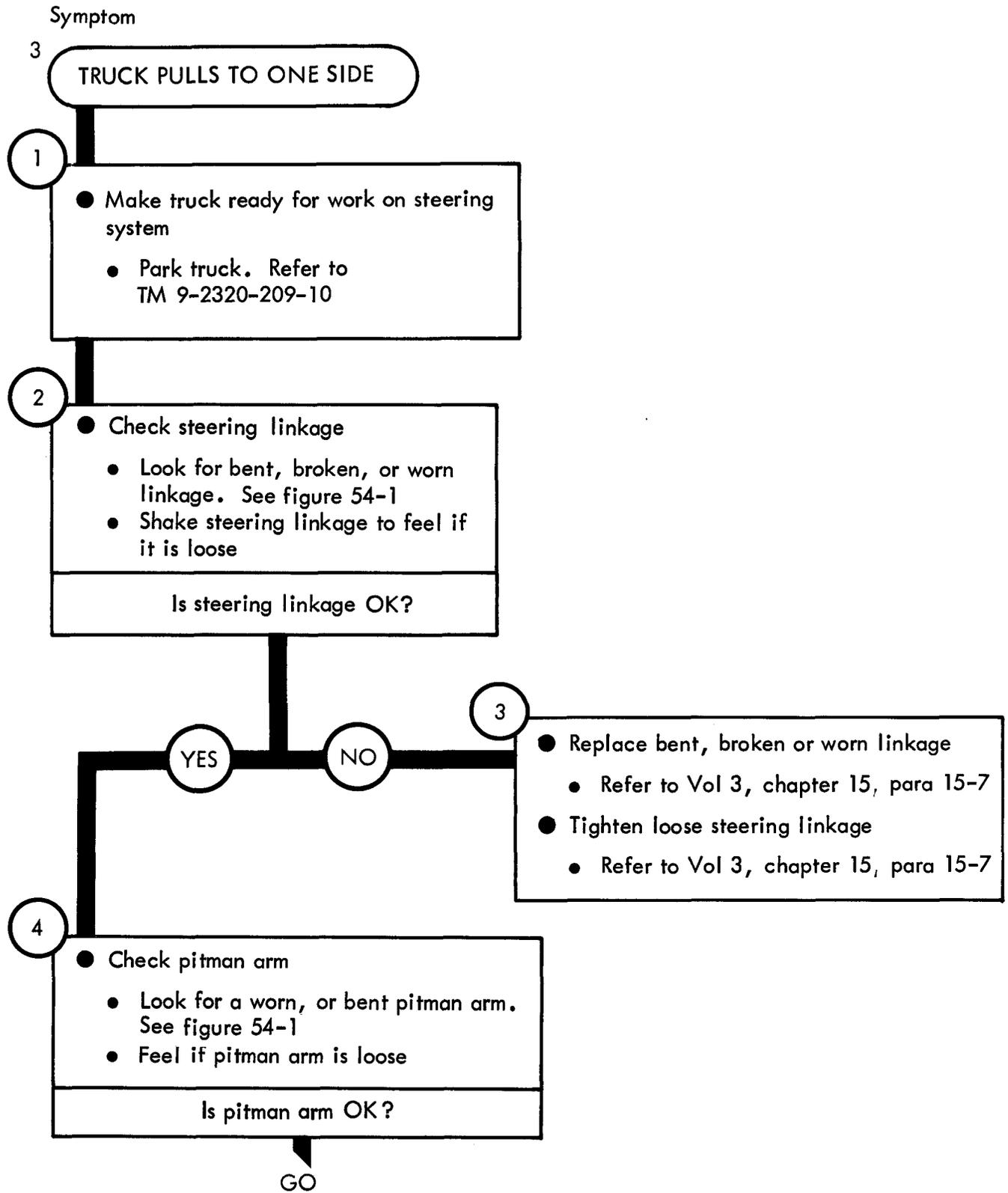

TA 114896

Figure 52-3 (Sheet 1 of 3)

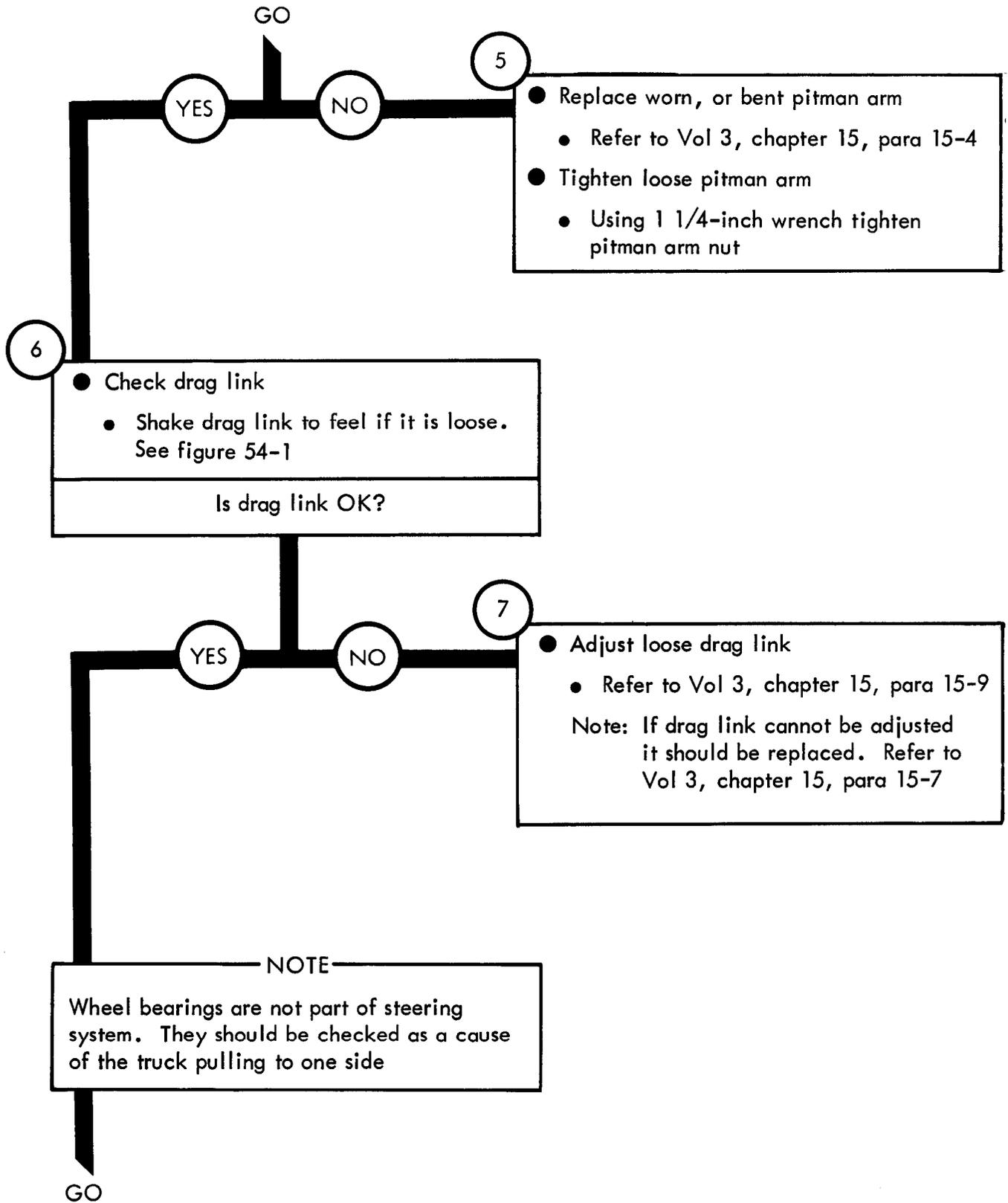

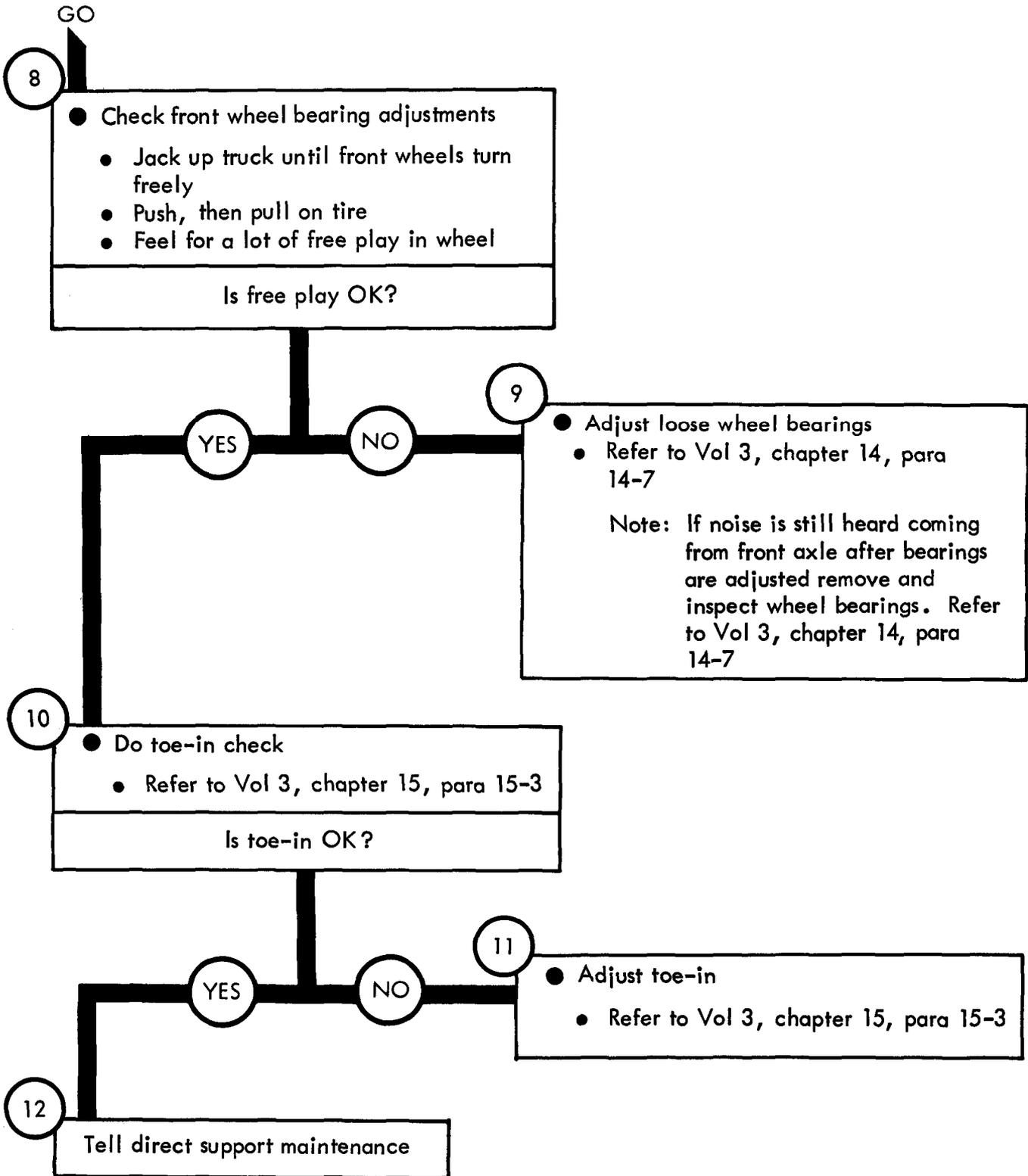

TA 114898

Figure 52-3 (Sheet 3 of 3)

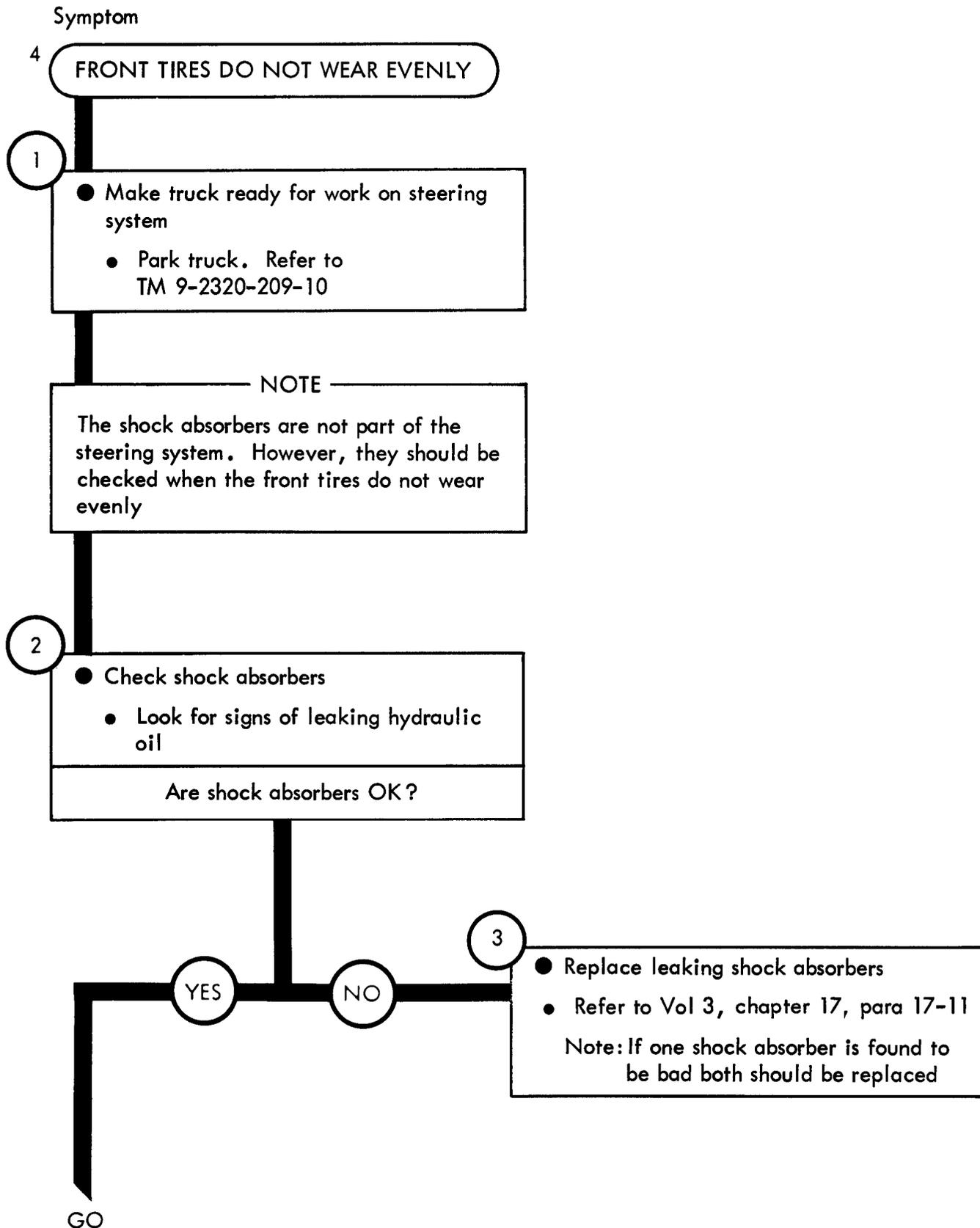
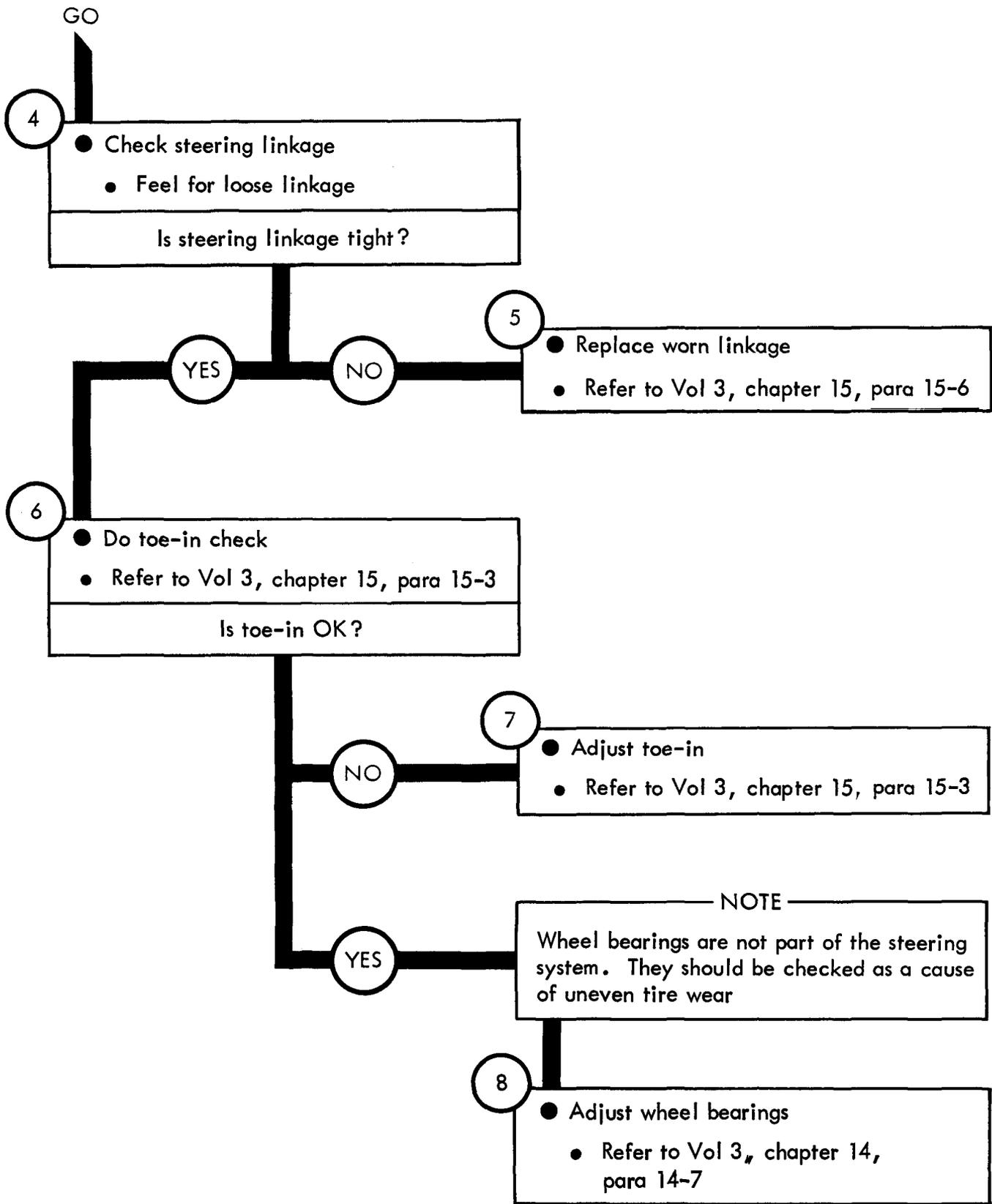

Figure 52-4 (Sheet 1 of 2)



TA 114900

Figure 52-4 (Sheet 2 of 2)

CHAPTER 53

STEERING SYSTEM TROUBLESHOOTING SUMMARY

53-1. GENERAL. This chapter gives a summary of troubleshooting procedures given in chapter 52 for the steering system.

53-2. PROCEDURES. The summary in this chapter covers all fault symptoms found in the detailed troubleshooting procedures. Chapter 7 outlines a sample troubleshooting procedure. The summary procedures are based on the "what-to-do" portions of the detailed procedures and do not include the "how-to-do-it" instructions. Warnings, cautions, and notes are given where needed.

STEERING SYSTEM TROUBLESHOOTING SUMMARY

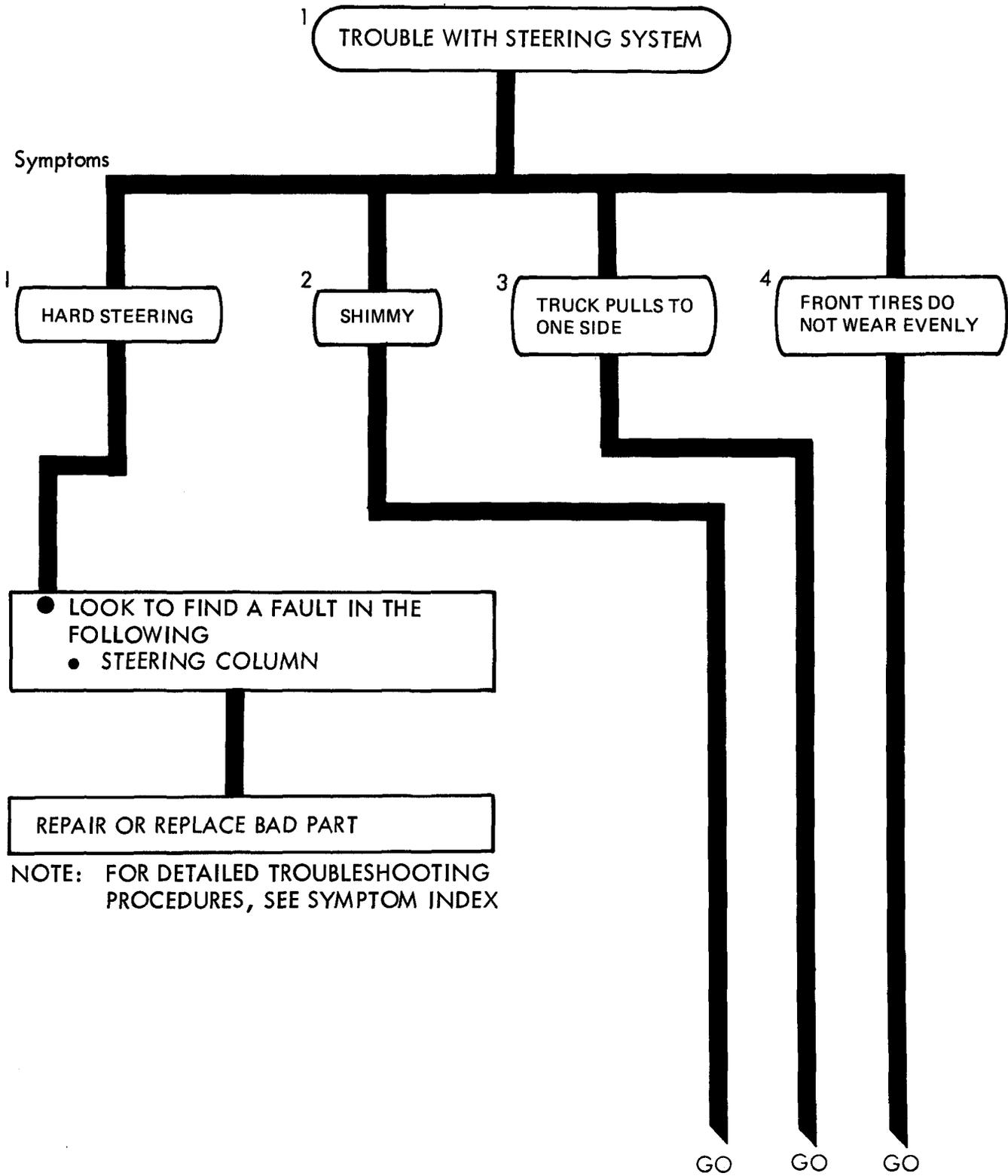

TA 114901

Figure 53-1 (Sheet 1 of 3)

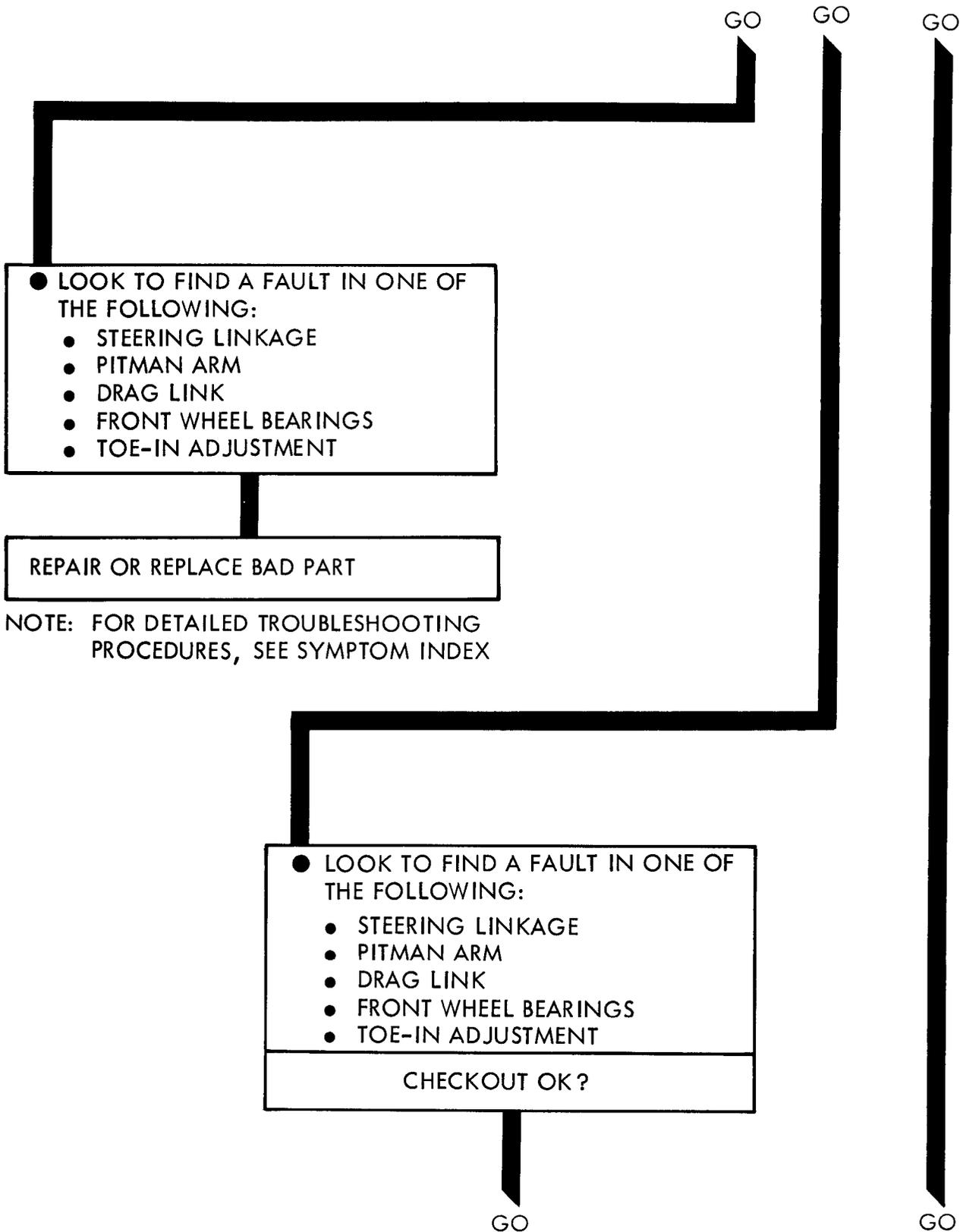
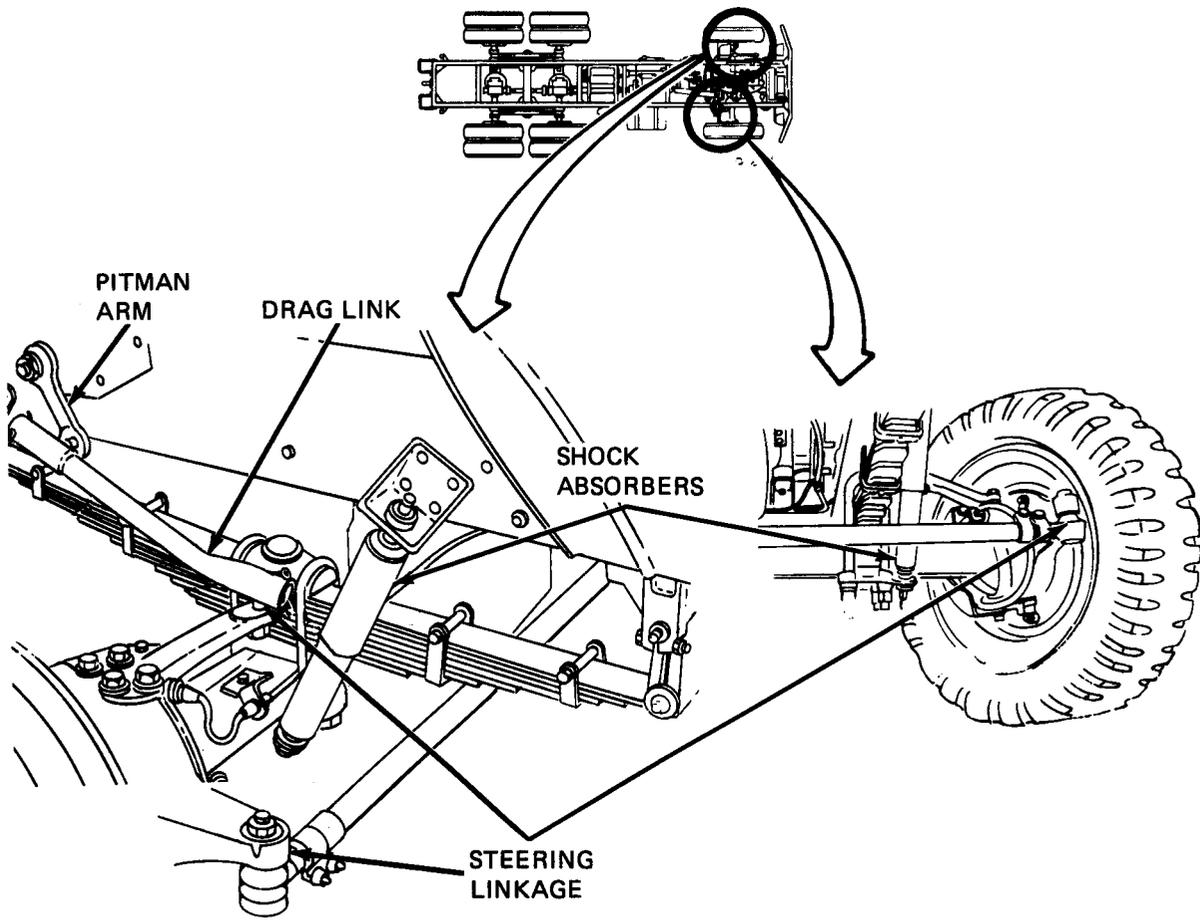

Figure 53-1 (Sheet 2 of 3)

CHAPTER 54

STEERING SYSTEM SUPPORT DIAGRAMS

54-1. GENERAL. This chapter gives the diagrams you need when doing troubleshooting procedures in chapter 52. Table 3-1 is a complete listing of all support diagrams used in this manual.



TA 114904

Figure 54-1. Steering System Support Diagram

CHAPTER 55

SPRING AND SHOCK ABSORBERS SYSTEM TROUBLESHOOTING

55-1. EQUIPMENT ITEMS COVERED. This chapter gives equipment troubleshooting procedures for the springs and shock absorbers system, for which there are authorized corrective maintenance tasks at the organizational maintenance level.

55-2. EQUIPMENT ITEMS NOT COVERED. All equipment items for which corrective maintenance is authorized at the organizational maintenance level are covered in this chapter.

SPRINGS AND SHOCK ABSORBERS TROUBLESHOOTING

Symptom

TRUCK LEANS TO ONE SIDE

1

- Make truck ready for work on springs
 - Park truck. Refer to TM 9-2320-209-10

2

- Check front and rear leaf springs
 - Look for broken springs

Are springs OK?

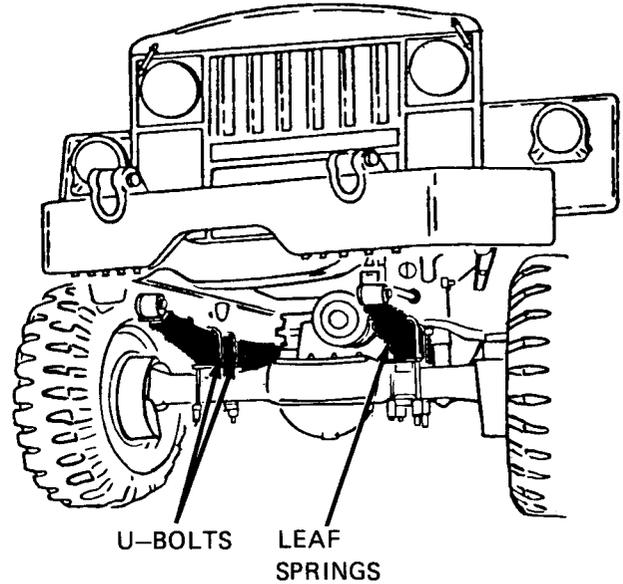

3

- Replace broken leaf springs
 - Refer to Vol 3, chapter 17, para 17-4 and 17-7

YES

NO

4

- Check front and rear U-bolts
 - Look for broken U-bolts

Are U-bolts OK?

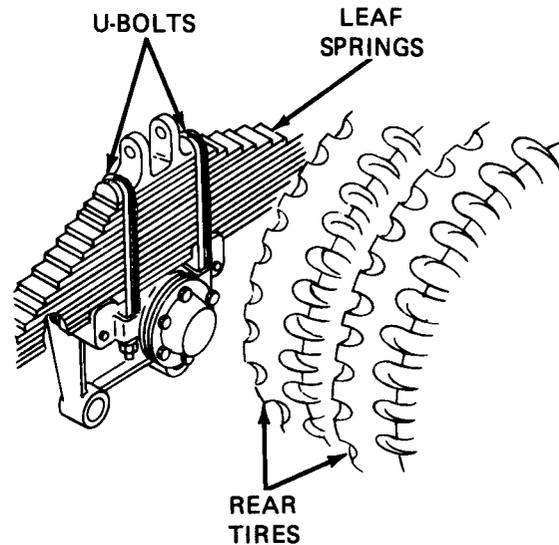

GO

TA 114905

Figure 55-1 (Sheet 1 of 2)

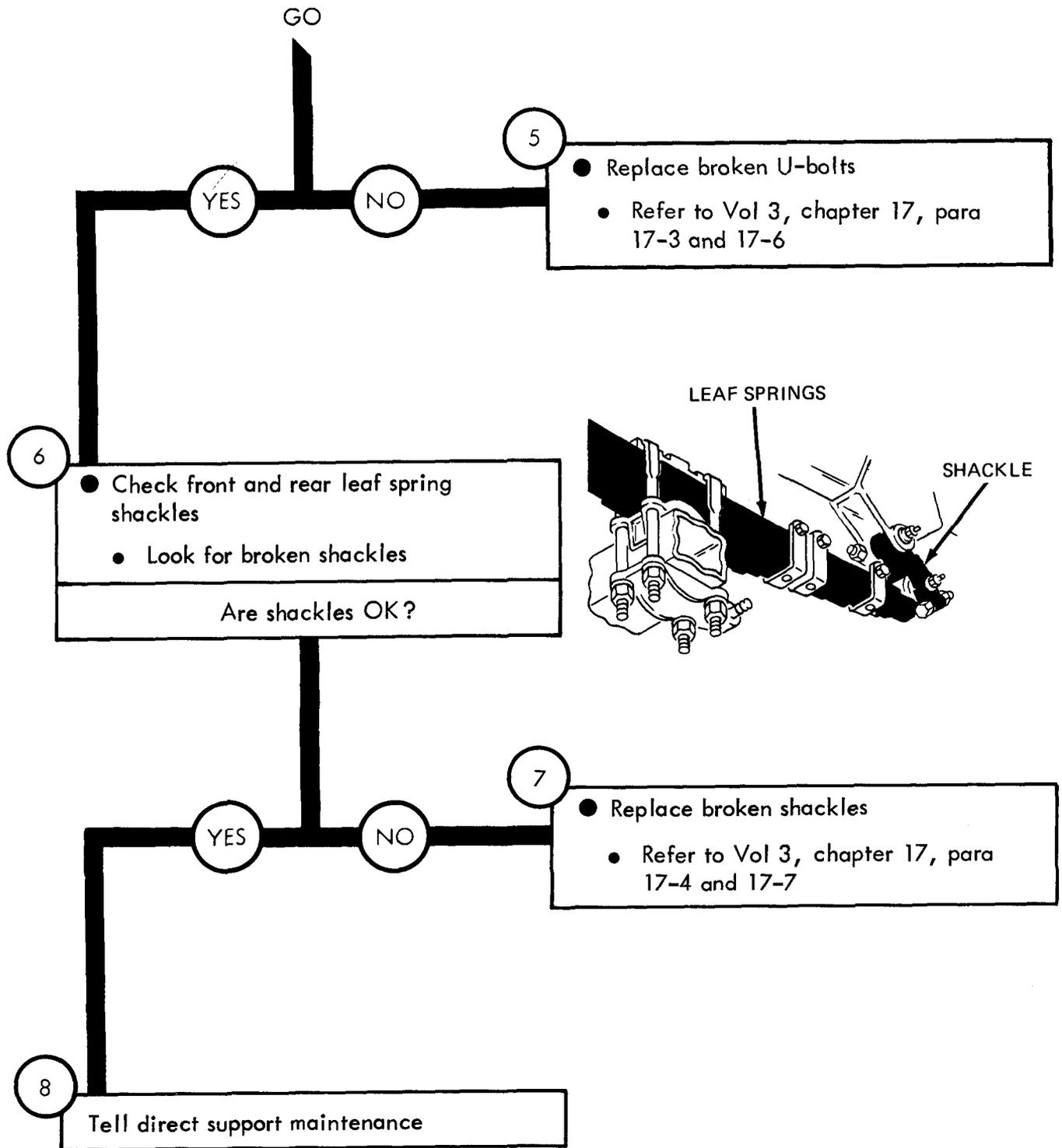

TA 114906

Figure 55-1 (Sheet 2 of 2)

Symptom

2

REAR AXLE MAKES NOISE

1

- Park truck
- Refer to TM 9-2320-209-10

2

- Check torque rods
 - Shake torque rods
 - Look for free play at torque rod ends

Are torque rods OK?

GO

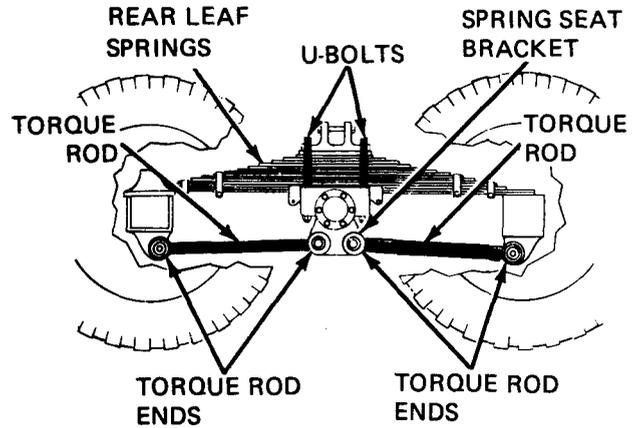

TA 114907

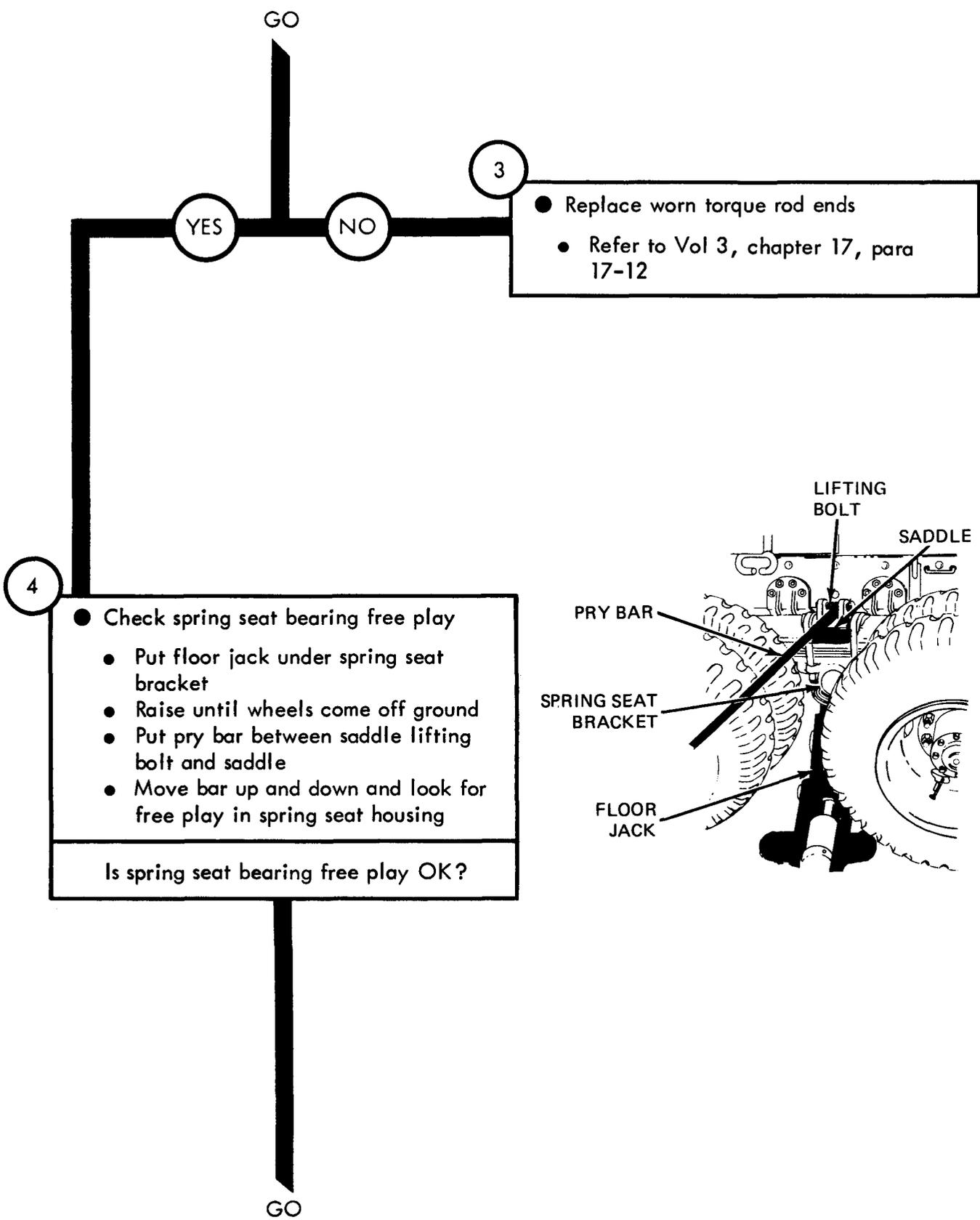

TA 114908

Figure 55-2 (Sheet 2 of 5)

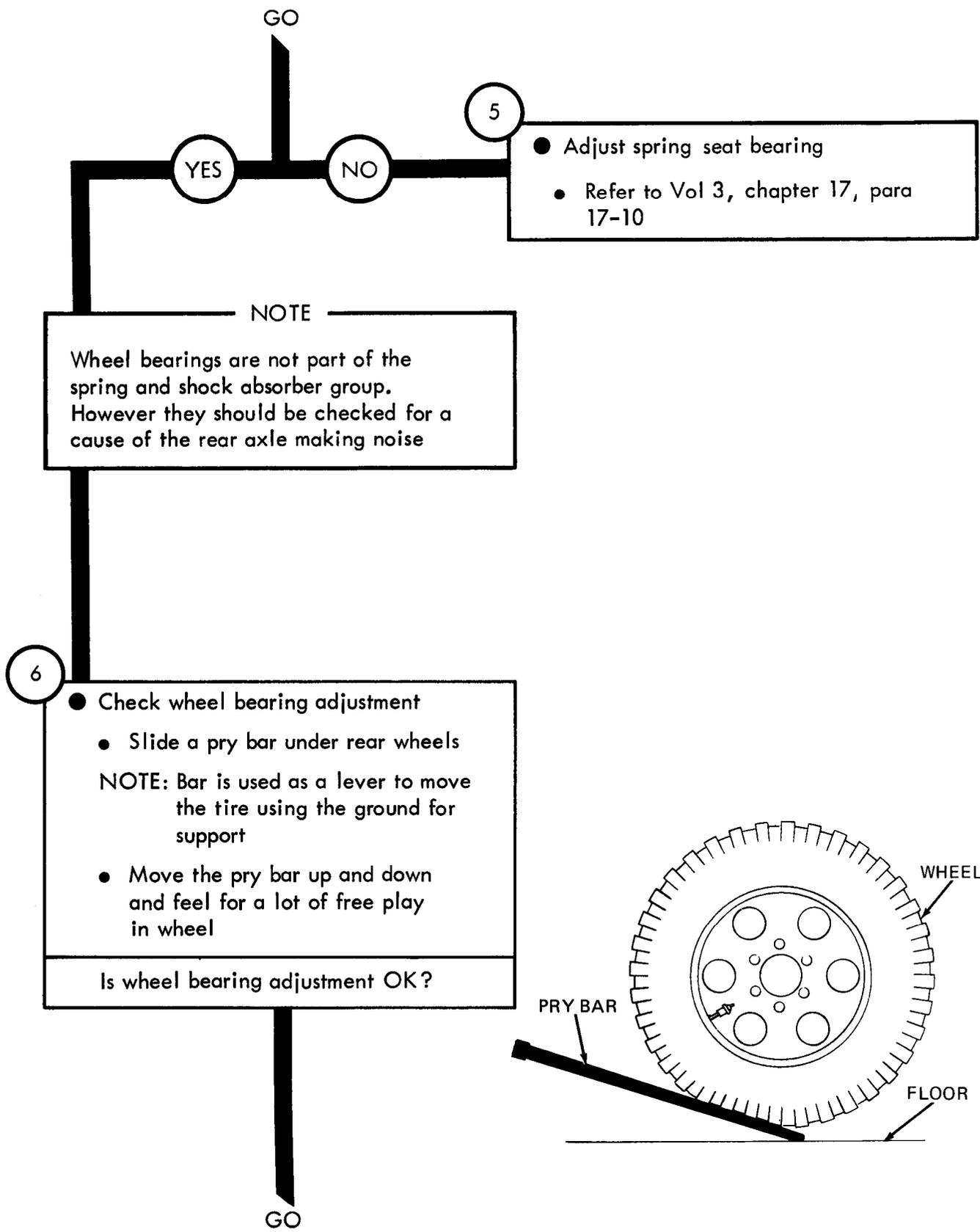

TA 114909

Figure 55-2 (Sheet 3 of 5)

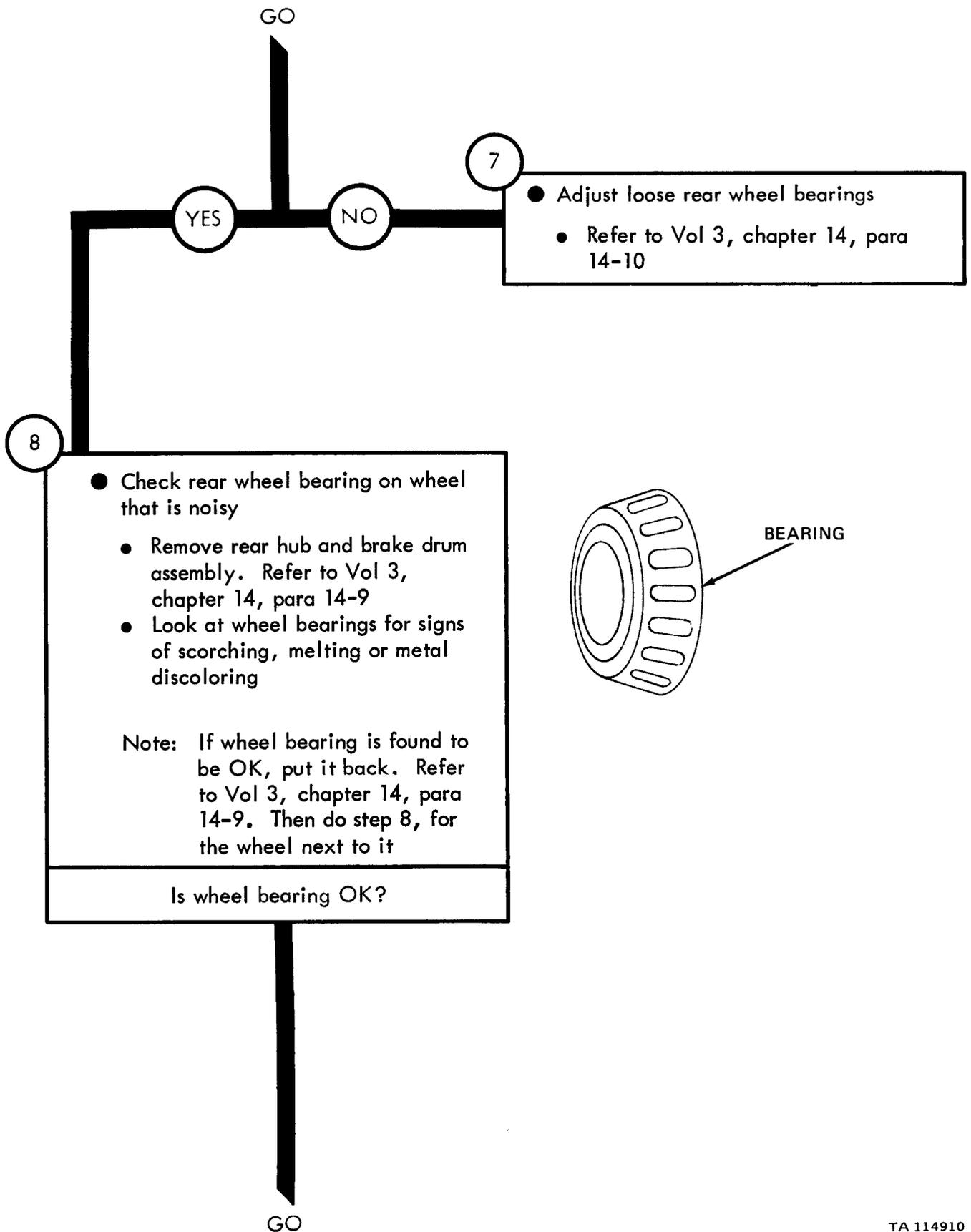

Figure 55-2 (Sheet 4 of 5)

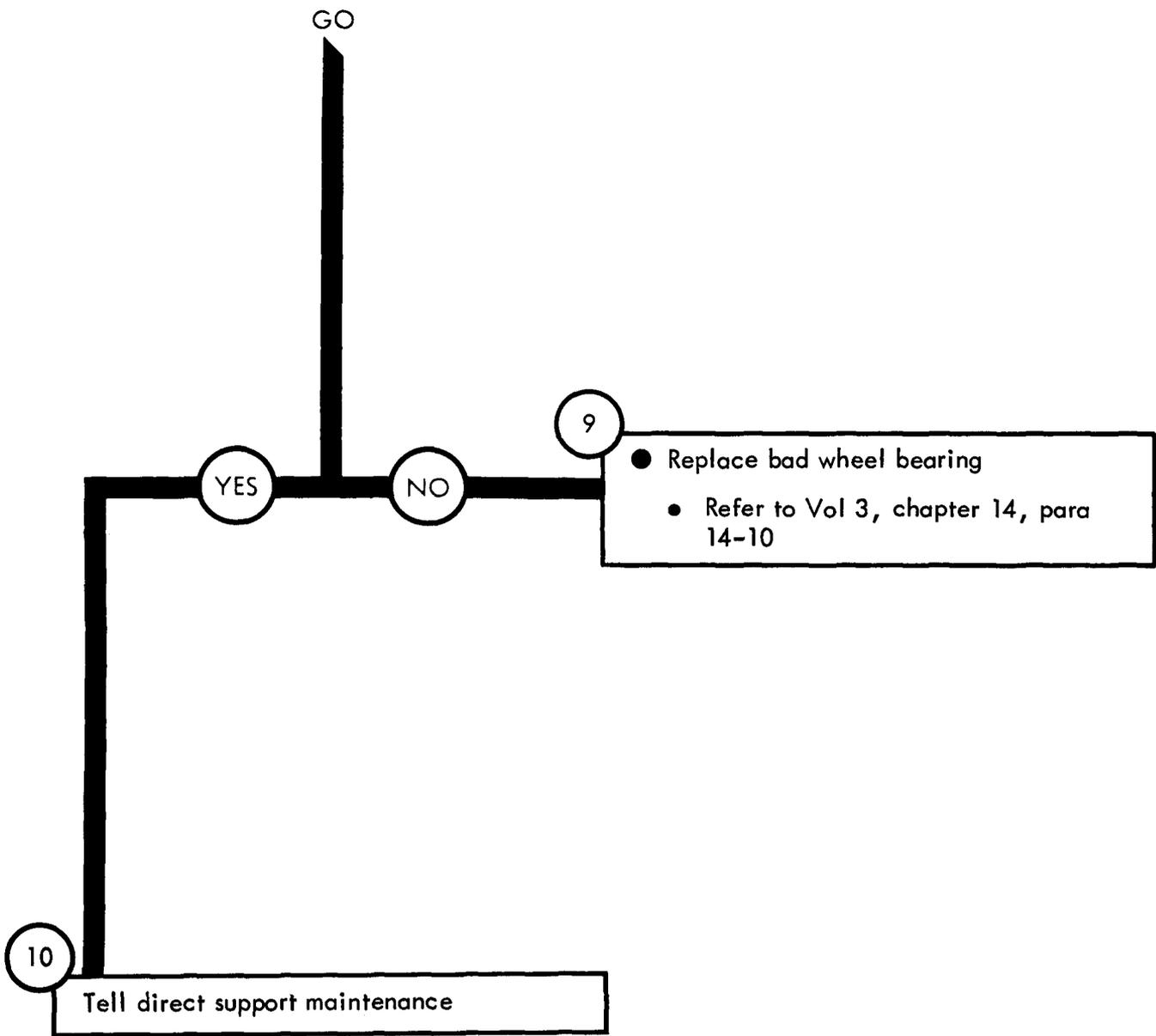

Figure 55-2 (Sheet 5 of 5)

CHAPTER 56

SPRING AND SHOCK ABSORBERS SYSTEM TROUBLESHOOTING SUMMARY

56-1. GENERAL. This chapter gives a summary of troubleshooting procedures given in chapter 55 for the springs and shock absorbers system.

56-2. PROCEDURES. The summary in this chapter covers all fault symptoms found in the detailed troubleshooting procedures. Chapter 7 outlines a sample troubleshooting procedure. The summary procedures are based on the "what-to-do" portions of the detailed procedures and do not include the "how-to-do-it" instructions. Warnings, cautions, and notes are given where needed.

SPRING AND SHOCK ABSORBERS TROUBLESHOOTING SUMMARY

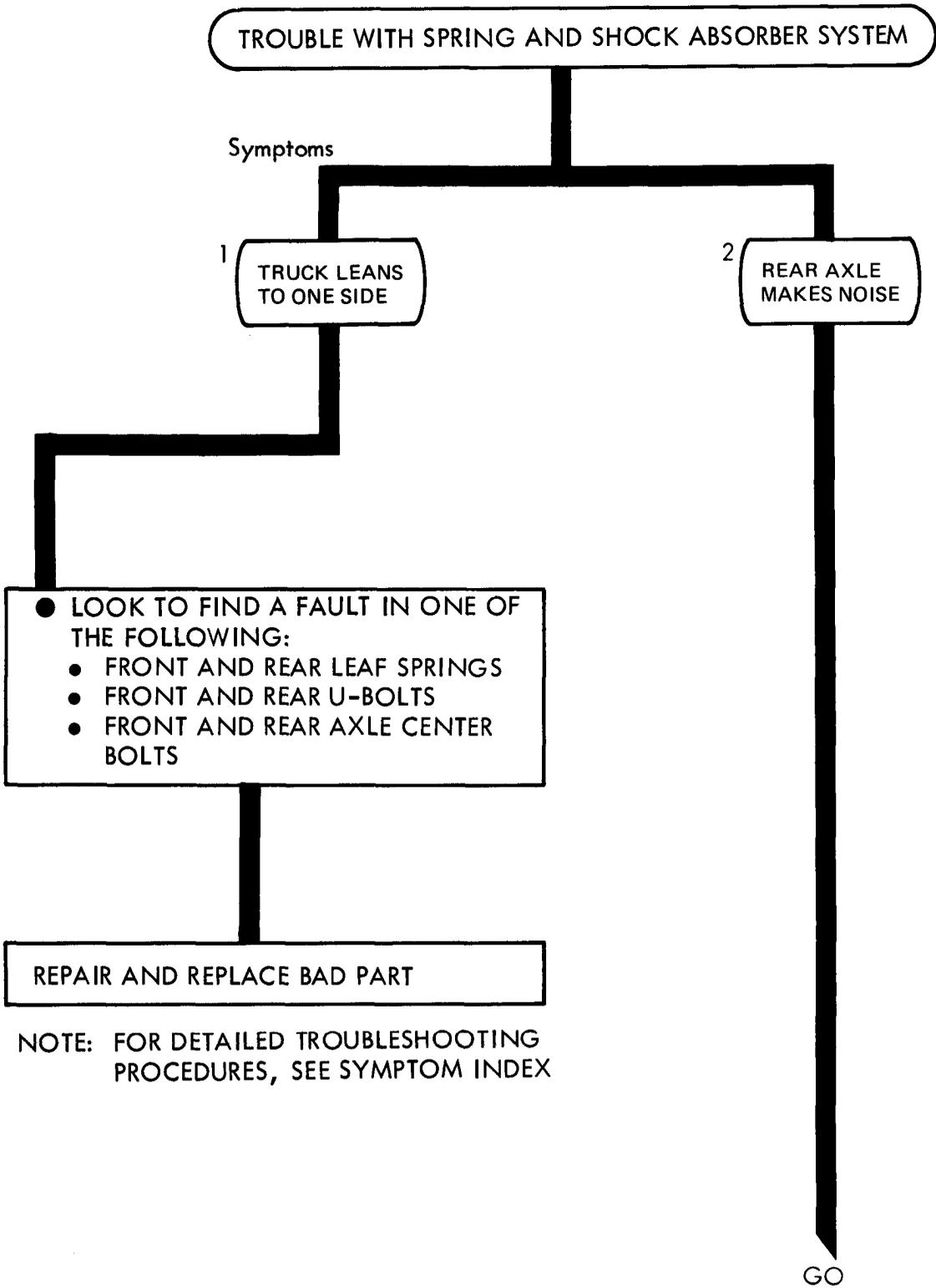

NOTE: FOR DETAILED TROUBLESHOOTING PROCEDURES, SEE SYMPTOM INDEX

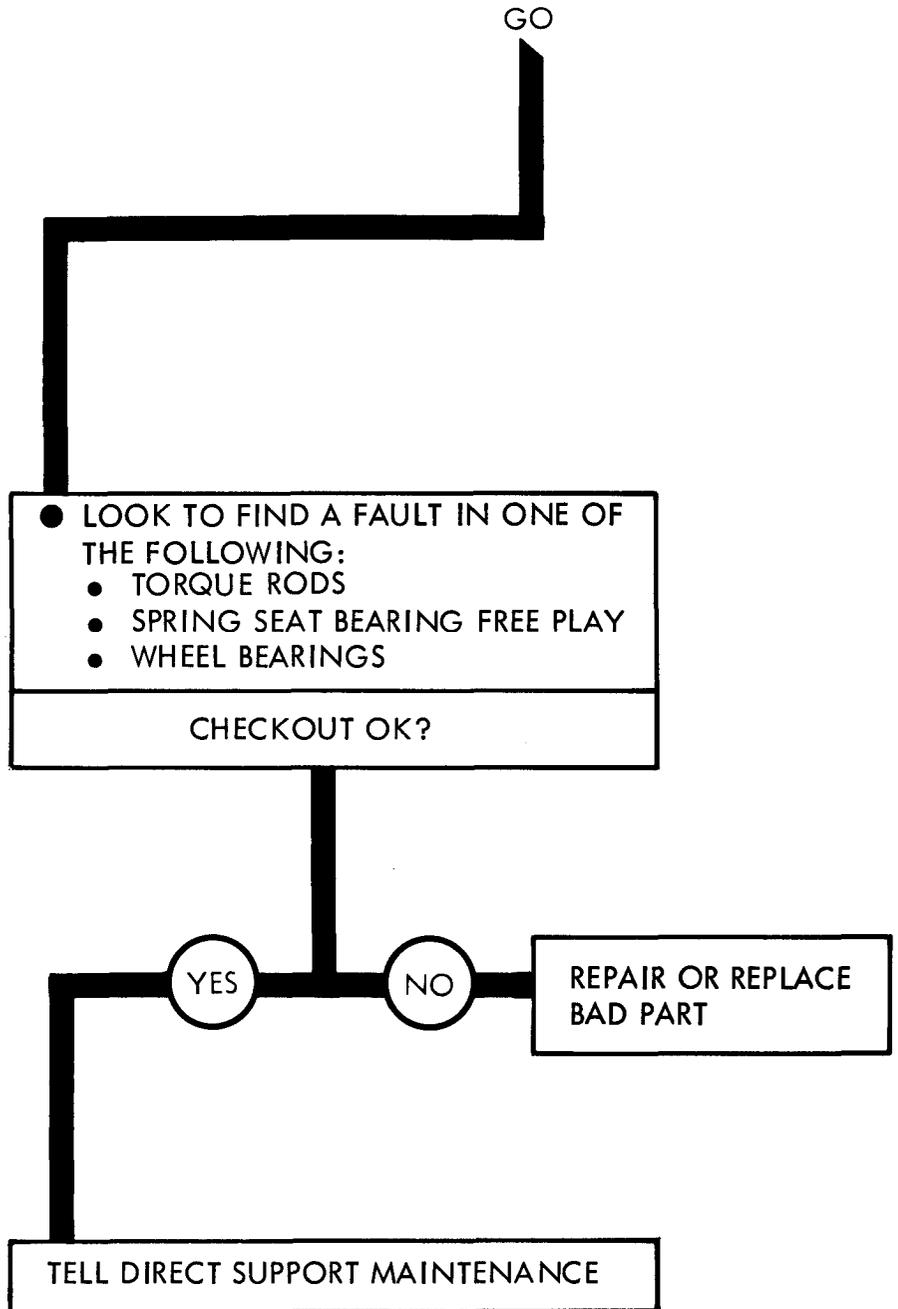

NOTE: FOR DETAILED TROUBLESHOOTING PROCEDURES, SEE SYMPTOM INDEX

CHAPTER 57

DUMP BODY TROUBLESHOOTING

57-1. EQUIPMENT ITEMS COVERED. This chapter gives equipment troubleshooting procedures for the dump body, for which there are authorized corrective maintenance tasks at the organizational maintenance level.

57-2. EQUIPMENT ITEMS NOT COVERED. All equipment items for which corrective maintenance is authorized at the organizational maintenance level are covered in this chapter.

DUMP BODY TROUBLESHOOTING

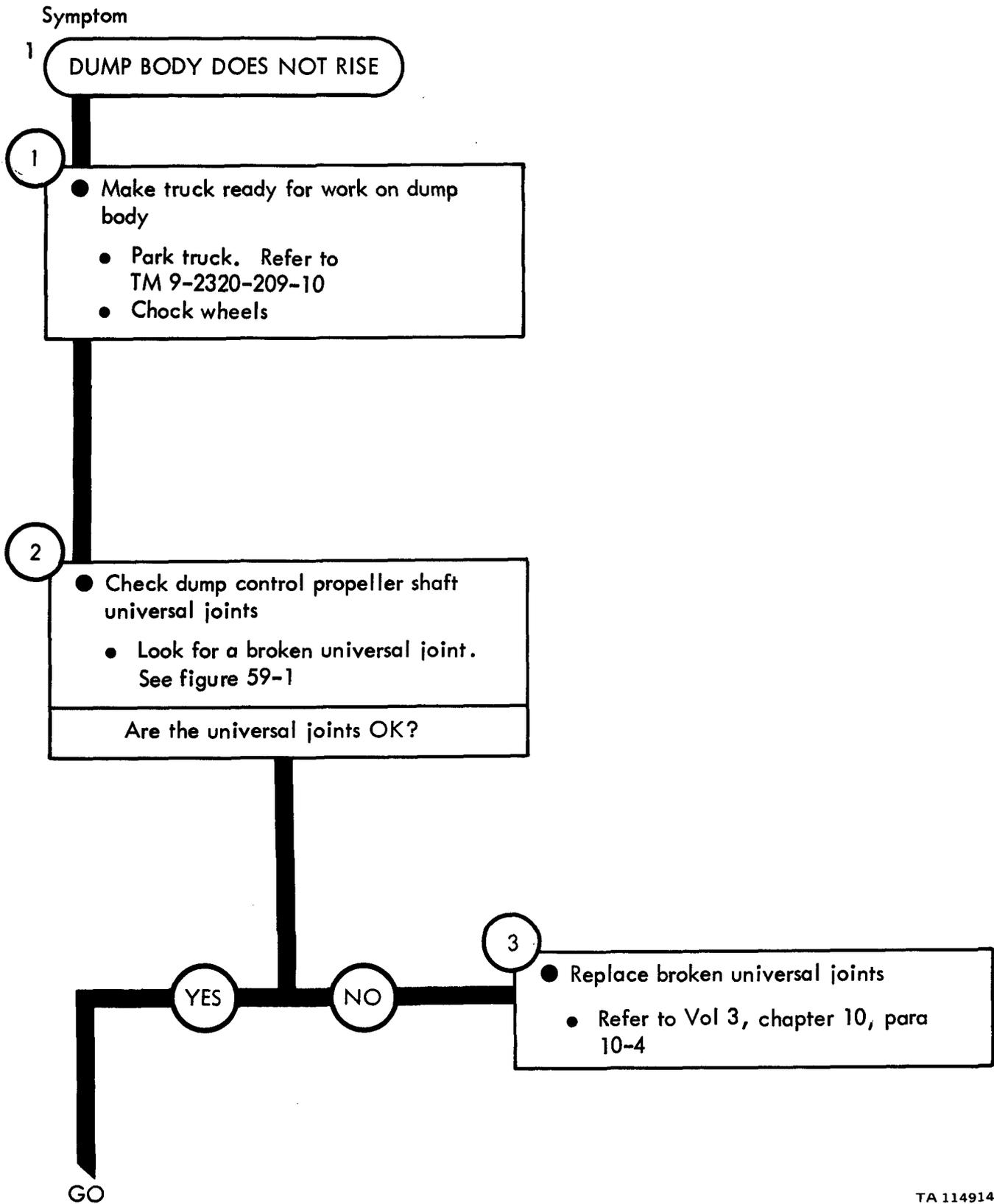

TA 114914

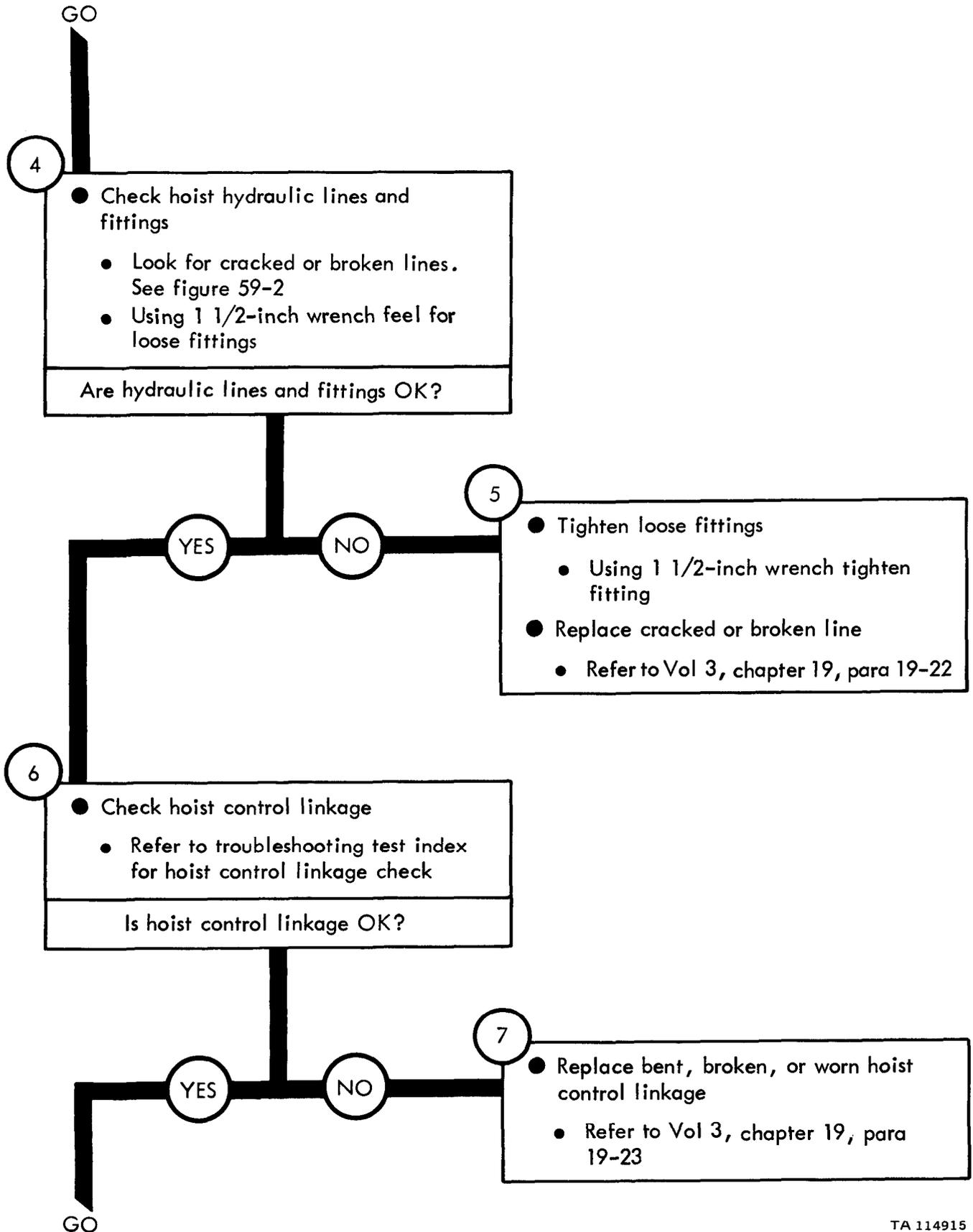

TA 114915

Figure 57-1 (Sheet 2 of 4)

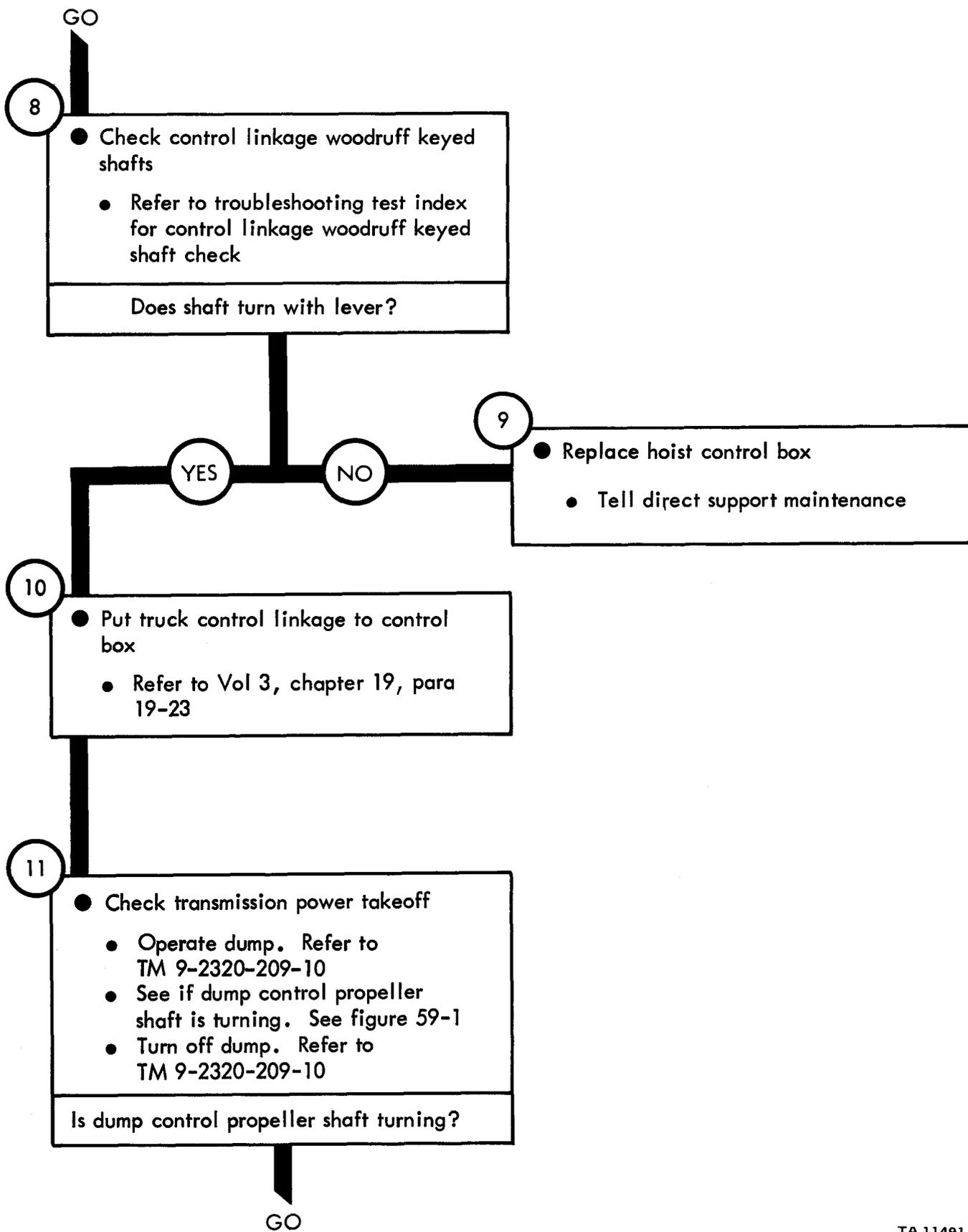

TA 11491

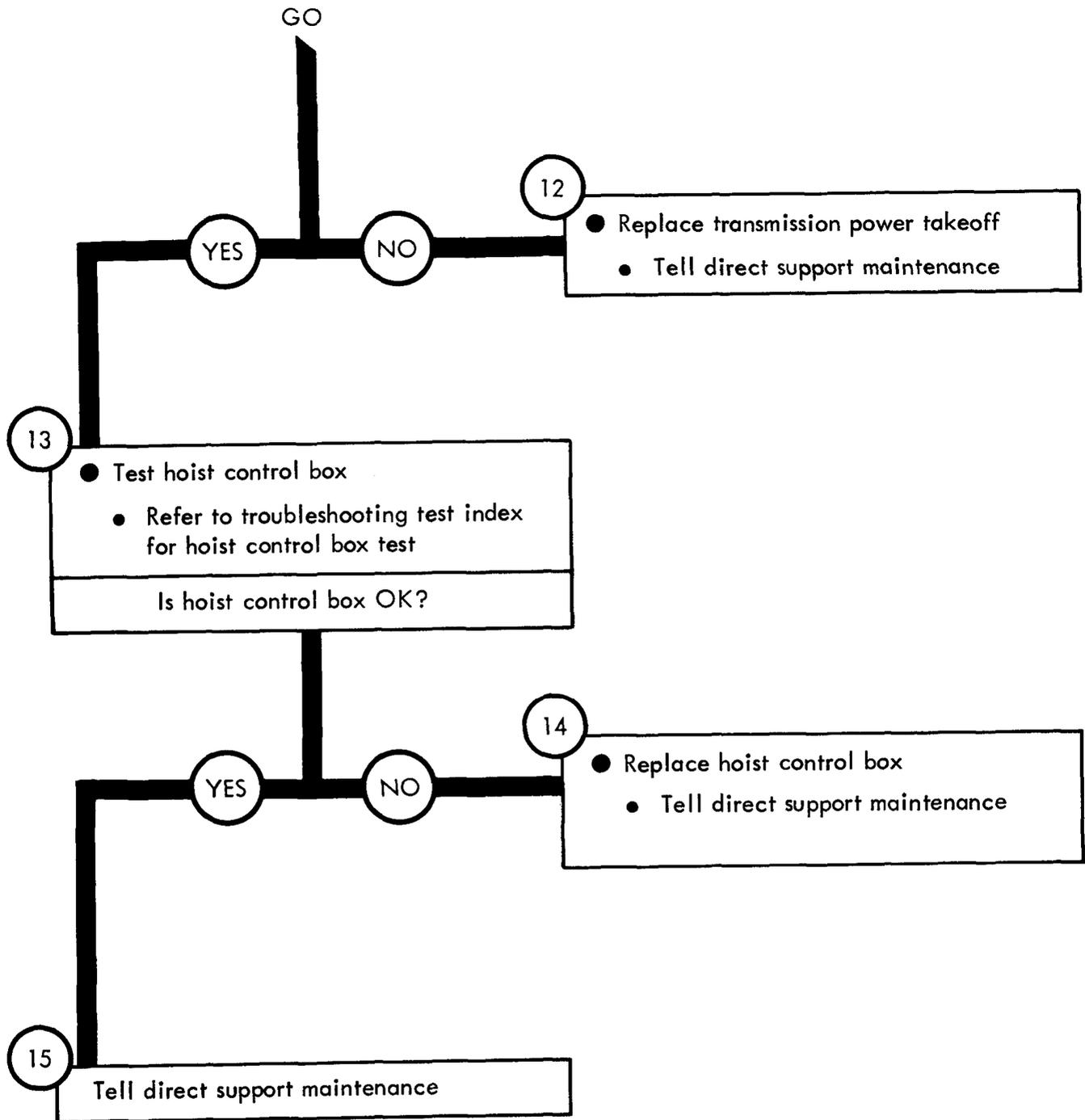

TA 114917

Figure 57-1 (Sheet 4 of 4)

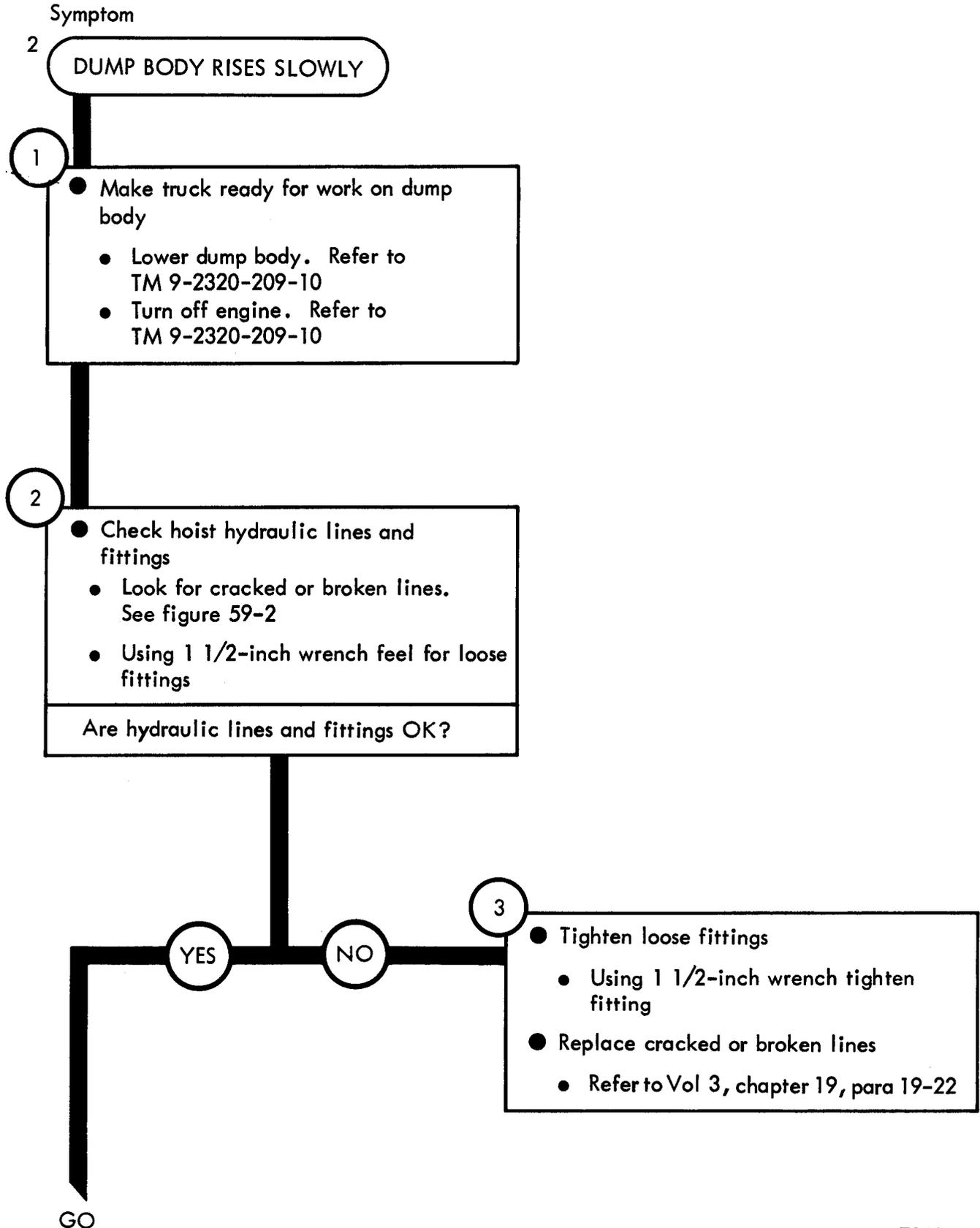

TA 114918

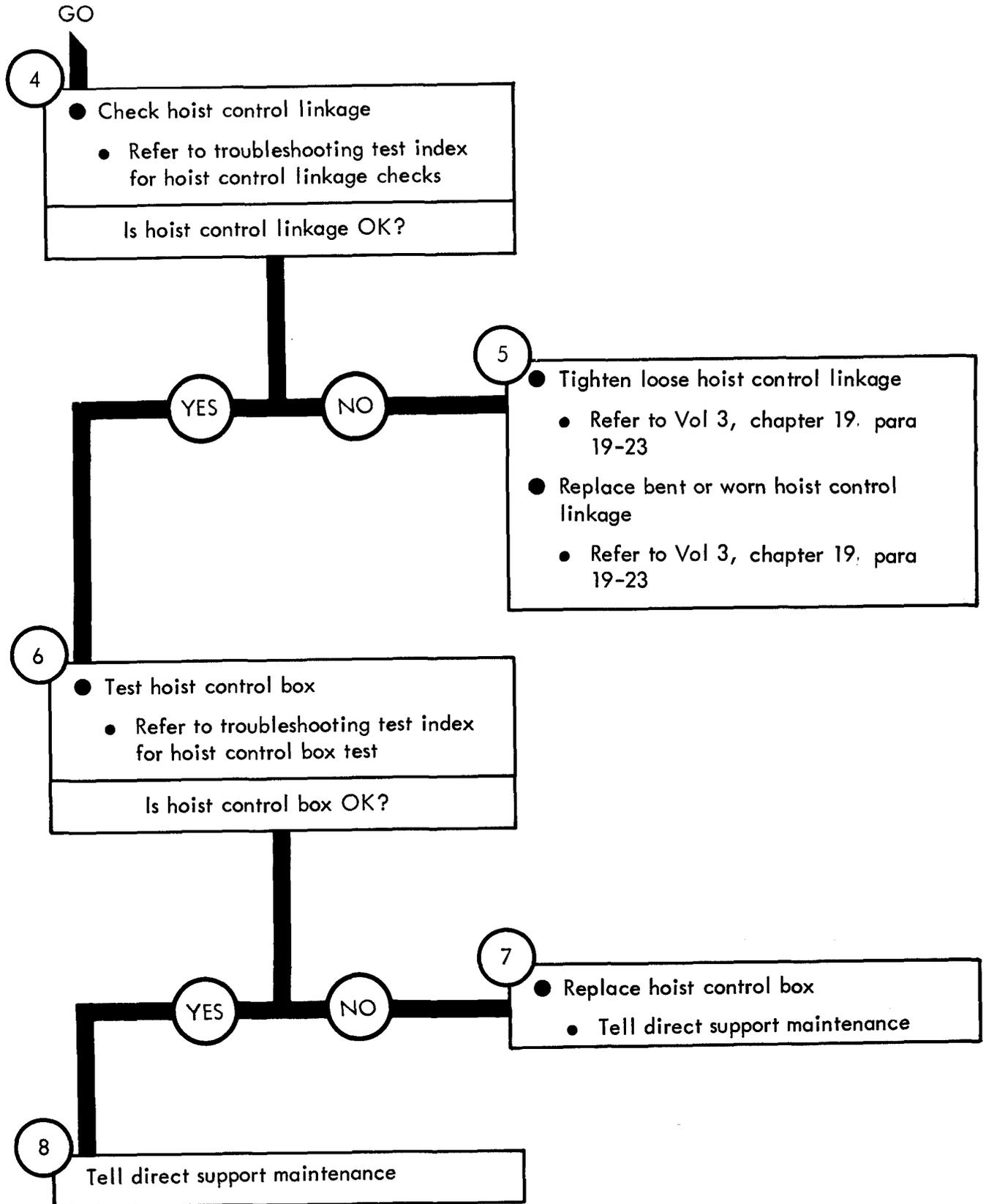

TA 114919

Figure 57-2 (Sheet 2 of 2)

Symptom

3

DUMP BODY WILL NOT HOLD IN RAISED POSITION

1

- Make truck ready for work on dump body
 - Lower dump body. Refer to TM 9-2320-209-10
 - Turn off engine. Refer to TM 9-2320-209-10
 - Chock wheels

2

- Check hydraulic lines and fittings
 - Look for cracked or broken lines. See figure 59-2
 - Using 1 1/2-inch wrench feel for loose fittings

Are hydraulic lines and fittings OK?

YES

NO

3

- Tighten loose fittings
 - Using 1 1/2-inch wrench tighten fitting
- Replace cracked or broken hydraulic lines
 - Refer to Vol 3, chapter 19, para 19-22

GO

Figure 57-3 (Sheet 1 of 2)

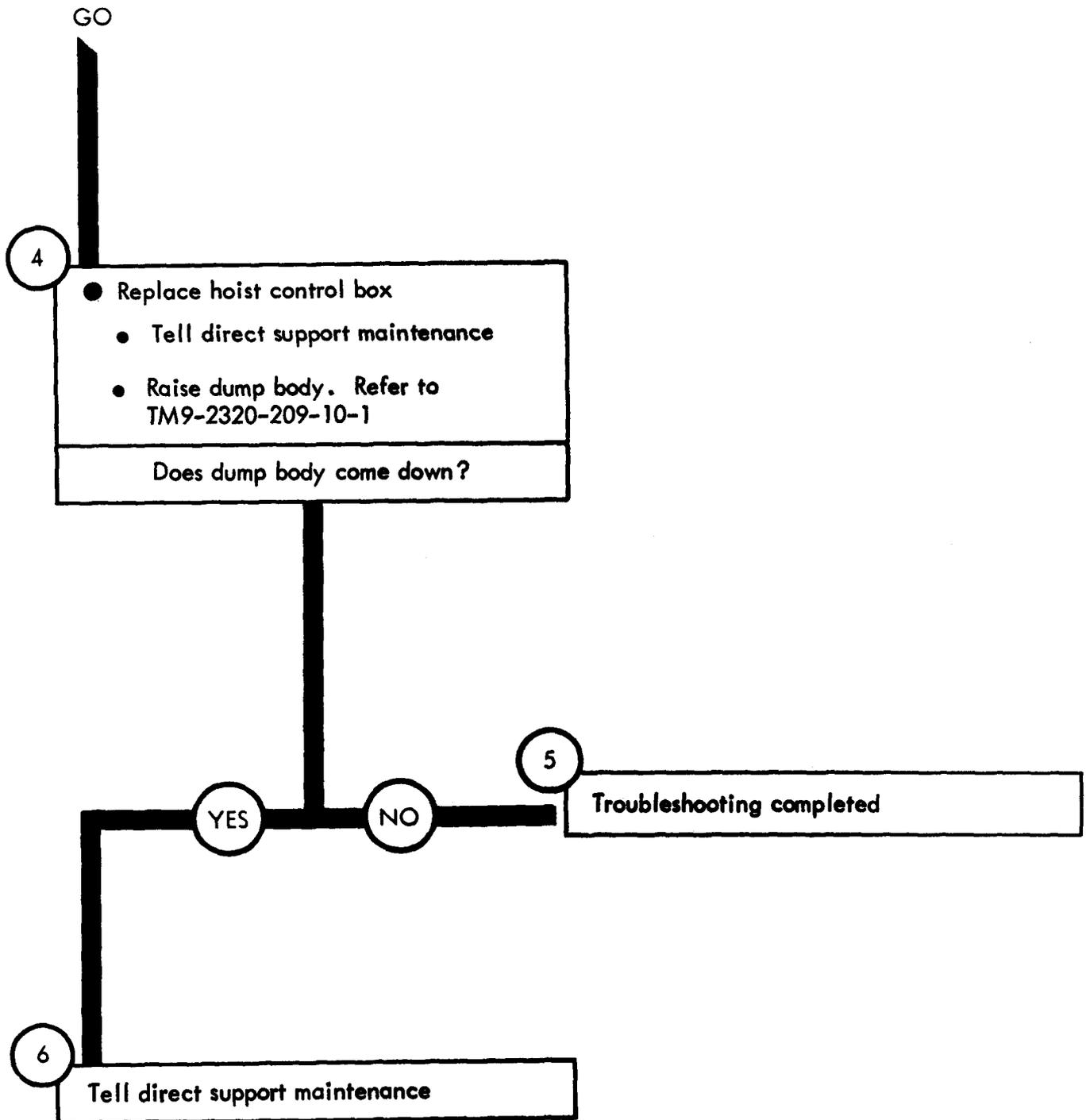
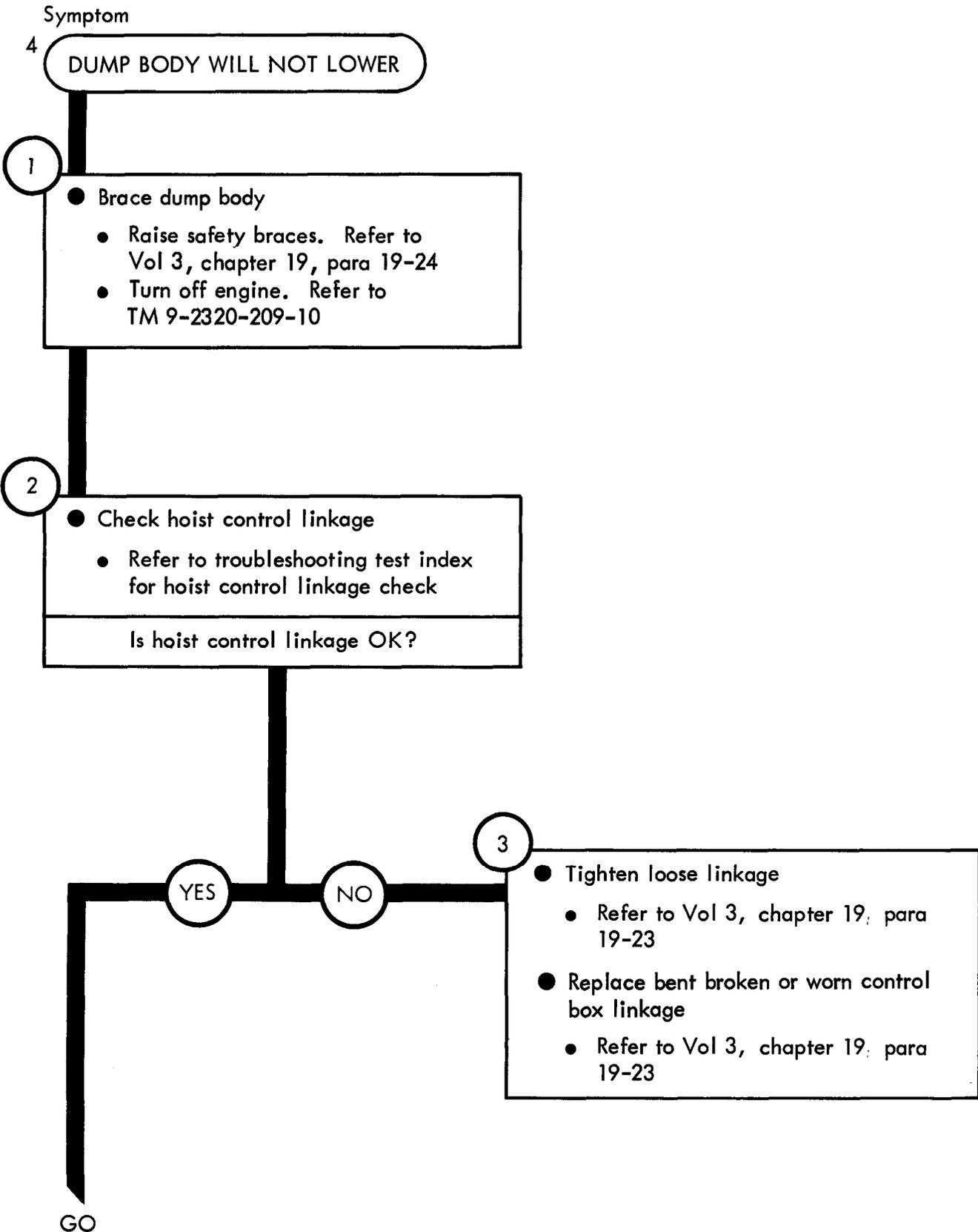
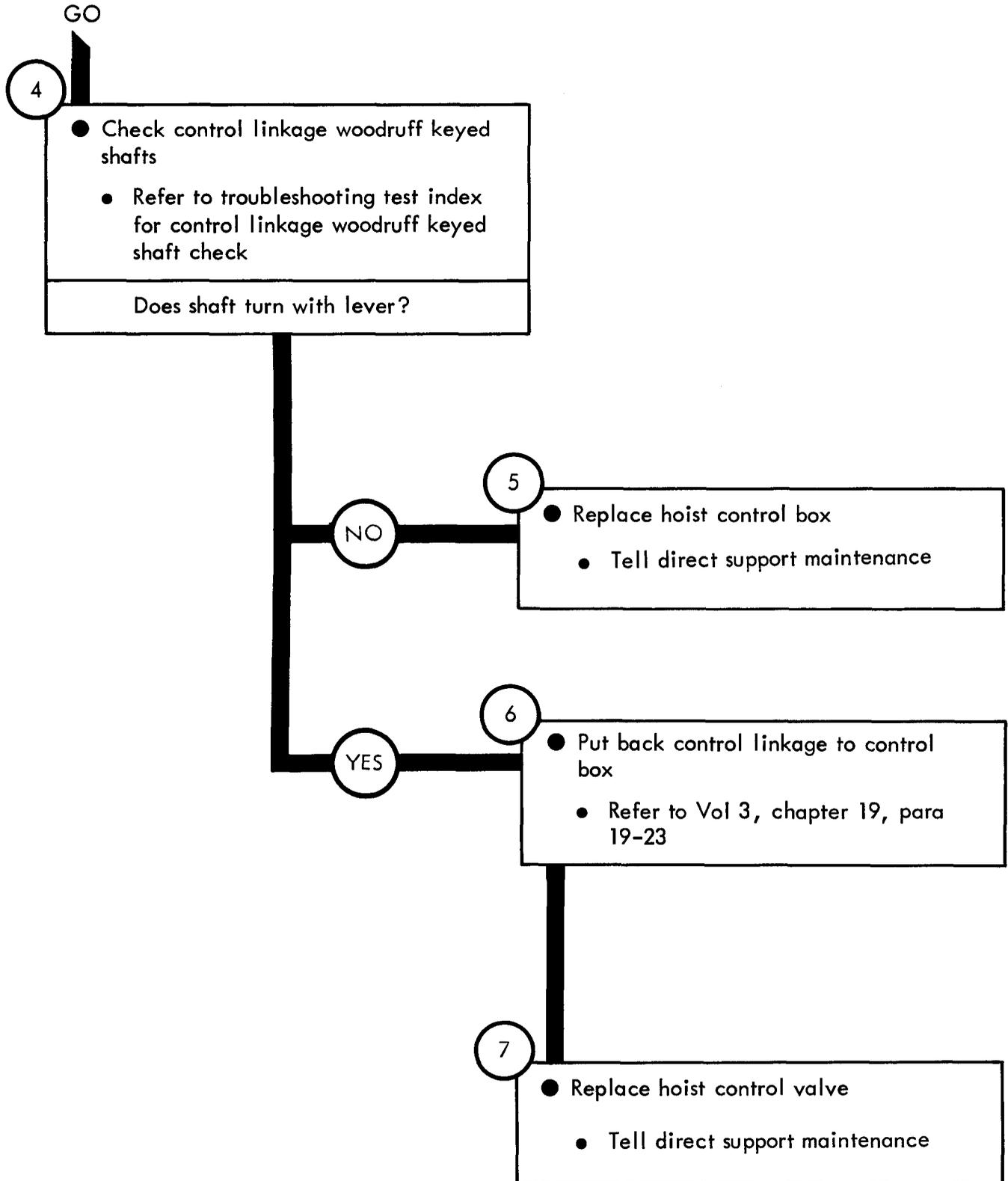

Figure 57-3 (Sheet 2 of 2)



TA 114922



TA 114923

Figure 57-4 (Sheet 2 of 2)

Symptom

5 DUMP BODY DOES NOT RISE ALL THE WAY

1

- Make truck ready for work on dump body
 - Park truck. Refer to TM 9-2320-209-10
 - Chock wheels

2

- Check hoist control linkage
 - Refer to troubleshooting test index for hoist control linkage check

Is linkage OK?

YES

NO

3

- Replace bent or worn control box linkage
 - Refer to Vol 3, chapter 19, para 19-23

GO

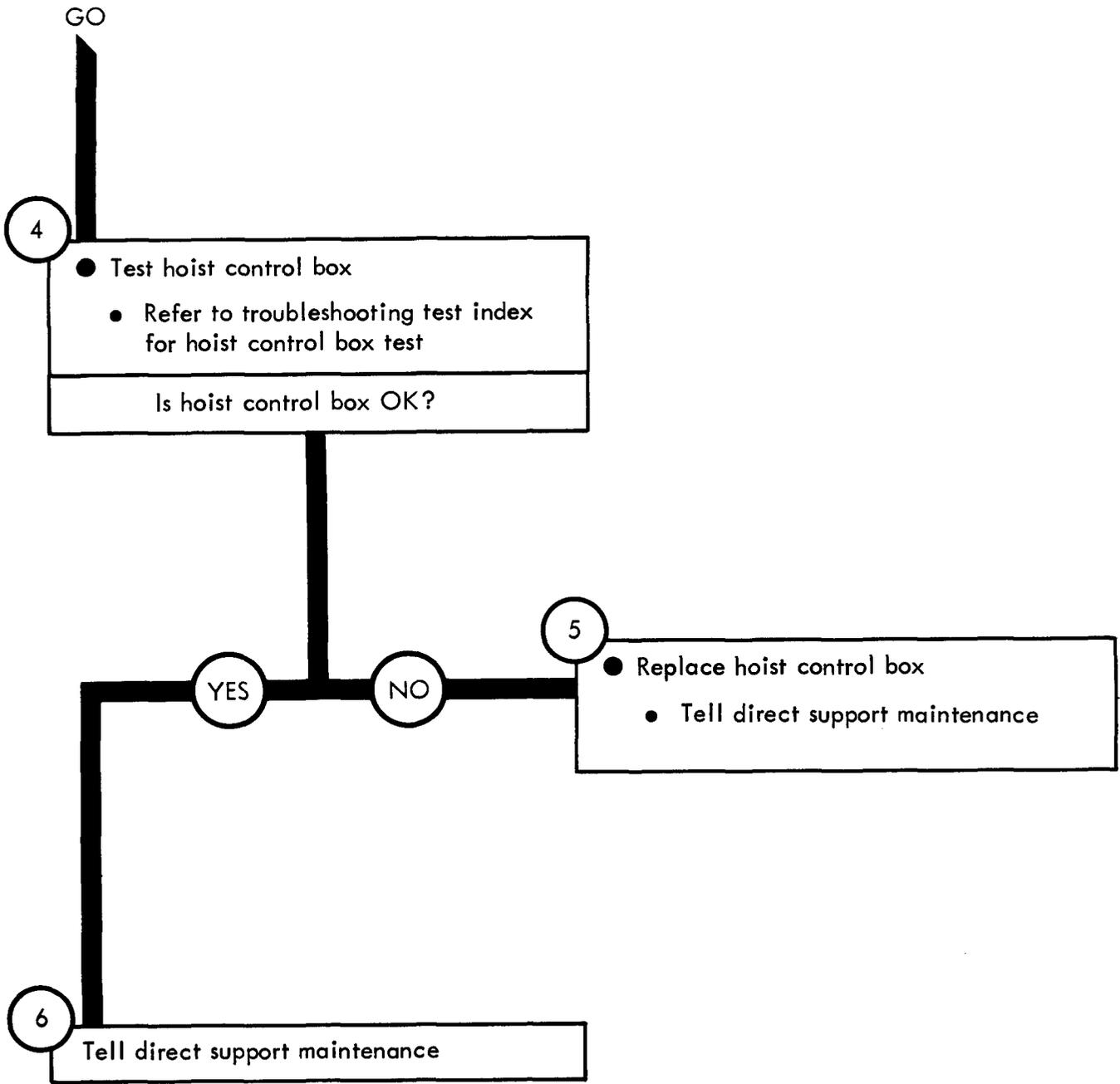

Figure 57-5 (Sheet 2 of 2)

DUMP BODY TROUBLESHOOTING TEST

6

HOIST CONTROL LINKAGE CHECK

- Check hoist control linkage
 - Look for bent or broken linkage.
See figure 59-1
 - Shake all linkage and feel if loose
 - Look for signs of wear in linkage

TA 114926

7

HOIST CONTROL BOX TEST

NOTE

This test will need the use of two soldiers. The lead soldier will be called Soldier A and the helper will be called Soldier B

- Test hoist control box as follows
 - SOLDIER B: ● Sit in drivers seat and wait for instructions from SOLDIER A
 - SOLDIER A: ● Crawl under truck
 - Tell SOLDIER B to move dump control lever to position B
 - SOLDIER B: ● Take off lock and move dump control lever forward to position B
 - SOLDIER A: ● See if power takeoff rod moves toward front of truck. See figure 59-1

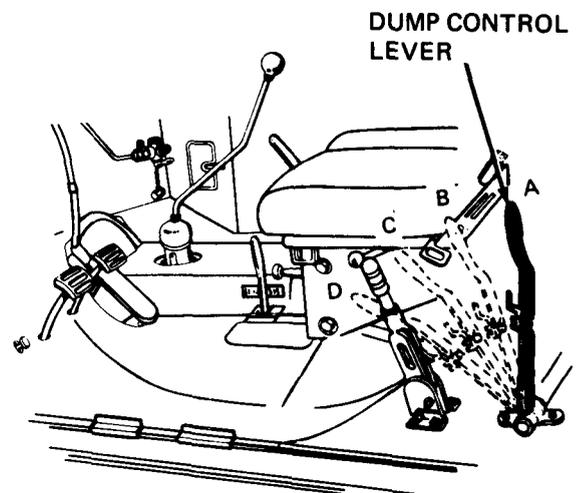

GO

TA 114927

GO

- SOLDIER A: ● Tell SOLDIER B to move dump control lever to position C
- SOLDIER B: ● Move dump control lever forward to position C
- SOLDIER A: ● See if spool control rod moves up
 - Tell SOLDIER B to move dump control lever to position D
- SOLDIER B: ● Move dump control lever forward to position D

- SOLDIER A: ● See if spool control rod moves up
 - Push up hoist control lever
 - See if spool valve moves up
 - Note: The spool valve should not move up more than 1/4-inch
 - Tell SOLDIER B to move dump control lever to position A
- SOLDIER B: ● Move dump control lever to position A and lock it

8

CONTROL LINKAGE WOODRUFF KEYED SHAFT CHECK

- Check control linkage woodruff keyed shafts
 - Take off control linkage at control box. Refer to Vol 3, chapter 19, para 19-23
- Note: Control linkage is attached to a control box lever on the control box. This lever is attached to control box by a woodruff keyed shaft. This shaft is visible where the control box lever attaches to the shaft
- Move control box levers and see if shaft turns with lever

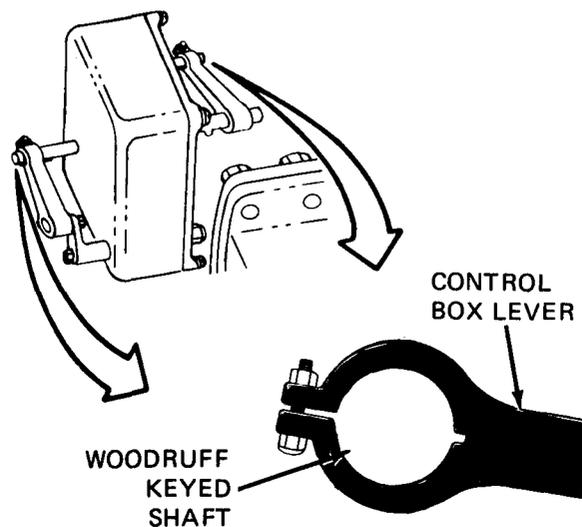

TA 114929

Figure 57-8

57-17/(57-18 blank)

CHAPTER 58

DUMP BODY TROUBLESHOOTING SUMMARY

58-1. GENERAL. This chapter gives a summary of troubleshooting procedures given in chapter 57 for the dump body.

58-2. PROCEDURES. The summary in this chapter covers all fault symptoms found in the detailed troubleshooting procedures. Chapter 7 outlines a sample troubleshooting procedure. The summary procedures are based on the "what-to-do" portions of the detailed procedures and do not include the "how-to-do-it" instructions. Warnings, cautions, and notes are given where needed.

DUMP BODY TROUBLESHOOTING SUMMARY

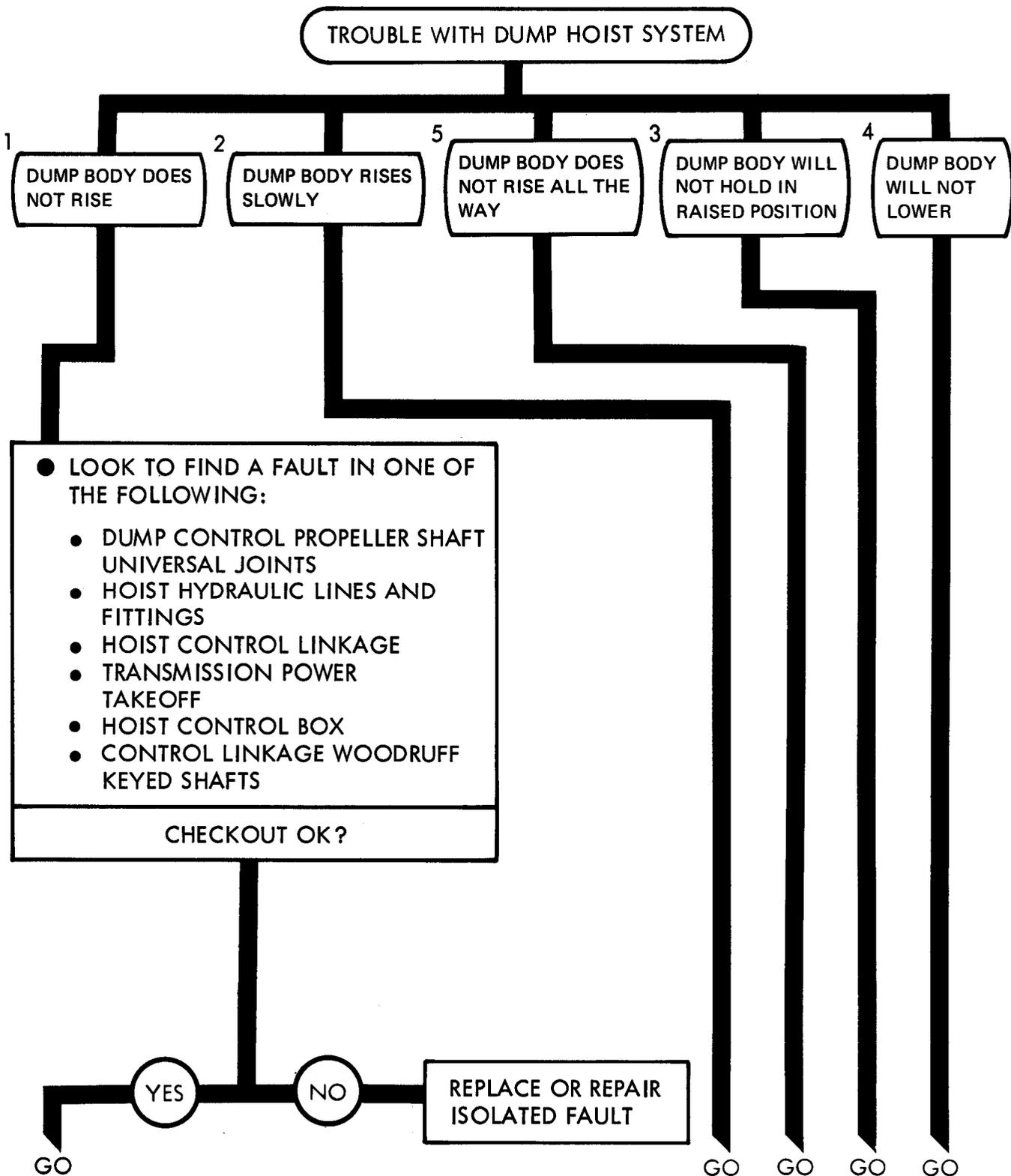

Figure 58-1 (Sheet 1 of 4)

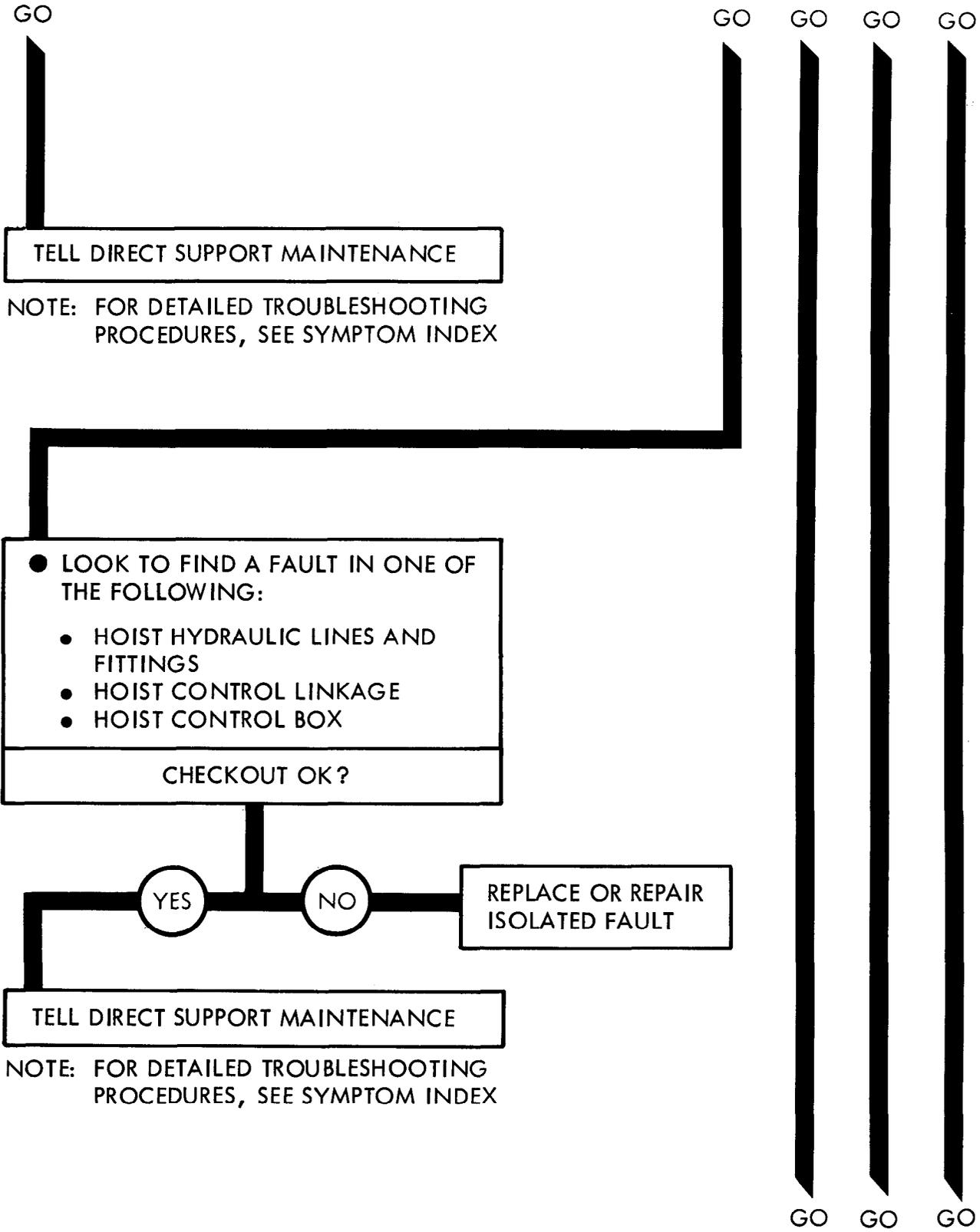
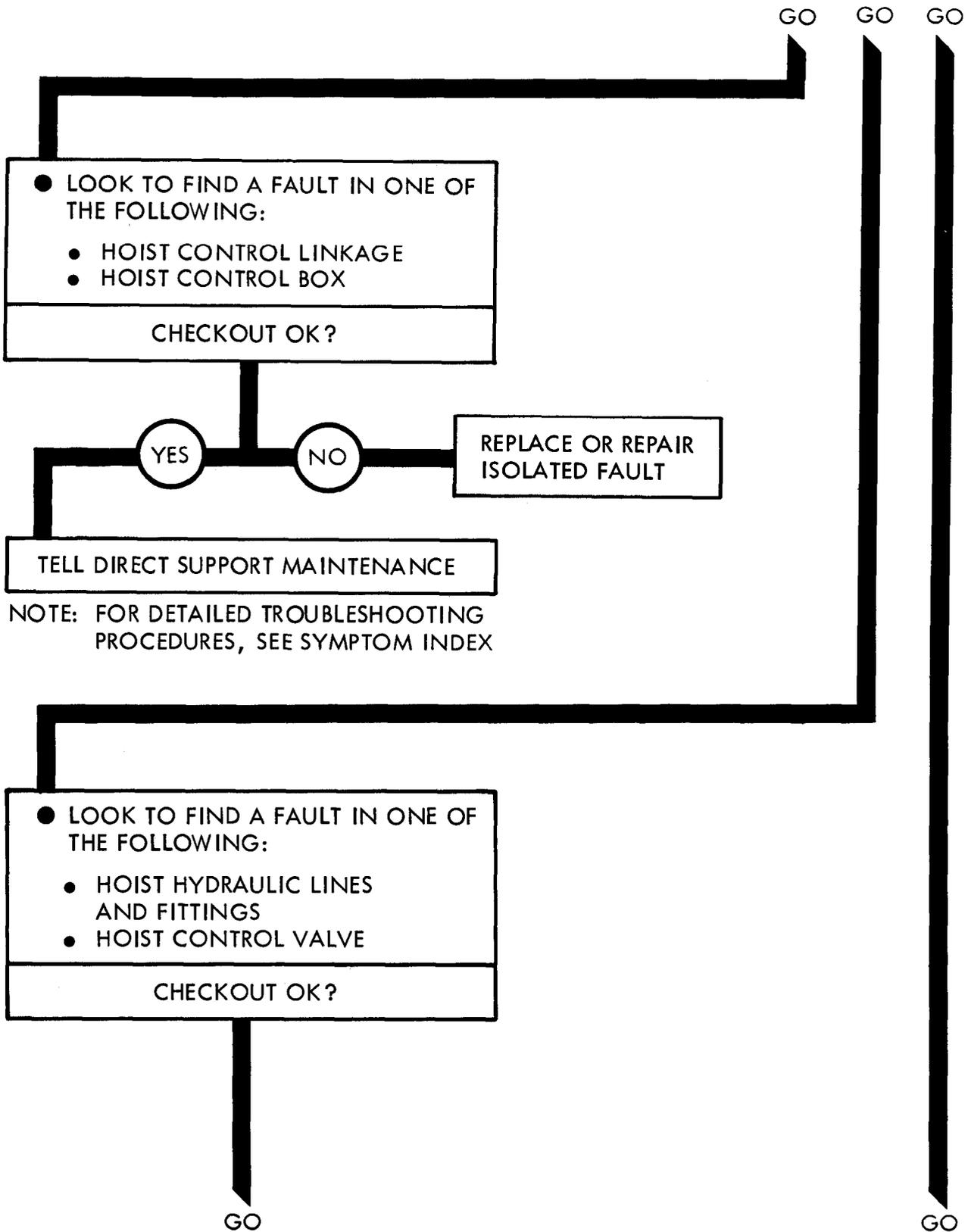
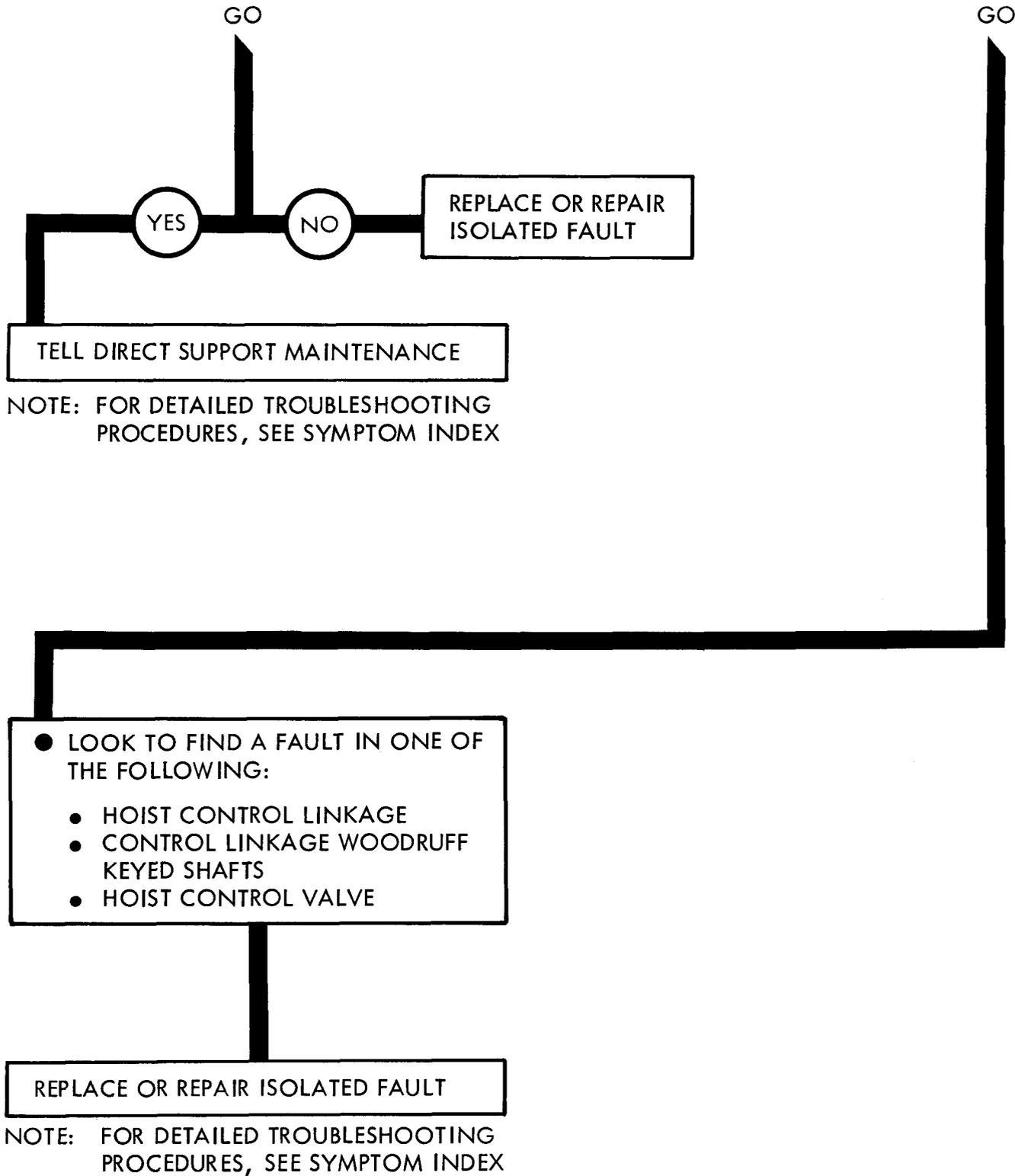

Figure 58-1 (Sheet 2 of 4)



TA 114932

Figure 58-1 (Sheet 3 of 4)



CHAPTER 59

DUMP BODY SUPPORT DIAGRAMS

59-1 GENERAL. This chapter gives the diagrams you need when doing troubleshooting procedures in chapter 57. Table 3-1 is a complete listing of all support diagrams used in this manual.

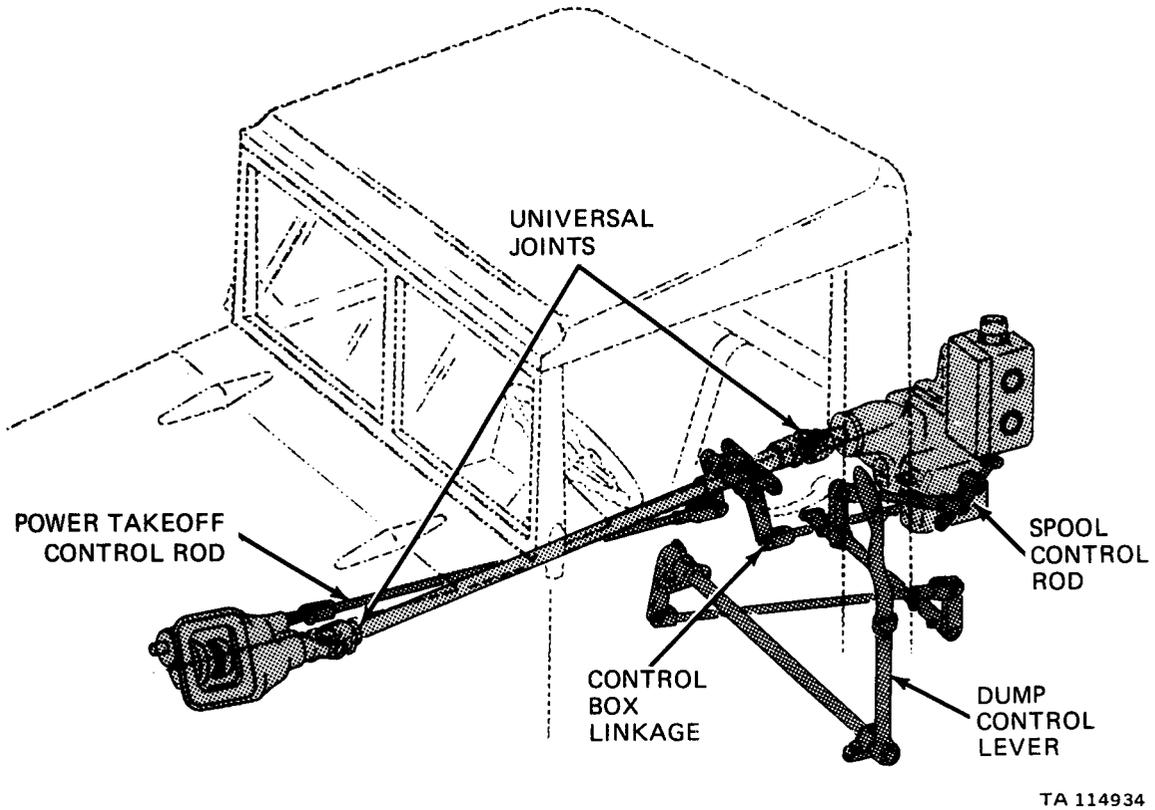
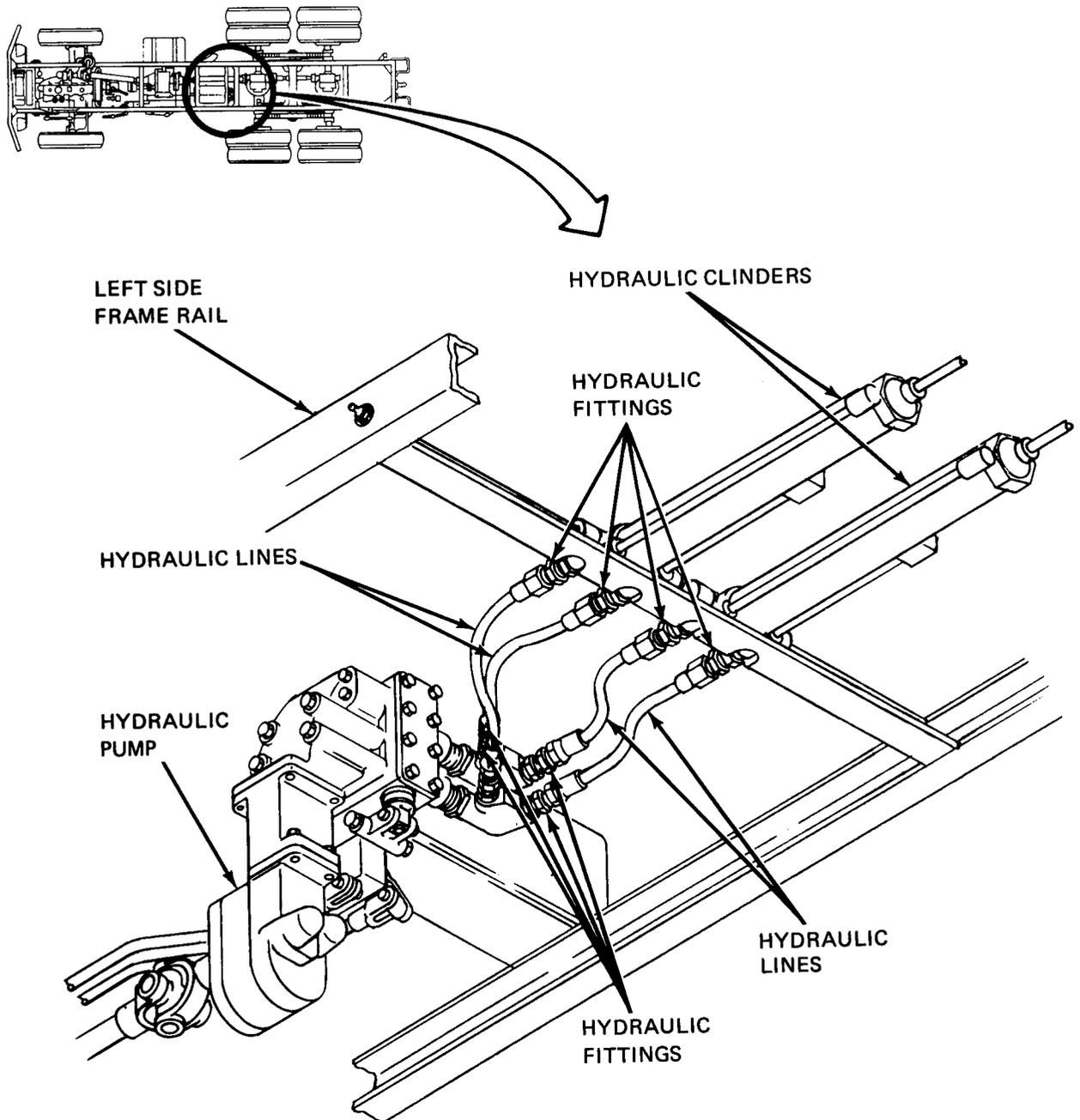

Figure 59-1. Support Diagram



TA 114935

Figure 59-2. Support Diagram

CHAPTER 60

DUMP BODY CHECKOUT PROCEDURES

60-1. GENERAL. This chapter gives procedures for checking out the system after troubleshooting and repair have been done. Procedures are set up in flow chart form showing the checkout steps in order and referring to the fault symptom index when the system does not checkout.

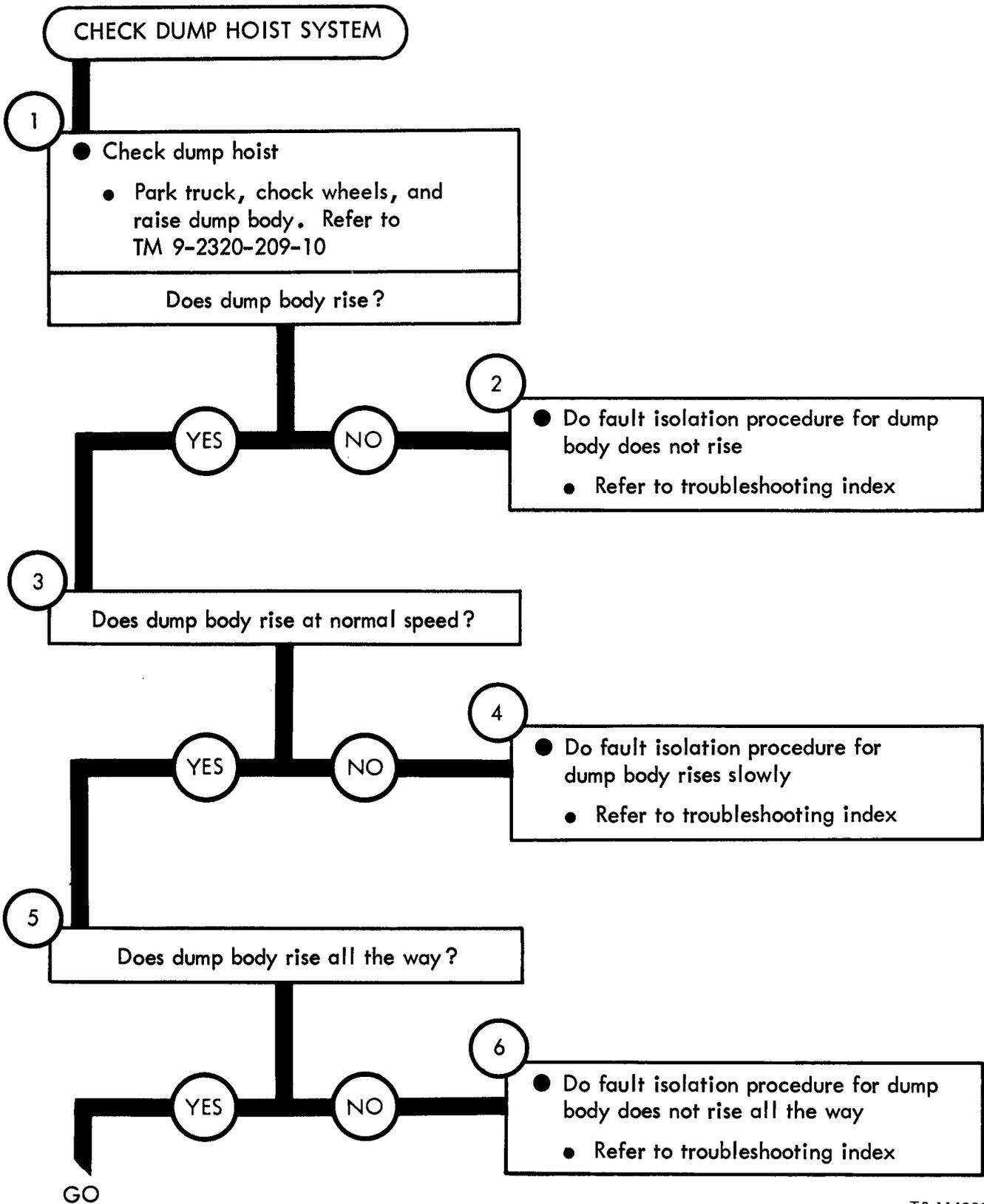

TA 114936

Figure 60-1 (Sheet 1 of 2)

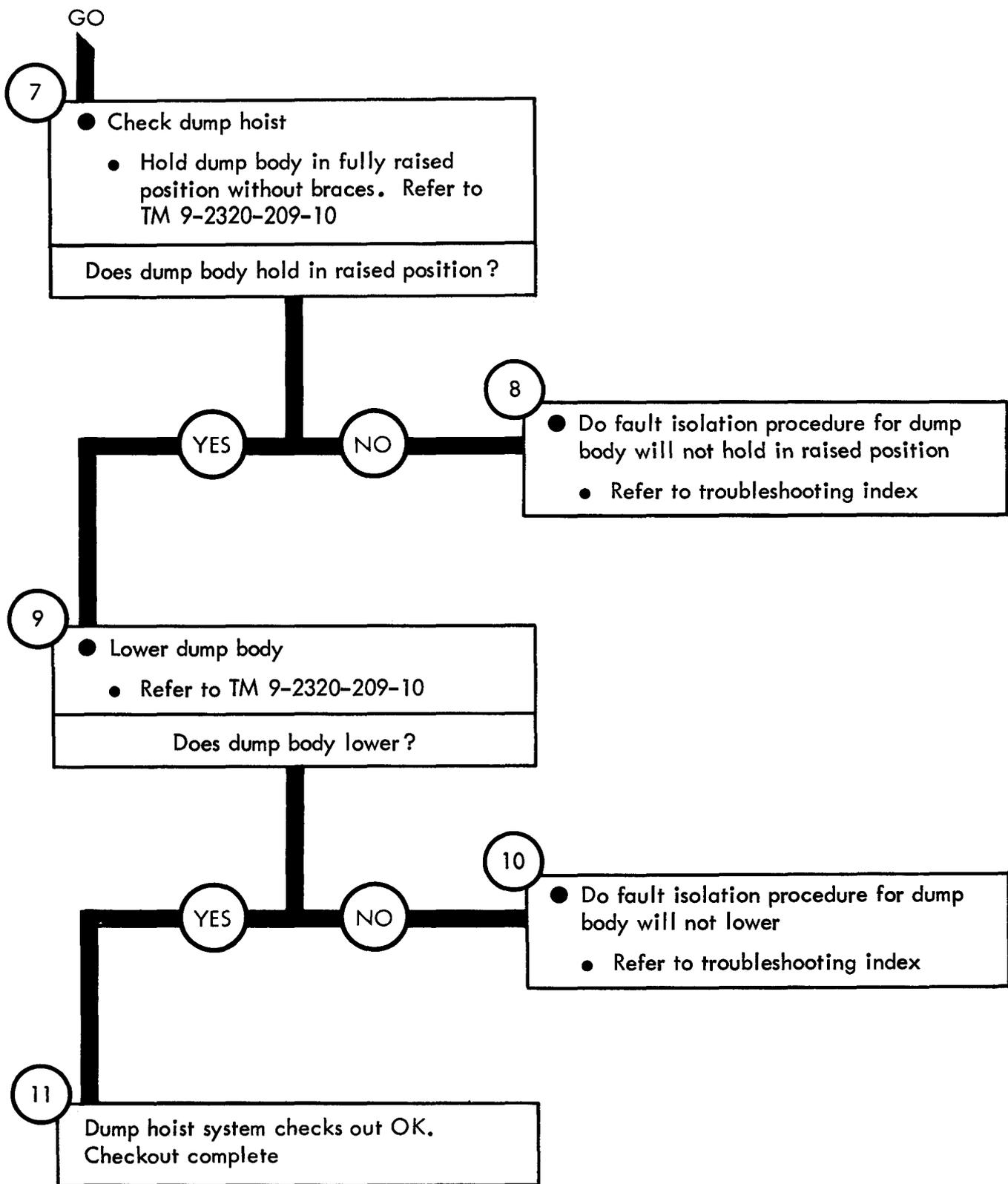

TA 114937

Figure 60-1 (Sheet 2 of 2)

CHAPTER 61

WATER TANK BODY TROUBLESHOOTING

61-1. EQUIPMENT ITEMS COVERED. This chapter gives equipment troubleshooting procedures for the water tank body, for which there are authorized corrective maintenance tasks at the organizational maintenance level.

61-2. EQUIPMENT ITEMS NOT COVERED. All equipment items for which corrective maintenance is authorized at the organizational maintenance level are covered in this chapter.

WATER TANK BODY TROUBLESHOOTING

Symptom

1 WATER CANNOT BE PUMPED FROM BOTH TANKS

- 1
- Stop pumping operations
 - Close pump delivery line valve
 - Push discharge valve control lever to front of truck
 - Turn off engine. Refer to TM 9-2320-209-10

- 2
- Check delivery pump drive shafts
 - Look for broken universal joints. See figure 63-1
 - Look for a broken drive shaft
- Are delivery pump drive shafts OK?

- YES
- NO
- 3
- Replace broken universal joints
 - Refer to Vol 3, chapter 18, para 18-36
 - Replace broken propeller shaft
 - Refer to Vol 3, chapter 18, para 18-35

GO

Figure 61-1 (Sheet 1 of 4)

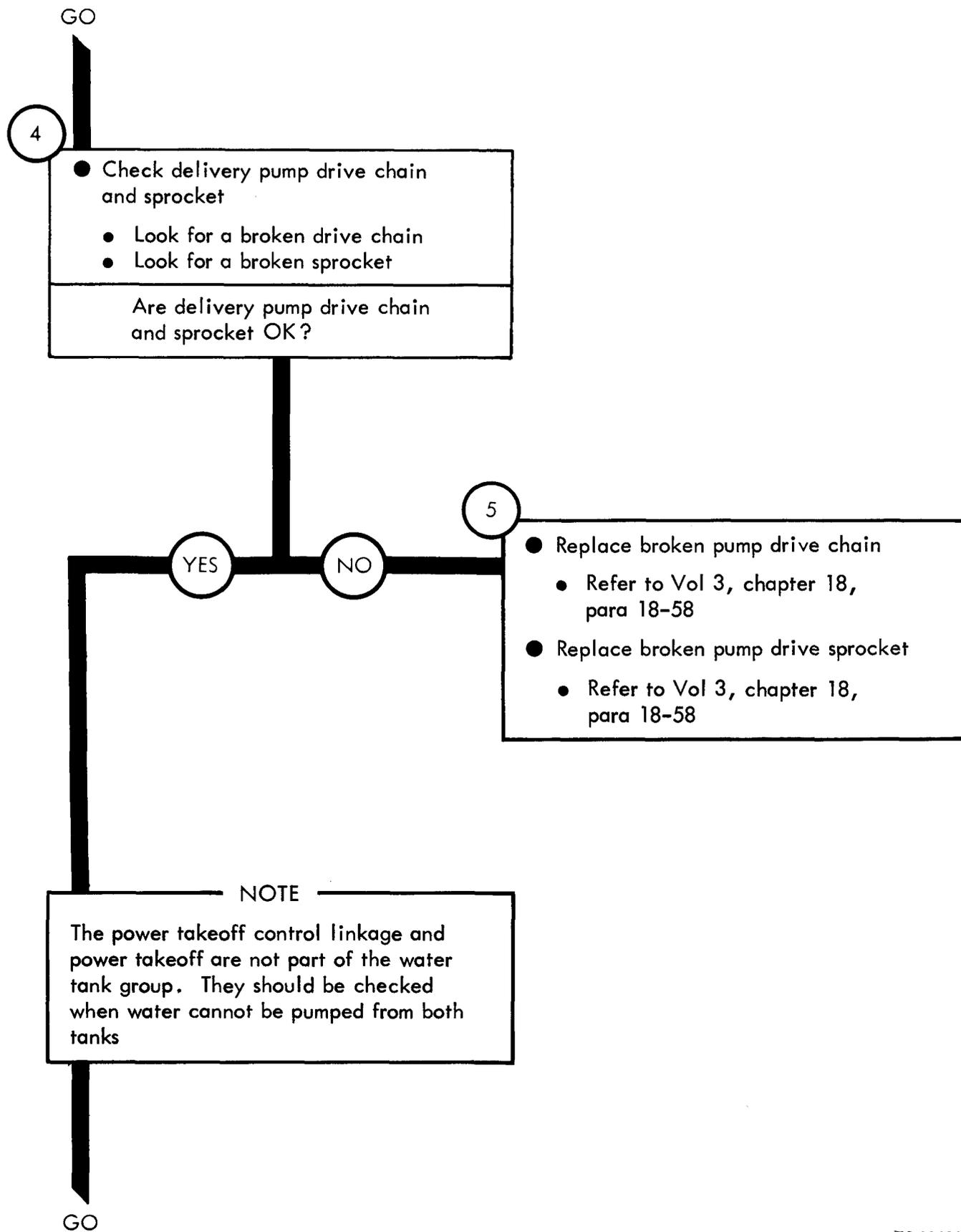

Figure 61-1 (Sheet 2 of 4)

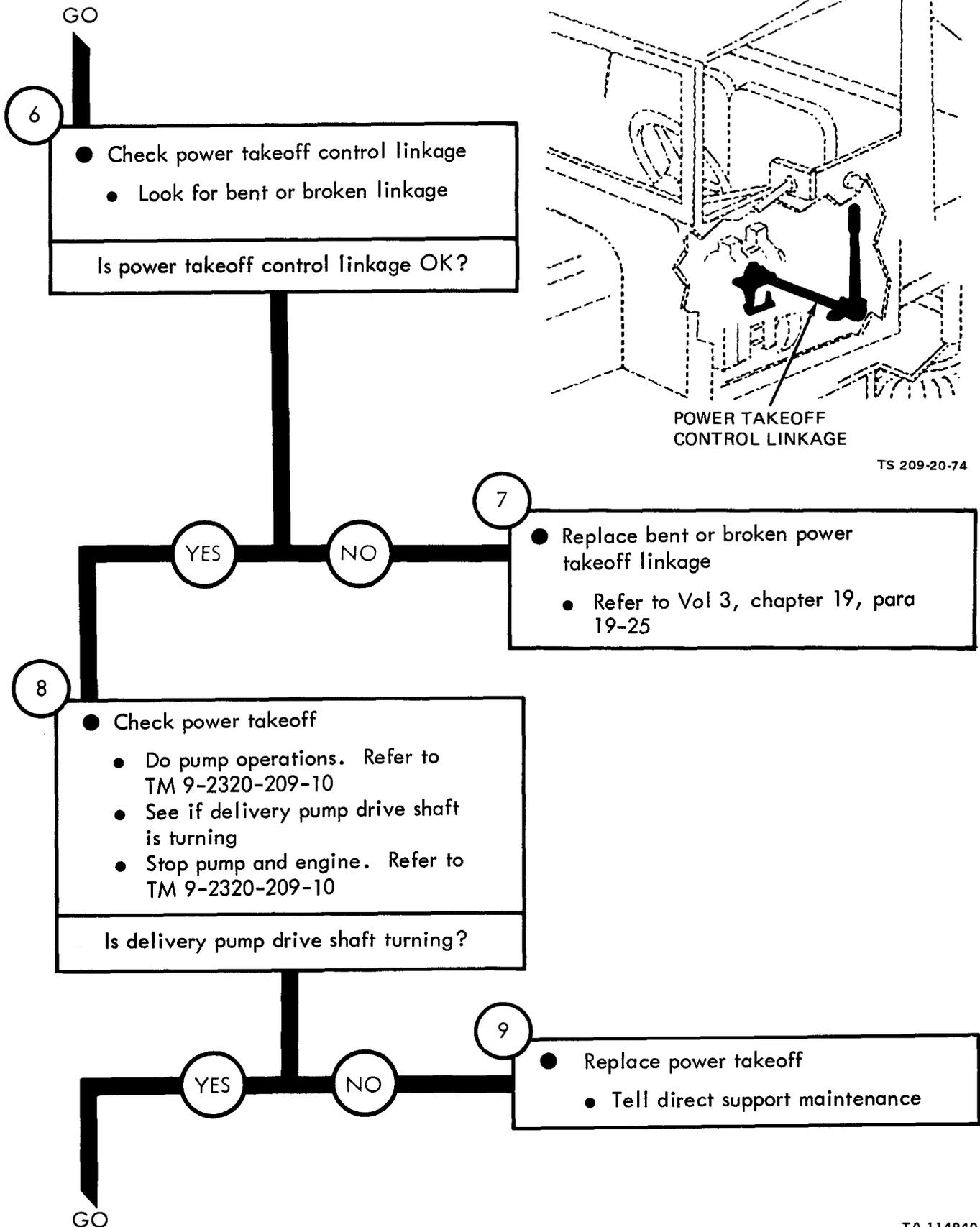
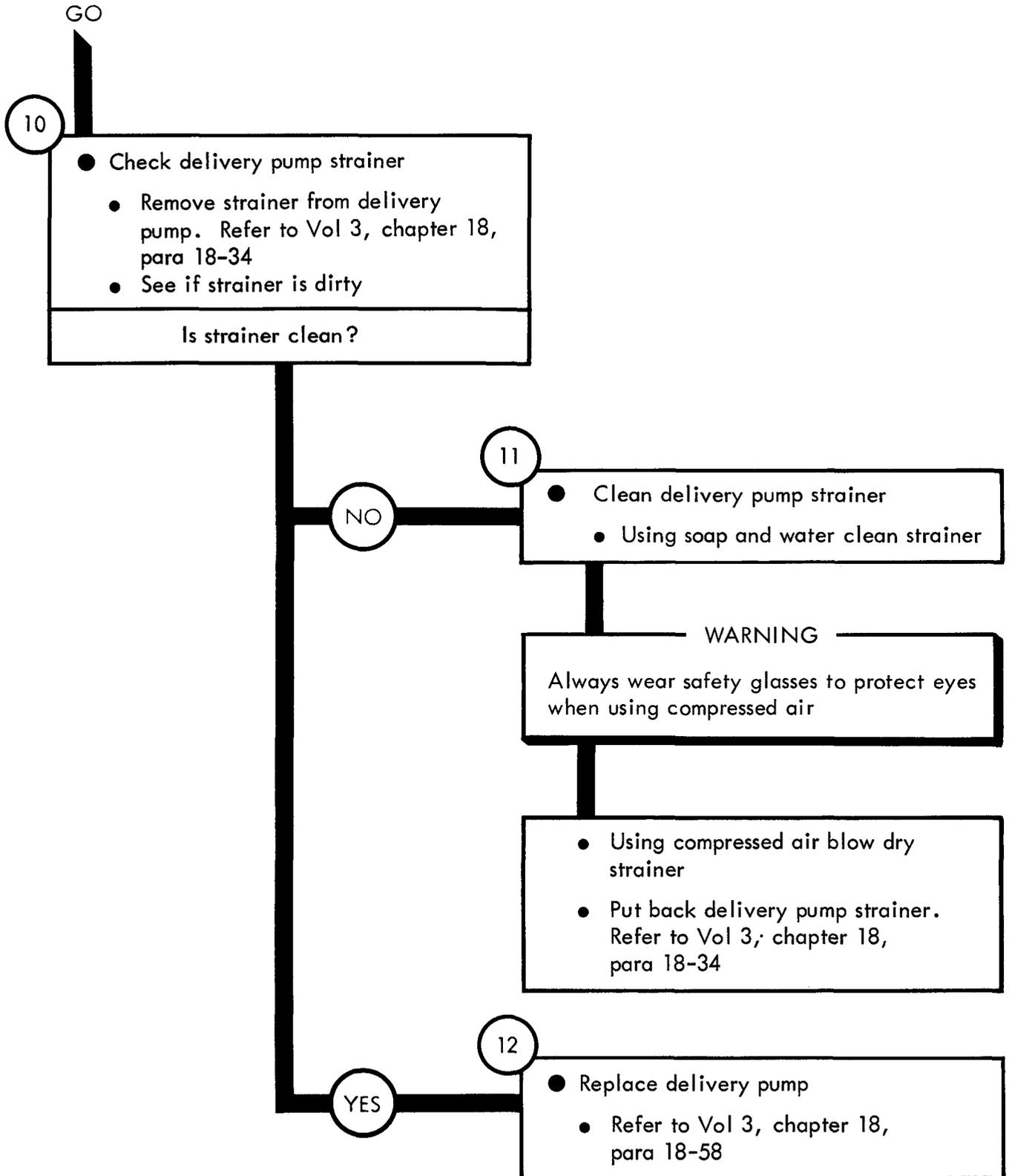

Figure 61-1 (Sheet 3 of 4)



TA 114941

Figure 61-1 (Sheet 4 of 4)

Symptom

2

WATER CANNOT BE PUMPED FROM TANK SELECTED

1

- Stop pumping operations
 - Close pump delivery line valve
 - Push discharge valve control lever to front of truck
 - Turn off engine. Refer to TM 9-2320-209-10

2

- Check discharge valve control cables
 - Look for a broken cable. See figure 63-1
 - Shake cable at discharge valve to feel if it is loose

Is discharge valve control cable OK?

GO

Figure 61-2 (Sheet 1 of 2)

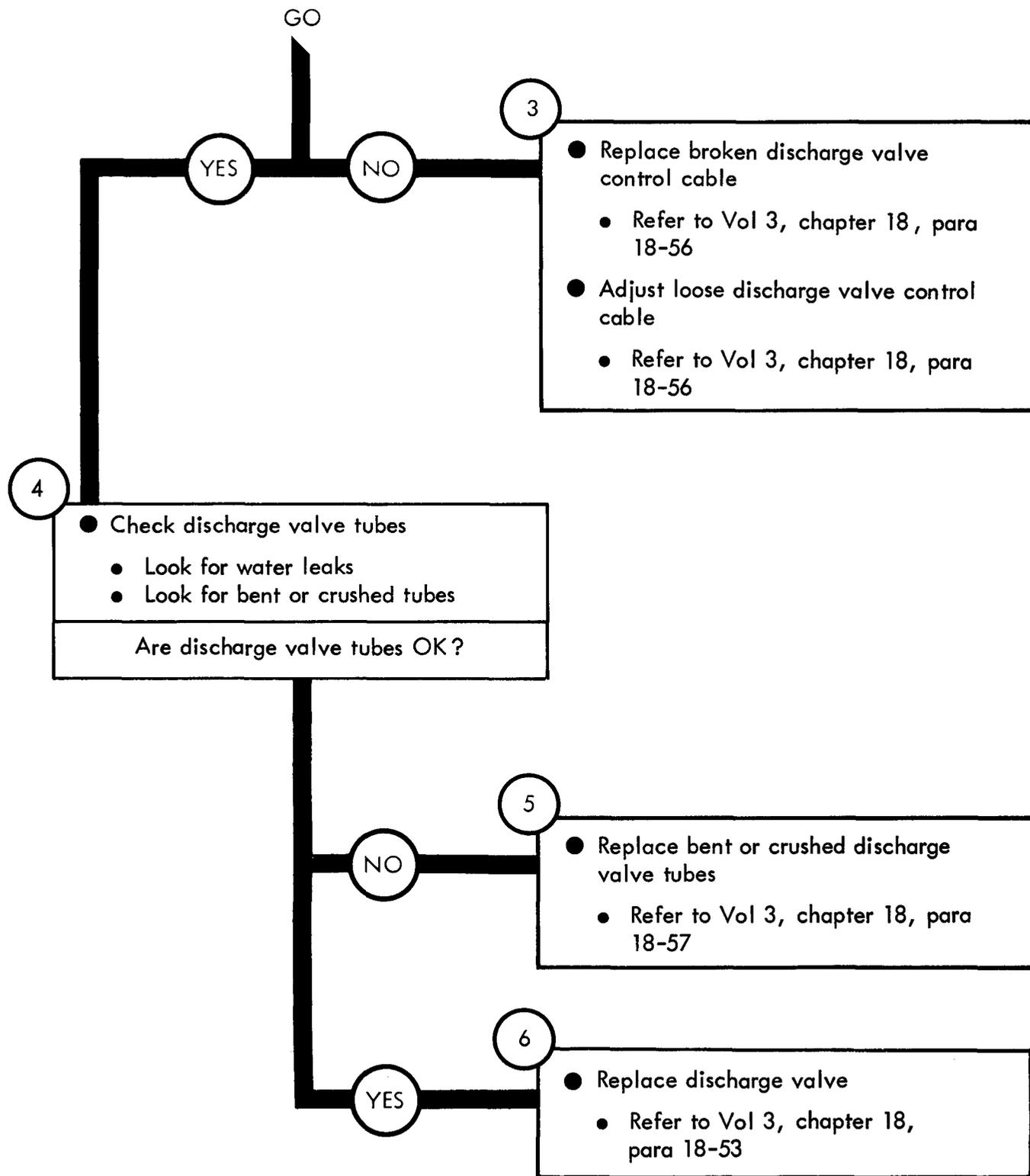

Figure 61-2 (Sheet 2 of 2)

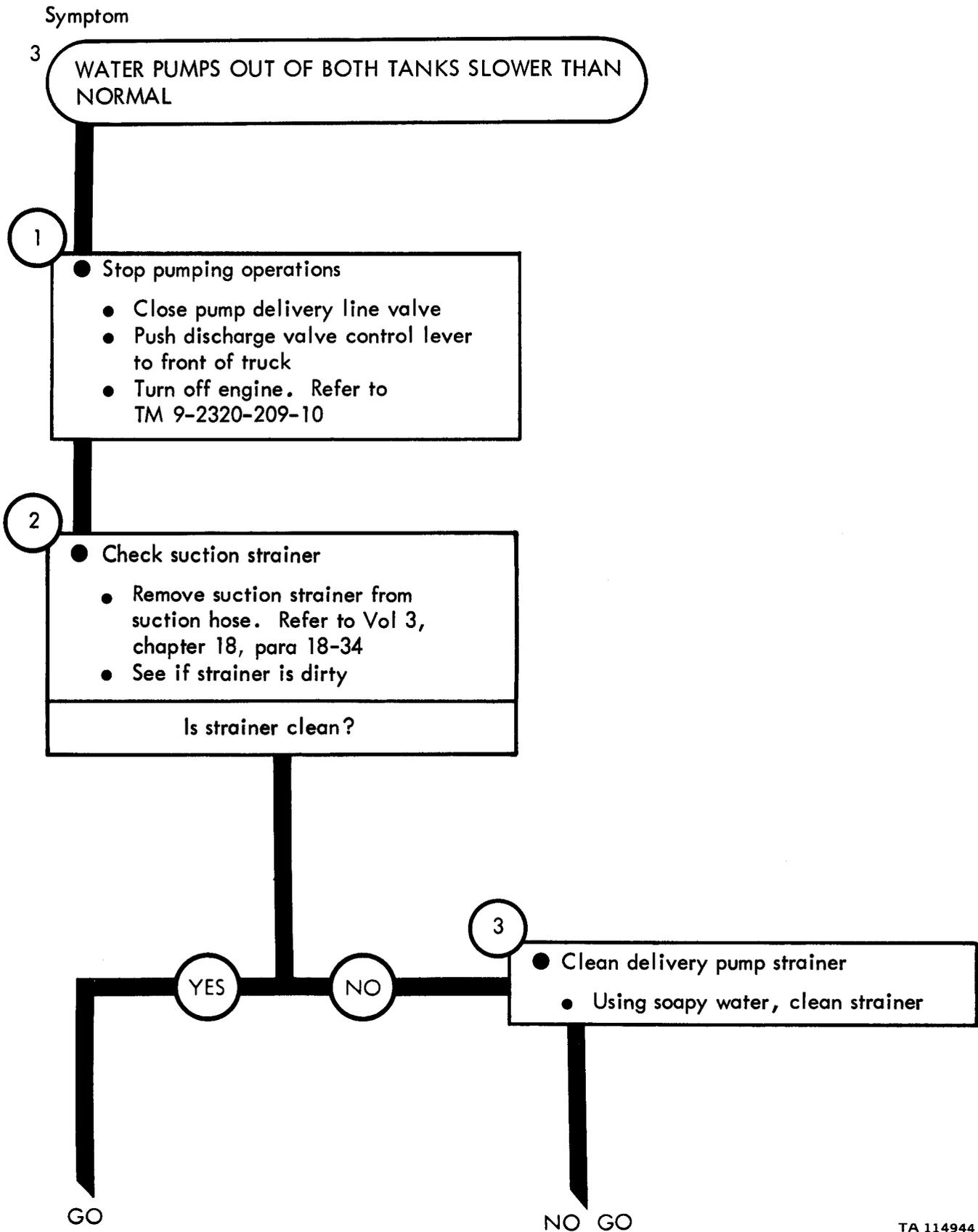

Figure 61-3 (Sheet 1 of 3)

TA 114944

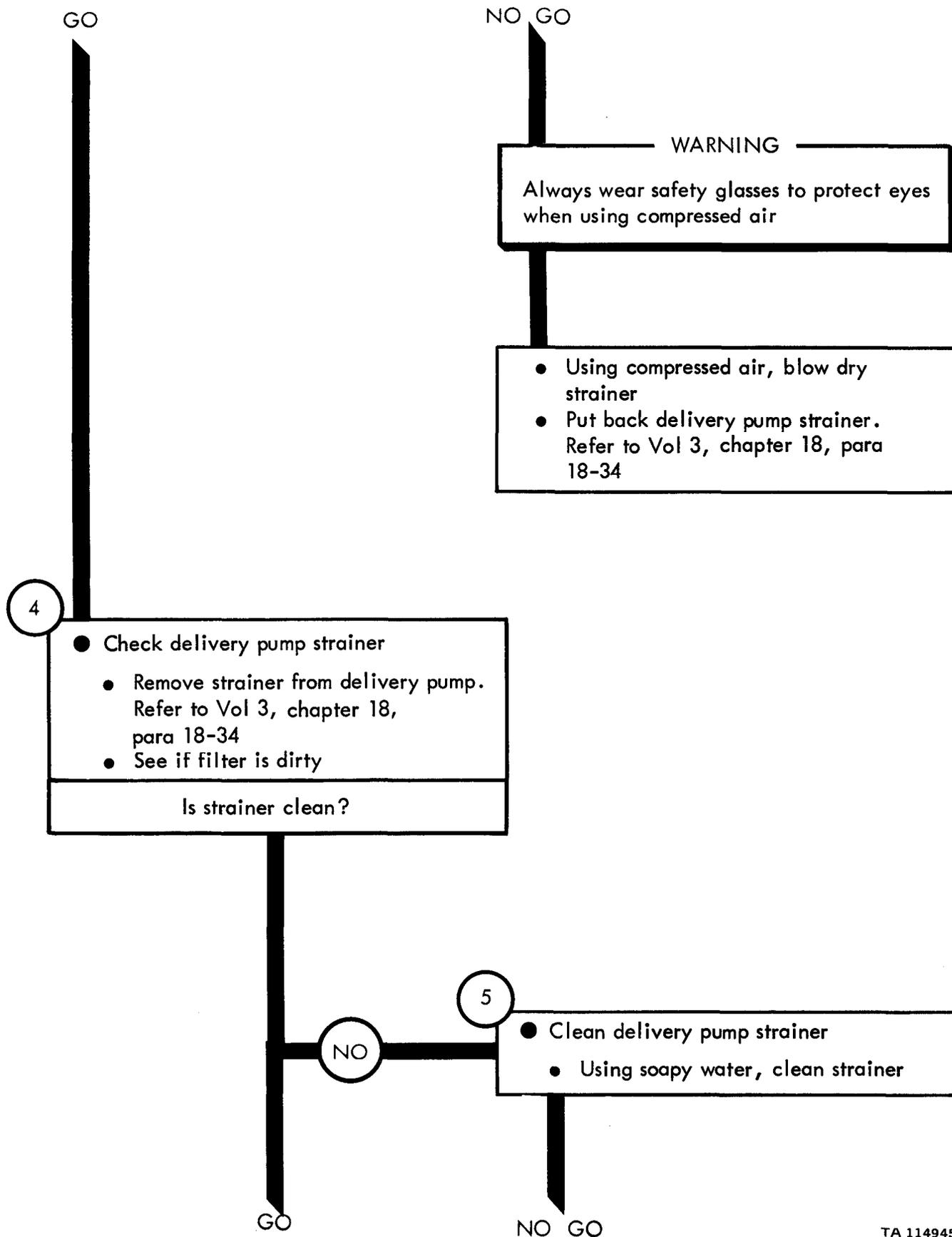

Figure 61-3 (Sheet 2 of 3)

TA 114945

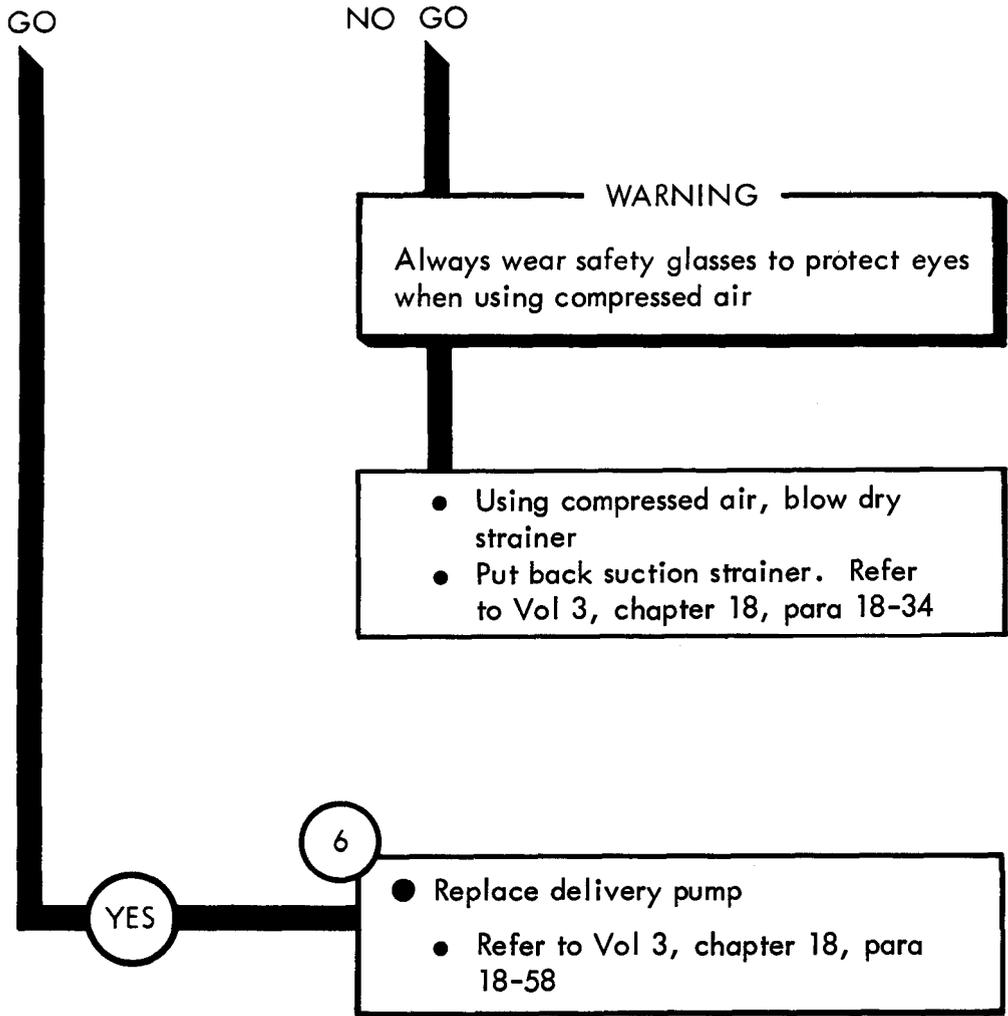

Figure 61-3 (Sheet 3 of 3)

TA 114946

Symptom

4

WATER DOES NOT DRAIN USING GRAVITY PROCEDURES

1

- Stop gravity discharge operations
 - Close discharge valve control levers
 - Close gravity delivery valve
 - Chock wheels

2

- Check discharge valve control cables
 - Look for a broken cable. See figure 63-1
 - Shake cable at discharge valve to feel if it is loose

Is discharge valve control cable OK?



GO

Figure 61-4 (Sheet 1 of 2)

Symptom

5

WATER DRAINS SLOWLY USING GRAVITY PROCEDURES

1

- Stop gravity discharge operations
 - Close discharge valve control levers
 - Close gravity delivery valve
 - Chock wheels

2

- Check discharge valve control cables
 - Look for a kinked cable. See figure 63-1
 - Shake cable at discharge valve to feel if it is loose

Is discharge valve control cable OK?

GO

Figure 61-5 (Sheet 1 of 2)

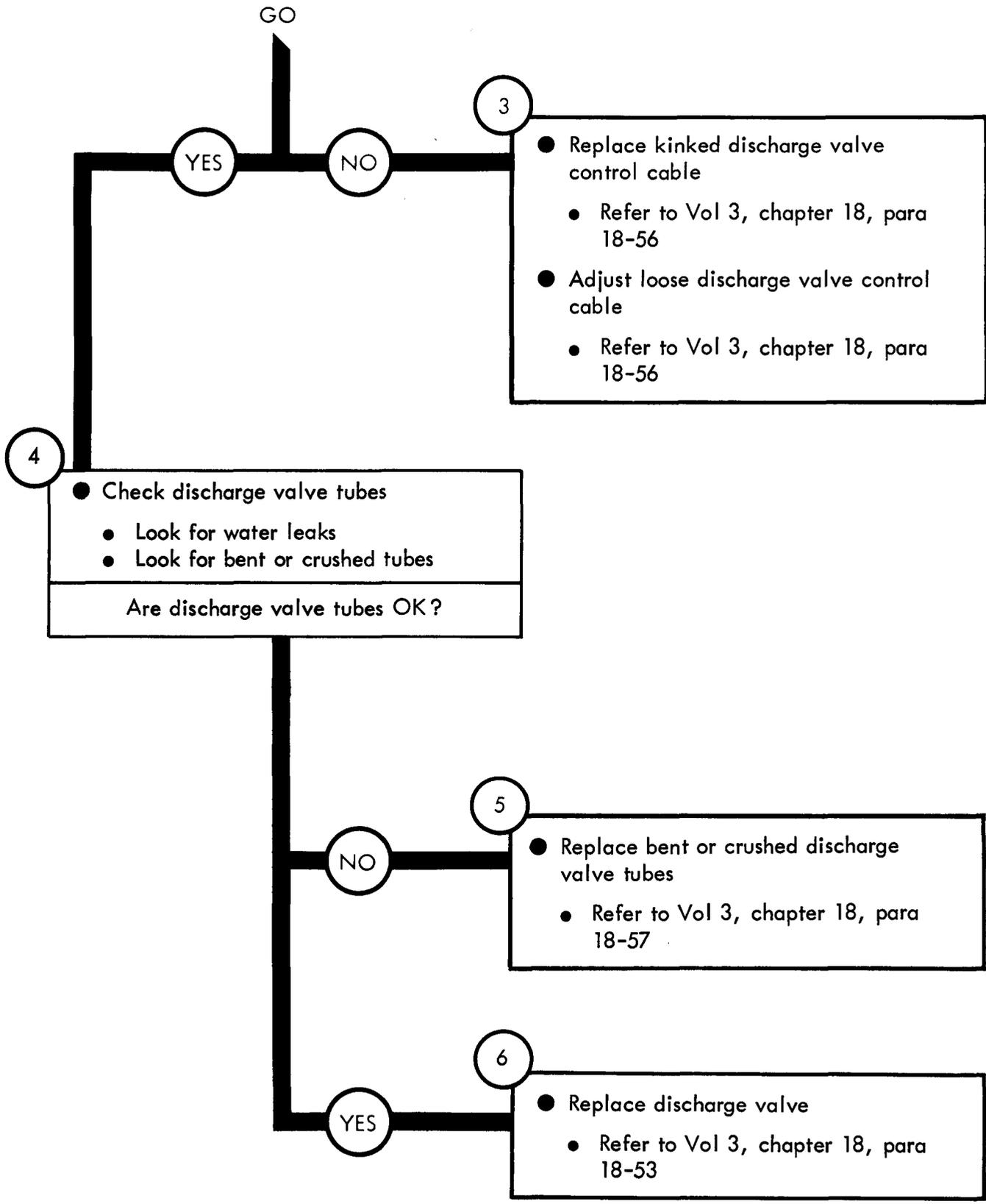

Figure 61-5 (Sheet 2 of 2)

TA 114950

Symptom

6

WATER PUMPS FROM TANK SELECTED SLOWER THAN NORMAL

1

- Stop pumping operations
 - Close pump delivery line valve
 - Push discharge valve control lever to front of truck
 - Turn off engine. Refer to TM 9-2320-209-10

2

- Check discharge valve control cables
 - Look for a kinked cable. See figure 63-1
 - Shake cable at discharge valve to feel if it is loose

Is discharge valve control cable OK?

GO

Figure 61-6 (Sheet 1 of 2)

TA 114951

61-15

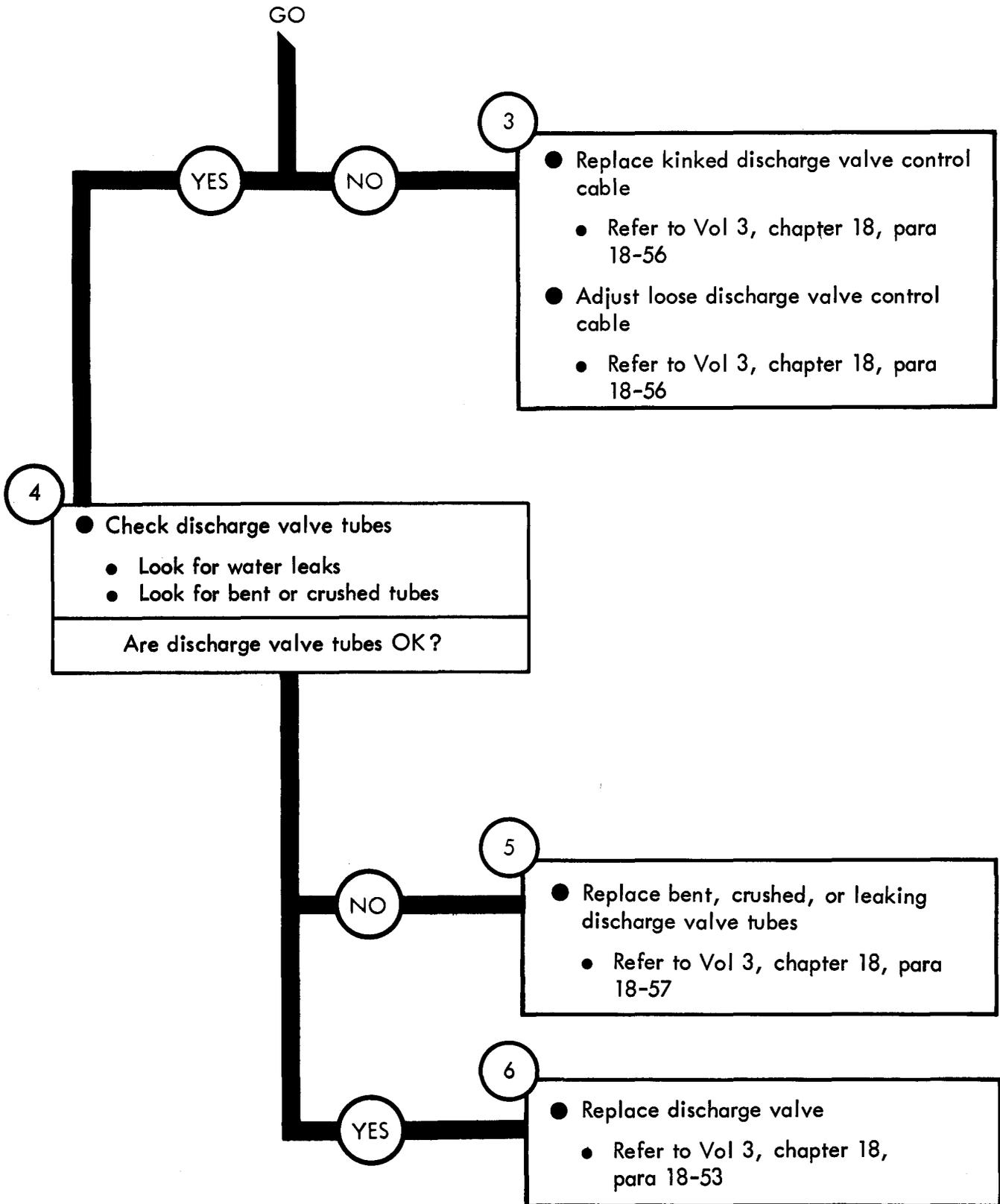

TA 114952

Figure 61-6 (Sheet 2 of 2)

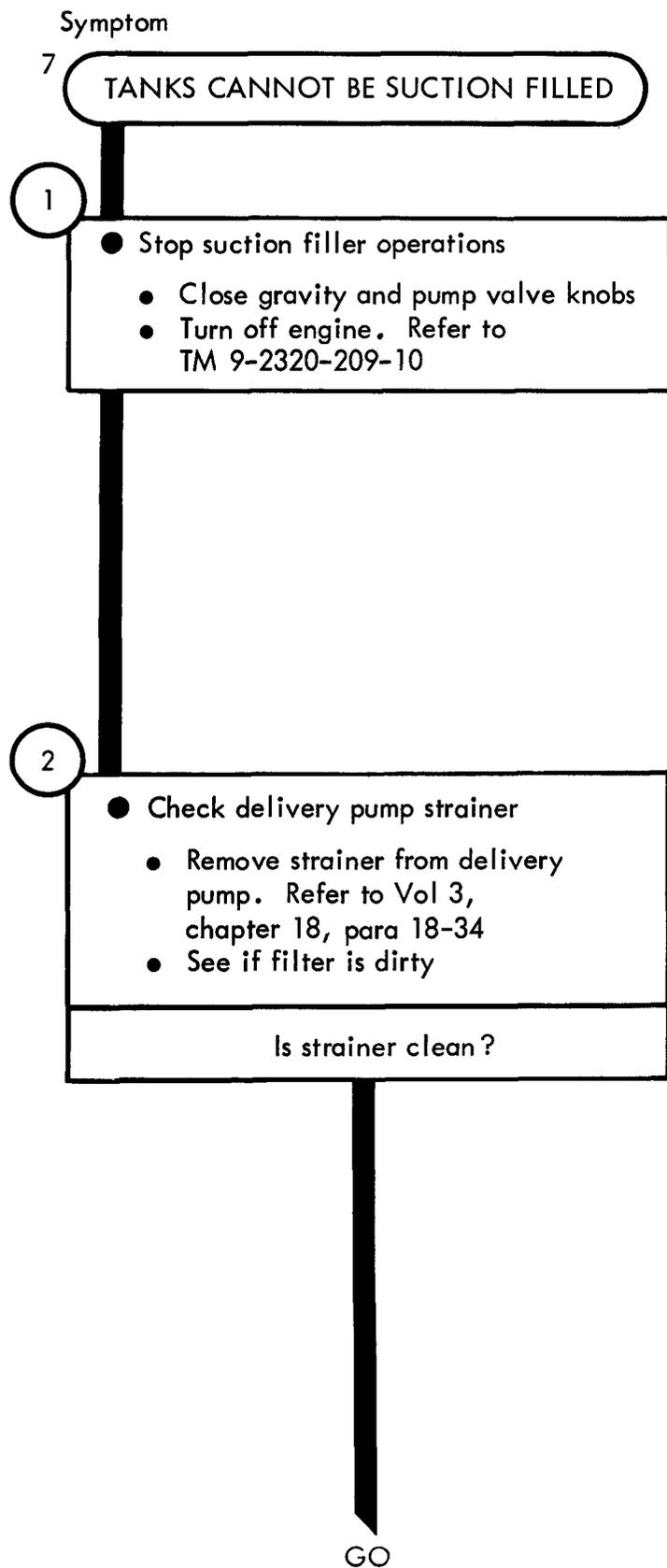

Figure 61-7 (Sheet 1 of 2)

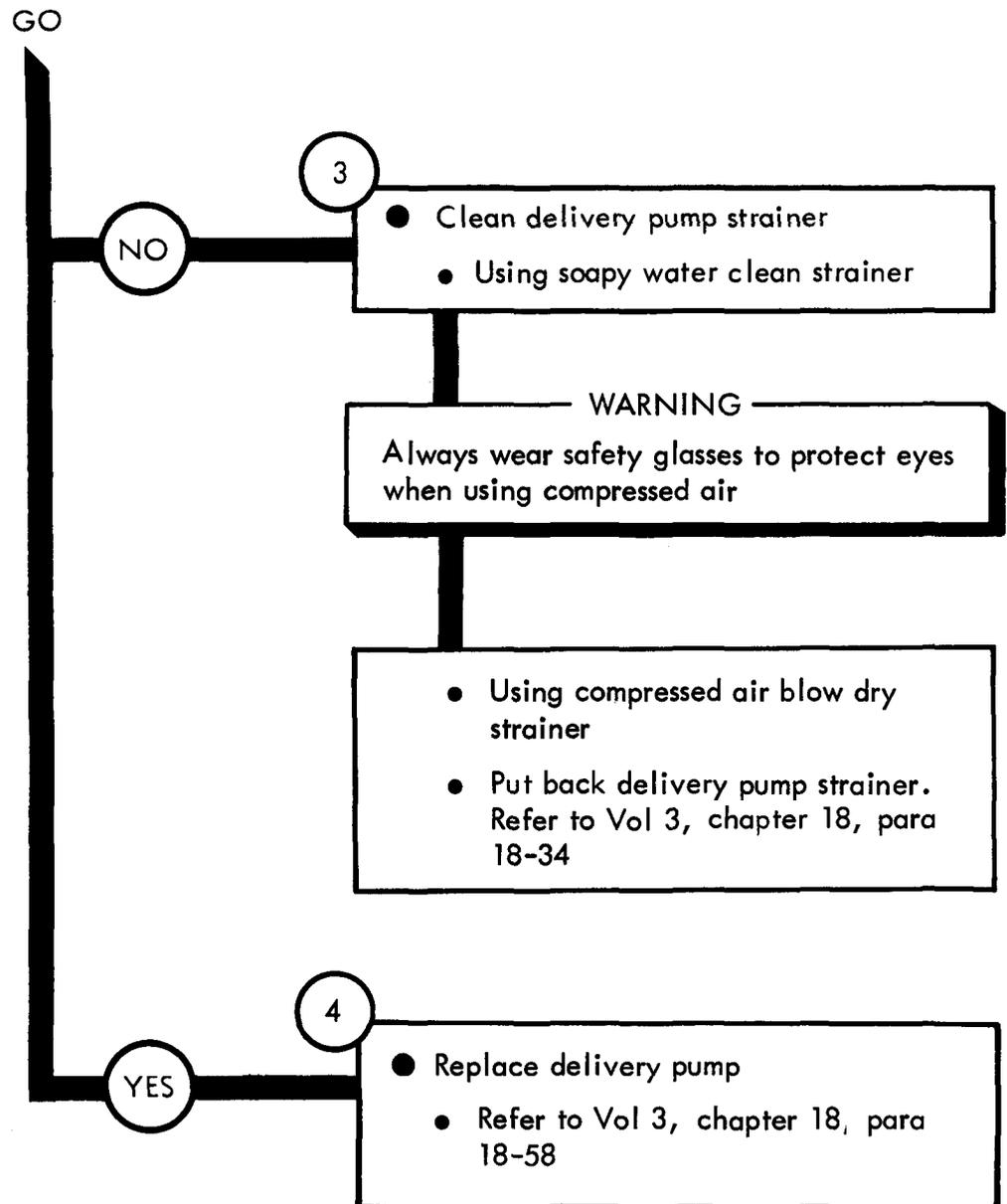

Figure 61-7 (Sheet 2 of 2)

TA 114954

CHAPTER 62

WATER TANK BODY TROUBLESHOOTING SUMMARY

62-1. GENERAL. This chapter gives a summary of troubleshooting procedures given in chapter 61 for the water tank body.

62-2. PROCEDURES. The summary in this chapter covers all fault symptoms found in the detailed troubleshooting procedures. Chapter 7 outlines a sample troubleshooting procedure. The summary procedures are based on the "what-to-do" portions of the detailed procedures and do not include the "how-to-do-it" instructions. Warnings, cautions, and notes are given where needed.

WATER TANK BODY TROUBLESHOOTING SUMMARY

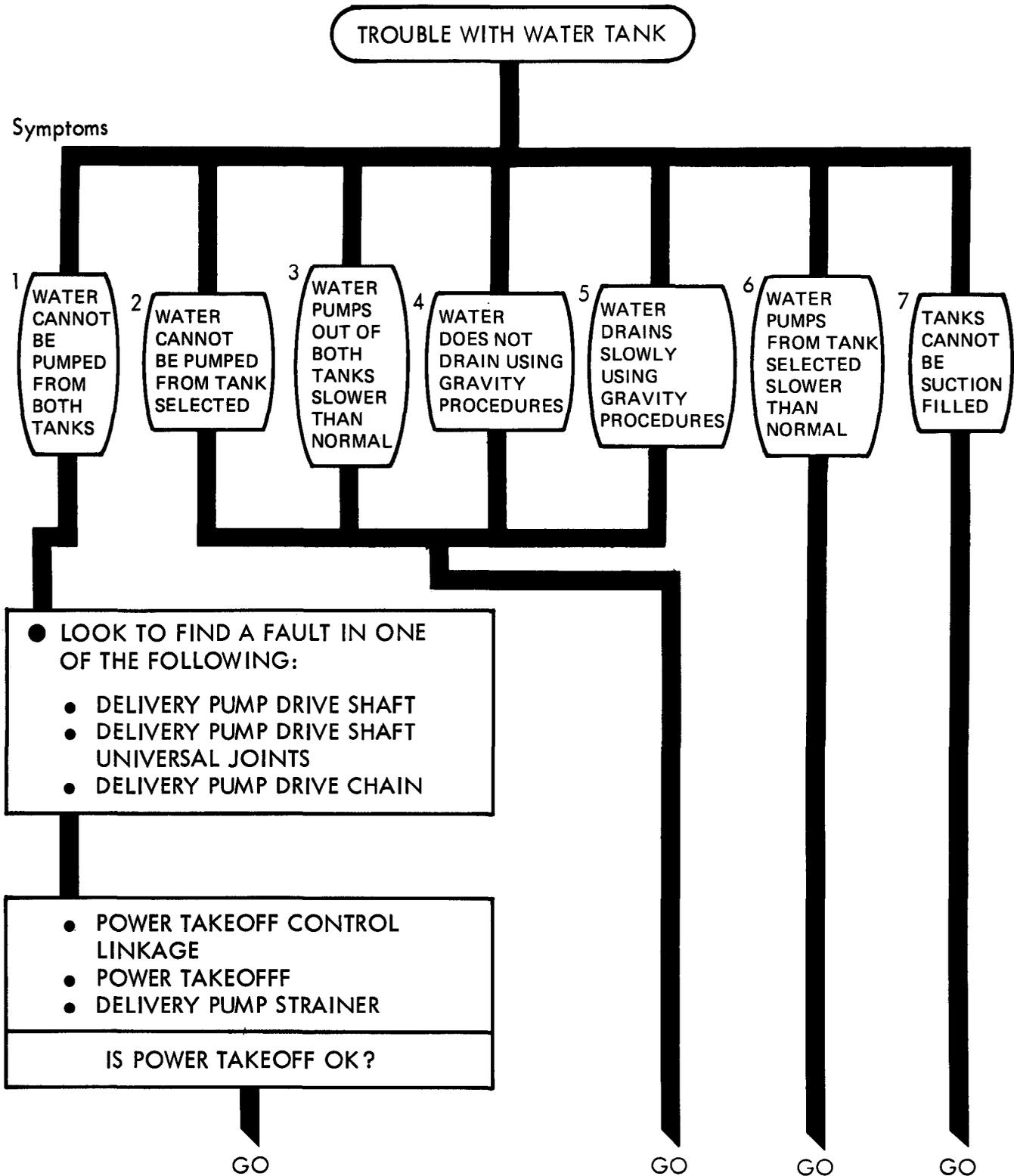
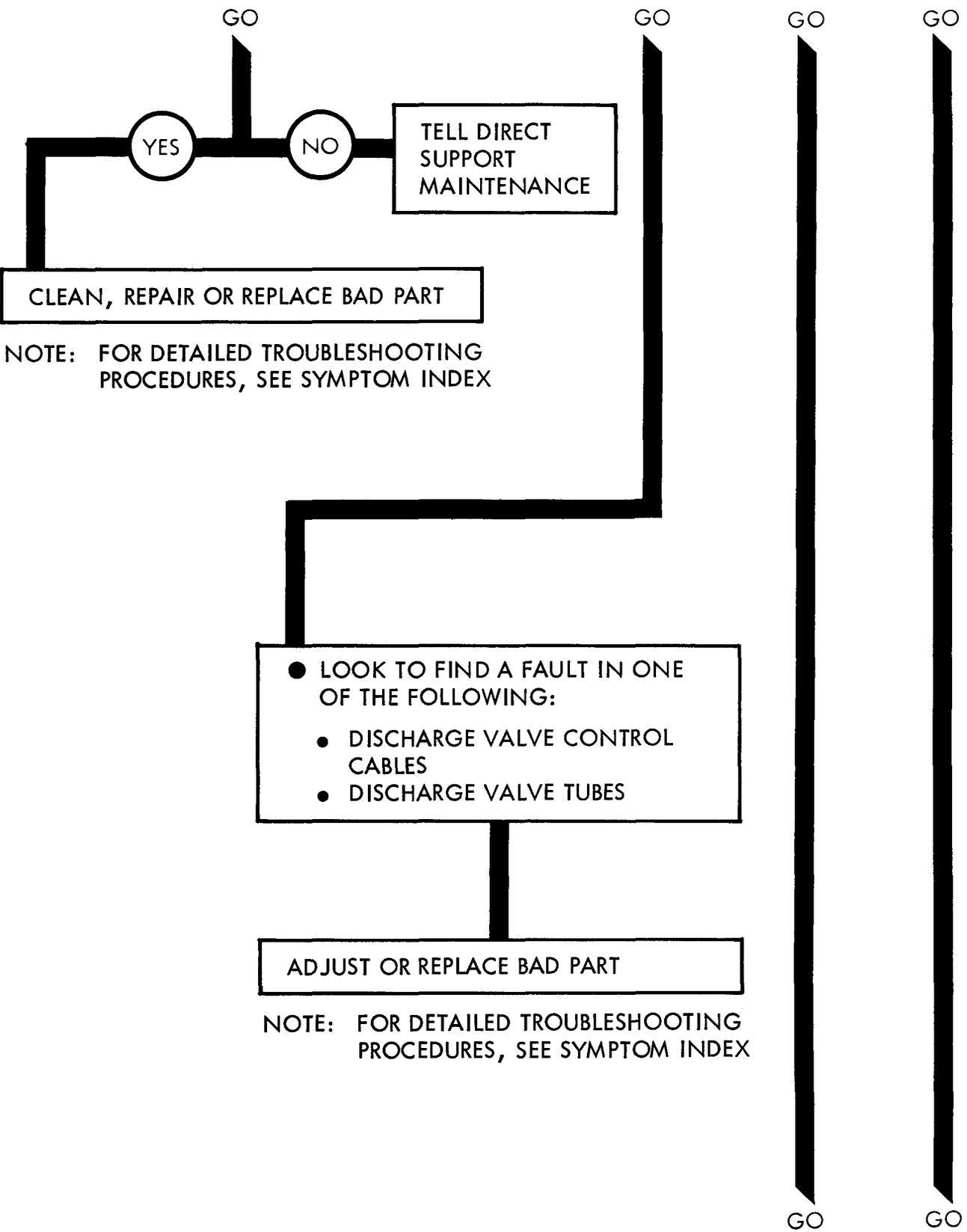

Figure 62-1 (Sheet 1 of 3)



NOTE: FOR DETAILED TROUBLESHOOTING PROCEDURES, SEE SYMPTOM INDEX

NOTE: FOR DETAILED TROUBLESHOOTING PROCEDURES, SEE SYMPTOM INDEX

Figure 62-1 (Sheet 2 of 3)

TA 114956

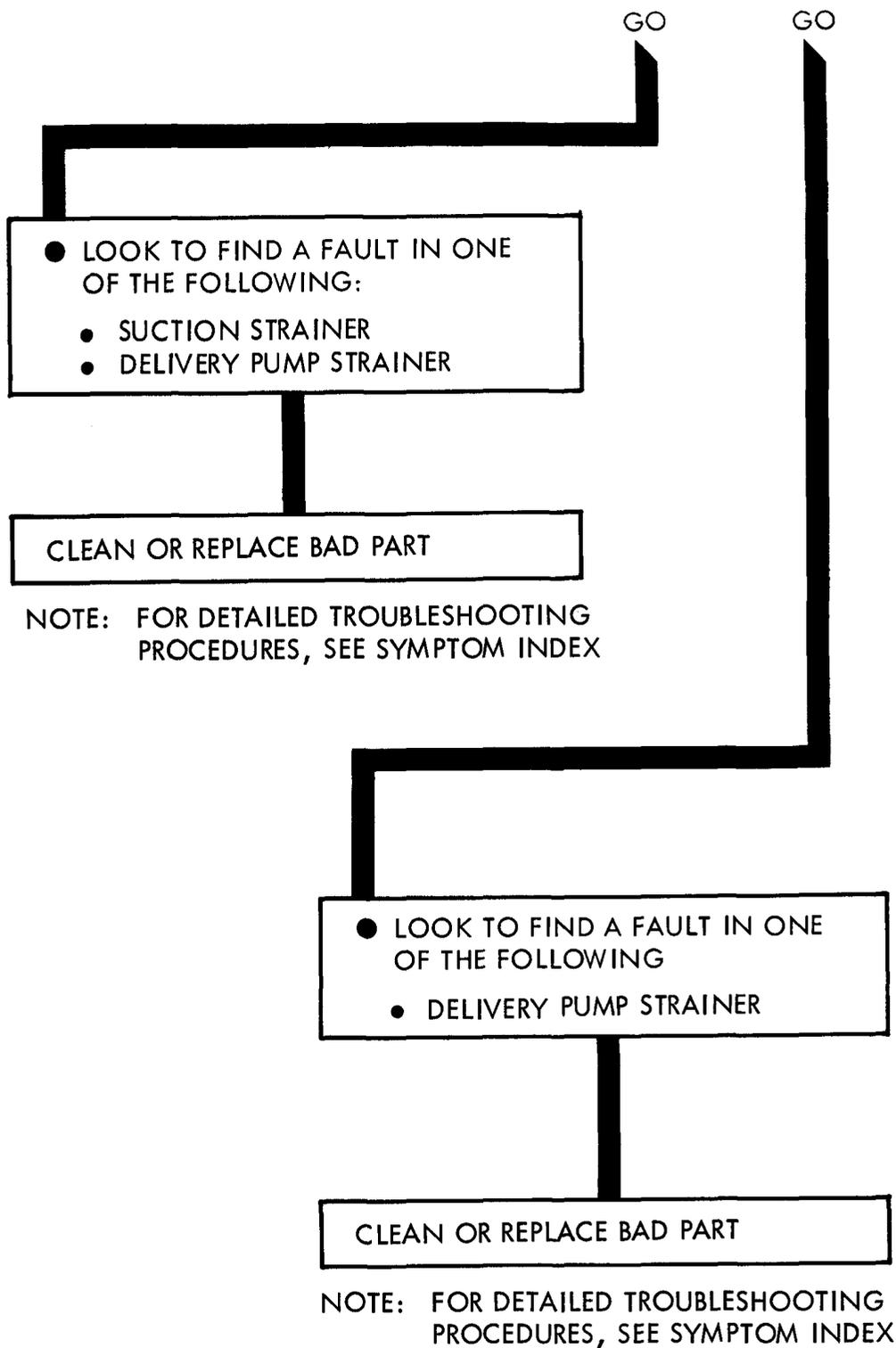

Figure 62-1 (Sheet 3 of 3)

TA 114957

CHAPTER 63

WATER TANK BODY SUPPORT DIAGRAMS

63-1. GENERAL. This chapter gives the diagrams you need when doing troubleshooting procedures in chapter 61. Table 3-1 is a complete listing of all support diagrams used in this manual.

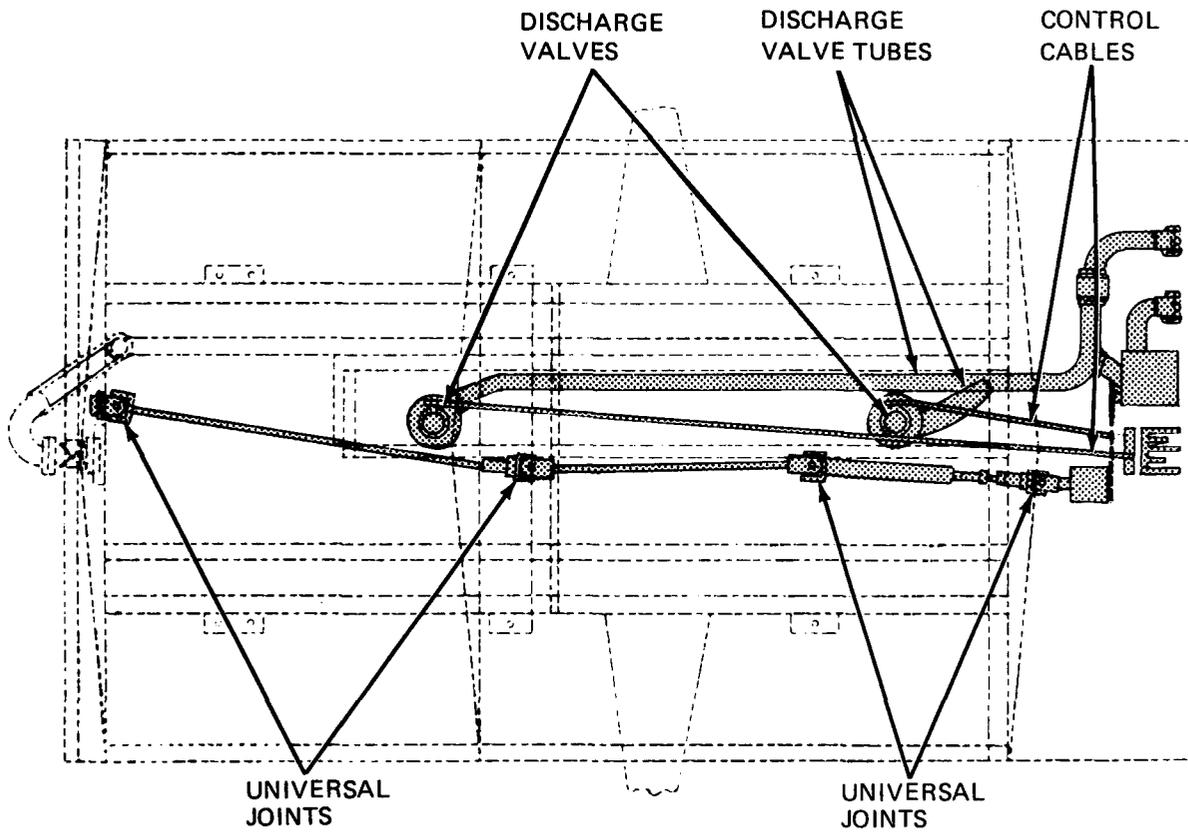

TA 114958

Figure 63-1. Water Tank Body Support Diagram

CHAPTER 64

WATER TANK BODY CHECKOUT PROCEDURES

64-1. GENERAL. This chapter gives procedures for checking out the system after troubleshooting and repair have been done. Procedures are set up in flow chart form showing the checkout steps in order and referring to the fault symptom index when the system does not checkout.

WATER TANK BODY CHECKOUT

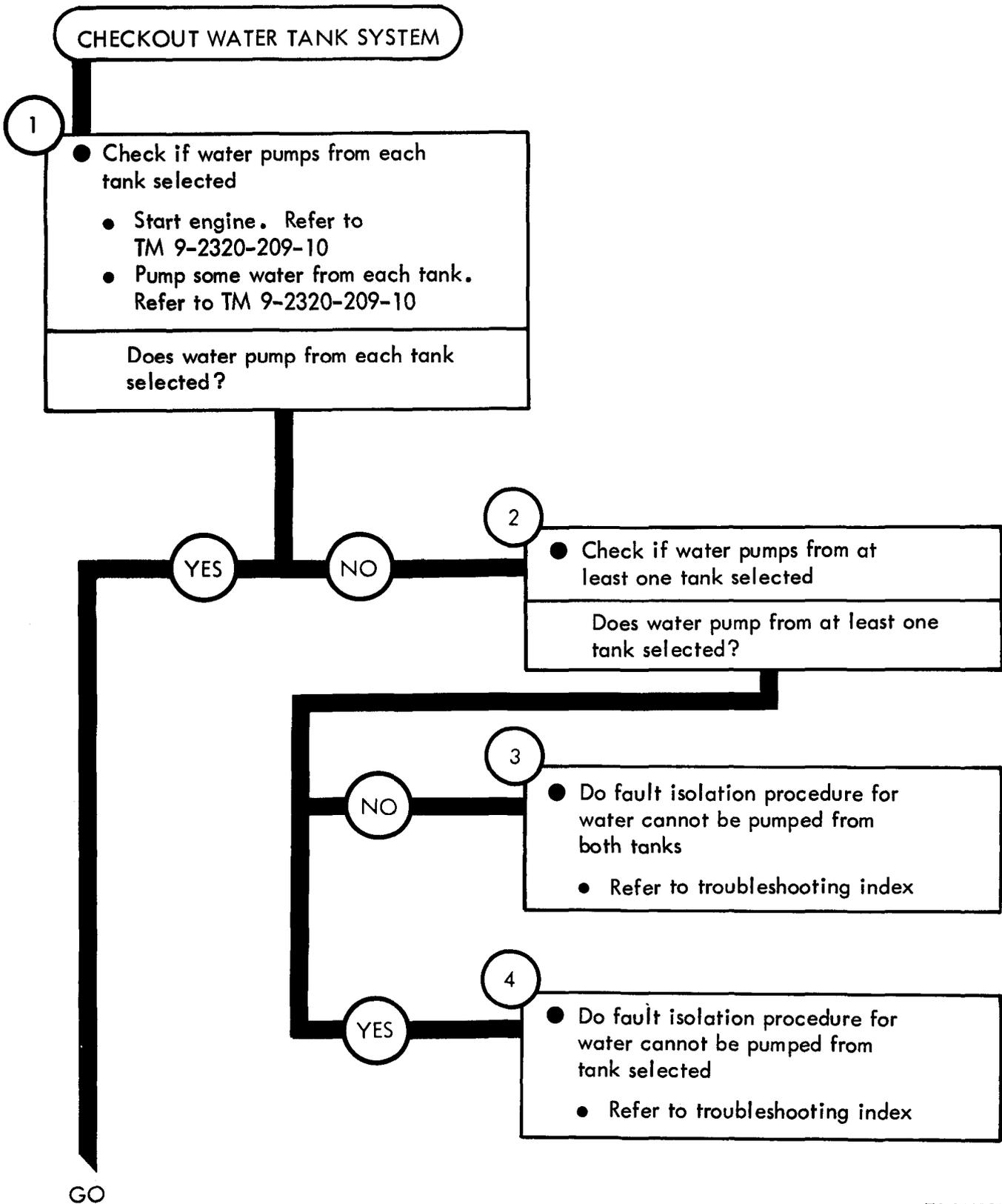
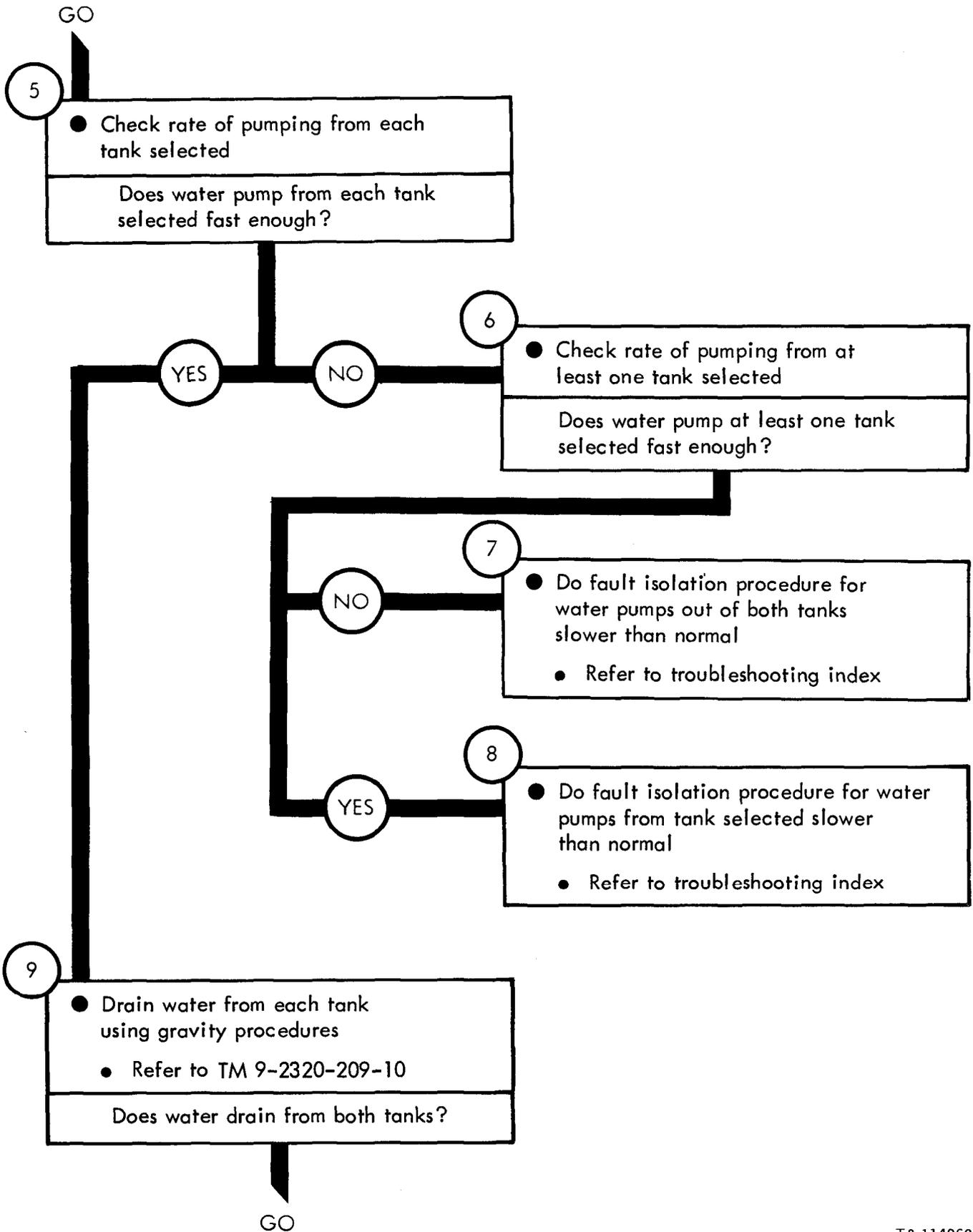

Figure 64-1 (Sheet 1 of 4)

TA 114959



TA 114960

Figure 64-1 (Sheet 2 of 4)

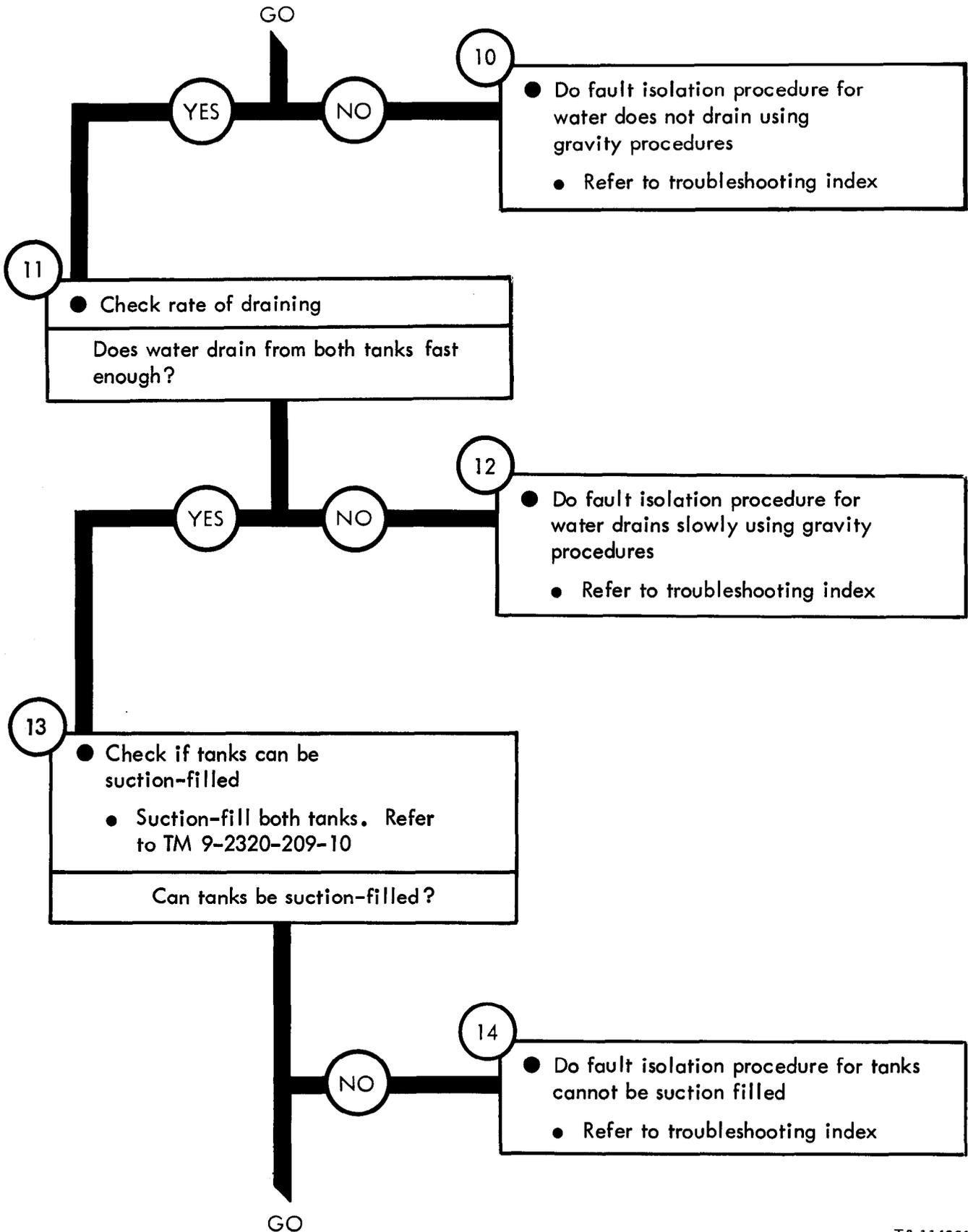

Figure 64-1 (Sheet 3 of 4)

TA 114961

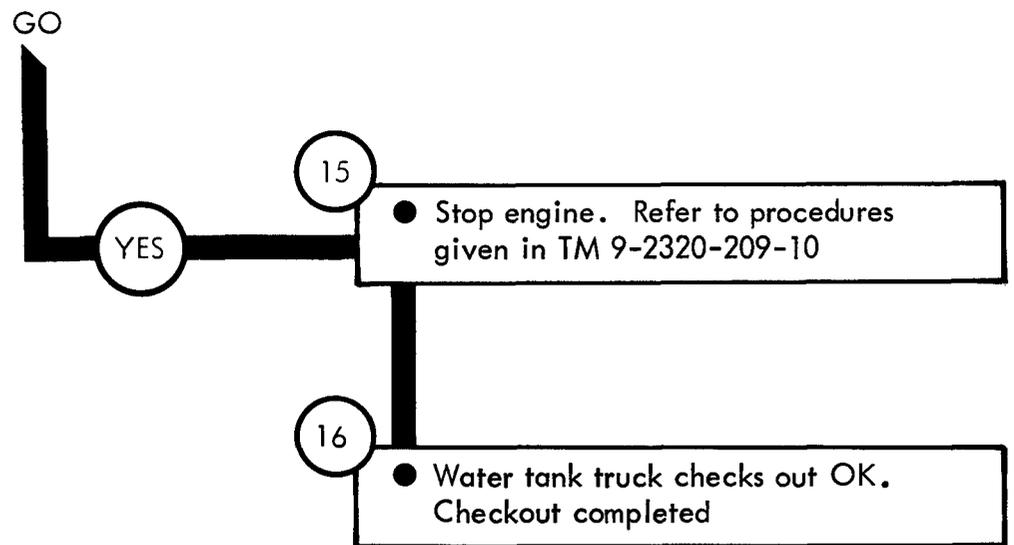

Figure 64-1 (Sheet 4 of 4)

CHAPTER 65

FUEL TANK BODY (TRUCK M49A1C) TROUBLESHOOTING

65-1. EQUIPMENT ITEMS COVERED. This chapter gives equipment troubleshooting procedures for the fuel tank body M49A1C, for which there are authorized corrective maintenance tasks at the organizational maintenance level.

65-2. EQUIPMENT ITEMS NOT COVERED. All equipment items for which corrective maintenance is authorized at the organizational maintenance level are covered in this chapter.

FUEL TANK BODY M49A1C TROUBLESHOOTING

Symptom

1 FUEL DOES NOT PUMP OUT OF TANKS

1

- Make truck ready for work on pumping system
- Park truck. Refer to TM 9-2320-209-10

WARNING

Diesel fuel is very flammable. Care must be used when choosing a place to work on fuel tanker. Keep truck about 50 feet away from an area where open flame, sparks, or smoking can cause a fire. Keep a fire extinguisher close by

2

- Check fusible link
 - See if link has come off mounting pin
 - Look for a broken link

Is fusible link OK?

GO

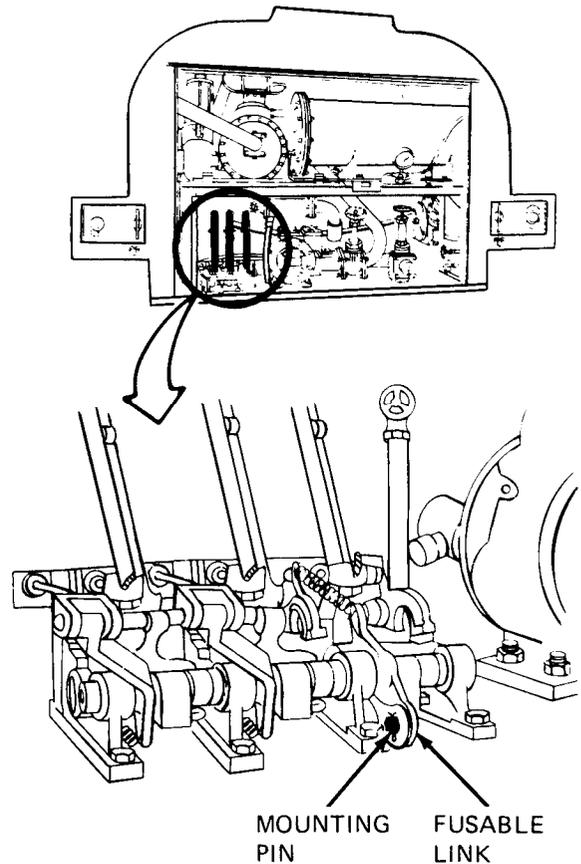

Figure 65-1 (Sheet 1 of 5)

TA 114963

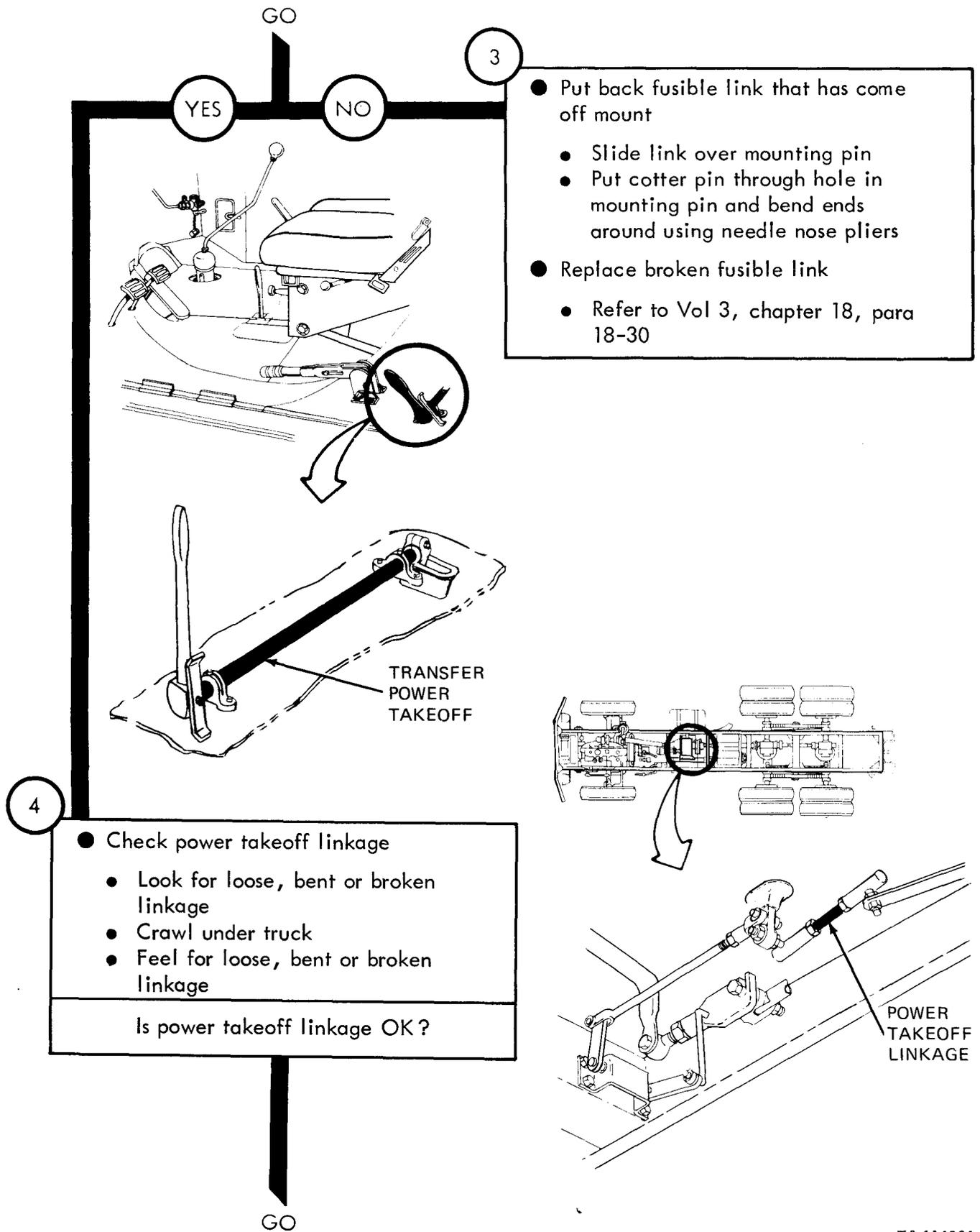

Figure 65-1 (Sheet 2 of 5)

TA 114964

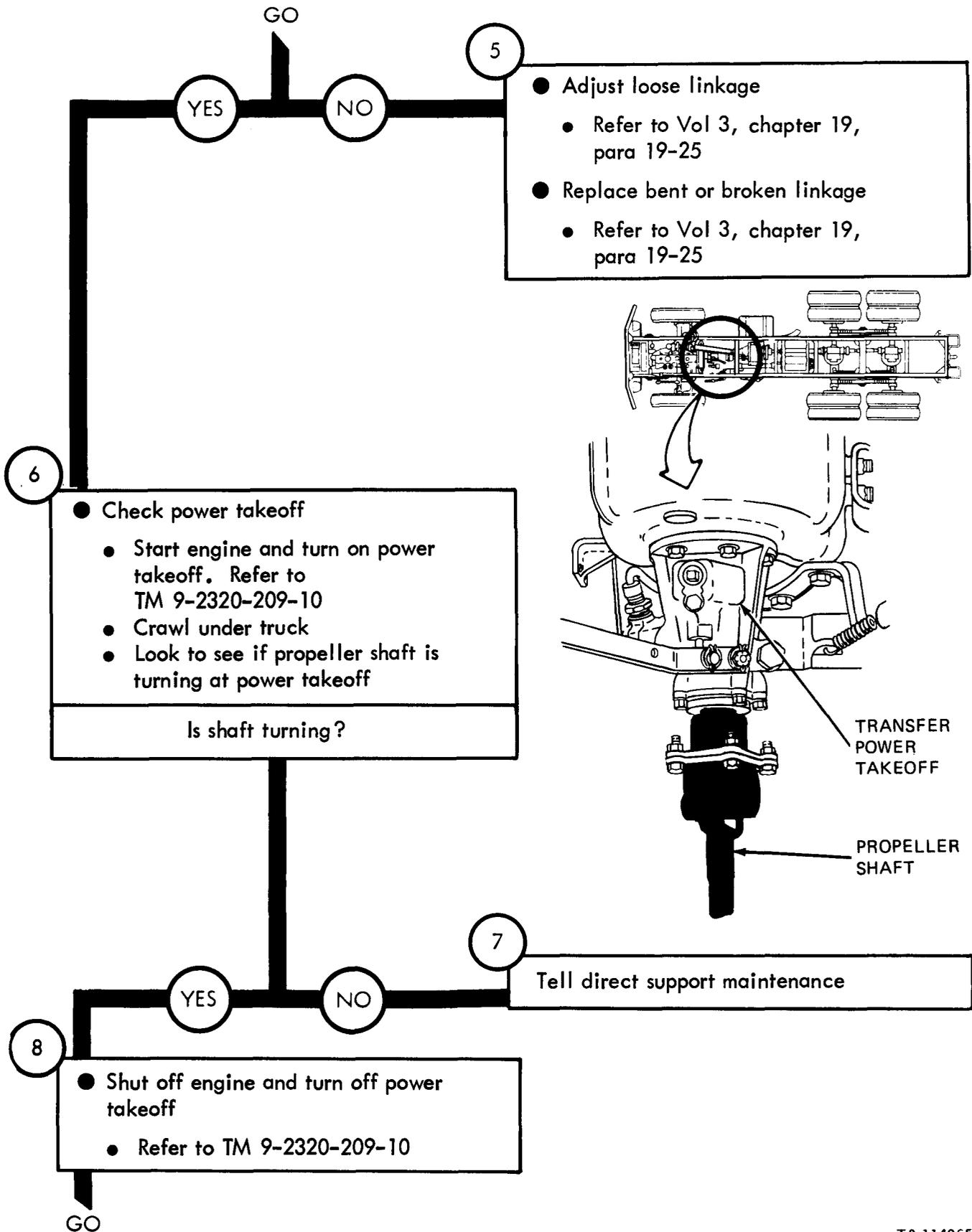

Figure 65-1 (Sheet 3 of 5)

TA 114965

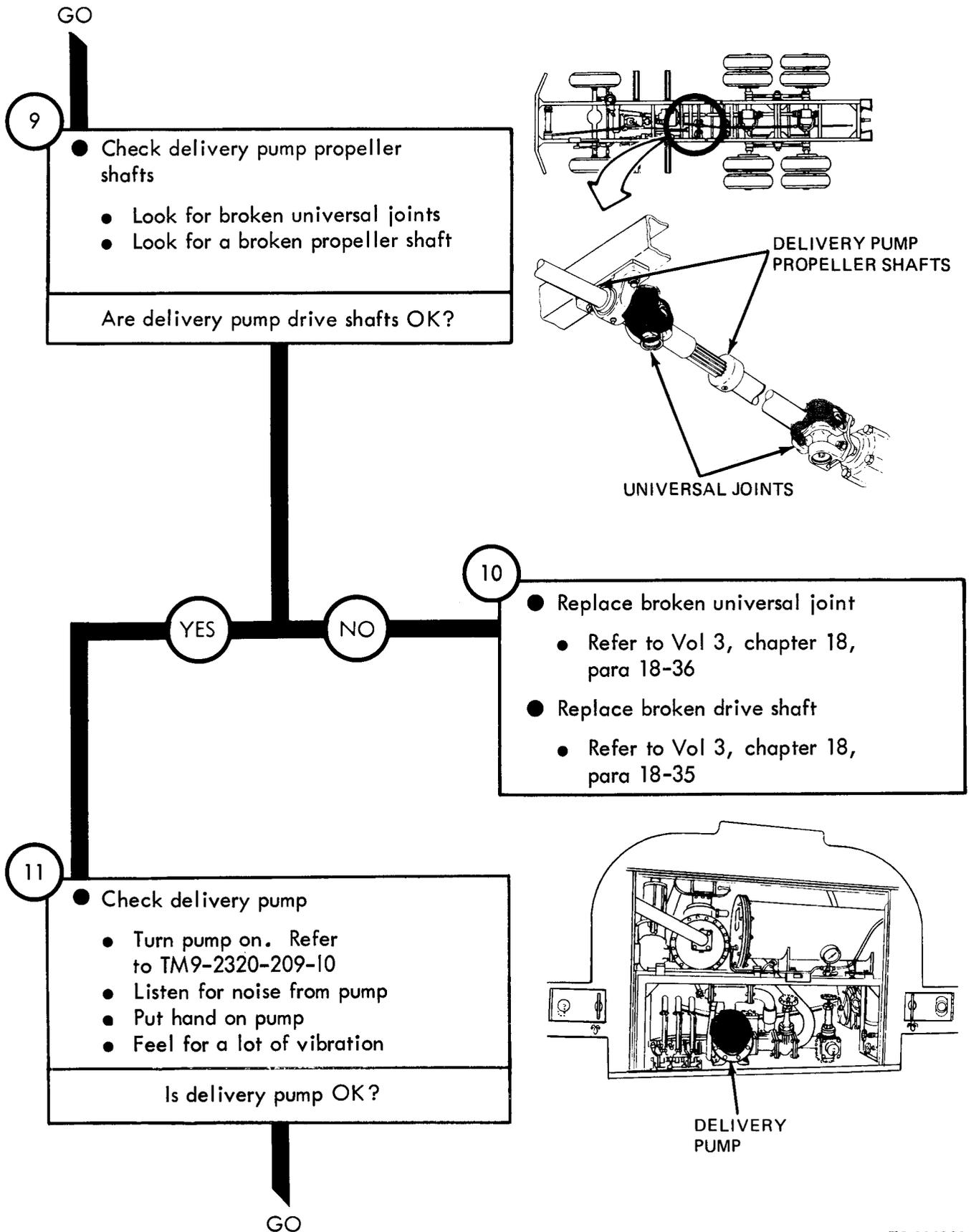

Figure 65-1 (Sheet 4 of 5)

Symptom

2

FUEL PUMPS OUT SLOWLY

1

- Stop pumping operations
 - Close delivery pump gate valve knob
 - Close dump valve knob
 - Close discharge valve control lever
 - Turn off engine
 - Chock wheels

WARNING

Diesel fuel is very flammable. Do not allow smoking or an open flame within 50 feet of truck while working on fuel tanker

2

- Check segregator filter
 - Refer to TM 9-2320-209-10

Note: If the pressure reading shows that the filter is OK, do not shut down from the segregator filter check. Go to step 4

Is delivery pump pressure OK?

GO

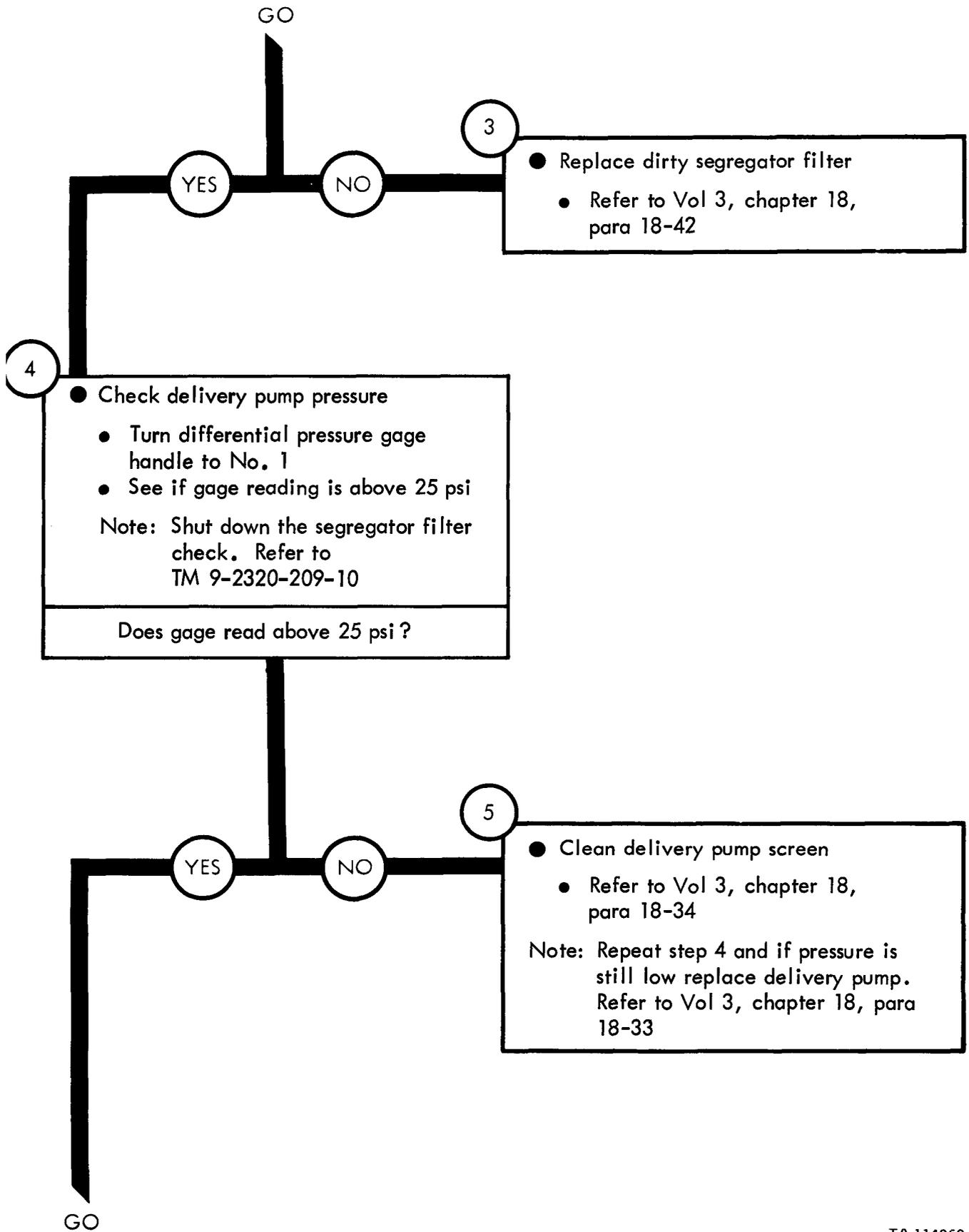

Figure 65-2 (Sheet 2 of 3)

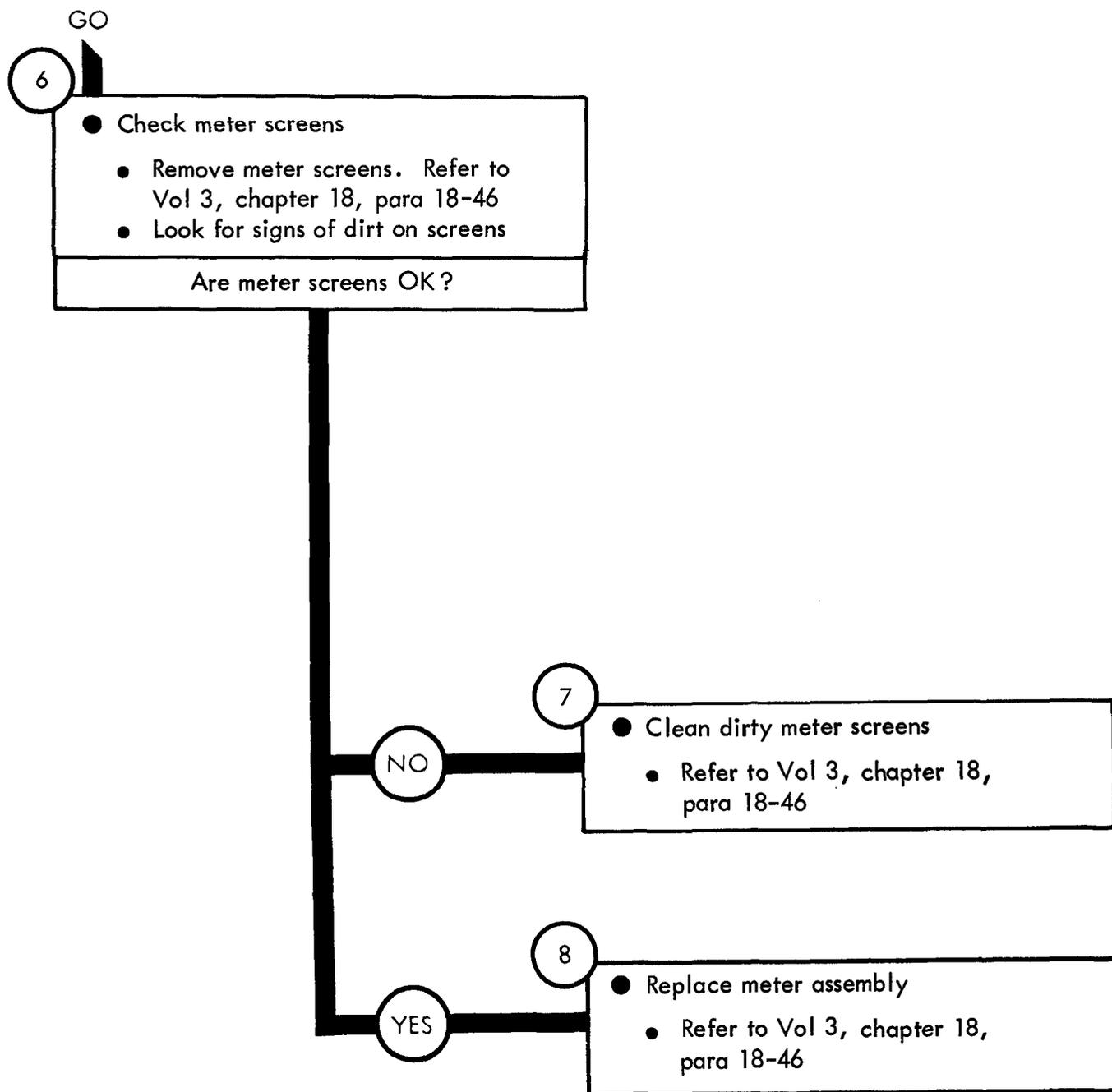

Figure 65-2 (Sheet 3 of 3)

Symptom

3 FUEL DOES NOT PUMP FROM TANK SELECTED

- 1
- Stop pumping operations
 - Close delivery pump gate valve knob
 - Close dump valve knob
 - Close discharge valve control lever
 - Turn off engine
 - Chock wheels

WARNING

Diesel fuel is very flammable. Do not allow smoking, or an open flame within 50 feet of truck while working on fuel tanker

- 2
- Check discharge valve cable
 - Look for a broken or kinked cable. See figure 67-1
 - See if cable has come off of mount
- Is discharge valve control cable OK?

GO

Figure 65-3 (Sheet 1 of 3)

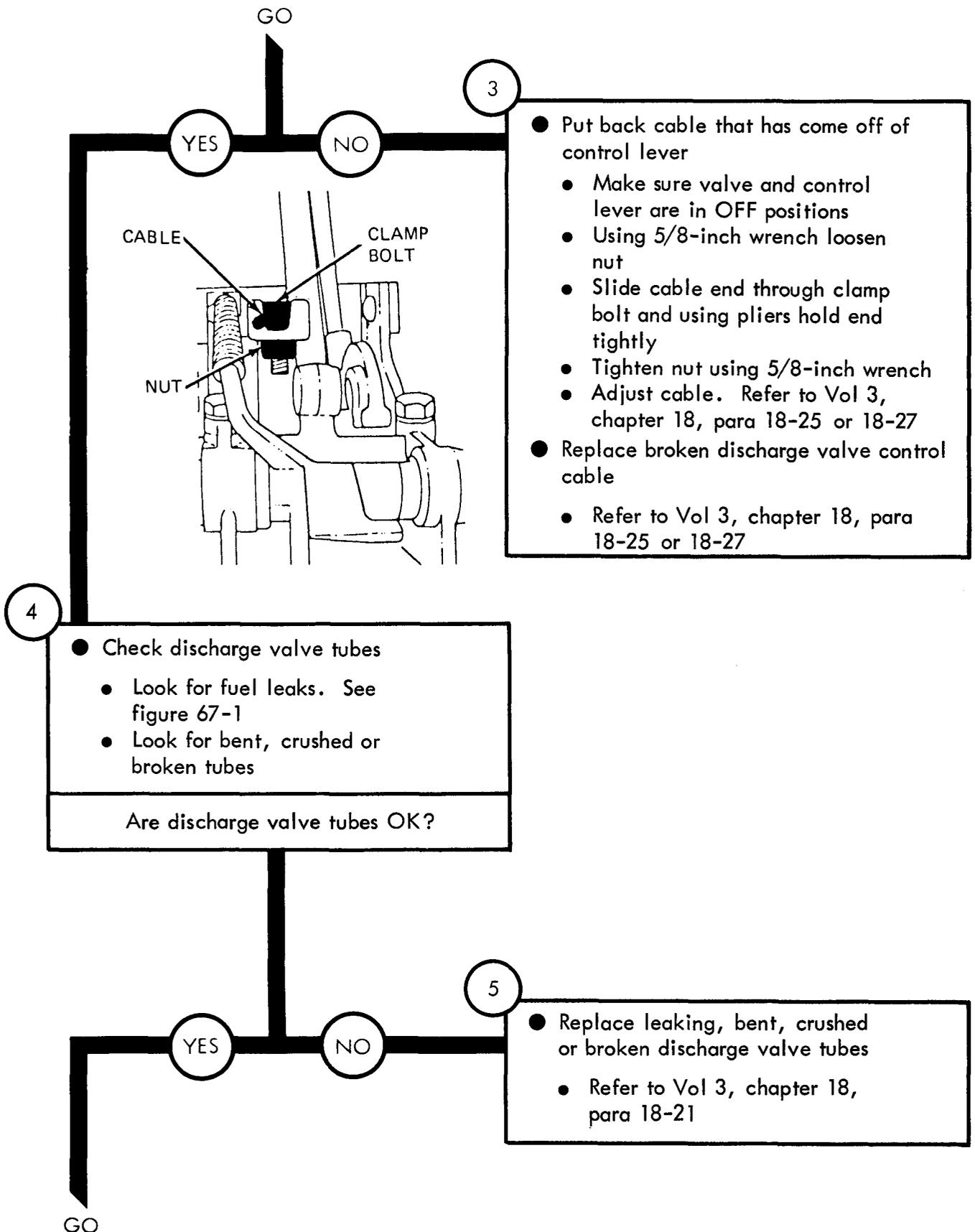

Figure 65-3 (Sheet 2 of 3)

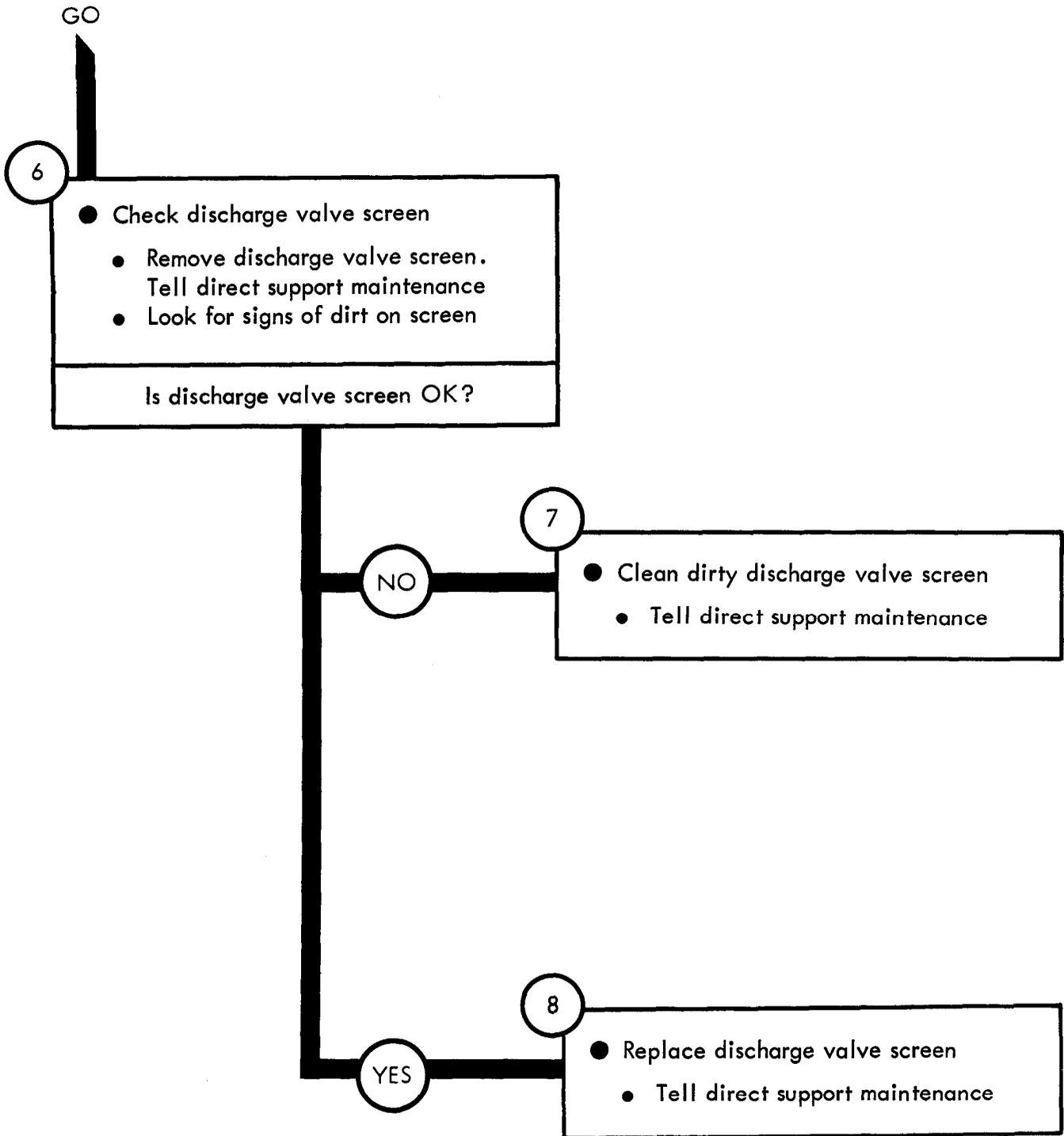

Figure 65-3 (Sheet 3 of 3)

TA 114973

Symptom

4 FUEL PUMPS FROM TANK SELECTED SLOWLY

1

- Stop pumping operations
 - Close delivery pump gate valve knob
 - Close dump valve knob
 - Close discharge valve control lever
 - Turn off engine
 - Chock wheels

— WARNING —

Diesel fuel is very flammable. Do not allow smoking, or an open flame within 50 feet of truck while working on fuel tanker

2

- Check discharge valve cable
 - Look for a kinked cable. See figure 67-1
 - Shake cable at discharge valve to feel if it is loose

Is discharge valve control cable OK?



GO

Figure 65-4 (Sheet 1 of 3)

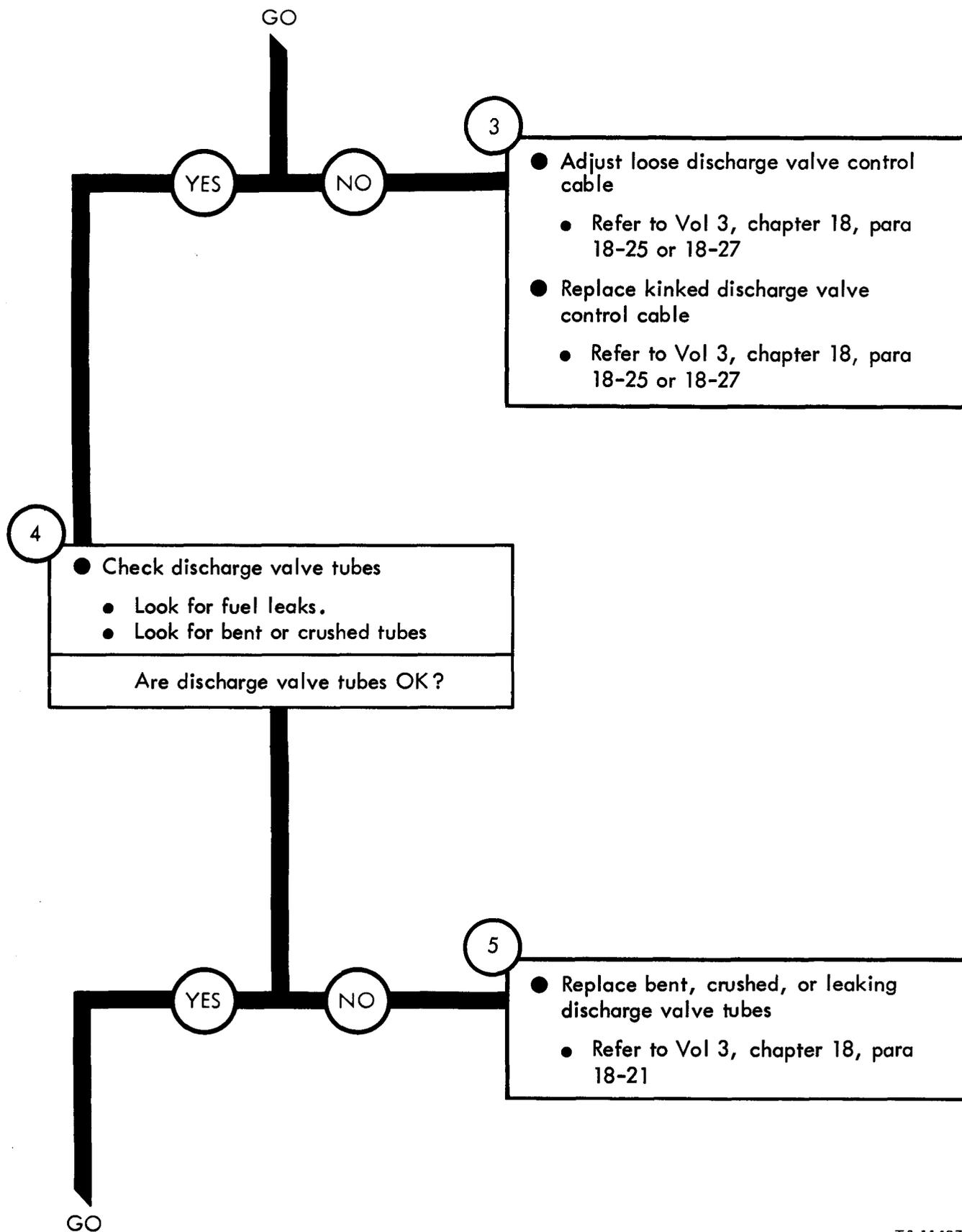

Figure 65-4 (Sheet 2 of 3)

TA 114975

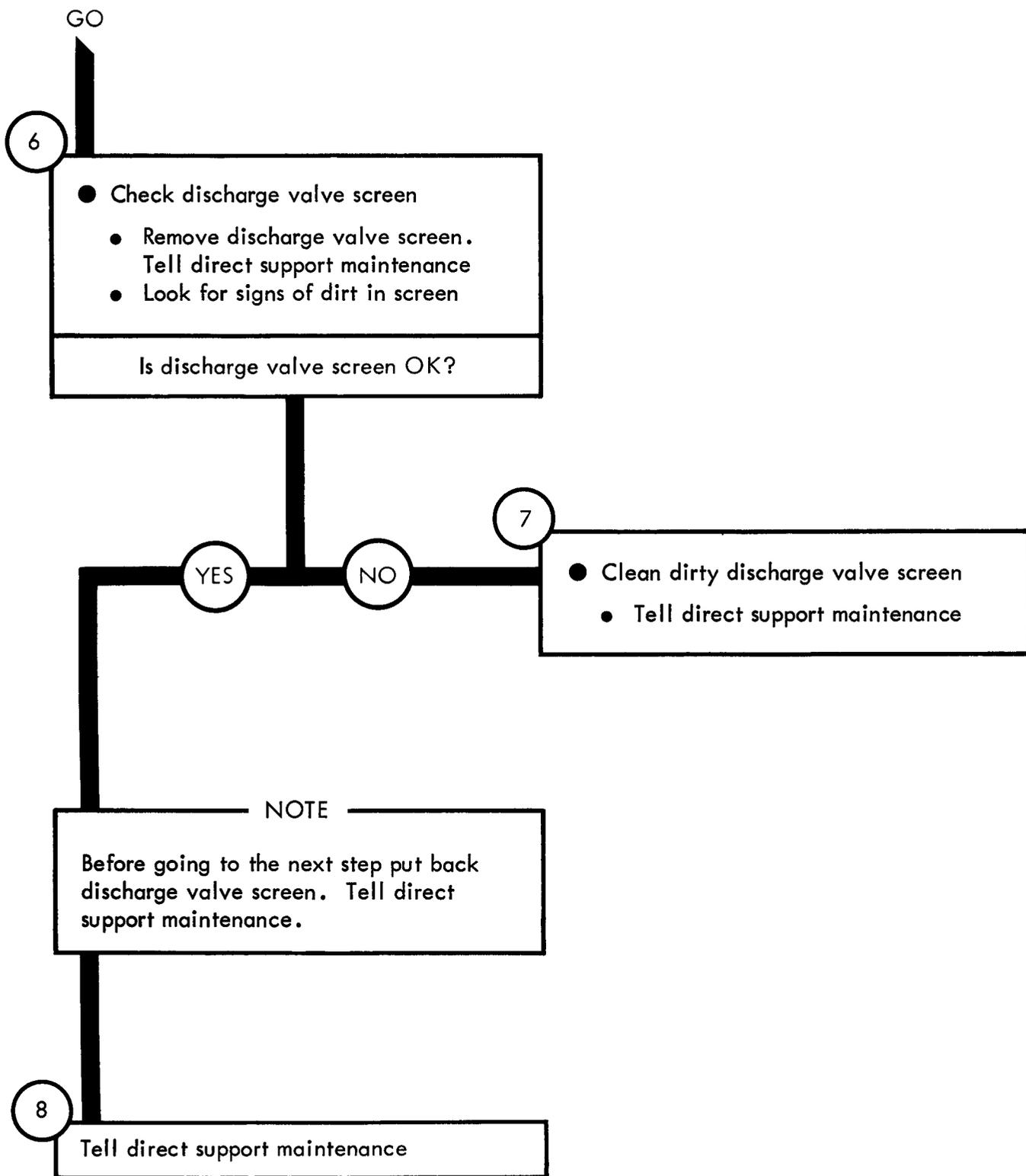

Figure 65-4 (Sheet 3 of 3)

Symptom

5 FUEL DOES NOT DRAIN FROM TANK SELECTED USING GRAVITY PROCEDURES

1

- Stop gravity discharge operations
 - Close discharge valve control levers. Refer to TM 9-2320-209-10
 - Close delivery line valve knob. Refer to TM 9-2320-209-10
 - Chock wheels

— WARNING —

Diesel fuel is very flammable. Do not allow smoking or an open flame within 50 feet of truck while working on fuel tanker

2

- Check discharge valve cable
 - Look for a broken or kinked cable. See figure 67-2
 - See if cable has come off of mounts

Is discharge valve control cable OK?



GO

Figure 65-5 (Sheet 1 of 3)

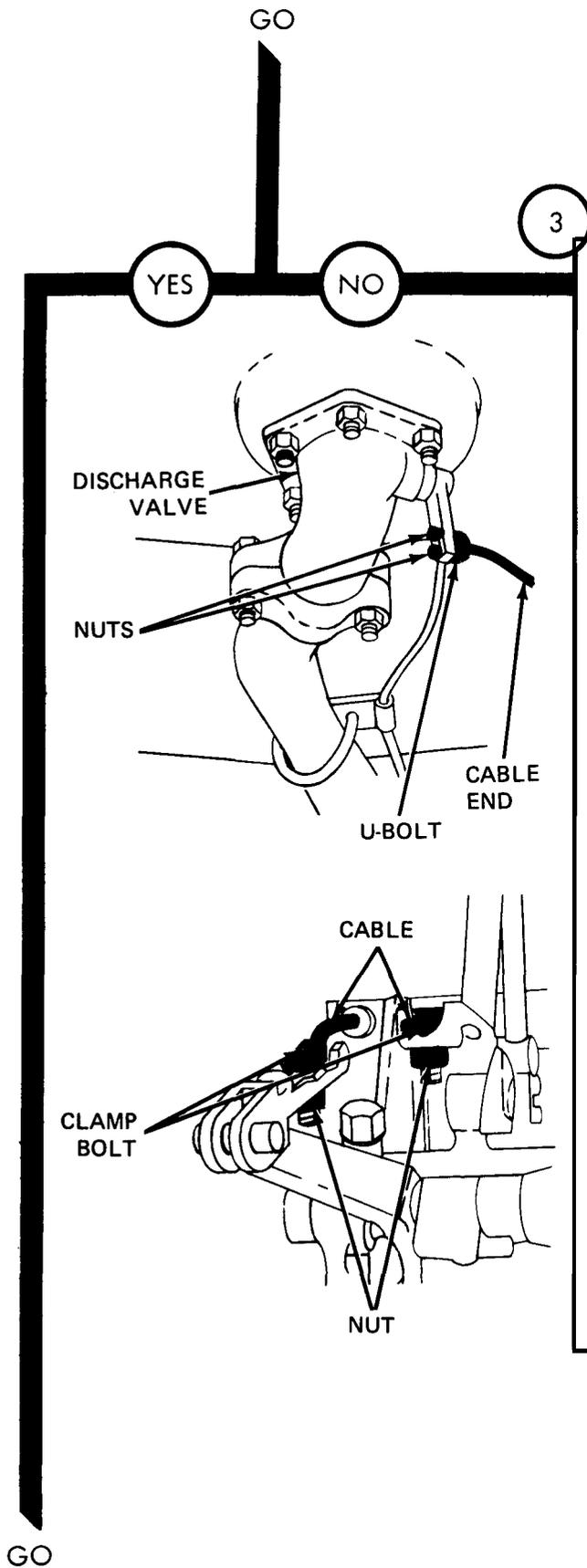

- Put back cable that has come off of discharge valve
 - Make sure valve and control levers are in OFF positions. Refer to TM 9-2320-209-10
 - Using 1/2-inch wrench loosen two nuts on U-bolt
 - Slide cable end through U-bolt and using pliers hold end tightly
 - Tighten two nuts on U-bolt using 1/2-inch wrench
 - Adjust cables. Refer to Vol 3, chapter 18, para 18-25 or 18-27
- Put back cable that has come off control lever
 - Make sure valve and control lever are in OFF positions. Refer to TM 9-2320-209-10
 - Using 5/8-inch wrench loosen nut
 - Slide cable end through clamp bolt and using pliers hold end tightly
 - Tighten nut using 5/8-inch wrench
 - Adjust cables. Refer to Vol 3, chapter 18, para 18-25 or 18-27
- Z Replace broken discharge valve control cable
 - Refer to Vol 3, chapter 18, para 18-25 or 18-27

Figure 65-5 (Sheet 2 of 3)

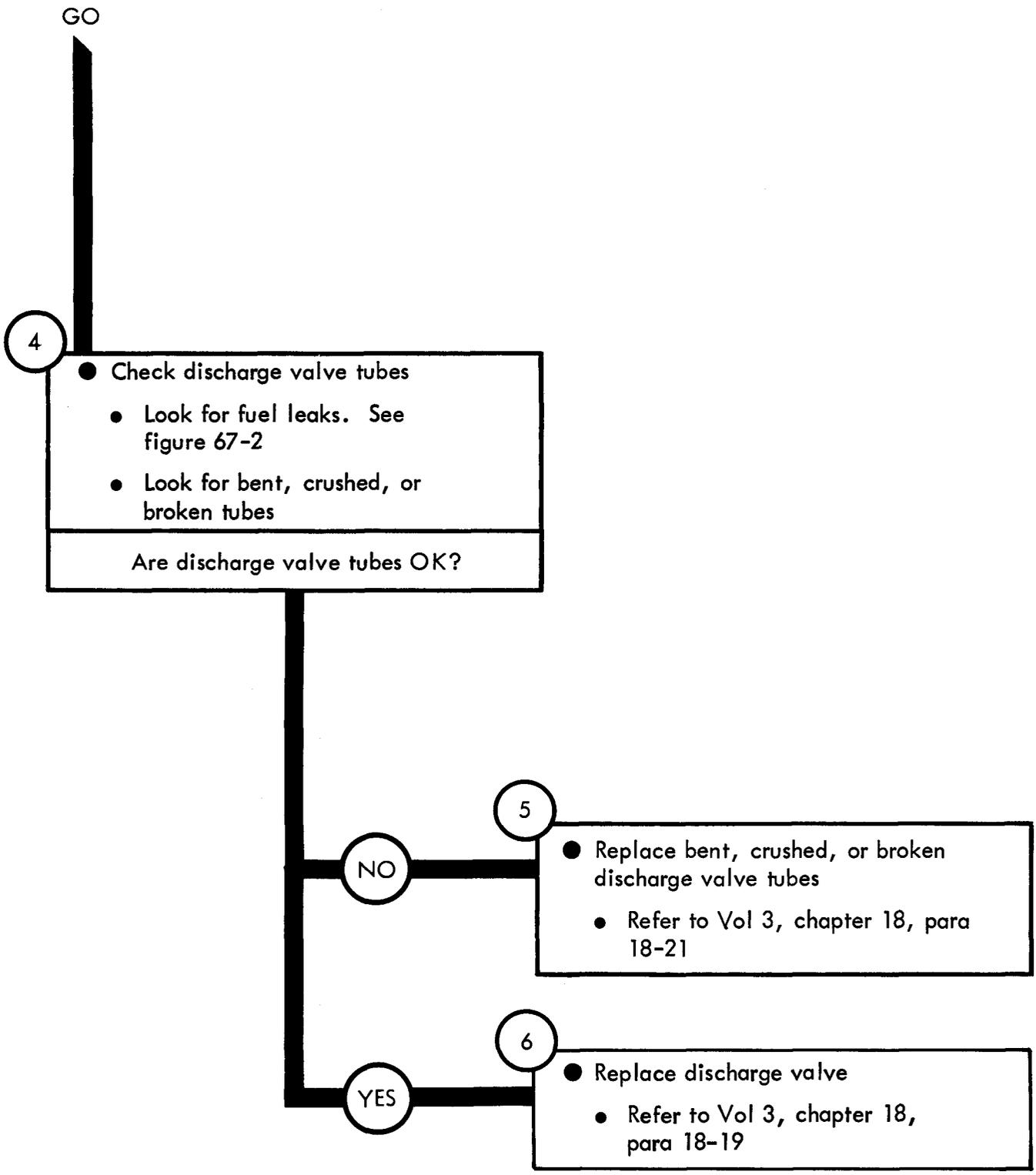

Figure 65-5 (Sheet 3 of 3)

Symptom

6

FUEL DRAINS FROM TANK SELECTED SLOWLY USING GRAVITY PROCEDURES

1

- Stop gravity discharge operations
 - Close discharge valve control levers. Refer to TM 9-2320-209-10
 - Close delivery line valve knob. Refer to TM 9-2320-209-10
 - Chock wheels

WARNING

Diesel fuel is very flammable. Do not allow smoking, or an open flame within 50 feet of truck while working on fuel tanker

2

- Check discharge valve control cable
 - Look for a kinked cable. See figure 67-2
 - Shake cable at discharge valve to feel if it is loose

Is discharge valve control cable OK?

GO

Figure 65-6 (Sheet 1 of 3)

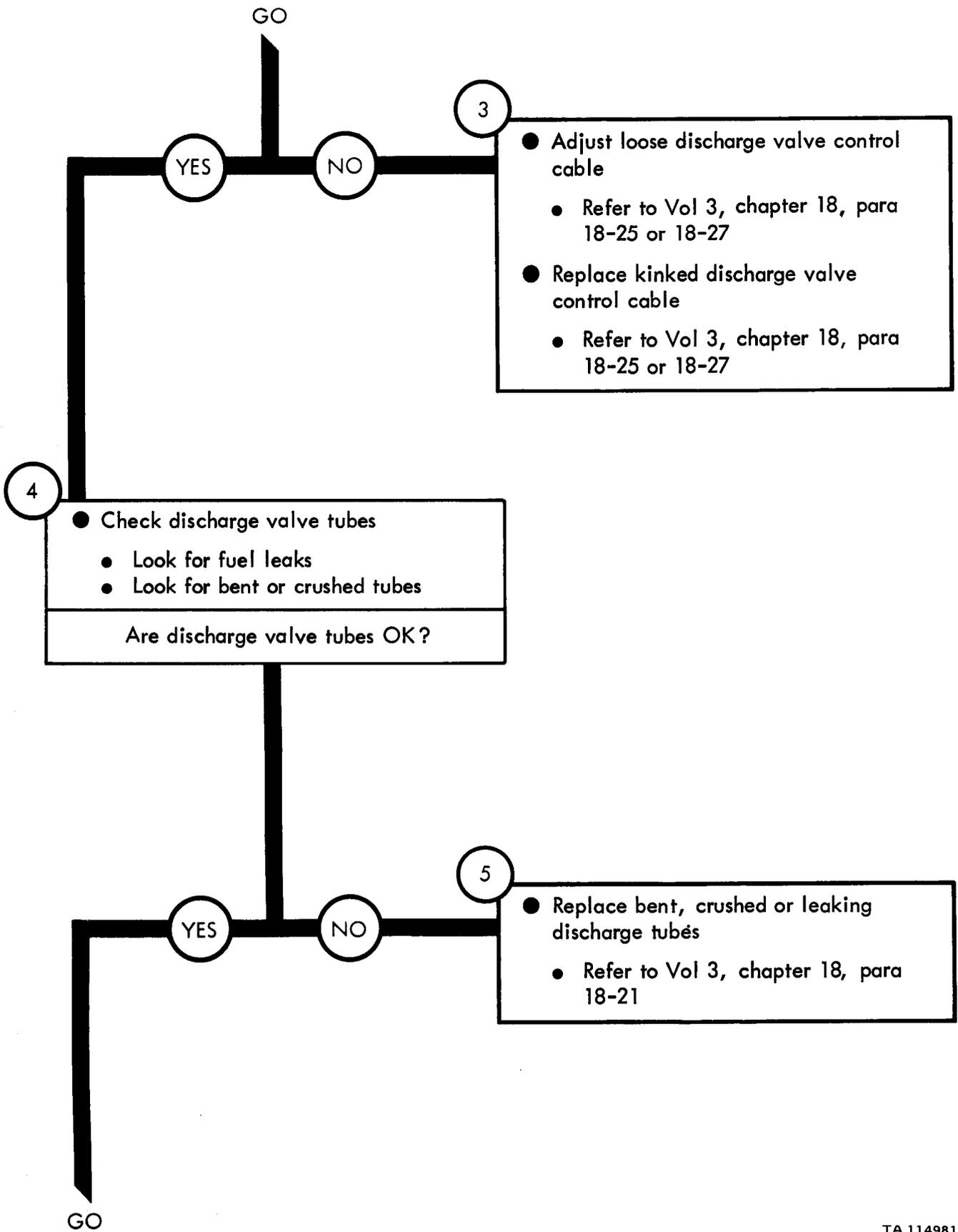

Figure 65-6 (Sheet 2 of 3)

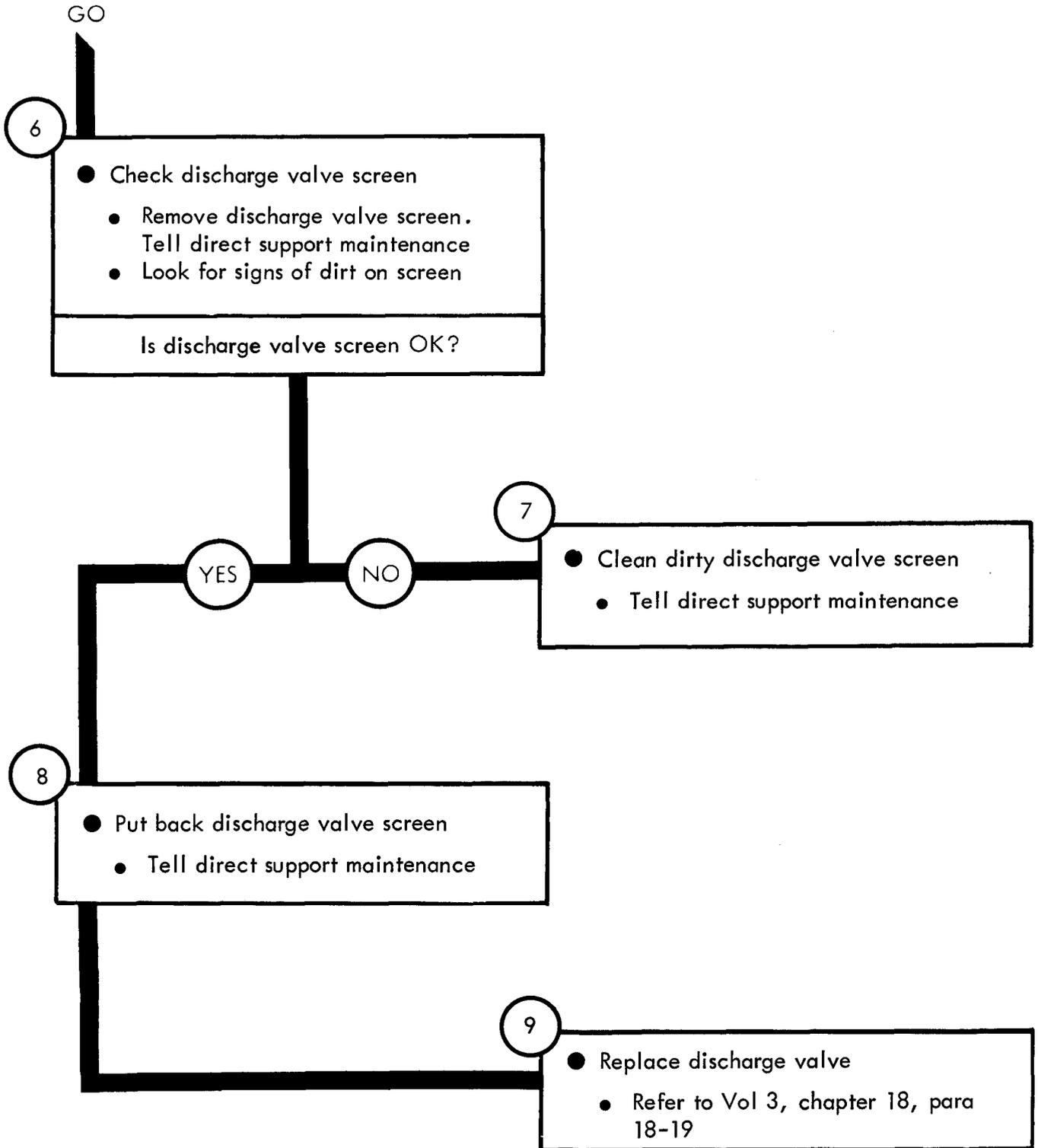

Figure 65-6 (Sheet 3 of 3)

Symptom

7 TANKS CANNOT BE FILLED BY SUCTION

- 1
- Make truck ready for work on suction system
 - Park truck. Refer to TM 9-2320-209-10

WARNING

Do not use a hammer or pry bar when working on fuel tanks. Care must be used when choosing a place to work on fuel tanks. Keep truck about 50 feet away from an area where open flame, sparks, or smoking can cause a fire. Keep a fire extinguisher close by

- 2
- Check fusible link
 - See if link has come off mounting pin
 - Look for a broken link
- Is fusible link OK?

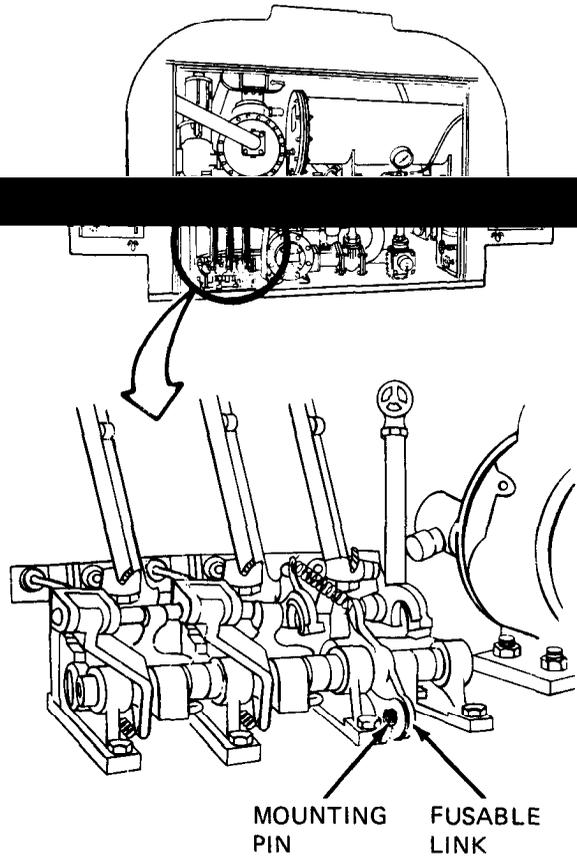

- 3
- Put back fusible link that has come off mounting pin
 - Slide link over mounting pin
 - Put cotter pin through hole in mounting pin and bend ends around using needle nose pliers
 - Replace broken fusible link
 - Refer to Vol 3, chapter 18, para 18-30
- YES NO
- GO

TA 114983

GO

4

- Check power takeoff linkage
 - Look for loose, bent or broken linkage
 - Crawl under truck
 - Feel for loose, bent or broken linkage
- Is power takeoff linkage OK?

GO

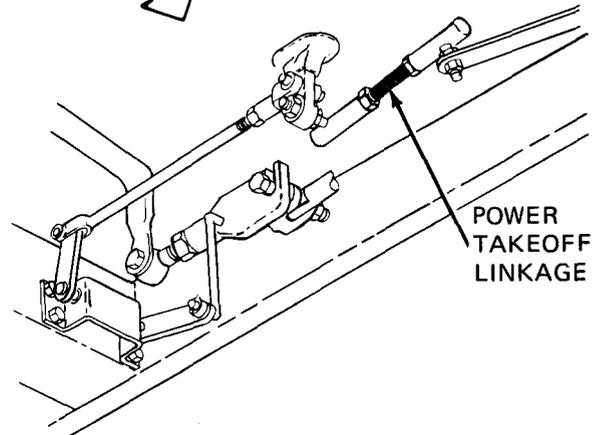
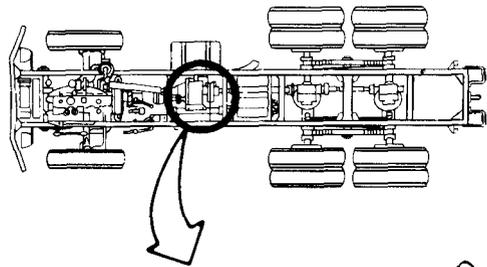
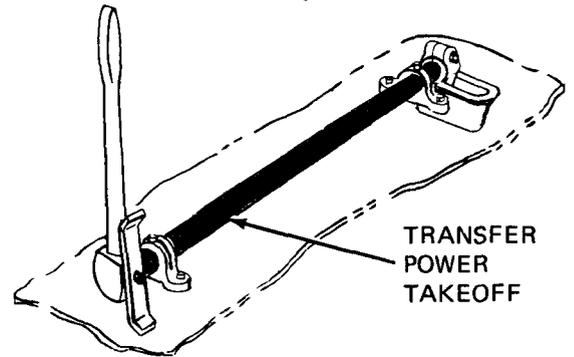
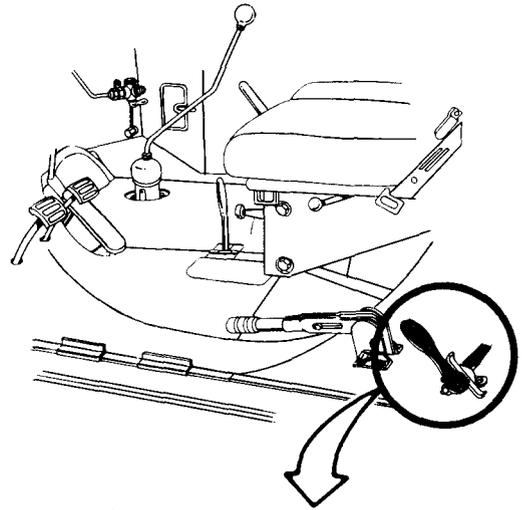
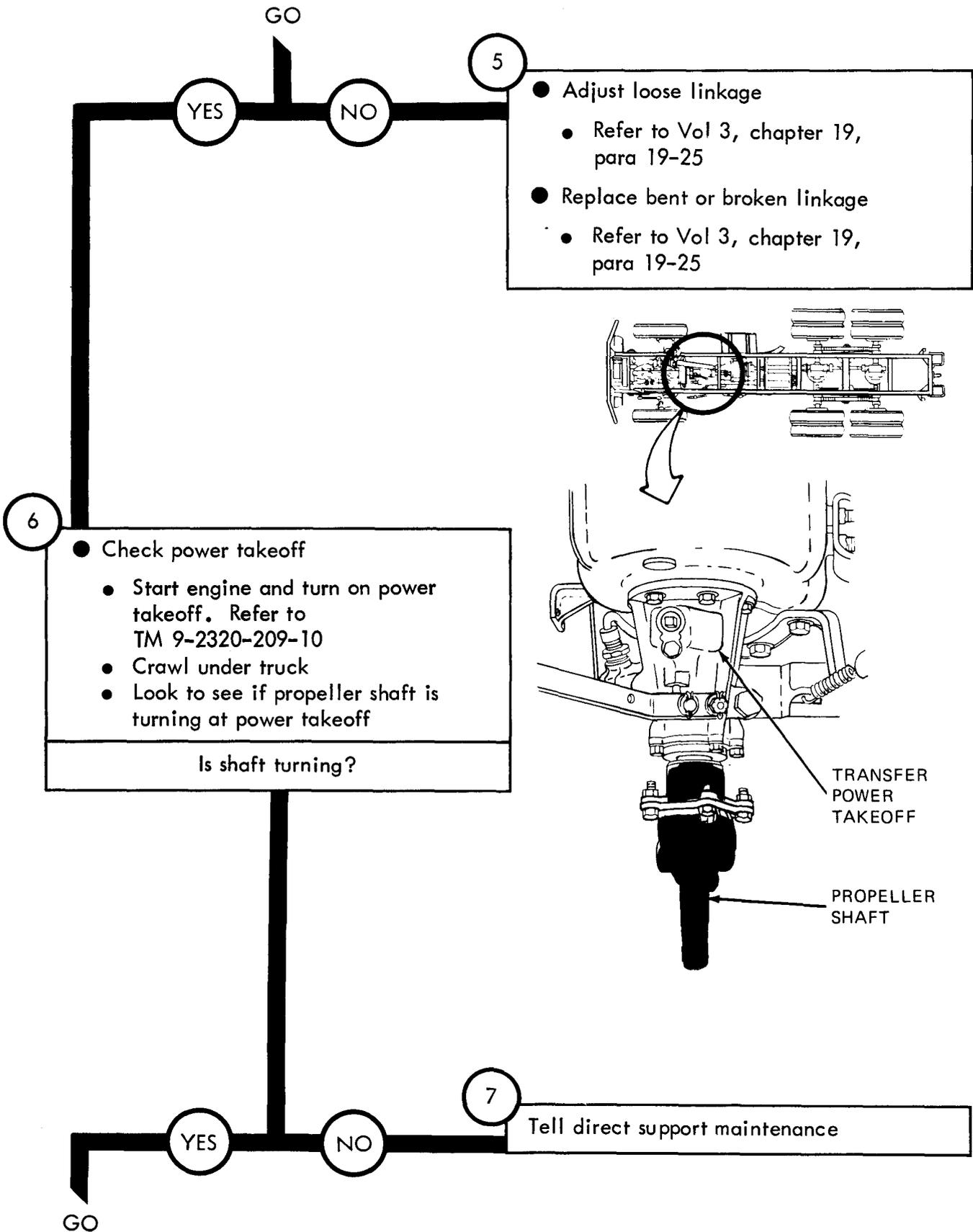

Figure 65-7 (Sheet 2 of 6)



TA 114985

Figure 65-7 (Sheet 3 of 6)

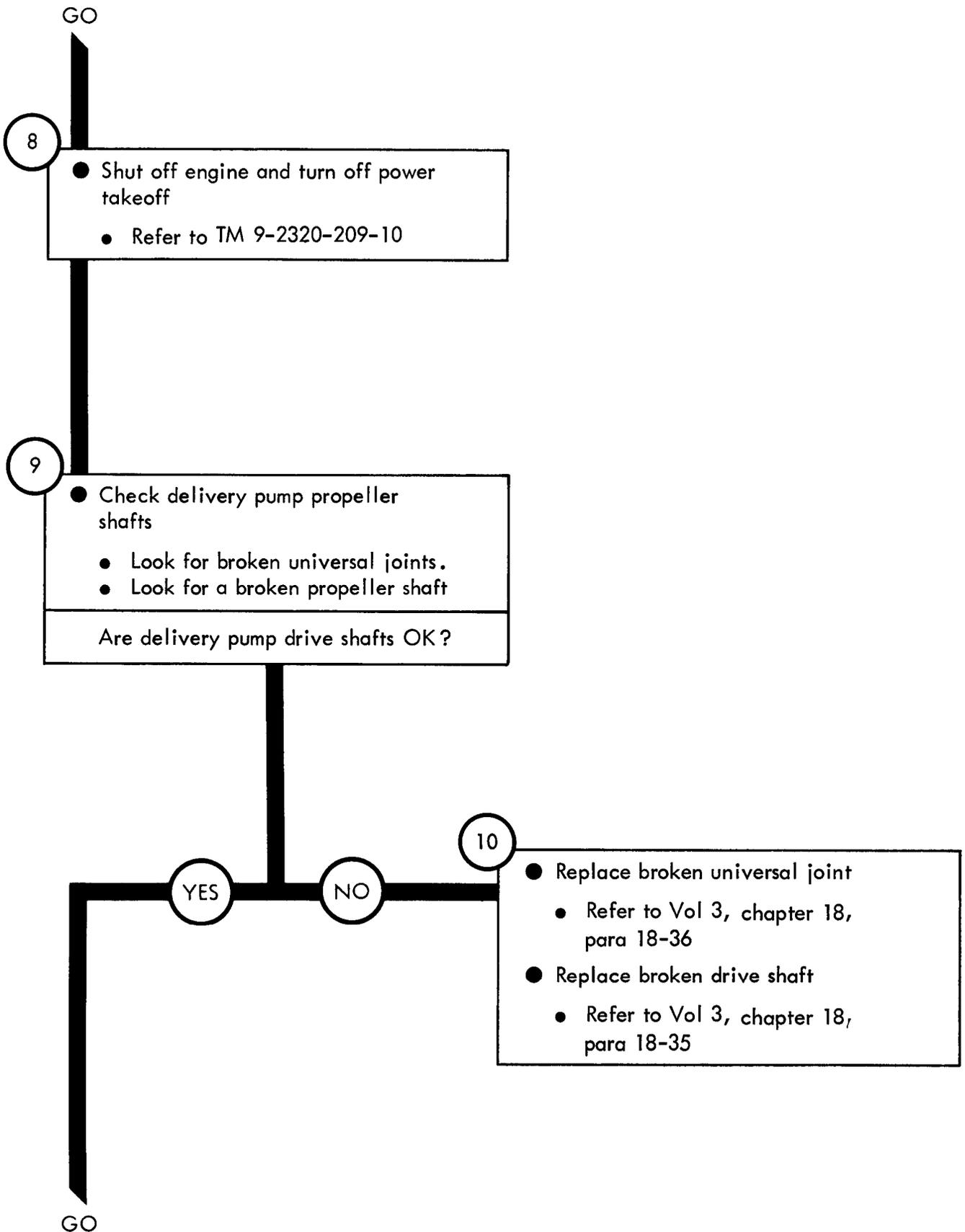
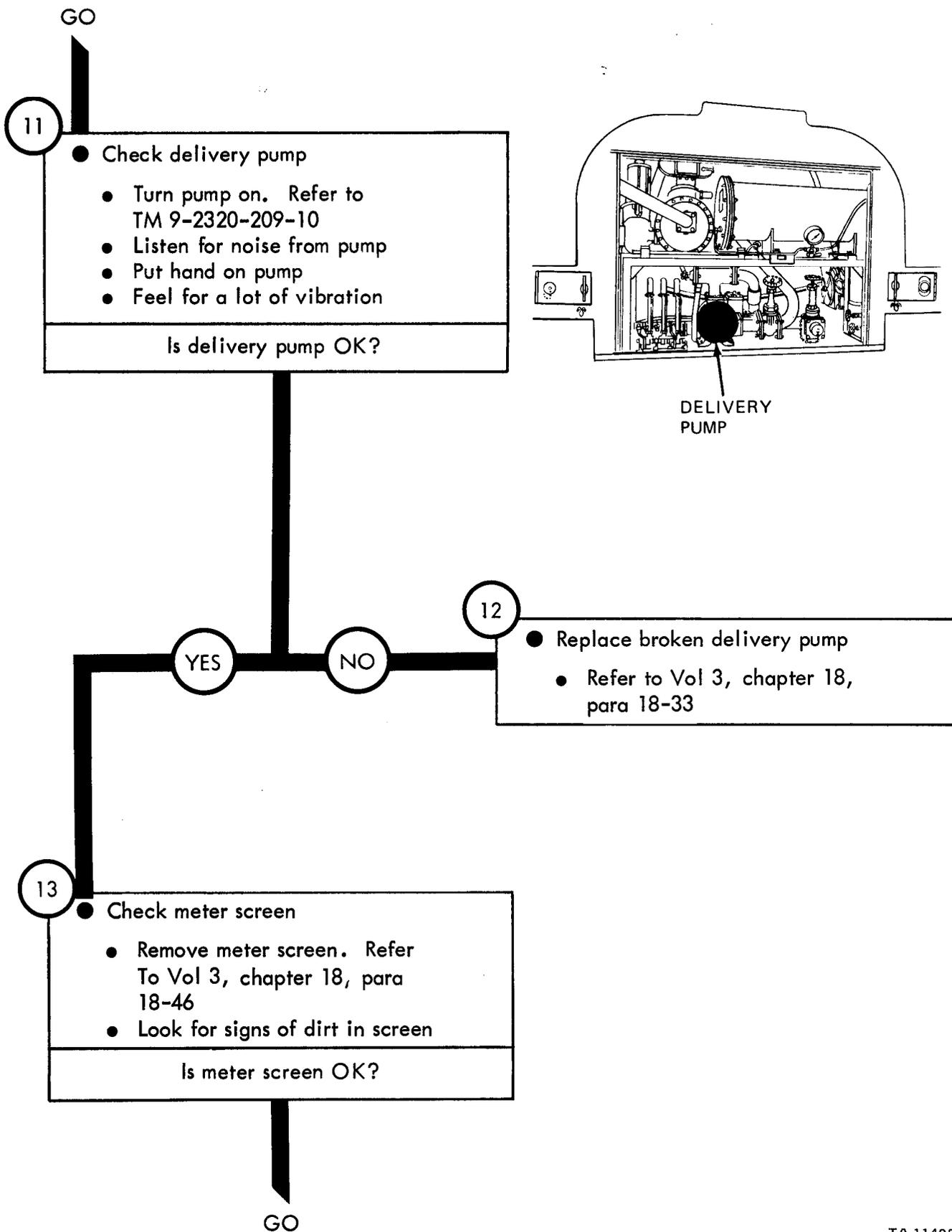
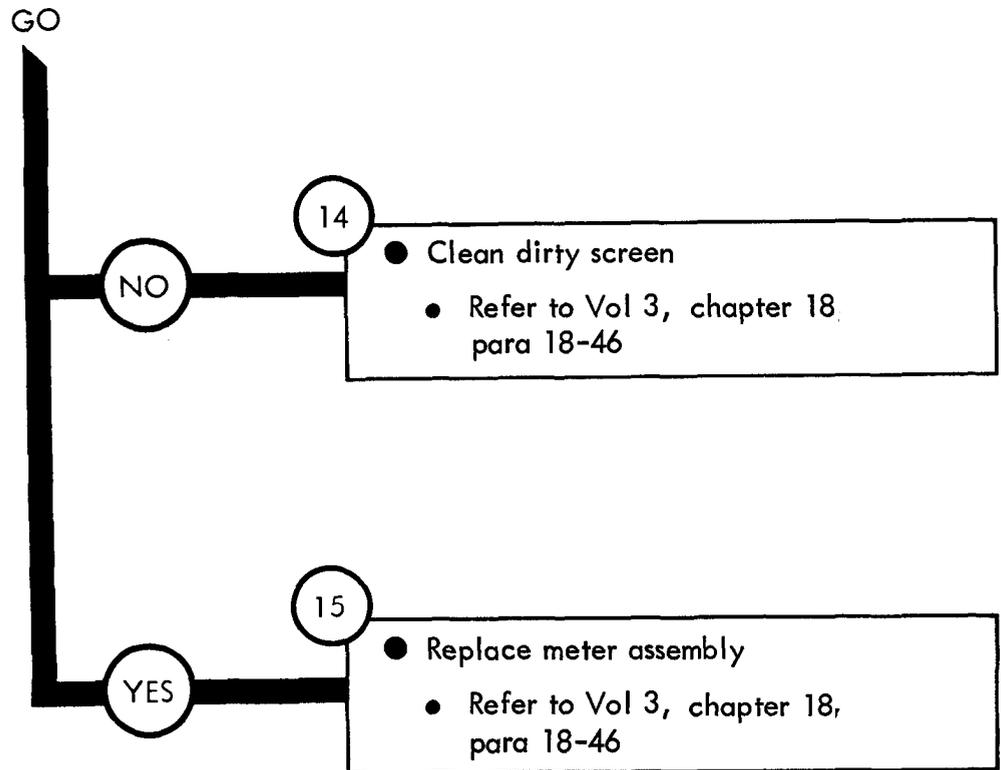

Figure 65-7 (Sheet 4 of 6)



TA 114987

Figure 65-7 (Sheet 5 of 6)



CHAPTER 66

FUEL TANK BODY (TRUCK M49A1C)

TROUBLESHOOTING SUMMARY

66-1. GENERAL. This chapter gives a summary of troubleshooting procedures given in chapter 65 for the fuel tank body (M49A1C).

66-2. PROCEDURES. The summary in this chapter covers all fault symptoms found in the detailed troubleshooting procedures. Chapter 7 outlines a sample troubleshooting procedure. The summary procedures are based on the "what-to-do" portions of the detailed procedures and do not include the "how -to-do-it" instructions. Warnings, cautions, and notes are given where needed.

FUEL TANK BODY M49A1C TROUBLESHOOTING SUMMARY

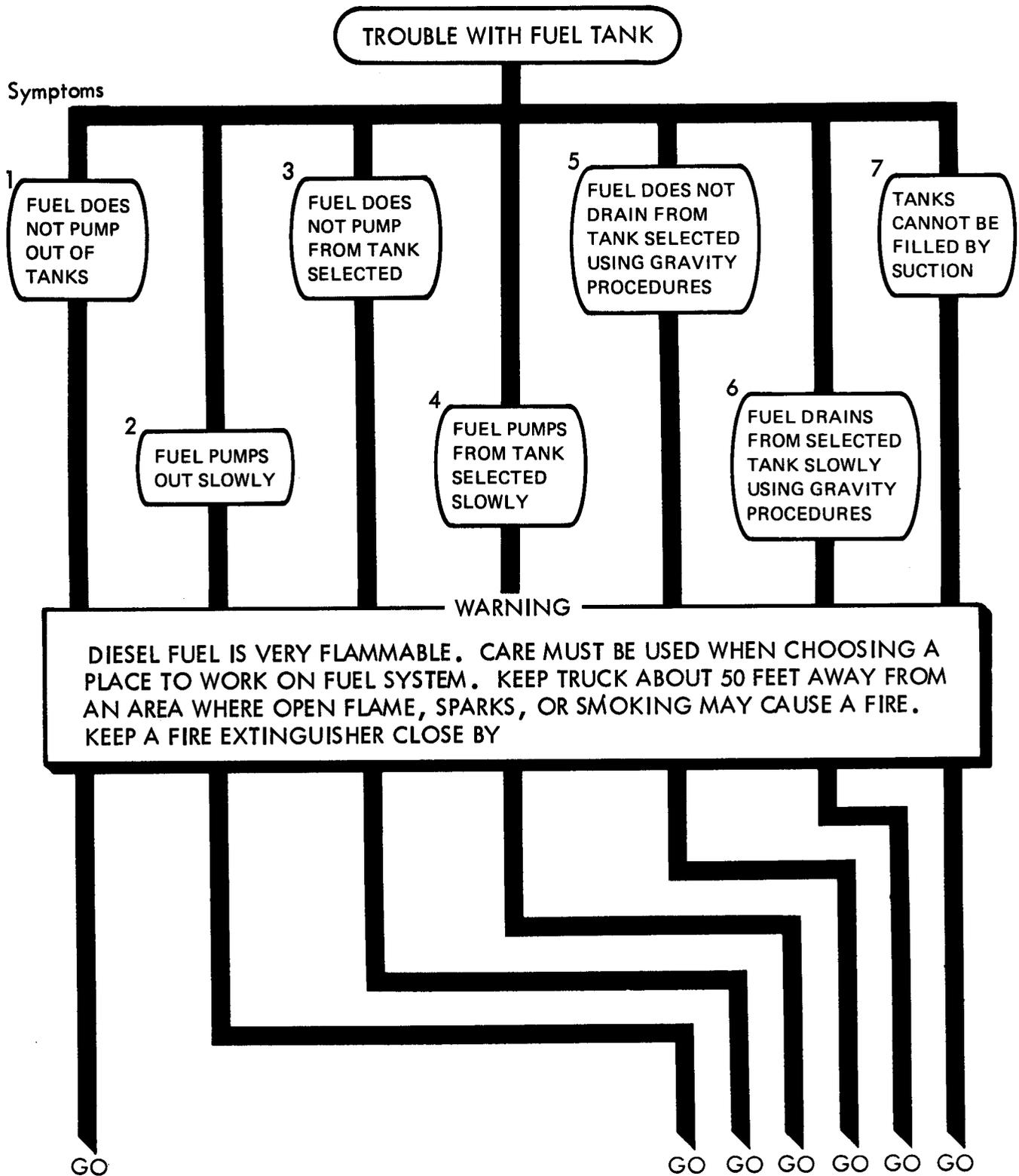

TA 114989a

Figure 66-1 (Sheet 1 of 5)

GO

- LOOK TO FIND A FAULT IN ONE OF THE FOLLOWING:
 - FUSIBLE LINK
 - POWER TAKEOFF LINKAGE
 - POWER TAKEOFF

- DELIVERY PUMP PROPELLER SHAFTS
- DELIVERY PUMP
- METER SCREEN

CLEAN, REPAIR OR REPLACE BAD PART

NOTE: FOR DETAILED TROUBLESHOOTING PROCEDURES, SEE SYMPTOM INDEX

GO GO GO GO GO GO



- LOOK TO FIND A FAULT IN ONE OF THE FOLLOWING:
 - SEGREGATOR FILTER
 - DELIVERY PUMP PRESSURE
 - METER SCREEN

CLEAN, REPAIR OR REPLACE BAD PART

NOTE: FOR DETAILED TROUBLESHOOTING PROCEDURES, SEE SYMPTOM INDEX

GO GO GO GO GO

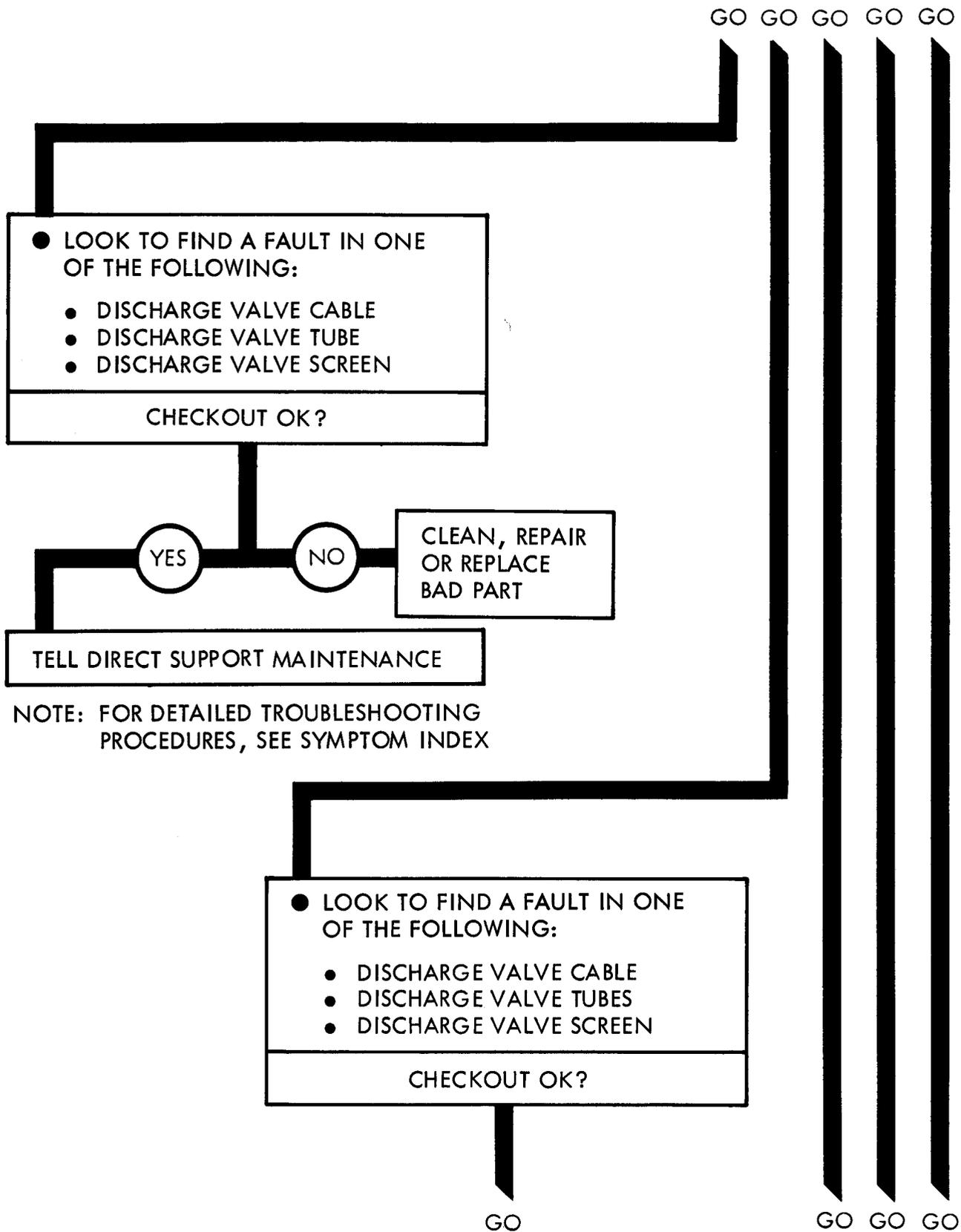

TA 114990

Figure 66-1 (Sheet 3 of 5)

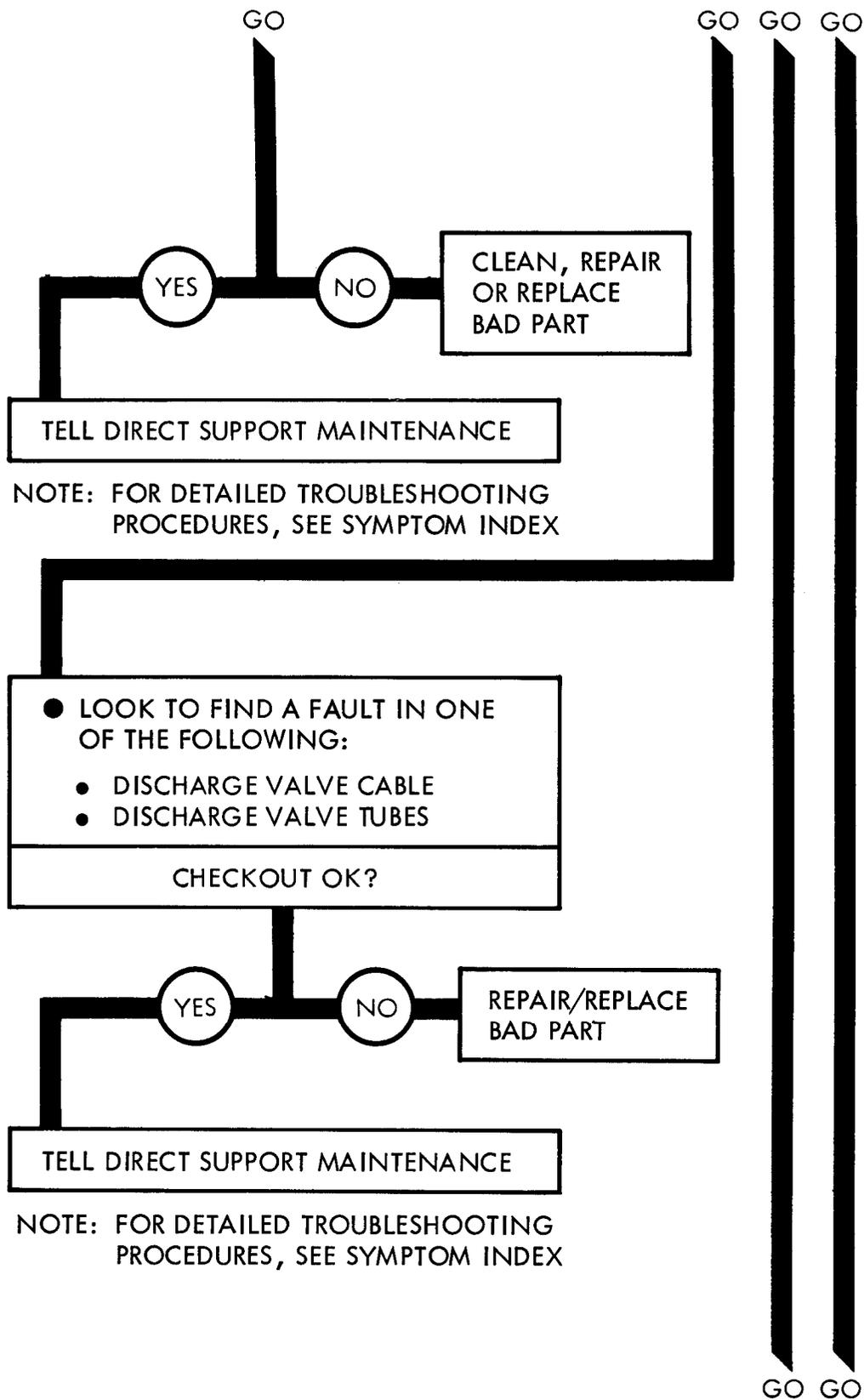

Figure 66-1 (Sheet 4 of 5)

TA 114991

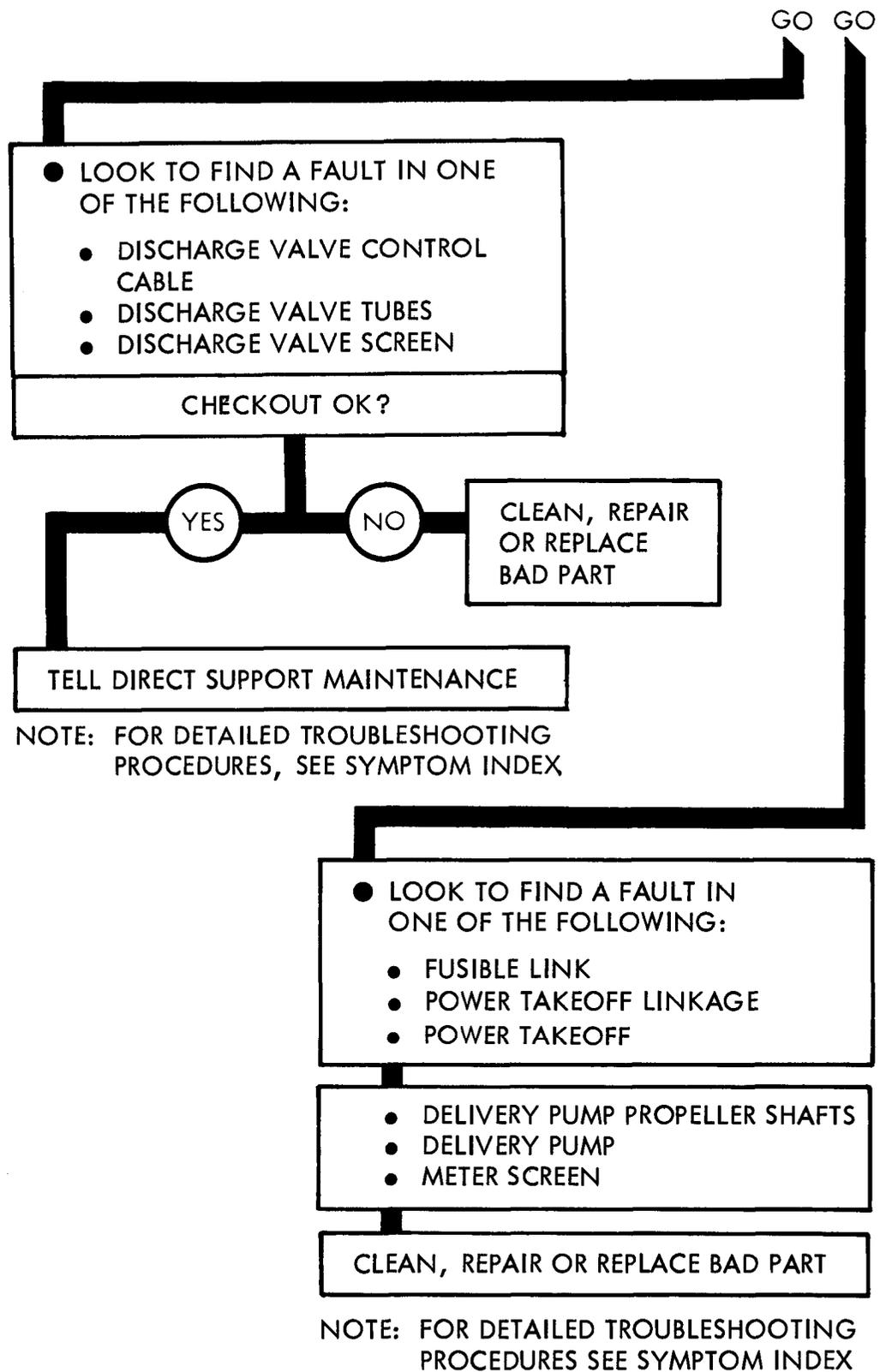

Figure 66-1 (Sheet 5 of 5)

CHAPTER 67

FUEL TANK BODY (TRUCK M49A1C) SUPPORT DIAGRAMS

67-1. GENERAL. This chapter gives the diagrams you need when doing troubleshooting procedures in chapter 65. Table 3-1 is a complete listing of all support diagrams used in this manual.

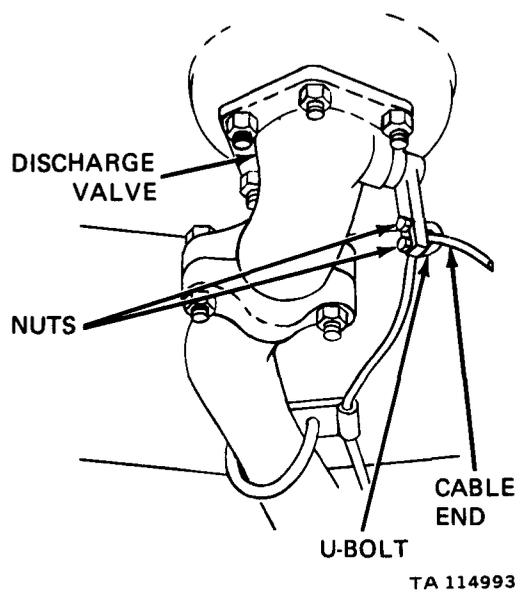
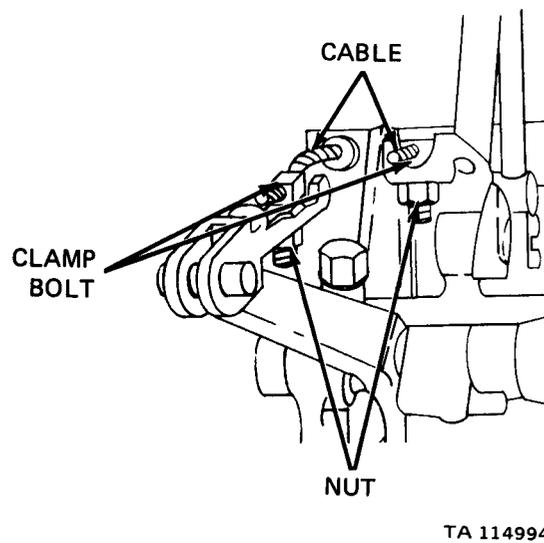

Figure 67-1. Fuel Tank Body (M49A1C) Support Diagram



TA 114994

Figure 67-2. Fuel Tank Body (M49A1C) Support Diagram

CHAPTER 68

FUEL TANK BODY (TRUCK M49A1C) CHECKOUT PROCEDURES

68-1. GENERAL. This chapter gives procedures for checking out the system after troubleshooting and repair have been done. Procedures are set up in flow chart form showing the checkout steps in order and referring to the fault symptom index when the system does not checkout.

FUEL TANK BODY M49A1C CHECKOUT

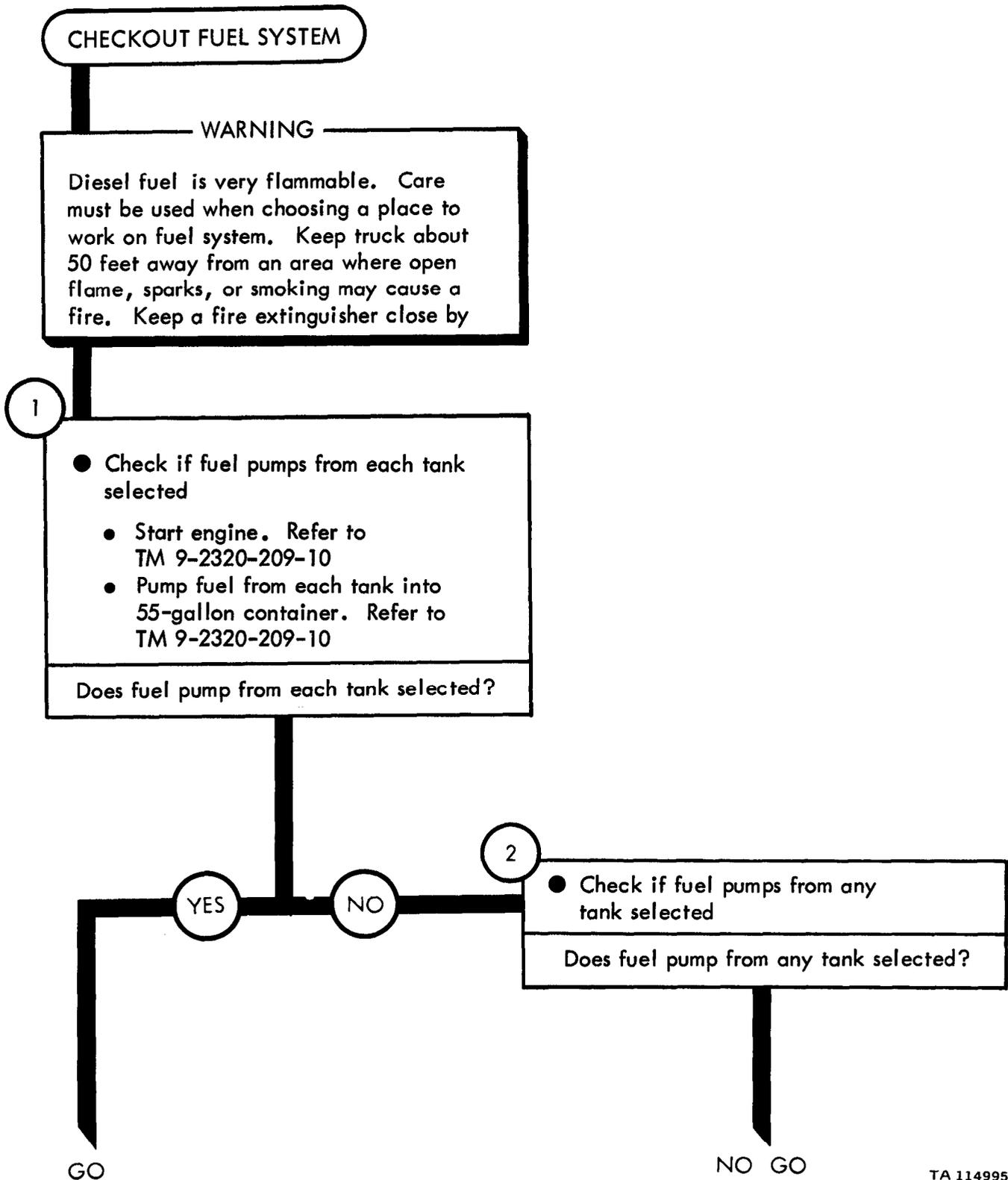

TA 114995

Figure 68-1 (Sheet 1 of 4)

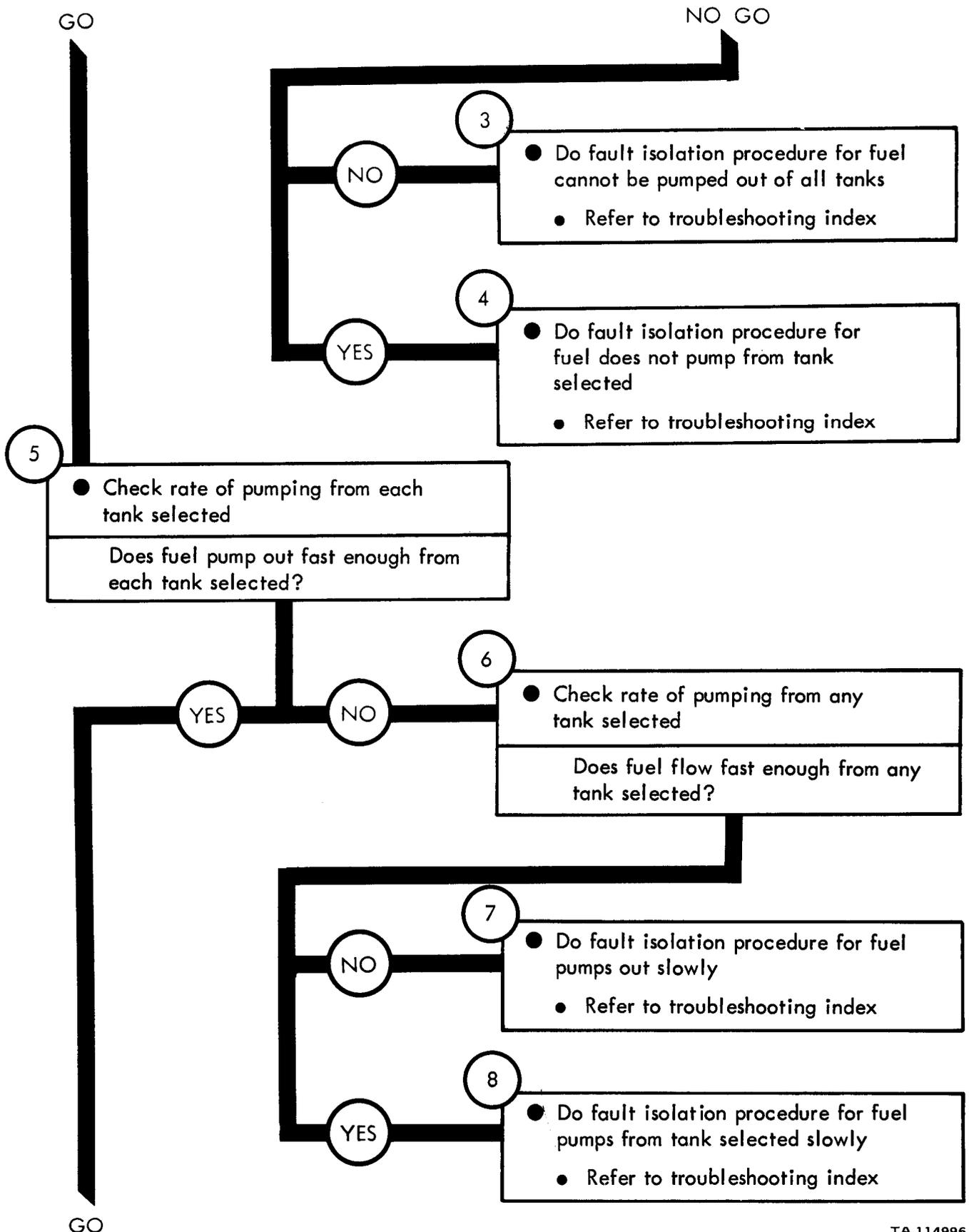

TA 114996

Figure 68-1 (Sheet 2 of 4)

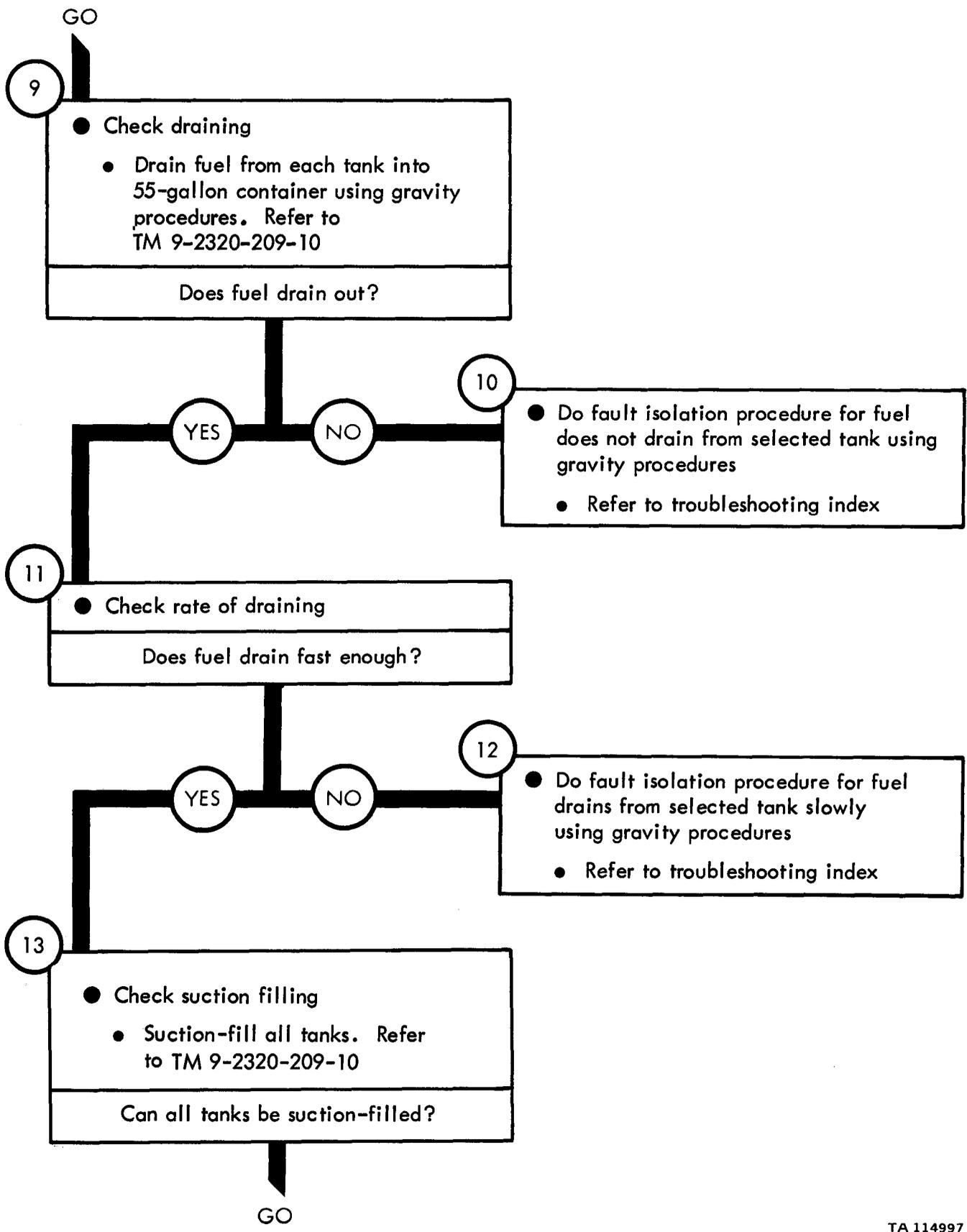

Figure 68-1 (Sheet 3 of 4)

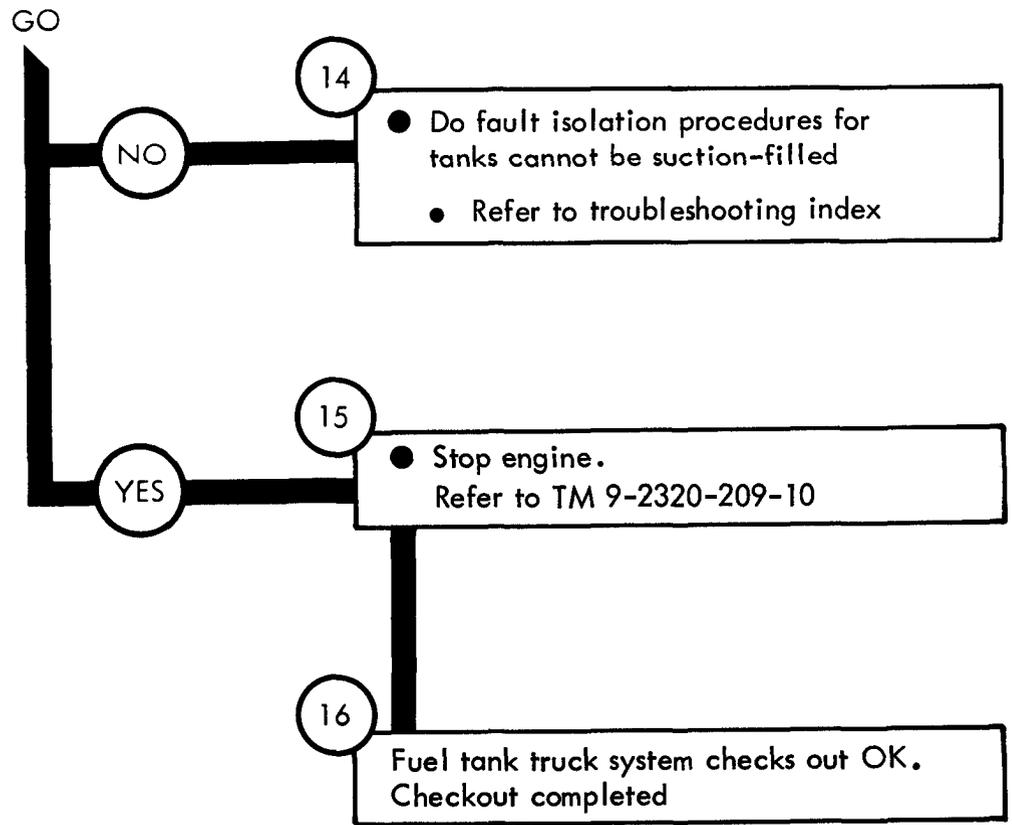

Figure 68-1 (Sheet 4 of 4)

CHAPTER 69

FUEL TANK BODY (TRUCK M49A2C) TROUBLESHOOTING

69-1. EQUIPMENT ITEMS COVERED. This chapter gives equipment troubleshooting procedures for the fuel tank body M49A2C, for which there are authorized corrective maintenance tasks at the organizational maintenance level.

69-2. EQUIPMENT ITEMS NOT COVERED. All equipment items for which corrective maintenance is authorized at the organizational maintenance level are covered in this chapter.

FUEL TANK BODY M49A2C TROUBLESHOOTING

Symptom

1

FUEL DOES NOT PUMP OUT OF TANKS

1

- Stop pumping operations
 - Close delivery pump gate valve knob
 - Close dump valve knob
 - Close discharge valve control lever
 - Turn off engine
 - Chock wheels

WARNING

Diesel fuel is very flammable. Do not allow smoking or an open flame within 50 feet of truck while working on fuel tanker

GO

TA 114999

Figure 69-1 (Sheet 1 of 4)

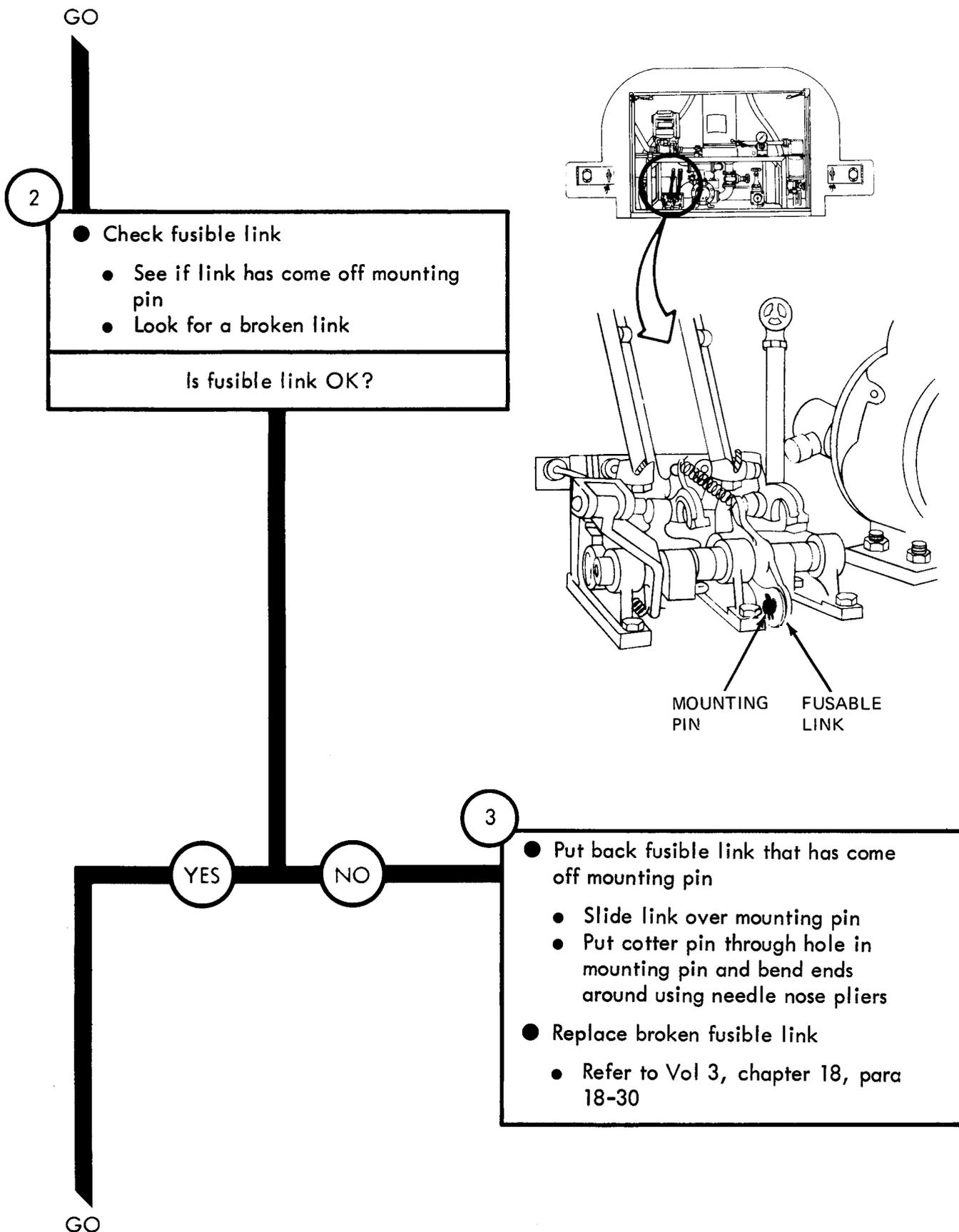
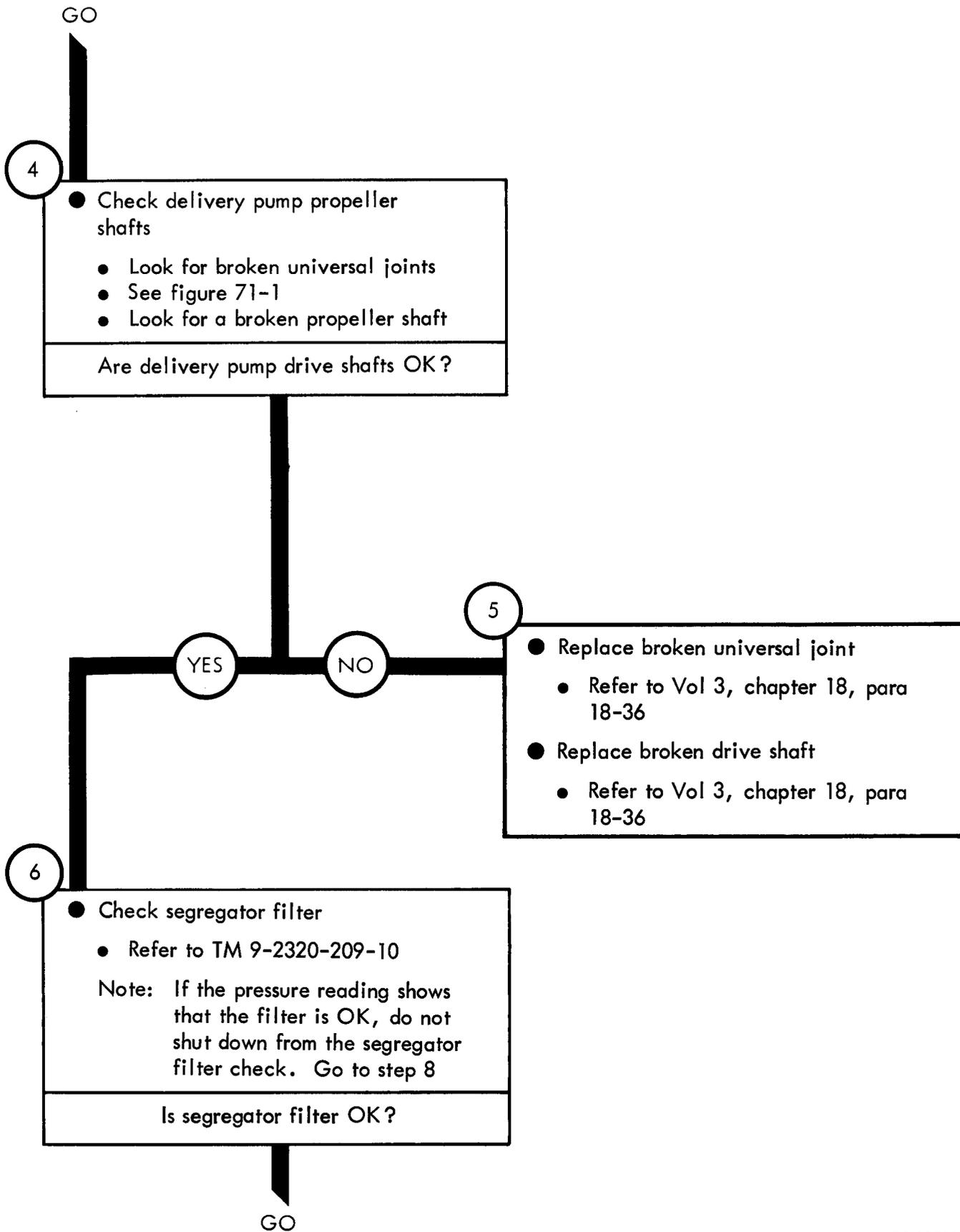

Figure 69-1 (Sheet 2 of 4)



TA 115001

Figure 69-1 (Sheet 3 of 4)

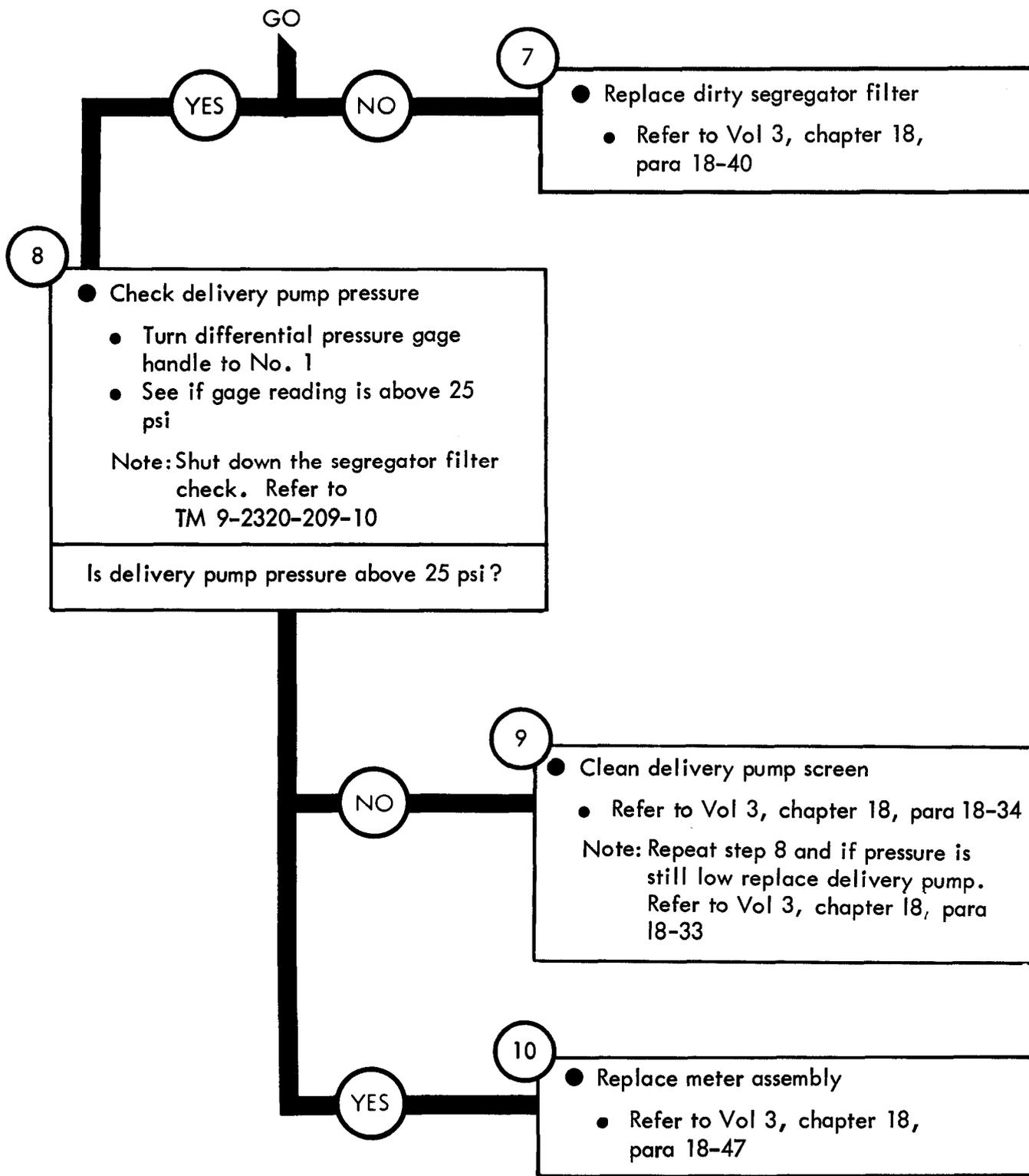
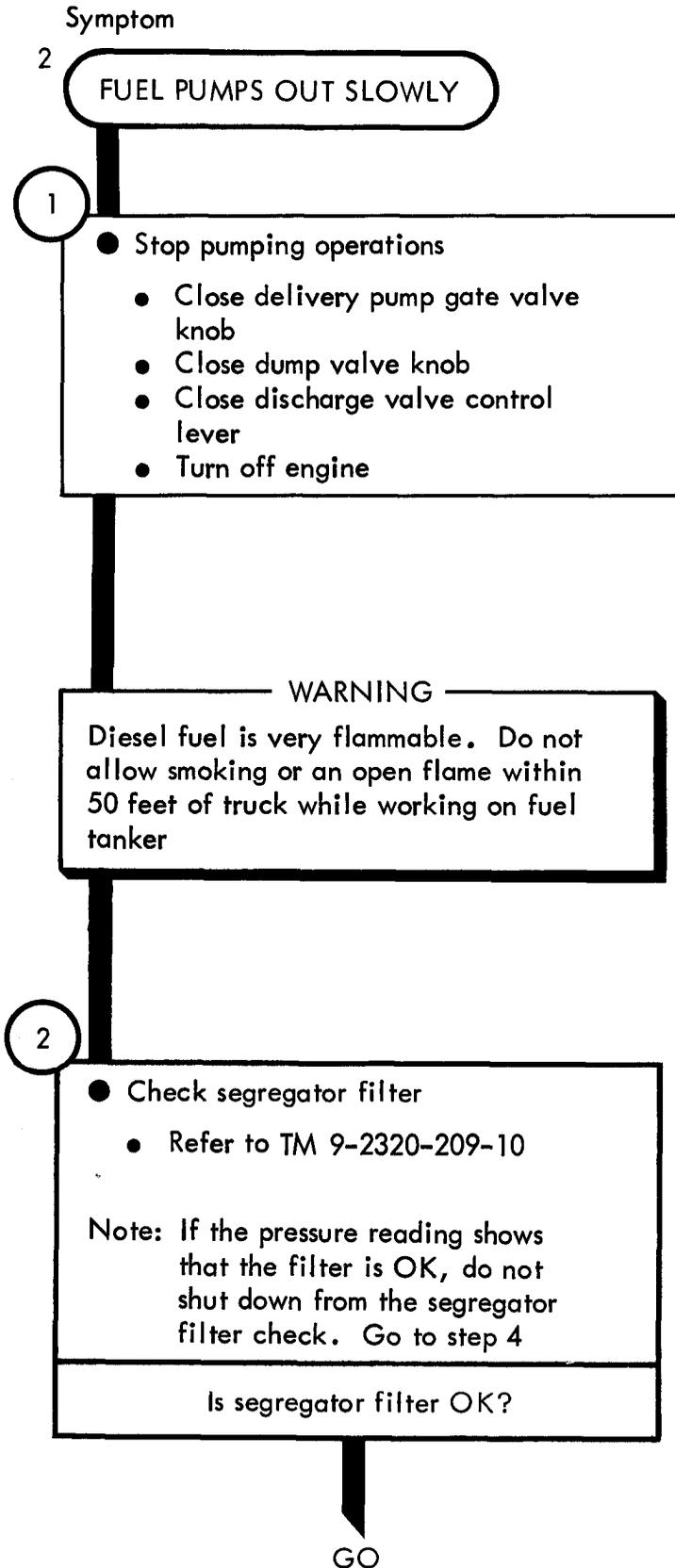
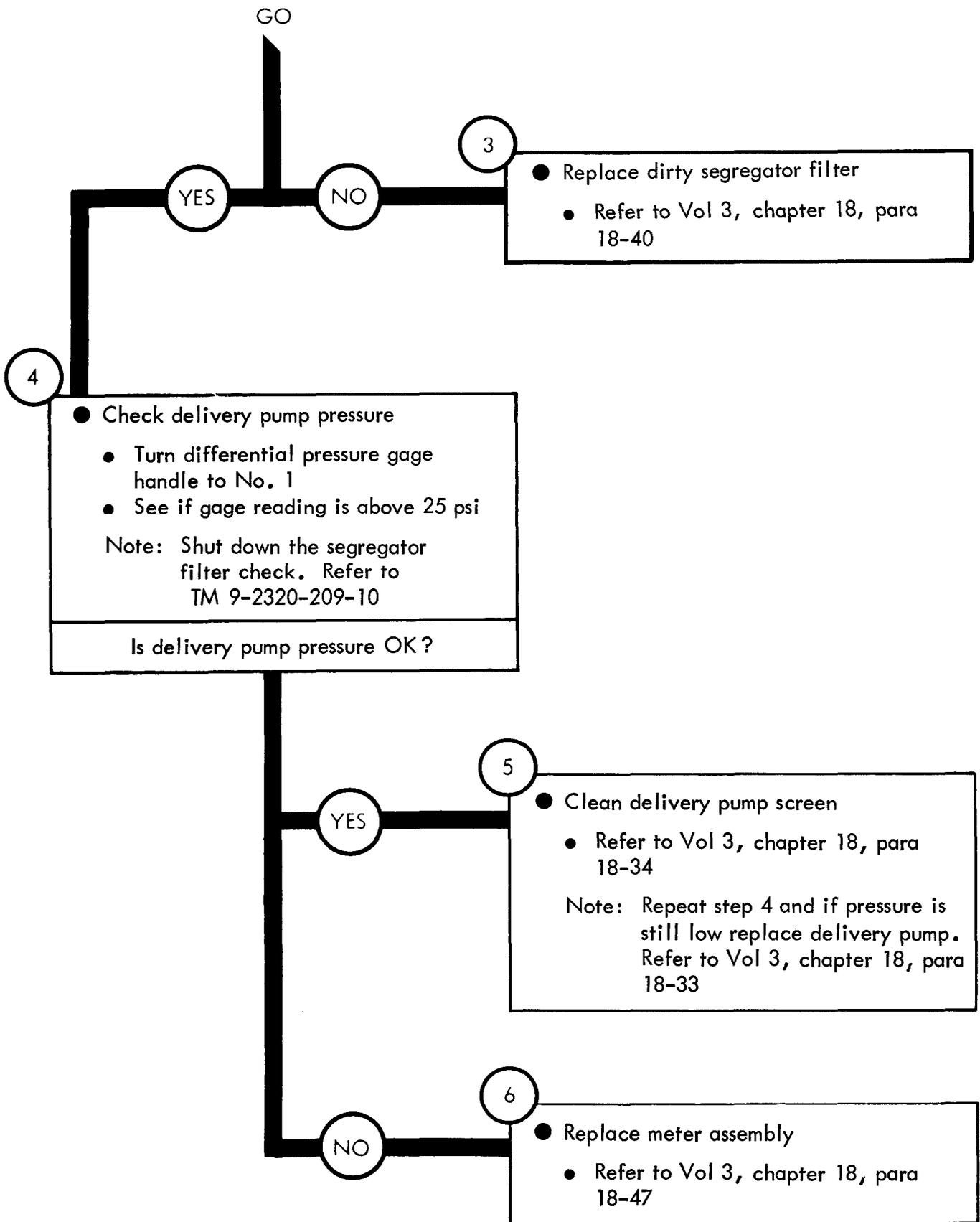

Figure 69-1 (Sheet 4 of 4)





TA 115004

Figure 69-2 (Sheet 2 of 2)

Symptom

3 FUEL DOES NOT PUMP FROM SELECTED TANK

- 1
- Stop pumping operations
 - Close delivery pump gate valve knob
 - Close dump valve knob
 - Close discharge valve control lever
 - Stop engine. Refer to TM 9-2320-209-10

WARNING

Diesel fuel is very flammable. Do not allow smoking or an open flame within 50 feet of truck while working on fuel tanker

- 2
- Check discharge valve cable
 - Look for a broken or kinked cable. See figure 71-1
 - See if cable has come off of mounts
- Is discharge valve control cable OK?

GO

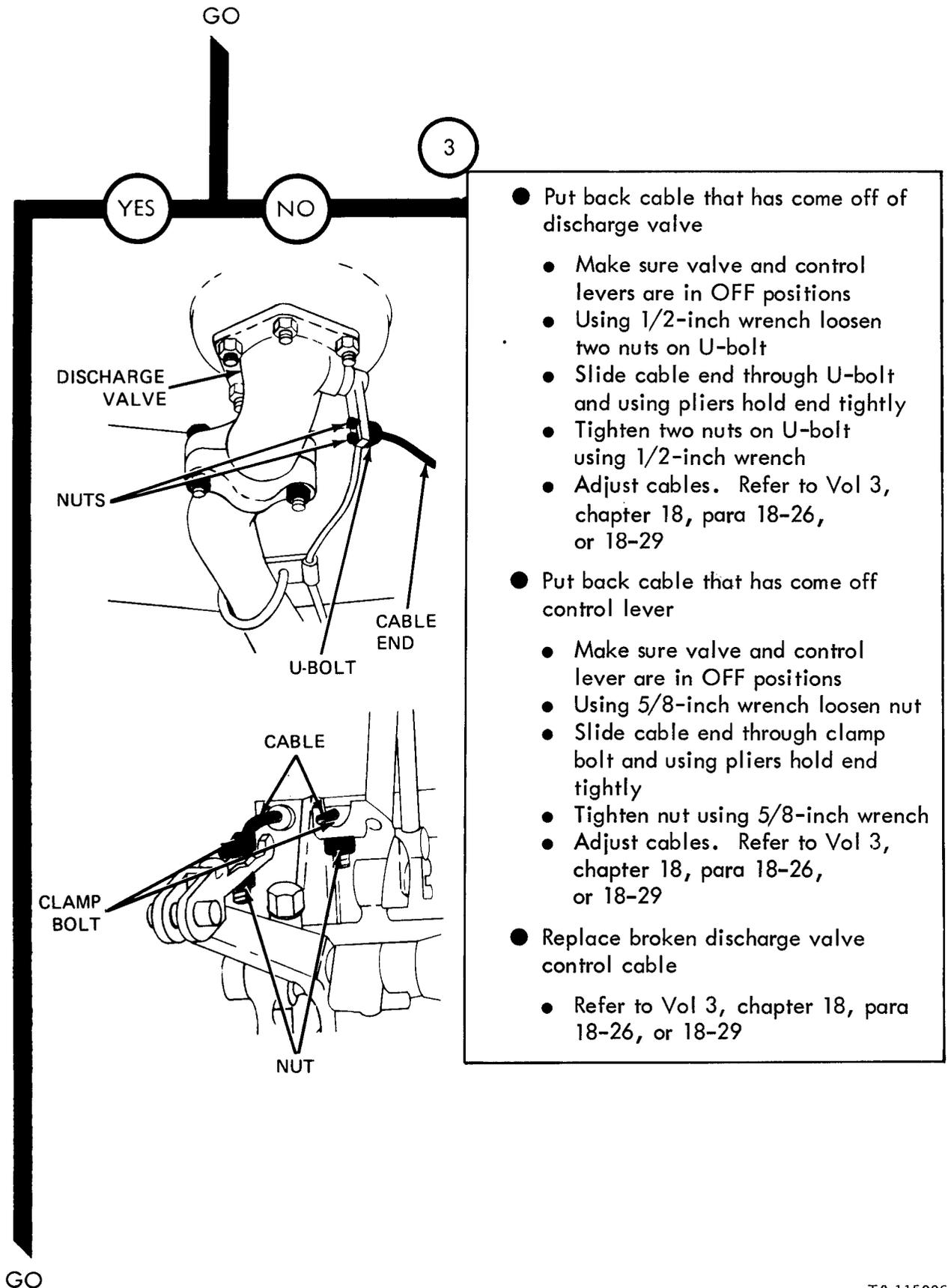

TA 115006

Figure 69-3 (Sheet 2 of 3)

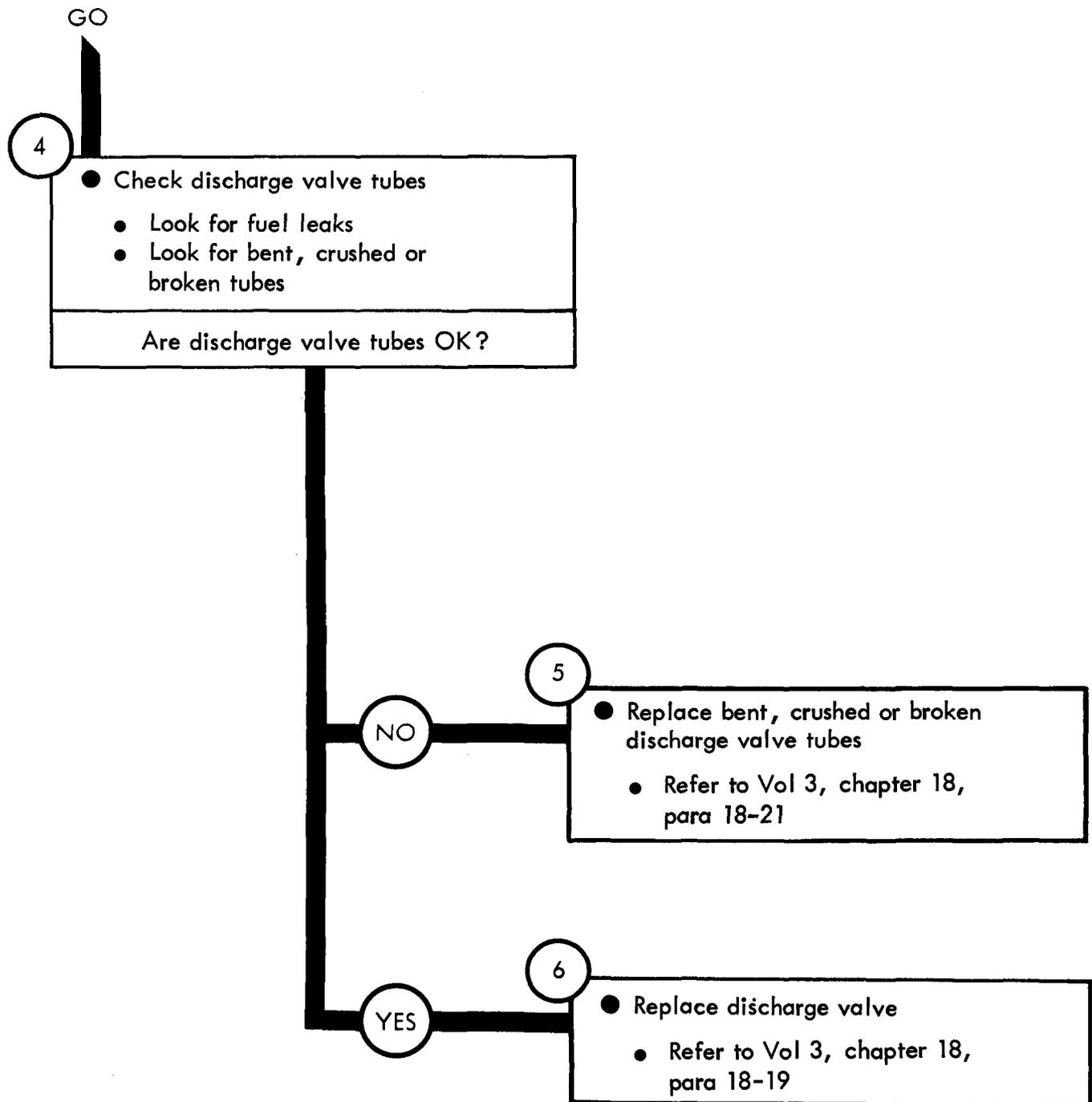

TA 115007

Figure 69-3 (Sheet 3 of 3)

Symptom

4

FUEL PUMPS FROM SELECTED TANK SLOWLY

1

- Stop pumping operations
 - Close delivery pump gate valve knob
 - Close dump valve knob
 - Close discharge valve control lever
 - Turn off engine
 - Chock wheels

WARNING

Diesel fuel is very flammable. Do not allow smoking or an open flame within 50 feet of truck while working on fuel tanker

2

- Check discharge valve cable
 - Look for a kinked cable. See figure 71-1
 - Shake cable at discharge valve to feel if it is loose

Is discharge valve control cable OK?

GO

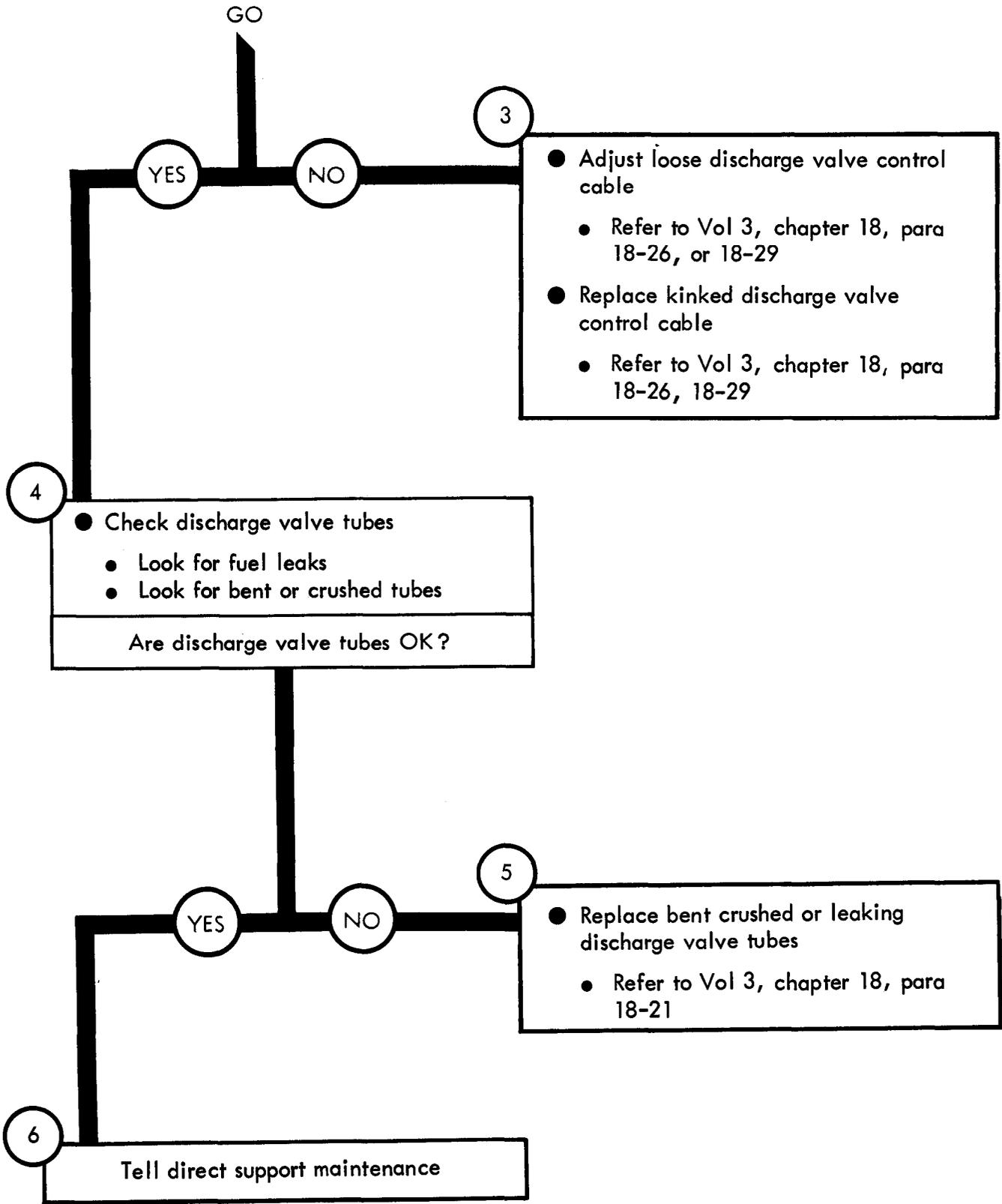

Figure 69-4 (Sheet 2 of 2)

Symptom

5

FUEL DOES NOT DRAIN FROM SELECTED TANK USING GRAVITY PROCEDURES

1

- Park truck
 - Refer to TM 9-2320-209-10

WARNING

Diesel fuel is very flammable. Do not allow smoking, or an open flame within 50 feet of truck while working on fuel tanker

2

- Check discharge valve cable
 - Look for a broken or kinked cable. See figure 71-1
 - See if cable has come off of mount

Is discharge valve control cable OK?

GO

TA 115010

Figure 69-5 (Sheet 1 of 3)

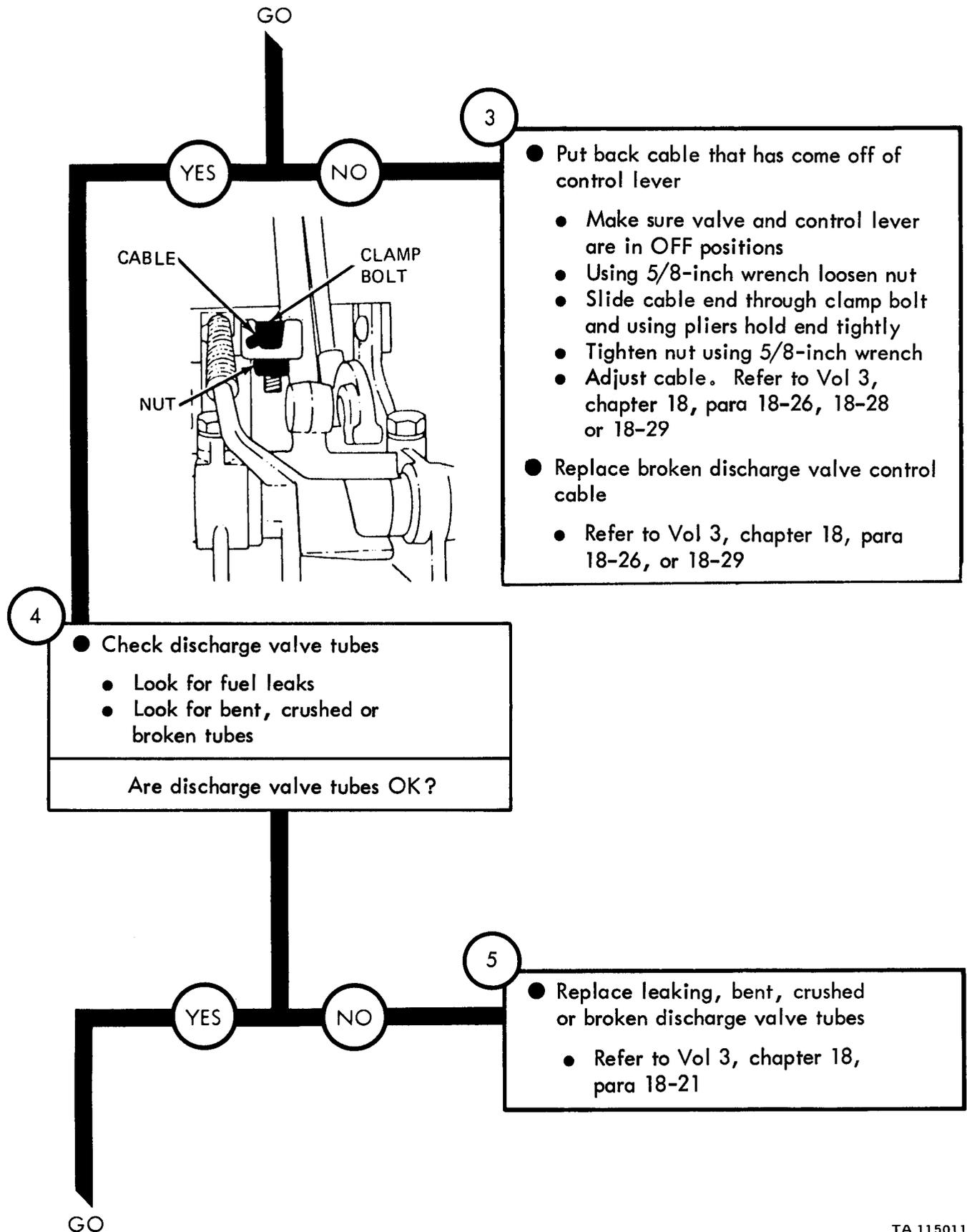
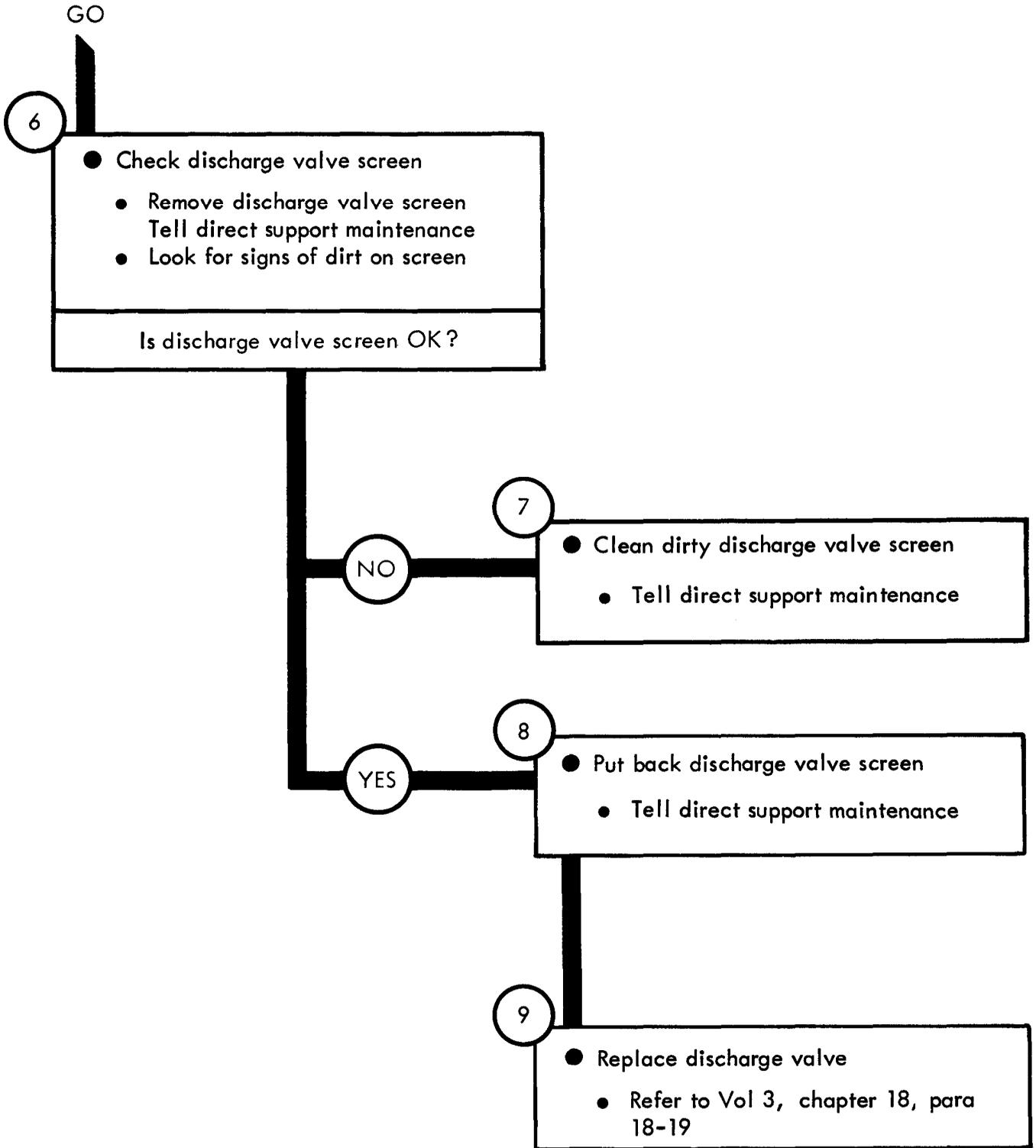

Figure 69-5 (Sheet 2 of 3)



TA 115012

Figure 69-5 (Sheet 3 of 3)

Symptom

6

FUEL DRAINS FROM SELECTED TANK SLOWLY USING GRAVITY PROCEDURES

1

- Park truck
 - Refer to TM 9-2320-209-10
- Close discharge valve control levers and delivery line valve knob
 - Refer to TM 9-2320-209-10

— WARNING —

Diesel fuel is very flammable. Do not allow smoking or an open flame within 50 feet of truck while working on fuel tanker

2

- Check discharge valve control cable
 - Look for kinked cable. See figure 71-1
 - Shake cable at discharge valve to feel if it is loose

Is discharge valve control cable OK?

GO

TA 11501:

Figure 69-6 (Sheet 1 of 2)

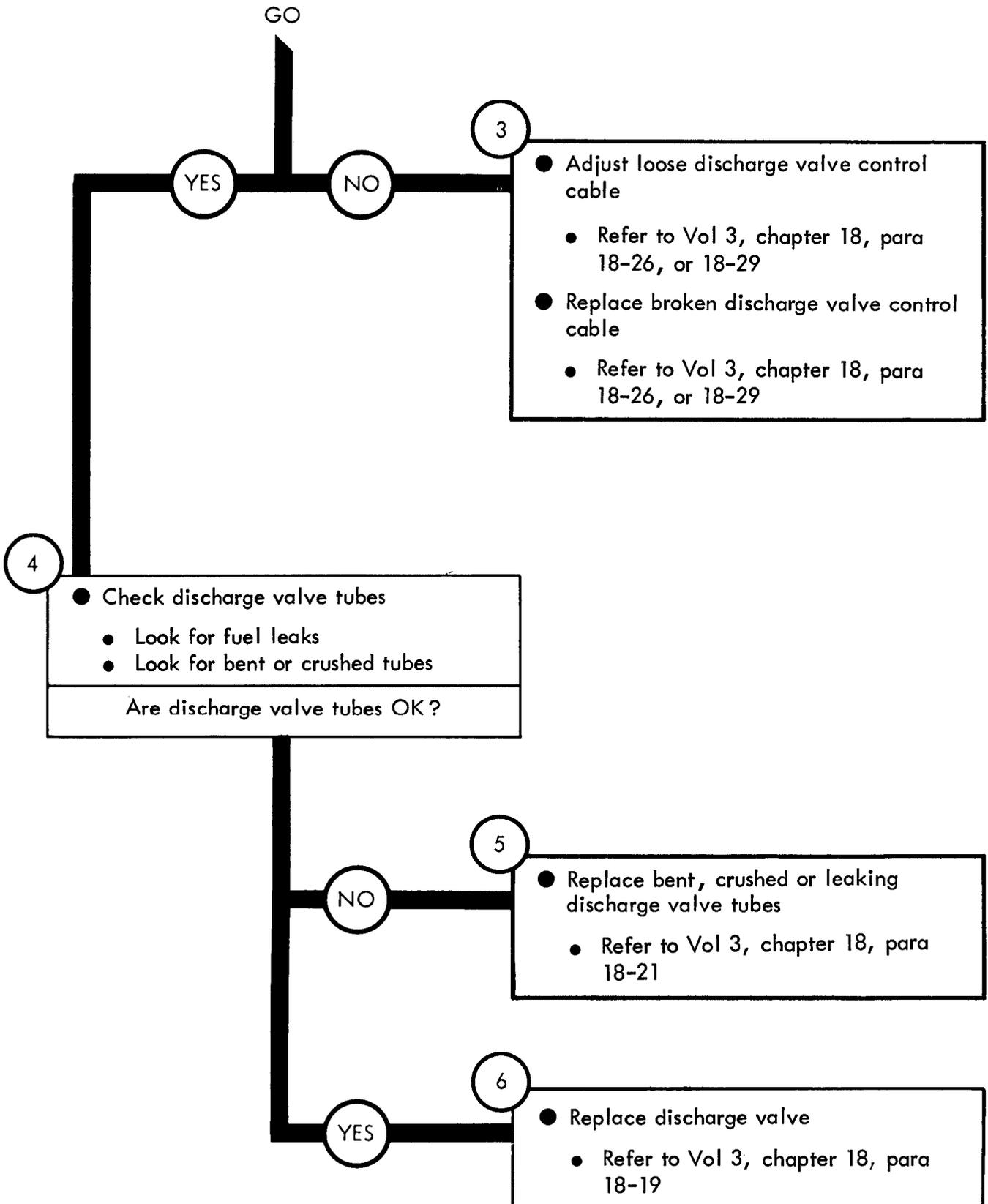

TA 115014

Figure 69-6 (Sheet 2 of 2)

Symptom

7 TANKS CANNOT BE FILLED BY SUCTION

1

- Stop suction filling operations
 - Close gravity delivery line gate valve
 - Turn off engine. Refer to TM 9-2320-209-10
 - Chock wheels

WARNING
Diesel fuel is very flammable. Do not allow smoking or an open flame within 50 feet of truck while working on fuel tanker

2

- Check delivery pump propeller shafts
 - Look for broken universal joints
 - Look for a broken propeller shaft
- Are delivery pump drive shafts OK?



GO

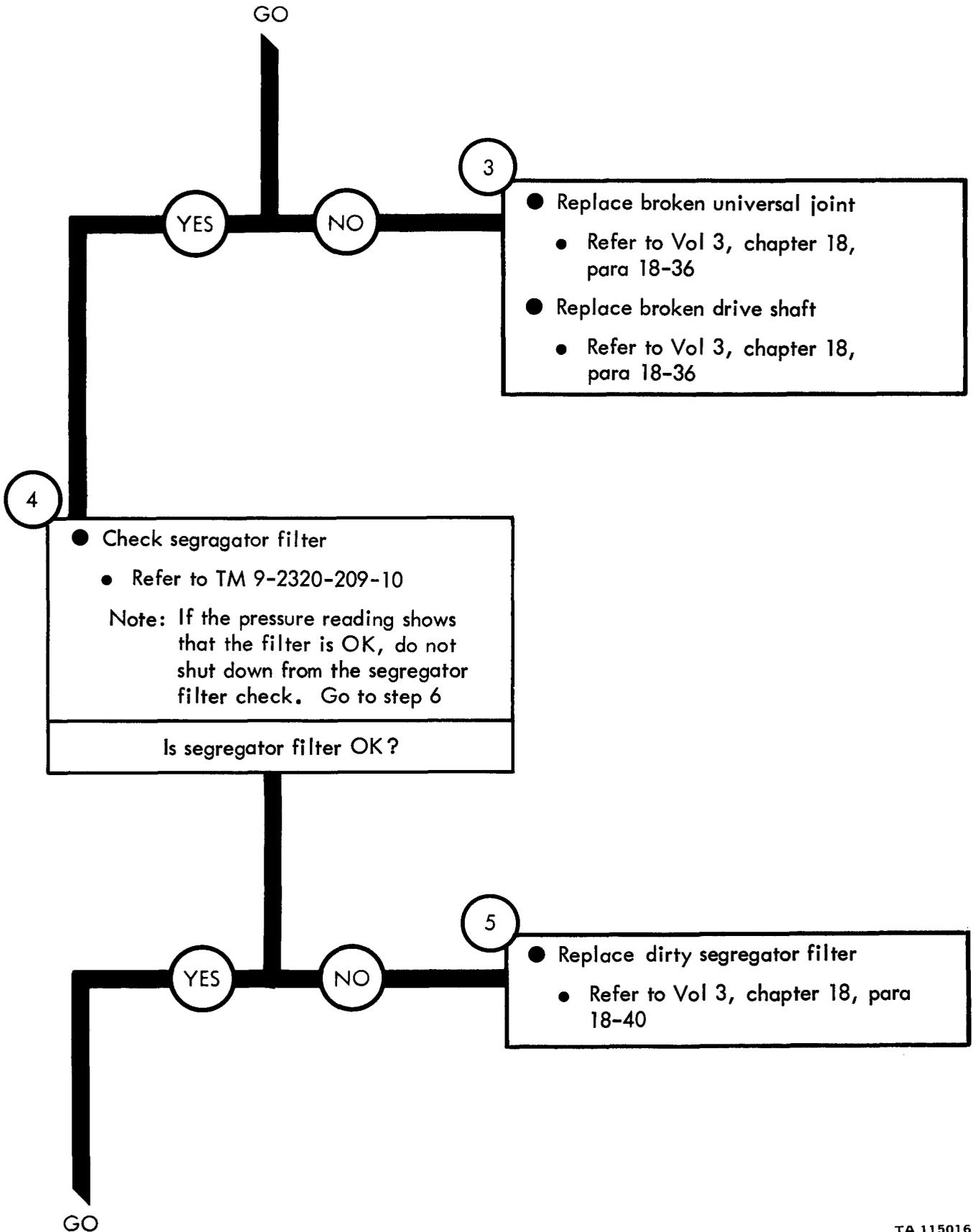
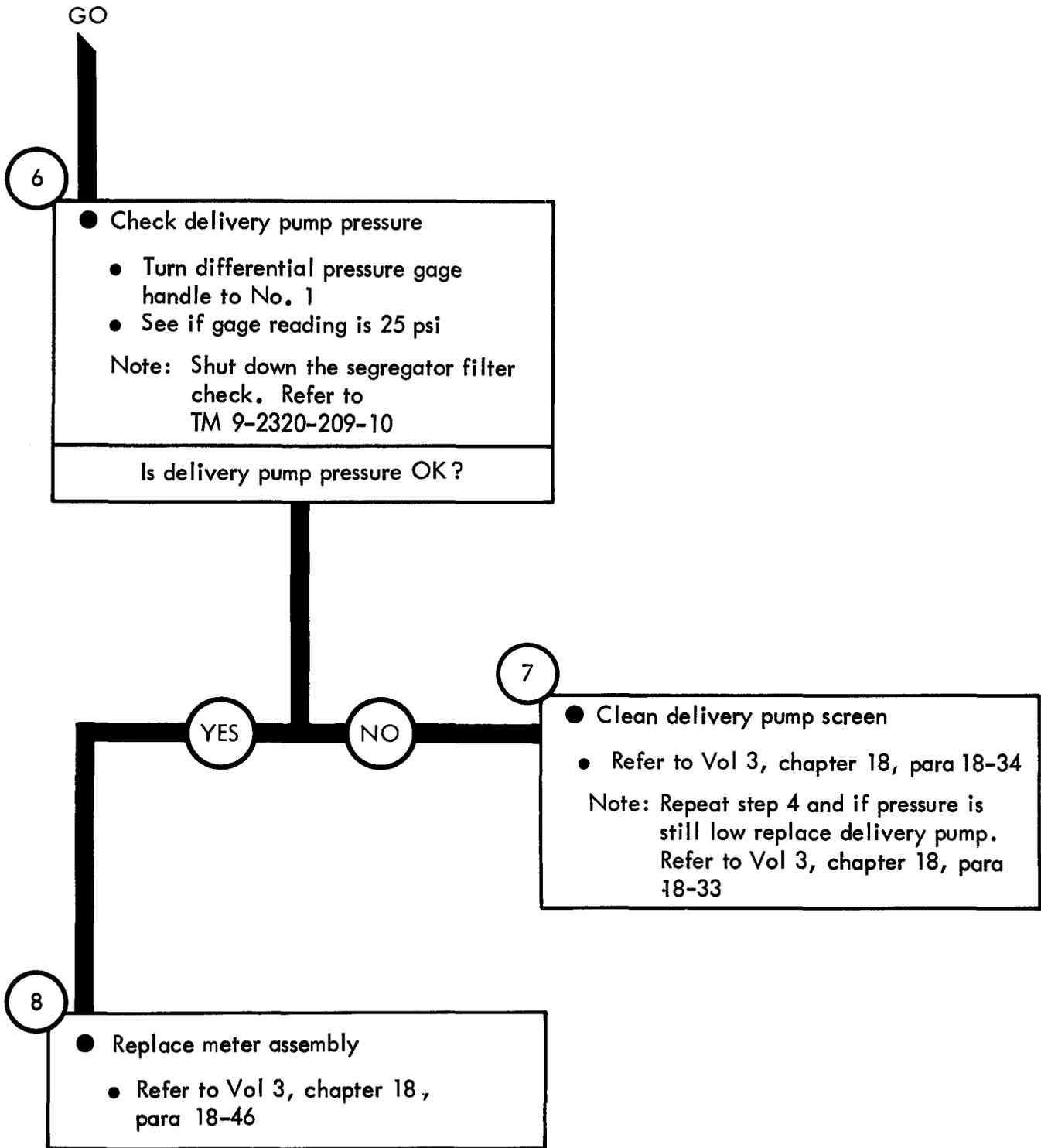

Figure 69-7 (Sheet 2 of 3)



CHAPTER 70

FUEL TANK BODY (TRUCK M49A2C)

TROUBLESHOOTING SUMMARY

70-1. GENERAL. This chapter gives a summary of troubleshooting procedures given in chapter 69 for the fuel tank body (M49A2C).

70-2. PROCEDURES. The summary in this chapter covers all fault symptoms found in the detailed troubleshooting procedures. Chapter 7 outlines a sample troubleshooting procedure. The summary procedures are based on the "what-to-do" portions of the detailed procedures and do not include the "how-to-do-it" instructions. Warnings, cautions, and notes are given where needed.

FUEL TANK BODY, M49A2C TROUBLESHOOTING SUMMARY

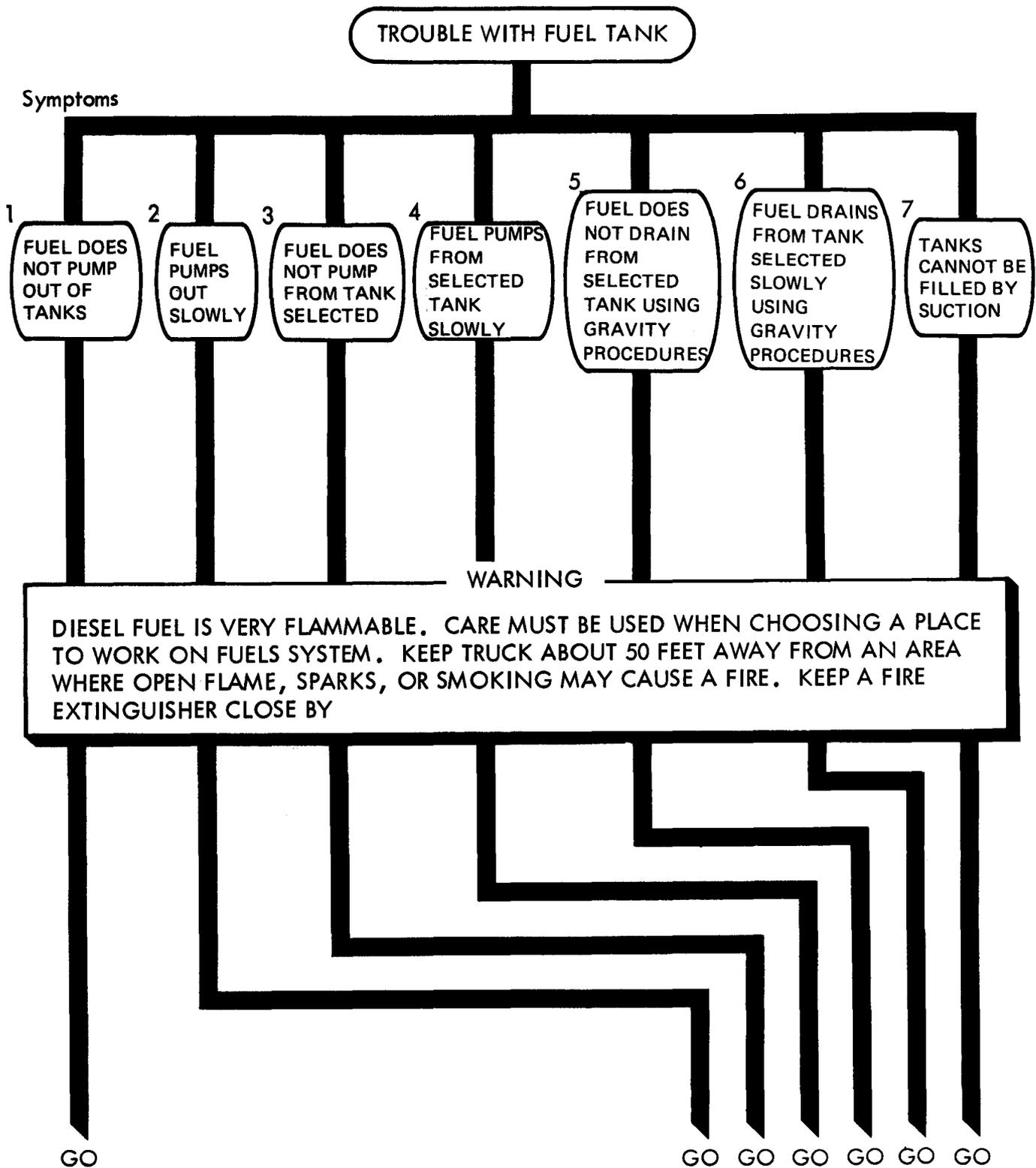
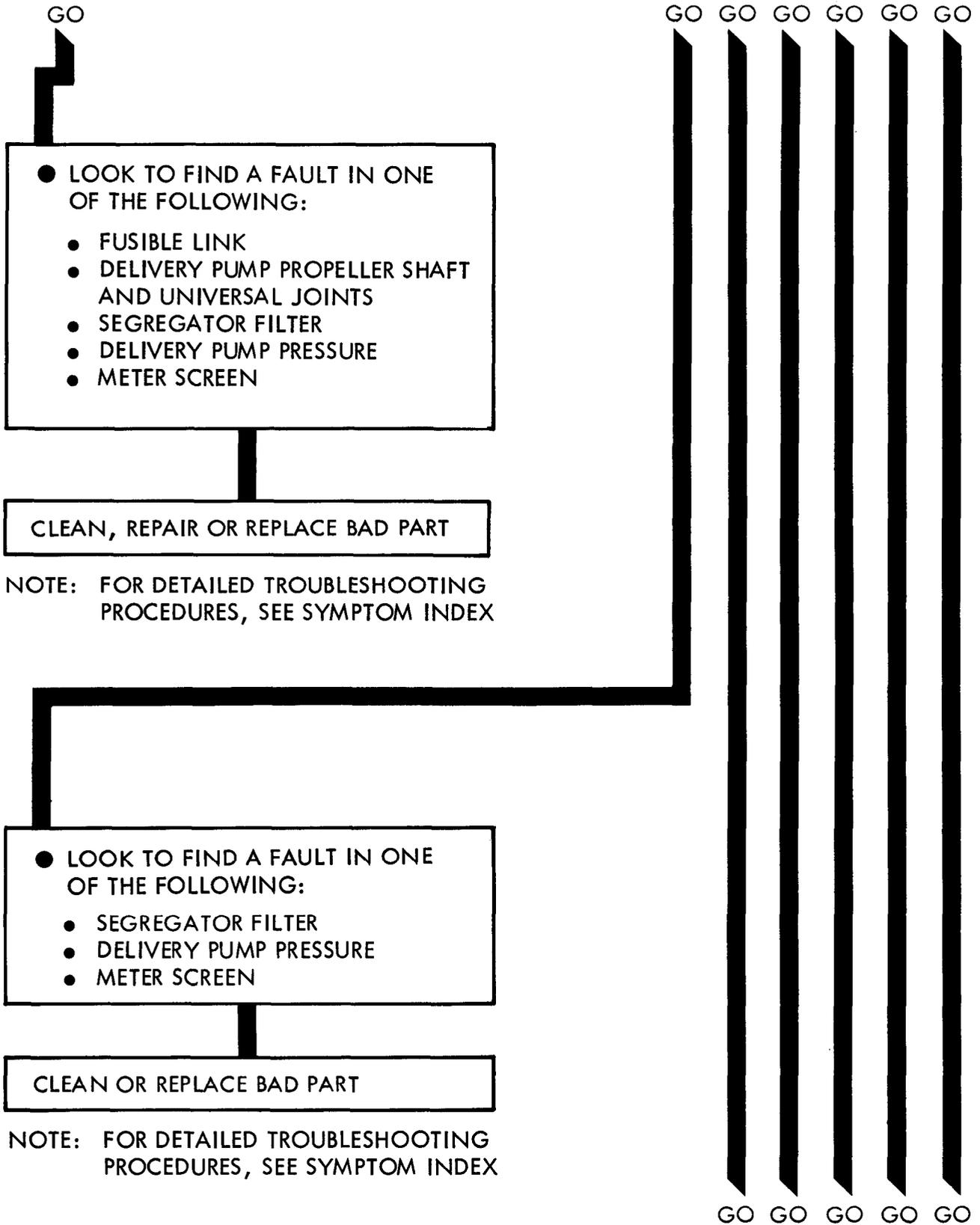
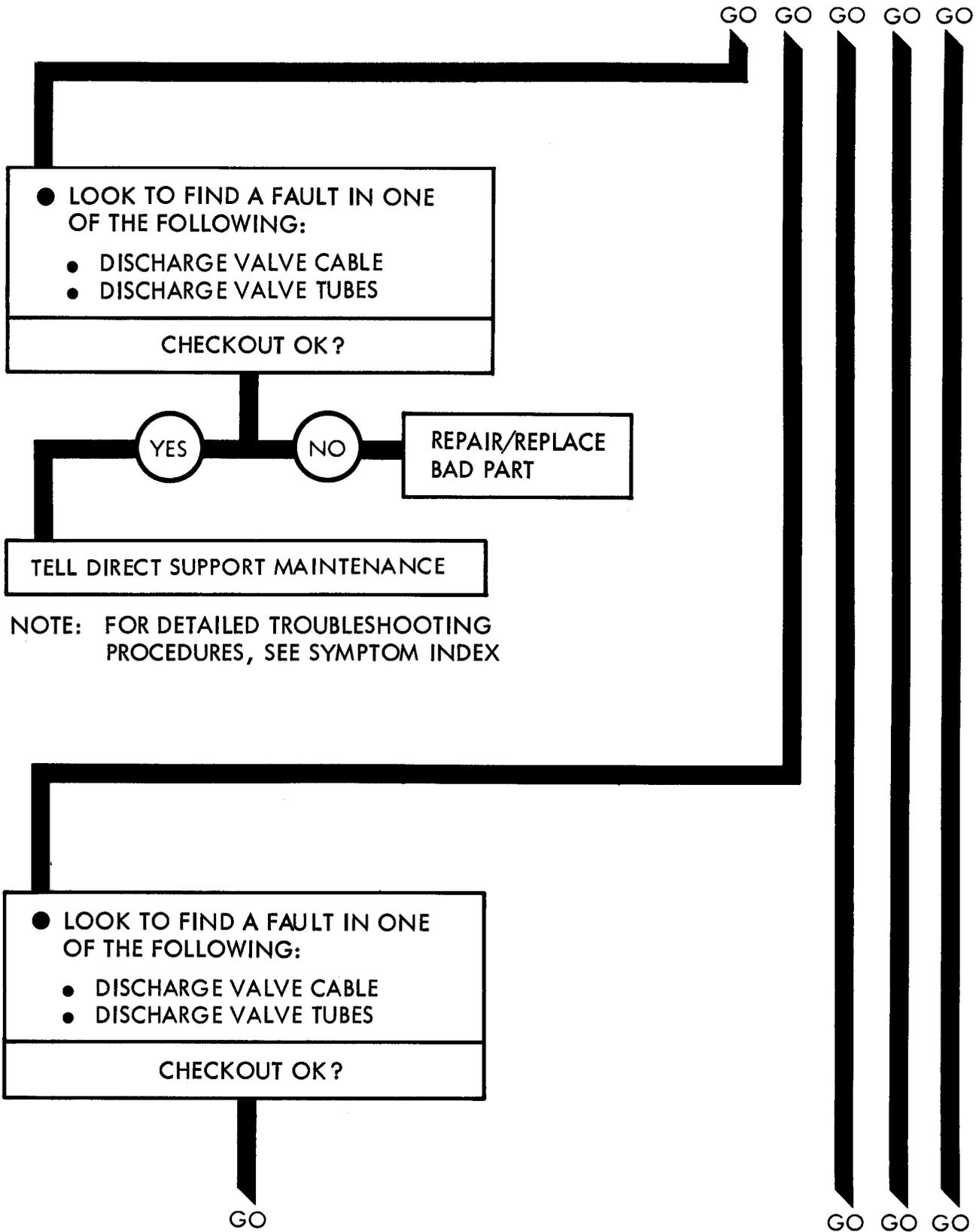

Figure 70-1 (Sheet 1 of 6)



TA 115020

Figure 70-1 (Sheet 2 of 6)



TA 115021

Figure 70-1 (Sheet 3 of 6)

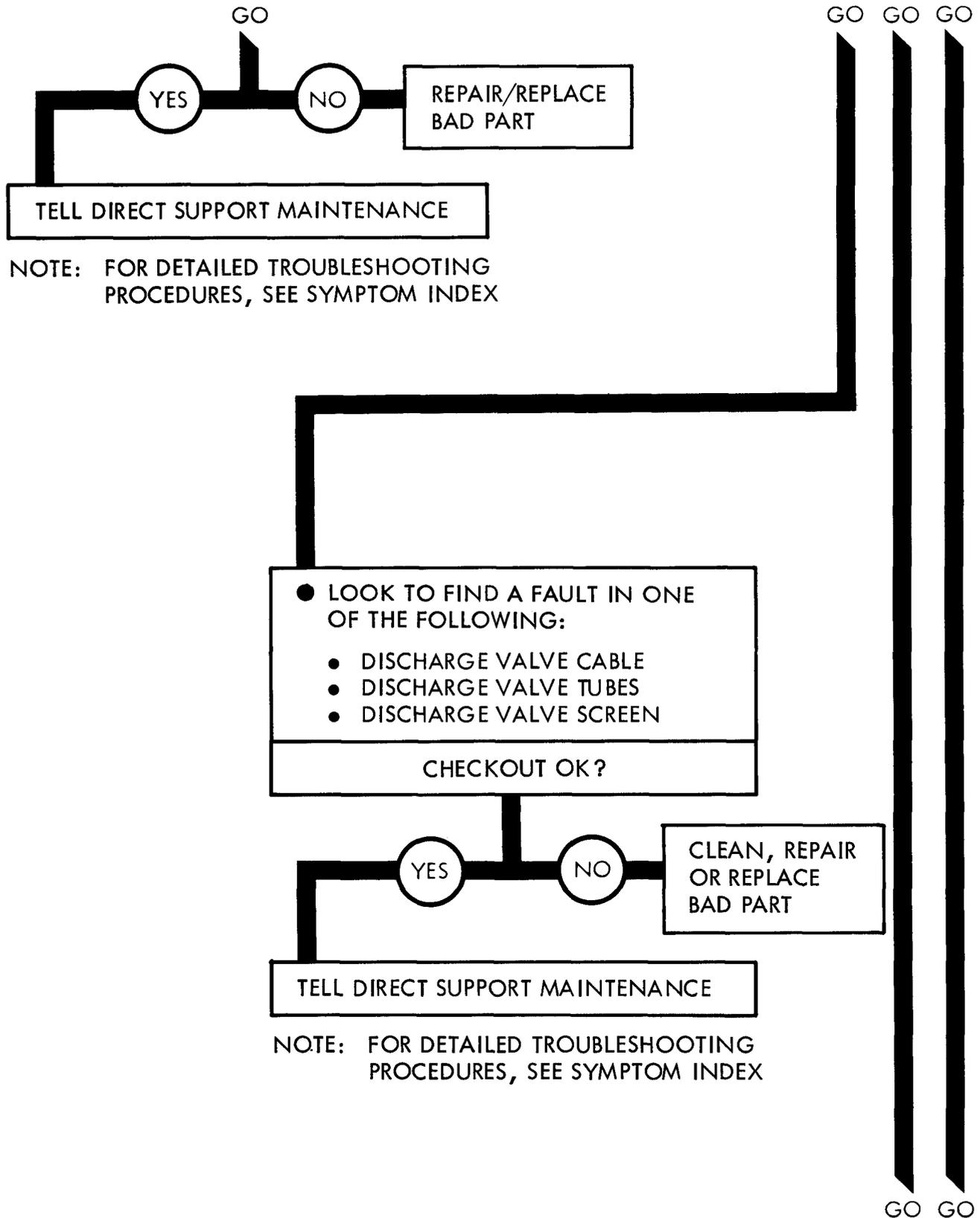

NOTE: FOR DETAILED TROUBLESHOOTING PROCEDURES, SEE SYMPTOM INDEX

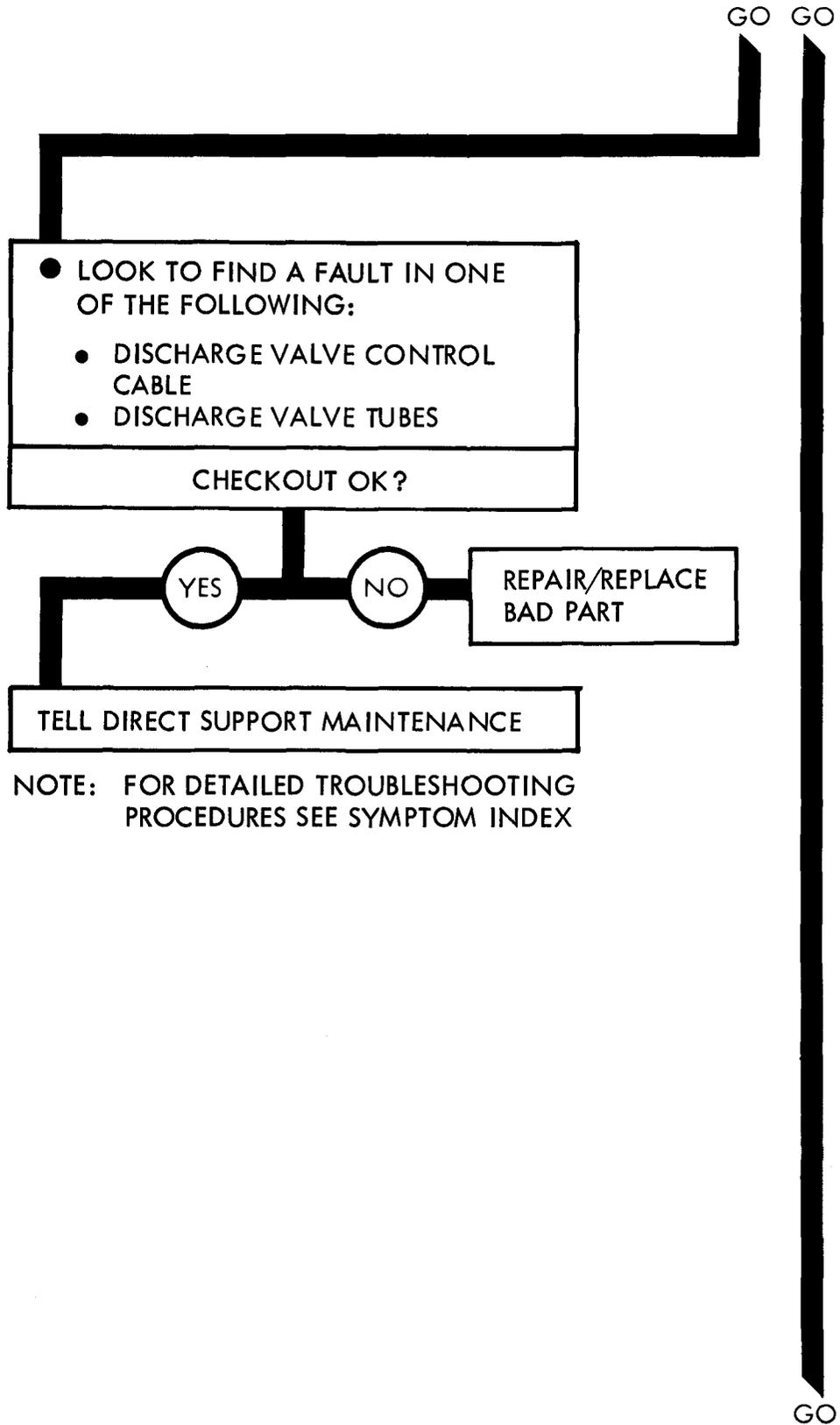

TA 115023

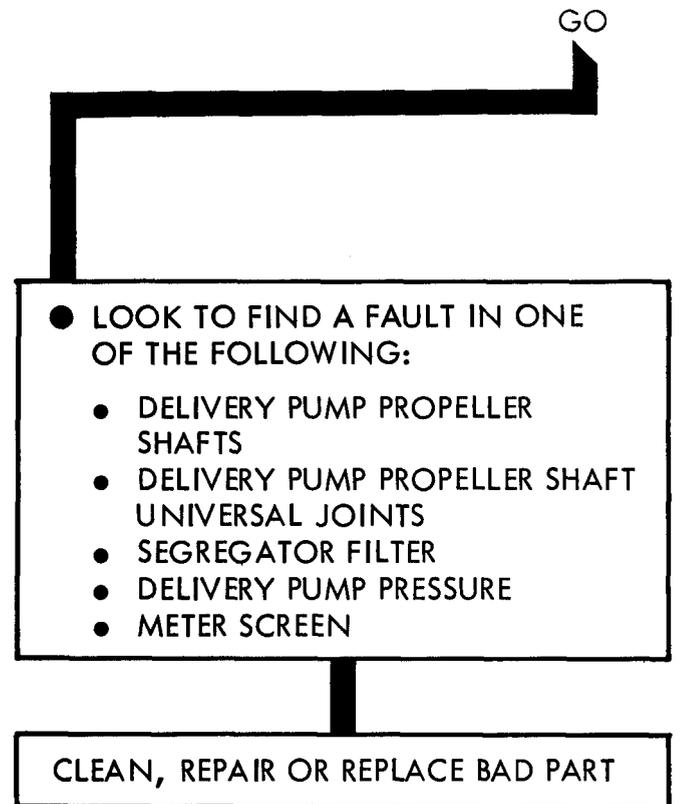

NOTE: FOR DETAILED TROUBLESHOOTING PROCEDURES, SEE SYMPTOM INDEX

CHAPTER 71

FUEL TANK BODY (TRUCK M49A2C) SUPPORT DIAGRAMS

71-1. GENERAL. This chapter gives the diagrams you need when doing troubleshooting procedures in chapter 69. Table 3-1 is a complete listing of all support diagrams used in this manual.

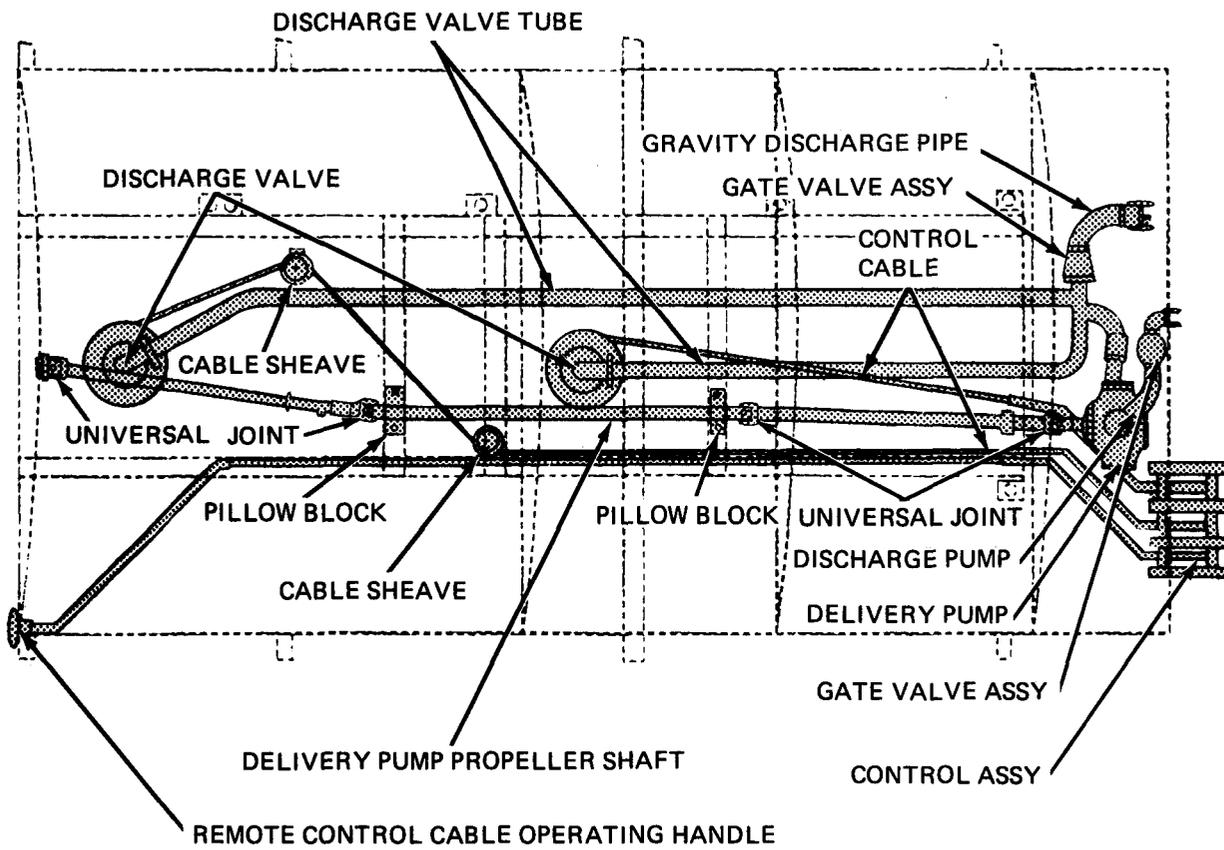

TA 115025

Figure 71-1. Fuel Tank Body (M49A2C) Support Diagram

CHAPTER 72

FUEL TANK BODY (TRUCK M49A2C) CHECKOUT PROCEDURES

72-1. GENERAL. This chapter gives procedures for checking out the system after troubleshooting and repair have been done. Procedures are set up in flow chart form showing the checkout steps in order and referring to the fault symptom index when the system does not check out.

FUEL TANK BODY, M49A2C CHECKOUT

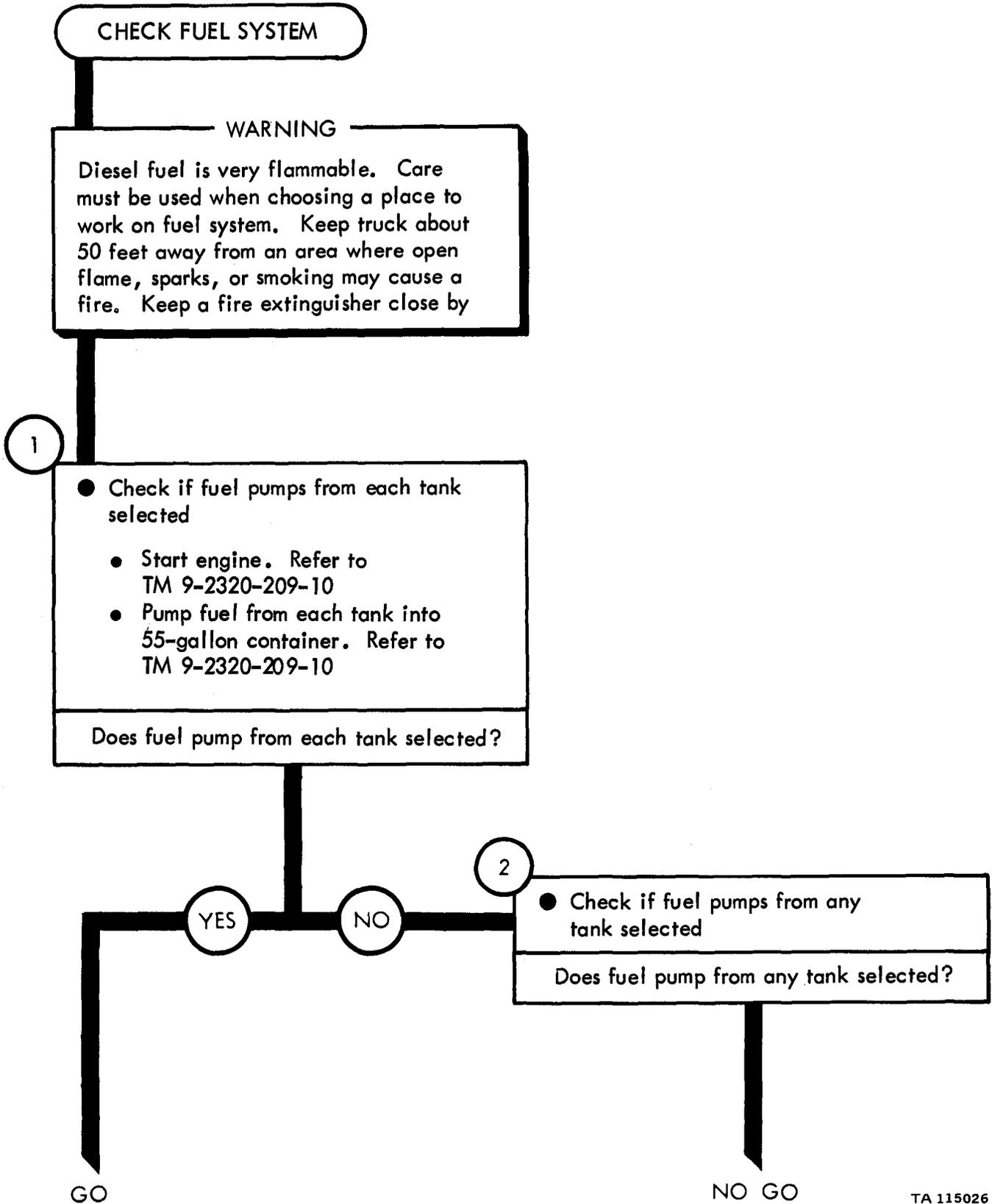
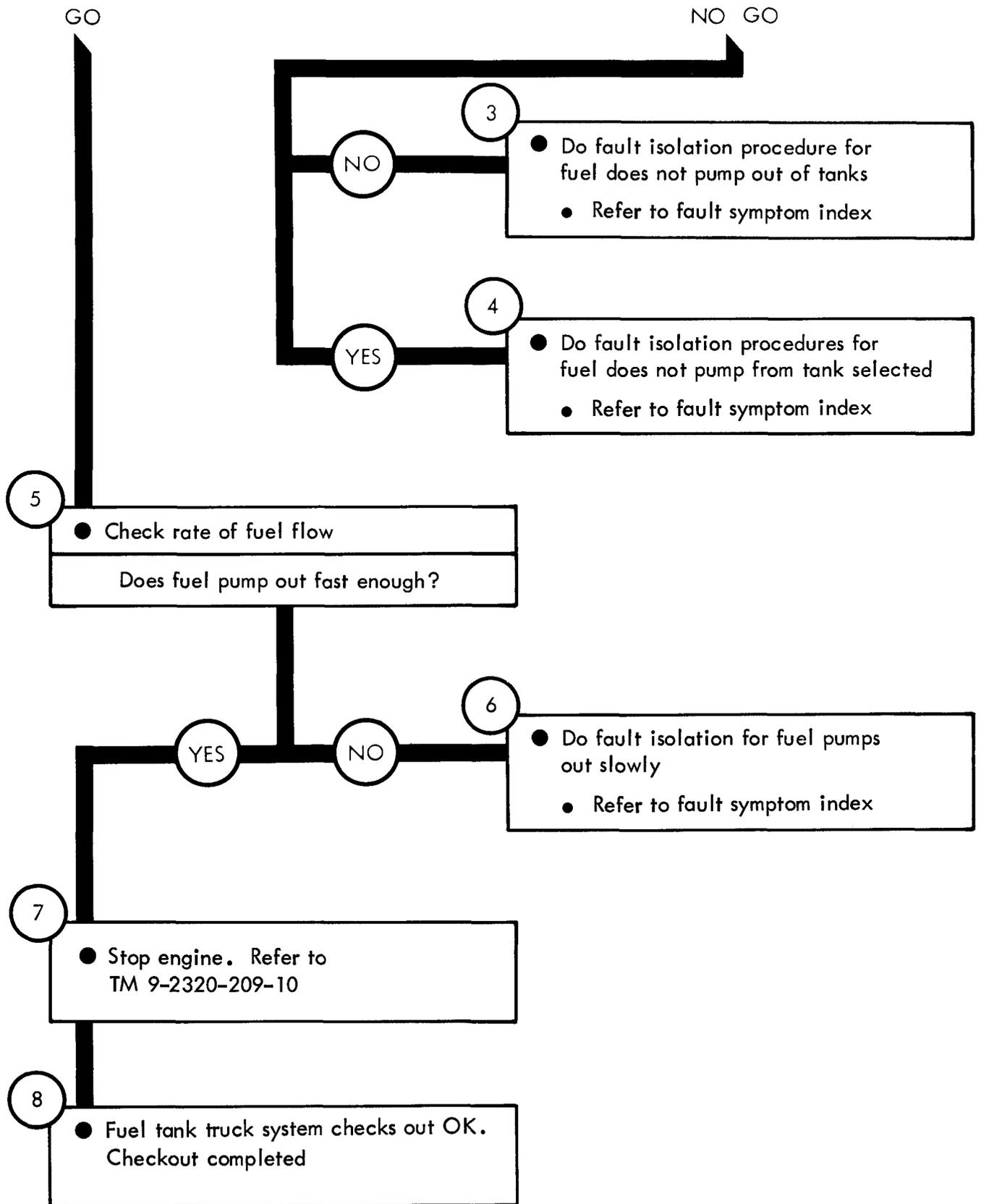

Figure 72-1 (Sheet 1 of 2)



TA 115027

Figure 72-1 (Sheet 2 of 2)

CHAPTER 73

EARTH BORING MACHINE TROUBLESHOOTING

73-1. EQUIPMENT ITEMS COVERED. This chapter gives equipment troubleshooting procedures for the earth boring machine M764, for which there are authorized corrective maintenance tasks at the organizational maintenance level.

73-2. EQUIPMENT ITEMS NOT COVERED. All equipment items for which corrective maintenance is authorized at the organizational maintenance level are covered in this chapter.

EARTH BORING MACHINE, M764 TROUBLESHOOTING

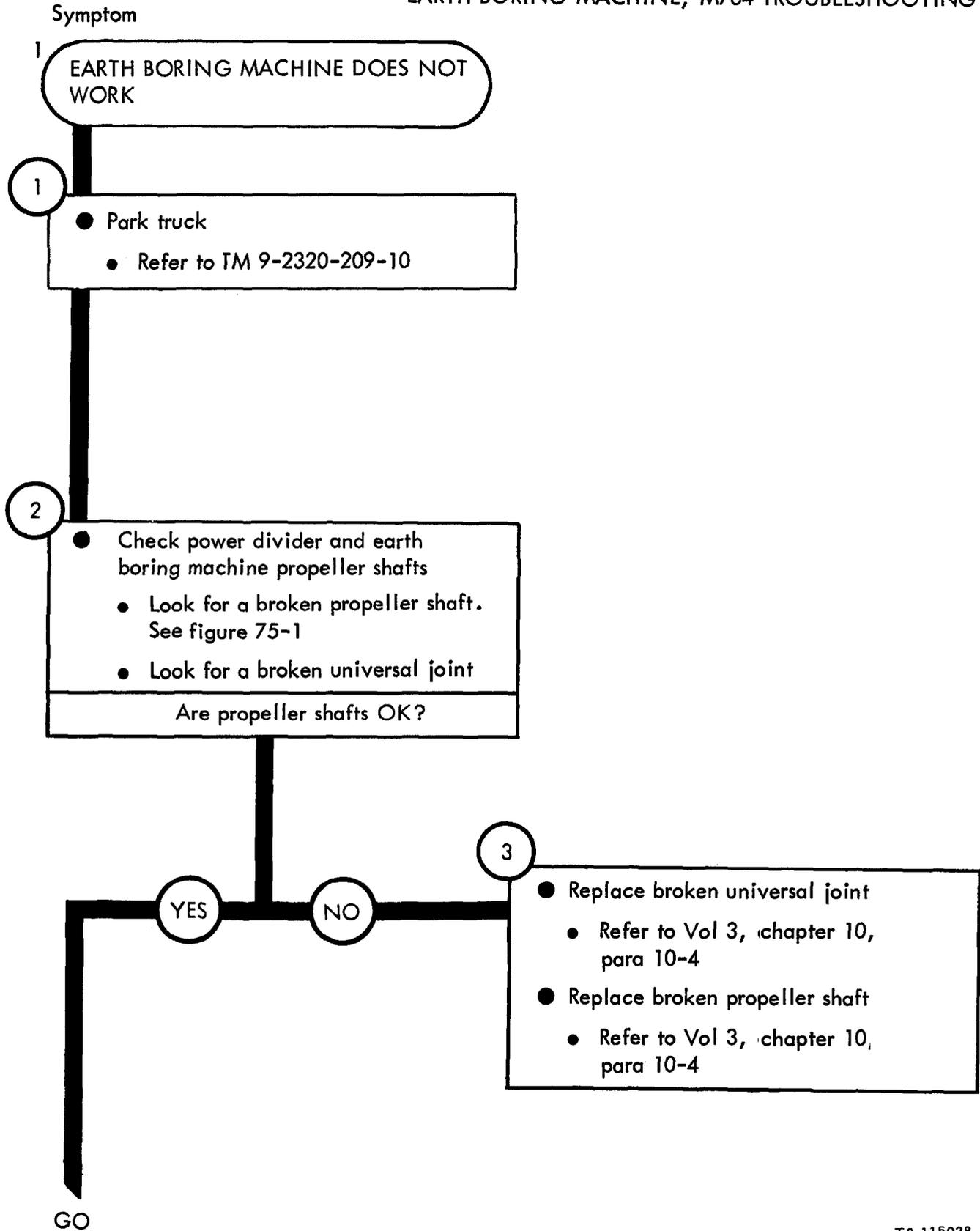

TA 115028

Figure 73-1 (Sheet 1 of 2)

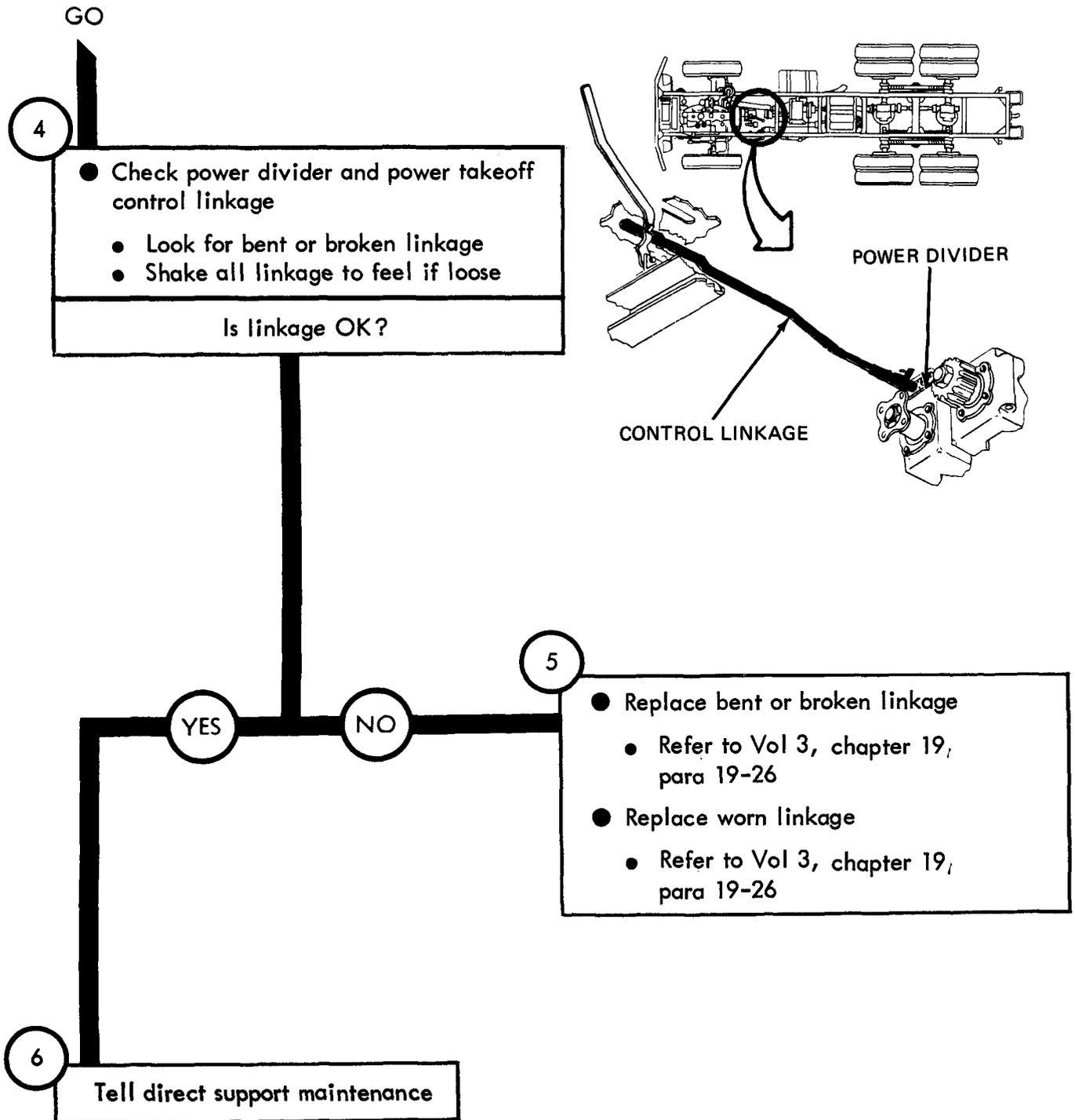

TA 115029

Figure 73-1 (Sheet 2 of 2)

Symptom

2 EARTH BORING MACHINE CANNOT BE MOVED VERTICALLY

1

- Stop earth boring operations
- Refer to TM 9-2320-209-10

2

- Check vertical drive chains
- Remove chain cover. Refer to Vol 3, chapter 18, para 18-79
- Look for a broken chain

Are drive chains OK?

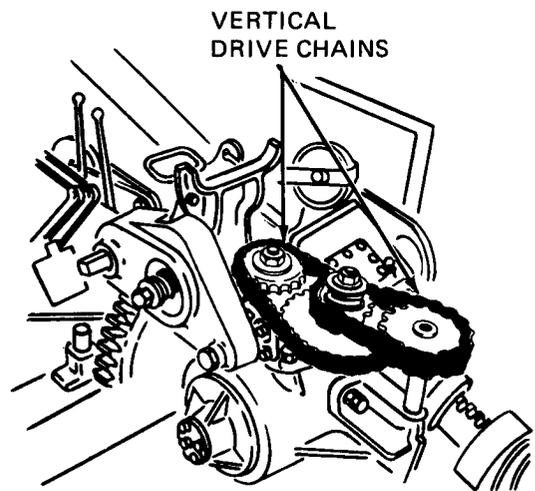

YES

NO

3

- Replace broken drive chains
- Refer to Vol 3, chapter 18, para 18-79

GO

Figure 73-2 (Sheet 1 of 2)

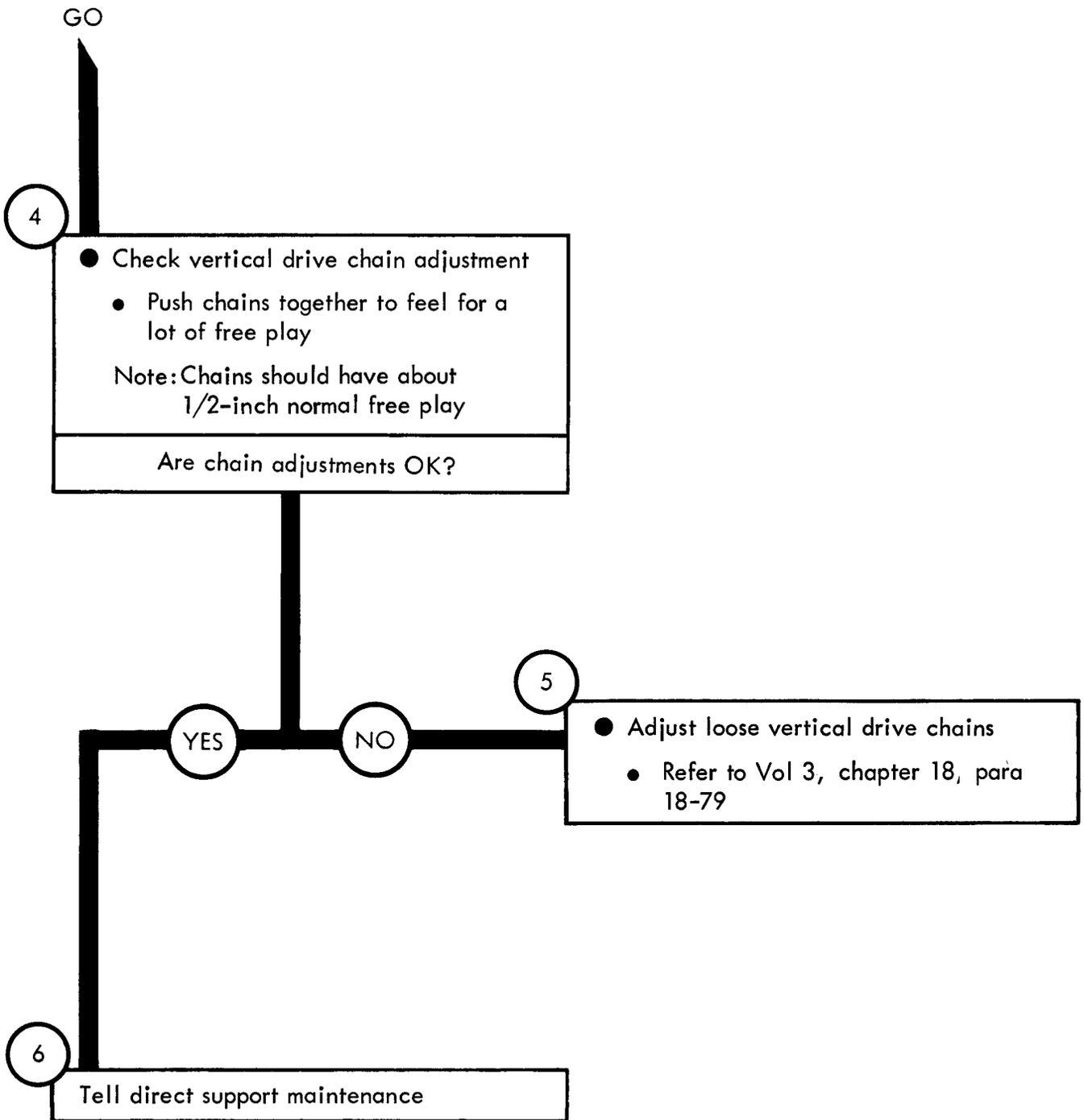

Figure 73-2 (Sheet 2 of 2)

Symptom

3 EARTH BORING MACHINE CANNOT BE MOVED HORIZONTALLY

1

- Stop earth boring operations
- Refer to TM 9-2320-209-10

2

- Check horizontal drive chains
- Remove chain cover. Refer to Vol 3, chapter 18, para 18-78
- Look for a broken chain

Are drive chains OK?

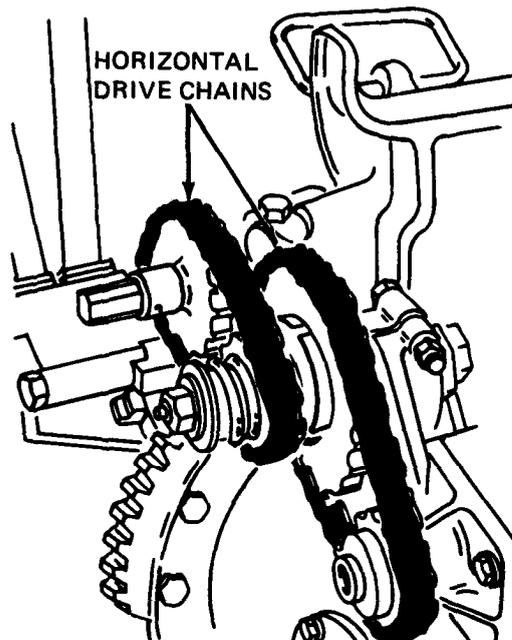

YES

NO

3

- Replace broken drive chains
- Refer to Vol 3, chapter 18, para 18-78

GO

Figure 73-3 (Sheet 1 of 2)

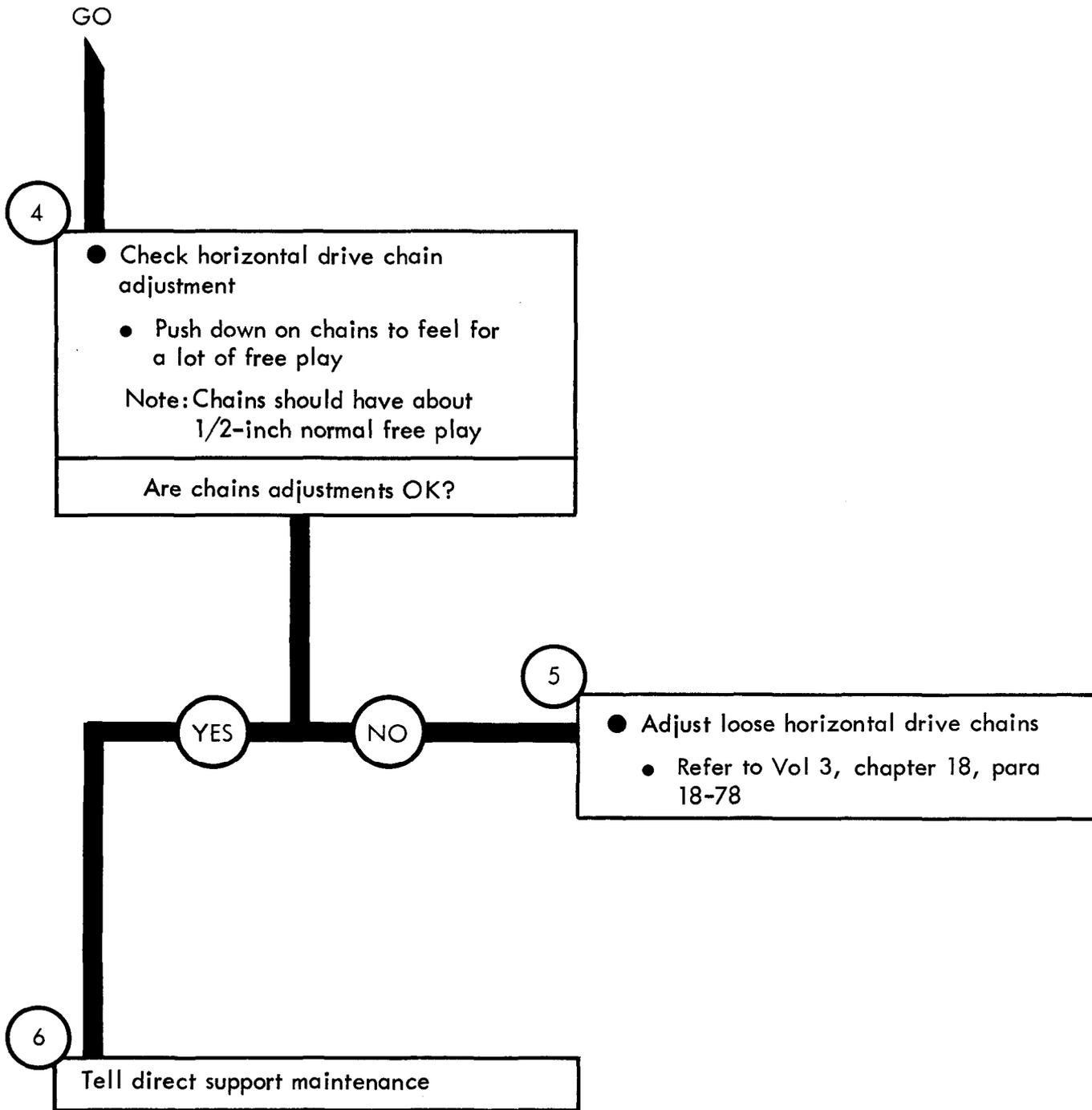

Figure 73-3 (Sheet 2 of 2)

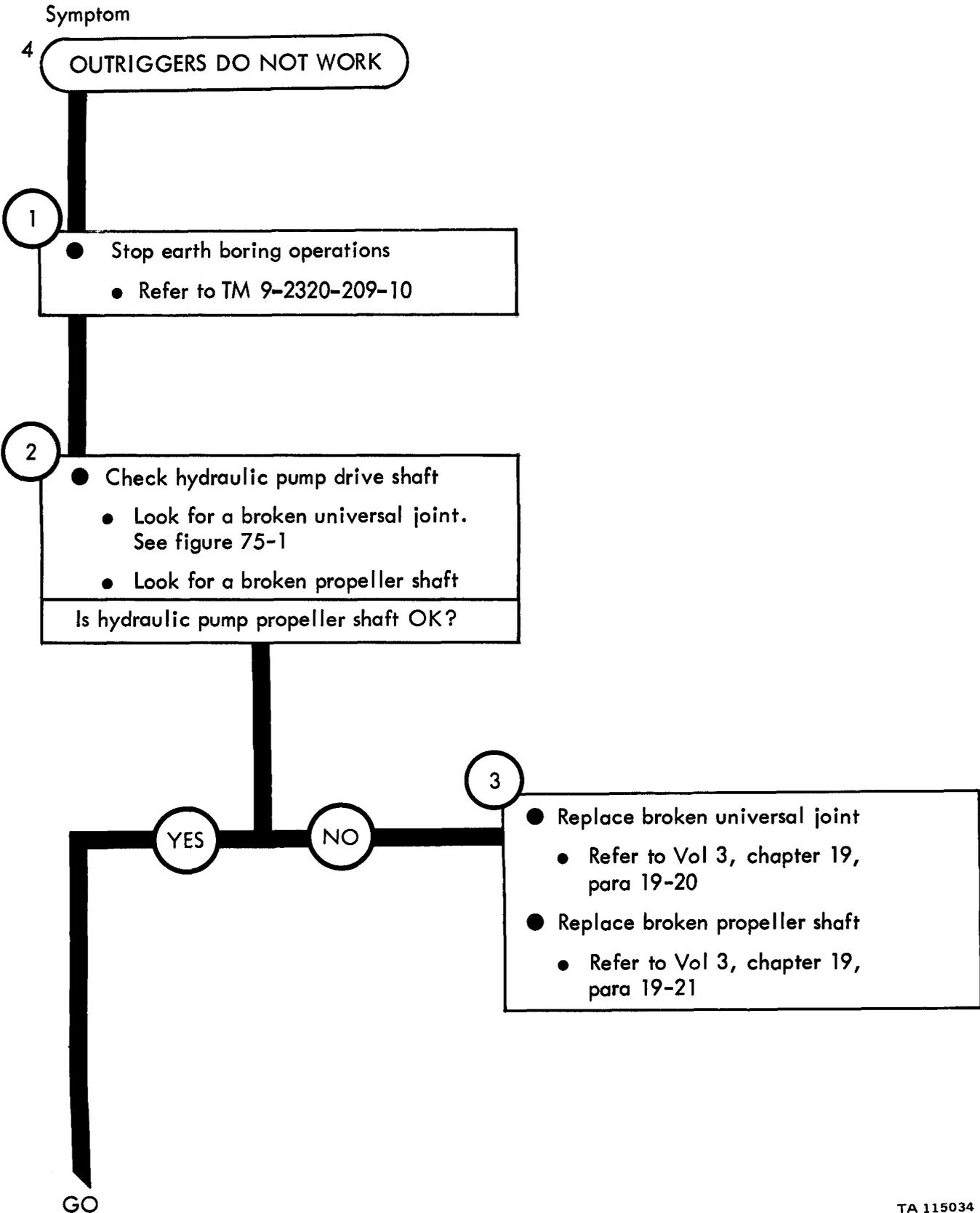
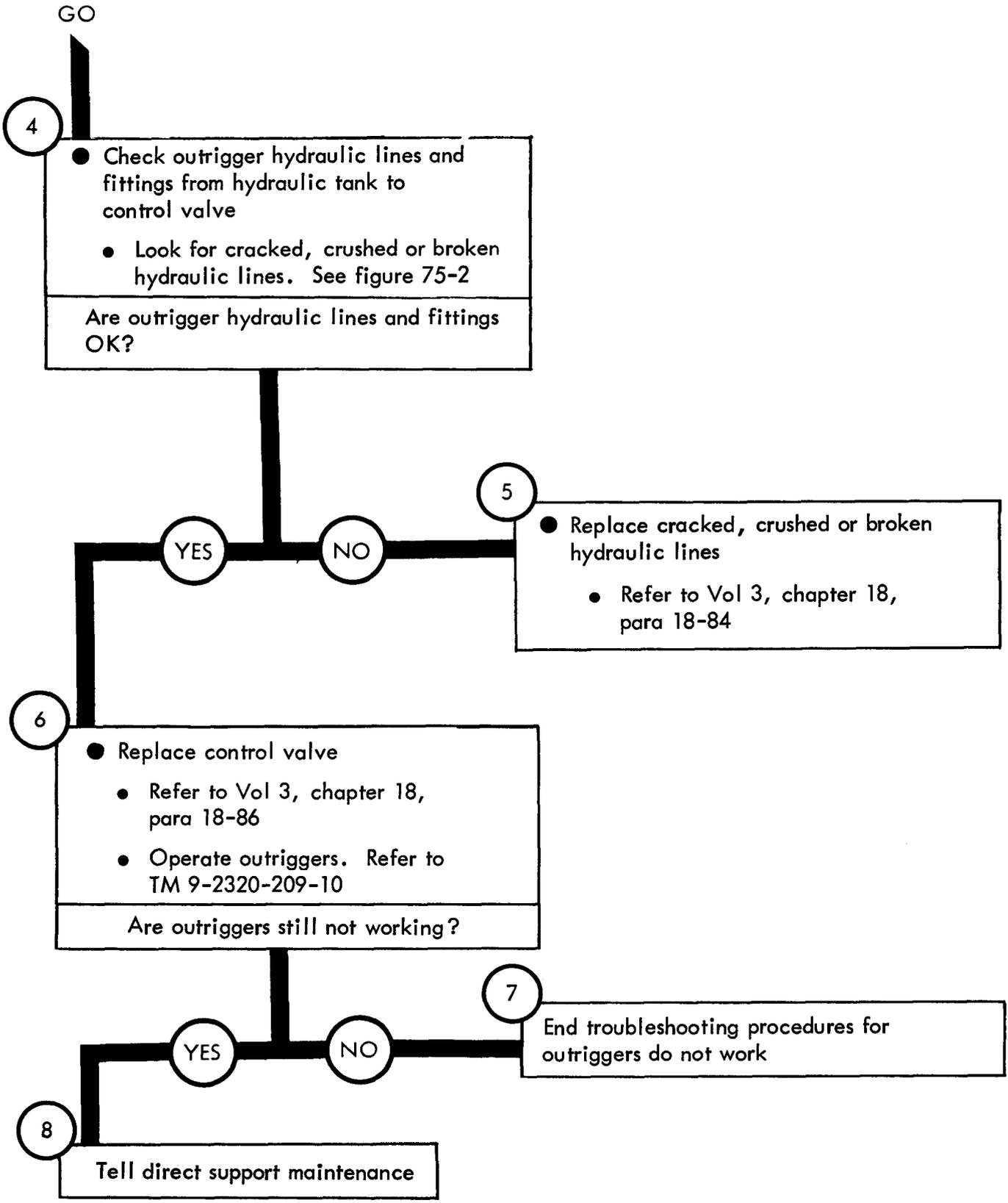
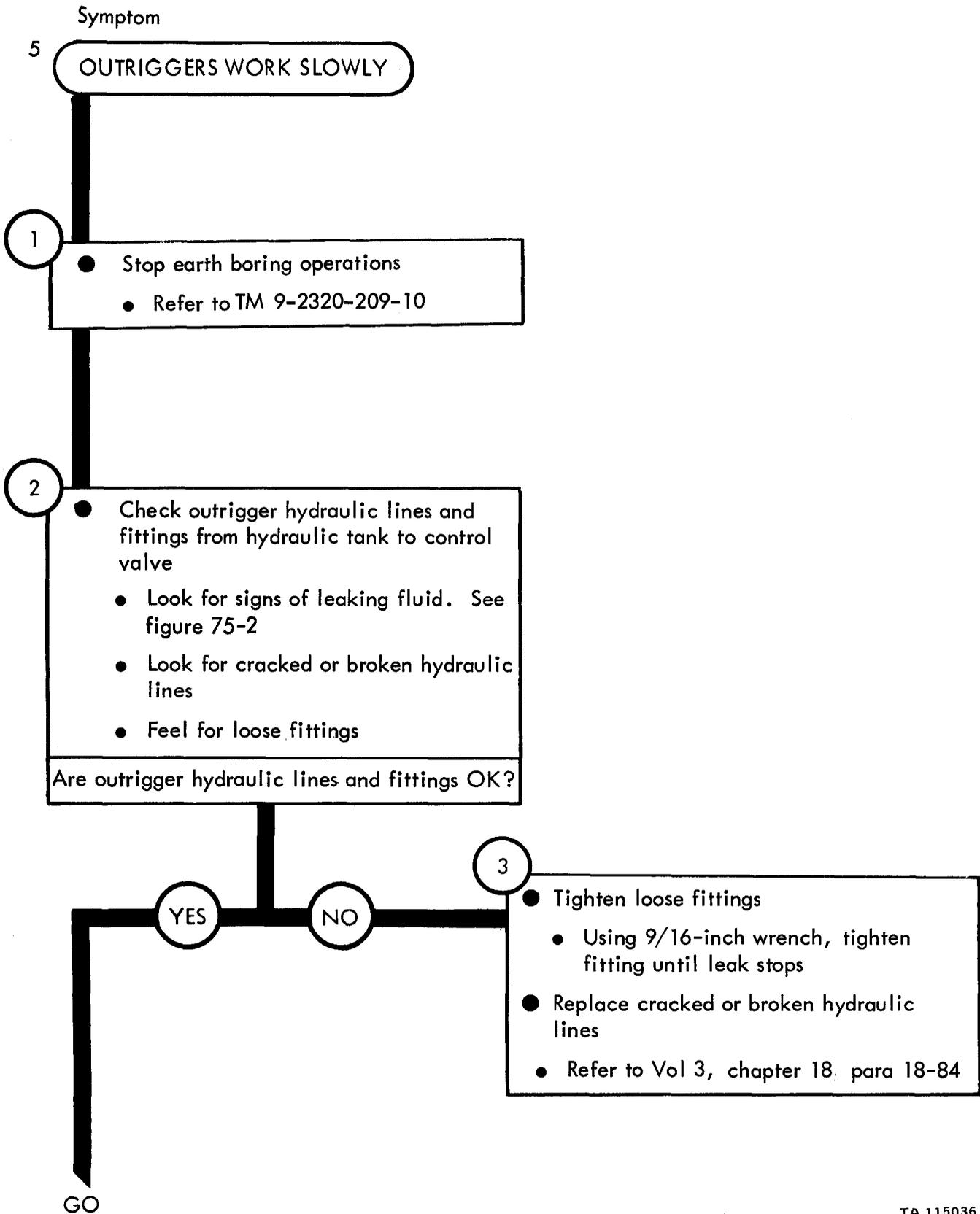

Figure 73-4 (Sheet 1 of 2)





TA 115036

Figure 73-5 (Sheet 1 of 2)

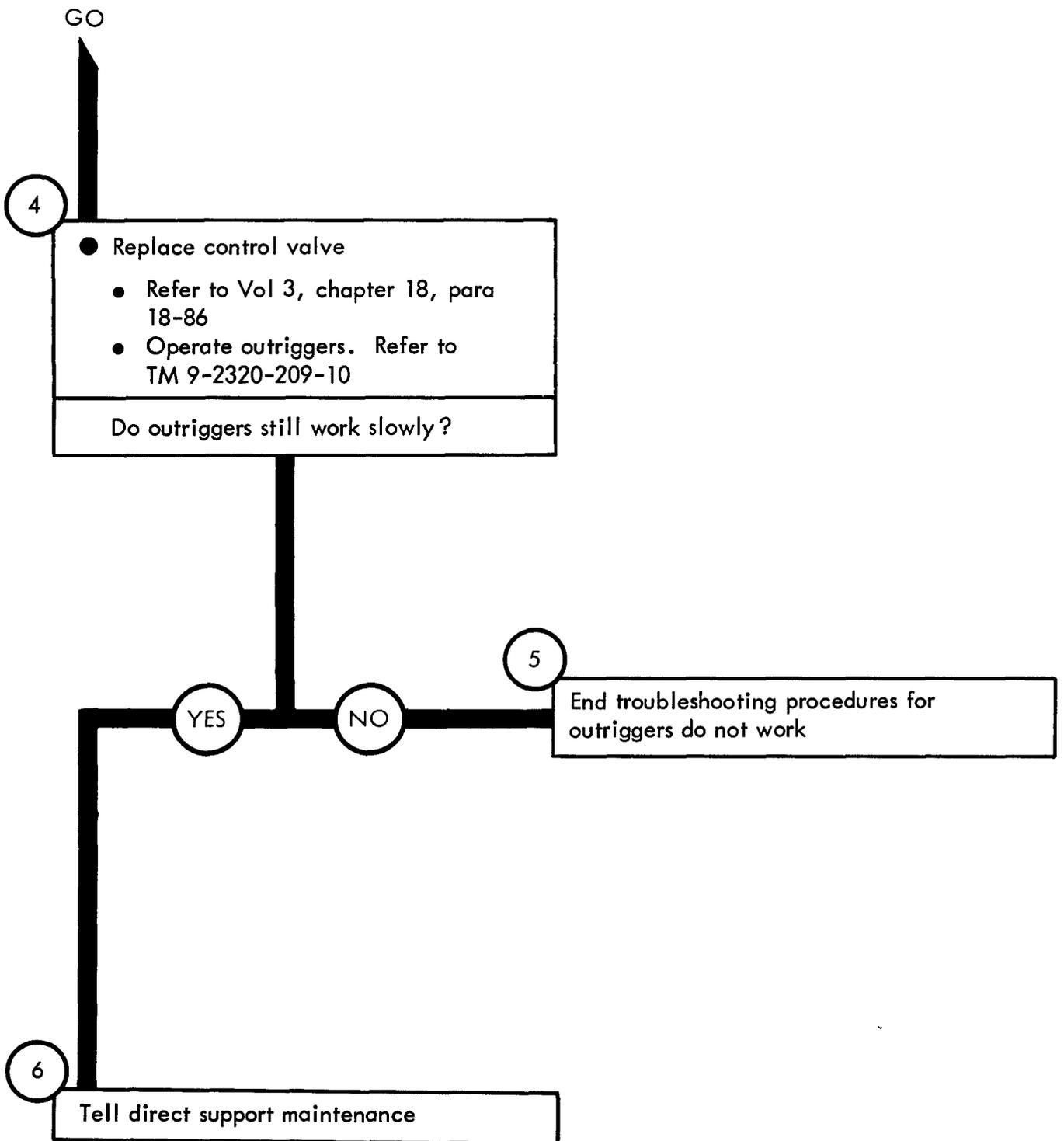

Figure 73-5 (Sheet 2 of 2)

CHAPTER 74

EARTH BORING MACHINE TROUBLESHOOTING SUMMARY

74-1. GENERAL. This chapter gives a summary of troubleshooting procedures given in chapter 73 for the earth boring machine (M764).

74-2. PROCEDURES. The summary in this chapter covers all fault symptoms found in the detailed troubleshooting procedures. Chapter 7 outlines a sample troubleshooting procedure. The summary procedures are based on the "what-to-do" portions of the detailed procedures and do not include the "how-to-do-it" instructions. Warnings, cautions, and notes are given where needed.

EARTH BORING MACHINE, M764 TROUBLESHOOTING SUMMARY

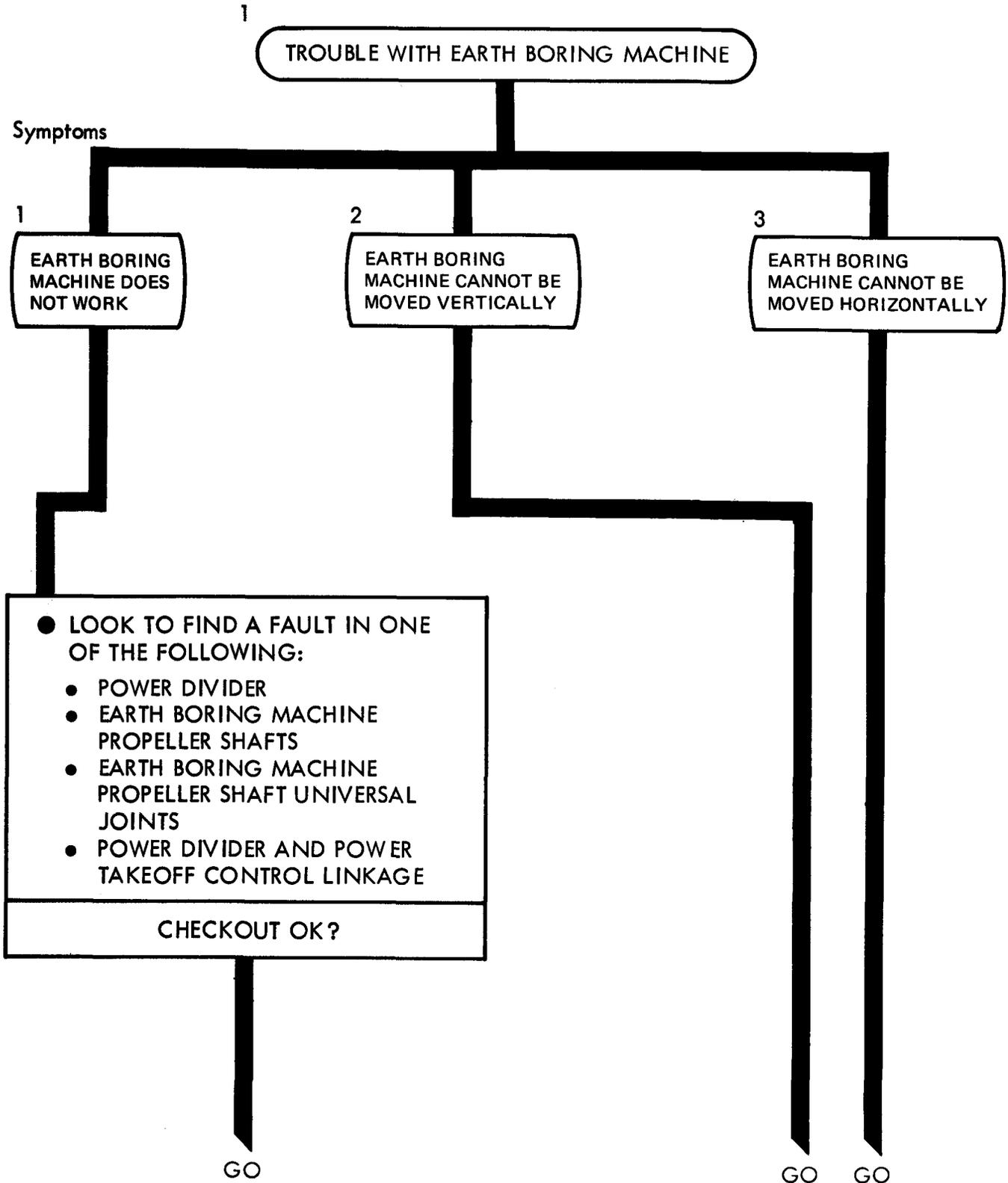

TA 115038

Figure 74-1 (Sheet 1 of 3)

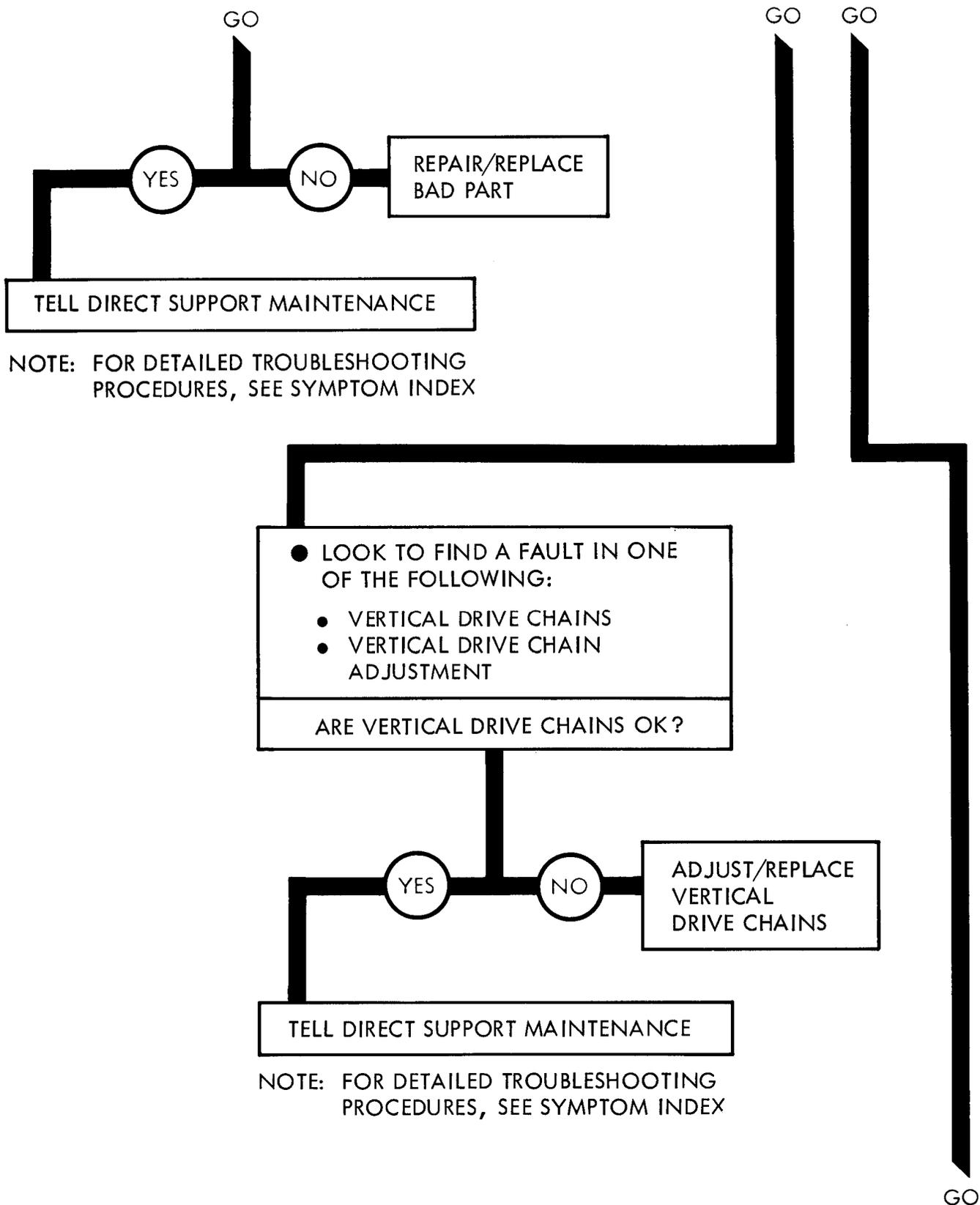
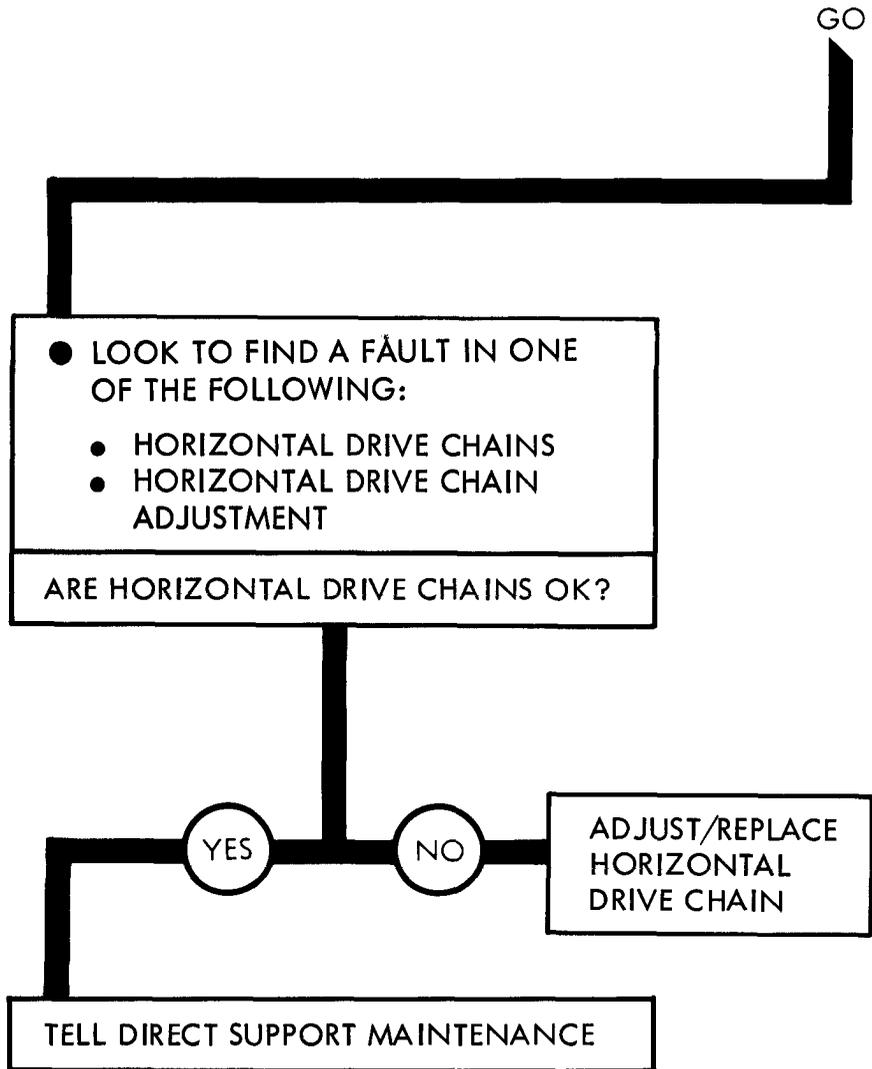

Figure 74-1 (Sheet 2 of 3)



NOTE: FOR DETAILED TROUBLESHOOTING PROCEDURES, SEE SYMPTOM INDEX

Figure 74-1 (Sheet 3 of 3)

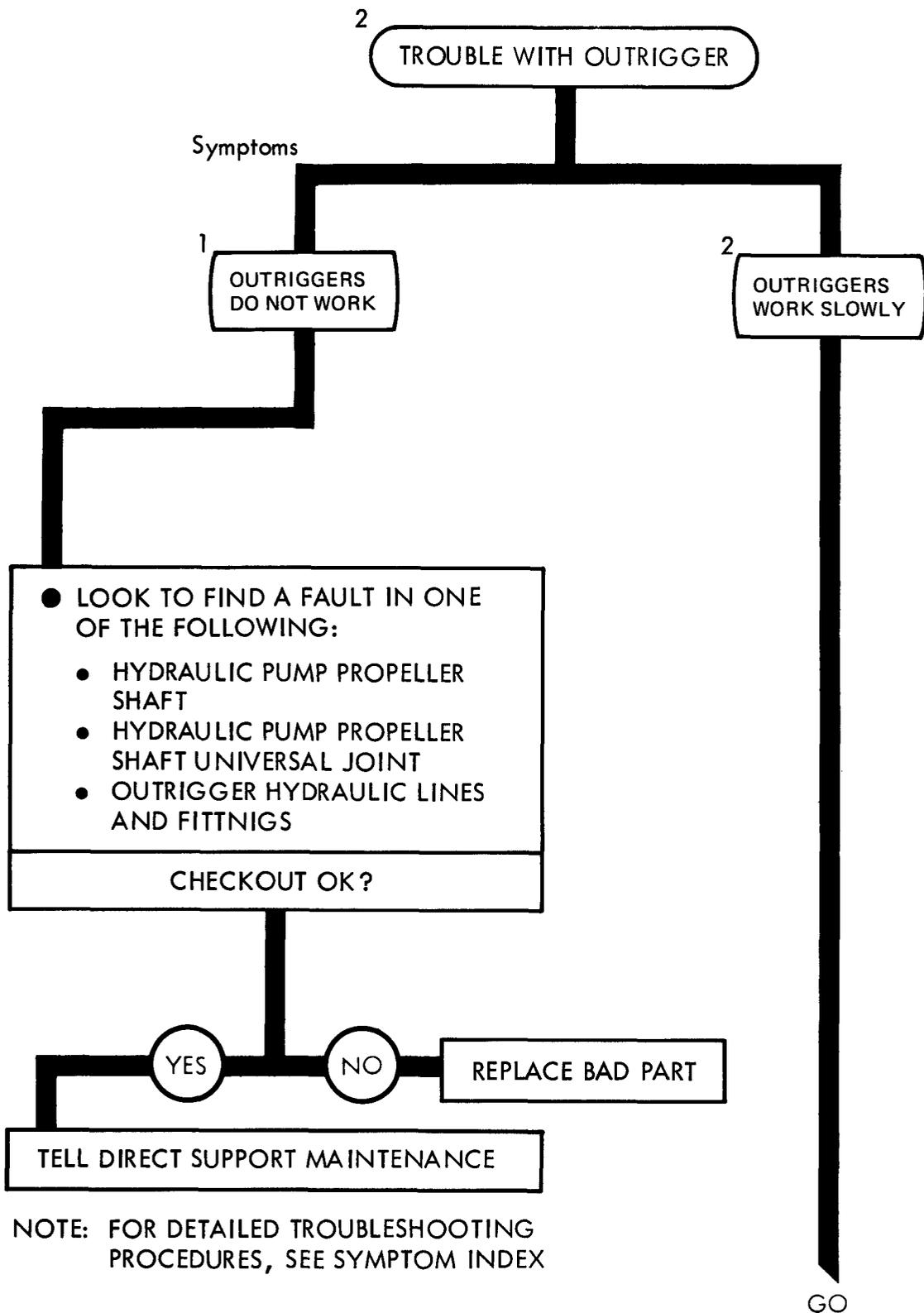
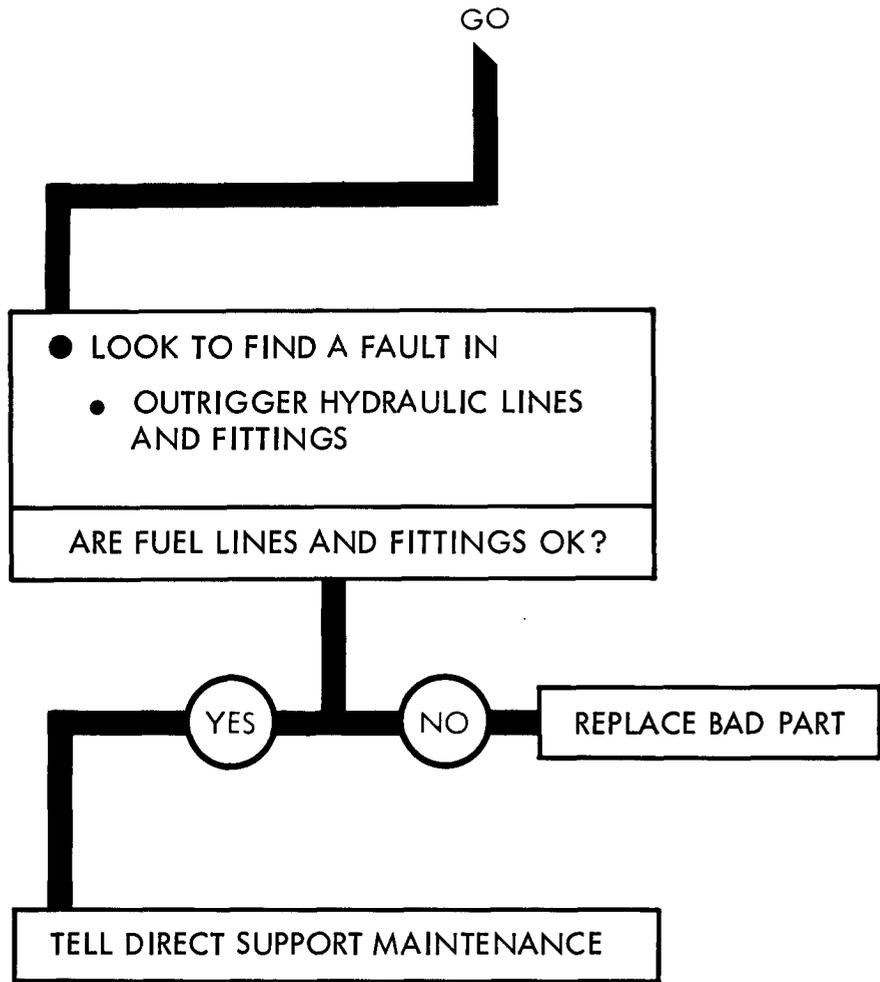

Figure 74-2 (Sheet 1 of 2)



NOTE: FOR DETAILED TROUBLESHOOTING PROCEDURES, SEE SYMPTOM INDEX

Figure 74-2 (Sheet 2 of 2)

CHAPTER 75

EARTH BORING MACHINE SUPPORT DIAGRAMS

75-1. GENERAL. This chapter gives the diagrams you need when doing troubleshooting procedures in chapter 73. Table 3-1 is a complete listing of all support diagrams used in this manual.

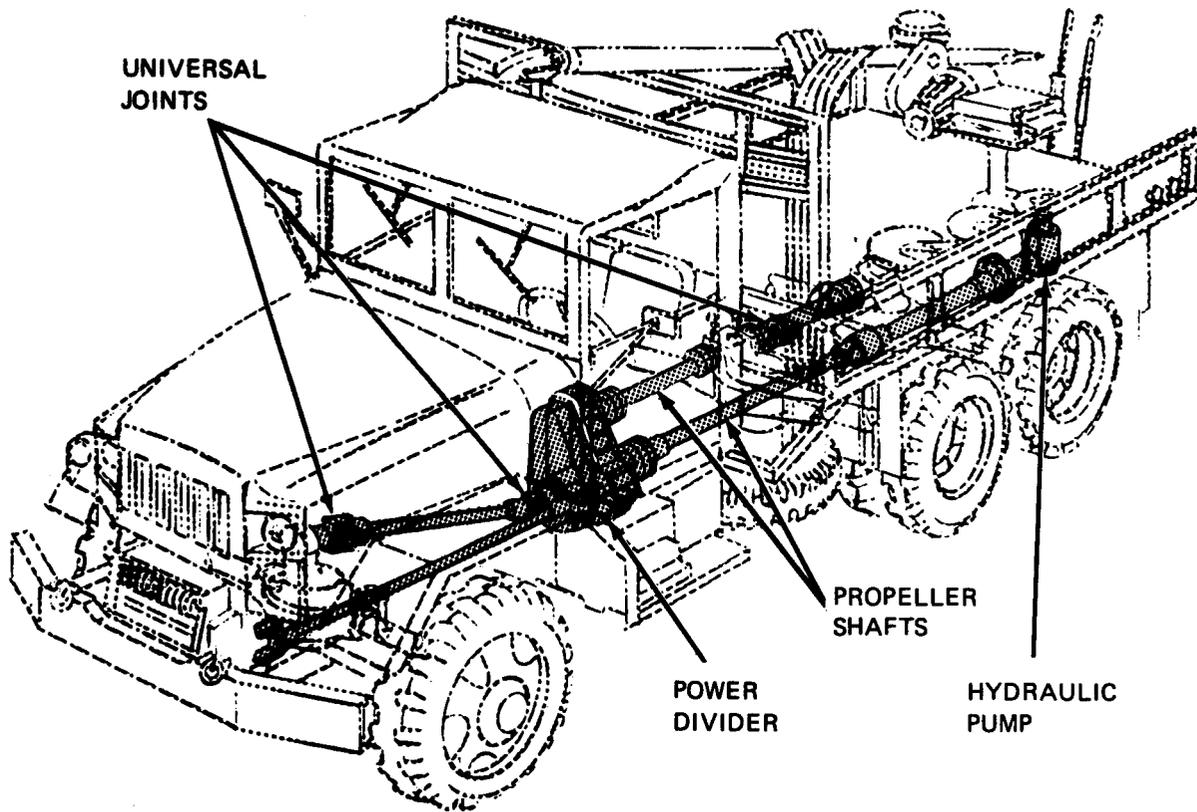

TA 115043

Figure 75-1. Earth Boring Machine (M764) Support Diagram

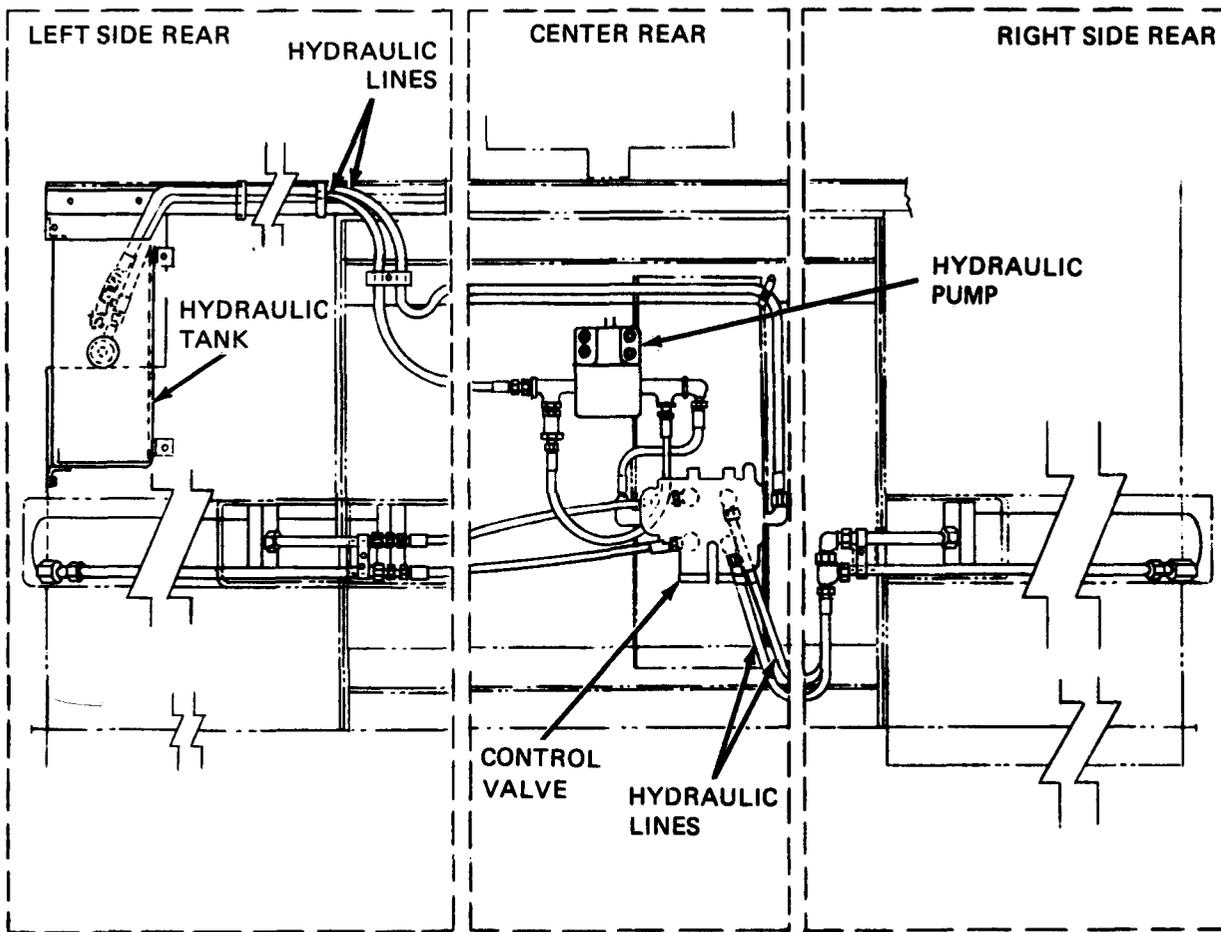

TA 115044

Figure 75-2. Earth Boring Machine (M764) Support Diagram

CHAPTER 76

EARTH BORING MACHINE CHECKOUT PROCEDURES

76-1. GENERAL. This chapter gives procedures for checking out the system after troubleshooting and repair have been done. Procedures are set up in flow chart form showing the checkout steps in order and referring to the fault symptom index when the system does not checkout.

EARTH BORING MACHINE, M764 CHECKOUT

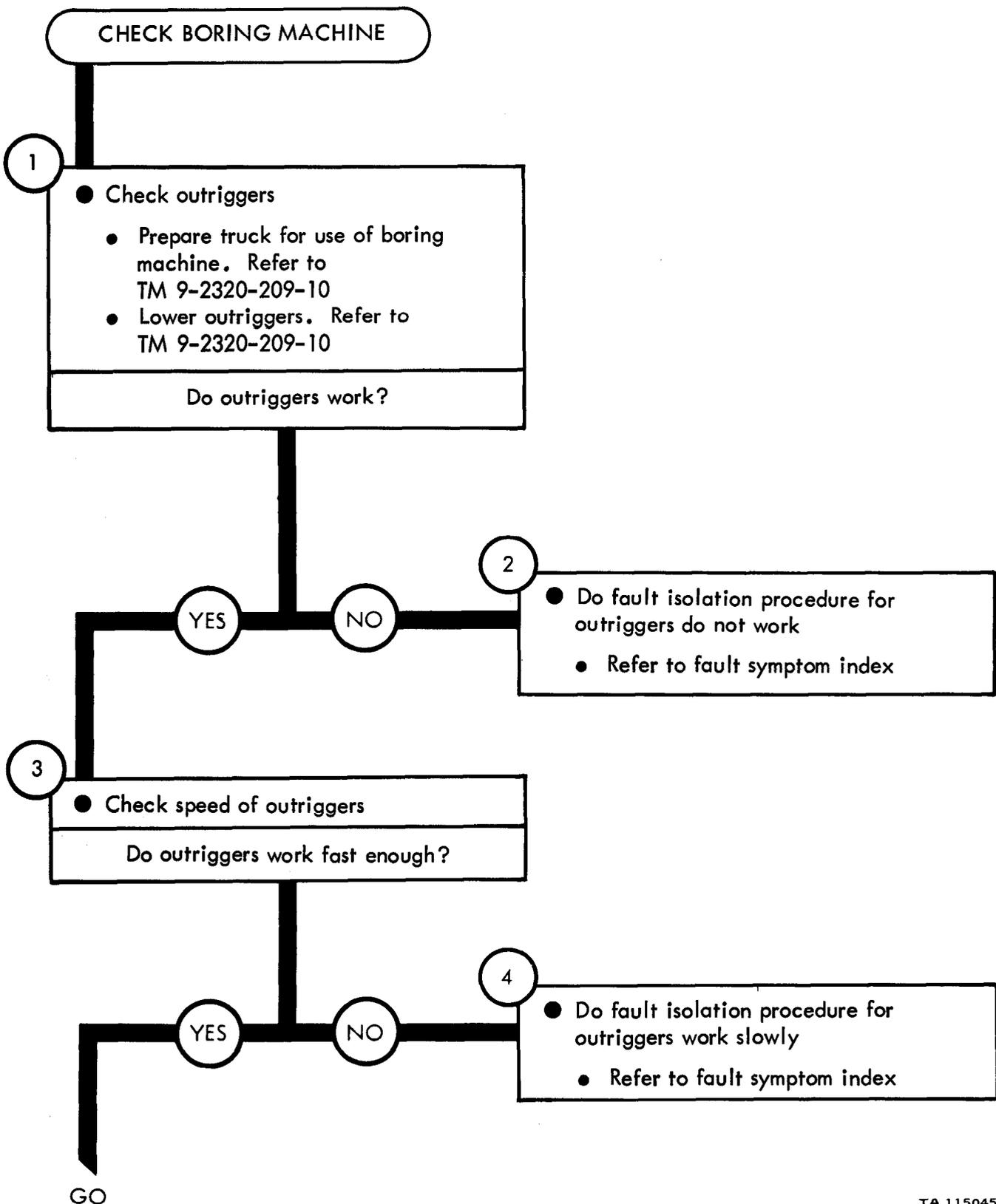

Figure 76-1 (Sheet 1 of 3)

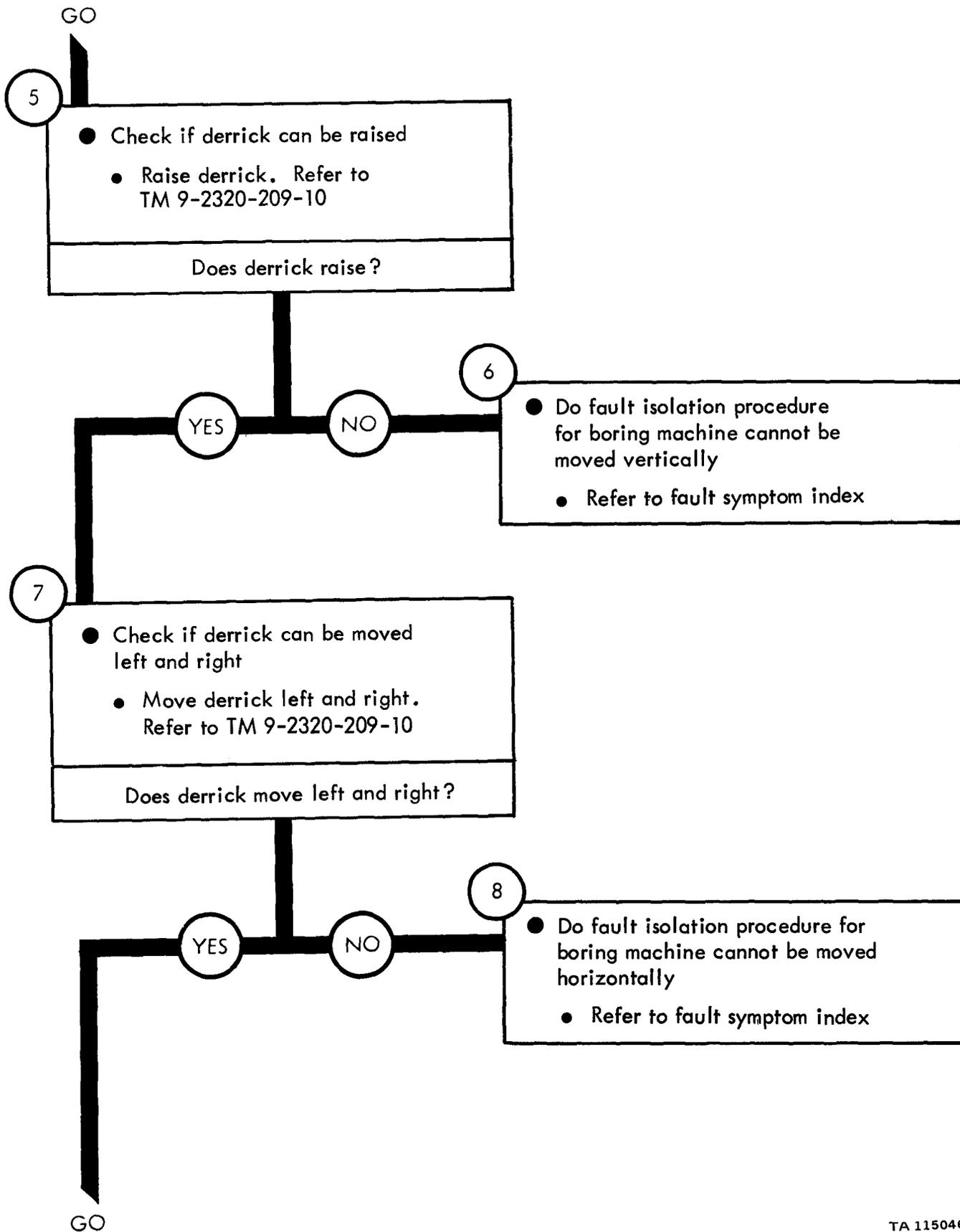
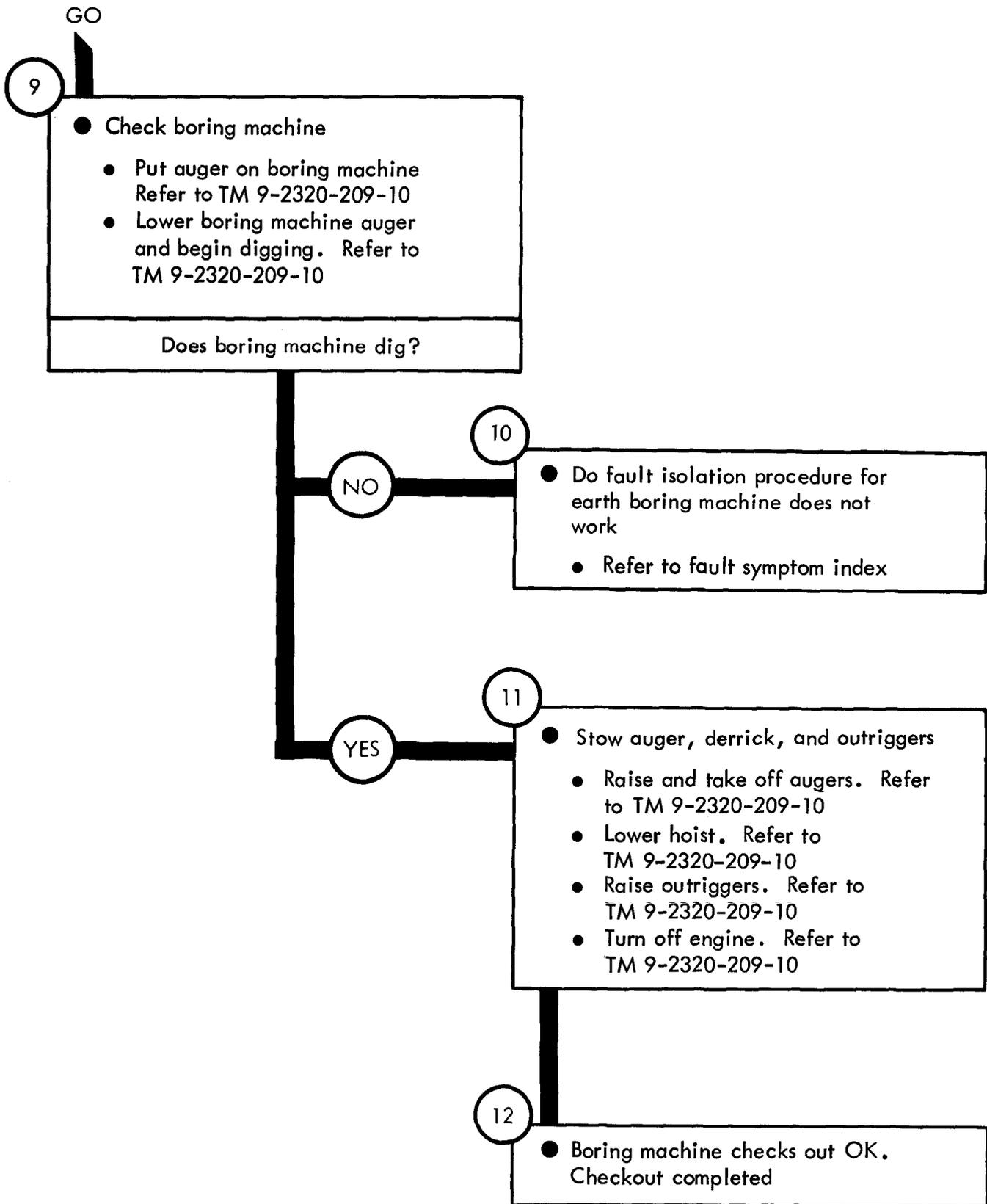

Figure 76-1 (Sheet 2 of 3)



TA 115047

Figure 76-1 (Sheet 3 of 3)

CHAPTER 77

FRONT WINCH TROUBLESHOOTING

77-1. EQUIPMENT ITEMS COVERED. This chapter gives equipment troubleshooting procedures for the front winch, for which there are authorized corrective maintenance tasks at the organizational maintenance level.

77-2. EQUIPMENT ITEMS NOT COVERED. All equipment items for which corrective maintenance is authorized at the organizational maintenance level are covered in this chapter.

FRONT WINCH TROUBLESHOOTING

Symptom

1 WINCH DOES NOT PULL LOAD

1

- Make truck body ready for work on front winch
 - Stop winch. Refer to TM 9-2320-209-10
 - Stop engine. Refer to TM 9-2320-209-10
 - Unhook cable from load
 - Chock wheels

2

- Check front winch drive shaft
 - Look for a broken universal joint
 - Look for a broken drive shaft

Is front winch drive shaft OK?

YES

NO

3

- Replace broken universal joint
 - Refer to Vol 3, chapter 10, para 10-5
- Replace broken drive shaft
 - Refer to Vol 3, chapter 19, para 19-5

GO

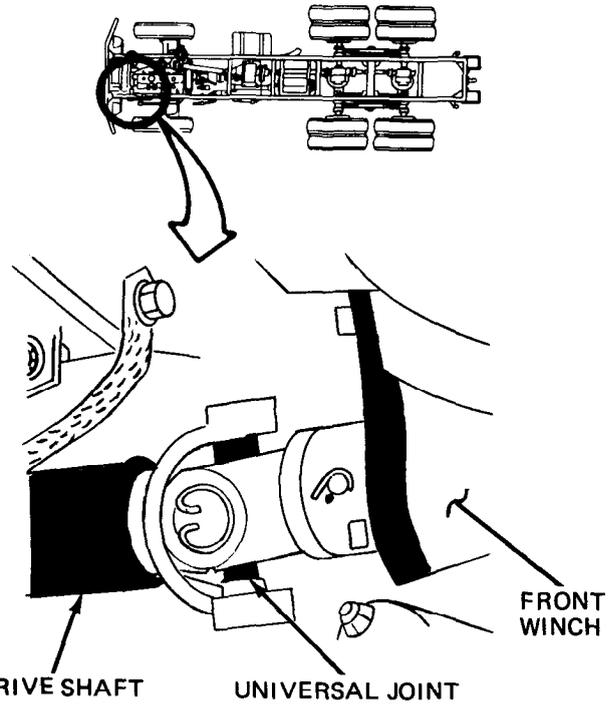
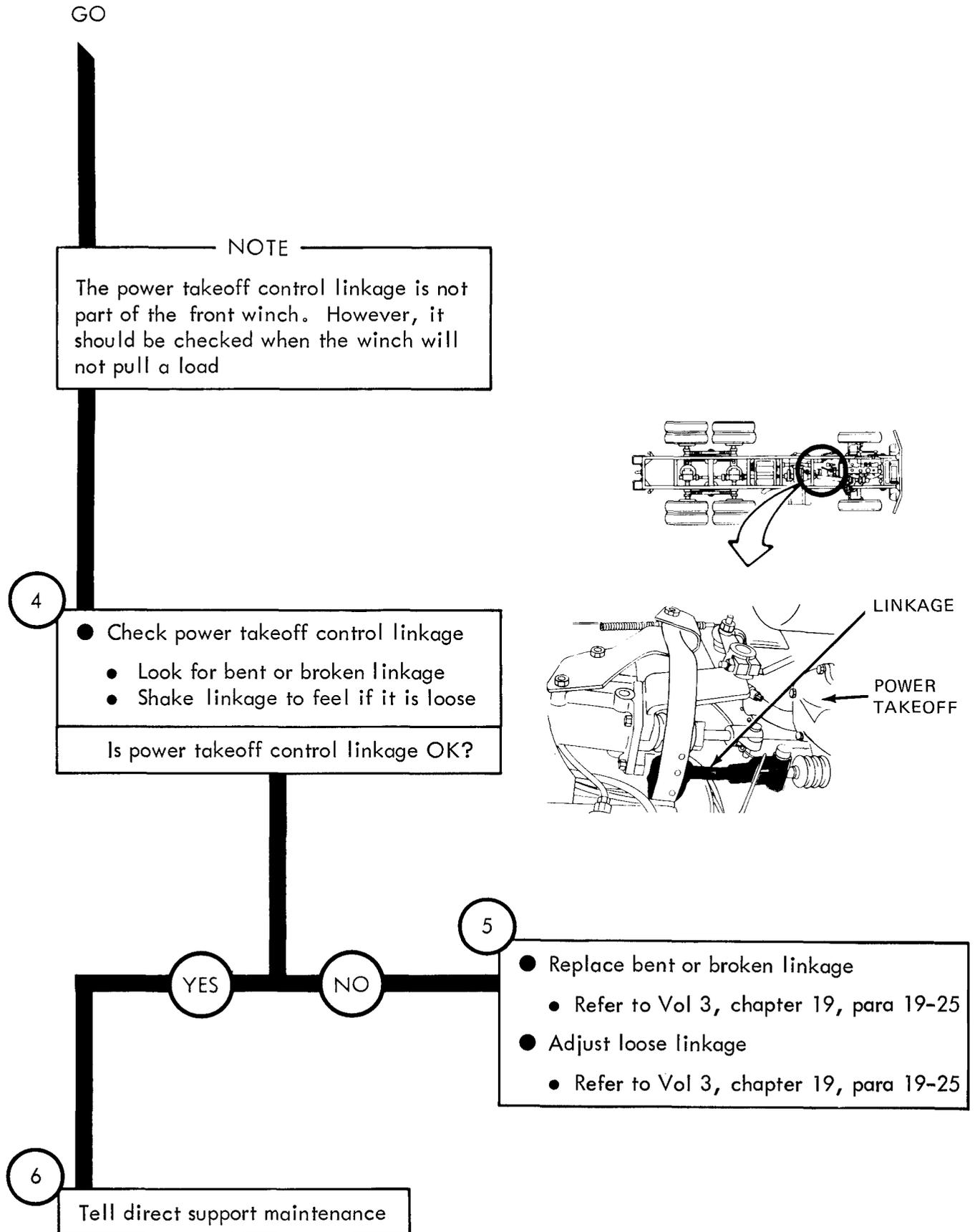

Figure 77-1 (Sheet 1 of 2)

TA 115048



TA 115049

Figure 77-1 (Sheet 2 of 2)

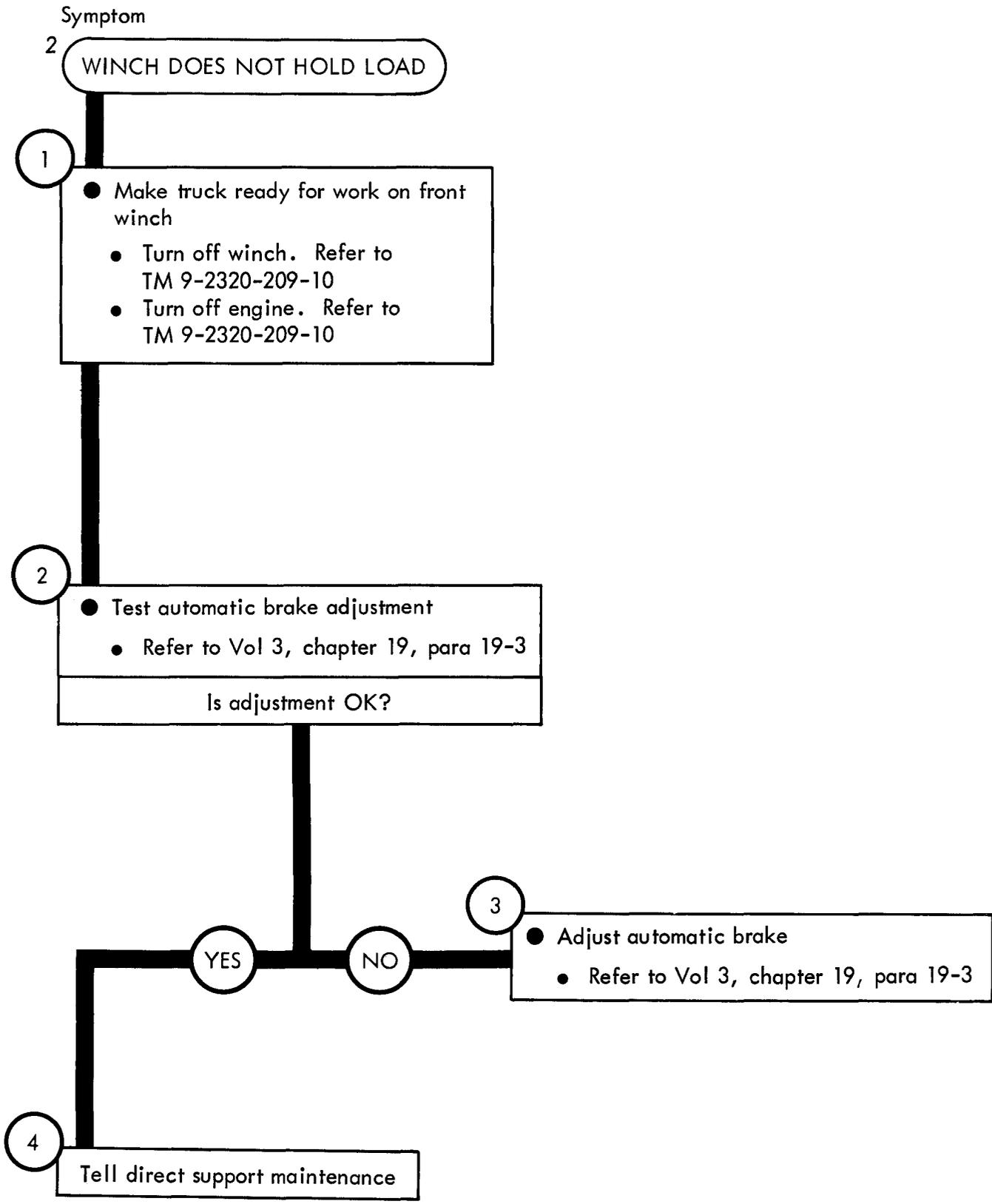
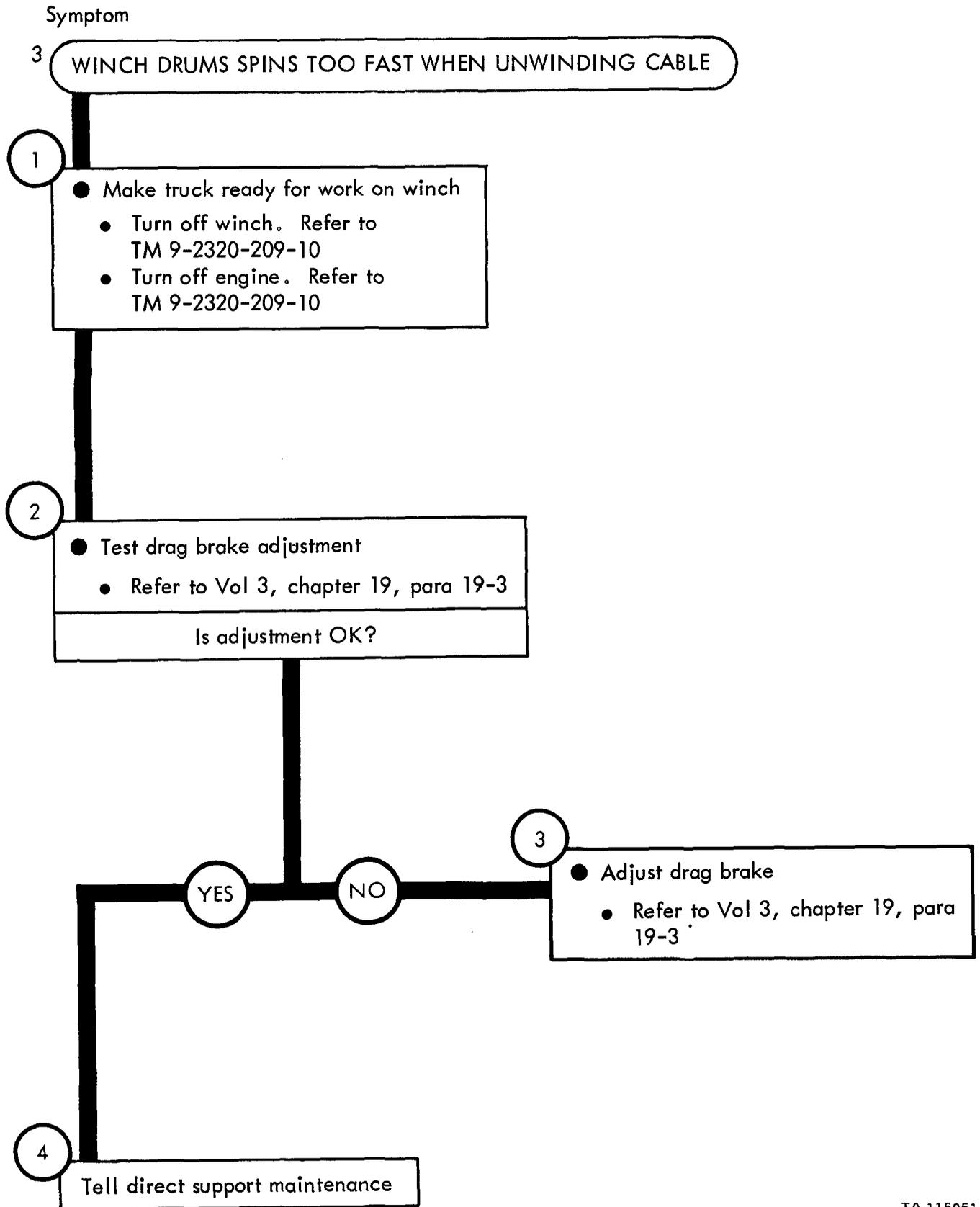

Figure 77-2



TA 115051

Figure 77-3

CHAPTER 78

FRONT WINCH TROUBLESHOOTING SUMMARY

78-1. GENERAL. This chapter gives a summary of troubleshooting procedures given in chapter 77 for the front winch.

78-2. PROCEDURES. The summary in this chapter covers all fault symptoms found in the detailed troubleshooting procedures. Chapter 7 outlines a sample troubleshooting procedure. The summary procedures are based on the "what-to-do" portions of the detailed procedures and do not include the "how-to-do-it" instructions. Warnings, cautions, and notes are given where needed.

FRONT WINCH TROUBLESHOOTING SUMMARY

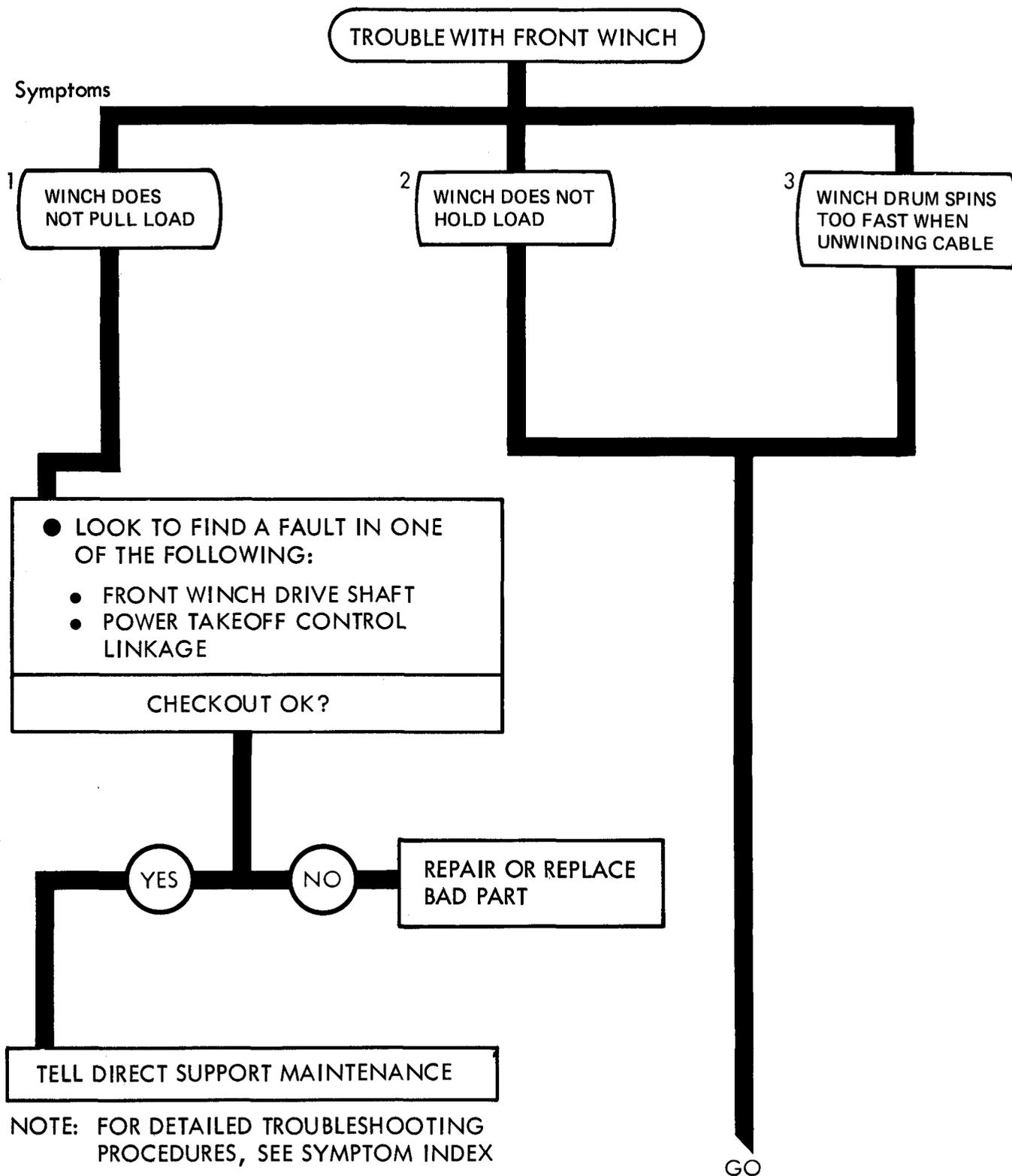

NOTE: FOR DETAILED TROUBLESHOOTING PROCEDURES, SEE SYMPTOM INDEX

Figure 78-1 (Sheet 1 of 2)

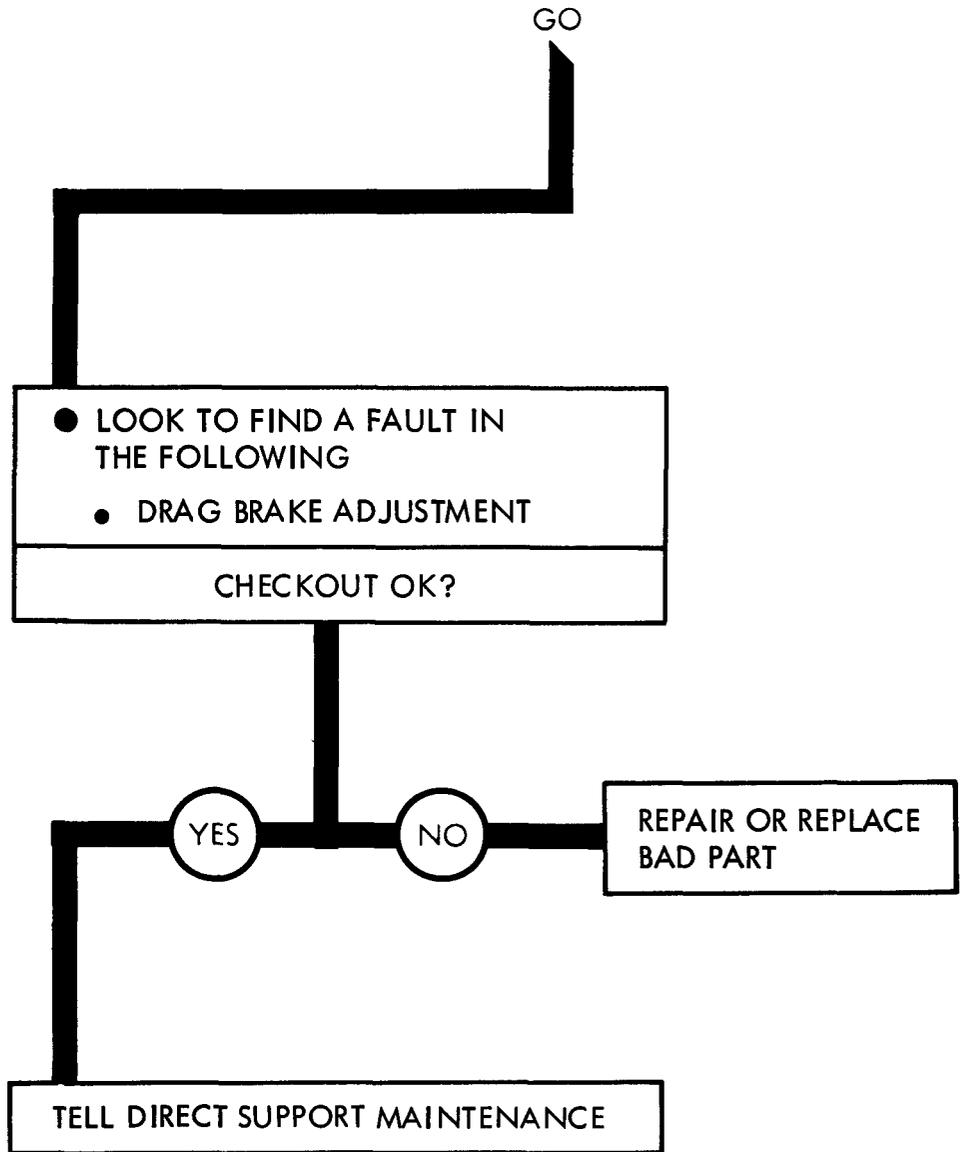

NOTE: FOR DETAILED TROUBLESHOOTING PROCEDURES, SEE SYMPTOM INDEX

CHAPTER 79

FRONT WINCH CHECKOUT PROCEDURES

79-1. GENERAL. This chapter gives procedures for checking out the system after troubleshooting and repair have been done. Procedures are set up in flow chart form showing the checkout steps in order and referring to the fault symptom index when the system does not check out.

FRONT WINCH CHECKOUT

Symptom

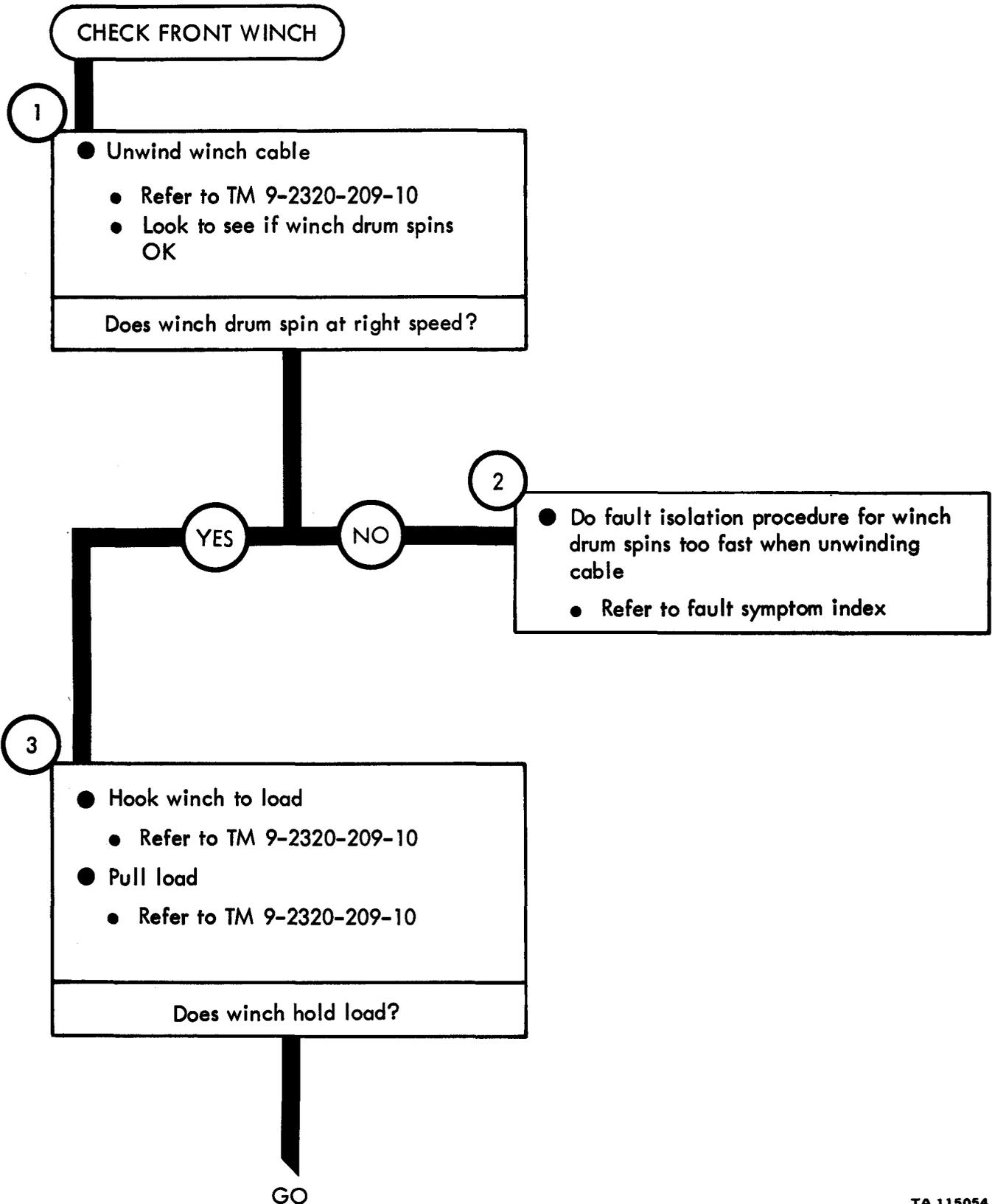
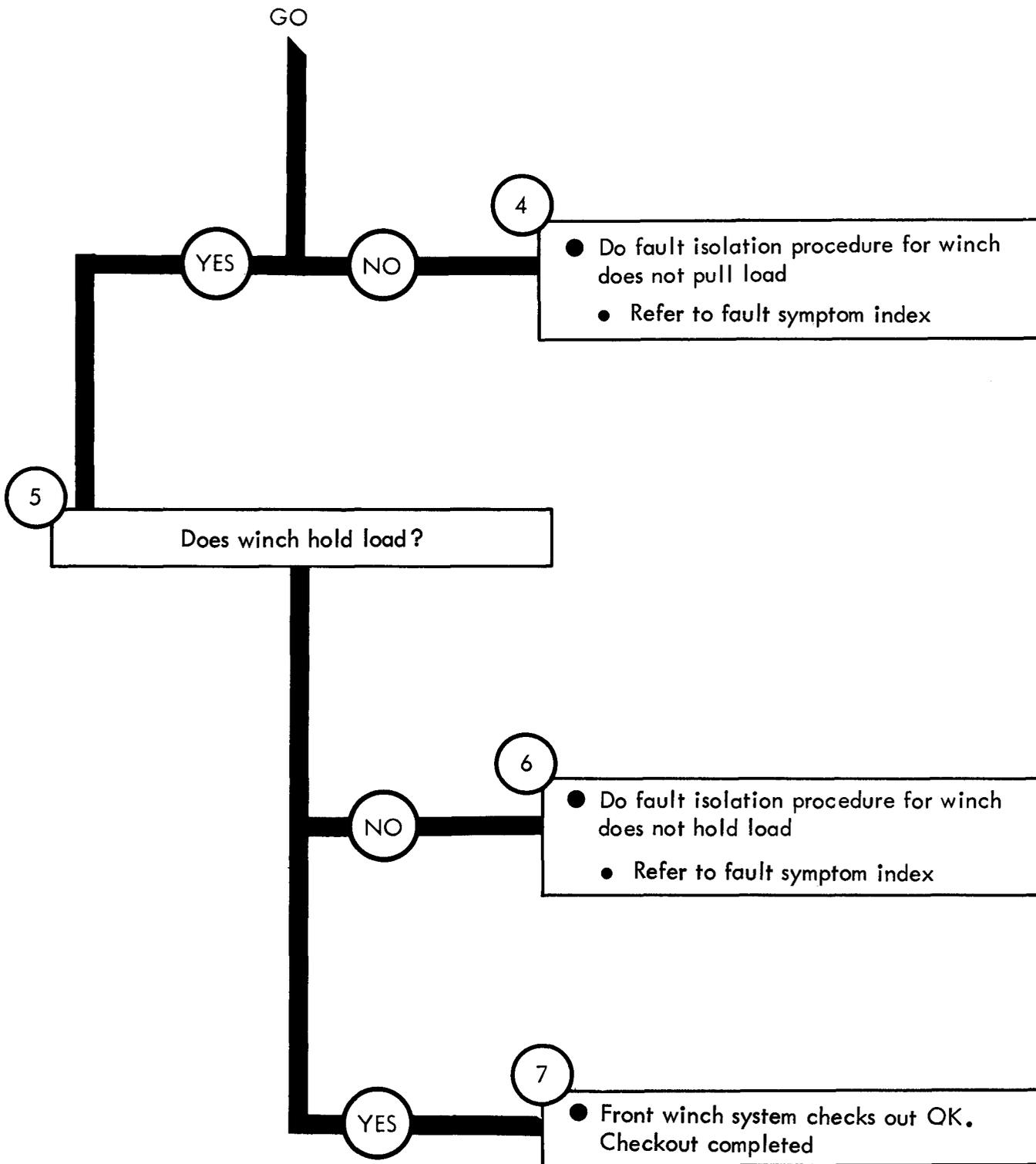

Figure 79-1 (Sheet 1 of 2)



CHAPTER 80

EARTH BORING MACHINE REAR WINCH TROUBLESHOOTING

80-1. EQUIPMENT ITEMS COVERED. This chapter gives equipment troubleshooting procedures for the earth boring machine rear winch, for which there are authorized corrective maintenance tasks at the organizational maintenance level.

80-2. EQUIPMENT ITEMS NOT COVERED. All equipment items for which corrective maintenance is authorized at the organizational maintenance level are covered in this chapter.

EARTH BORING MACHINE REAR WINCH TROUBLESHOOTING

Symptom

1 WINCH DOES NOT PULL LOAD

- 1
- Park truck
 - Refer to TM 9-2320-209-10
 - Turn off winch. Refer to TM 9-2320-209-10
 - Turn off engine. Refer to TM 9-2320-209-10

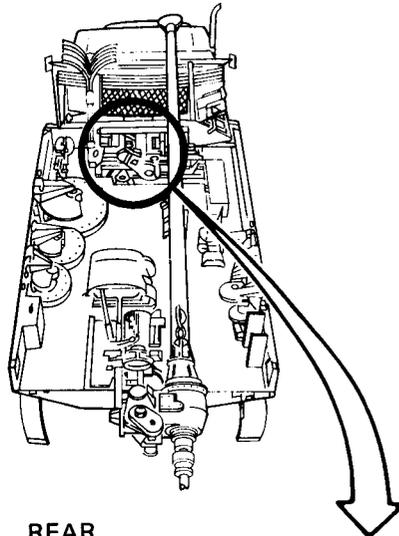

- 2
- Check winch drive chain
 - Look for broken chain
- Is winch drive chain OK?

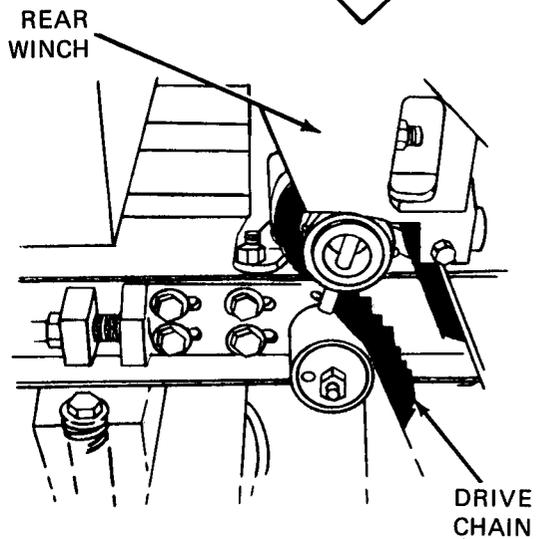

GO

TA 115056

Figure 80-1 (Sheet 1 of 4)

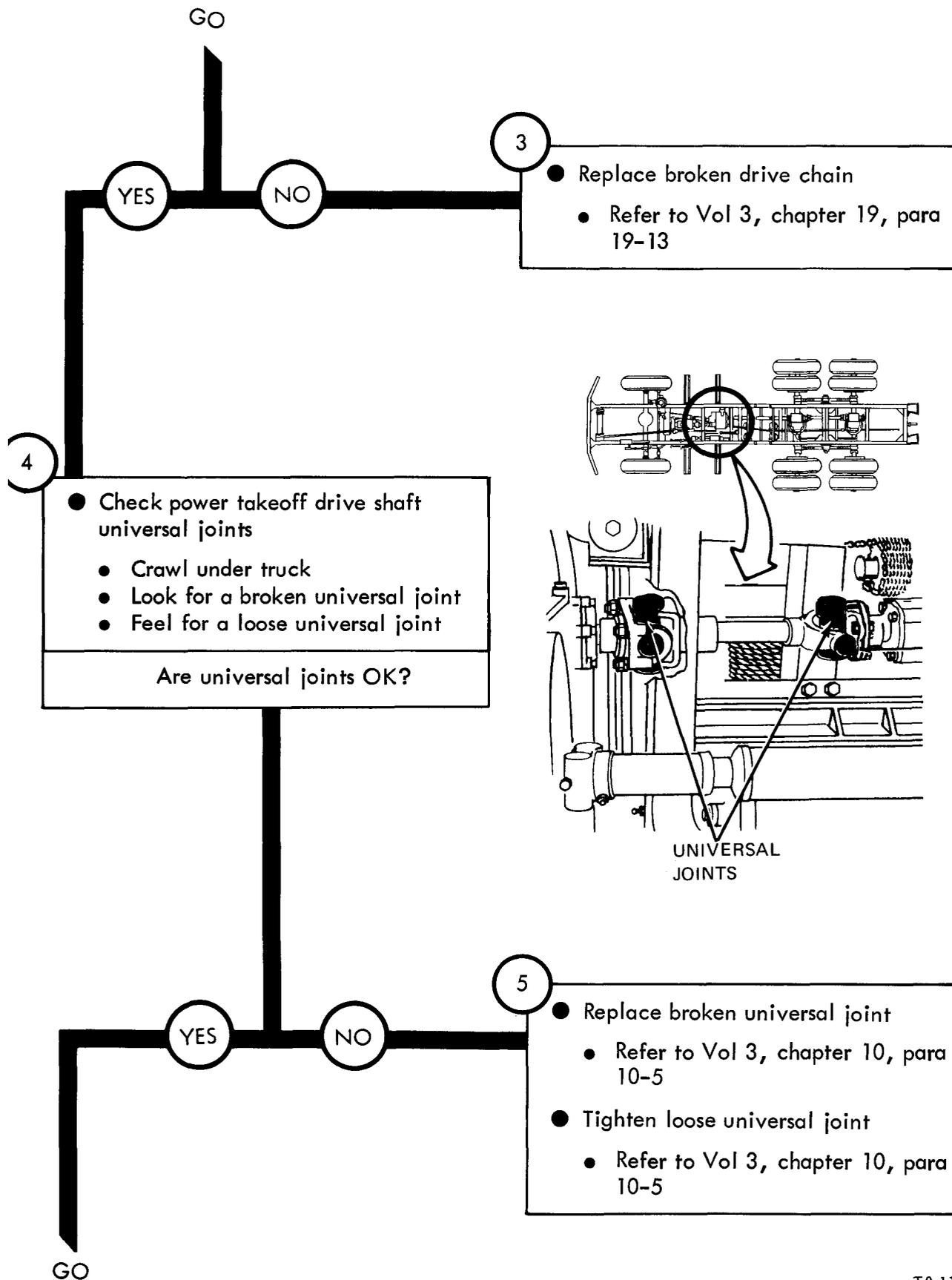
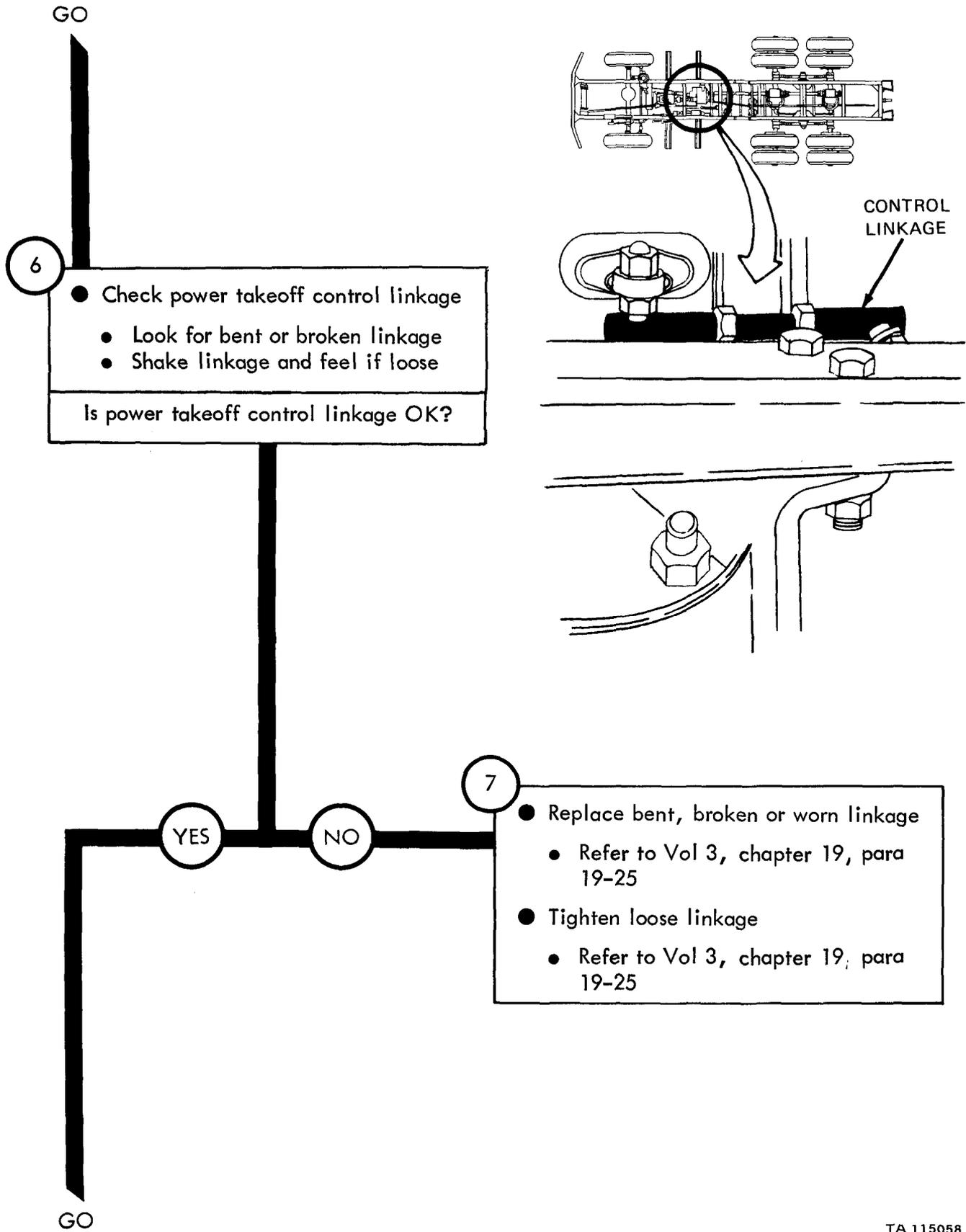

Figure 80-1 (Sheet 2 of 4)



TA 115058

Figure 80-1 (Sheet 3 of 4)

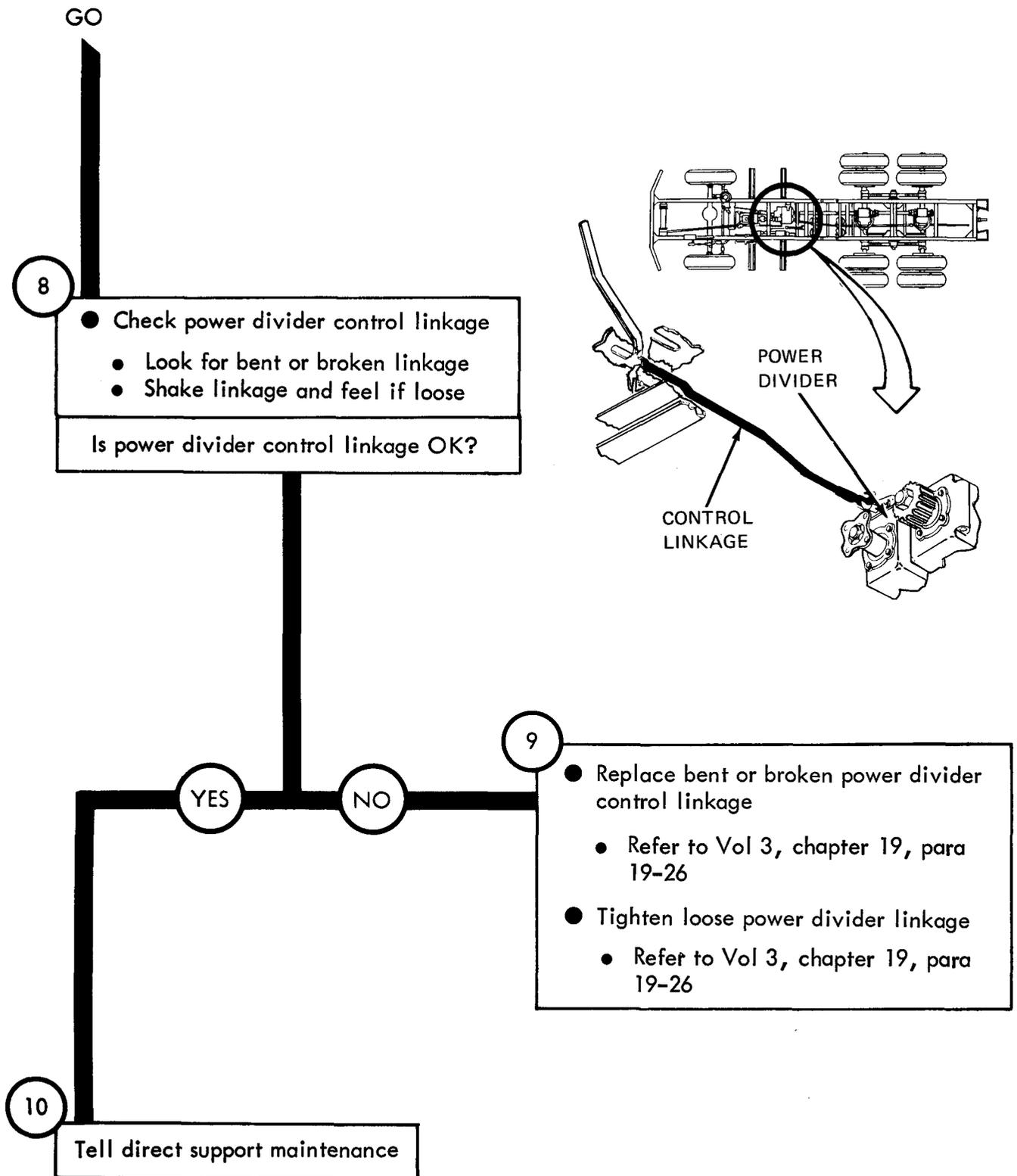

Figure 80-1 (Sheet 4 of 4)

Symptom

2

WINCH DRUM DOES NOT ENGAGE

1

- Park truck
 - Refer to TM 9-2320-209-10
 - Turn off winch. Refer to TM 9-2320-209-10
 - Turn off engine. Refer to TM 9-2320-209-10

2

- Check winch control lever shift
 - Move control lever to feel if it moves freely
 - Feel for loose or sluggish movement
- Does control lever shift OK?

GO

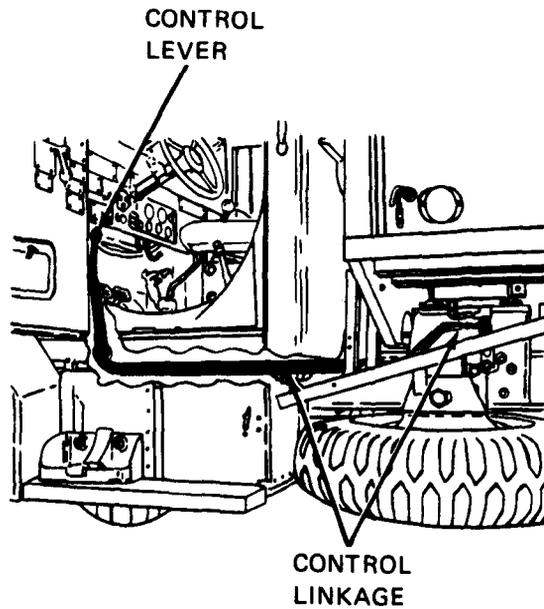
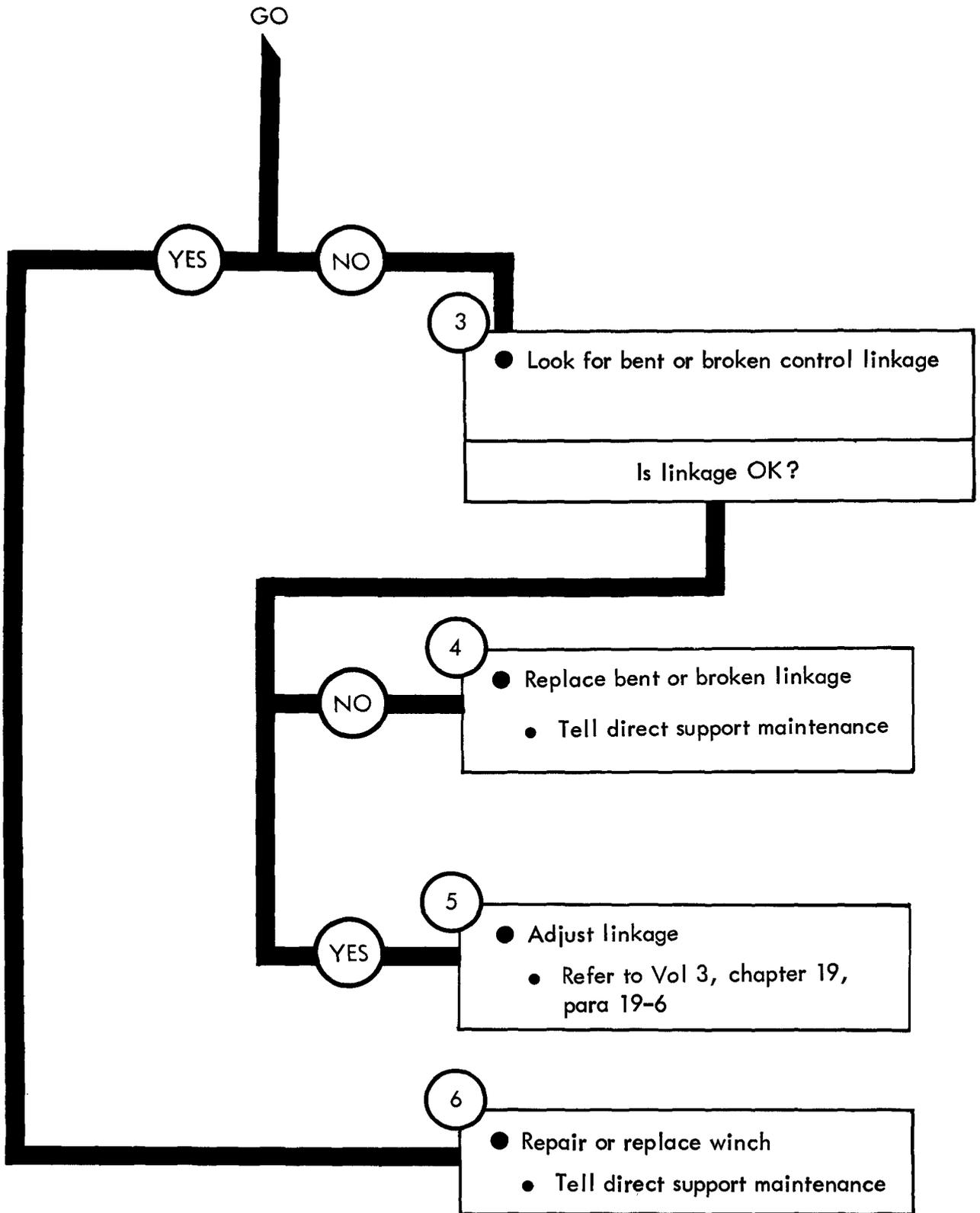

Figure 80-2 (Sheet 1 of 2)

TA 115060



TA 115061

Figure 80-2 (Sheet 2 of 2)

80-7/(80-8 blank)

CHAPTER 81

PIPELINE CONSTRUCTION TRUCK REAR WINCH TROUBLESHOOTING

81-1. EQUIPMENT ITEMS COVERED. This chapter gives equipment troubleshooting procedures for the pipeline construction truck rear winch, for which there are authorized corrective maintenance tasks at the organizational maintenance level.

81-2. EQUIPMENT ITEMS NOT COVERED. All equipment items for which corrective maintenance is authorized at the organizational maintenance level are covered in this chapter.

PIPELINE CONSTRUCTION TRUCK REAR WINCH TROUBLESHOOTING

Symptom

1 WINCH DOES NOT PULL LOAD

- 1
- Make truck ready for work on rear winch
 - Turn off winch. Refer to TM 9-2320-209-10
 - Turn off engine. Refer to TM 9-2320-209-10

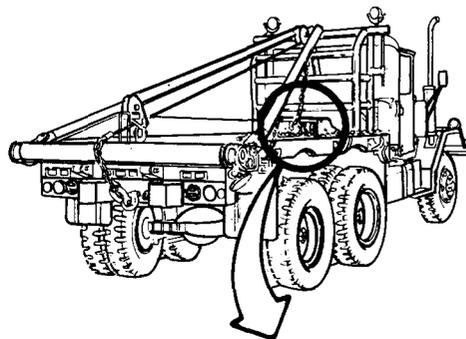

- 2
- Check winch drive chain
 - Look for a broken chain
- Is winch drive chain OK?

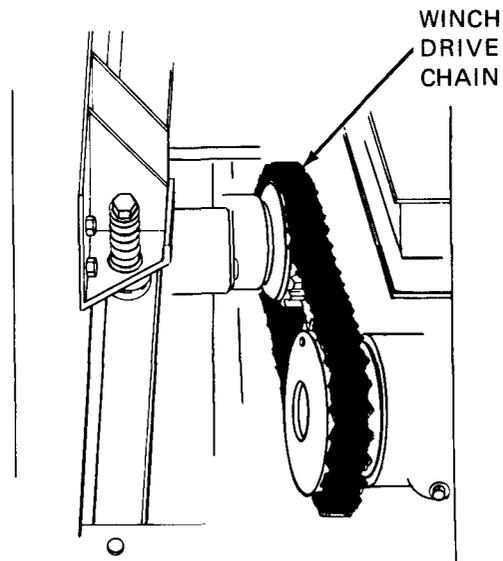

- YES
- NO
- 3
- Replace broken drive chain
 - Refer to Vol 3, chapter 19, para 19-13

GO

TA 115062

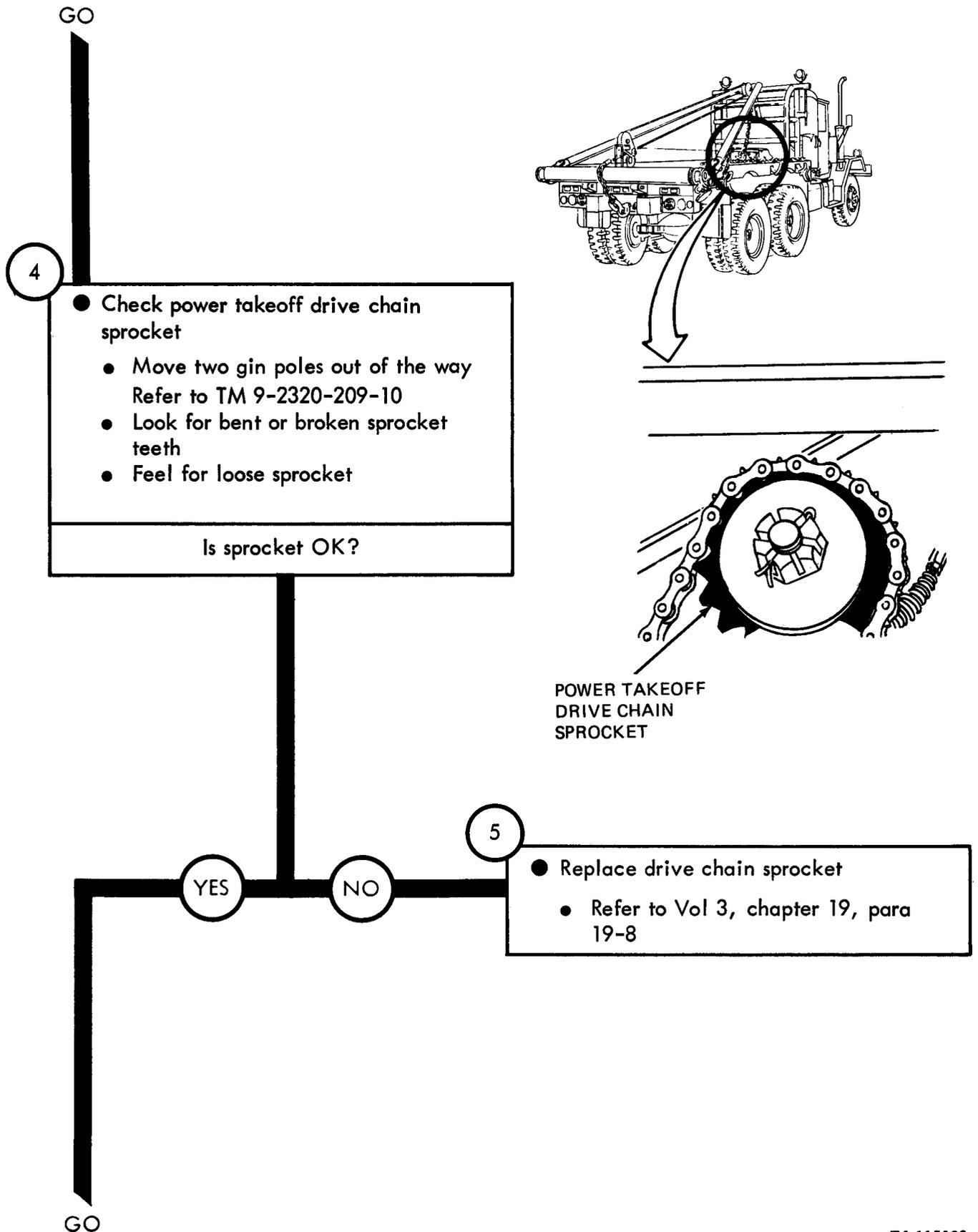
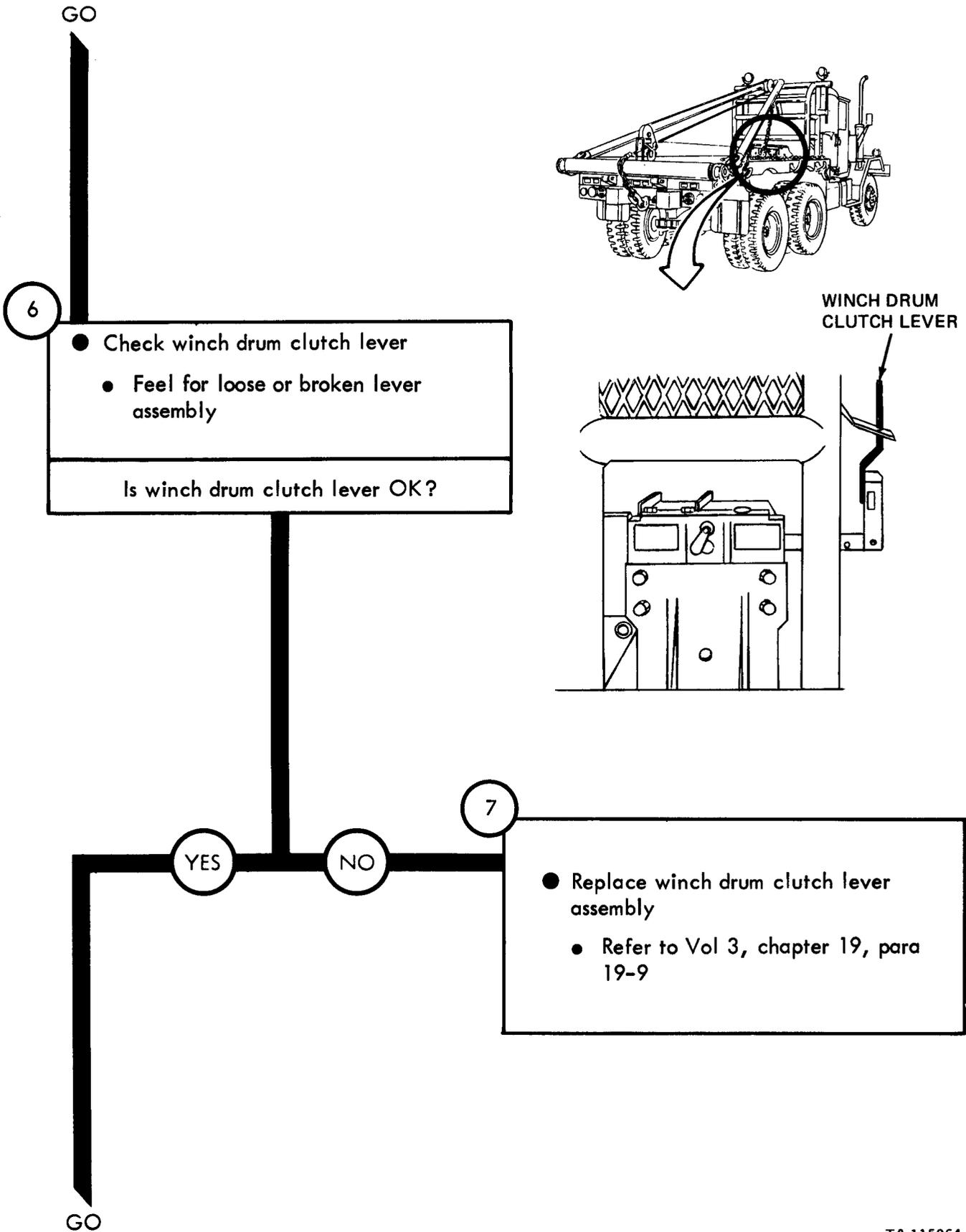

Figure 81-1 (Sheet 2 of 5)



TA 115064

Figure 81-1 (Sheet 3 of 5)

GO

8

- Check power takeoff control linkage
 - Look for bent or broken linkage
 - Crawl under truck
 - Shake linkage and feel if it is loose

Is power control linkage OK?

GO

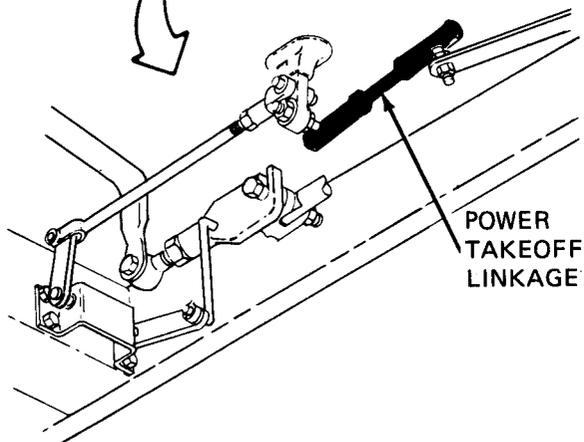
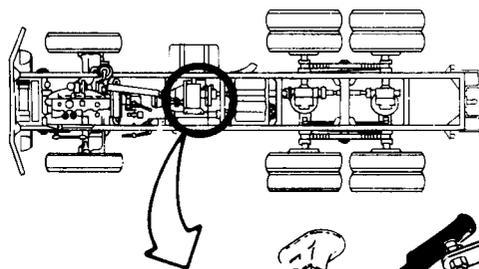
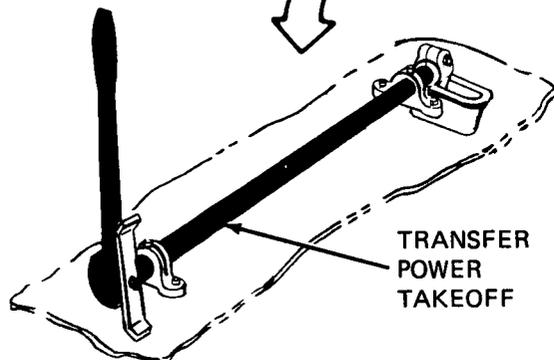
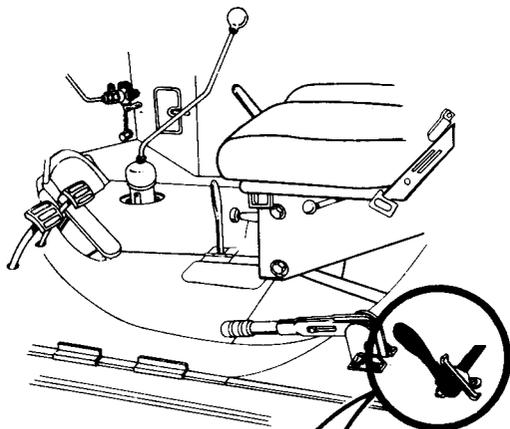

TA 115065

Figure 81-1 (Sheet 4 of 5)

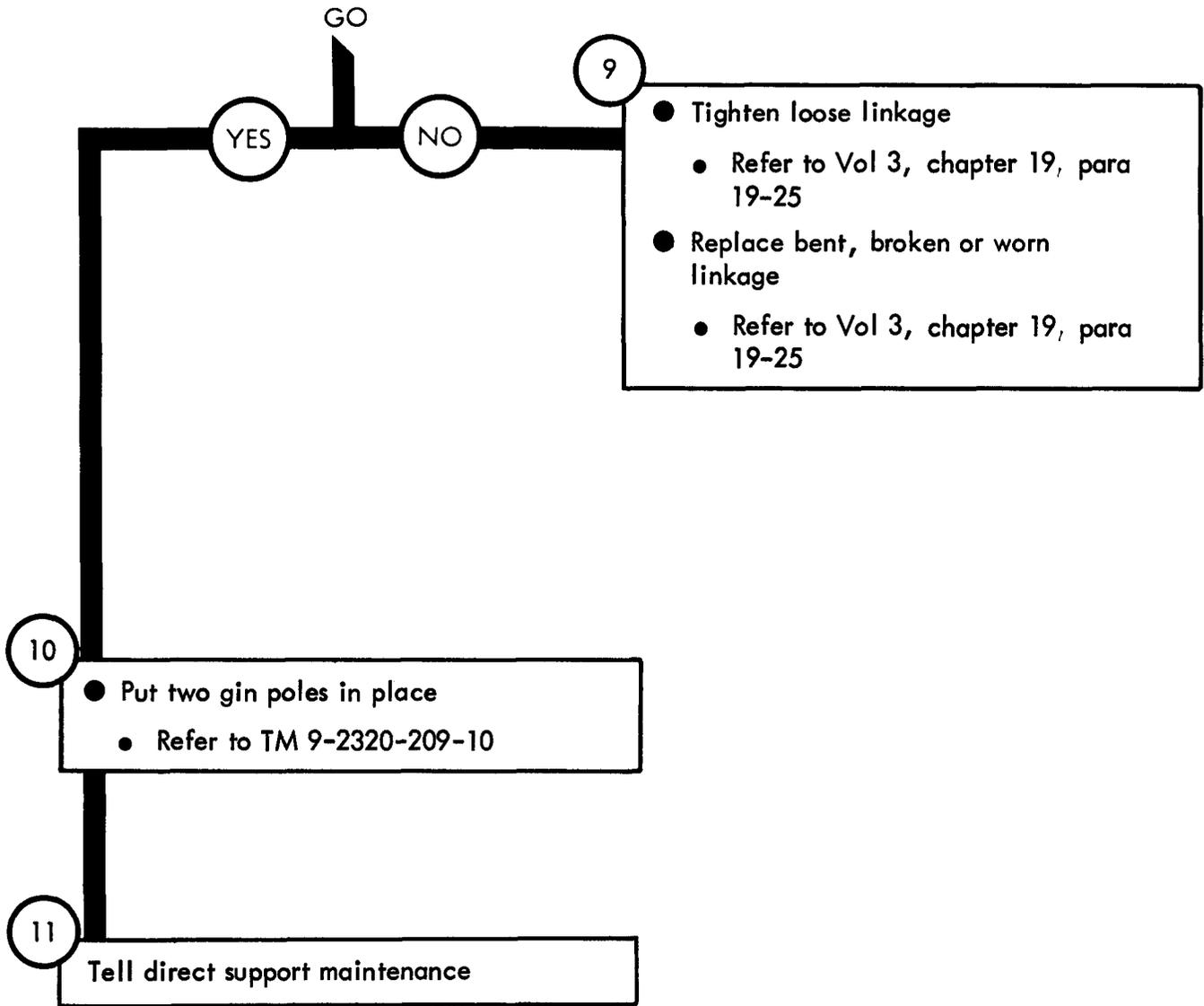

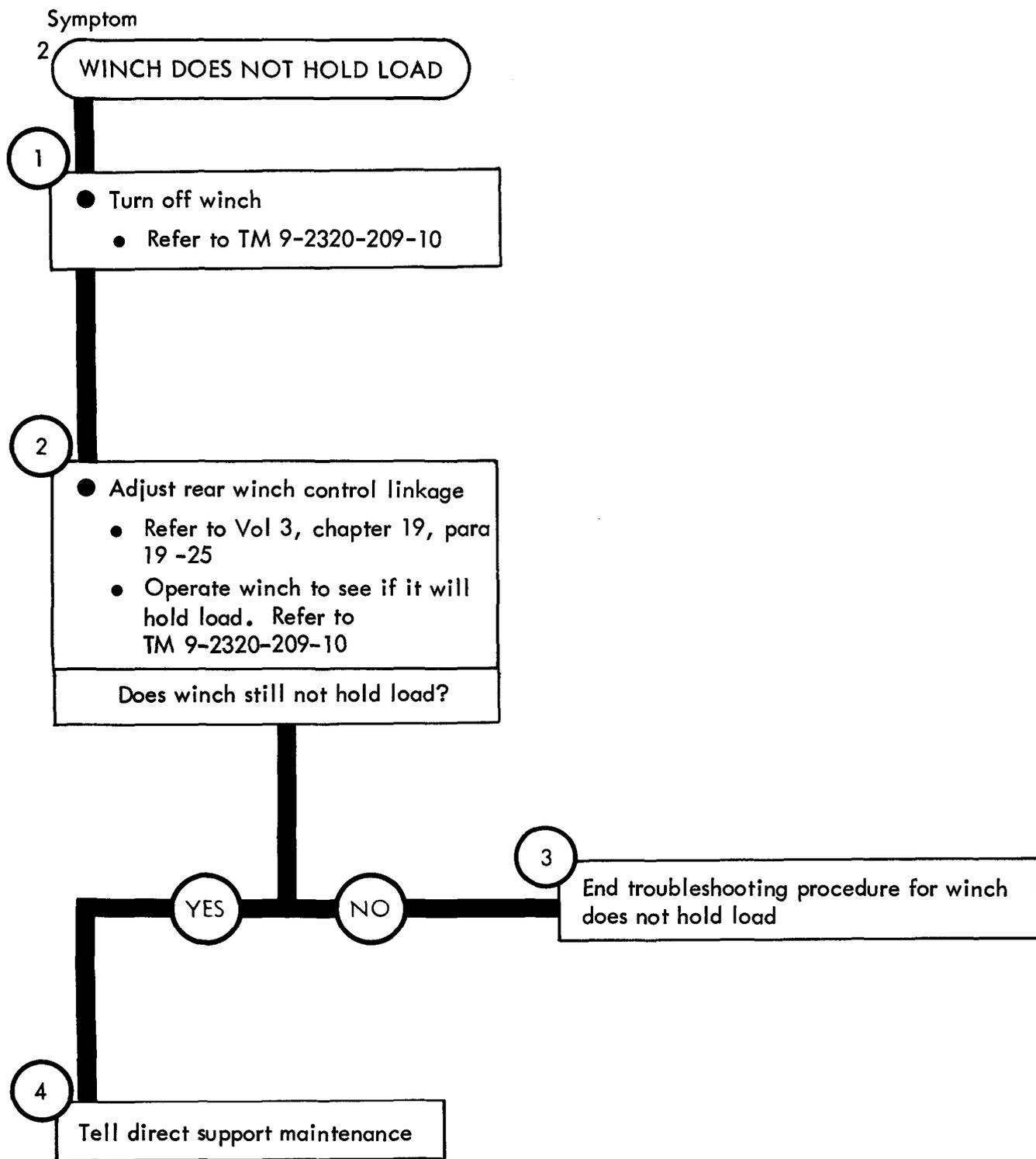

TA 115067

Figure 81-2

CHAPTER 82

ENGINE COOLANT HEATER TROUBLESHOOTING

82-1. EQUIPMENT ITEMS COVERED. This chapter gives equipment troubleshooting procedures for the engine coolant heater, for which there are authorized corrective maintenance tasks at the organizational maintenance level.

82-2. EQUIPMENT ITEMS NOT COVERED. All equipment items for which corrective maintenance is authorized at the organizational maintenance level are covered in this chapter.

Symptom

1 HEATER DOES NOT START WHEN SWITCH IS TURNED ON

- 1
- Turn heater switch to OFF
 - Refer to TM 9-2320-209-10

— WARNING —

Diesel fuel is very flammable. Care must be used when choosing a place to work on fuel line. Keep truck about 50 feet away from an area where open flame, sparks, or smoking can cause a fire. Keep a fire extinguisher nearby

- 2
- Check heater fuel pump
 - Refer to troubleshooting test index for heater fuel pump check
- Is heater fuel pump OK?

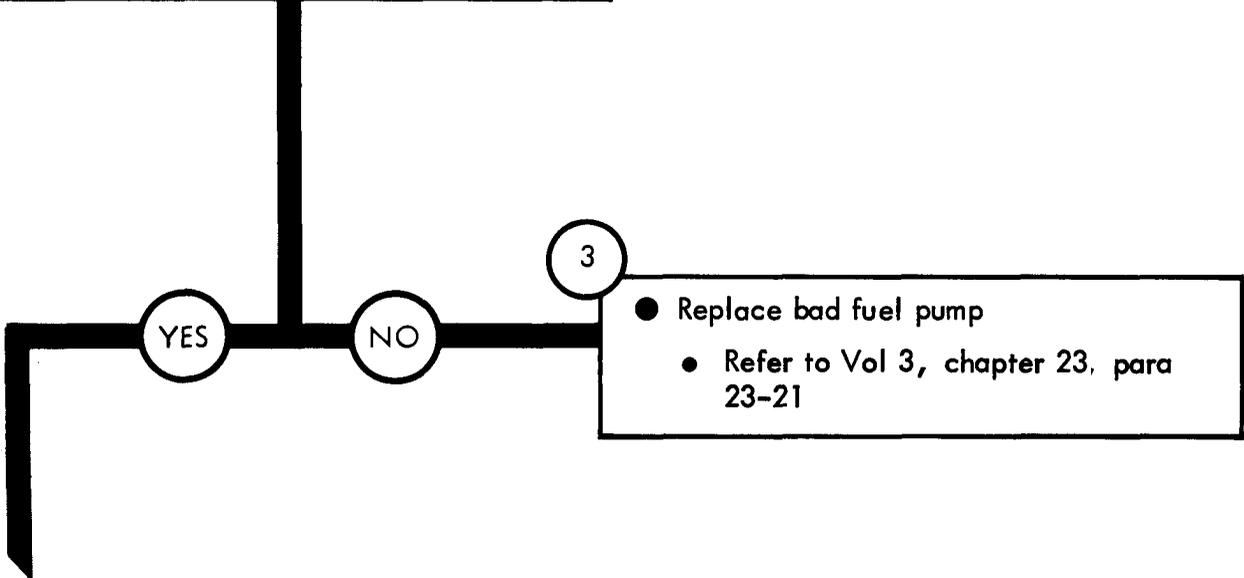

GO

TA 115267

Figure 82-1 (Sheet 1 of 2)

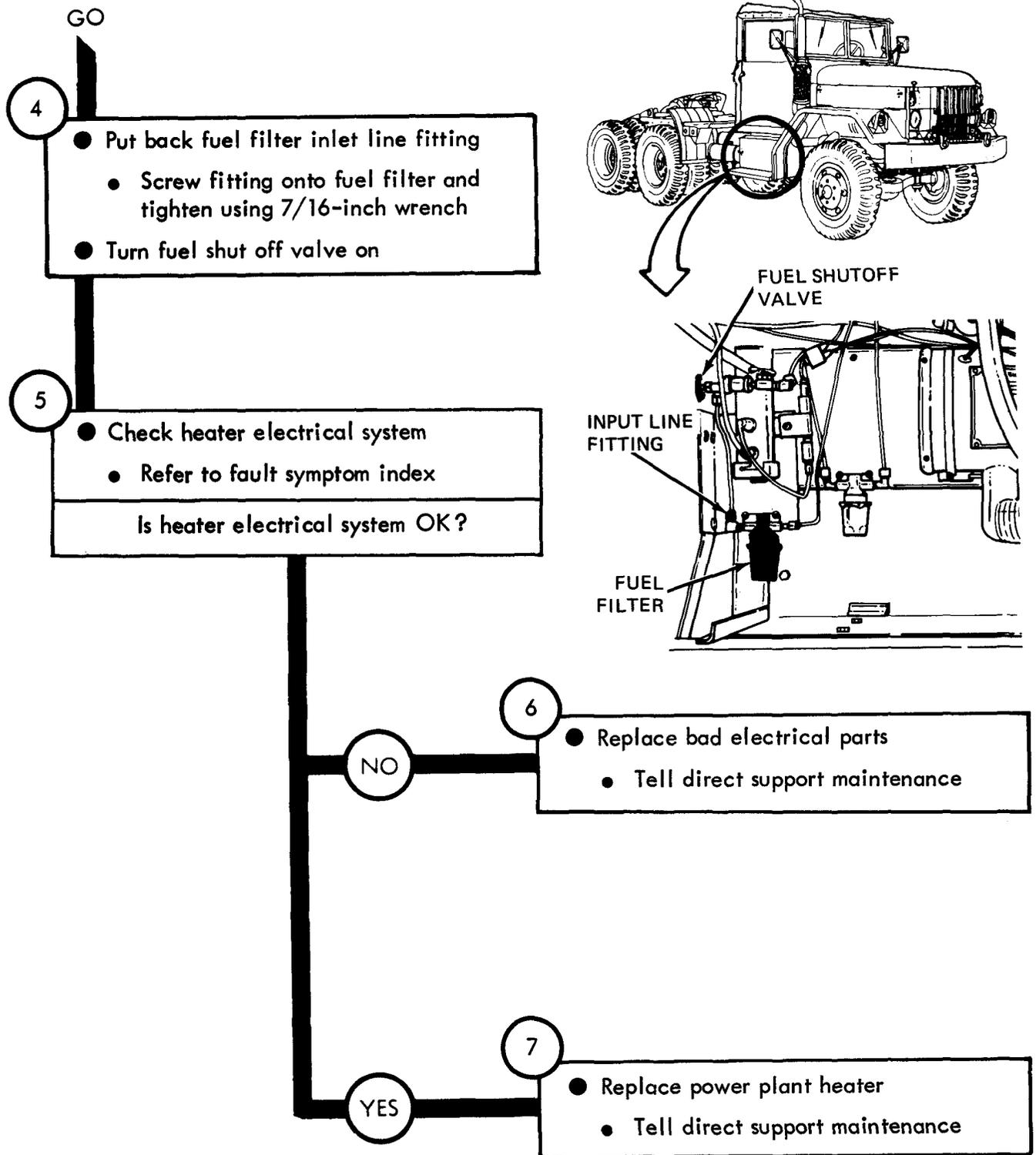

Figure 82-1 (Sheet 2 of 2)

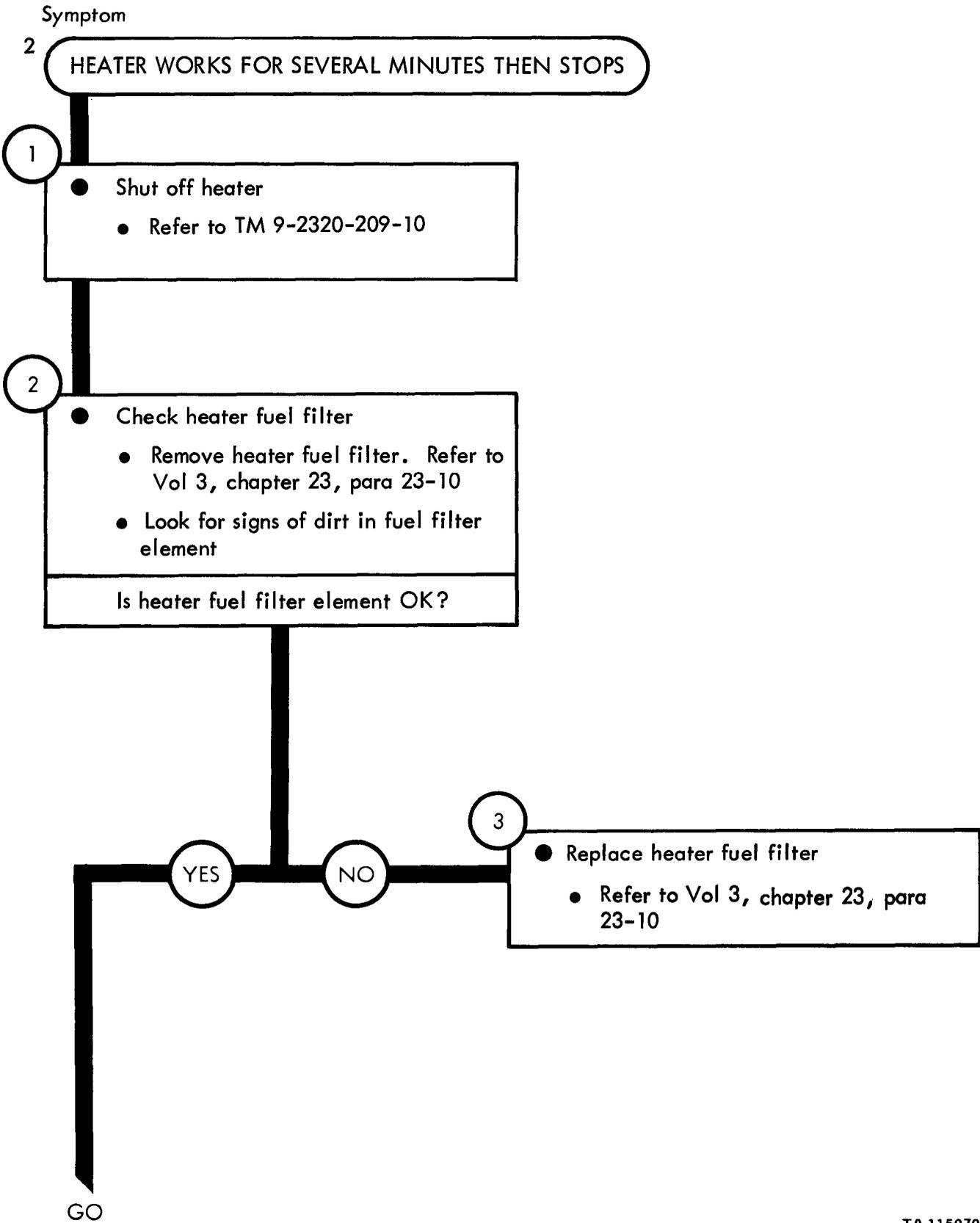

Figure 82-2 (Sheet 1 of 3)

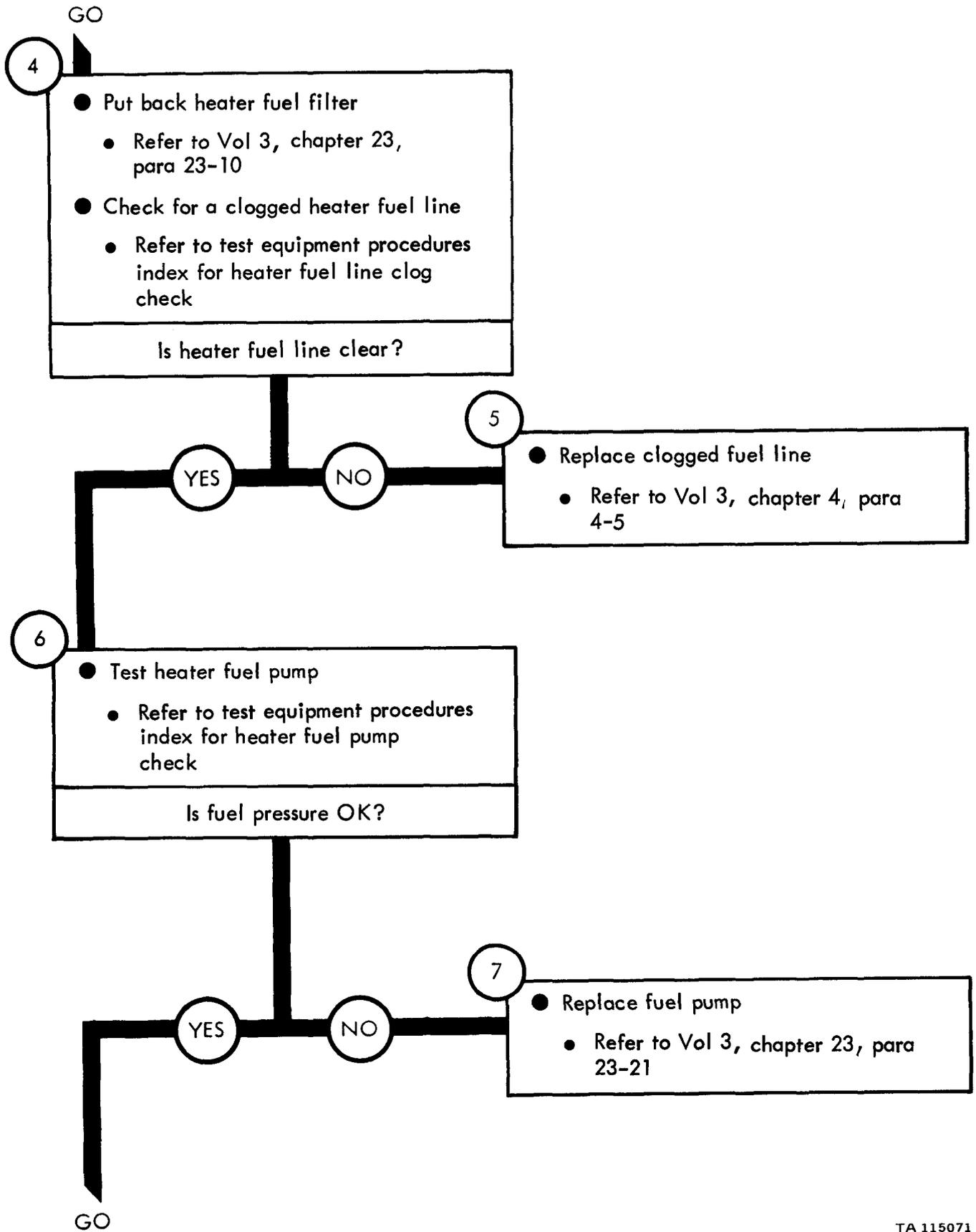
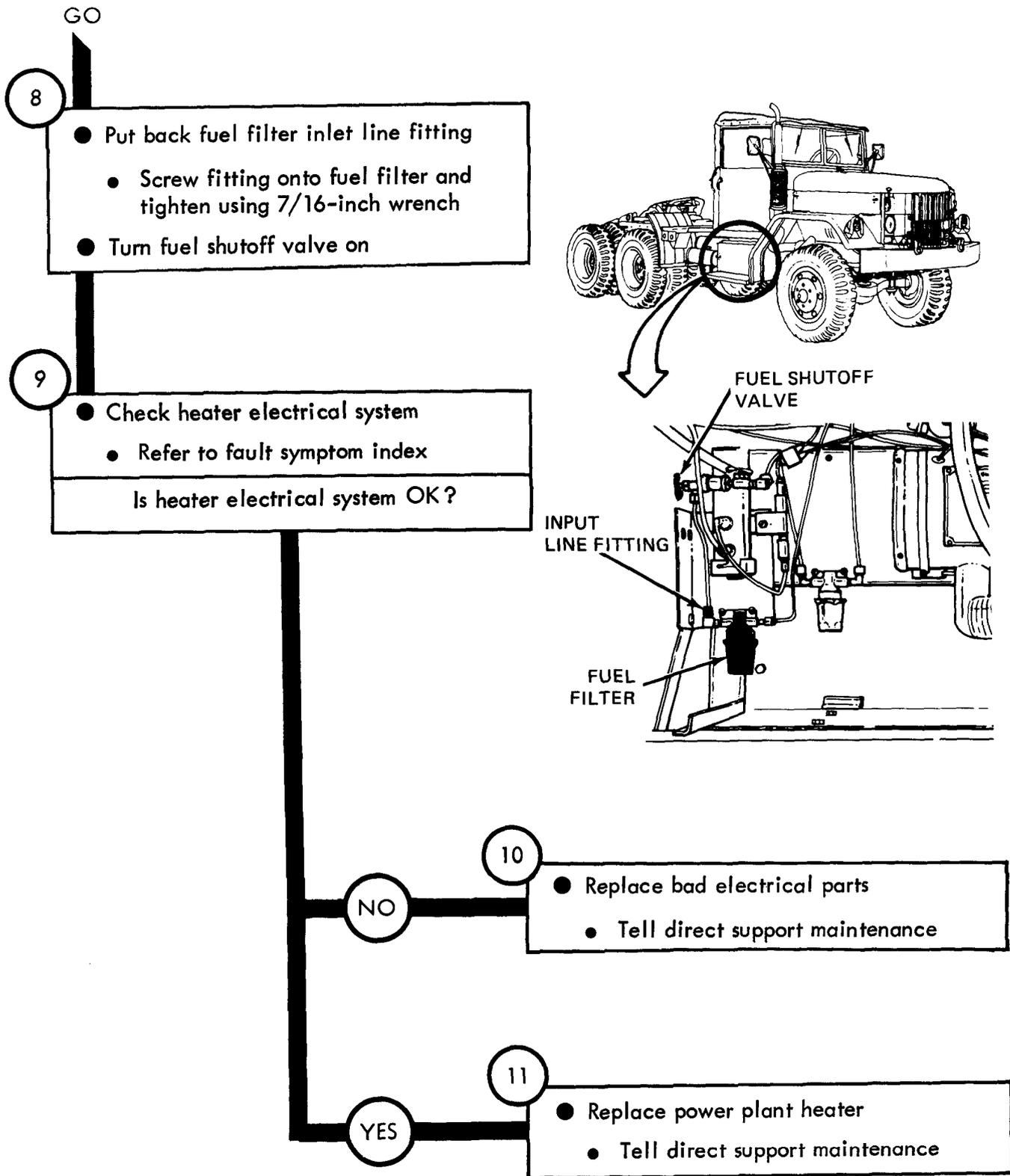

Figure 82-2 (Sheet 2 of 3)



TA 115072

Figure 82-2 (Sheet 3 of 3)

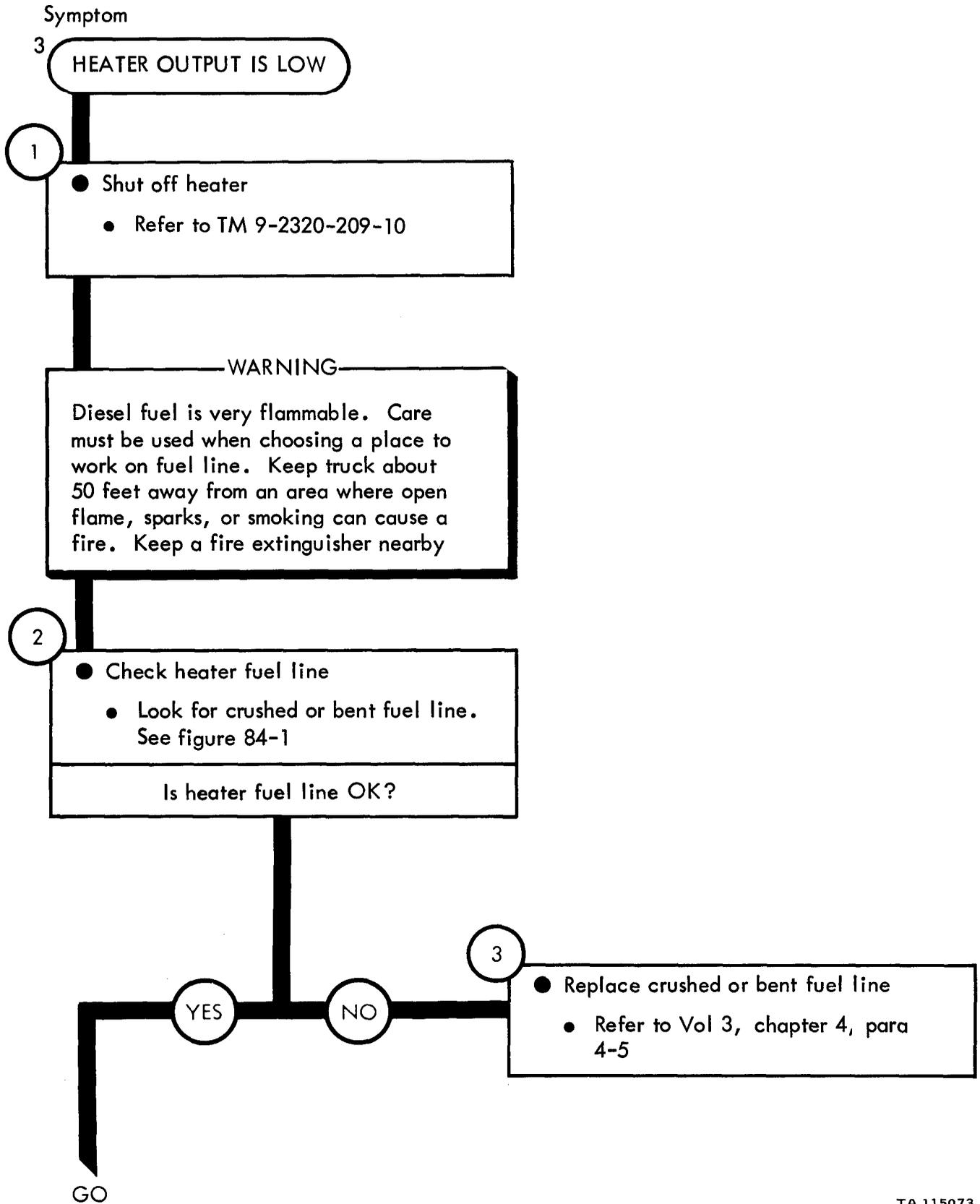
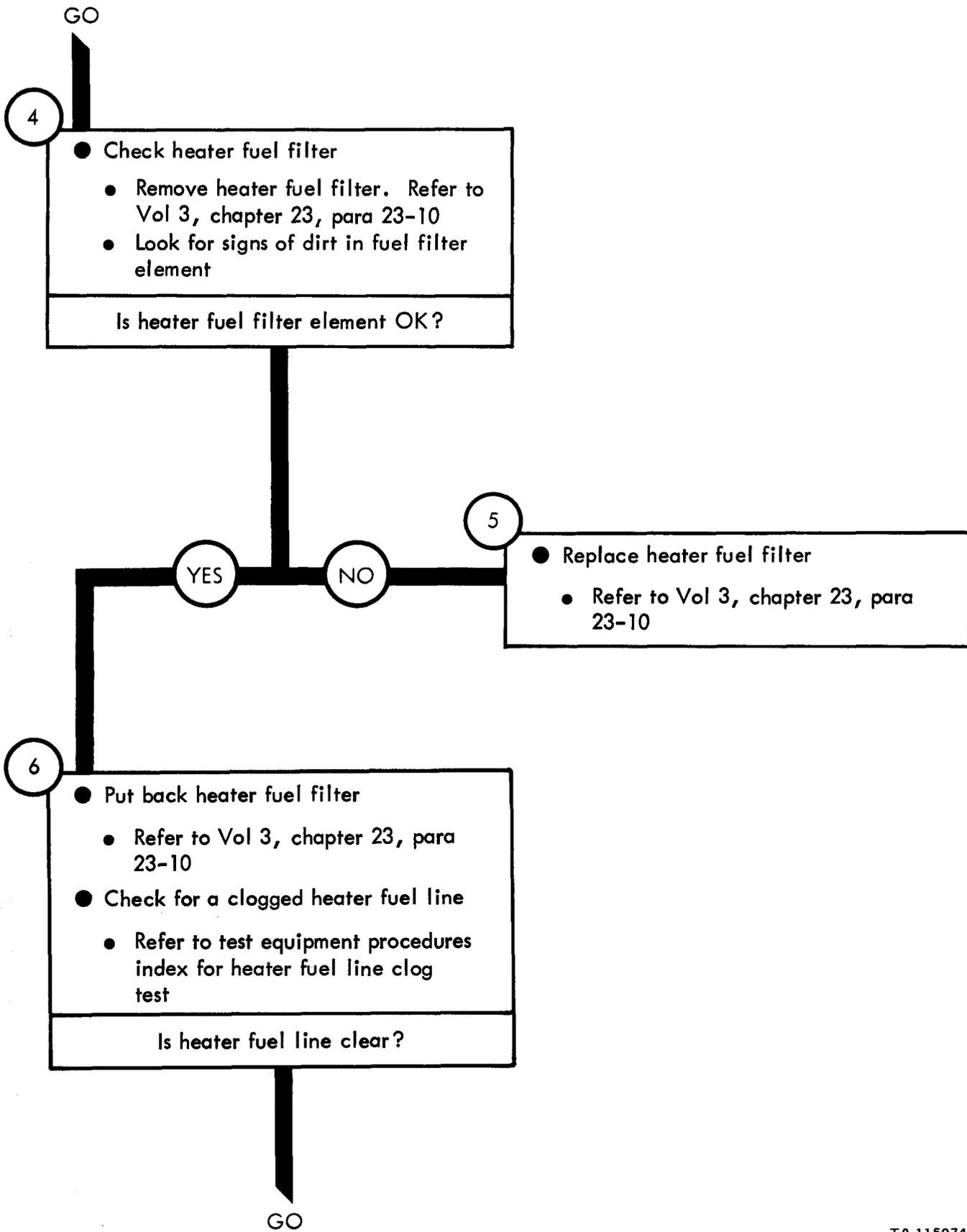

Figure 82-3 (Sheet 1 of 3)



TA 115074

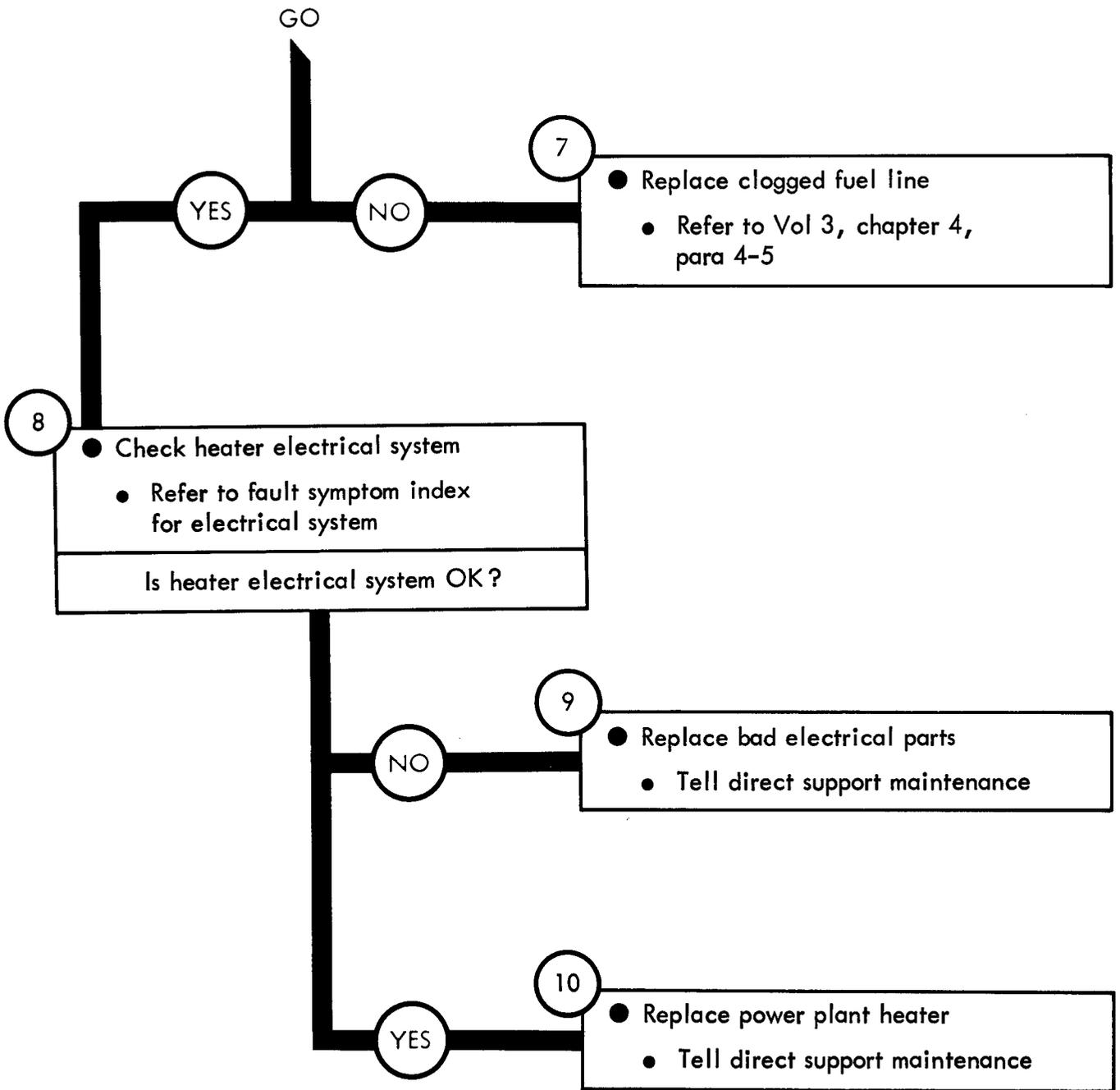

Figure 82-3 (Sheet 3 of 3)

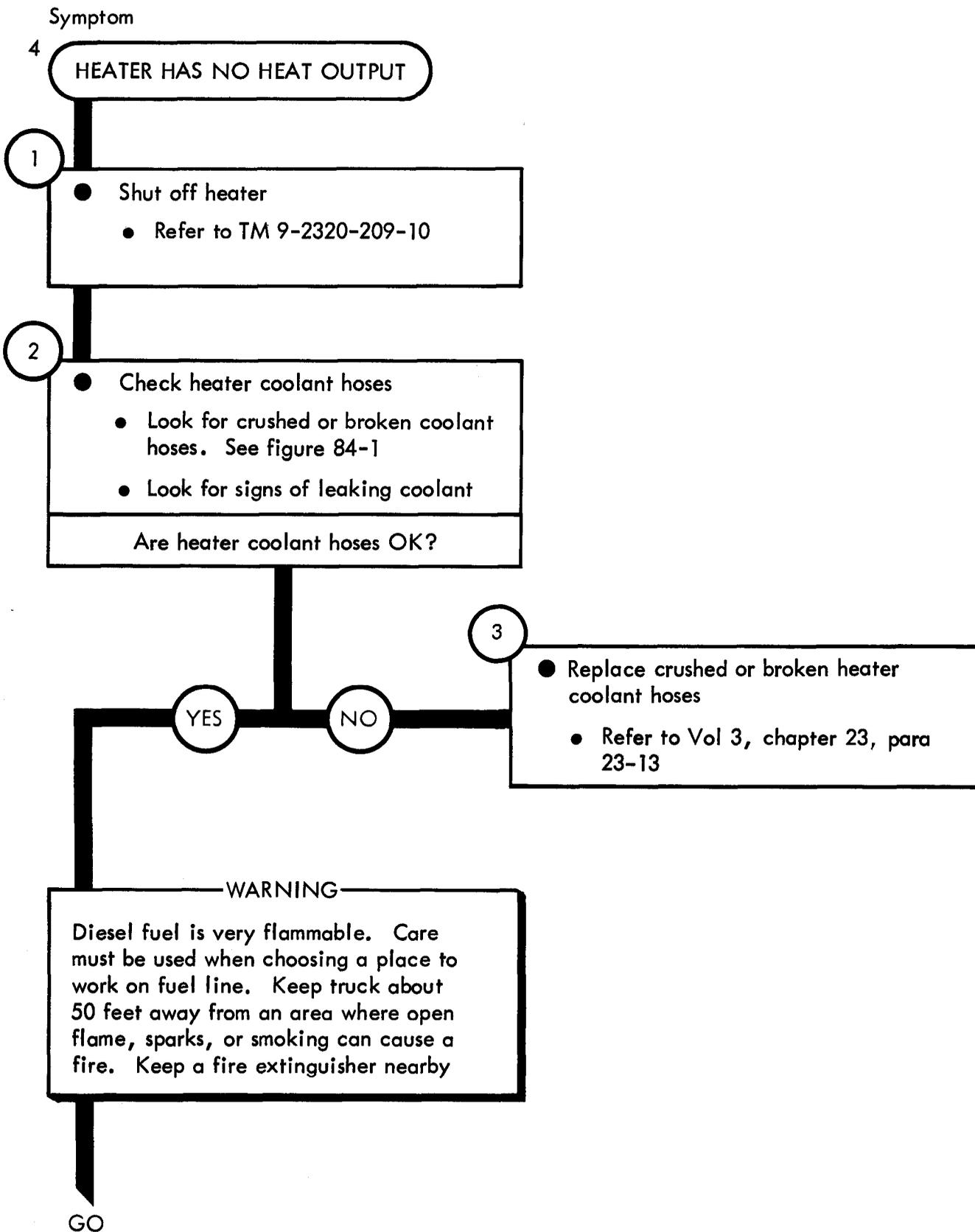
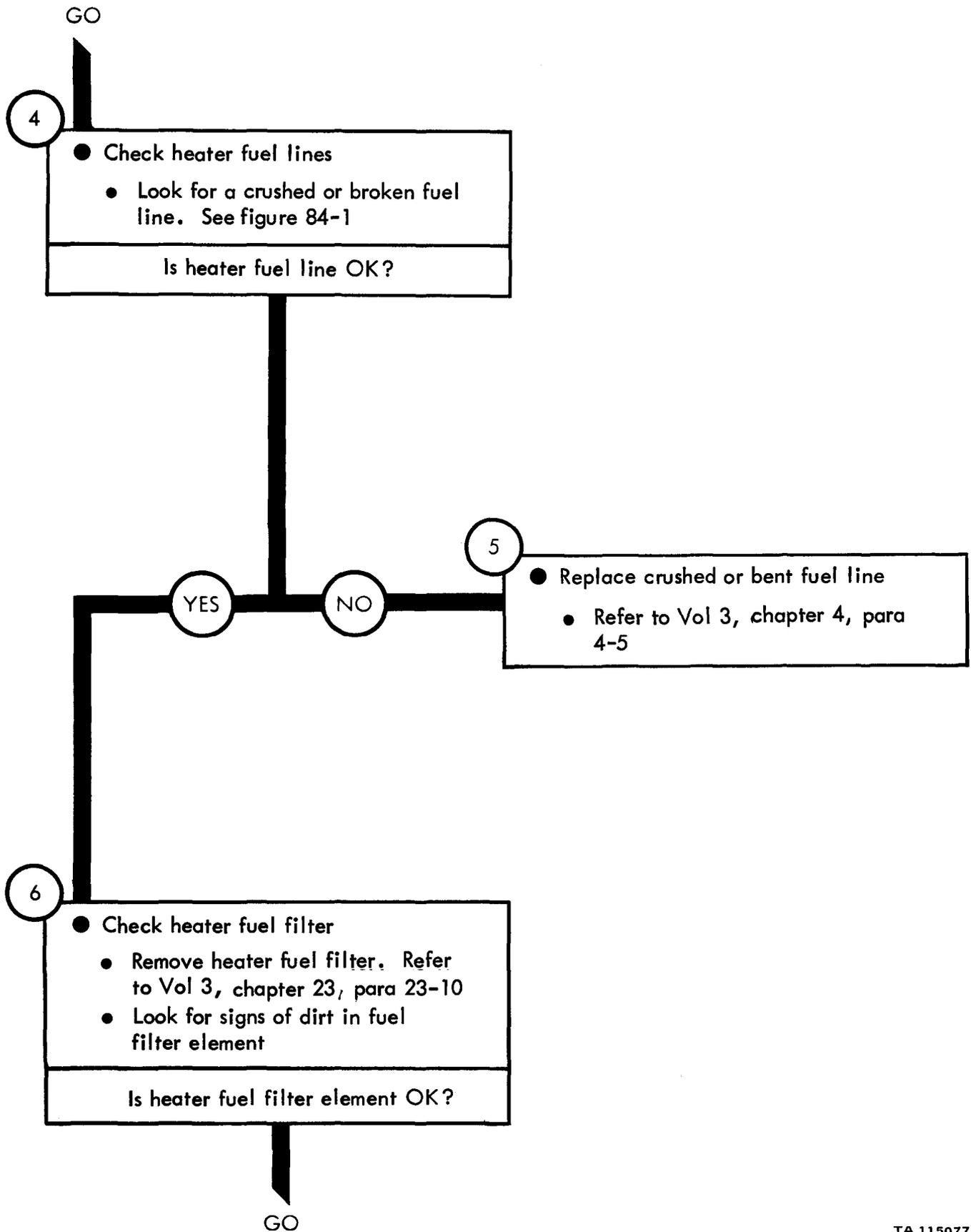

Figure 82-4 (Sheet 1 of 3)



TA 115077

Figure 82-4 (Sheet 2 of 3)

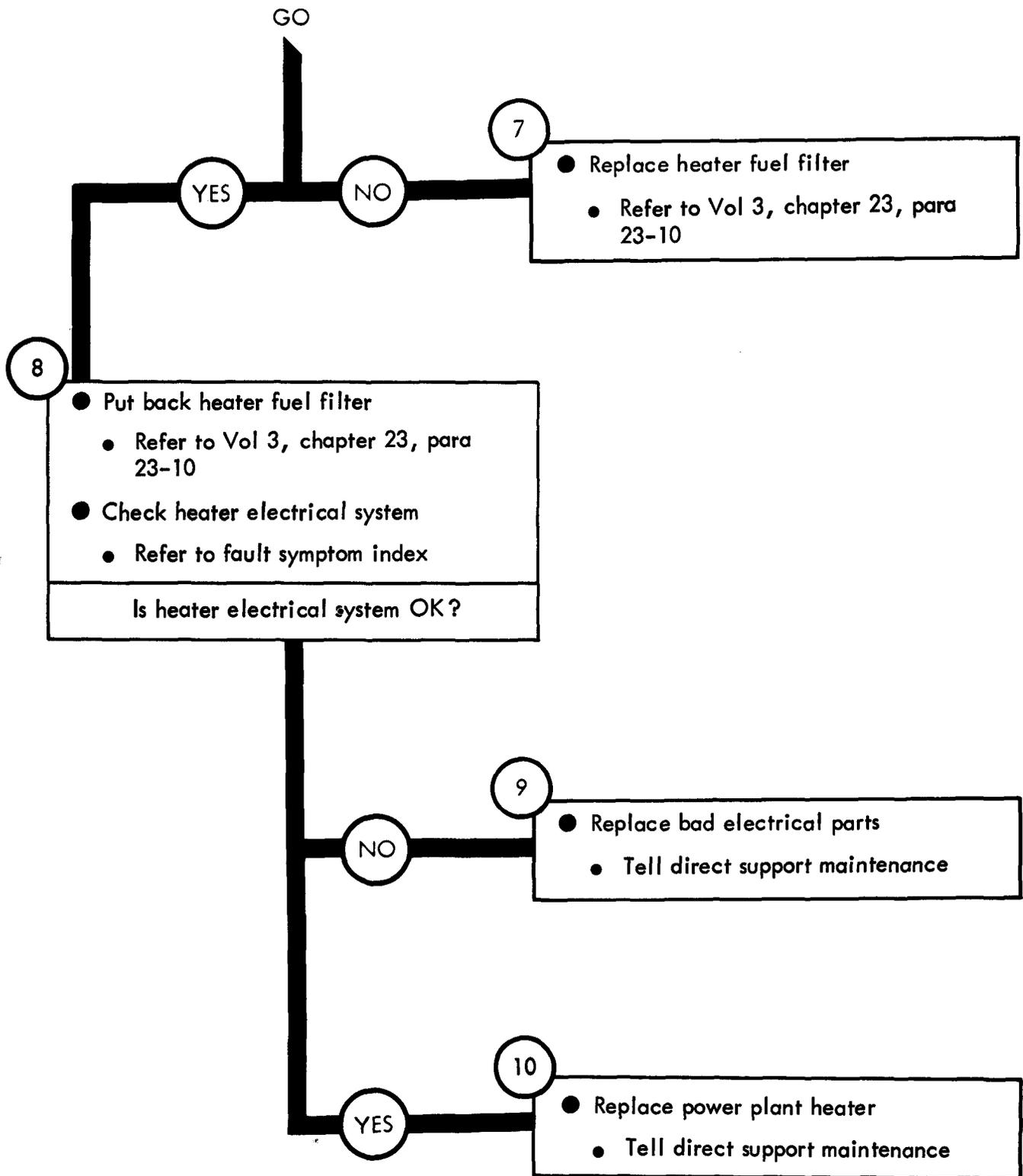

Figure 82-4 (Sheet 3 of 3)

TA 115078

Symptom

5

BLOWER WORKS, BUT THERE IS NO HEAT IN SYSTEM

1

- Shut off heater
 - Refer to TM 9-2320-209-10

WARNING

Diesel fuel is very flammable. Care must be used when choosing a place to work on fuel line. Keep truck about 50 feet away from an area where open flame, sparks, or smoking can cause a fire. Keep a fire extinguisher nearby

2

- Check heater fuel lines
 - Look for a crushed or bent fuel line. See figure 84-1

Is heater fuel line OK?

YES

NO

3

- Replace crushed or bent fuel line
 - Refer to Vol 3, chapter 4, para 4-5

GO

Figure 82-5 (Sheet 1 of 4)

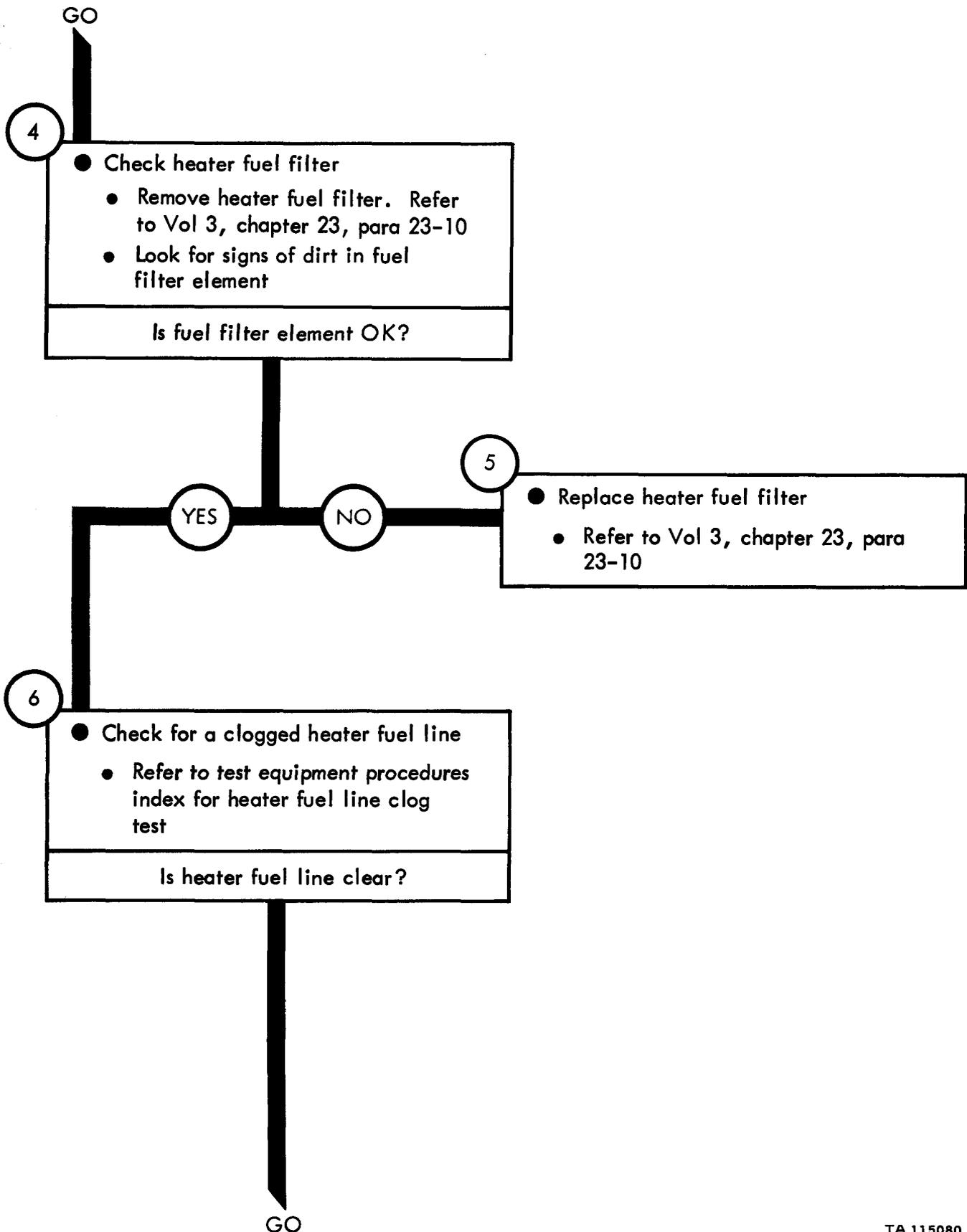

TA 115080

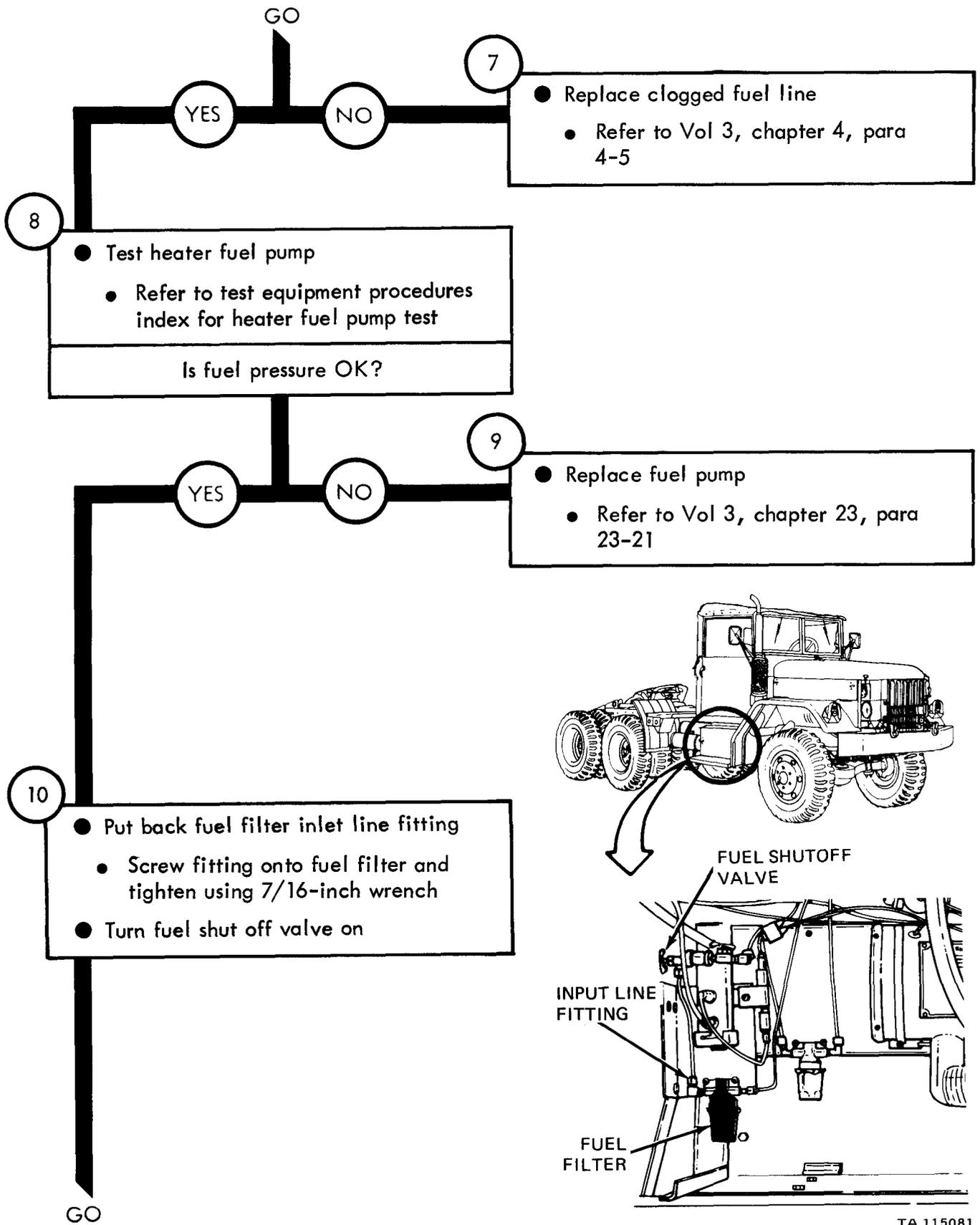

TA 115081

Figure 82-5 (Sheet 3 of 4)

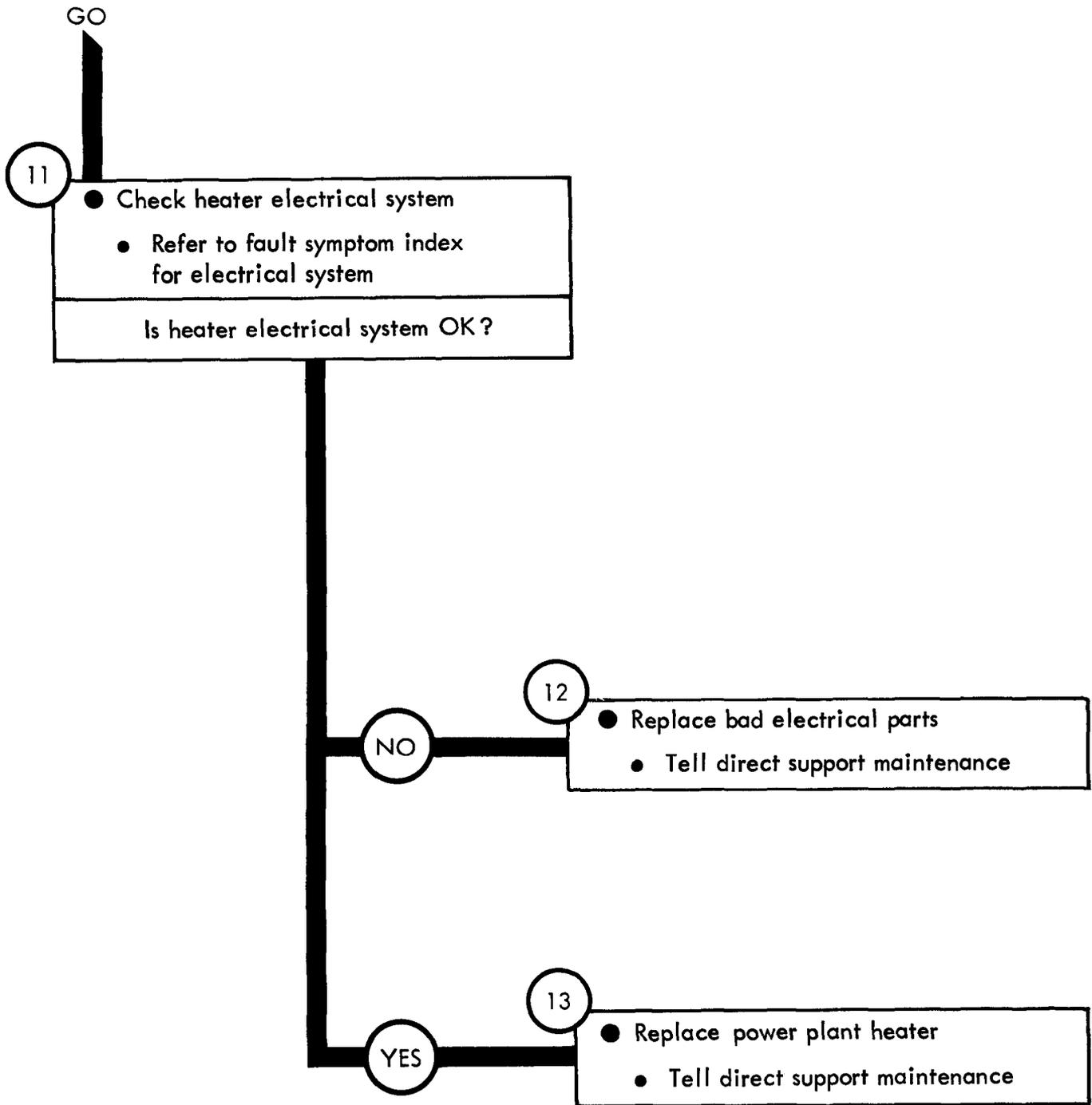

CHAPTER 83

ENGINE COOLANT HEATER TROUBLESHOOTING SUMMARY

83-1. GENERAL. This chapter gives a summary of troubleshooting procedures given in chapter 82 for the engine coolant heater.

83-2. PROCEDURES. The summary in this chapter covers all fault symptoms found in the detailed troubleshooting procedures. Chapter 7 outlines a sample troubleshooting procedure. The summary procedures are based on the "what-to-do" portions of the detailed procedures and do not include the "how-to-do-it" instructions. Warnings, cautions, and notes are given where needed.

ENGINE COOLANT HEATER TROUBLESHOOTING SUMMARY

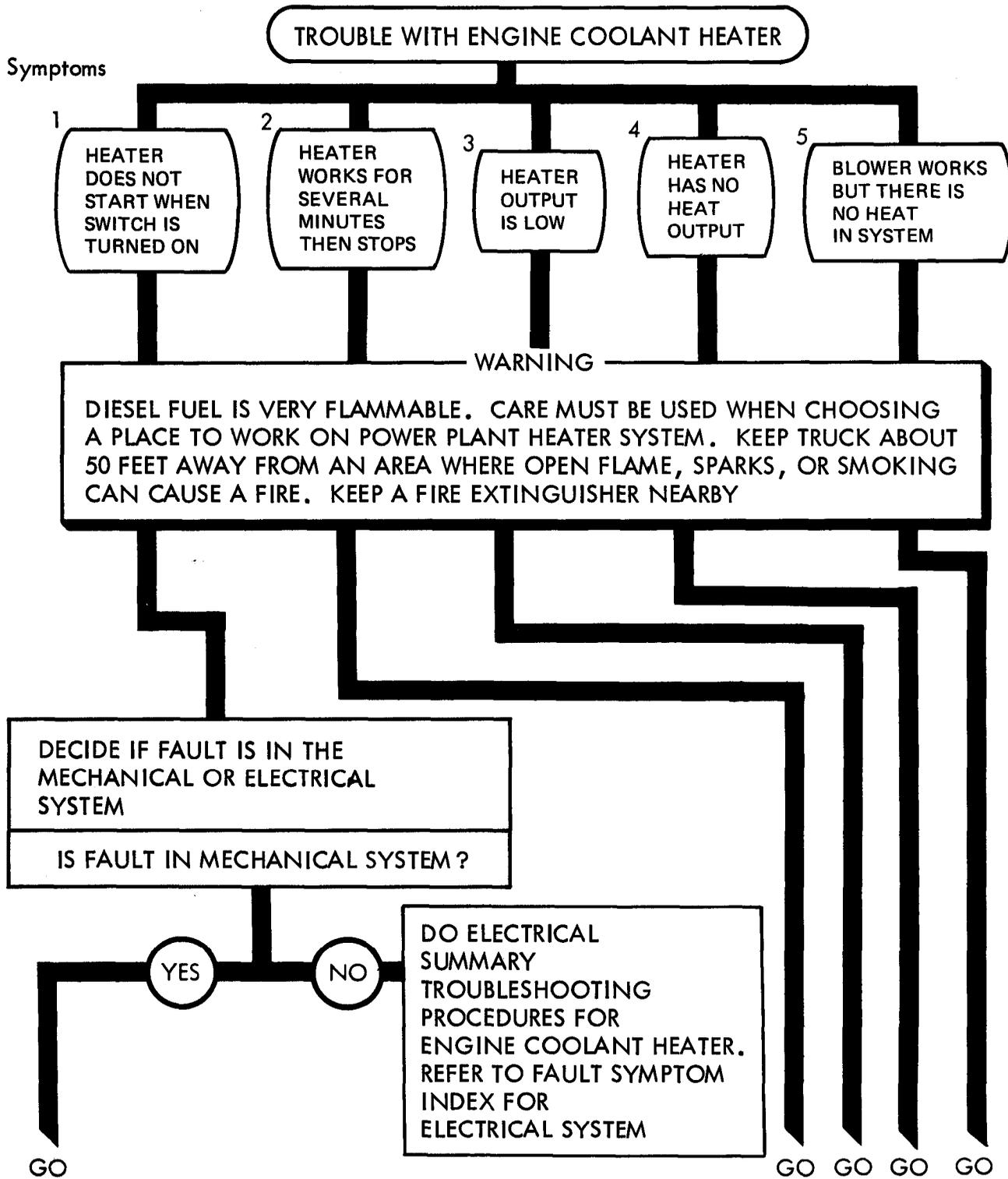
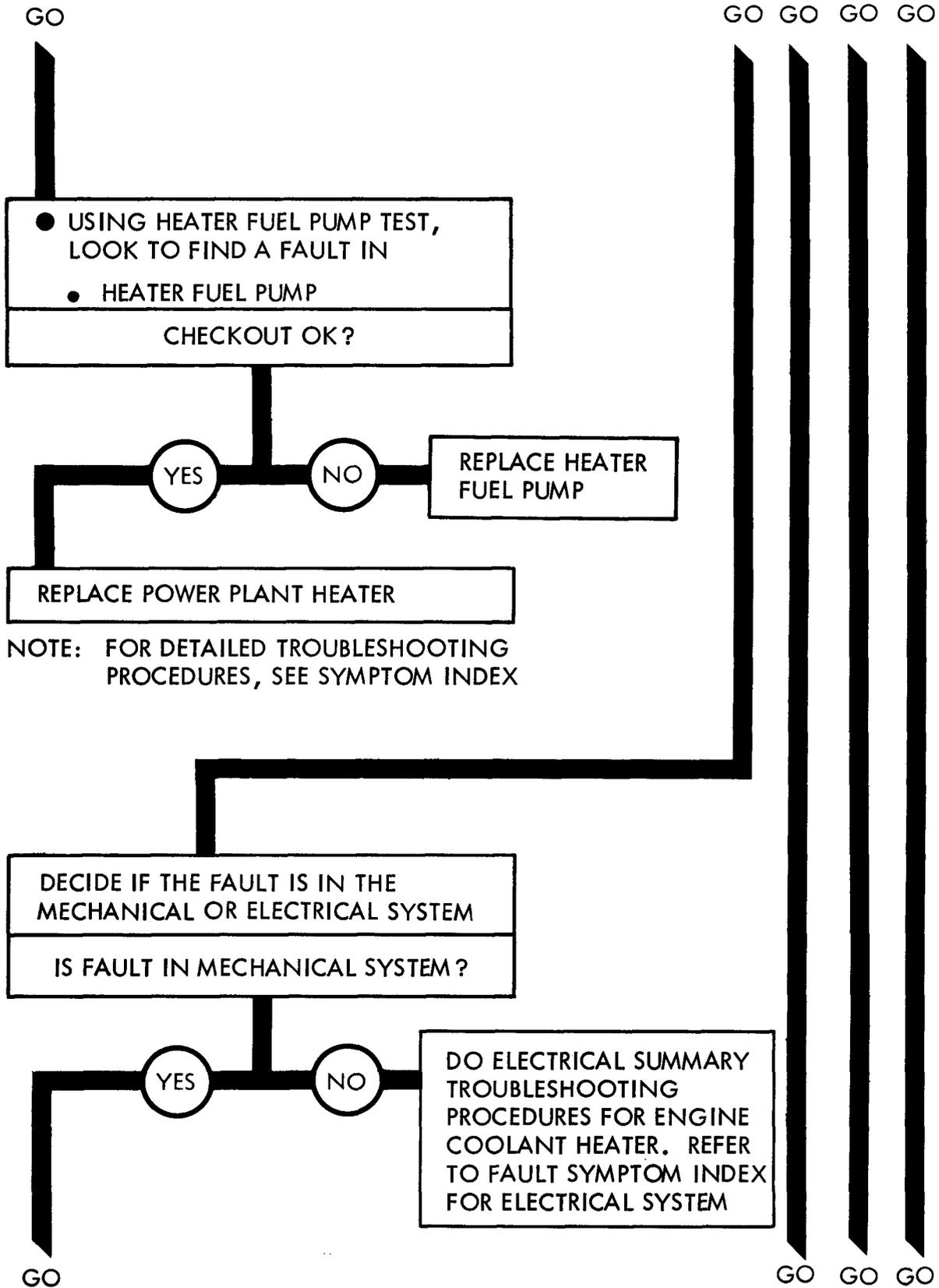

Figure 83-1 (Sheet 1 of 6)



NOTE: FOR DETAILED TROUBLESHOOTING PROCEDURES, SEE SYMPTOM INDEX

Figure 83-1 (Sheet 2 of 6)

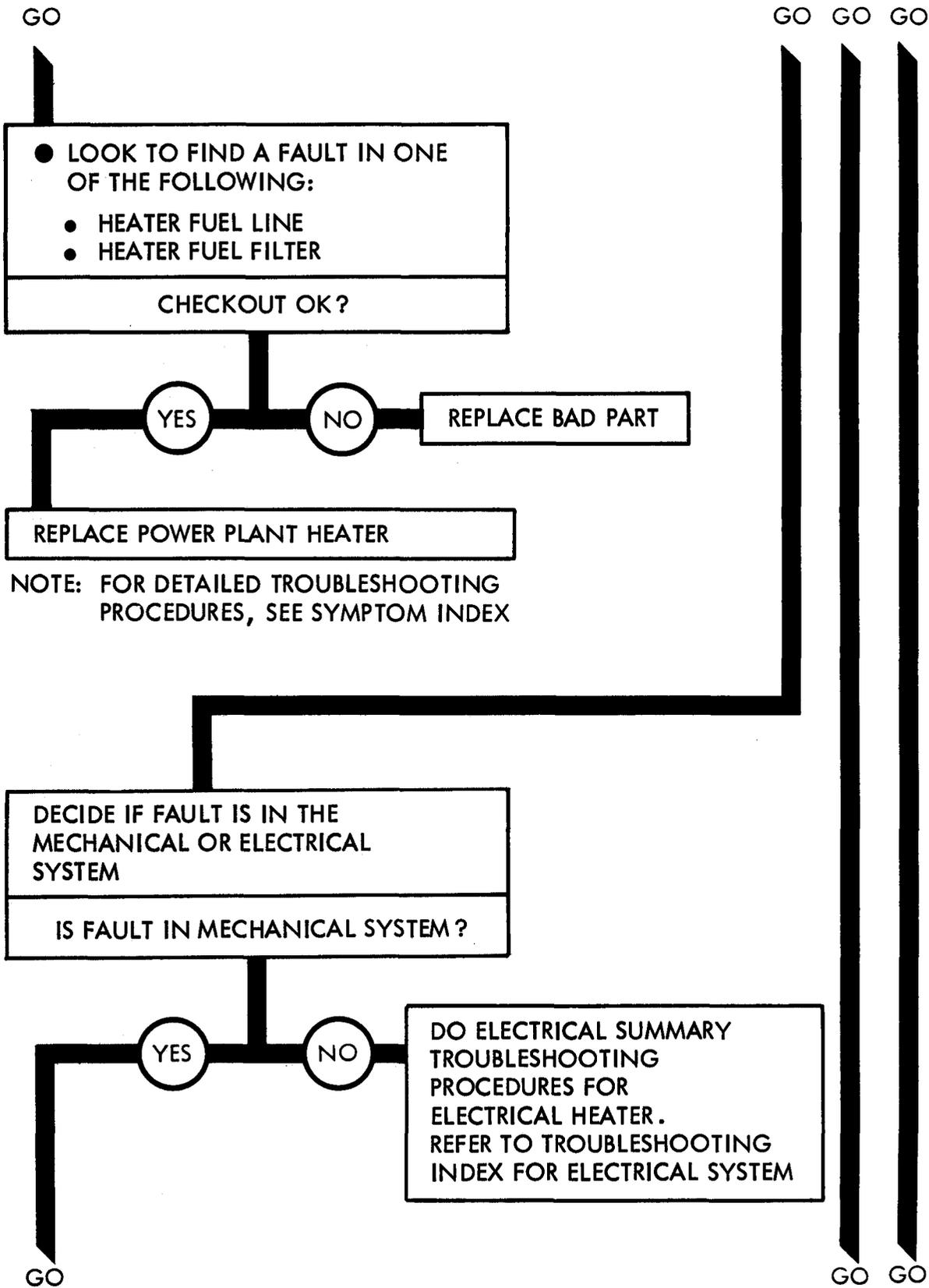
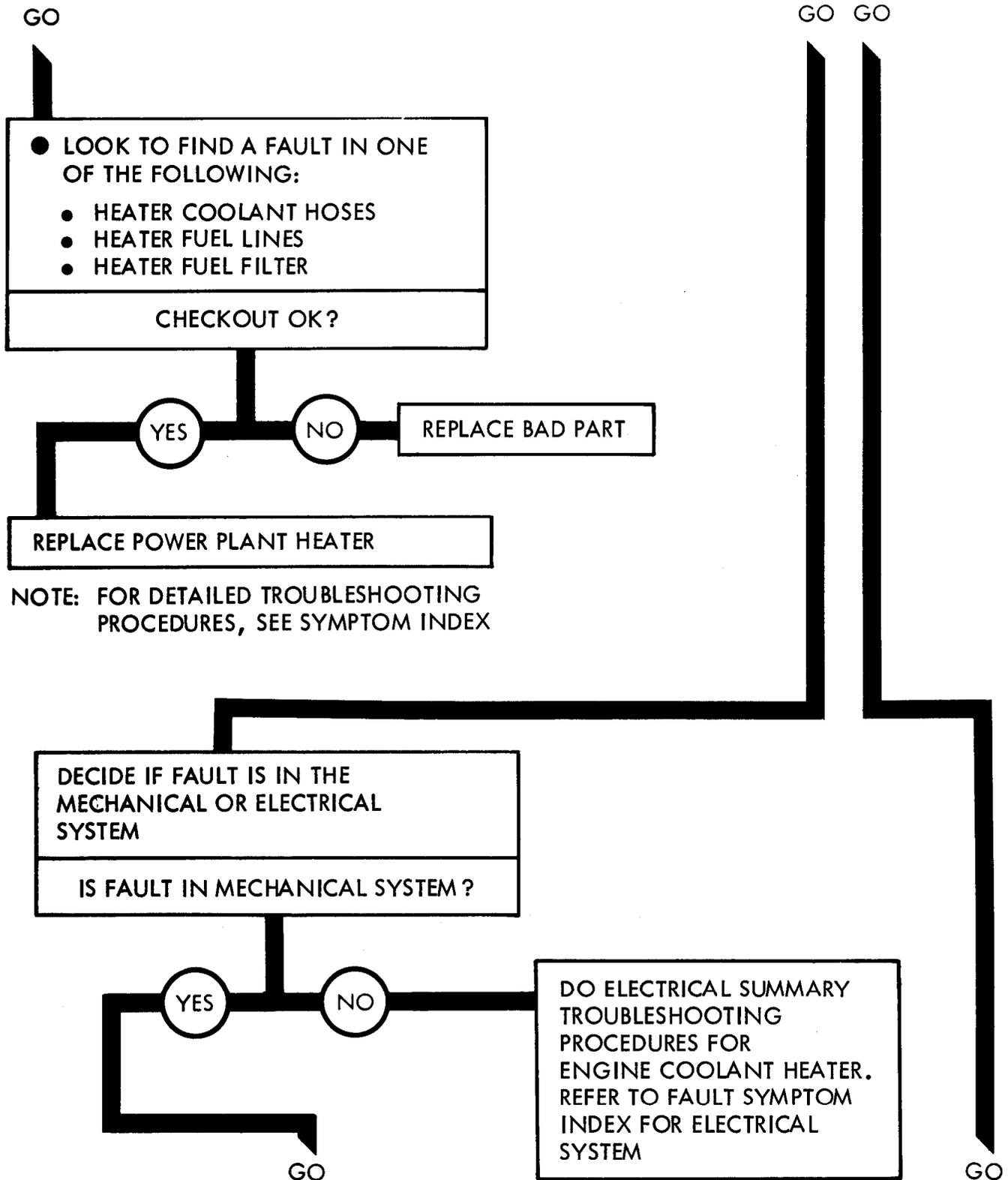

Figure 83-1 (Sheet 3 of 6)



NOTE: FOR DETAILED TROUBLESHOOTING PROCEDURES, SEE SYMPTOM INDEX

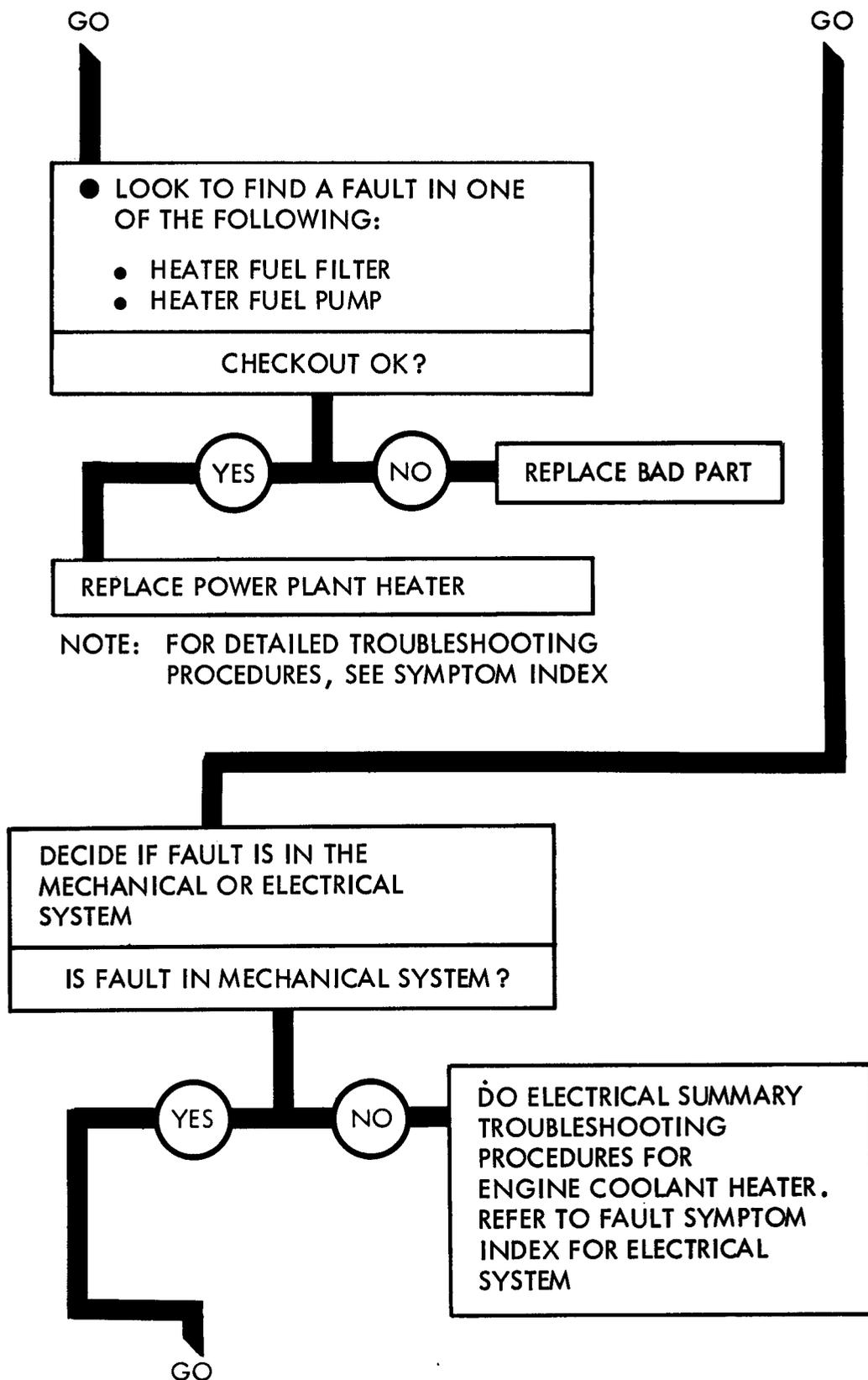
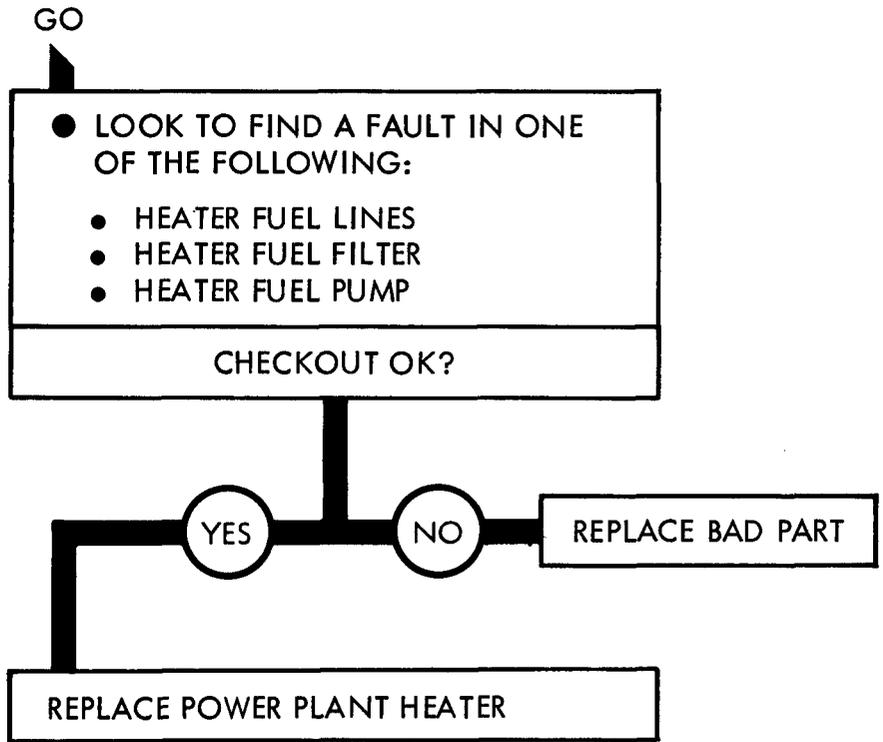

Figure 83-1 (Sheet 5 of 6)

TA 115089



NOTE: FOR DETAILED TROUBLESHOOTING PROCEDURES, SEE SYMPTOM INDEX

CHAPTER 84

ENGINE COOLANT HEATER SUPPORT DIAGRAMS

84-1. GENERAL. This chapter gives the diagrams you need when doing troubleshooting procedures in chapter 82. Table 3-1 is a complete listing of all support diagrams used in this manual.

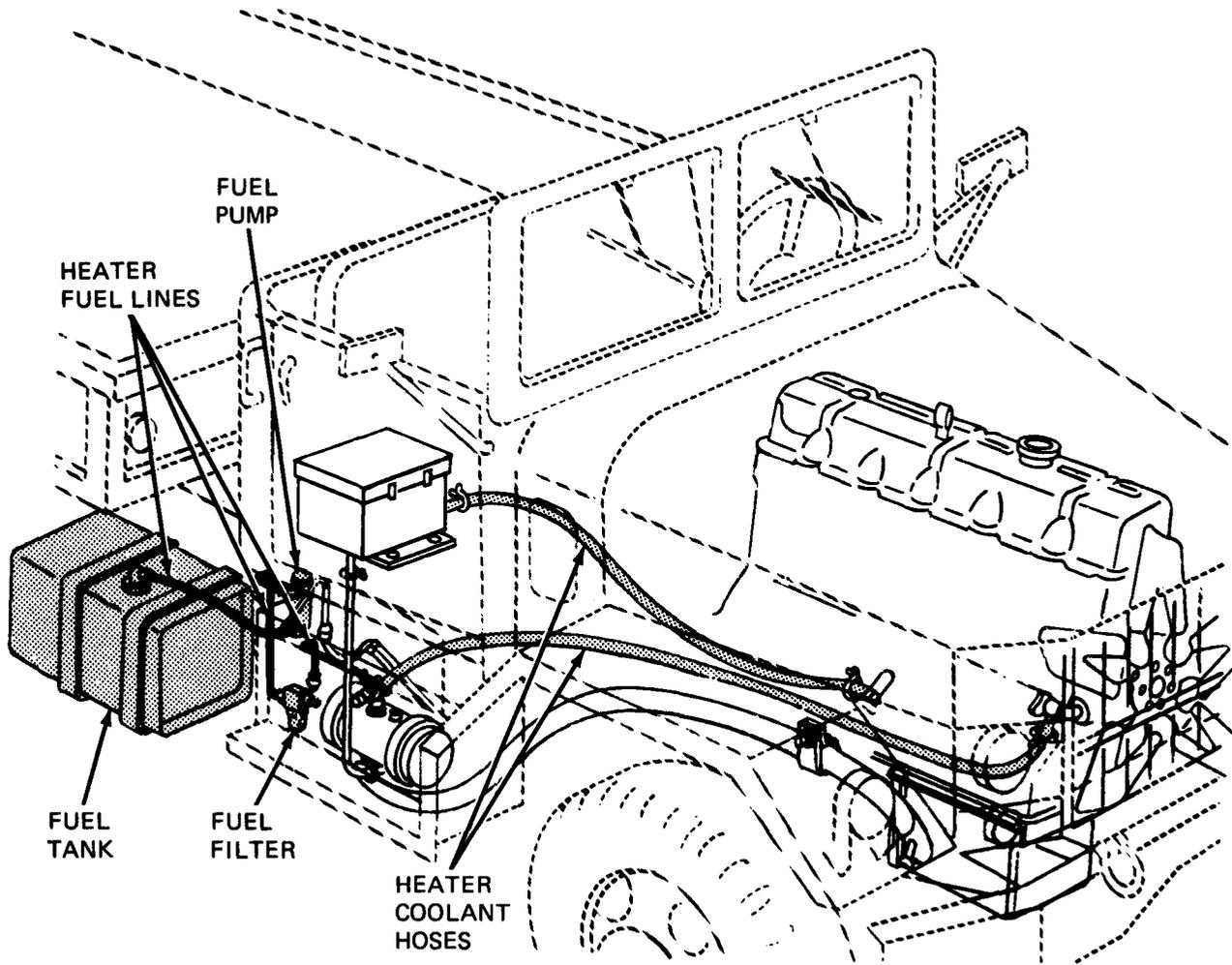

TA 115091

Figure 84-1. Engine Coolant Heater Support Diagram

CHAPTER 85

ENGINE COLANT HEATER TEST PROCEDURES

85-1. GENERAL. This chapter gives test procedures for the tests given in chapter 82, for the engine coolant heater.

85-2. TEST SET-UP. Instructions for setup of test equipment and parts to be tested are given before the test procedures. Illustrations are used, when needed, to show you how to hook up the test equipment to the part to be tested.

85-3. TEST PROCEDURE. Detailed step-by-step instructions, in flow chart form, are given for each test. The procedure calls out the type of test and the condition of the truck system for each part of testing. The step-by-step test will lead you to the bad component or to a fault symptom within a related system. Reference is made to the fault symptom index, chapter 6, if the test shows a fault in another system.

HEATER FUEL LINE CLOG CHECK

WARNING

Diesel fuel is very flammable. Care must be used when choosing a place to work on fuel pump. Keep truck about 50 feet away from an area where open flame, sparks, or smoking can cause a fire. Keep a fire extinguisher nearby

NOTE

This procedure will need the use of two soldiers. The lead soldier will be called soldier A and the helper will be called soldier B

● **Check for a clogged heater fuel line**

- SOLDIER A:**
- Using 7/16-inch wrench unscrew fittings from both ends of the fuel tank to fuel pump heater fuel line. See figure 84-1
 - Put a can under heater fuel line at pump

WARNING

Eye shields must be worn when using compressed air. Eye injury can occur if eye shields are not used

SOLDIER A:

- Using compressed air blow through heater fuel line at fuel tank end

SOLDIER B:

- Put hand over fuel pump end of heater fuel line and feel for air flow

Note: If heater fuel line is clogged no air will be felt by soldier B. If air is felt that means the line is clean and should be put back on fuel pump and fuel tank and tightened using 7/16-inch wrench

TA 115083

Figure 85-1

HEATER FUEL PUMP CHECK

WARNING

Diesel fuel is very flammable. Care must be used when choosing a place to work on fuel line. Keep truck about 50 feet away from an area where open flame, sparks, or smoking can cause a fire. Keep a fire extinguisher nearby

- Check heater fuel pump
 - Turn fuel shutoff valve off
 - Using 7/16-inch wrench unscrew fuel filter input line fitting
 - Point fitting end in can

- Start heater and let run for about 30 seconds. Refer to TM 9-2320-209-10
- Shut off heater. Refer to TM 9-2320-209-10
- Look for fuel in can

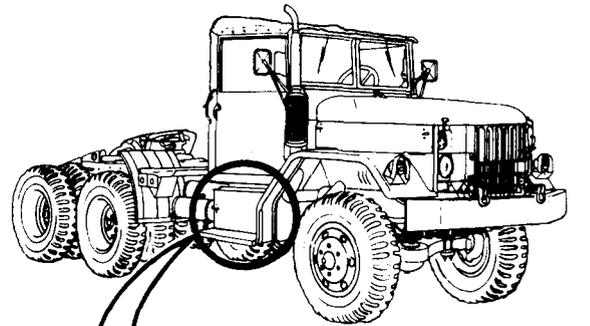

FUEL SHUTOFF VALVE

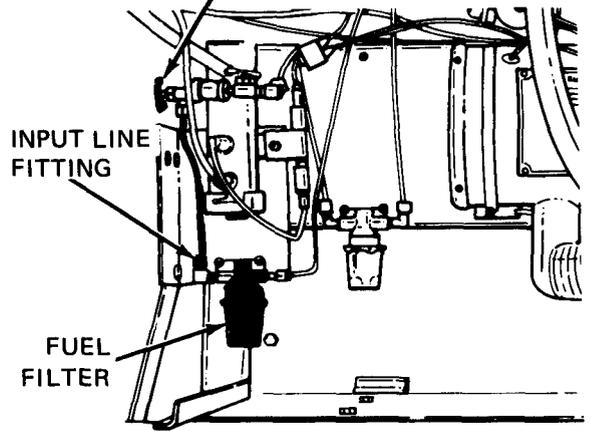

INPUT LINE FITTING

FUEL FILTER

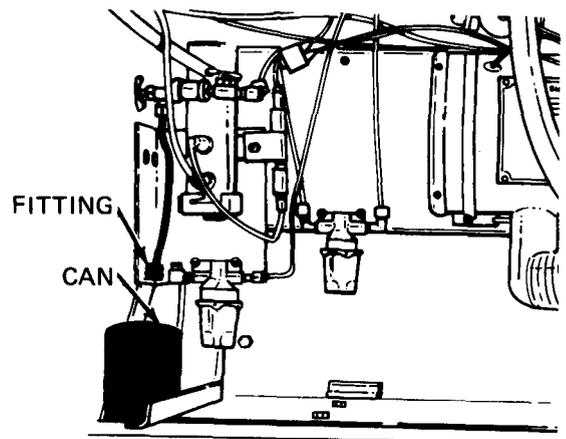

FITTING

CAN

TA 115084

Figure 85-2

CHAPTER 86

ENGINE COOLANT HEATER CHECKOUT PROCEDURES

86-1. GENERAL. This chapter gives procedures for checking out the system after troubleshooting and repair have been done. Procedures are set up in flow chart form showing the checkout steps in order and referring to the fault symptom index when the system does not checkout.

ENGINE COOLANT HEATER CHECKOUT

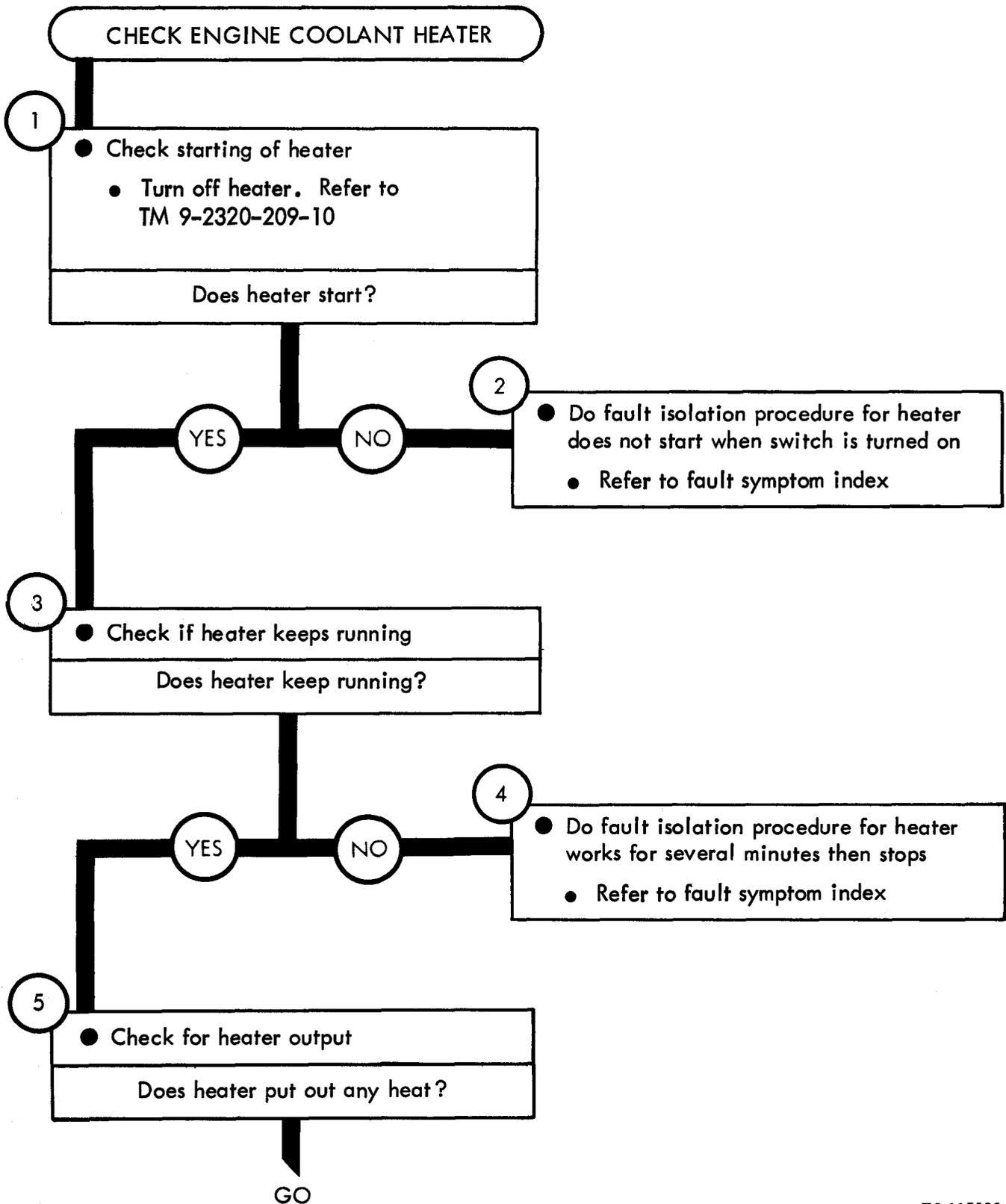

TA 115092

Figure 86-1 (Sheet 1 of 3)

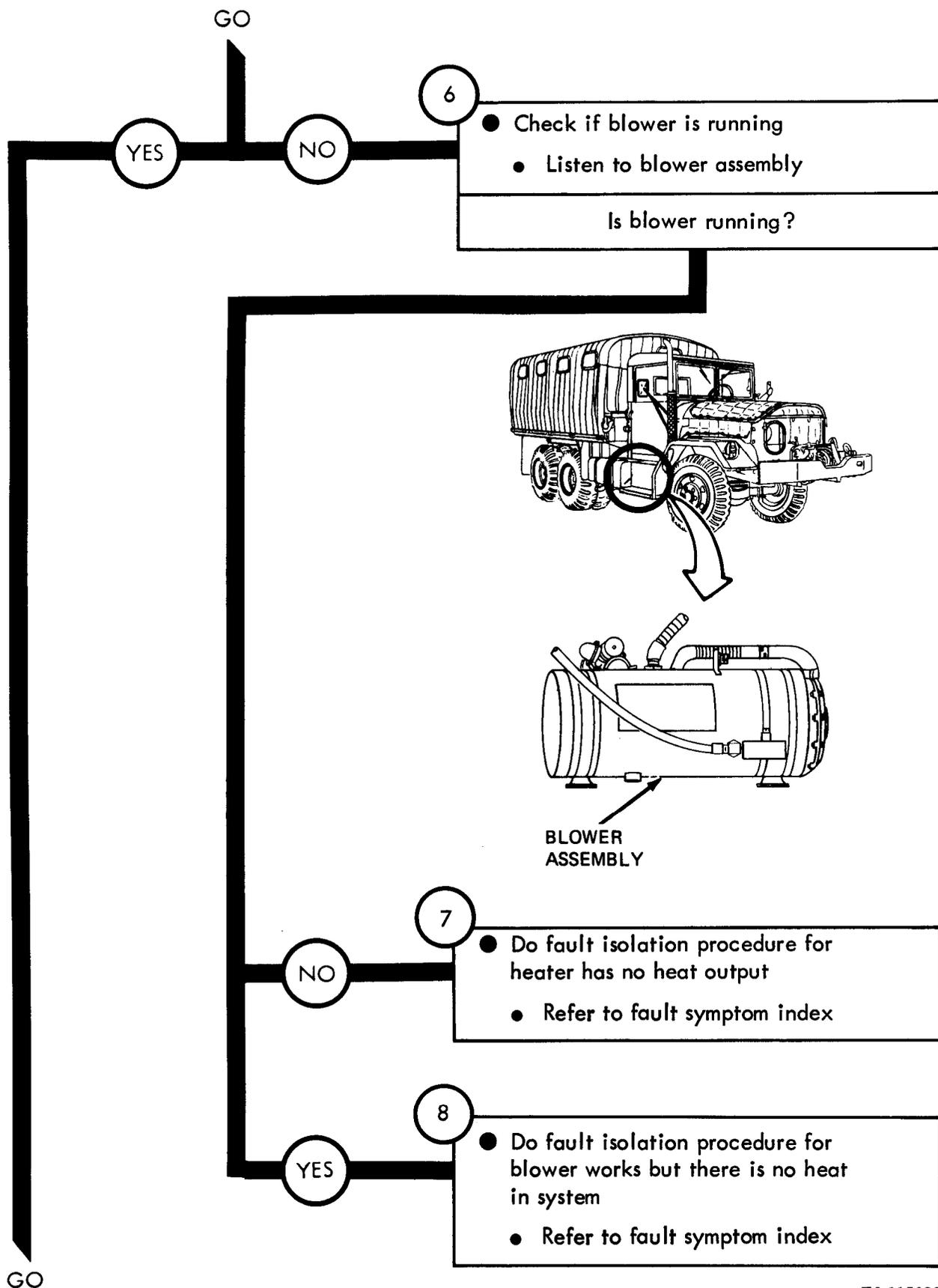

TA 115093

Figure 86-1 (Sheet 2 of 3)

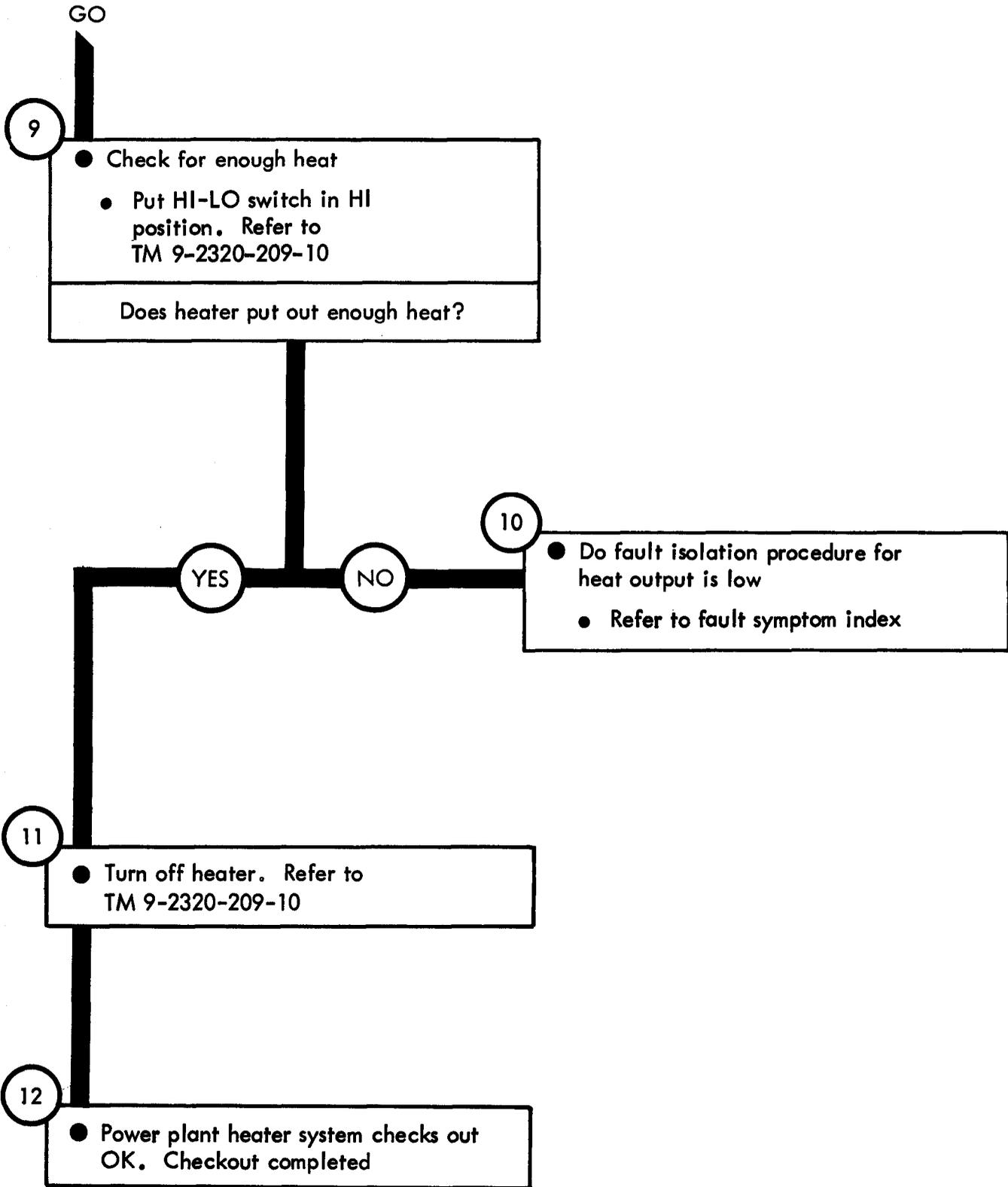

Figure 86-1 (Sheet 3 of 3)

TA 115094

CHAPTER 87

FUEL BURNING PERSONNEL HEATER TROUBLESHOOTING

87-1. EQUIPMENT ITEMS COVERED. This chapter gives equipment troubleshooting procedures for the fuel burning personnel heater, for which there are authorized corrective maintenance tasks at the organizational maintenance level.

87-2. EQUIPMENT ITEMS NOT COVERED. All equipment items for which corrective maintenance is authorized at the organizational maintenance level are covered in this chapter.

FUEL BURNING PERSONNEL HEATER TROUBLESHOOTING

Symptom

1 HEATER DOES NOT START

1

- Shut down heater
- Refer to TM 9-2320-209-10

2

- Check heater fuel filter
 - Take out fuel filter. Refer to Vol 3, chapter 23, para 23-10
 - Look for a dirty or clogged filter

Is heater fuel filter OK?

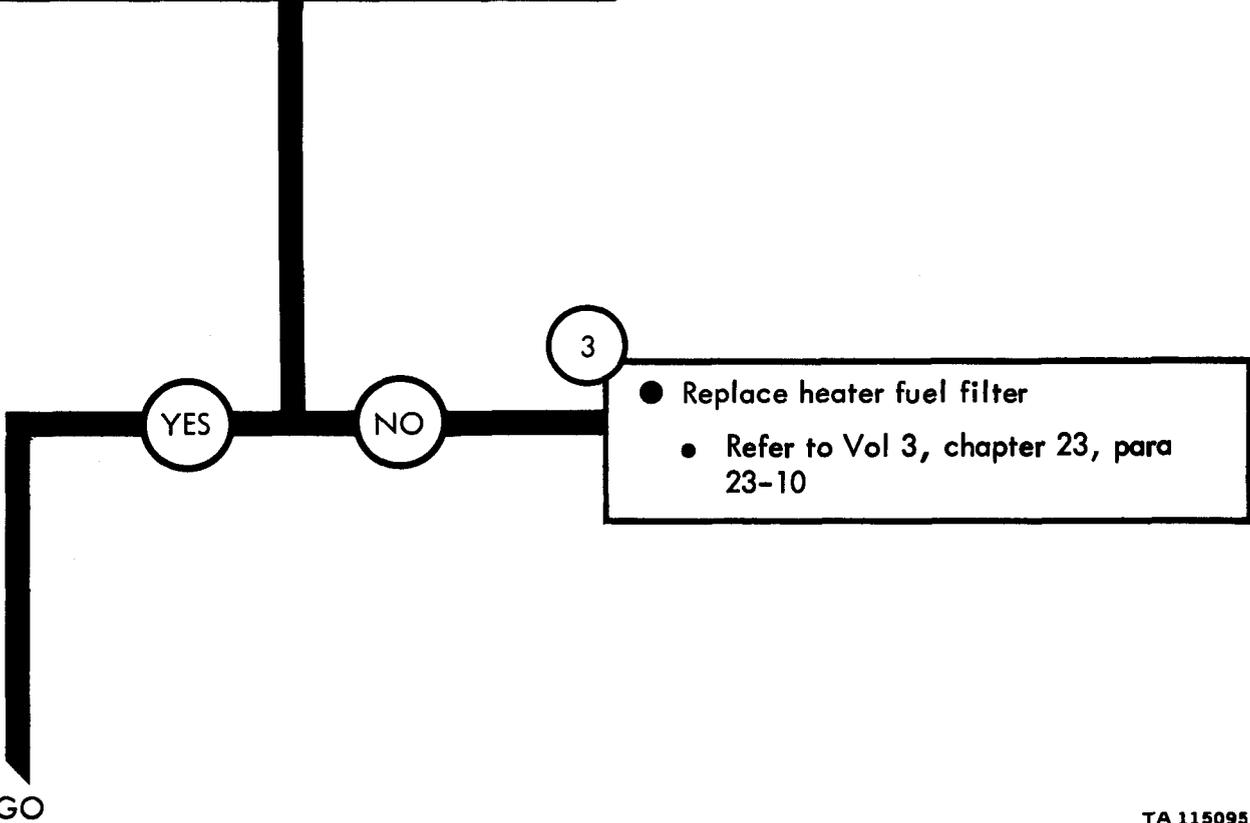

3

- Replace heater fuel filter
- Refer to Vol 3, chapter 23, para 23-10

GO

Figure 87-1 (Sheet 1 of 2)

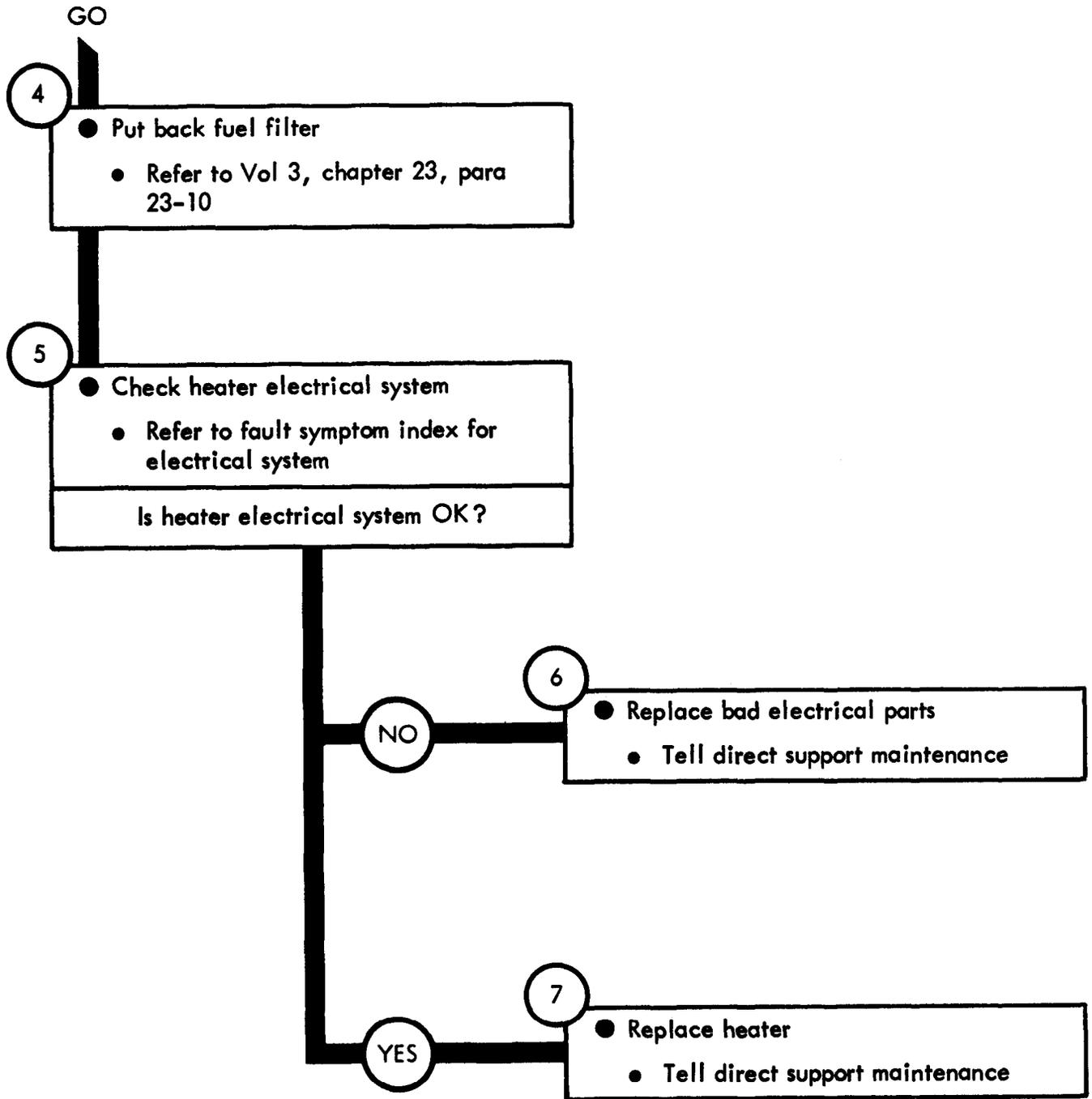

TA 115096

Figure 87-1 (Sheet 2 of 2)

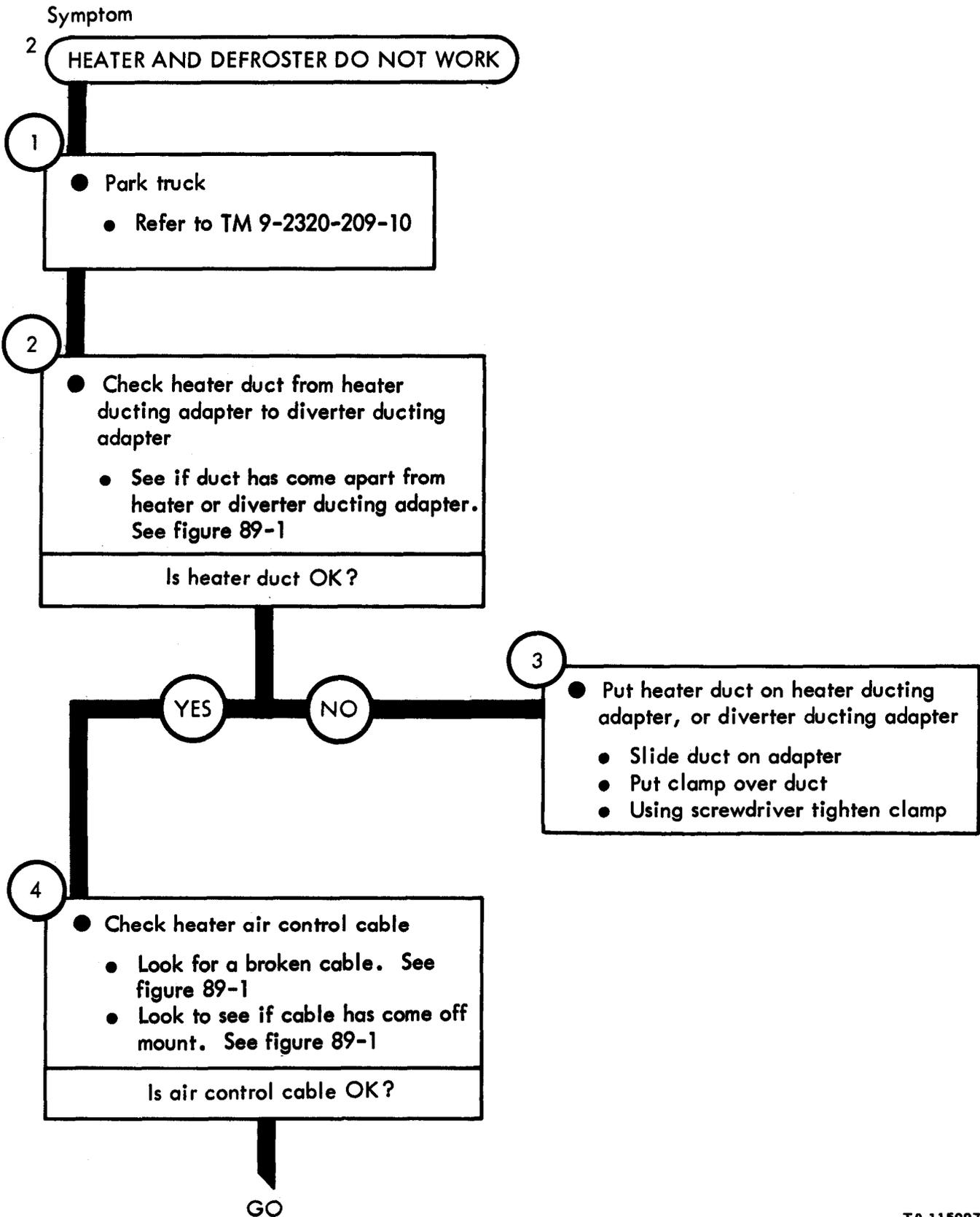

TA 115097

Figure 87-2 (Sheet 1 of 3)

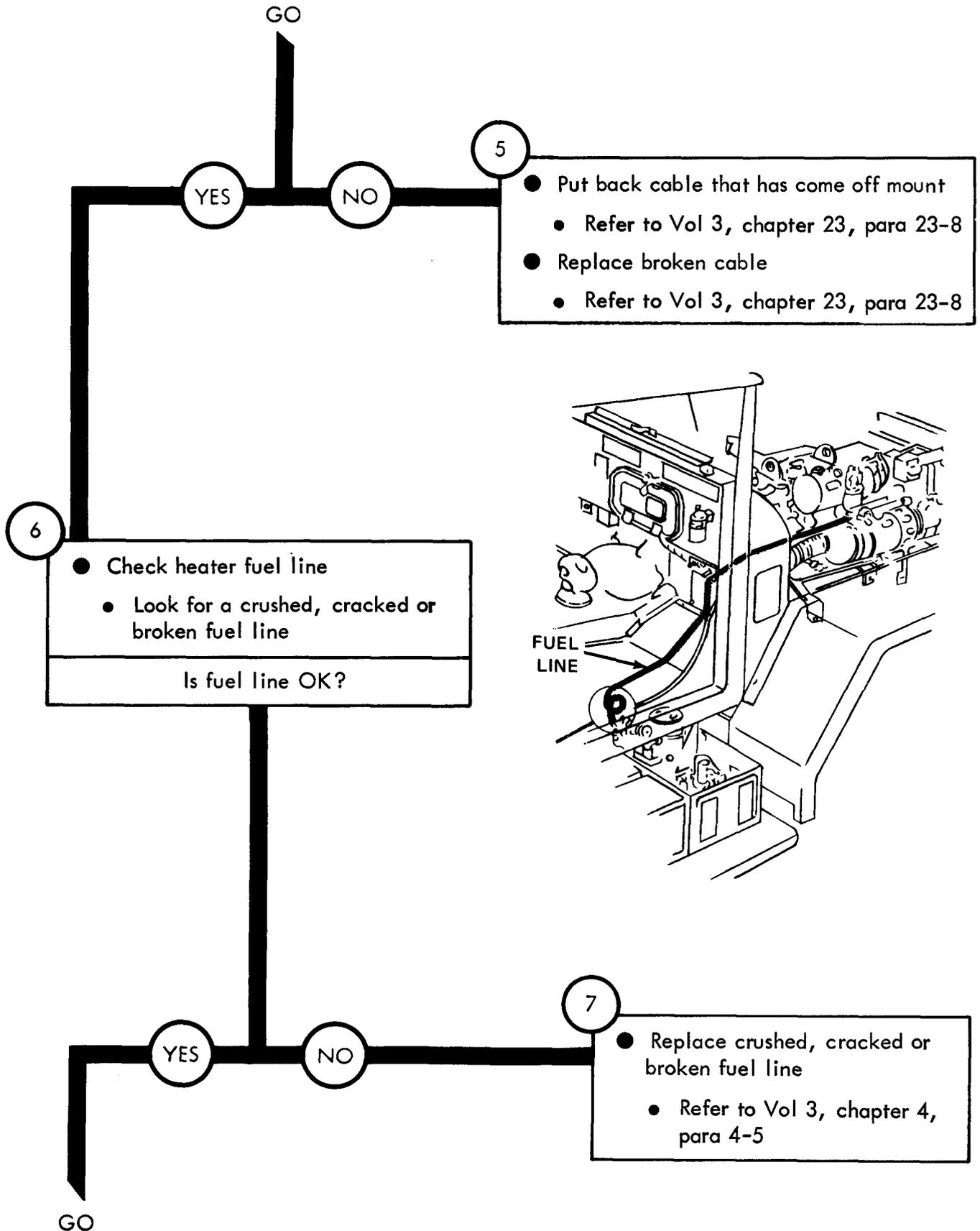
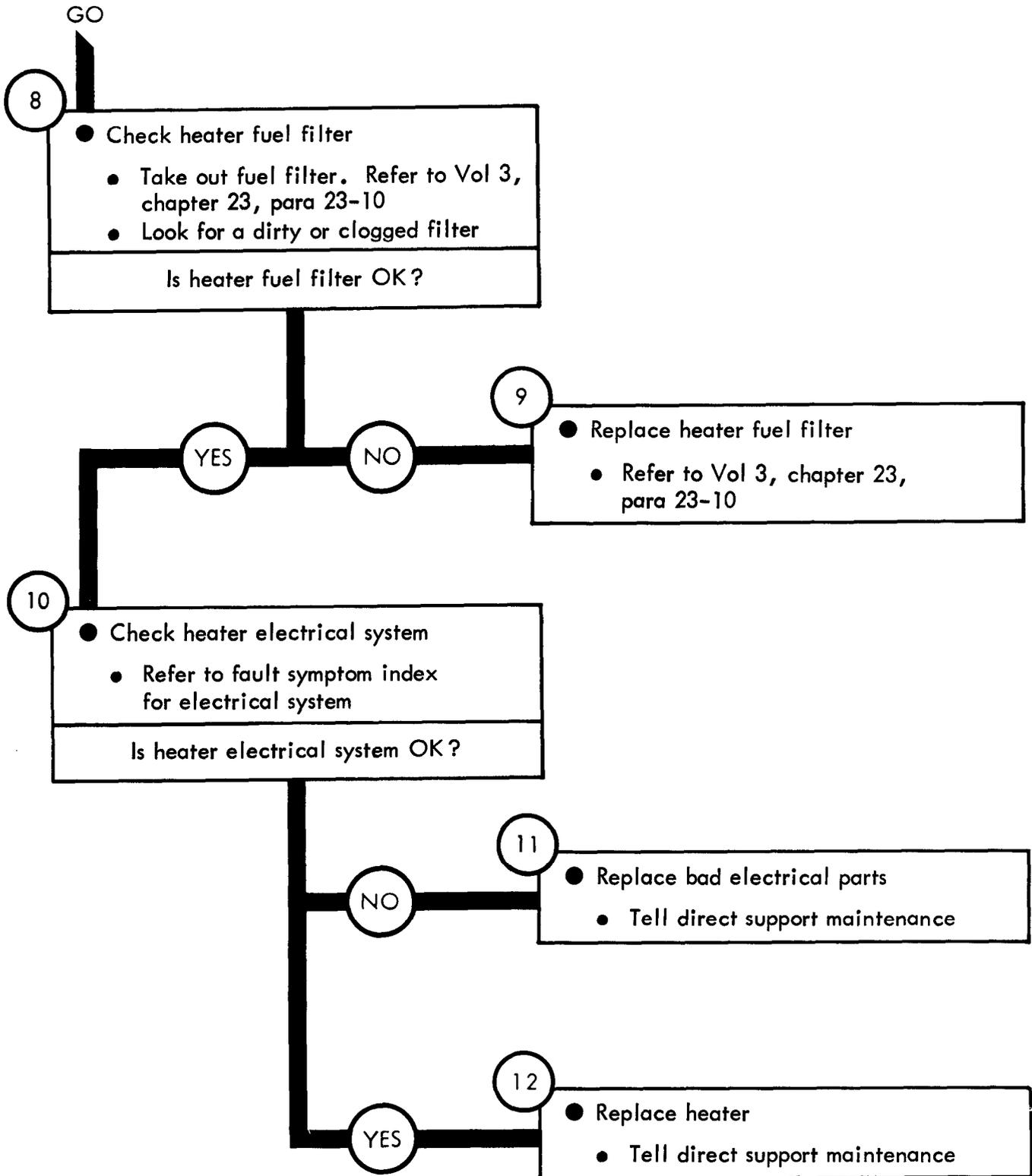

Figure 87-2 (Sheet 2 of 3)



TA 115099

Figure 87-2 (Sheet 3 of 3)

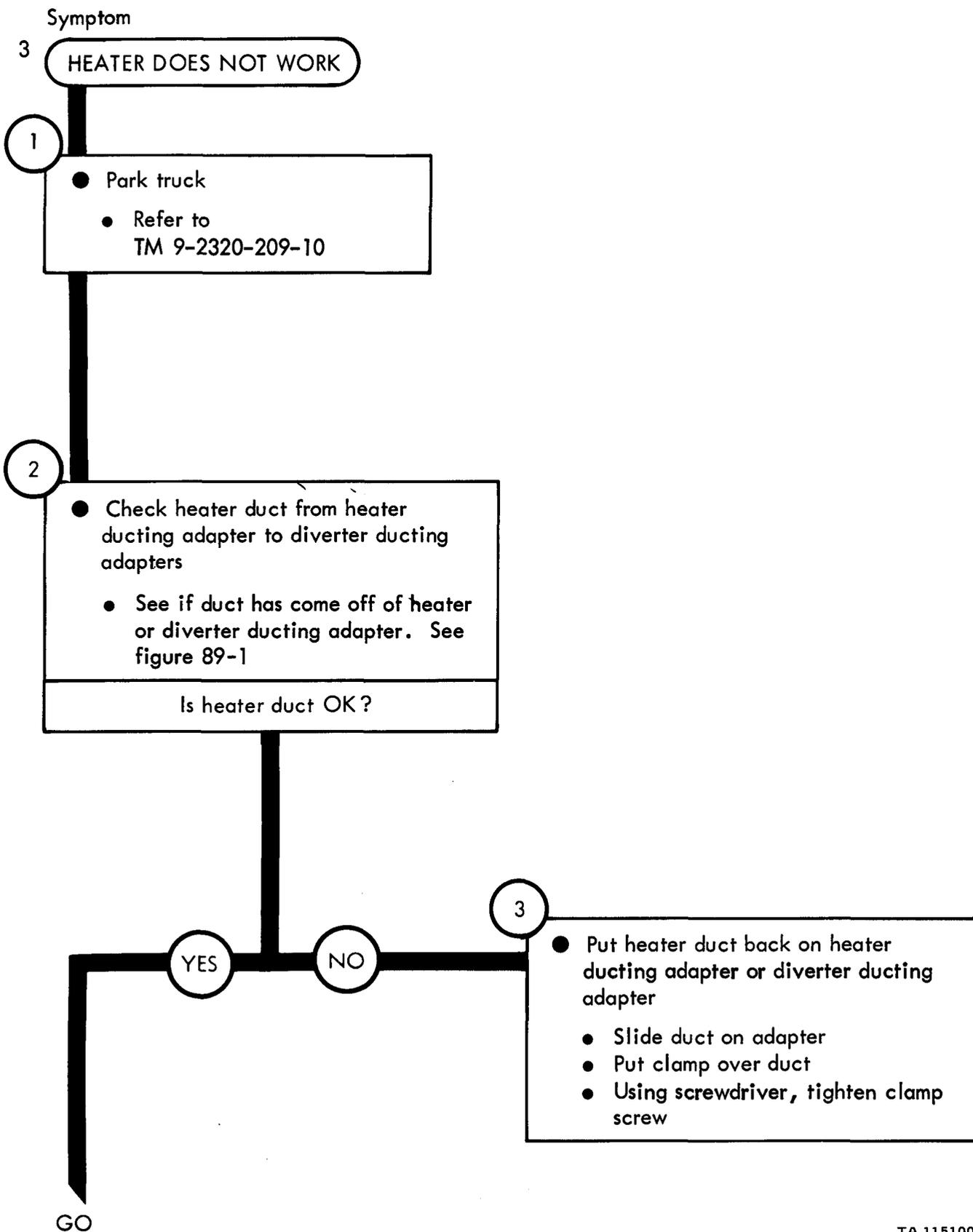

Figure 87-3 (Sheet 1 of 2)

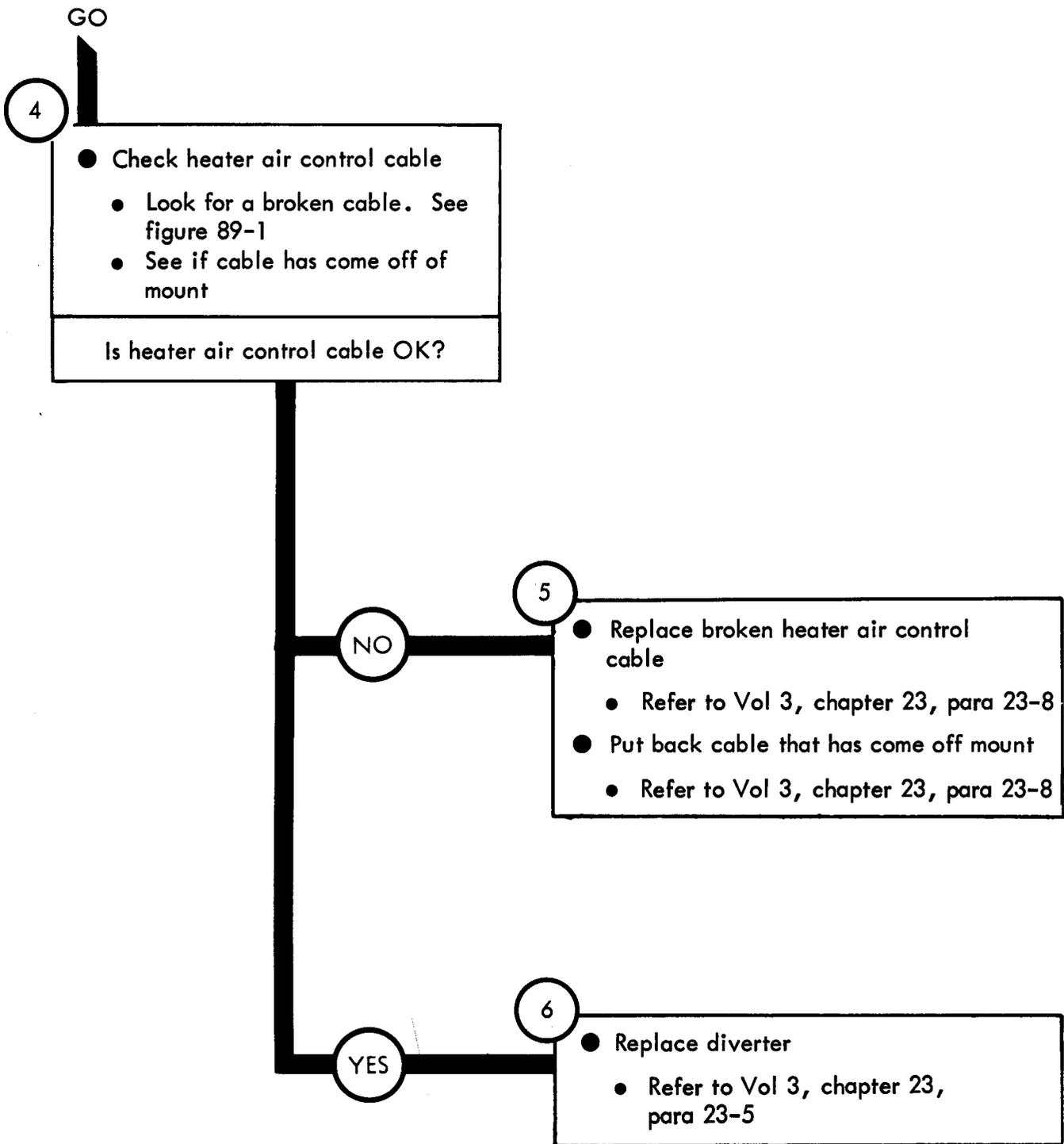
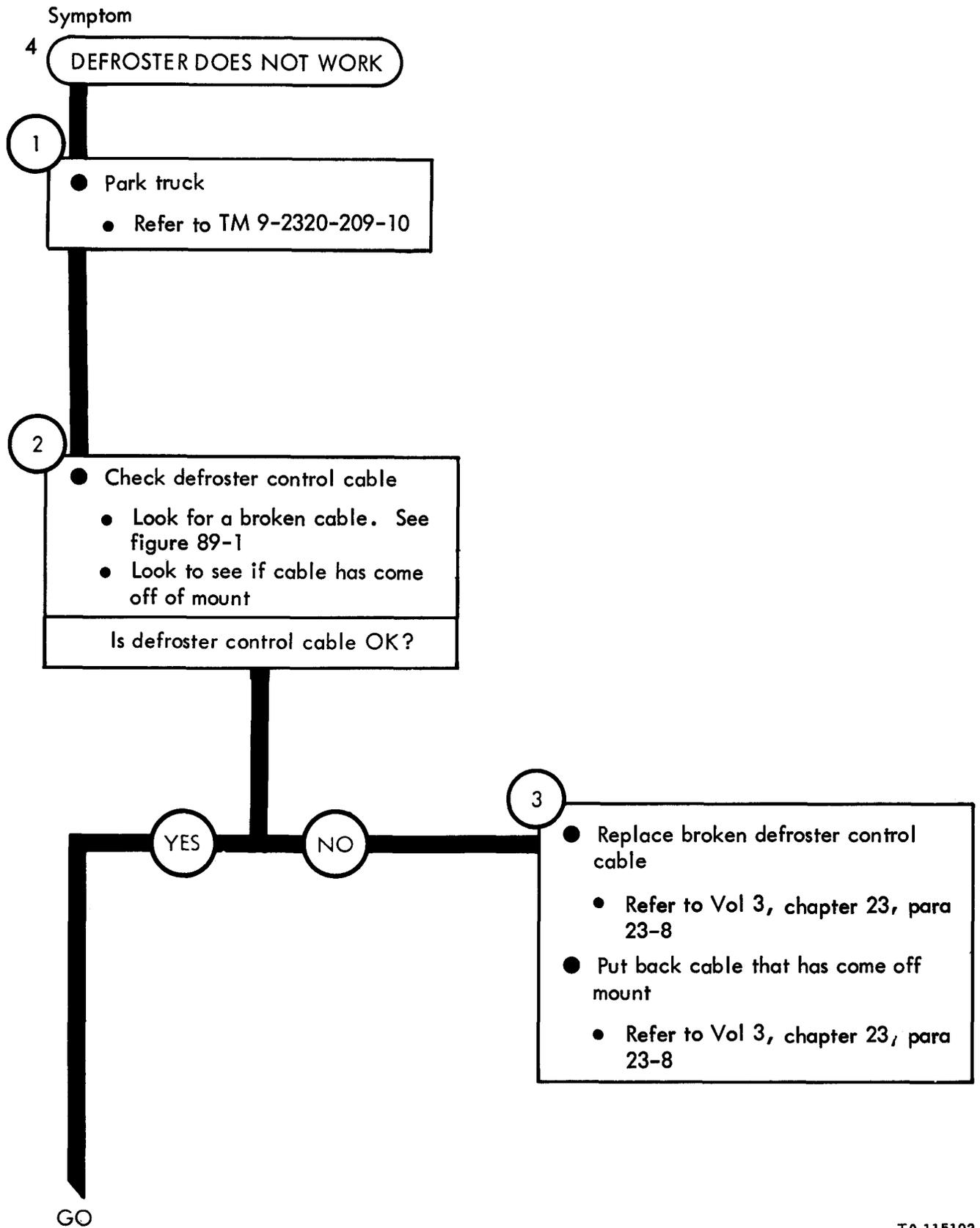

Figure 87-3 (Sheet 2 of 2)



TA 115102

Figure 87-4 (Sheet 1 of 2)

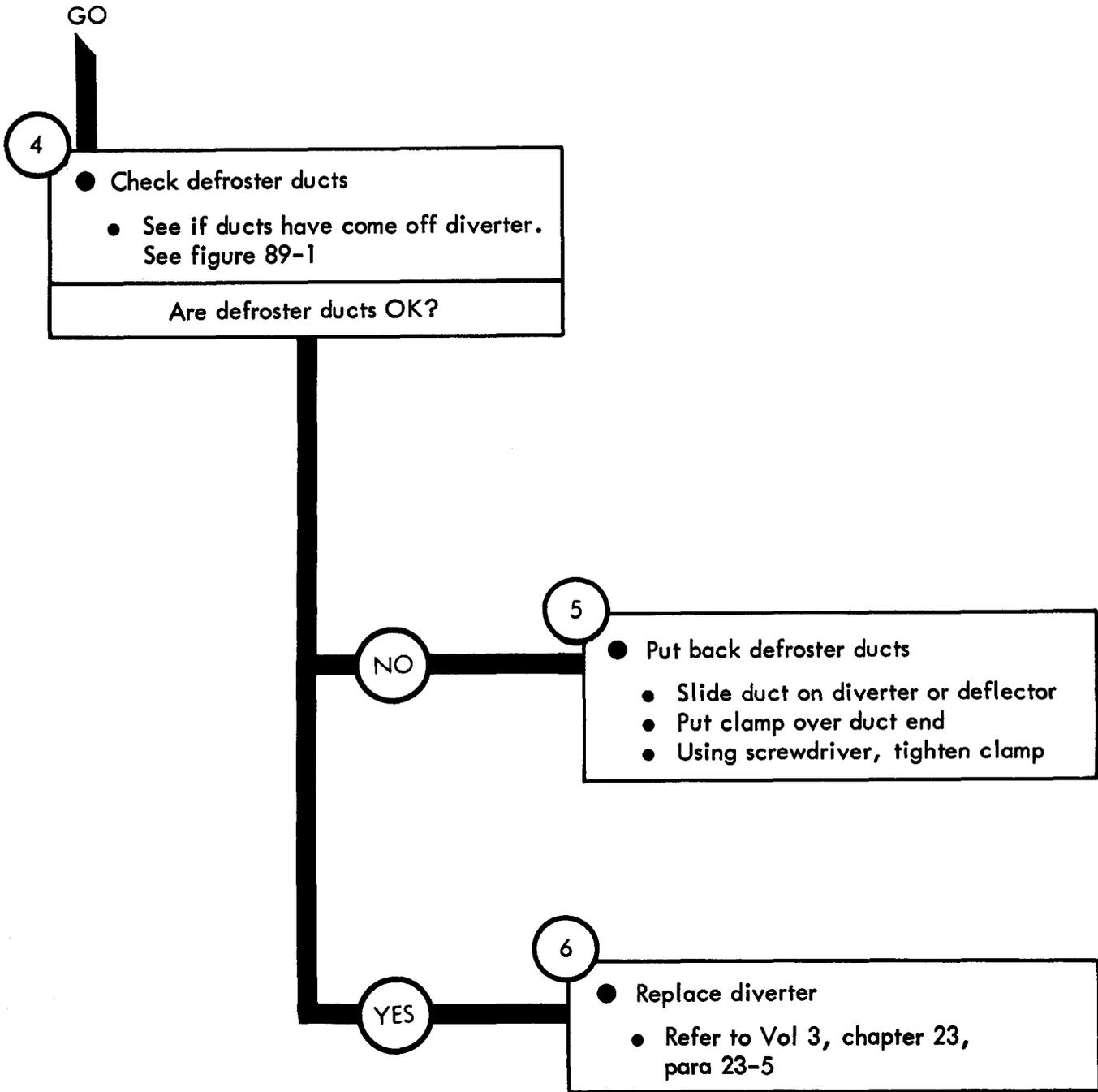

Figure 87-4 (Sheet 2 of 2)

Symptom

5 HEATER AND DEFROSTER DOES NOT GIVE OFF ENOUGH HEAT

1

- Park truck
- Refer to TM 9-2320-209-10

2

- Check heater duct from heater ducting adapter to diverter ducting adapters
- See if duct has come off of heater or diverter ducting adapter. See figure 89-1

Is heater duct OK?

3

- Put heater duct back on heater ducting adapter or diverter ducting adapter
 - Slide duct on adapter
 - Put clamp over duct
 - Using screwdriver, tighten clamp screw

GO

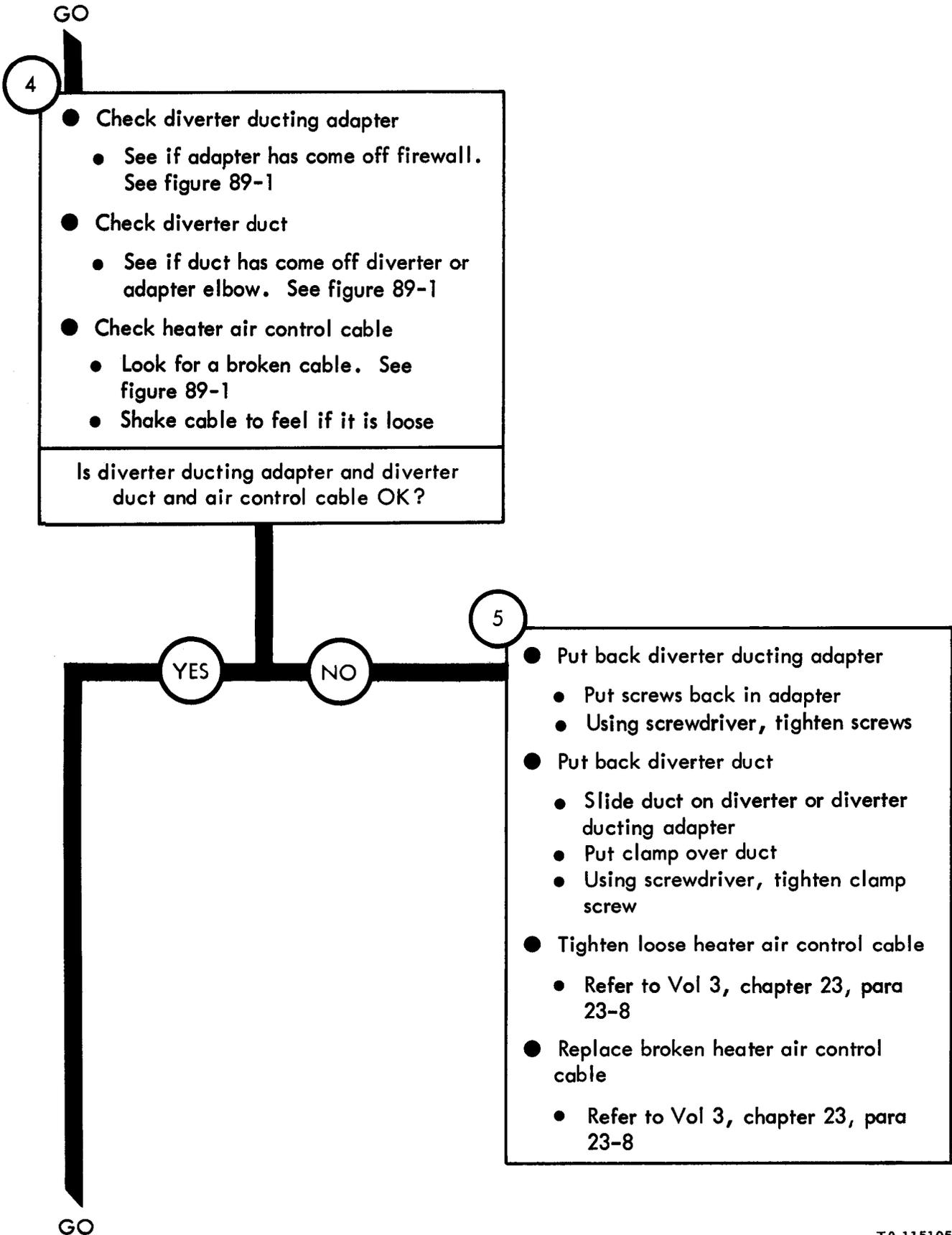

TA 115105

Figure 87-5 (Sheet 2 of 4)

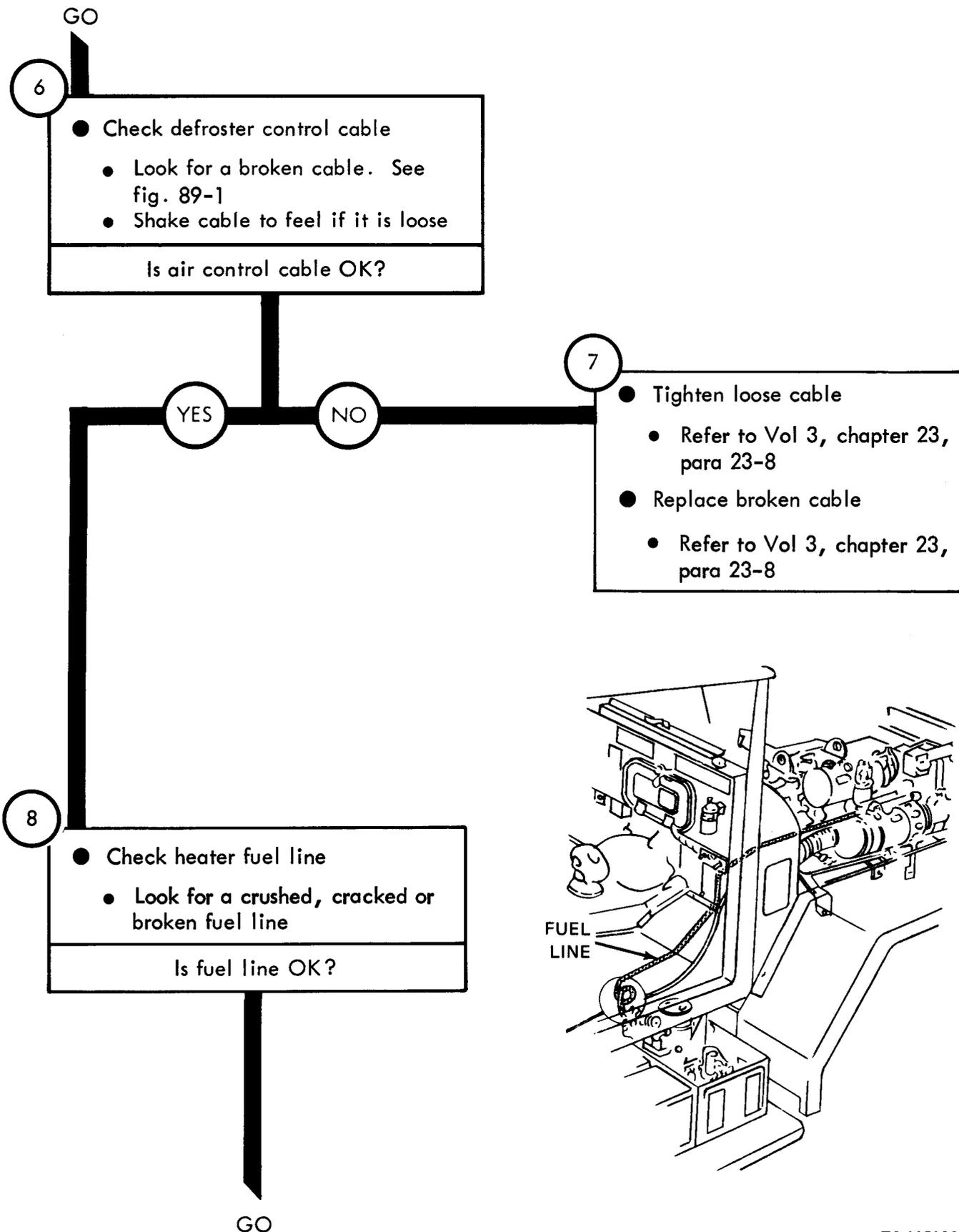
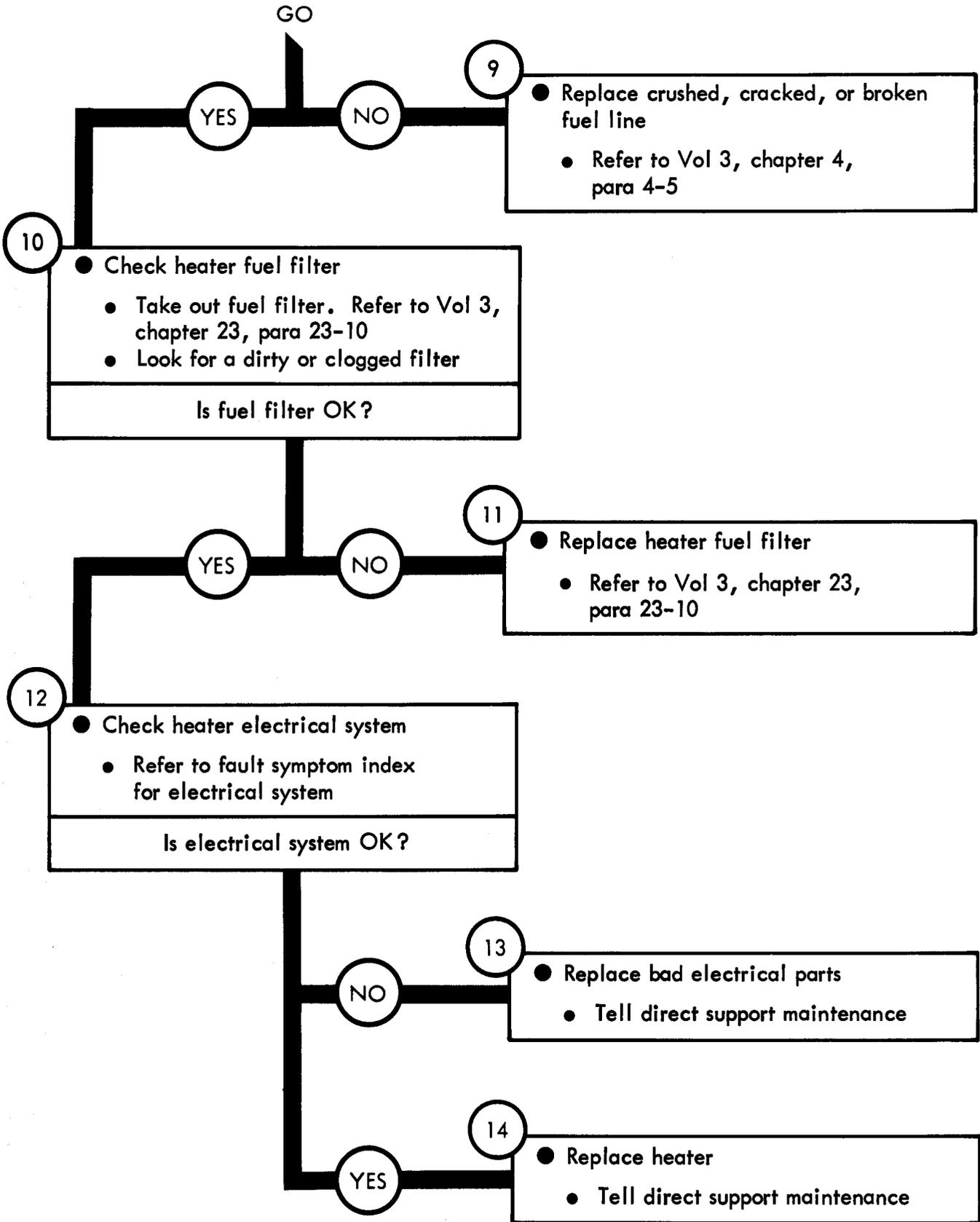

Figure 87-5 (Sheet 3 of 4)

TA 115106



TA 115107

Figure 87-5 (Sheet 4 of 4)

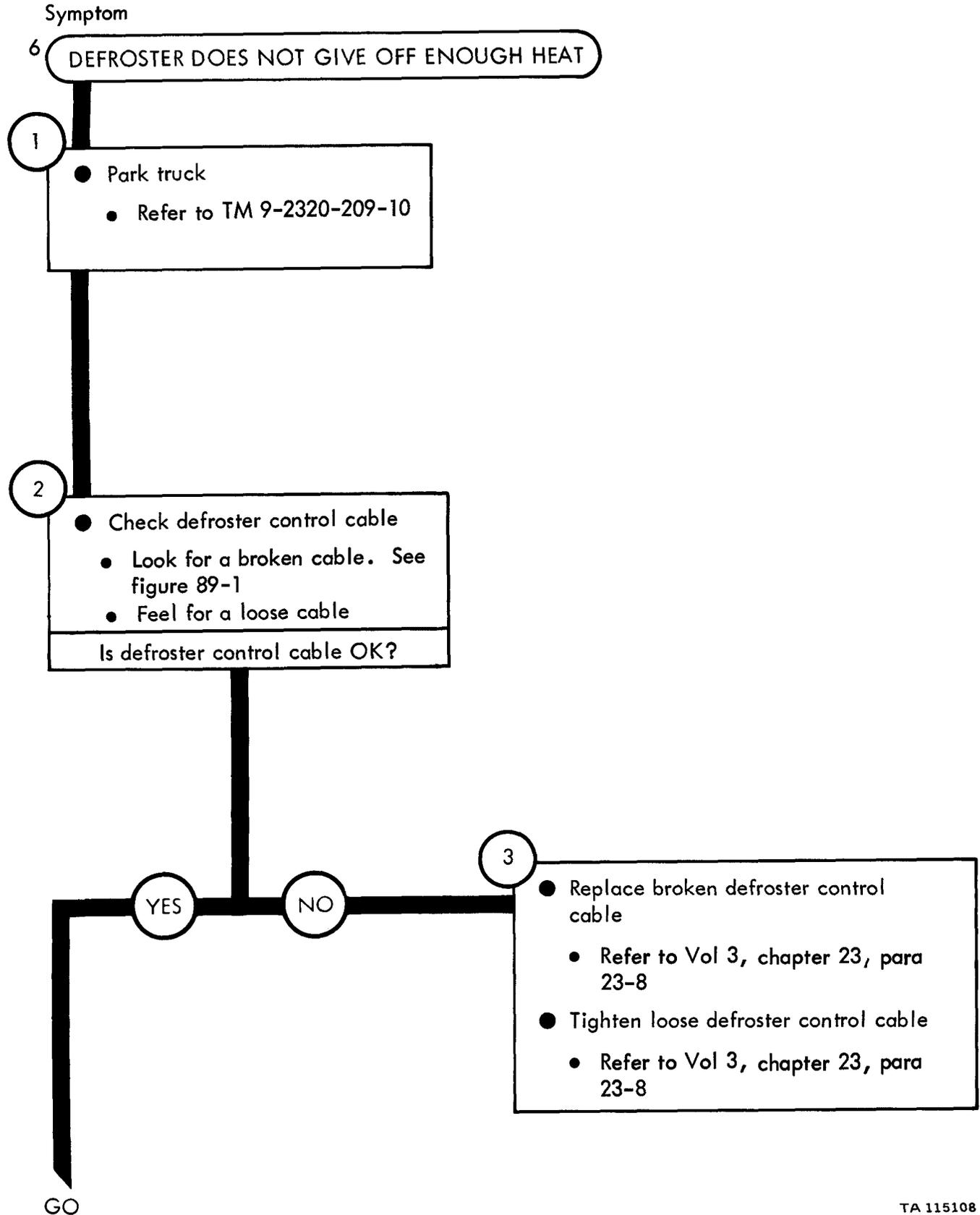

Figure 87-6 (Sheet 1 of 2)

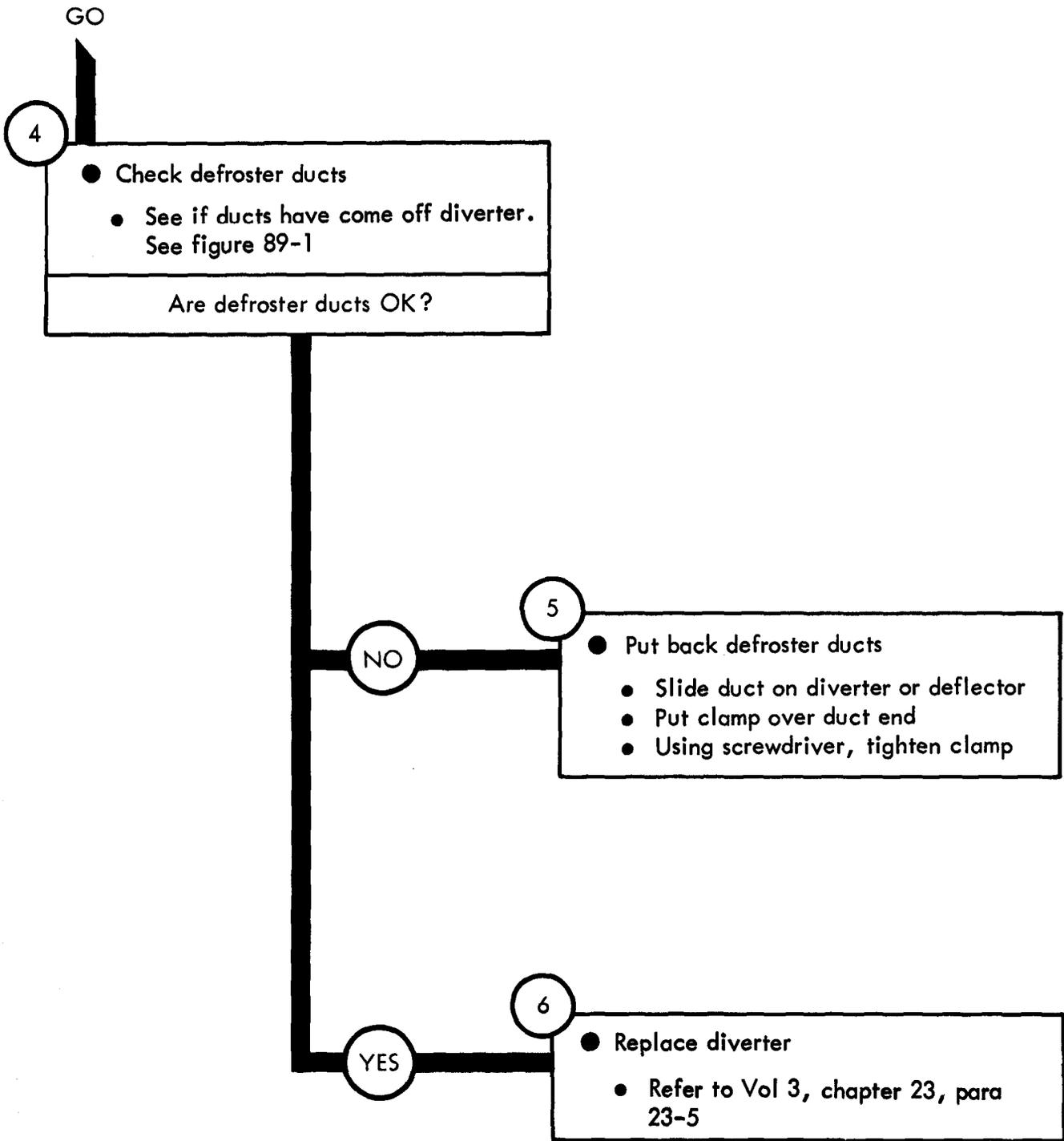
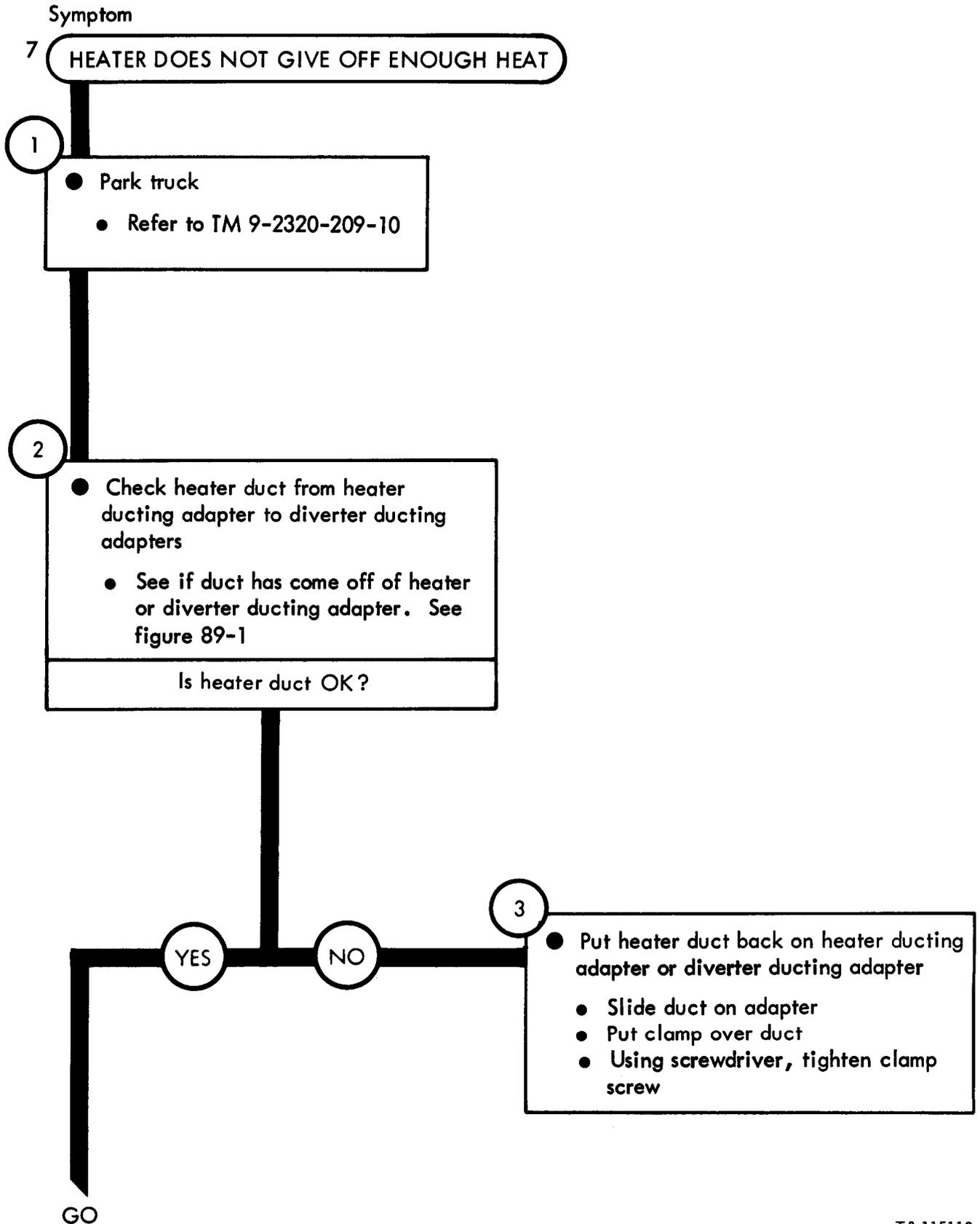
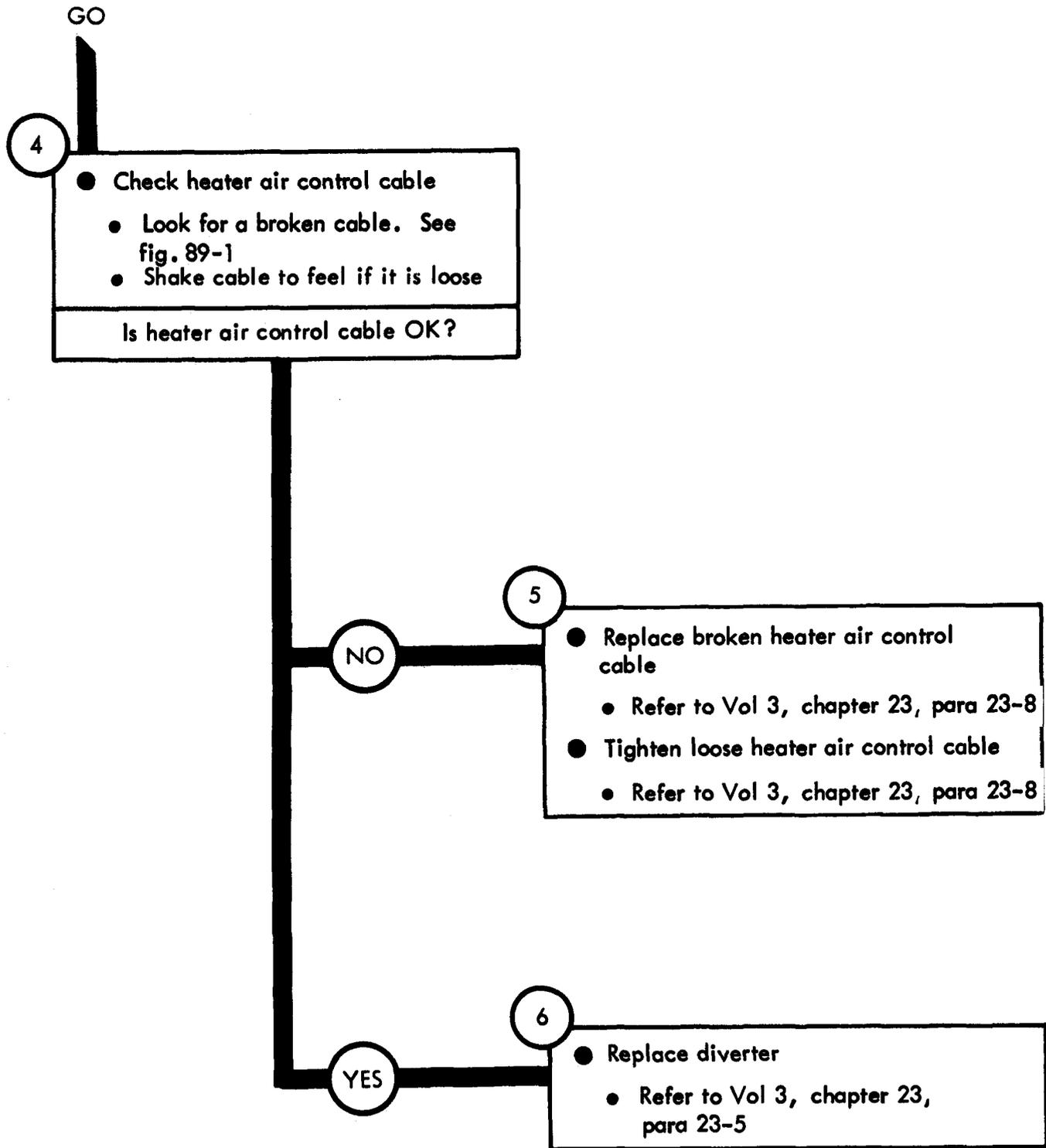

Figure 87-6 (Sheet 2 of 2)



TA 115110

Figure 87-7 (Sheet 1 of 2)



TA 115111

Figure 87-7 (Sheet 2 of 2)

CHAPTER 88

FUEL BURNING PERSONNEL HEATER TROUBLESHOOTING SUMMARY

88-1. GENERAL. This chapter gives a summary of troubleshooting procedures given in chapter 87 for the fuel burning personnel heater.

88-2. PROCEDURES. The summary in this chapter covers all fault symptoms found in the detailed troubleshooting procedures. Chapter 7 outlines a sample troubleshooting procedure. The summary procedures are based on the "what-to-do" portions of the detailed procedures and do not include the "how-to-do-it" instructions. Warnings, cautions, and notes are given where needed.

FUEL BURNING PERSONNEL HEATER TROUBLESHOOTING SUMMARY

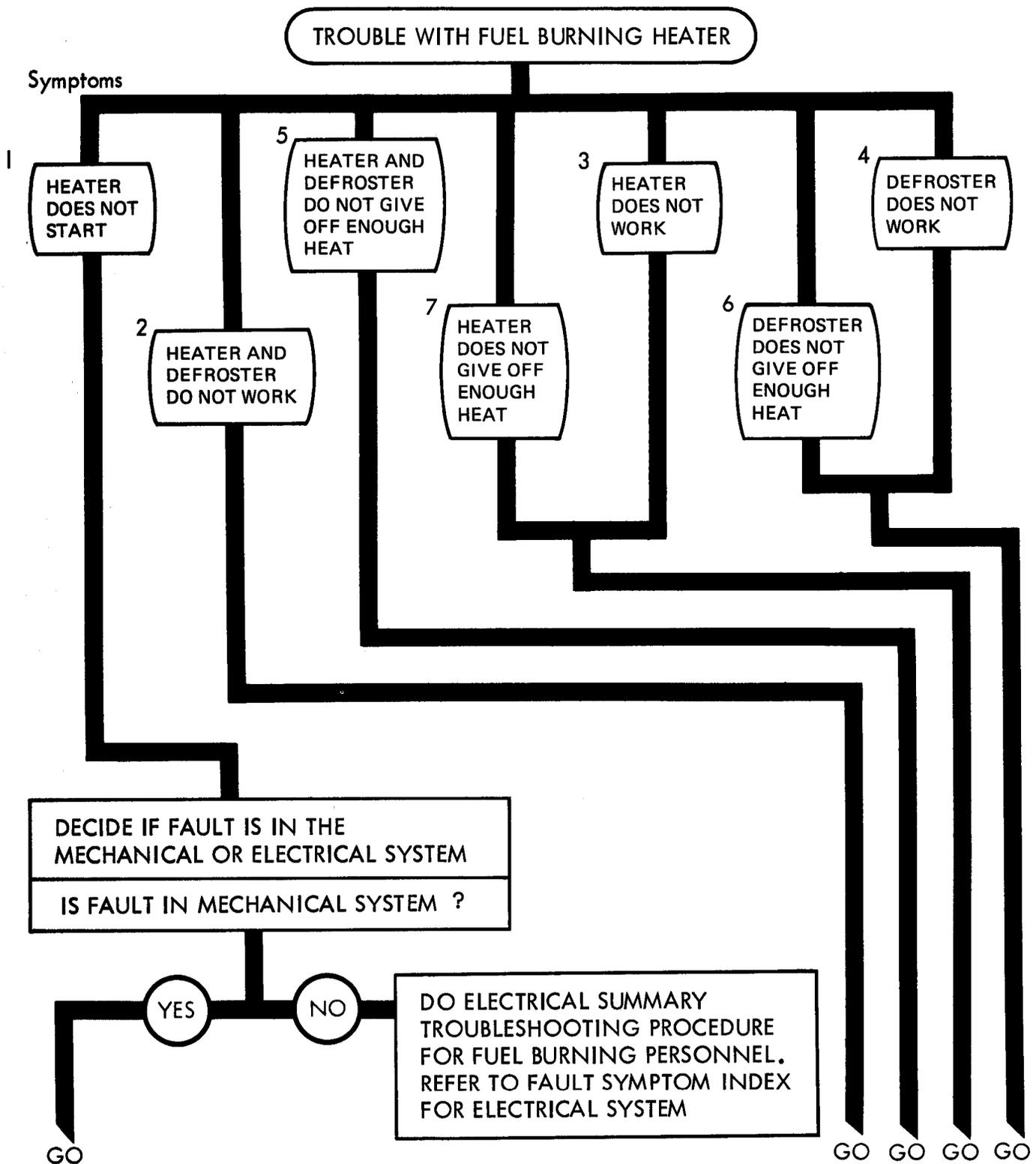

TA 115112

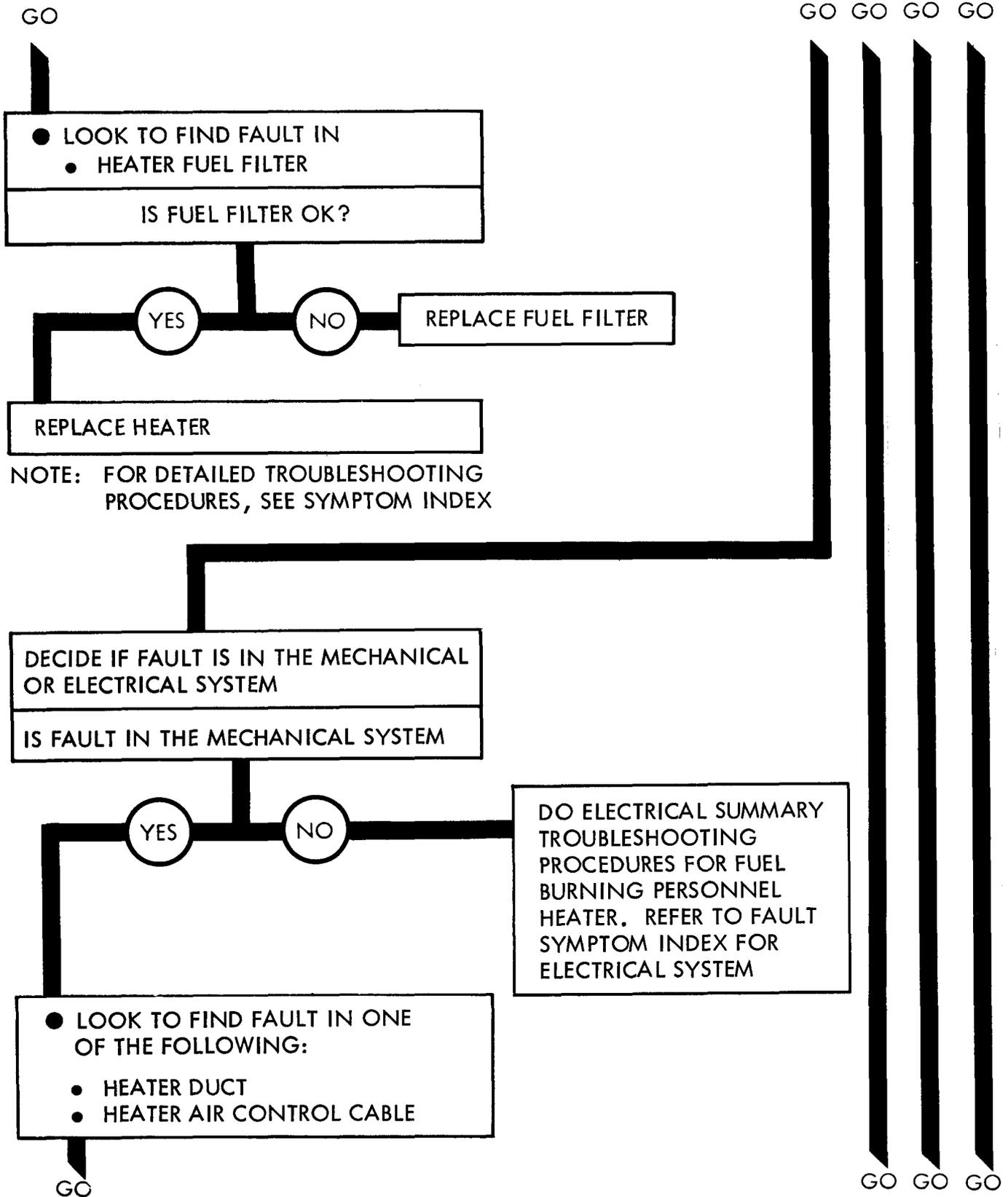

TA 115113

Figure 88-1 (Sheet 2 of 6)

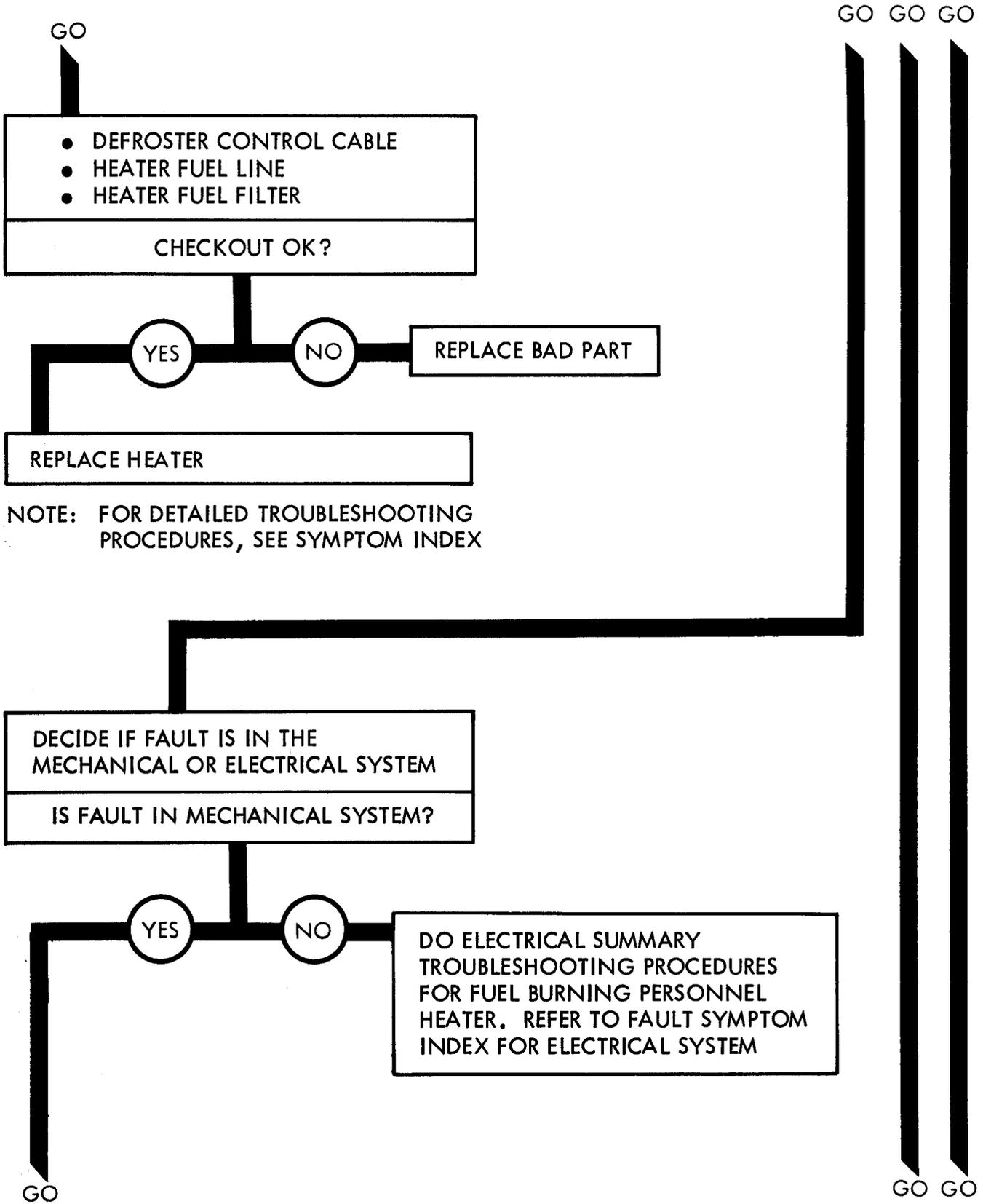
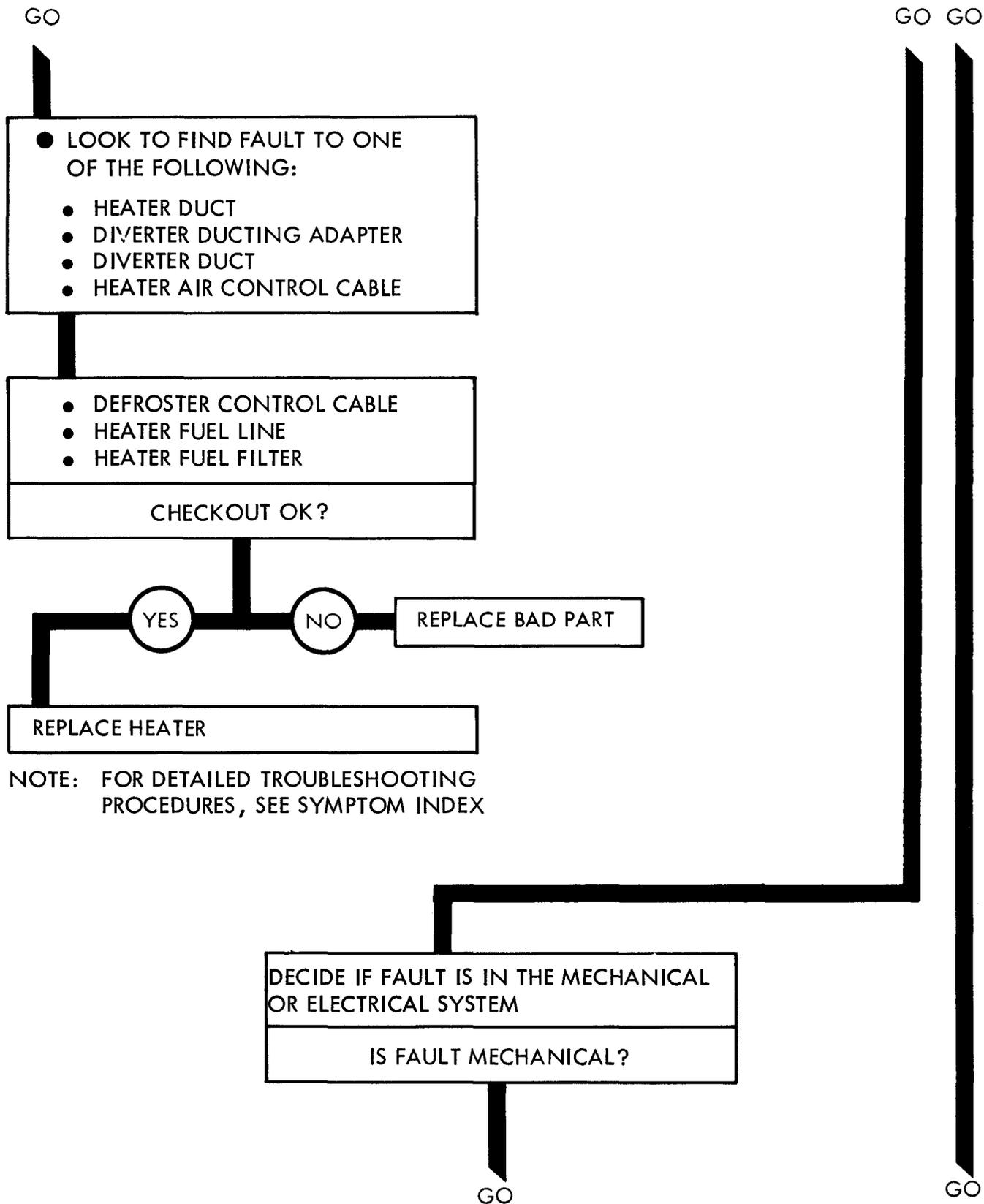

Figure 88-1 (Sheet 3 of 6)

TA 115114



NOTE: FOR DETAILED TROUBLESHOOTING PROCEDURES, SEE SYMPTOM INDEX

Figure 88-1 (Sheet 4 of 6)

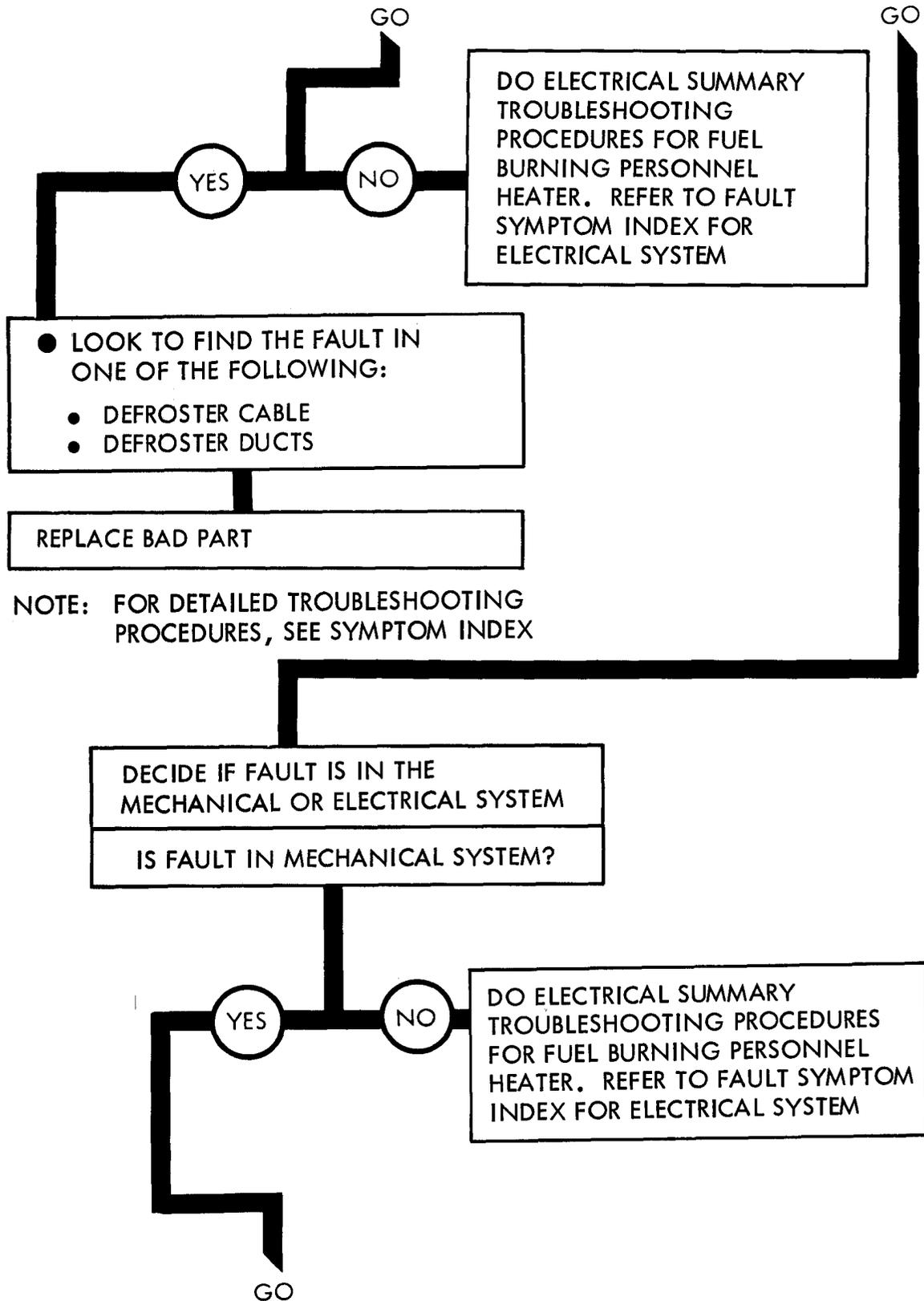

NOTE: FOR DETAILED TROUBLESHOOTING PROCEDURES, SEE SYMPTOM INDEX

Figure 88-1 (Sheet 5 of 6)

GO

- LOOK TO FIND FAULT TO ONE OF THE FOLLOWING:
 - HEATER DUCT
 - HEATER AIR CONTROL CABLE

REPLACE BAD PART

NOTE: FOR DETAILED TROUBLESHOOTING PROCEDURES, SEE SYMPTOM INDEX

Figure 88-1 (Sheet 6 of 6)

CHAPTER 89

FUEL BURNING PERSONNEL HEATER SUPPORT DIAGRAMS

89-1. GENERAL. This chapter gives the diagrams you need when doing troubleshooting procedures in chapter 87. Table 3-1 is a complete listing of all support diagrams used in this manual.

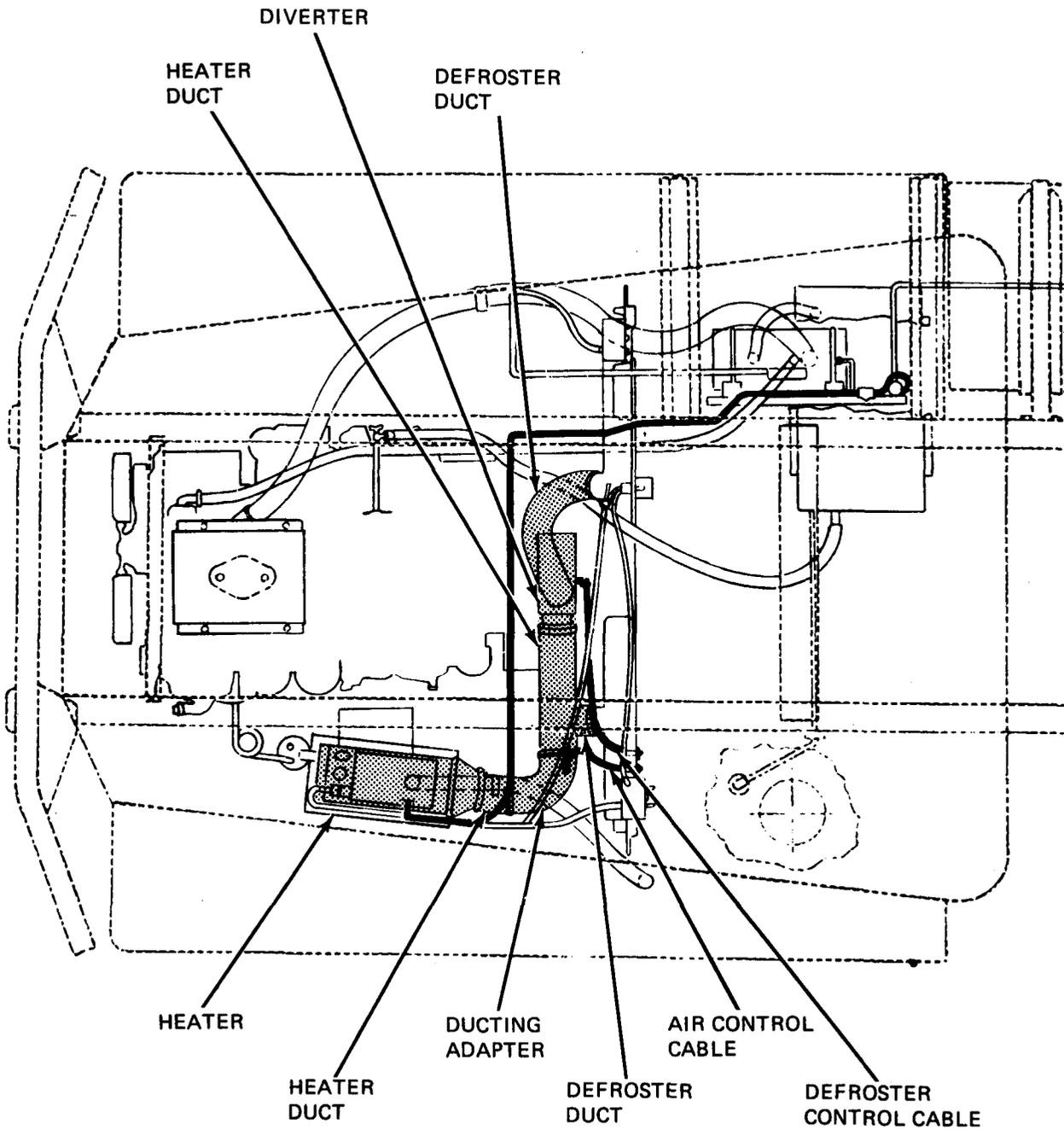

TA 115118

Figure 89-1. Fuel Burning Personnel Heater Support Diagram

CHAPTER 90

FUEL BURNING PERSONNEL HEATER CHECKOUT PROCEDURES

90-1. GENERAL. This chapter gives procedures for checking out the system after troubleshooting and repair have been done. Procedures are set up in flow chart form showing the checkout steps in order and referring to the fault symptom index when the system does not check out.

FUEL-BURNING PERSONNEL HEATER CHECKOUT

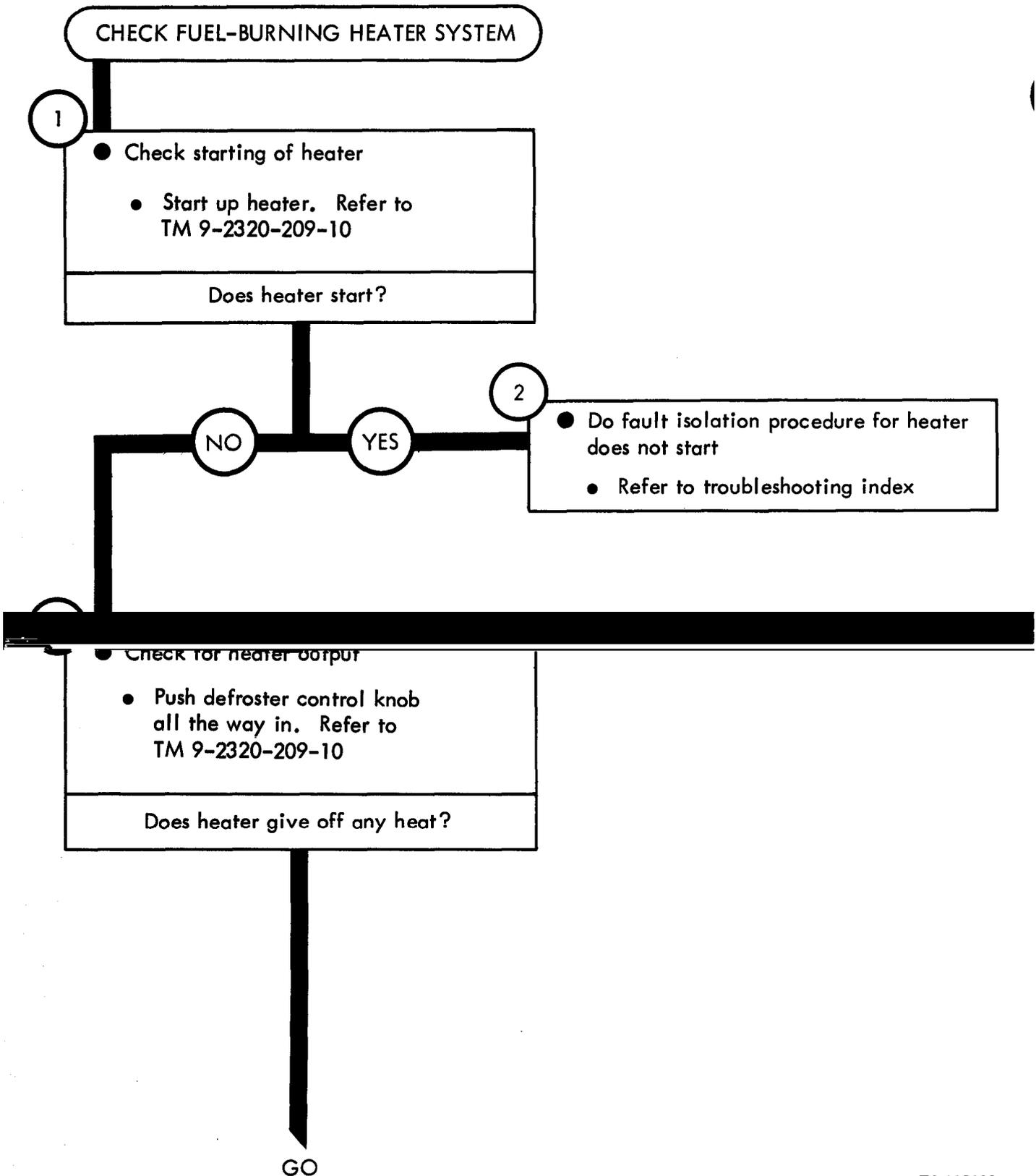

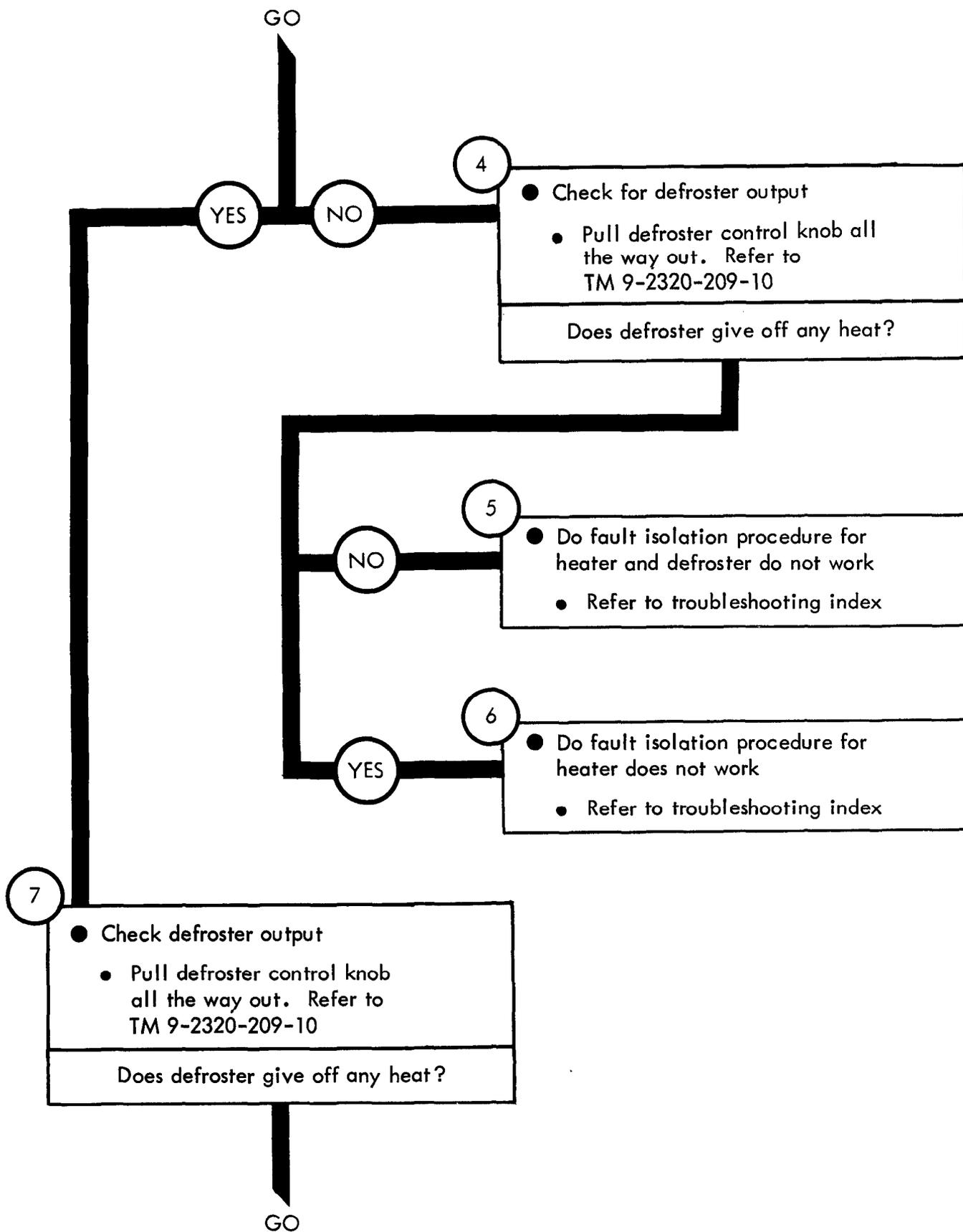
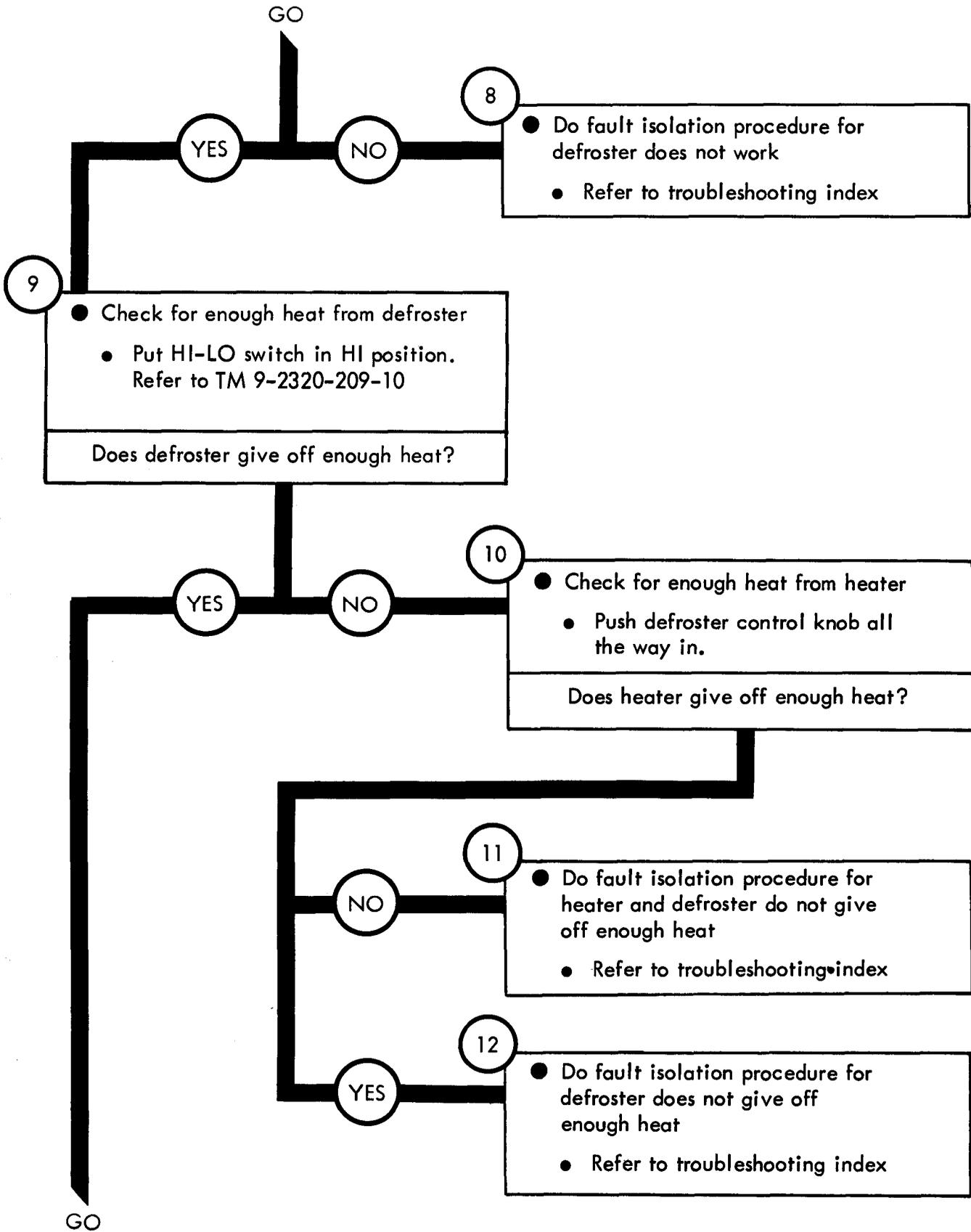
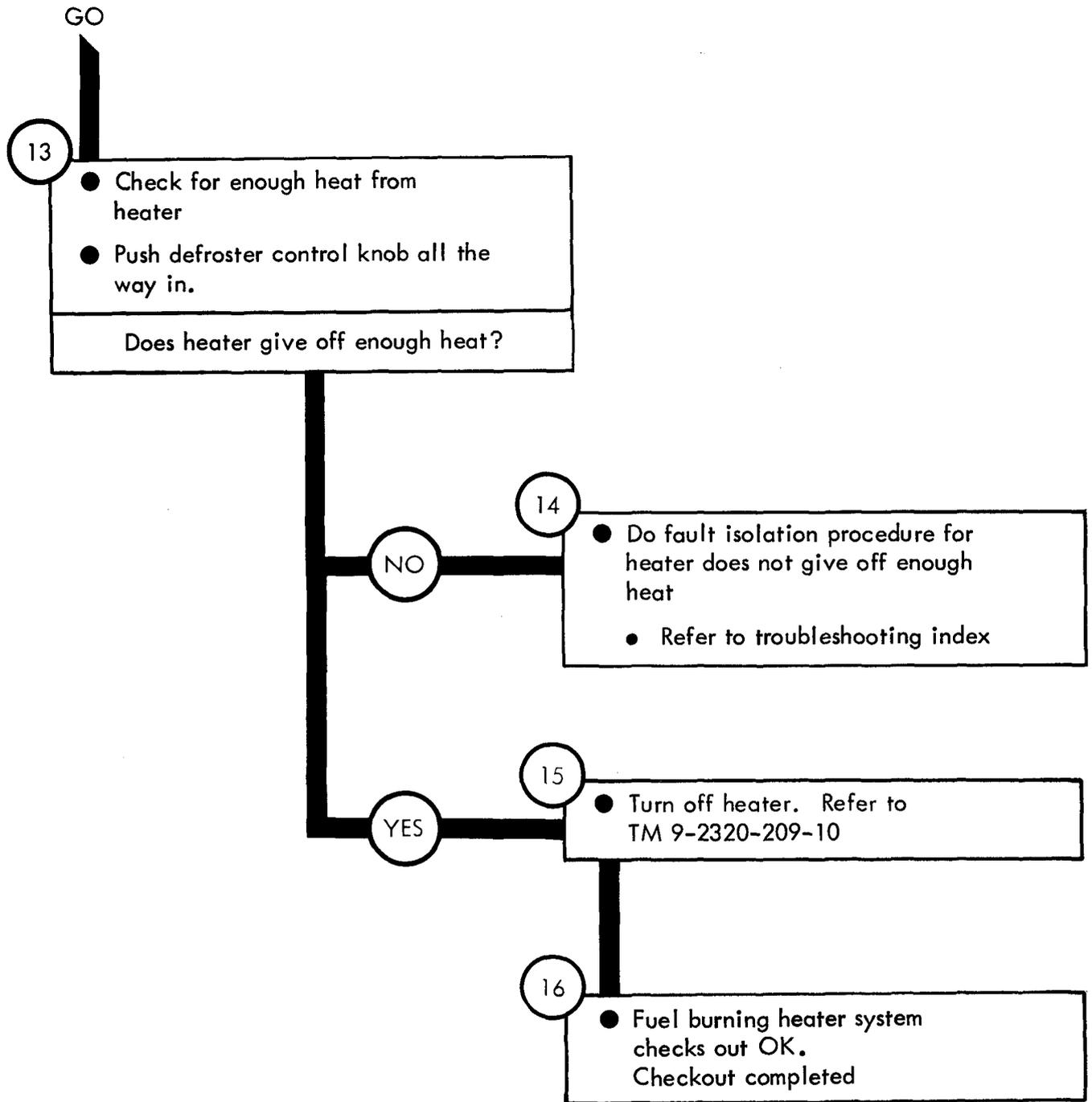

Figure 90-1 (Sheet 2 of 4)



TA 115121

Figure 90-1 (Sheet 3 of 4)



CHAPTER 91

HOT WATER HEATER TROUBLESHOOTING

91-1. EQUIPMENT ITEMS COVERED. This chapter gives equipment troubleshooting procedures for the hot water heater, for which there are authorized corrective maintenance tasks at the organizational maintenance level.

91-2. EQUIPMENT ITEMS NOT COVERED. All equipment items for which corrective maintenance is authorized at the organizational maintenance level are covered in this chapter.

HOT WATER HEATER TROUBLESHOOTING

Symptom

1 COOL OR COLD AIR AT OUTLETS AFTER ENGINE HAS REACHED OPERATING TEMPERATURE

1

- Park truck
- Refer to TM 9-2320-209-10

2

- Check to see that shutoff cocks are fully open to the left
- Open hood. Refer to TM 9-2320-209-10
- Check if shutoff cocks are fully open to the left

Are shut off cocks fully open to left?

GO

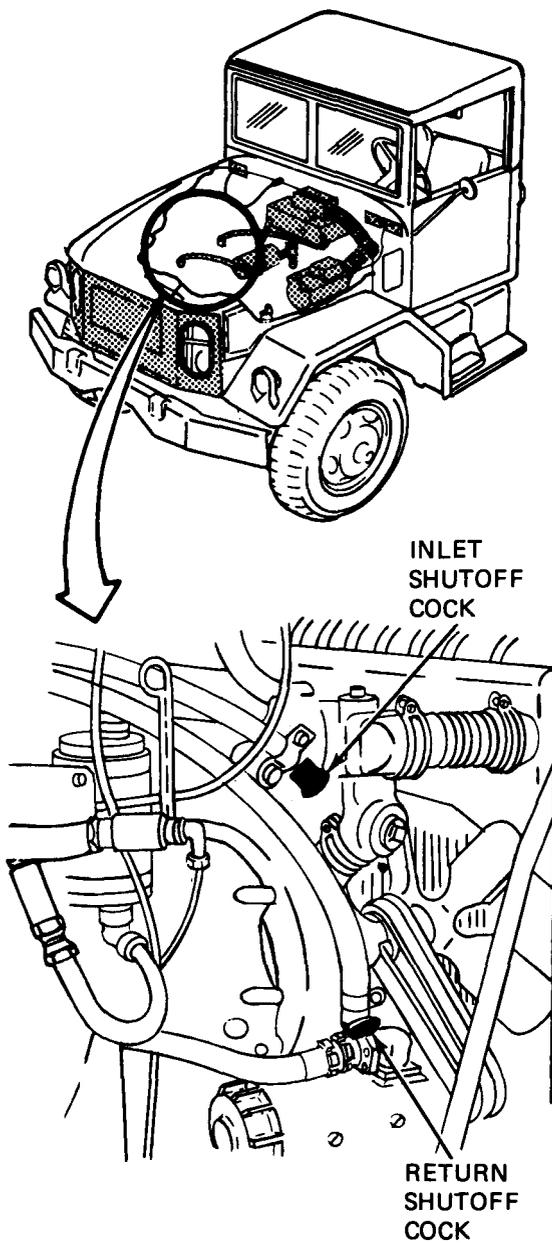

TA 115123

Figure 91-1 (Sheet 1 of 3)

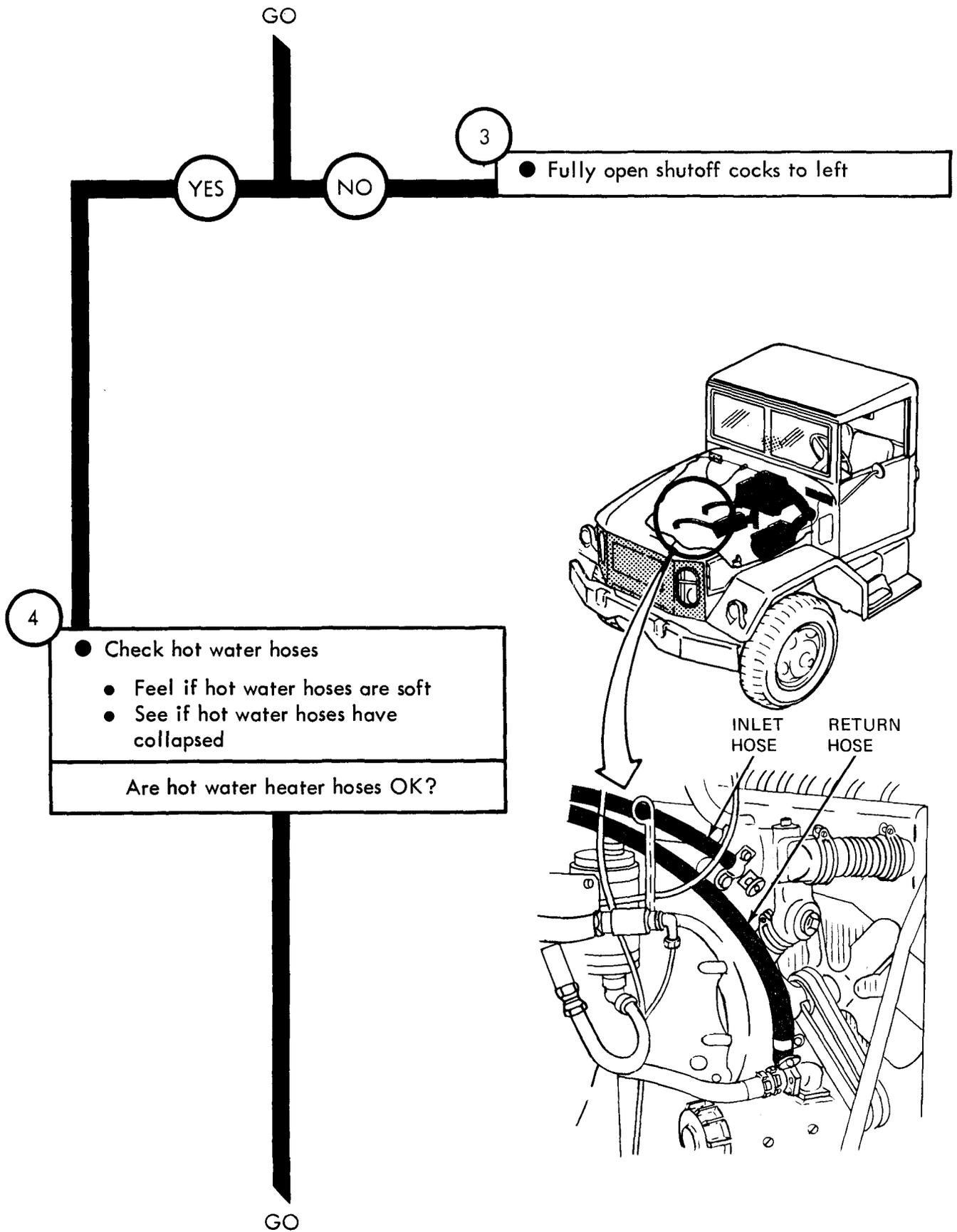
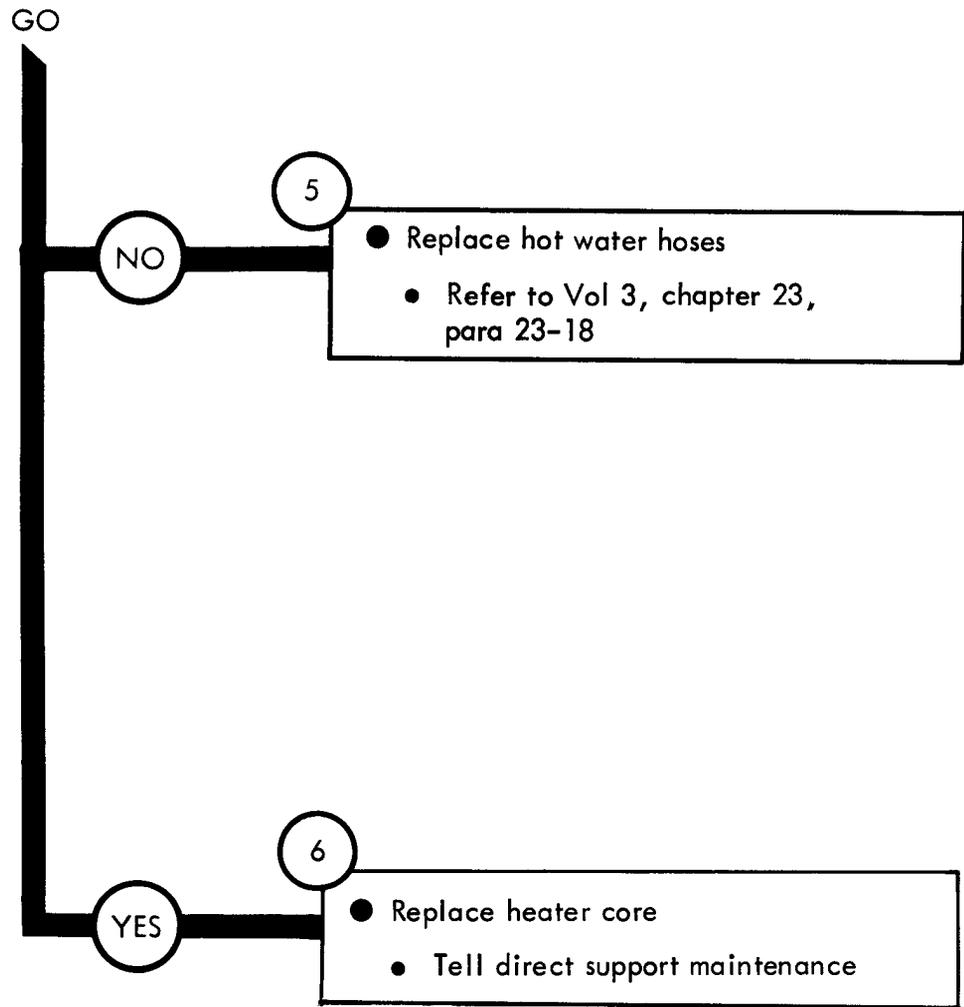

Figure 91-1 (Sheet 2 of 3)

TA 115124



Symptom

2 NO AIR FLOW AT HEAT OUTLET

1

- Park truck
- Refer to TM 9-2320-209-10

2

- Check if heater to air diverter duct is hanging loose
- Look under dash and check if heater to air diverter is hanging loose from heater or air diverter

Is heater to air diverter duct attached to heater and air diverter?

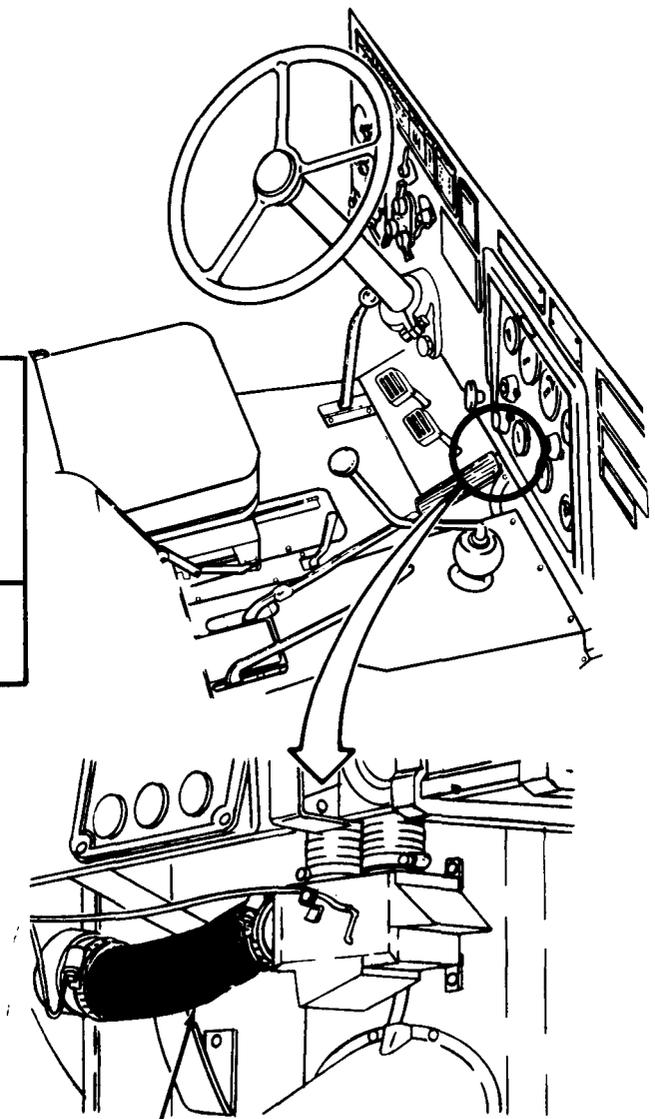

HEATER TO AIR DIVERTER DUCT

GO

Figure 91-2 (Sheet 1 of 2)

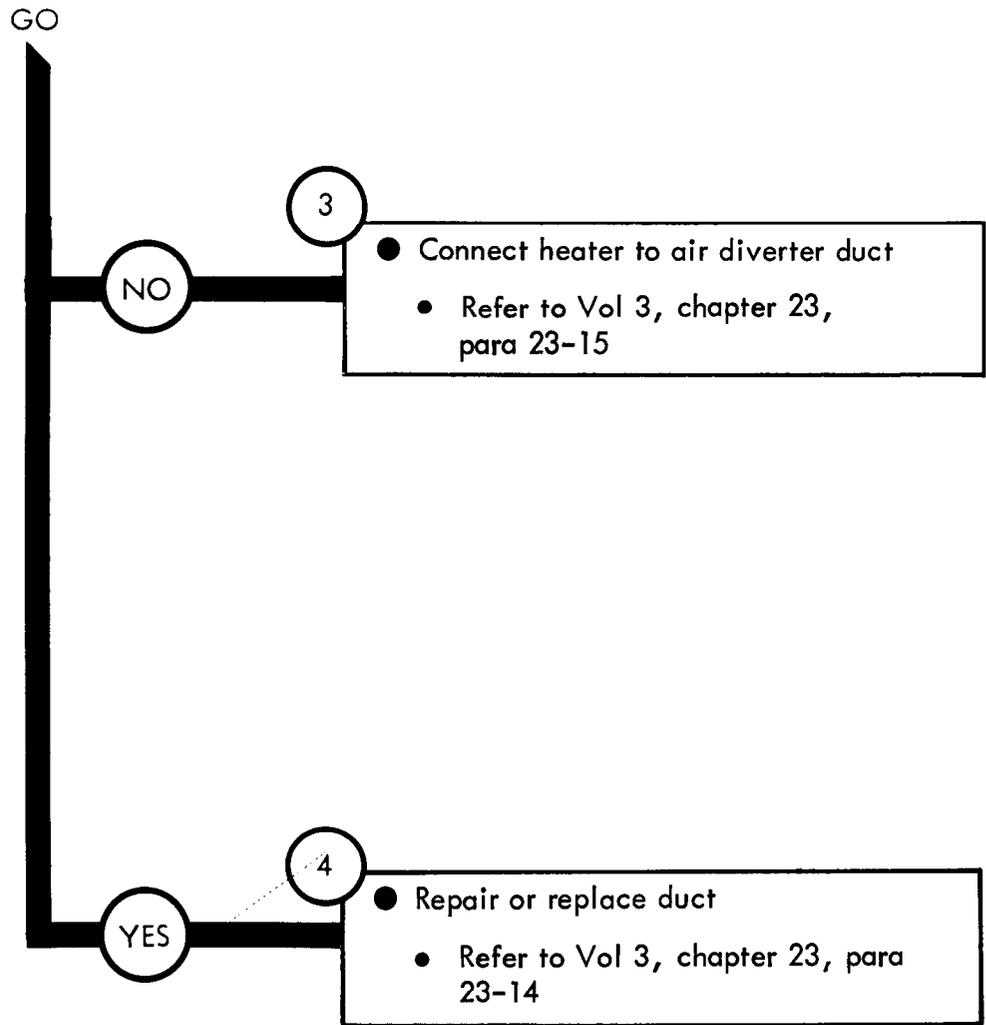

TA 115127

Figure 91-2 (Sheet 2 of 2)

Symptom

3 BLOWER MOTOR DOES NOT WORK

1

- Park truck
 - Refer to TM 9-2320-209-10

2

- Check if lead to blower motor is attached
 - Open hood. Refer to TM 9-2320-209-10
 - Check if lead to blower motor is attached

Is lead to blower motor attached?

GO

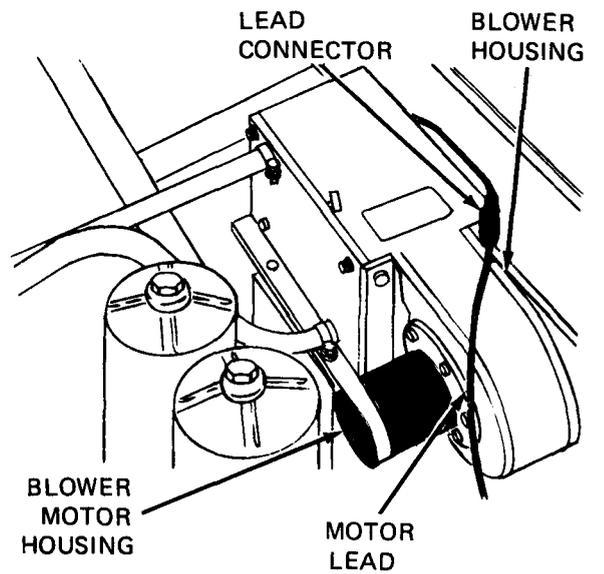
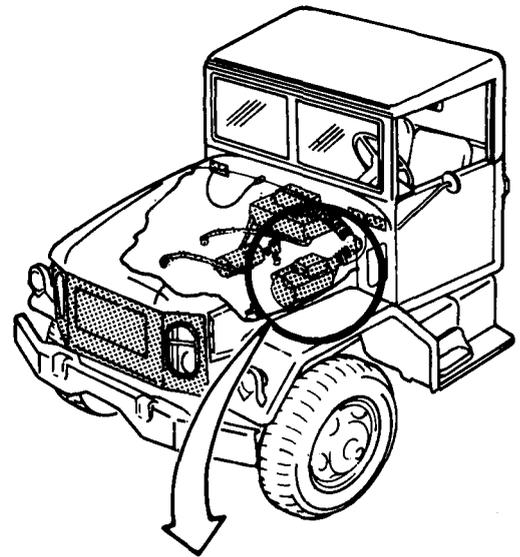

Figure 91-3 (Sheet 1 of 2)

TA 115128

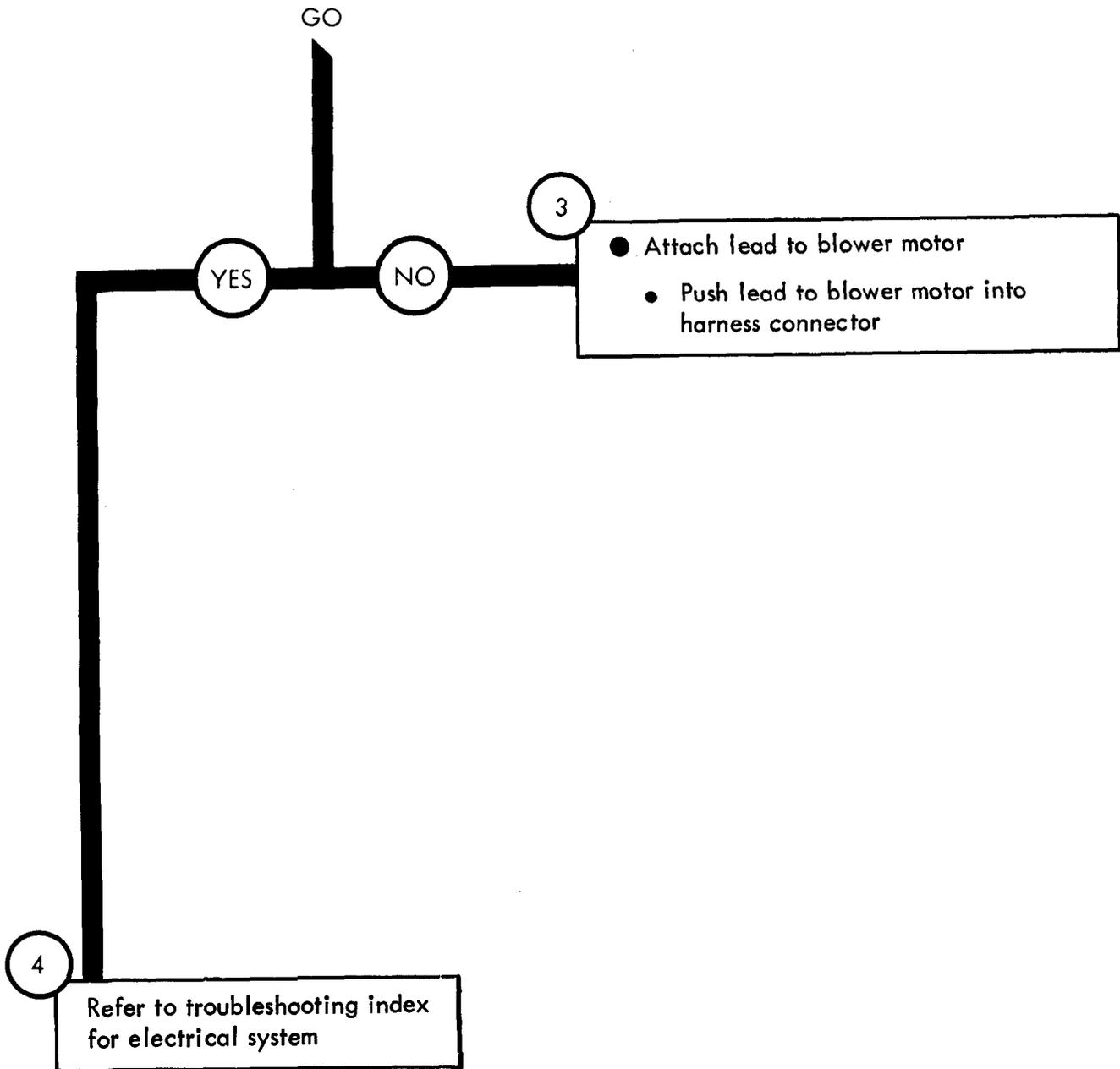

Figure 91-3 (Sheet 2 of 2)

Symptom

4 BLOWER MOTOR OPERATES ON HI ONLY

1

- Park truck
- Refer to TM 9-2320-209-10

2

- Check if heater switch lead is attached
- Look under dash panel and see if heater switch lead is attached

Is heater switch lead attached?

GO

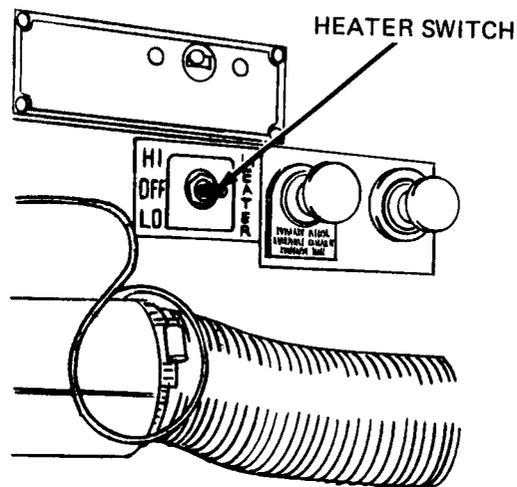
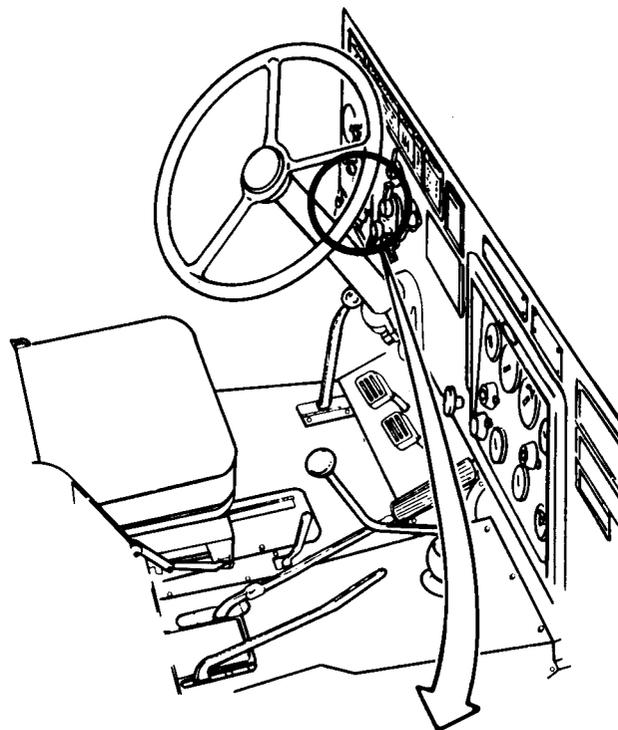

Figure 91-4 (Sheet 1 of 2)

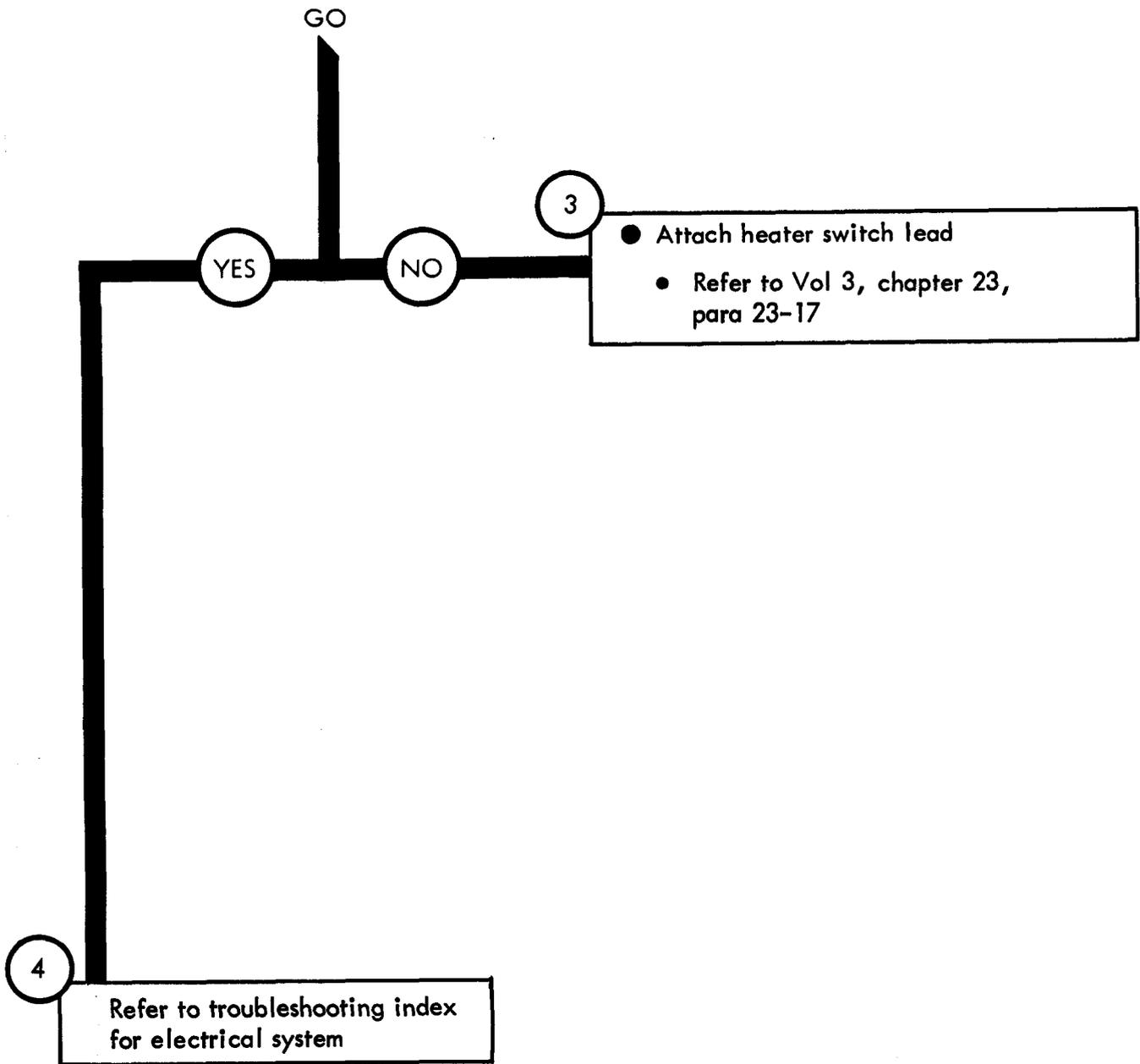

Figure 91-4 (Sheet 2 of 2)

Symptom

5

NO AIR FLOW AT DEFROSTER

1

- Park truck
- Refer to TM 9-2320-209-10

2

- Check if defroster air duct is hanging loose at windshield defroster nozzle
- Under dash panel, look and see if defroster air duct is attached to nozzle

Is defroster air duct attached to nozzle?

GO

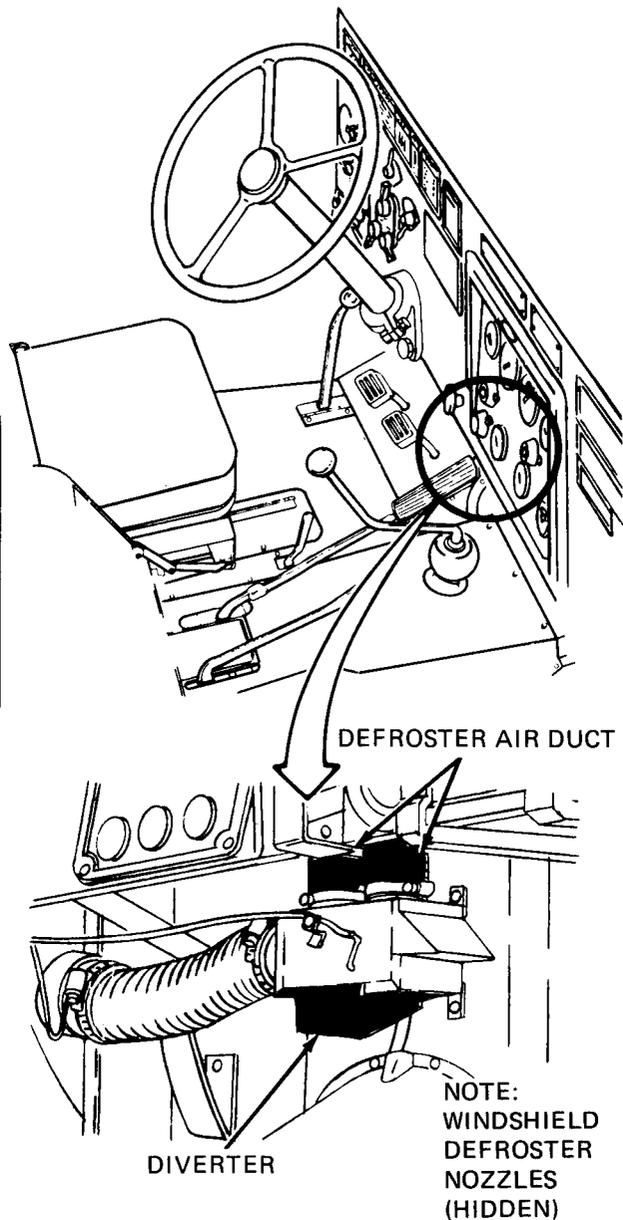

Figure 91-5 (Sheet 1 of 2)

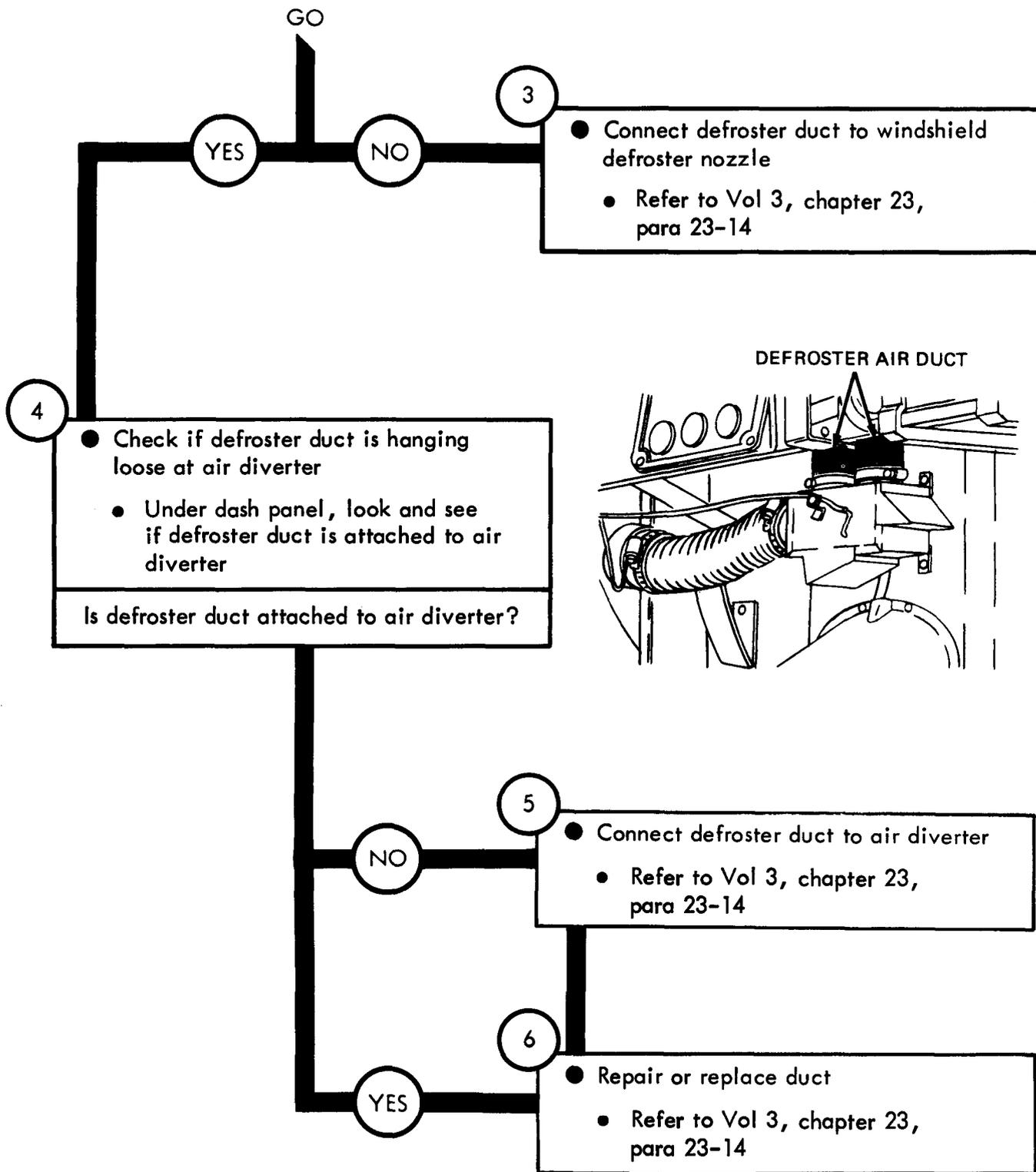

Figure 91-5 (Sheet 2 of 2)

TA 115133

Symptom

6

BLOWER MOTOR OPERATES ON LOW ONLY

1

- Park truck
- Refer to TM 9-2320-209-10

2

- Check if heater switch lead is attached
- Look under dash panel and see if heater switch lead is attached

Is heater switch lead attached?

GO

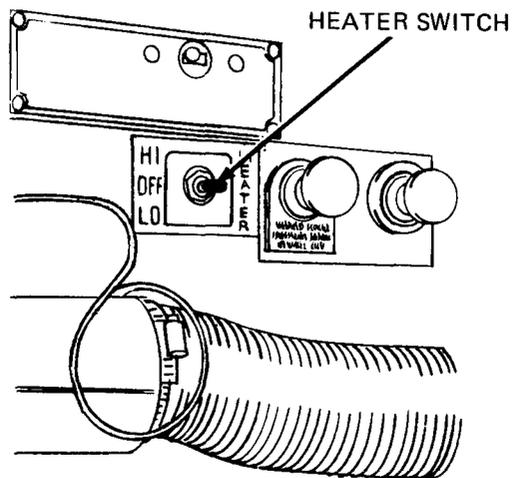
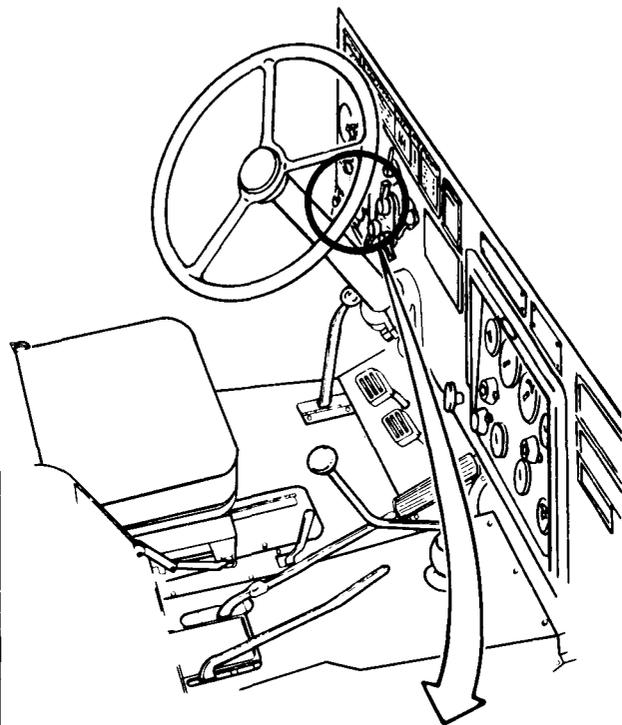
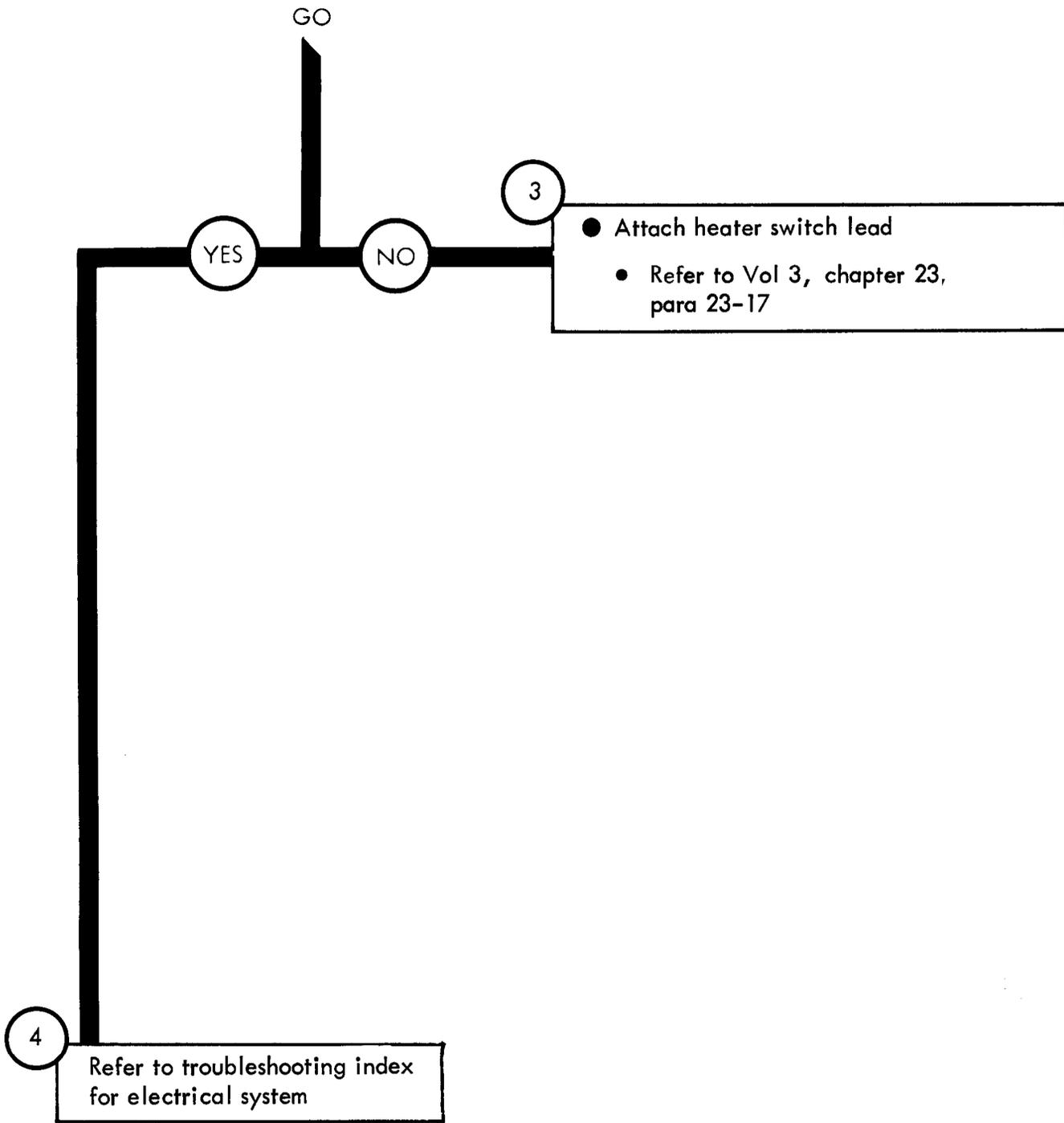

Figure 91-6 (Sheet 1 of 2)

TA 115134



Symptom

7

HEAT OUTPUT TOO LOW

1

- Park truck
- Refer to TM 9-2320-209-10

2

- Check if shut off cocks are fully open to the left
- Open hood. Refer to TM 9-2320-209-10
- Check if shutoff cocks are fully open to left

Are shutoff cocks fully open to left?

GO

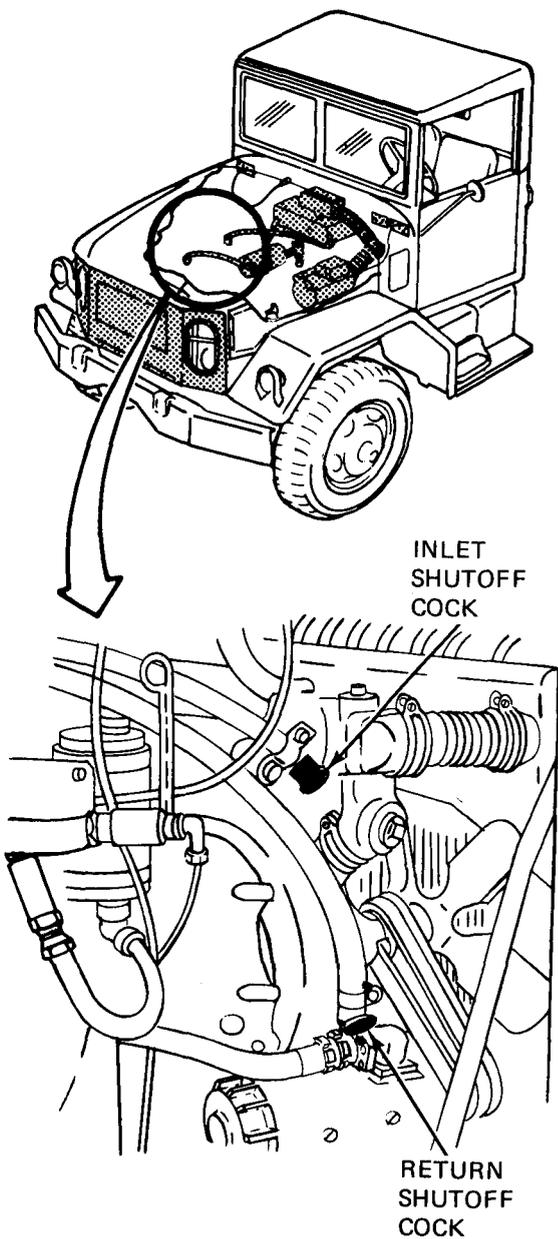
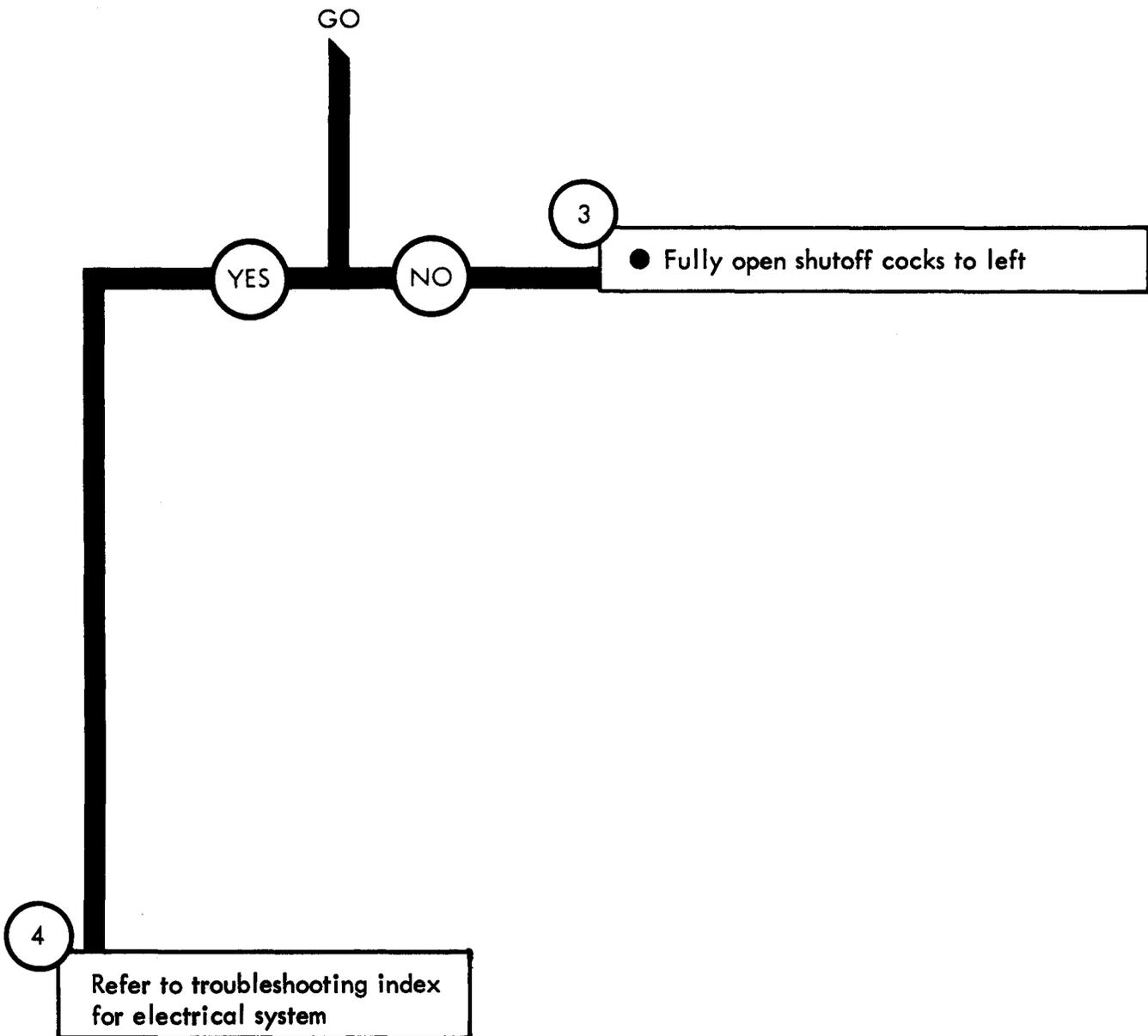

Figure 91-7 (Sheet 1 of 2)

TA 115136



CHAPTER 92

HOT WATER HEATER TROUBLESHOOTING SUMMARY

92-1. GENERAL. This chapter gives a summary of troubleshooting procedures given in chapter 91 for the hot water heater.

92-2. PROCEDURES. The summary in this chapter covers all fault symptoms found in the detailed troubleshooting procedures. Chapter 7 outlines a sample troubleshooting procedure. The summary procedures are based on the "what-to-do" portions of the detailed procedures and do not include the "how-to-do-it" instructions. Warnings, cautions, and notes are given where needed.

HOT WATER HEATER TROUBLESHOOTING SUMMARY

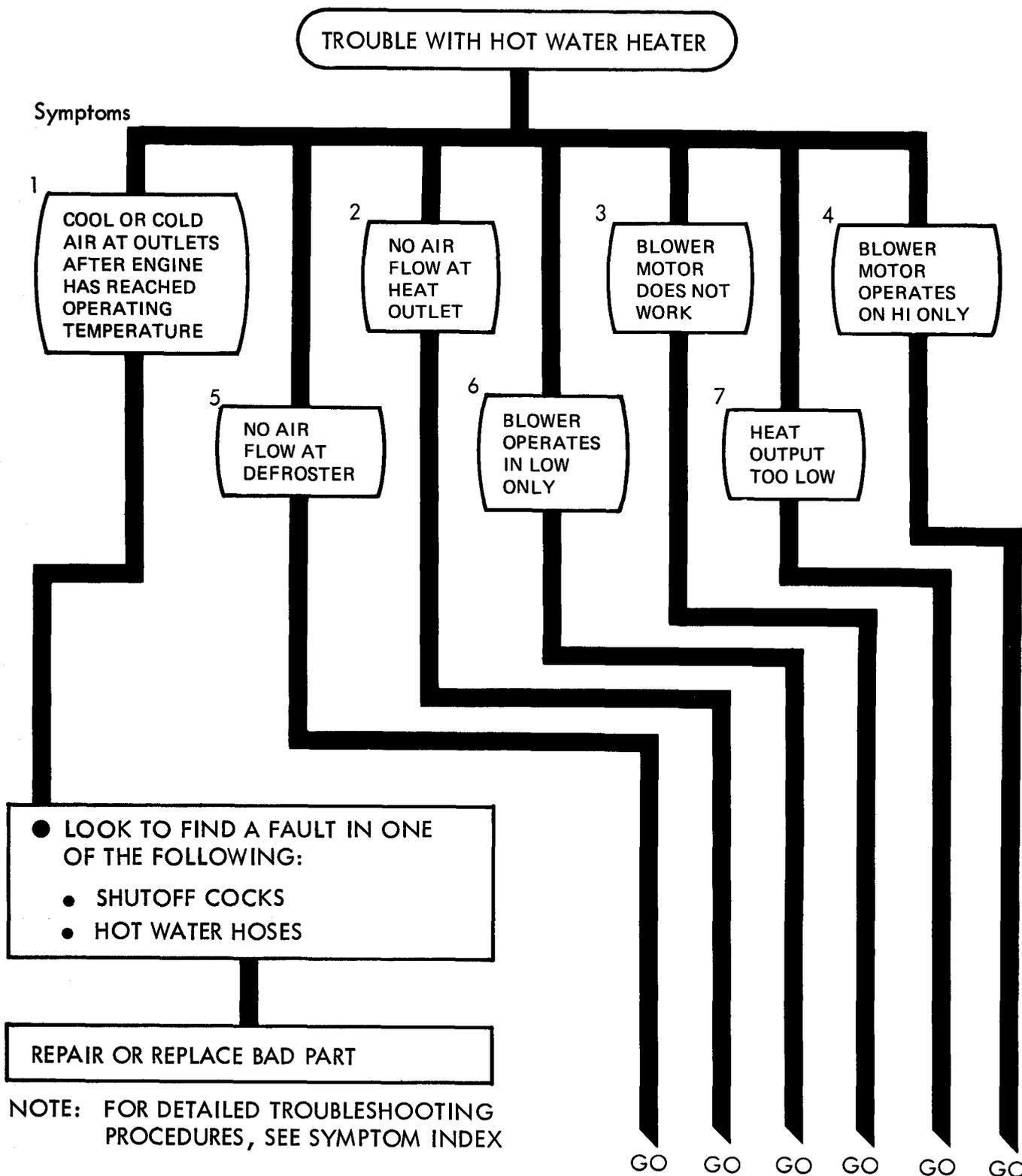

TA 115138

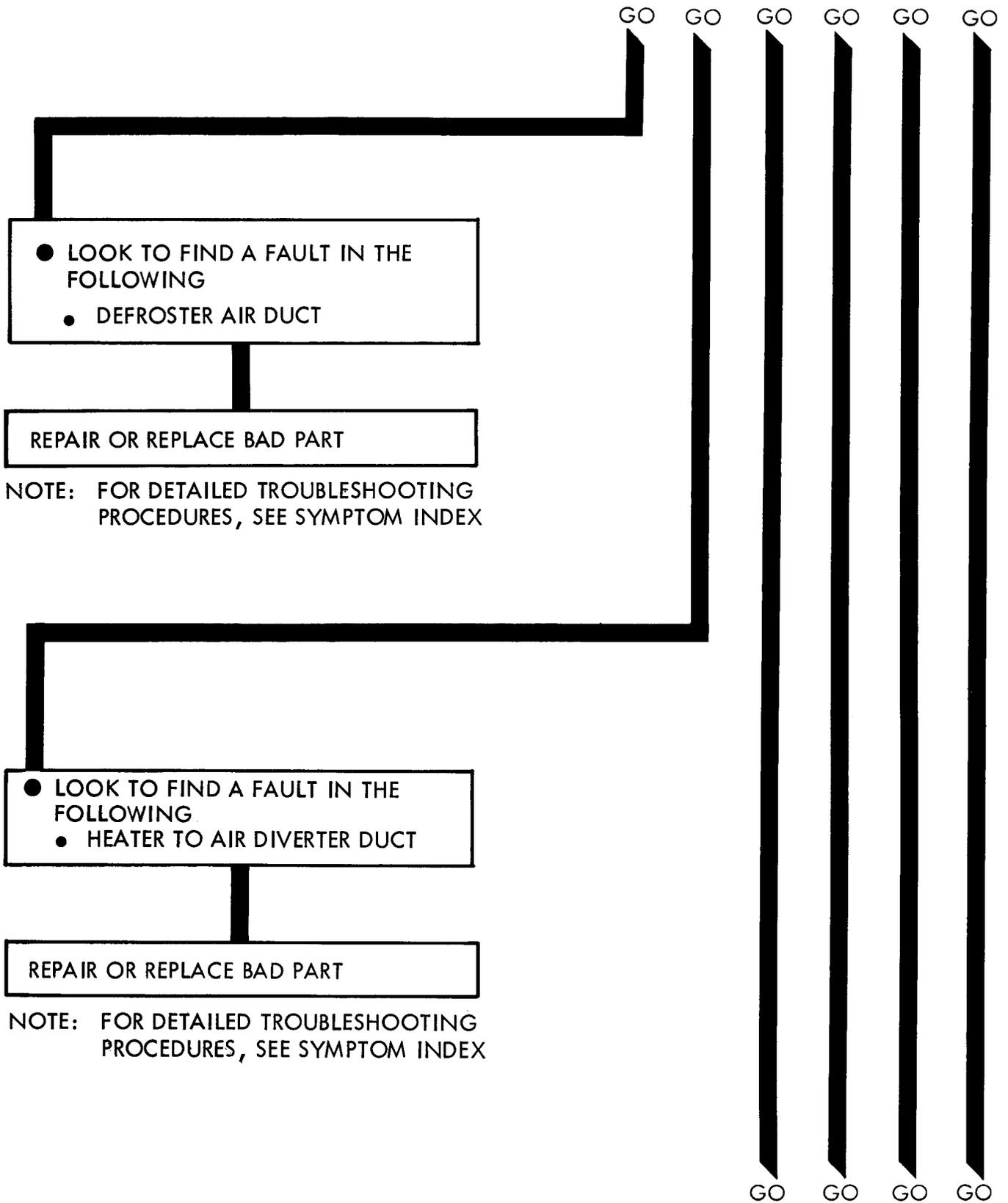

TA 115139

Figure 92-1 (Sheet 2 of 6)

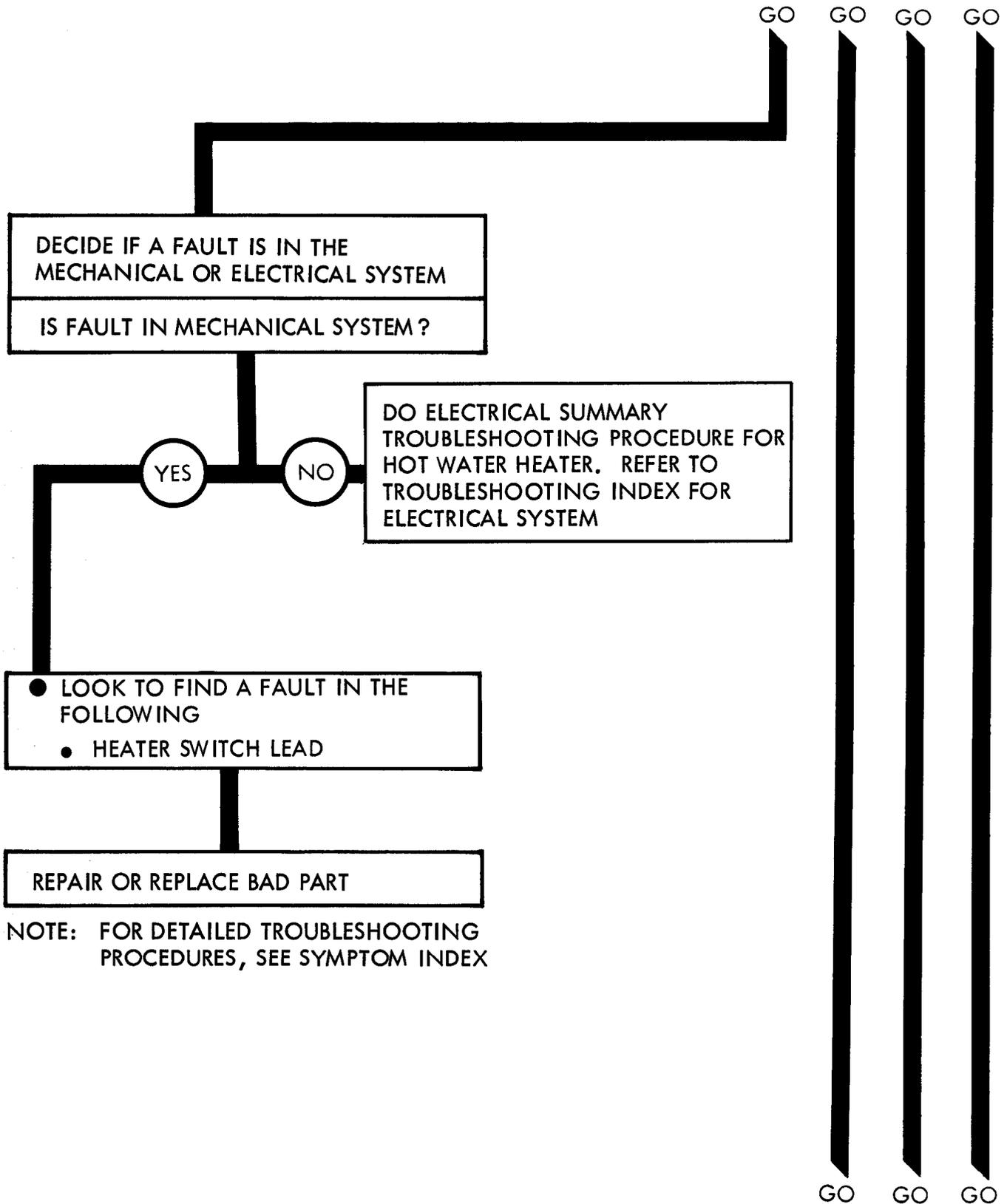

NOTE: FOR DETAILED TROUBLESHOOTING PROCEDURES, SEE SYMPTOM INDEX

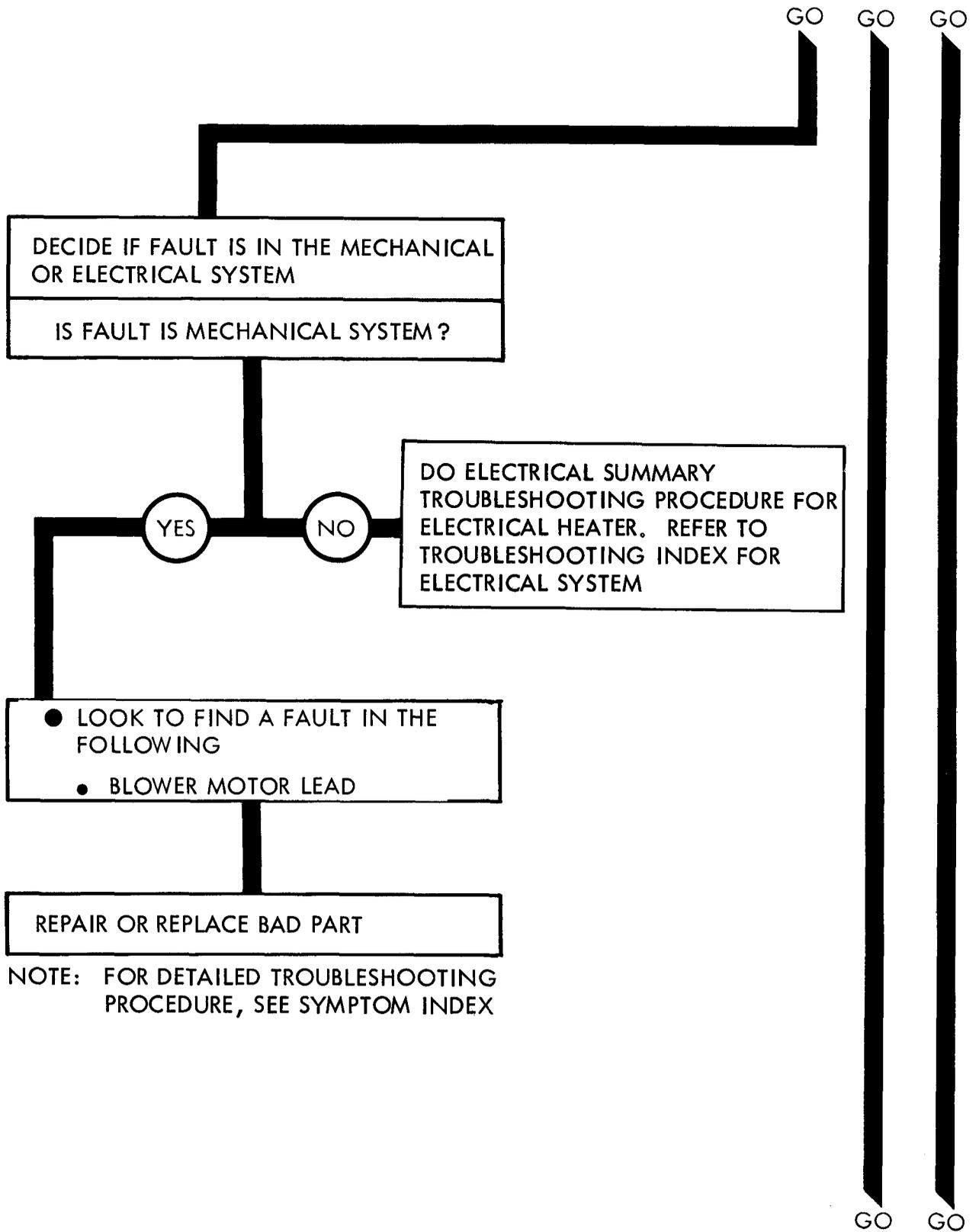

NOTE: FOR DETAILED TROUBLESHOOTING PROCEDURE, SEE SYMPTOM INDEX

Figure 92-1 (Sheet 4 of 6)

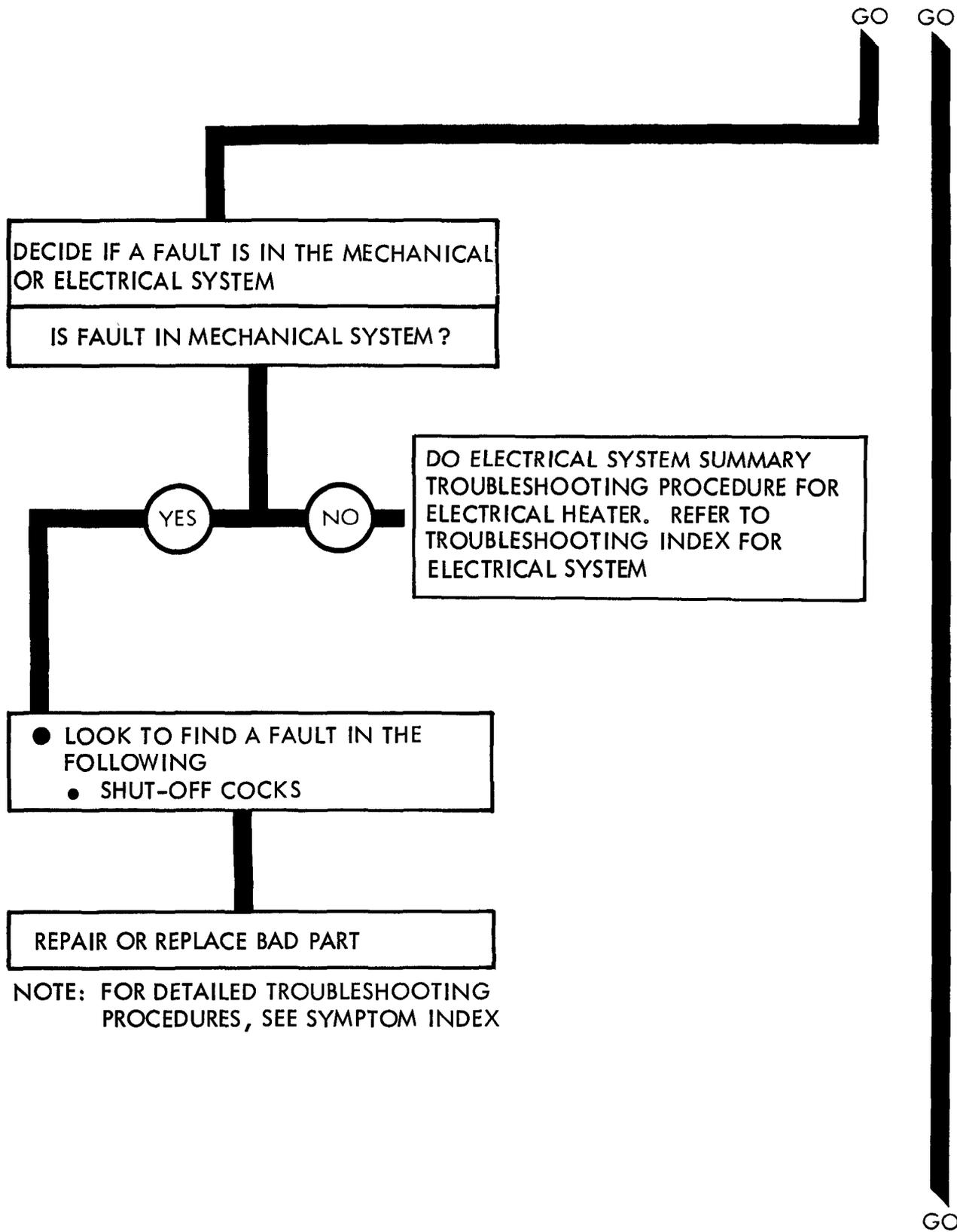
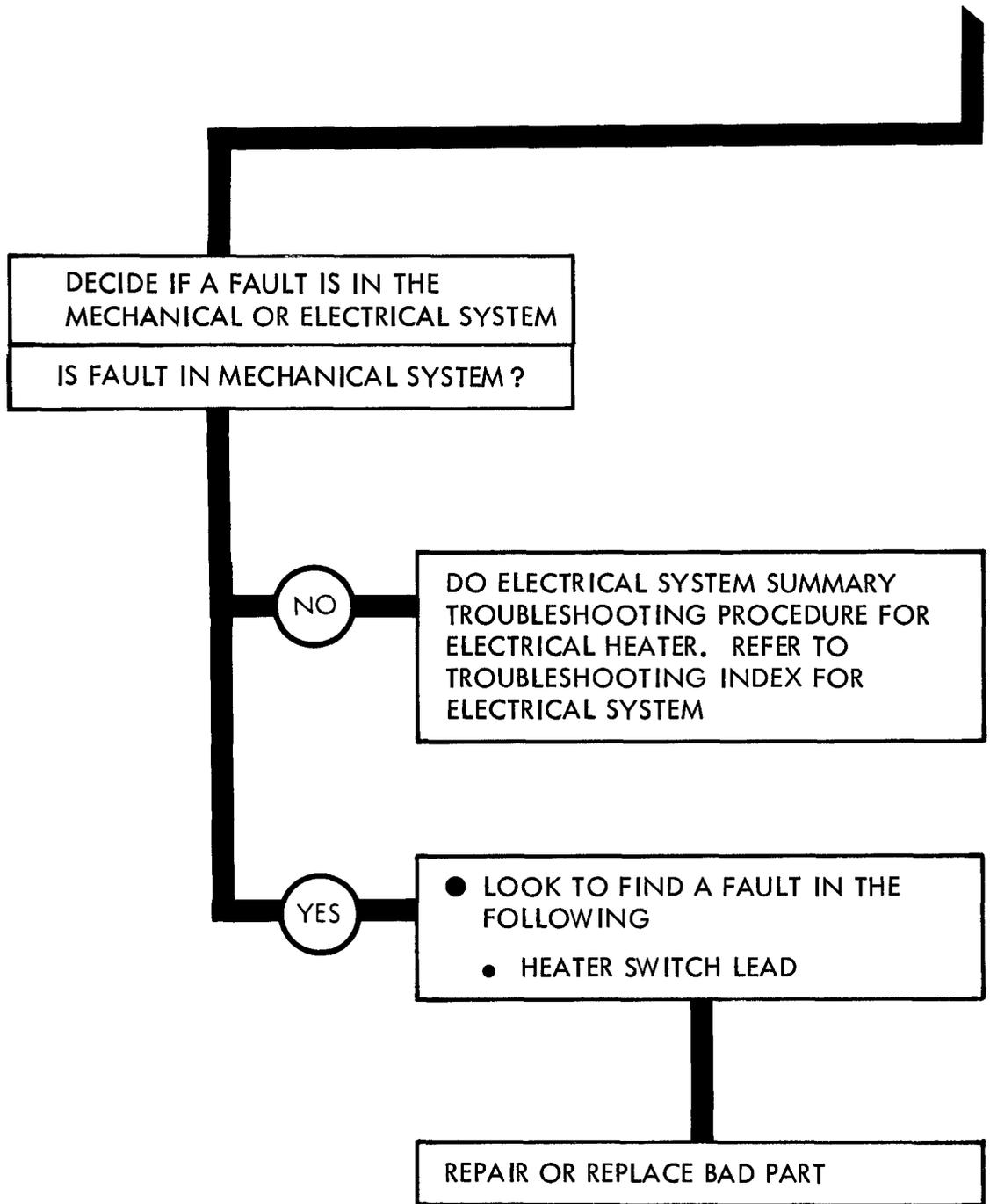

Figure 92-1 (Sheet 5 of 6)

TA 115142



NOTE: FOR DETAILED TROUBLESHOOTING PROCEDURE, SEE SYMPTOM INDEX

CHAPTER 93

HOT WATER HEATER CHECKOUT PROCEDURES

93-1. GENERAL. This chapter gives procedures for checking out the system after troubleshooting and repair have been done. Procedures are set up in flow chart form showing the checkout steps in order and referring to the fault symptom index when the system does not check out.

HOT WATER HEATER KIT CHECKOUT

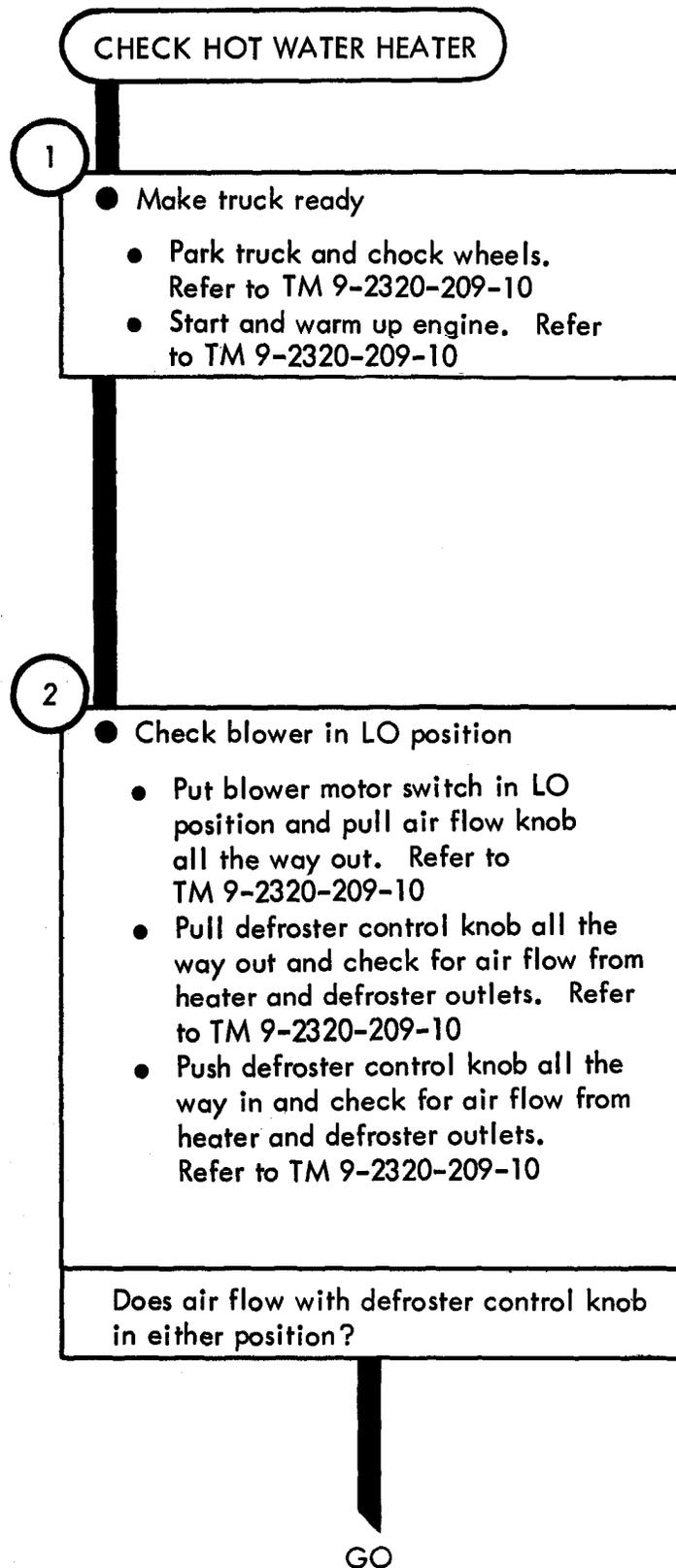

TA 115144

Figure 93-1 (Sheet 1 of 5)

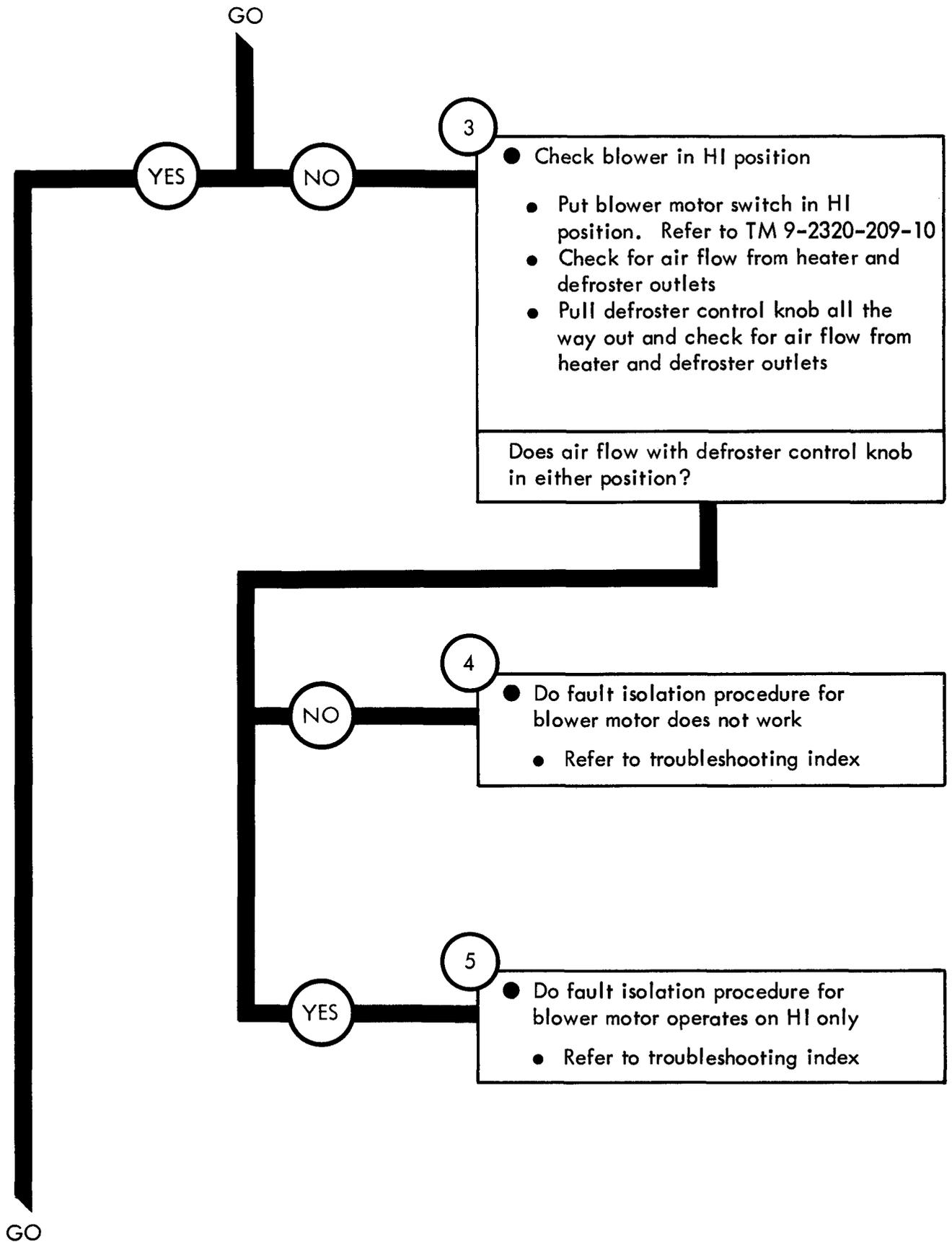
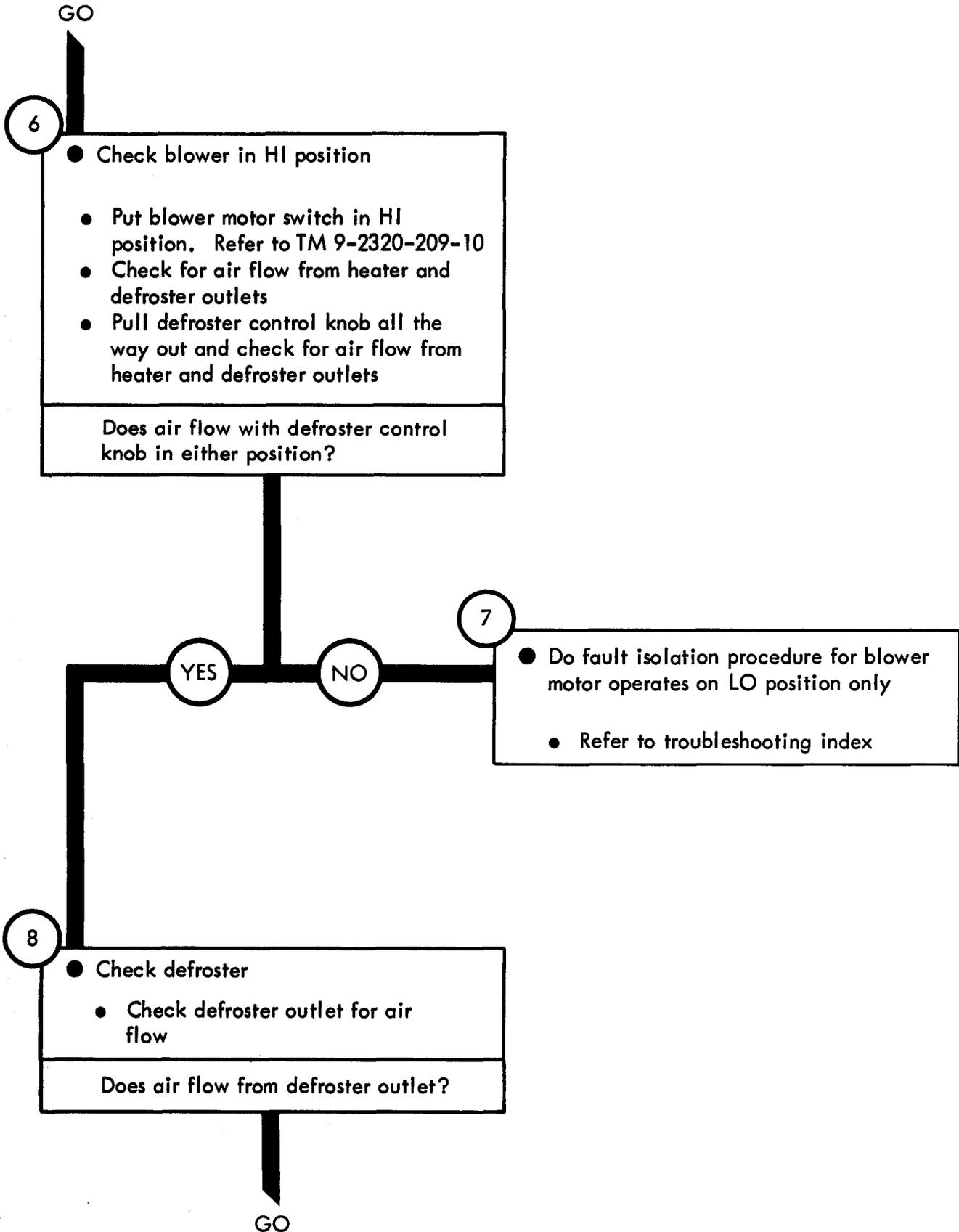

Figure 93-1 (Sheet 2 of 5)



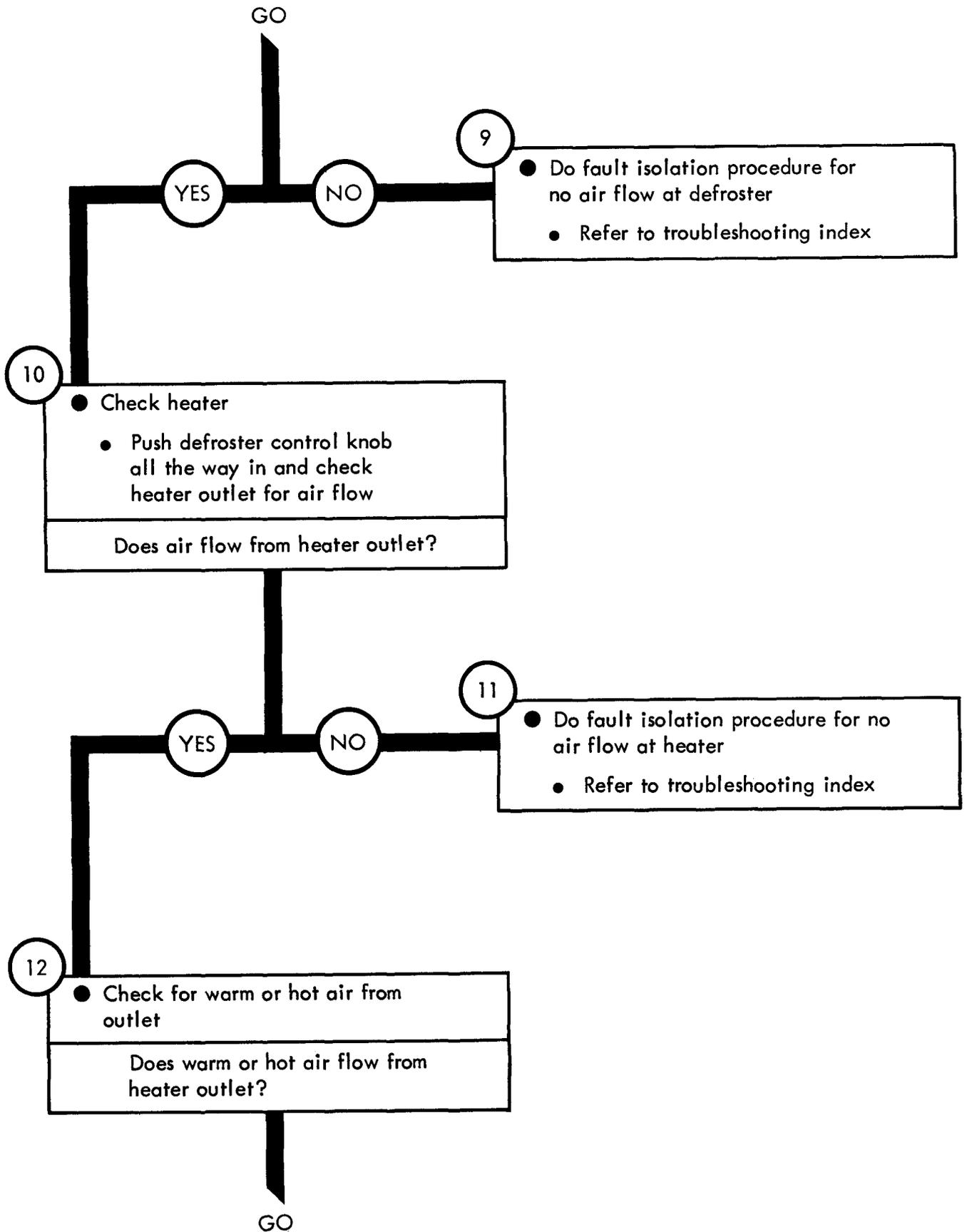
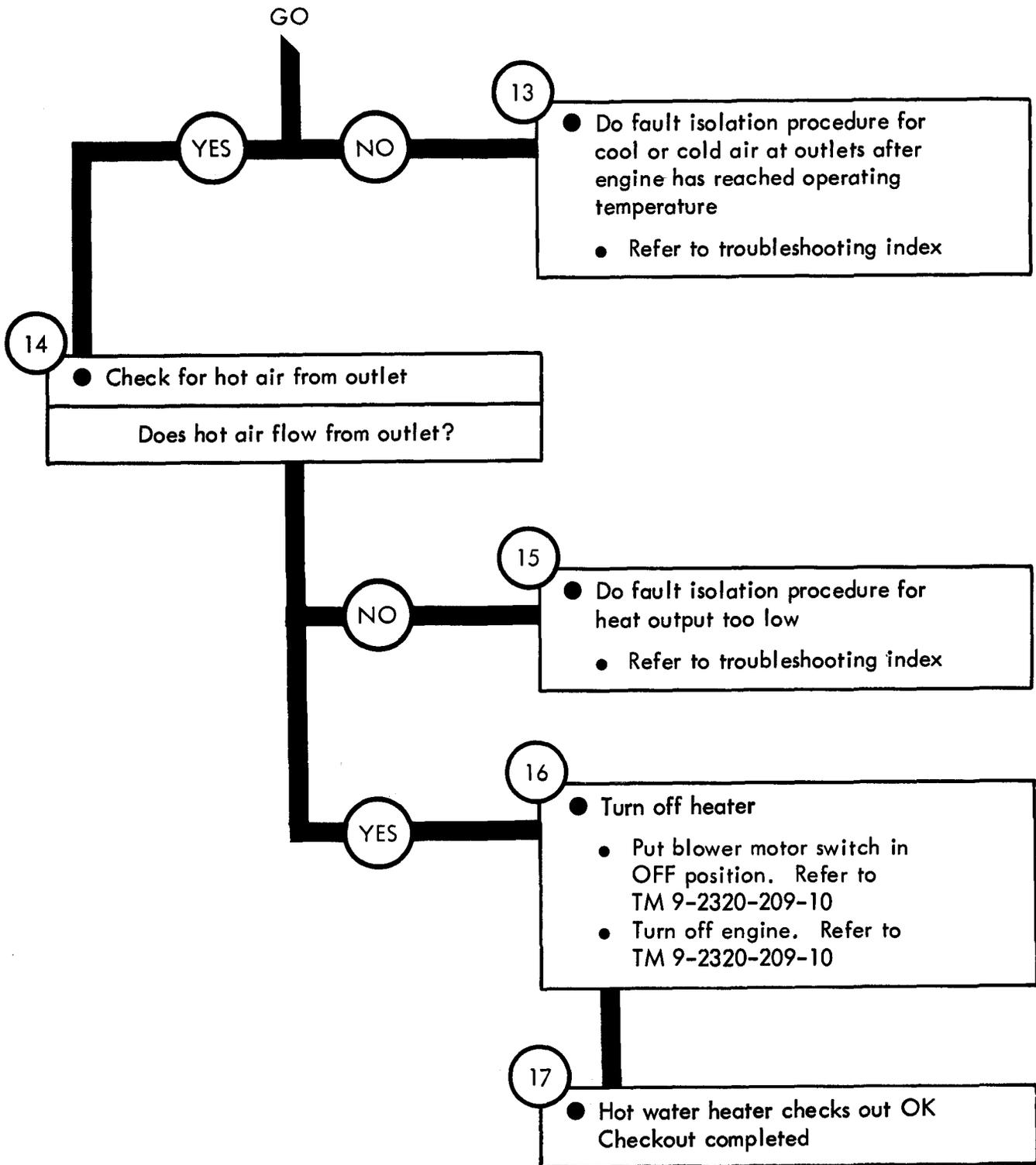

Figure 93-1 (Sheet 4 of 5)



TA 115148

CHAPTER 94

DEEP WATER FORDING KIT TROUBLESHOOTING

94-1. EQUIPMENT ITEMS COVERED. This chapter gives equipment troubleshooting procedures for the deep water fording kit, for which there are authorized corrective maintenance tasks at the organizational maintenance level.

94-2. EQUIPMENT ITEMS NOT COVERED. All equipment items for which corrective maintenance is authorized at the organizational maintenance level are covered in this chapter.

DEEP WATER FORDING KIT TROUBLESHOOTING

Symptom

1 ENGINE STALLS WHILE FORDING OR AFTER LEAVING WATER ON ALL TRUCKS EXCEPT M35A1 AND SOME M35A2

- 1
- Tow truck to work area
 - Refer to TM 9-2320-209-10

CAUTION

Do not start engine after truck has been removed from water. If water has entered engine assembly serious damage may occur if engine is started. Engine must be overhauled. Refer to direct support maintenance

- 2
- Check crankcase breather air inlet hose
 - Look to see if air inlet hose is off breather. See figure 96-1
 - Feel for a loose air inlet hose connection
 - Look for cracked or broken air inlet hose
- Is air inlet hose OK?

GO

Figure 94-1 (Sheet 1 of 5)

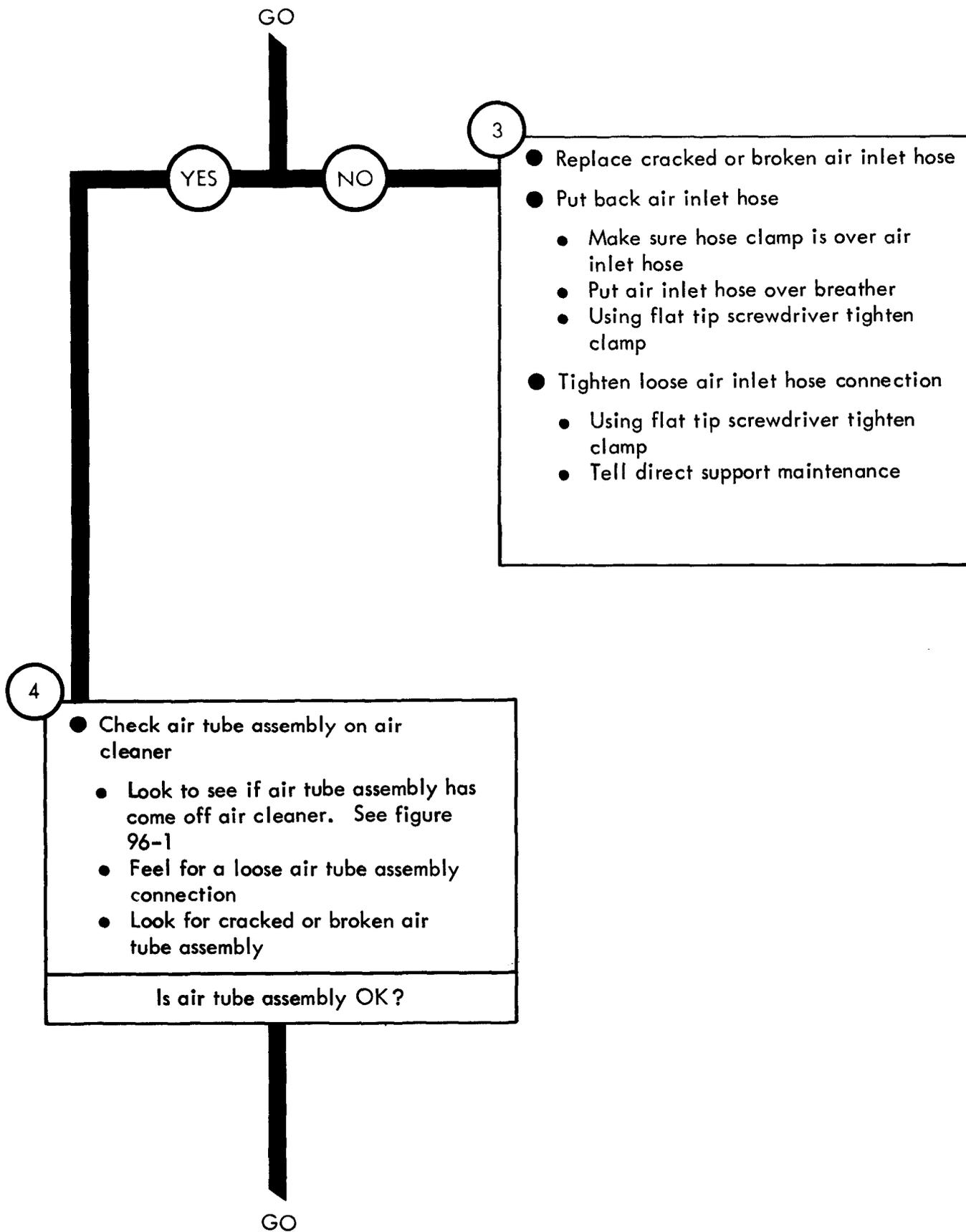
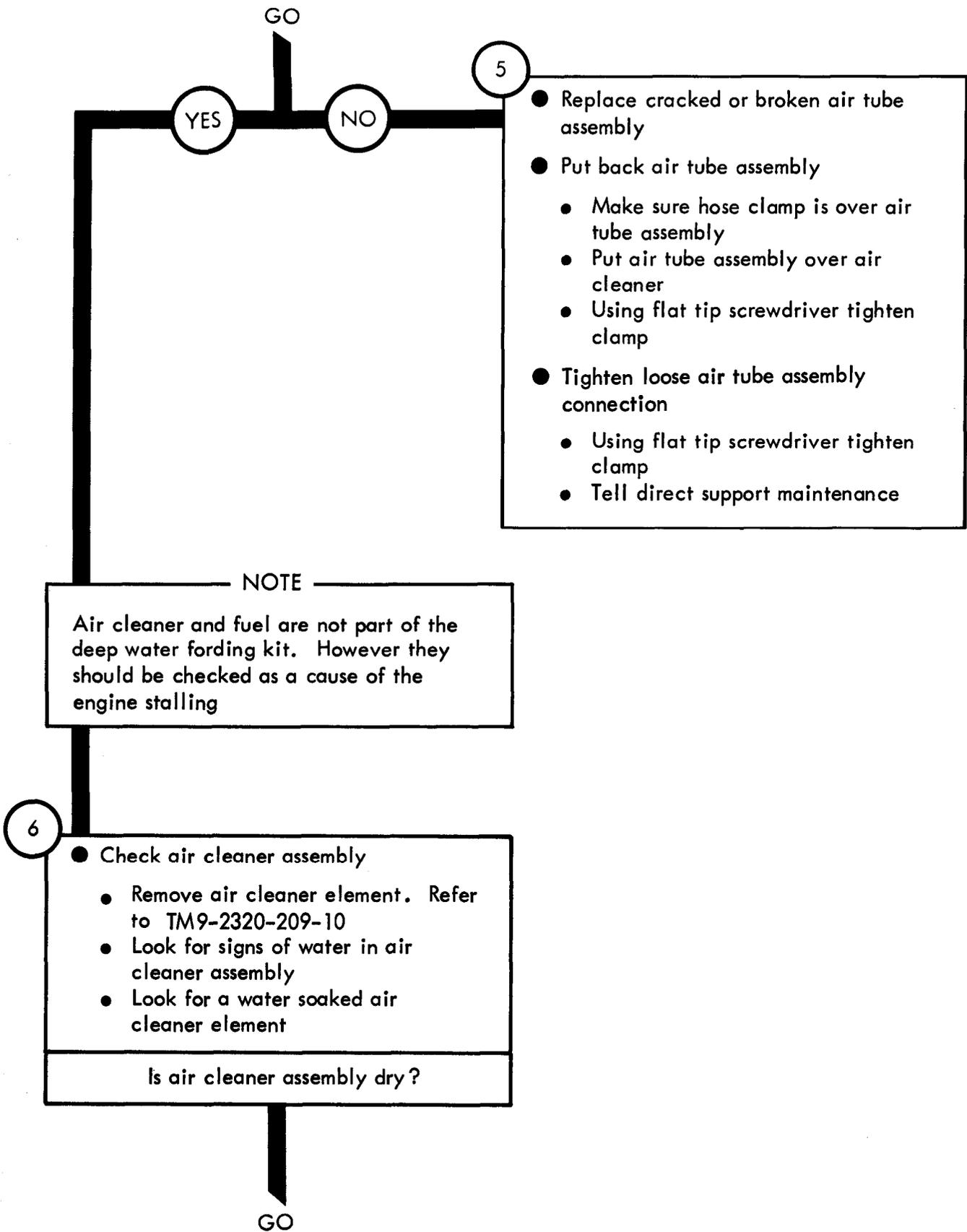

Figure 94-1 (Sheet 2 of 5)



TA 115151

Figure 94-1 (Sheet 3 of 5)

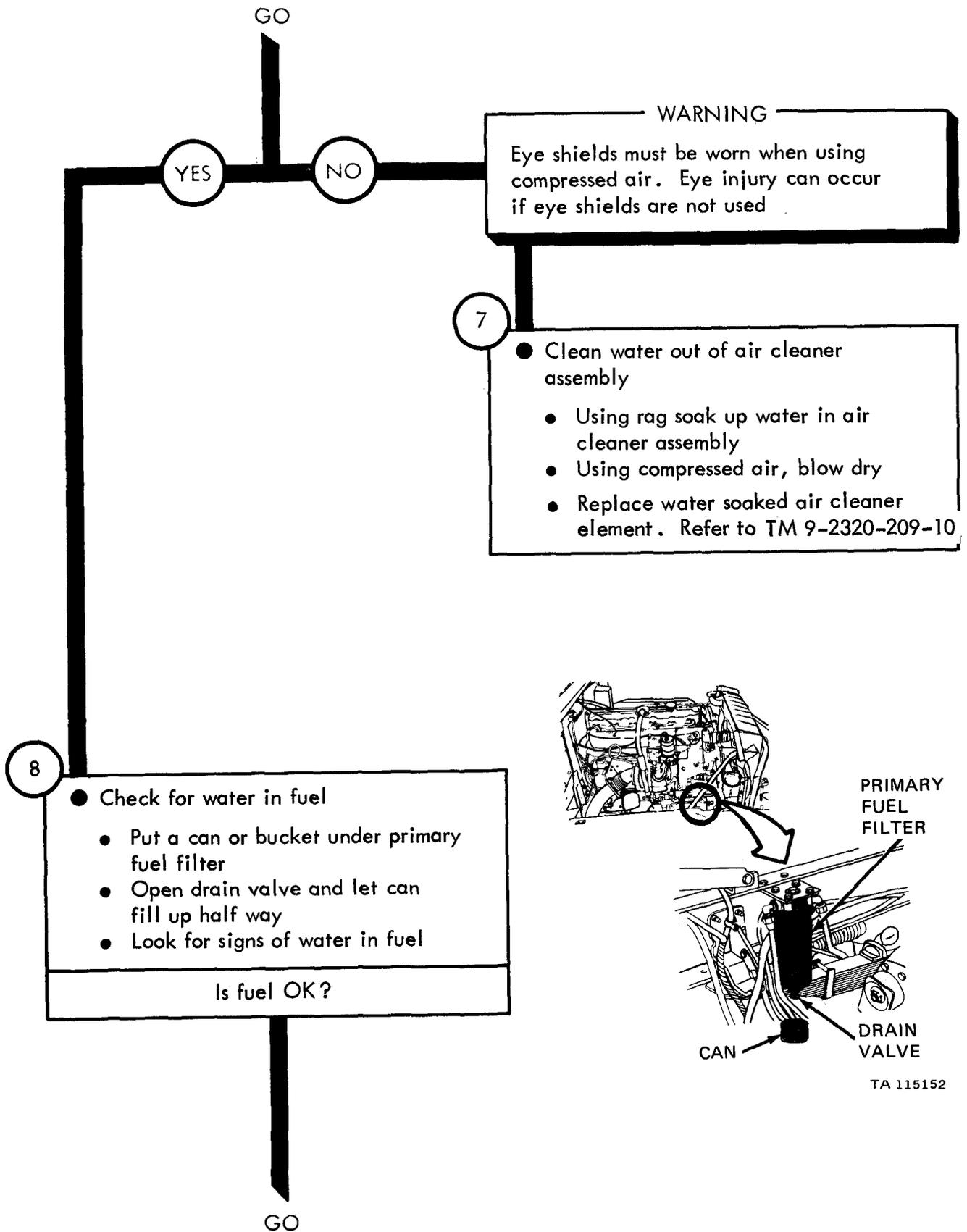
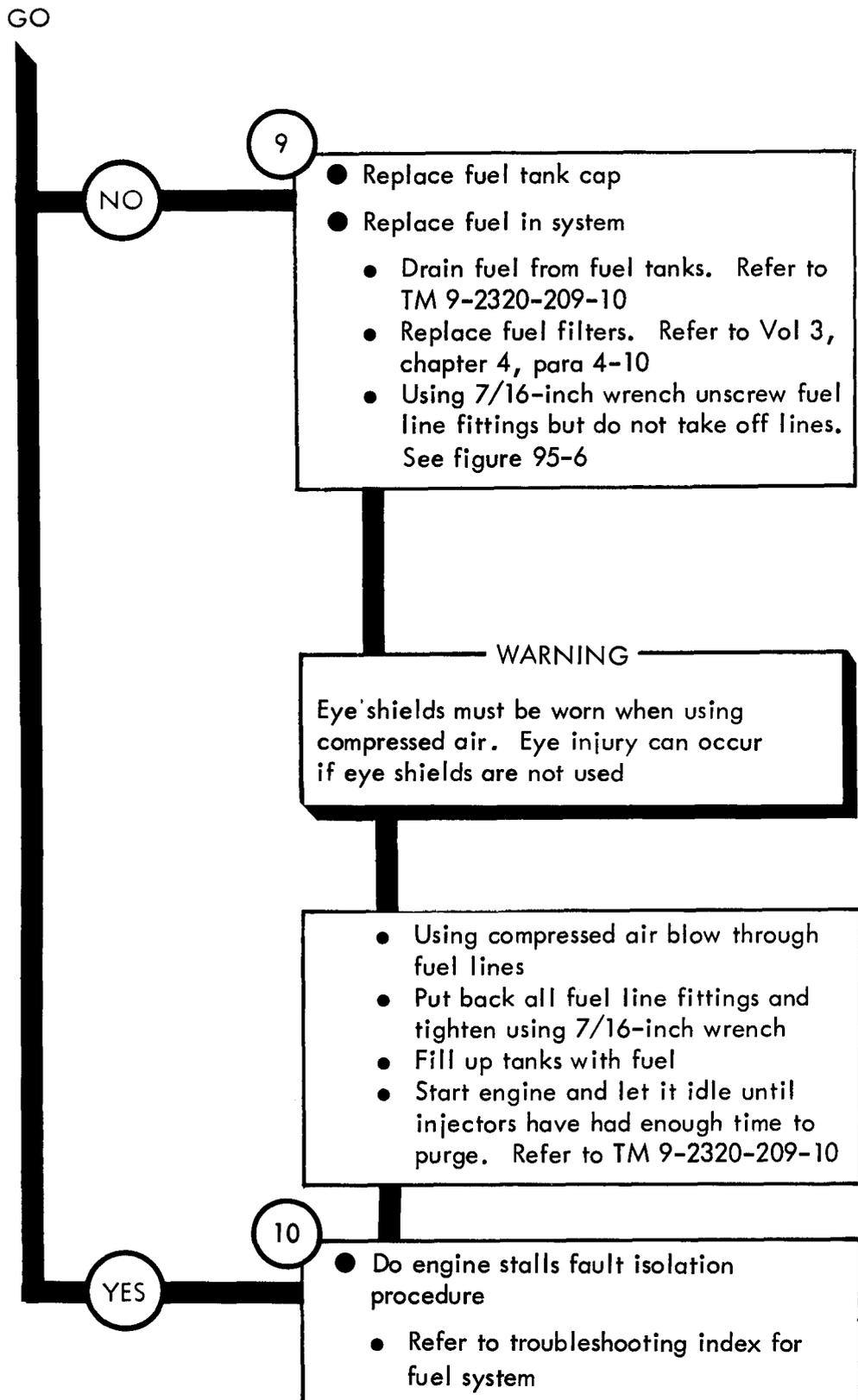

Figure 94-1 (Sheet 4 of 5)



TA 115153

Figure 94-1 (Sheet 5 of 5)

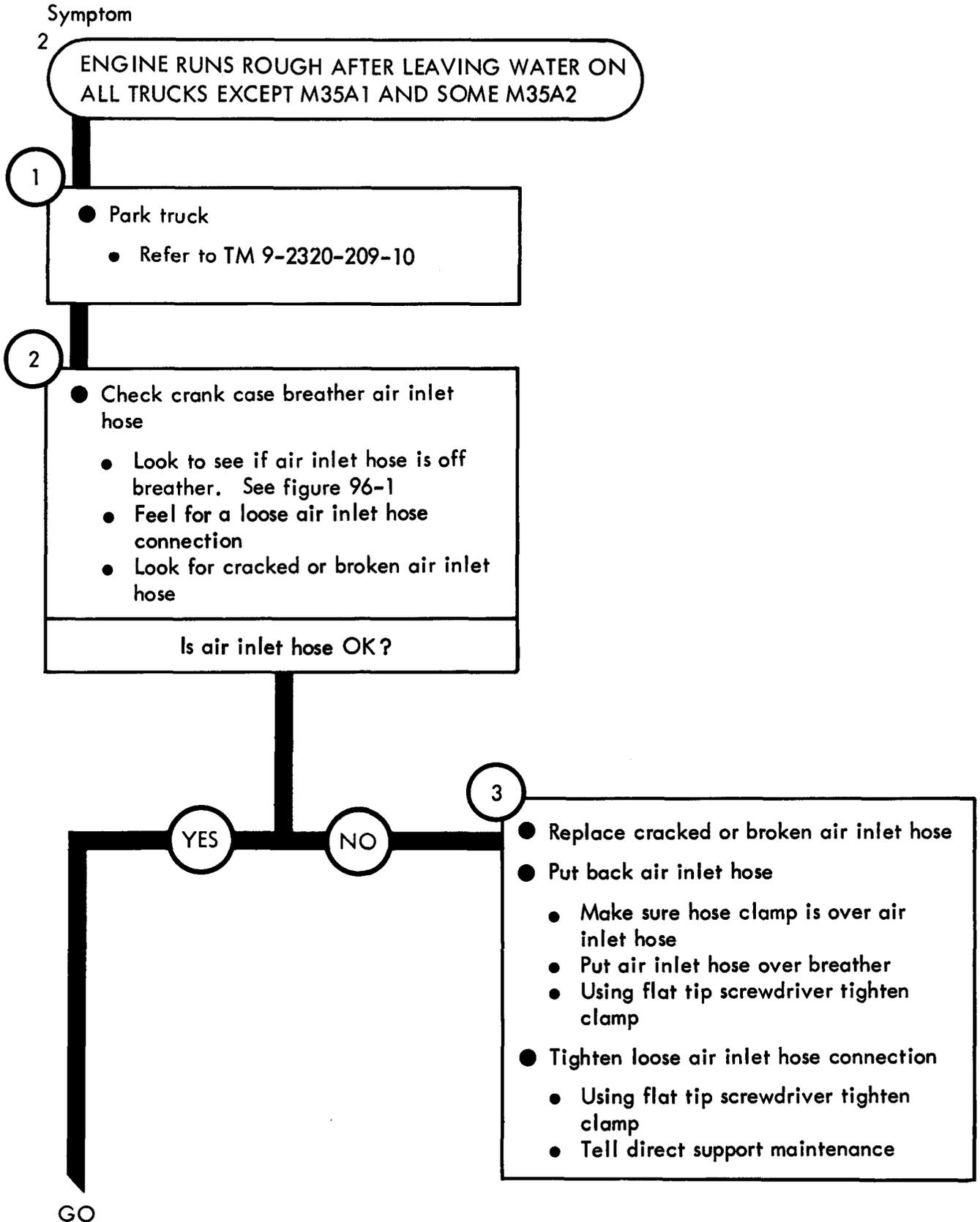
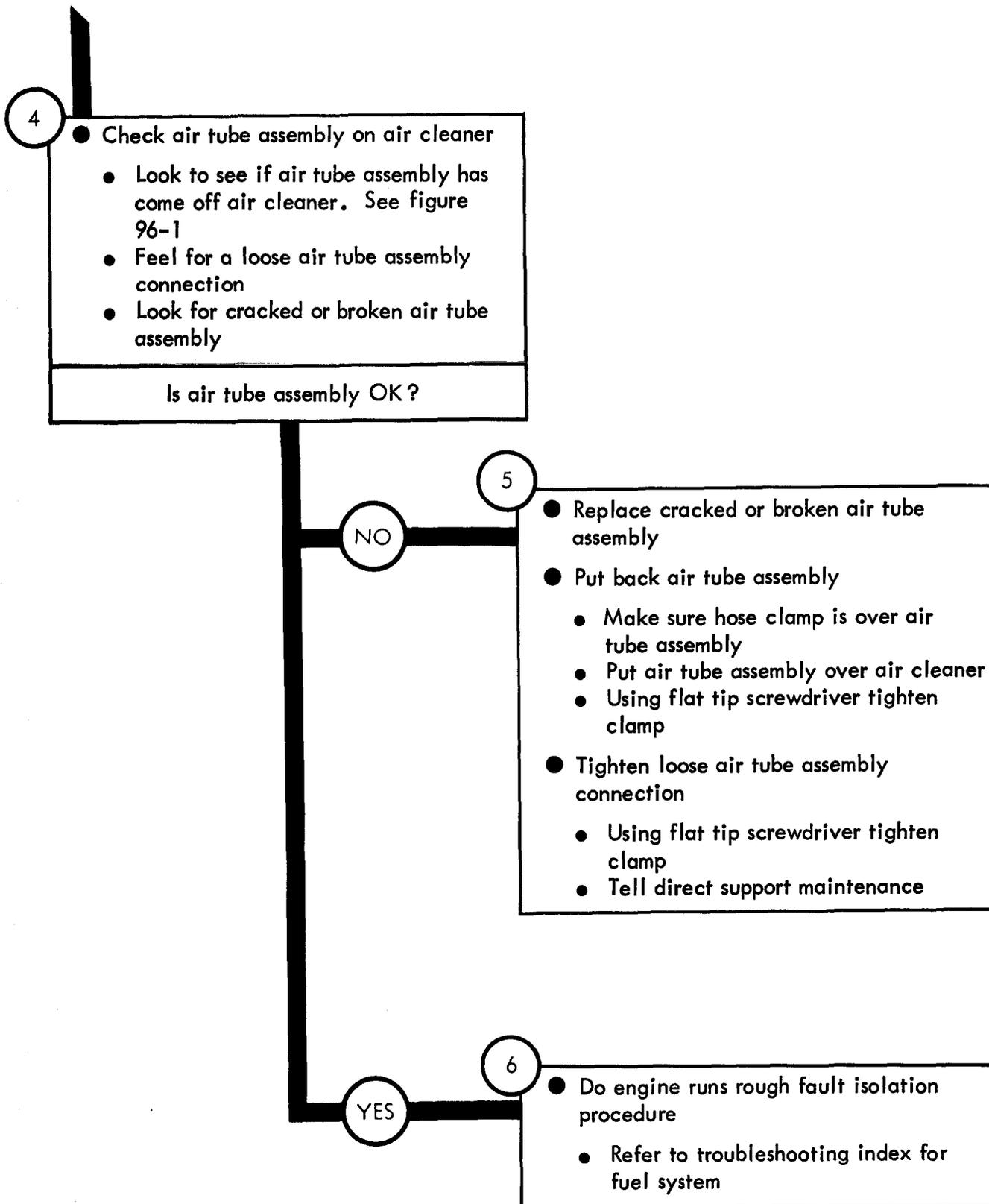

Figure 94-2 (Sheet 1 of 2)



TA 115160

Figure 94-2 (Sheet 2 of 2)

Symptom

1

ENGINE STALLS WHILE FORDING OR AFTER LEAVING WATER ON TRUCKS M35A1 AND SOME M35A2

1

- Tow truck to work area
- Refer to TM 9-2320-209-10

— — — CAUTION — — —

Do not start engine after truck has been removed from water. If water has entered engine assembly serious damage may occur if engine is started. Engine must be overhauled. Refer to direct support maintenance

2

- Check crankcase breather air inlet hose
 - Look to see if air inlet hose is off breather. See figure 96-1
 - Feel for a loose air inlet hose connection
 - Look for cracked or broken air inlet hose

Is air inlet hose OK?



GO

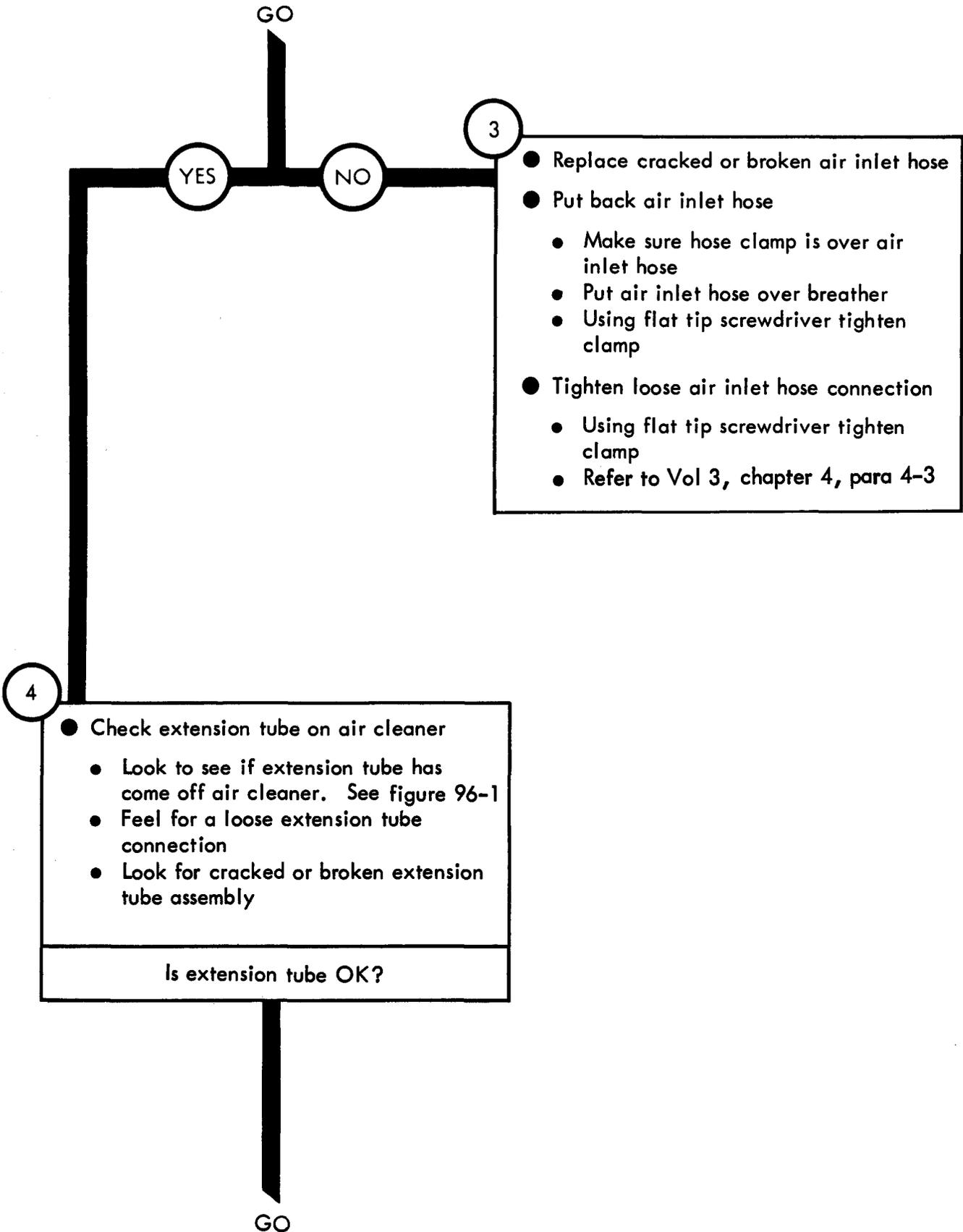

TA 115155

Figure 94-3 (Sheet 2 of 5)

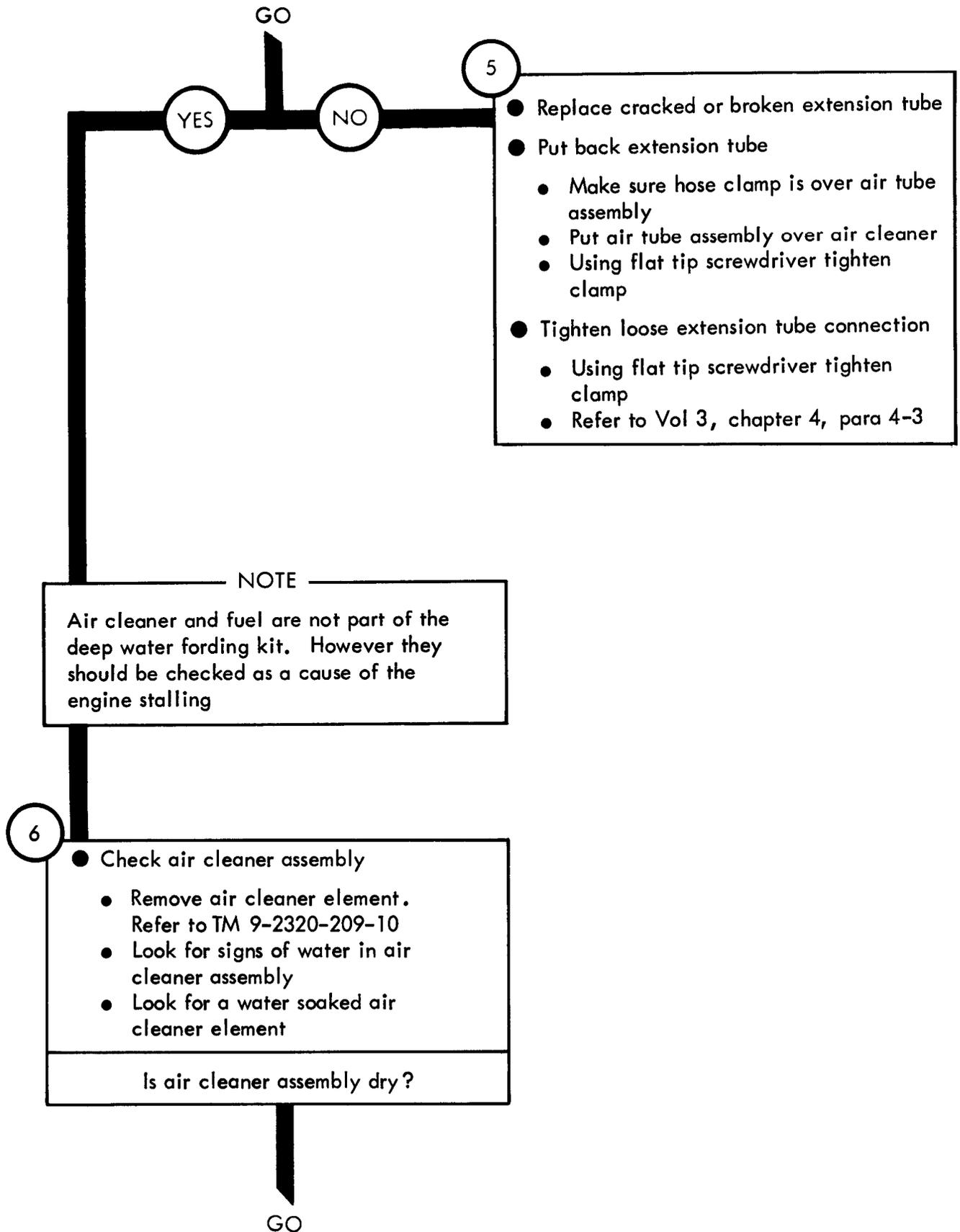
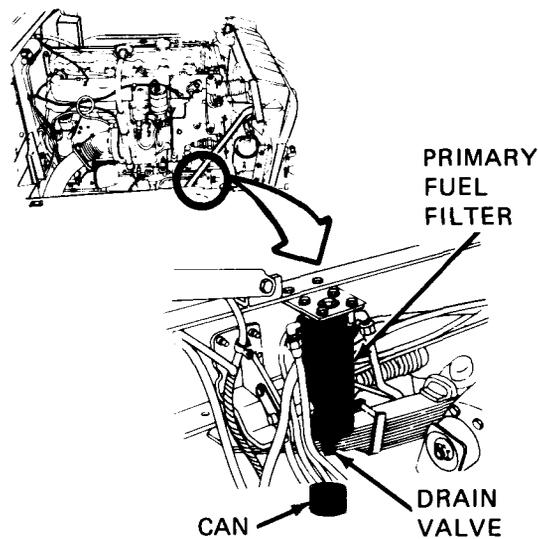
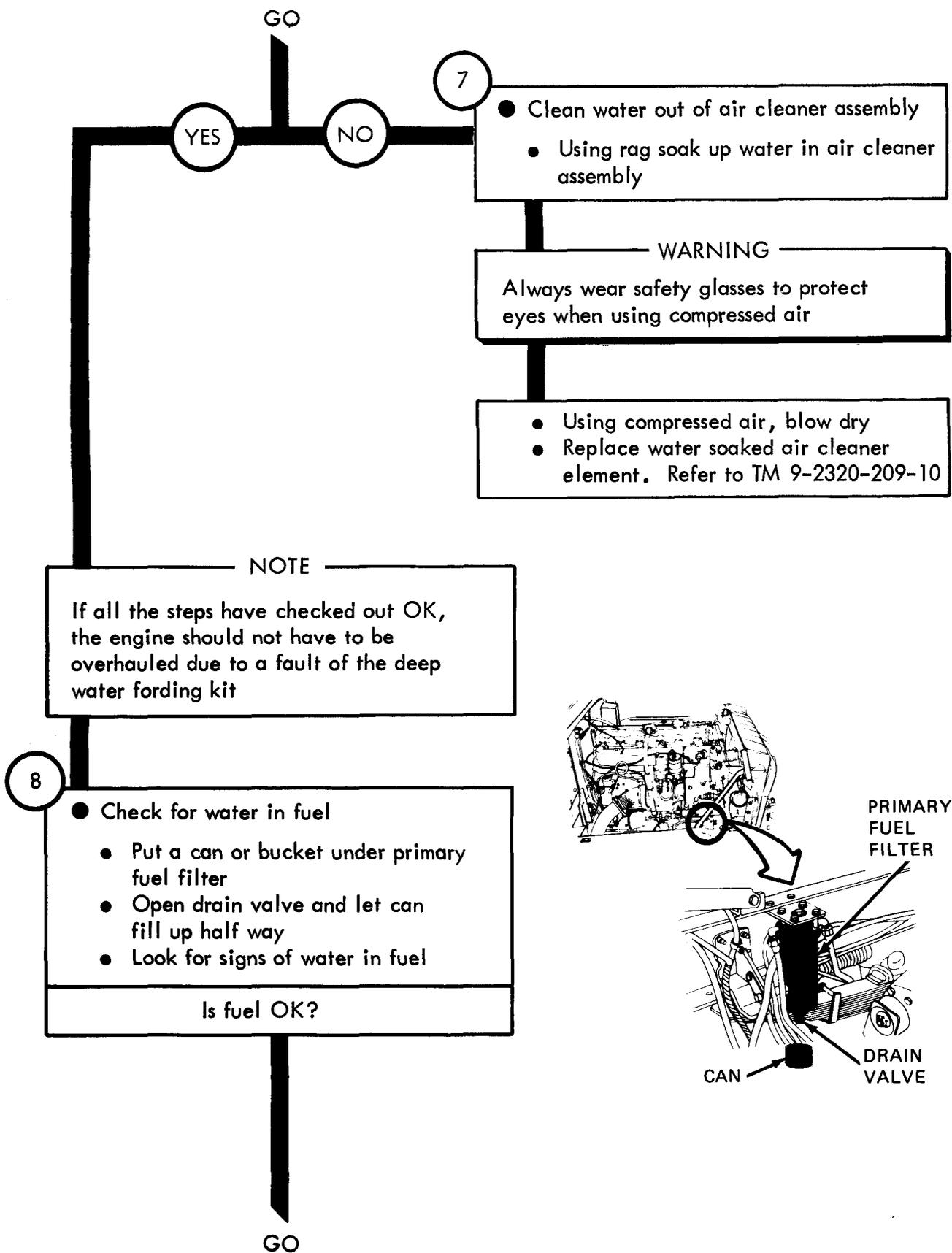
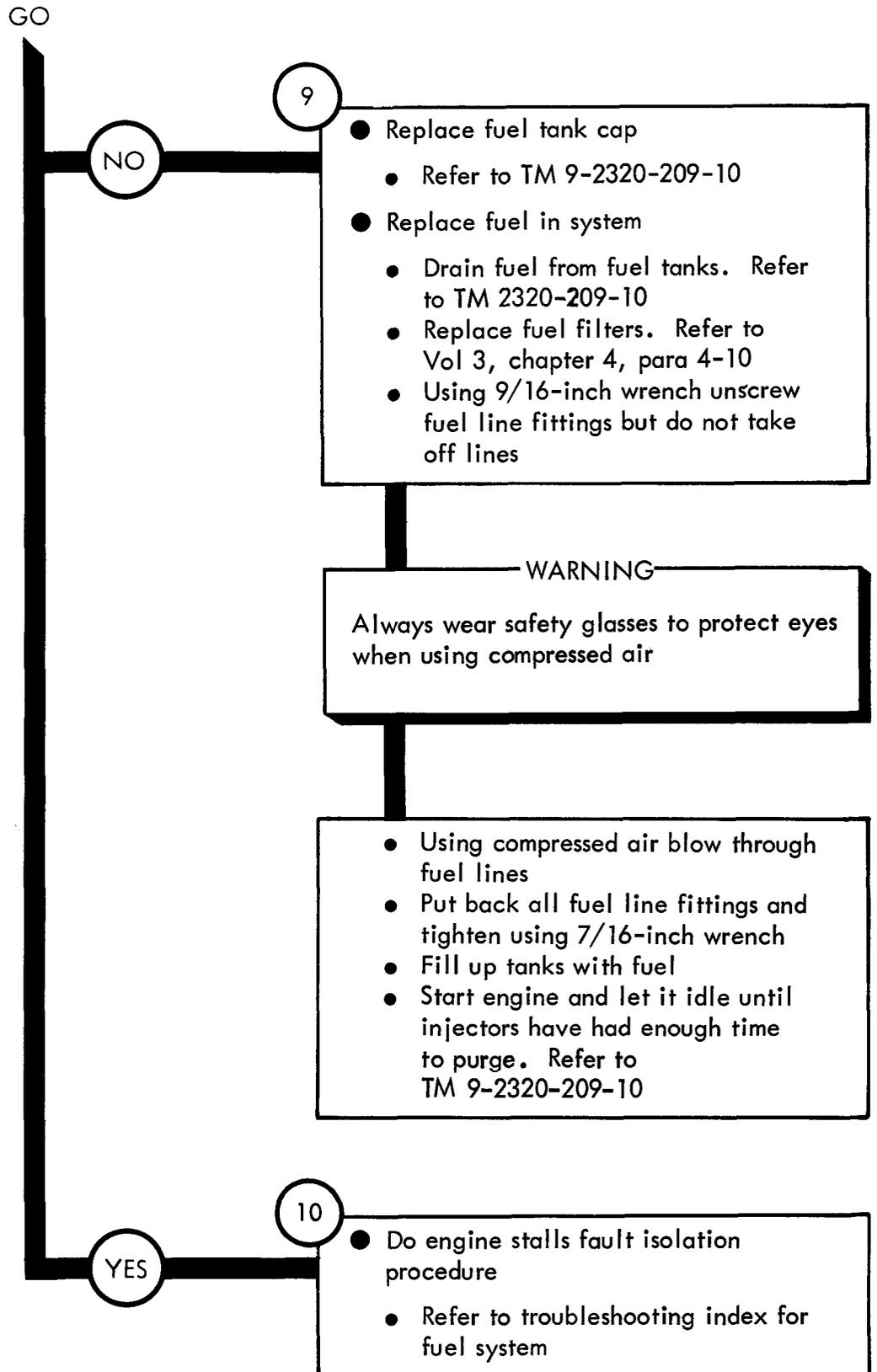

Figure 94-3 (Sheet 3 of 5)



TA 115157

Figure 94-3 (Sheet 4 of 5)



TA 115158

Figure 94-3 (Sheet 5 of 5)

Symptom

2

ENGINE RUNS ROUGH AFTER LEAVING WATER ON TRUCKS M35A1 AND SOME M35A2

1

- Park truck
 - Refer to TM 9-2320-209-10

2

- Check crankcase breather air inlet hose
 - Look to see if air inlet hose is off breather. See figure 96-1
 - Look for a loose air inlet hose connection
 - Look for cracked or broken air inlet hose

Is air inlet hose OK?

GO

Figure 94-4 (Sheet 1 of 3)

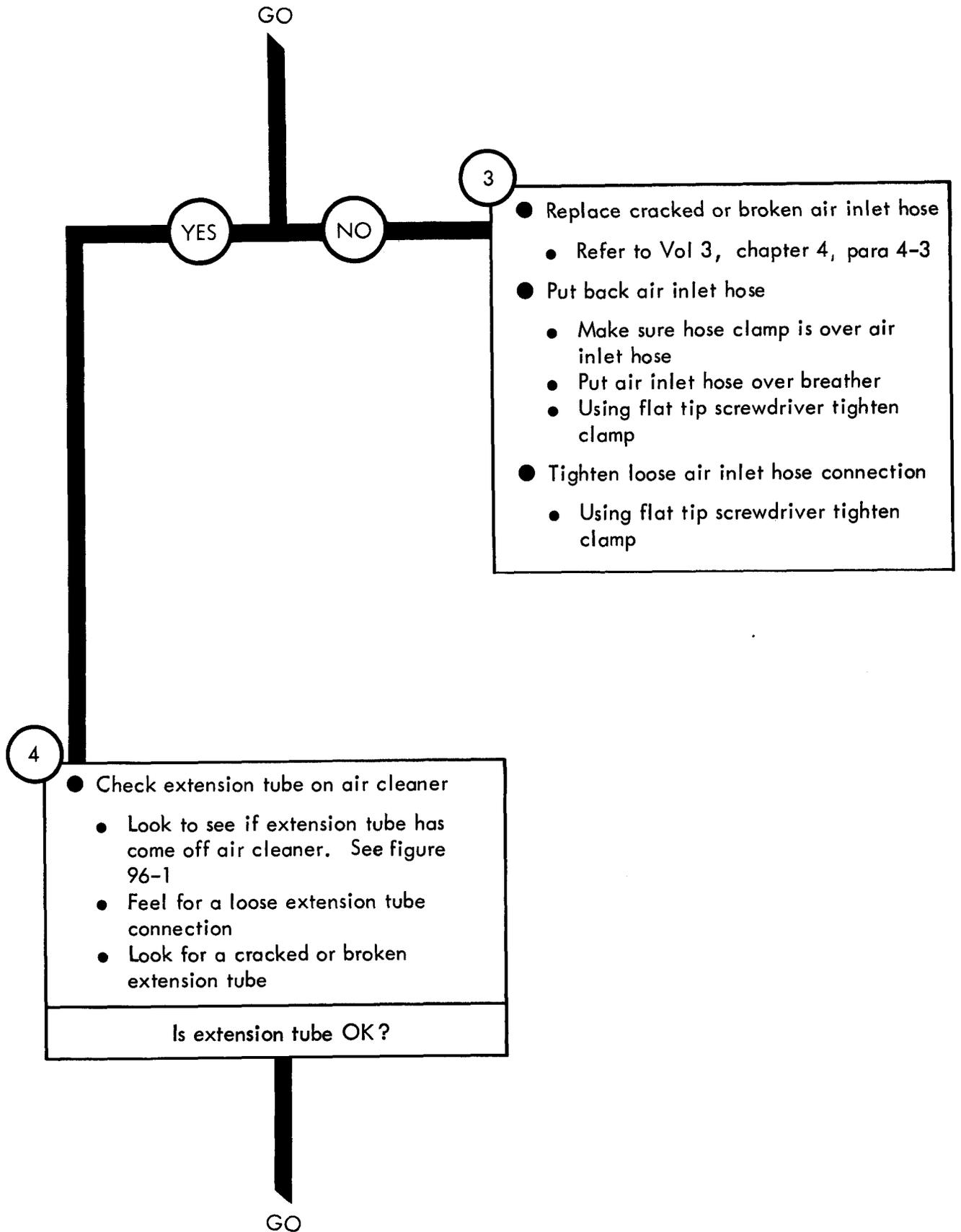

TA 115162

Figure 94-4 (Sheet 2 of 3)

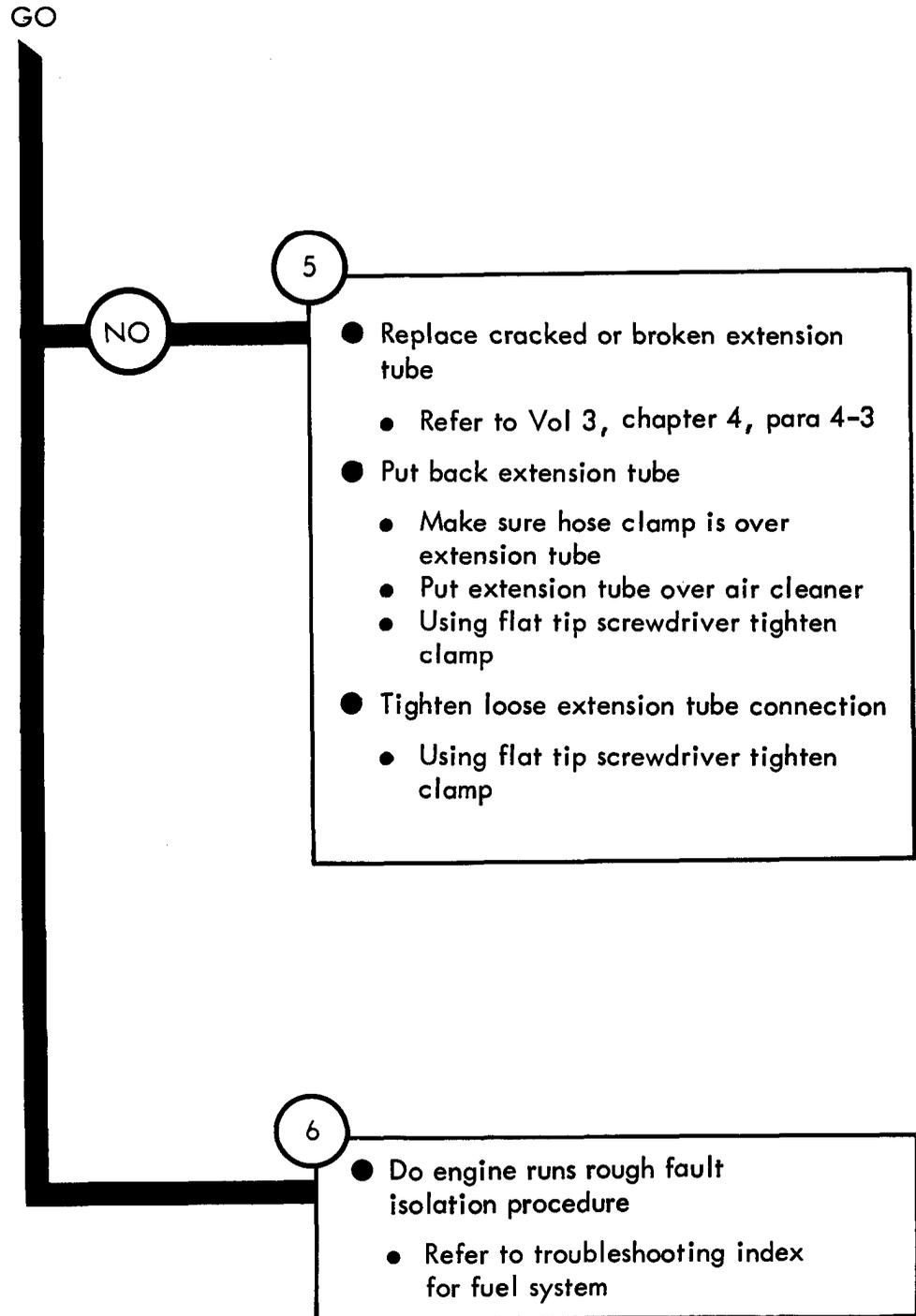

TA 115163

Figure 94-4 (Sheet 3 of 3)

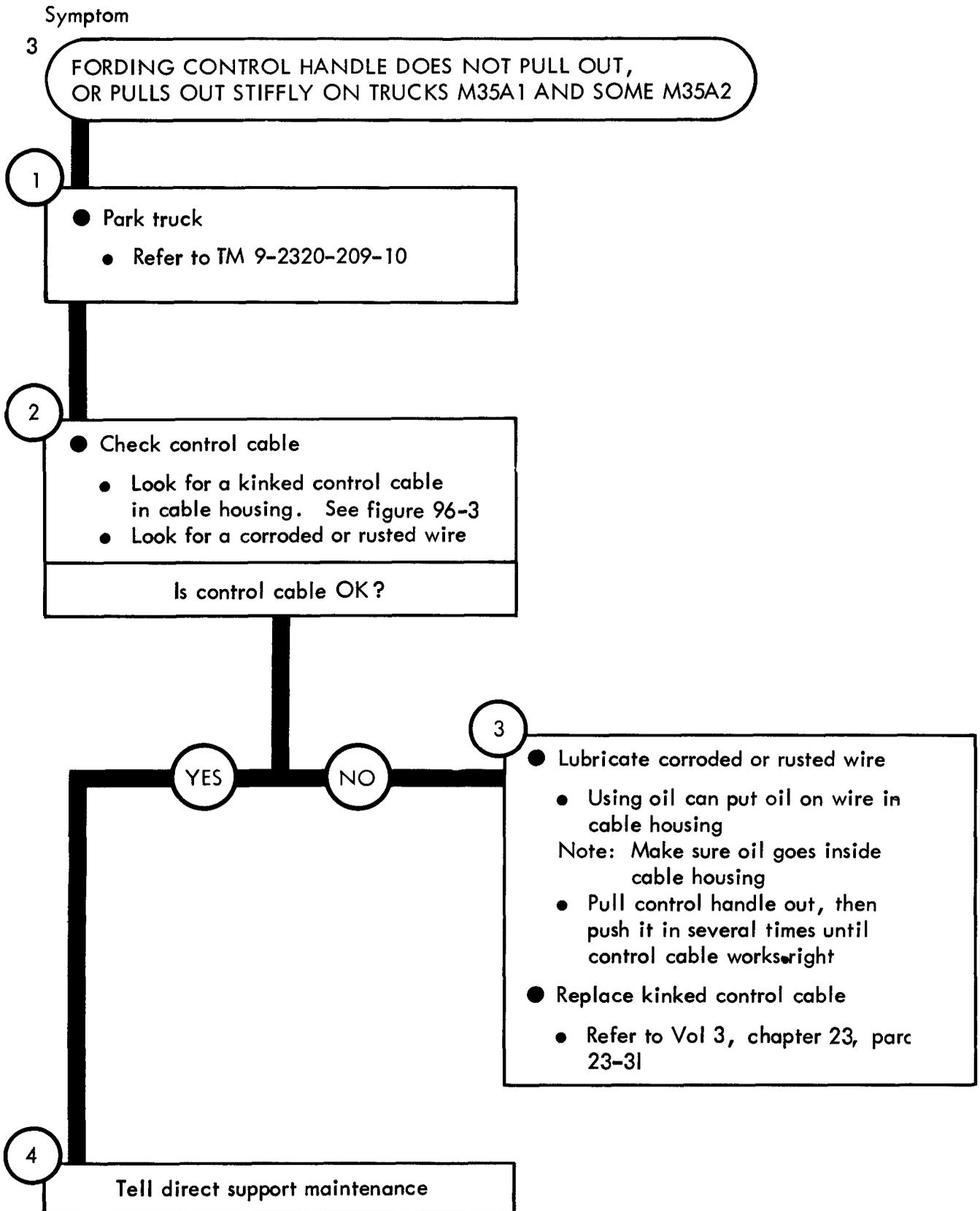

TA 115167

Figure 94-5

Symptom

4

CLUTCH SLIPS AFTER LEAVING WATER ON ALL TRUCKS WITH KIT

1

- Park truck
 - Refer to TM 9-2320-209-10
 - Chock wheels

NOTE

Before doing any troubleshooting on clutch the deep water fording kit must be checked out

2

- Drain water from transmission clutch housing
 - Remove clutch housing inspection cover
 - Allow all water to drain

WARNING

Always wear safety glasses to protect eyes when using compressed air

- Using compressed air, blow dry clutch
- Put back clutch housing inspection cover

Figure 94-6 (Sheet 1 of 3)

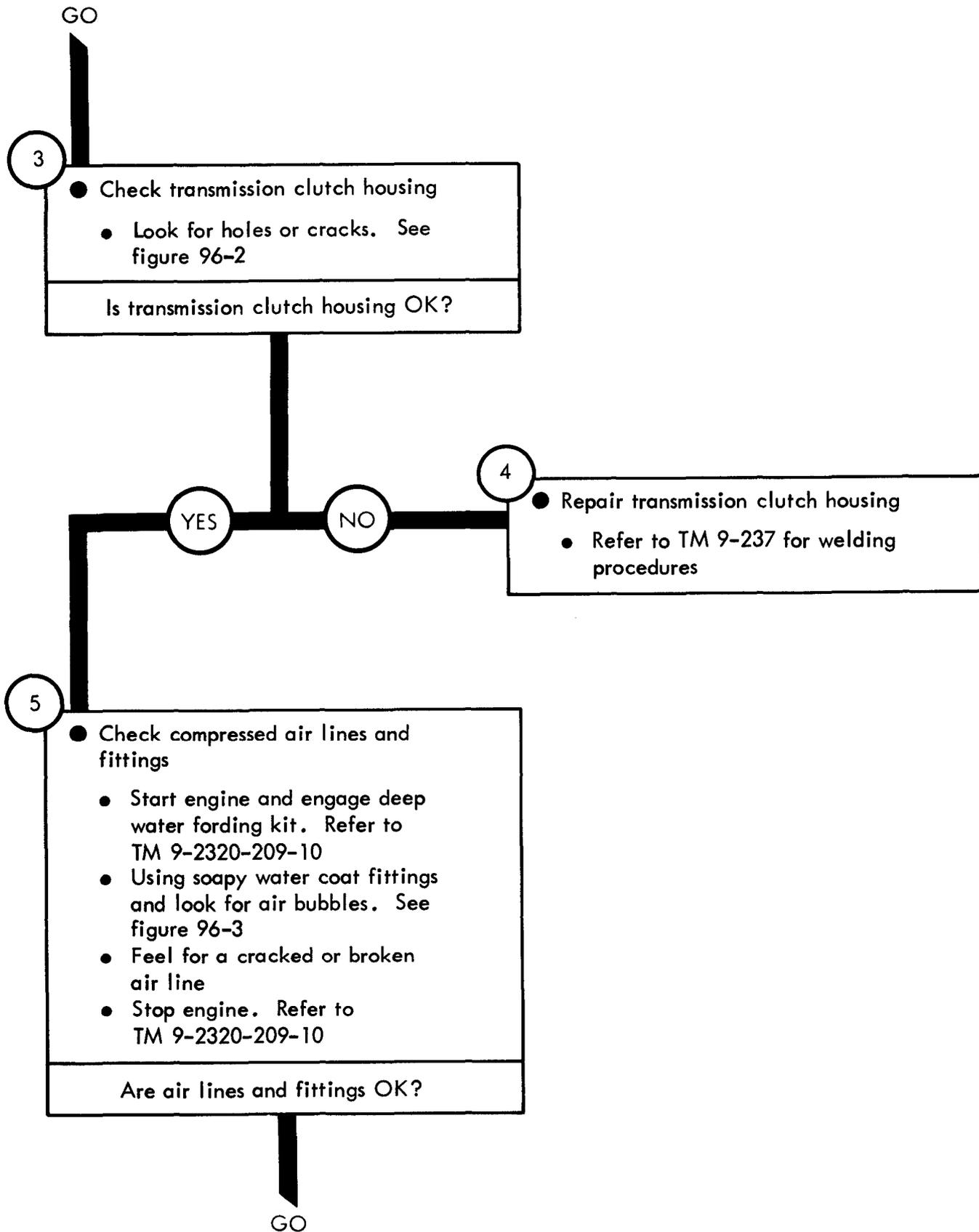

TA 115165

Figure 94-5 (Sheet 2 of 3)

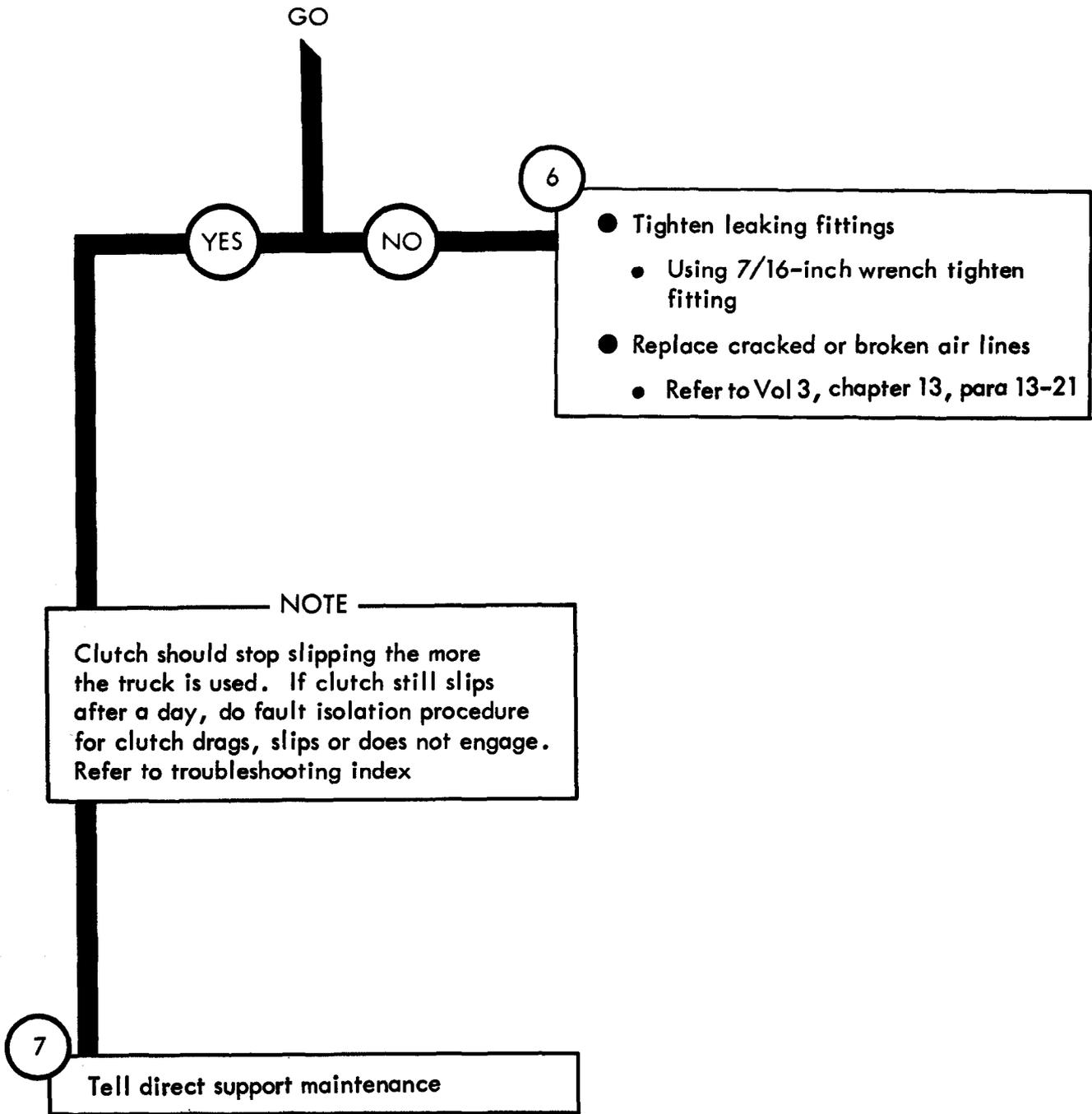

Symptom

5

WARNING BUZZER SOUNDS, OR AIR COMPRESSOR MAKES NOISE, AFTER LEAVING WATER ON ALL TRUCKS WITH KIT

1

- Tow truck to work area
 - Refer to procedures given in TM 9-2320-209-10
 - Chock wheels

2

- Check air compressor air inlet hose
 - Look for a cracked or broken hose. See figure 96-3
 - See if hose connection has come off air compressor
 - Feel for a loose hose connection to air compressor and air cleaner

Is air compressor drive belt OK?

YES

NO

GO

NOTE

Air compressor must be replaced due to the damage caused by the bad air compressor inlet hose. Make sure hose connection to new compressor is tight. Refer to Vol 3, chapter 13, para 13-31 for replacement of air compressor

3

- Replace cracked or broken air compressor air inlet hose
 - Refer to Vol 3, chapter 13, para 13-21

Figure 94-7 (Sheet 1 of 2)

GO

NOTE

Air compressor drive belt are not part of the deep water fording kit. However it should be checked as a cause of the warning buzzer sounding or the air compressor making noise

AIR COMPRESSOR DRIVE BELT

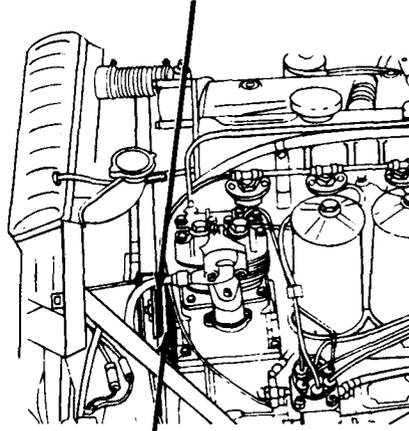

COMPRESSOR PULLEY

4

- Check air compressor drive belt
 - Take off battery ground cable. Refer to Vol 3, chapter 7, para 7-58
 - Look for signs of a slipping belt
 - Feel for a loose belt

Is air compressor drive belt OK?

YES

NO

5

- Adjust loose or slipping belt
 - Refer to Vol 3, chapter 13, para 13-34c
- Note: If belt is too loose to be adjusted it should be replaced. Refer to Vol 3, chapter 13, para 13-34

6

- Replace air compressor
 - Refer to Vol 3, chapter 13, para 13-31

CHAPTER 95

DEEP WATER FORDING KIT TROUBLESHOOTING SUMMARY

95-1. GENERAL. This chapter gives a summary of troubleshooting procedures given in chapter 94 for the deep water fording kit.

95-2. PROCEDURES. The summary in this chapter covers all fault symptoms found in the detailed troubleshooting procedures. Chapter 7 outlines a sample troubleshooting procedure. The summary procedures are based on the "what-to-do" portions of the detailed procedures and do not include the "how-to-do-it" instructions. Warnings, cautions, and notes are given where needed.

DEEP WATER FORDING KIT ENGINE TROUBLESHOOTING SUMMARY

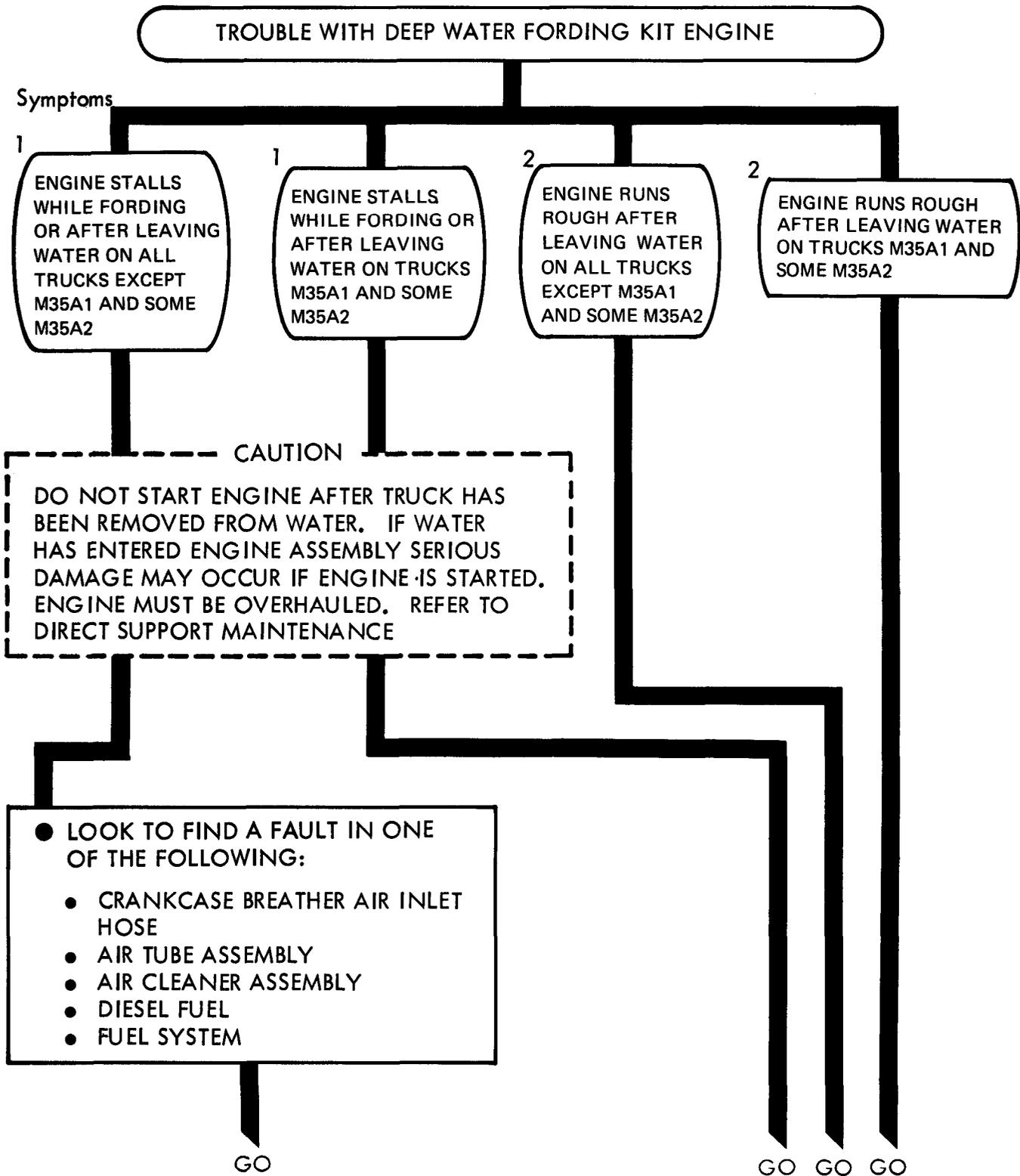

Figure 95-1 (Sheet 1 of 3)

TA 115170

GO

REPAIR OR REPLACE BAD PART

NOTE: FOR DETAILED TROUBLESHOOTING PROCEDURES, SEE SYMPTOM INDEX

GO GO GO



- LOOK TO FIND A FAULT IN ONE OF THE FOLLOWING:
 - CRANKCASE BREATHER AIR INLET HOSE
 - EXTENSION TUBE
 - AIR CLEANER ASSEMBLY
 - DIESEL FUEL
 - FUEL SYSTEM

REPAIR OR REPLACE BAD PART

NOTE: FOR DETAILED TROUBLESHOOTING PROCEDURES, SEE SYMPTOM INDEX



GO GO

Figure 95-1 (Sheet 2 of 3)

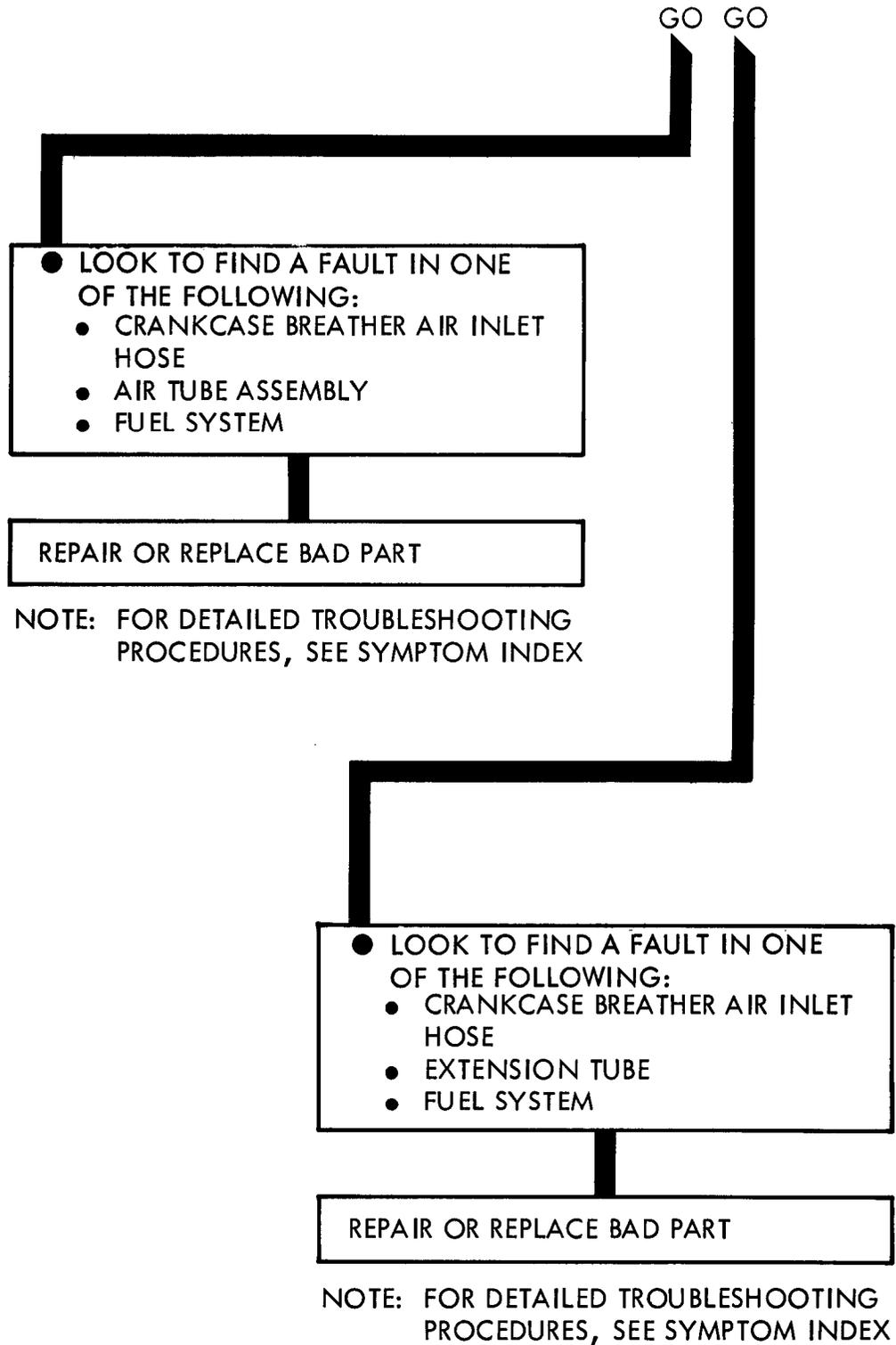

TA 115172

Figure 95-1 (Sheet 3 of 3)

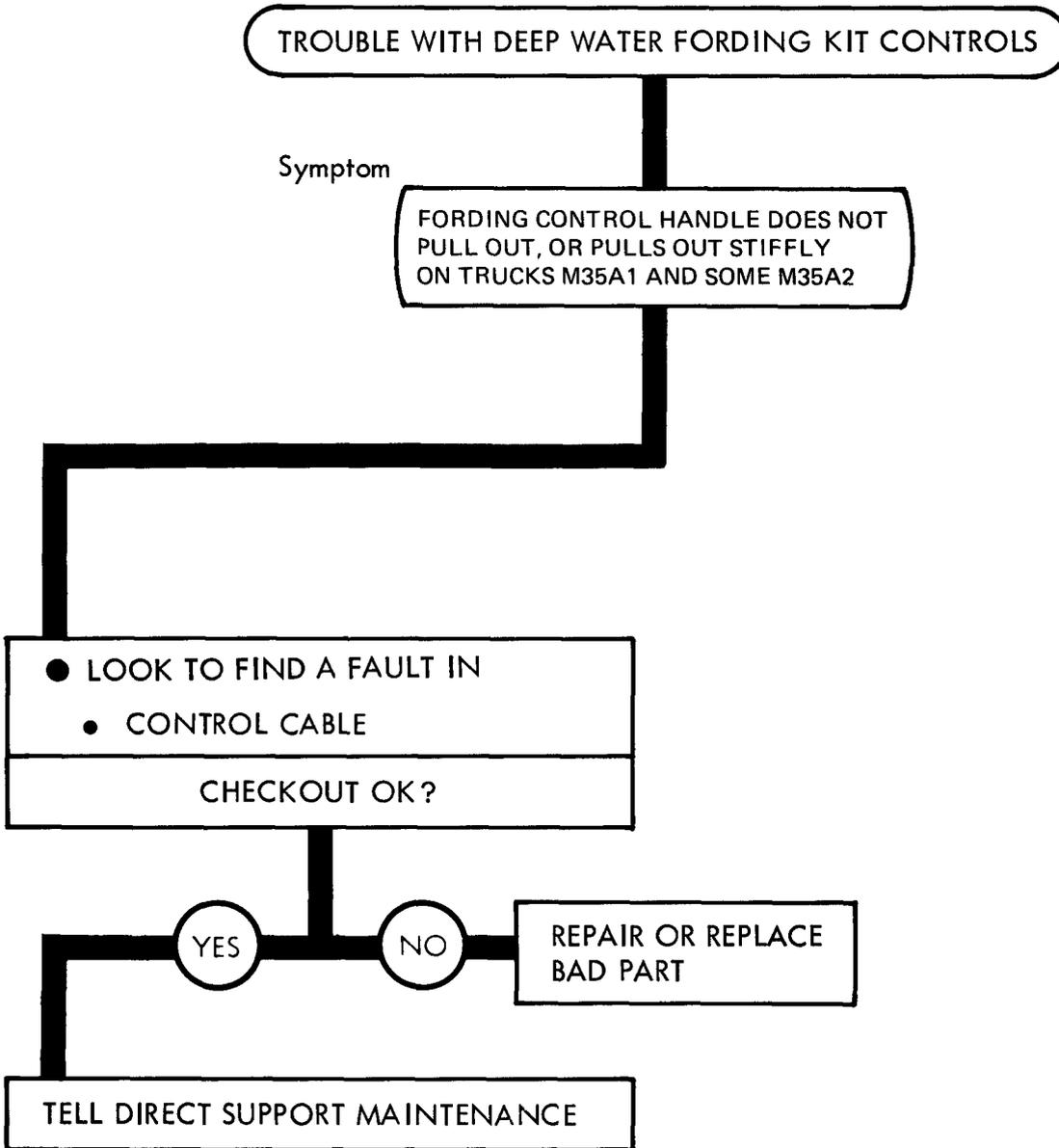

NOTE: FOR DETAILED TROUBLESHOOTING PROCEDURES, SEE SYMPTOM INDEX

Figure 95-2

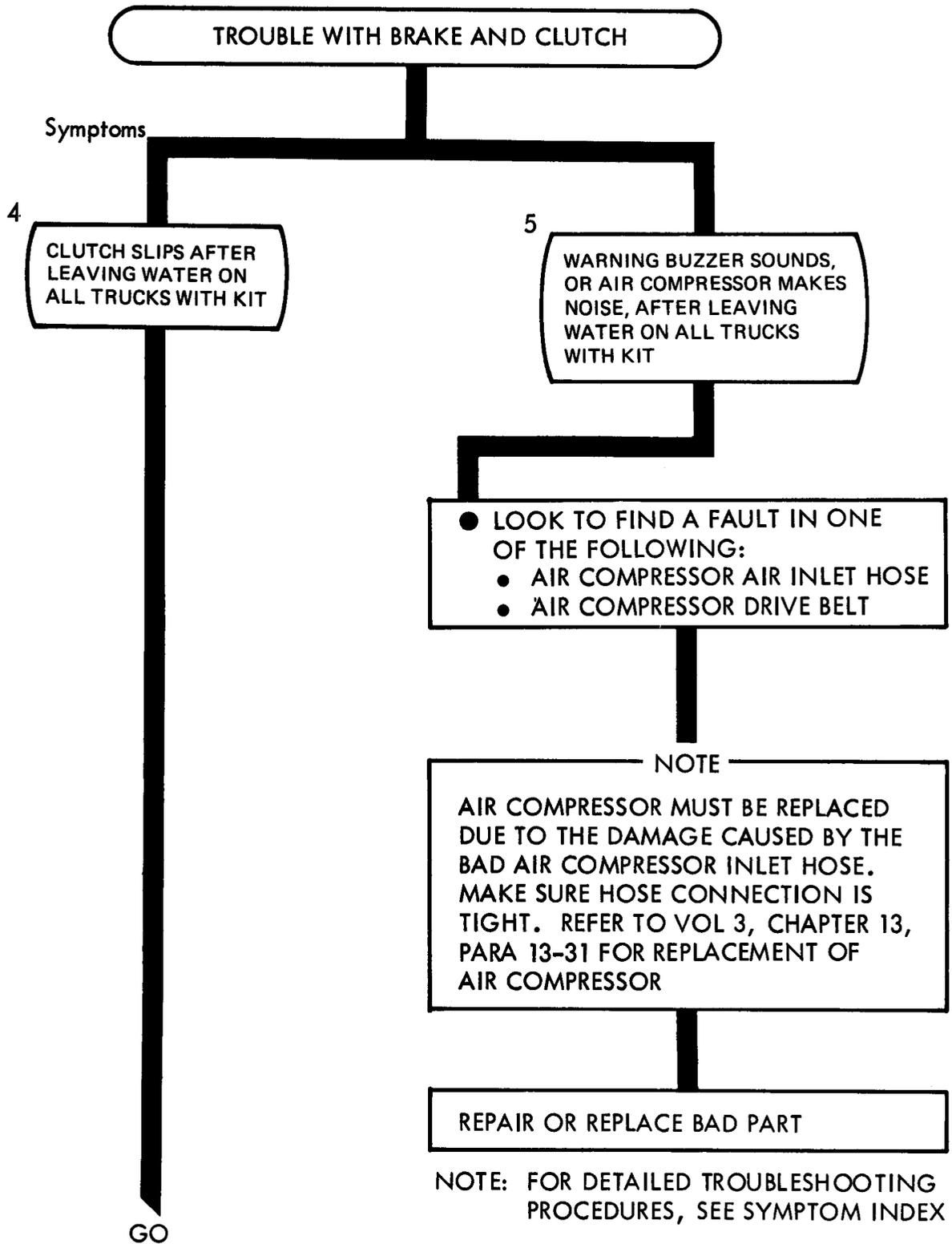

TA 115174

Figure 95-3 (Sheet 1 of 2)

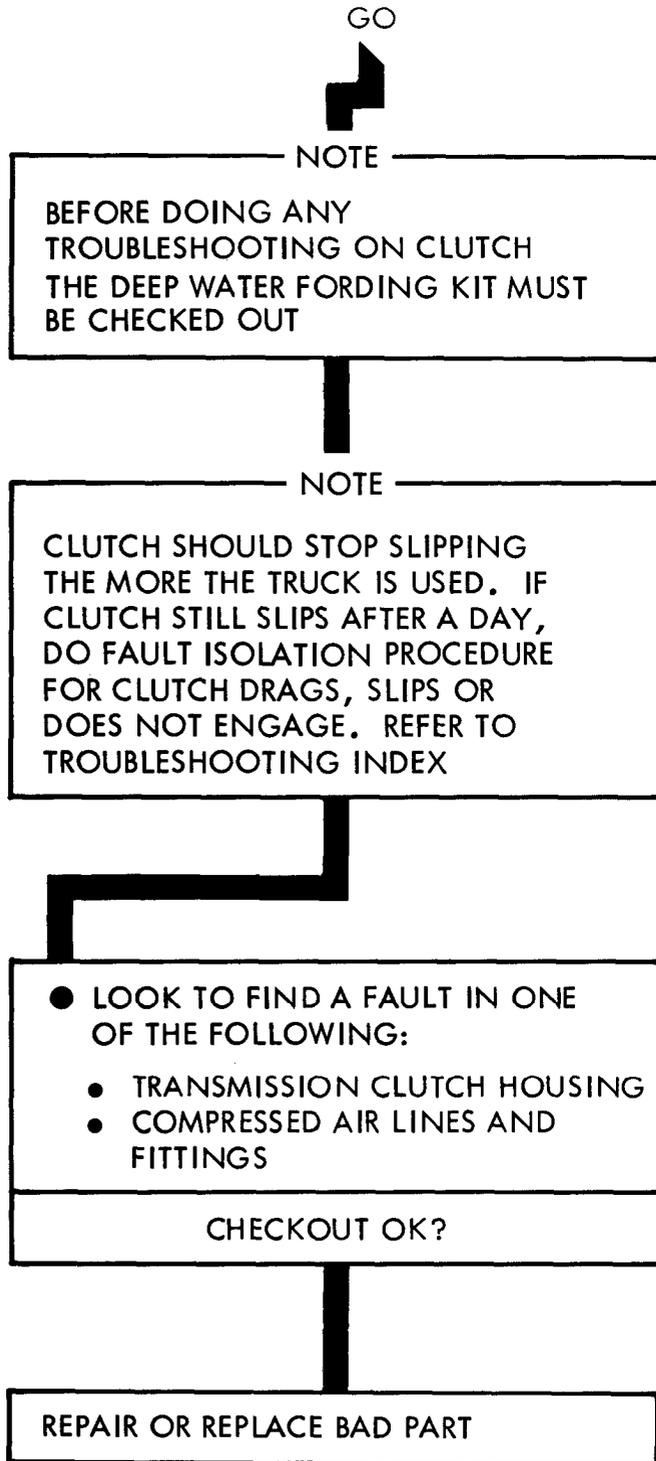

NOTE: FOR DETAILED TROUBLESHOOTING PROCEDURES, SEE SYMPTOM INDEX

CHAPTER 96

DEEP WATER FORDING KIT SUPPORT DIAGRAMS

96-1. GENERAL. This chapter gives the diagrams you need when doing troubleshooting procedures in chapter 94. Table 3-1 is a complete listing of all support diagrams used in this manual.

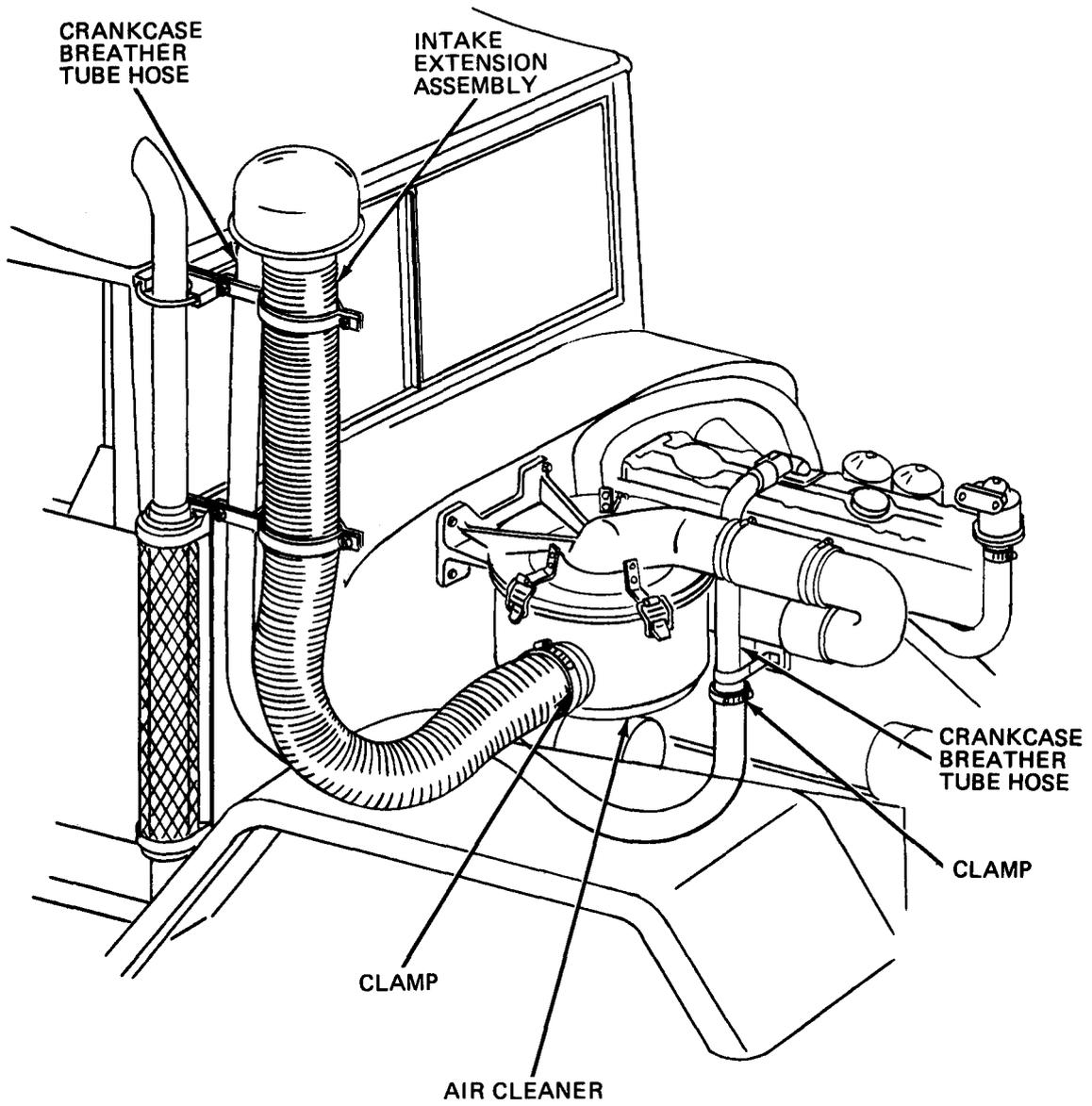

TA 115176

Figure 96-1. Deep Water Fording Kit Support Diagram

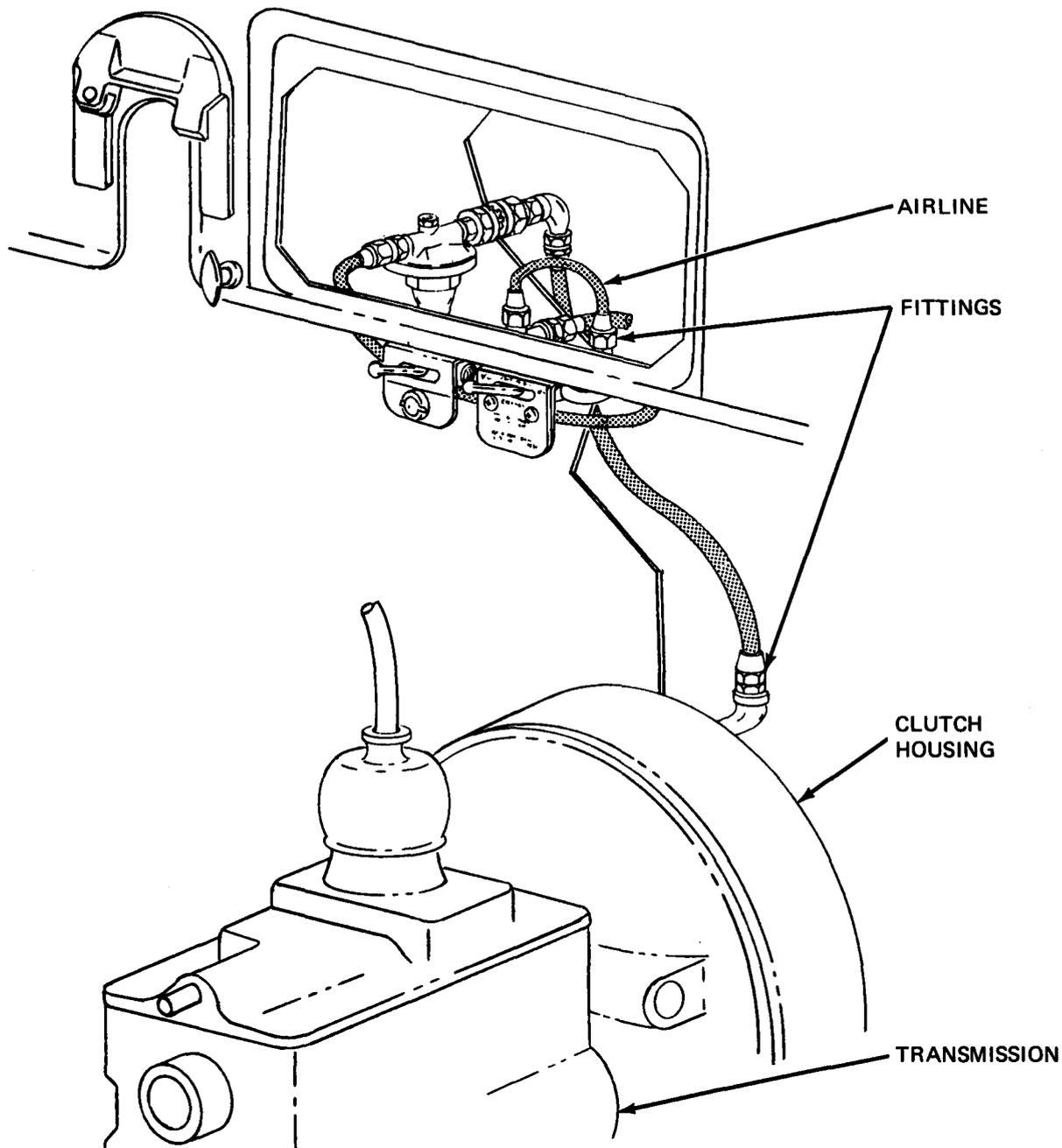

ON ALL TRUCKS EXCEPT M35A1 AND SOME M35A2

TA 115177

Figure 96-2. Deep Water Fording Kit Support Diagram

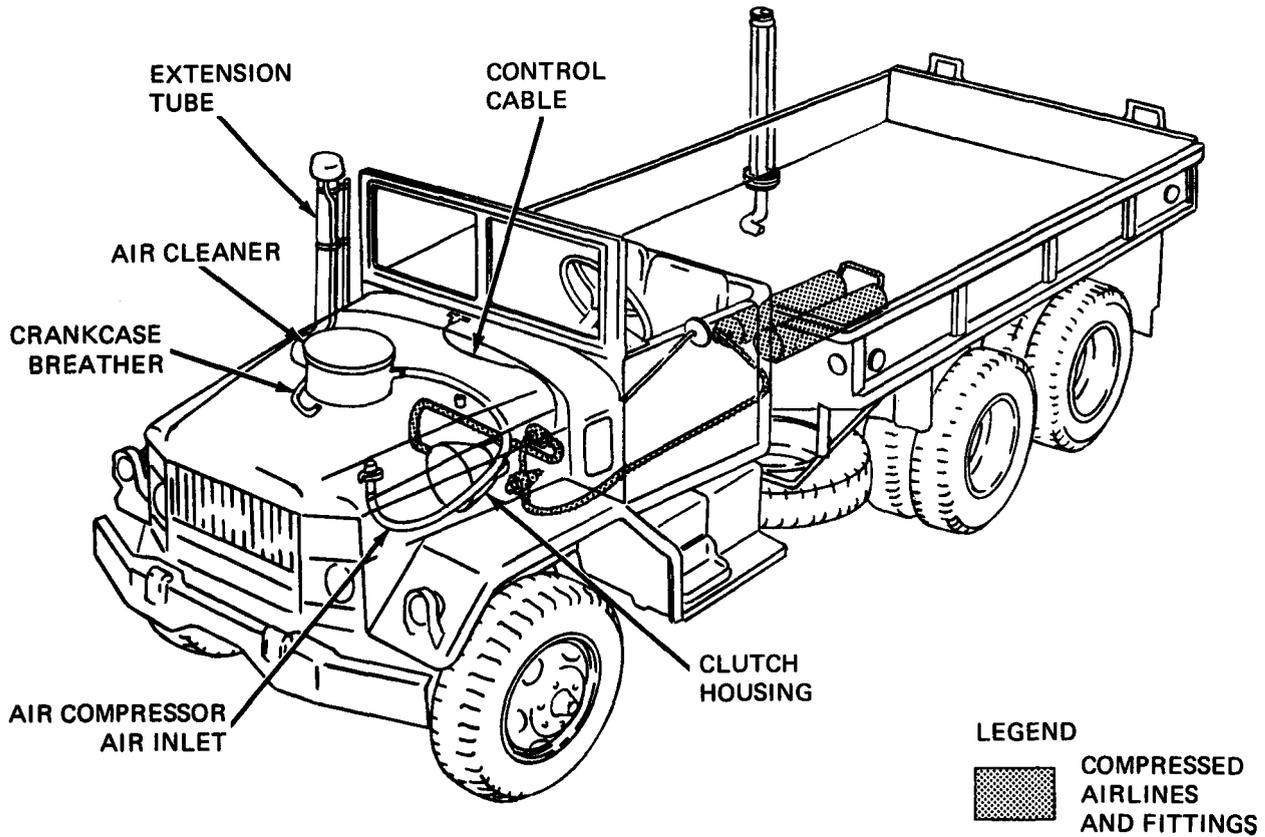

ON TRUCKS M35A1 AND SOME M35A2

TA 115178

Figure 96-3. Deep Water Fording Kit Support Diagram

CHAPTER 97

DEEP WATER FORDING KIT CHECKOUT PROCEDURES

97-1. GENERAL. This chapter gives procedures for checking out the system after troubleshooting and repair have been done. Procedures are set up in flow chart form showing the checkout steps in order and referring to the fault symptom index when the system does not check out.

DEEP WATER FORDING KIT CHECKOUT

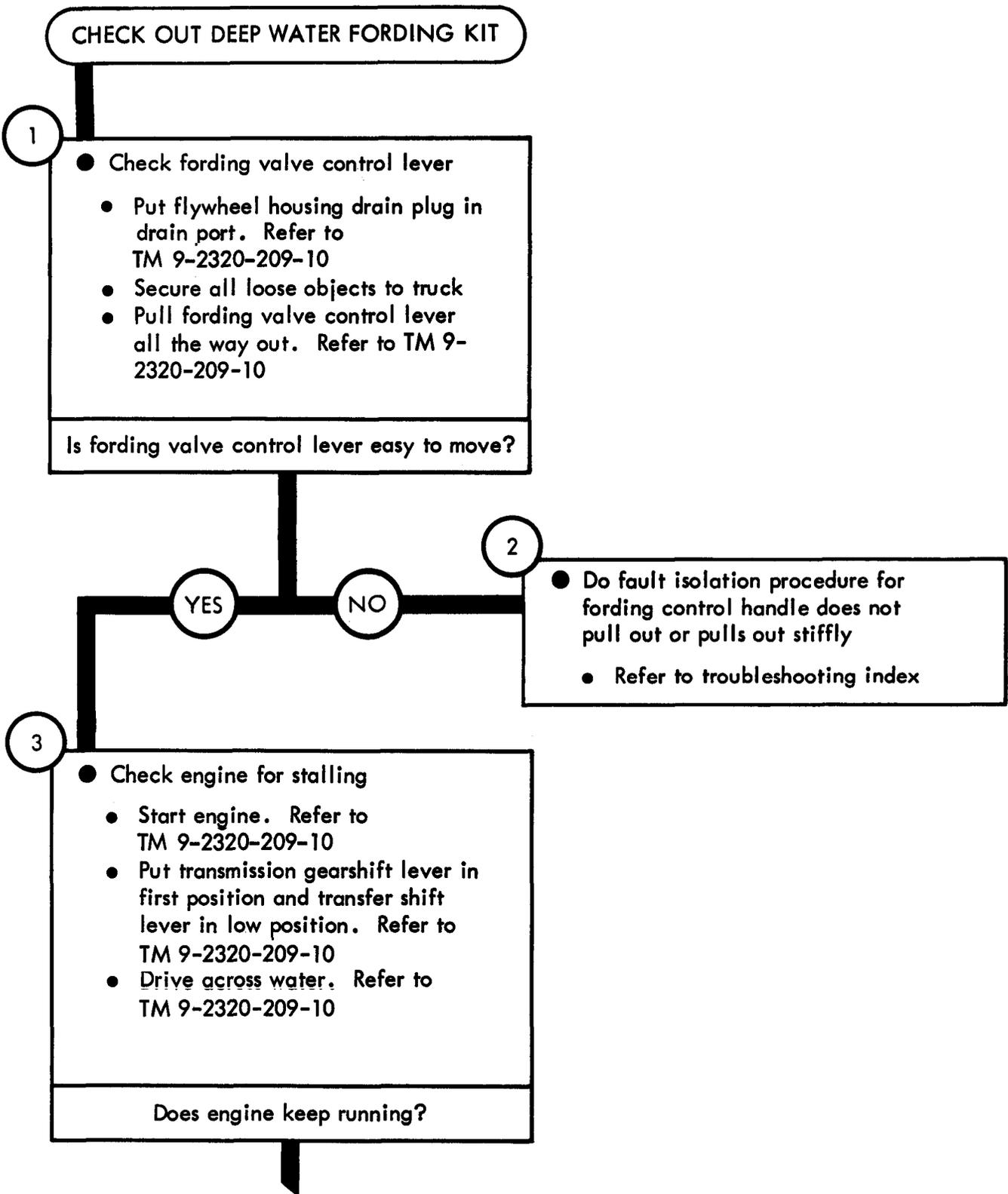

Figure 97-1 (Sheet 1 of 3)

TA 115179

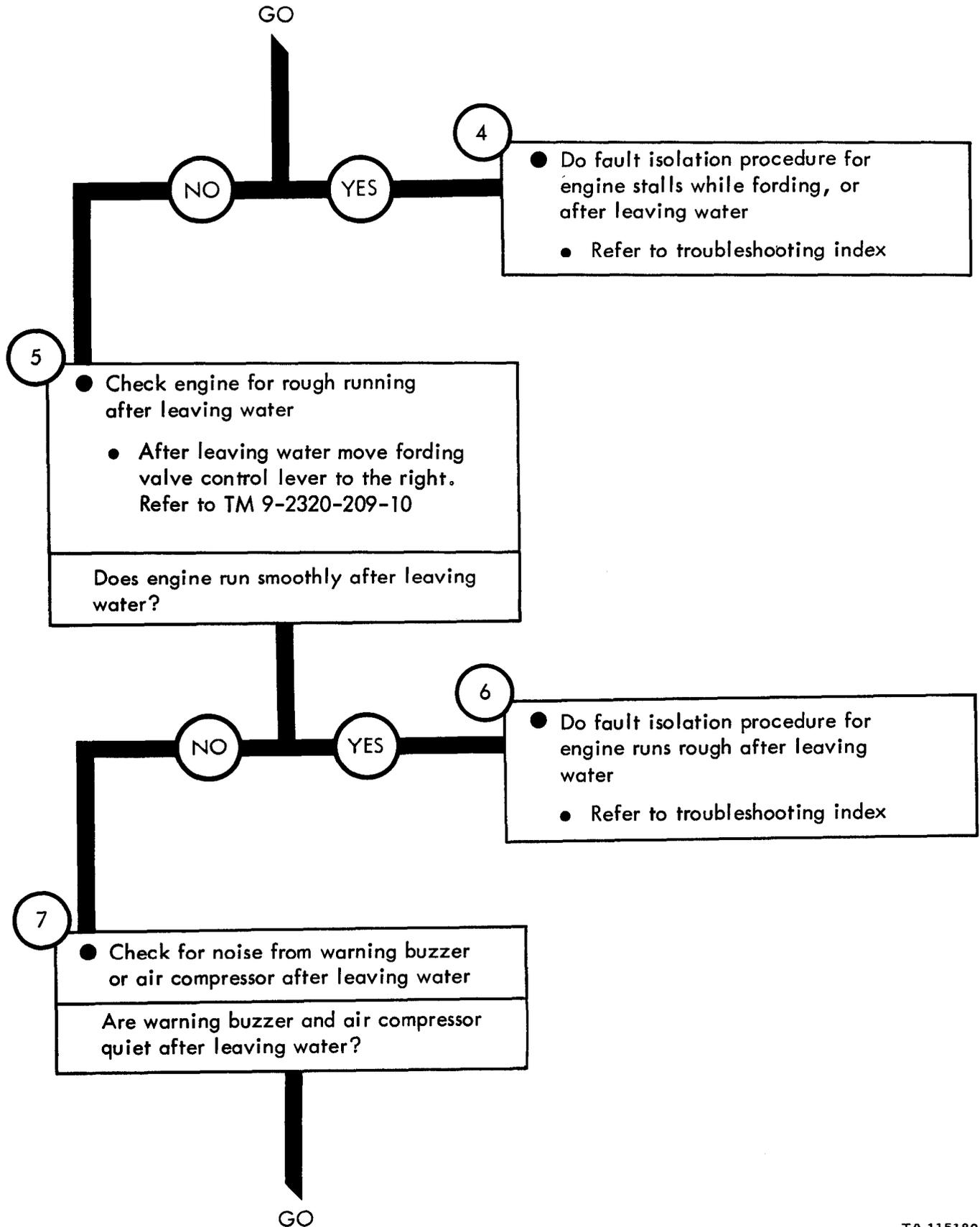

Figure 97-1 (Sheet 2 of 3)

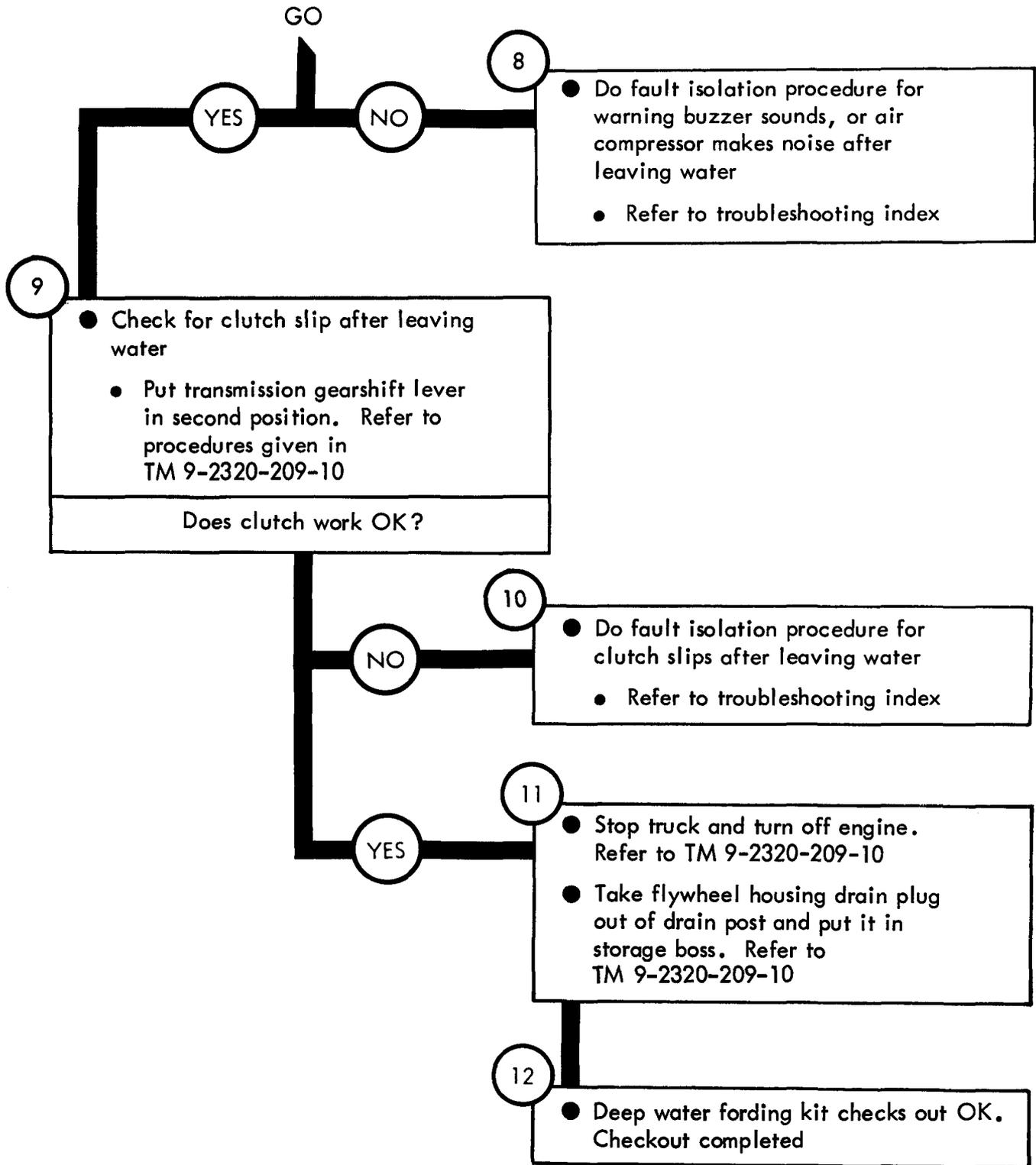

Figure 97-1 (Sheet 3 of 3)

TA 115181

CHAPTER 98

NON-ELECTRICAL GAGES TROUBLESHOOTING

98-1. EQUIPMENT ITEMS COVERED. This chapter gives equipment troubleshooting procedures for the non-electrical gages, for which there are authorized corrective maintenance tasks at the organizational maintenance level.

98-2. EQUIPMENT ITEMS NOT COVERED. All equipment items for which corrective maintenance is authorized at the organizational maintenance level are covered in this chapter.

Symptom

1 SPEEDOMETER DOES NOT WORK

- 1
- Make truck ready for work on speedometer
 - Park truck. Refer to TM 9-2320-209-10

- 2
- Check gage end of speedometer cable
 - See if cable has come out of gage. See figure 100-1
 - Check transfer end of speedometer cable
 - See if cable has come out of drive adapter assembly. See figure 100-1
- Are both ends OK?

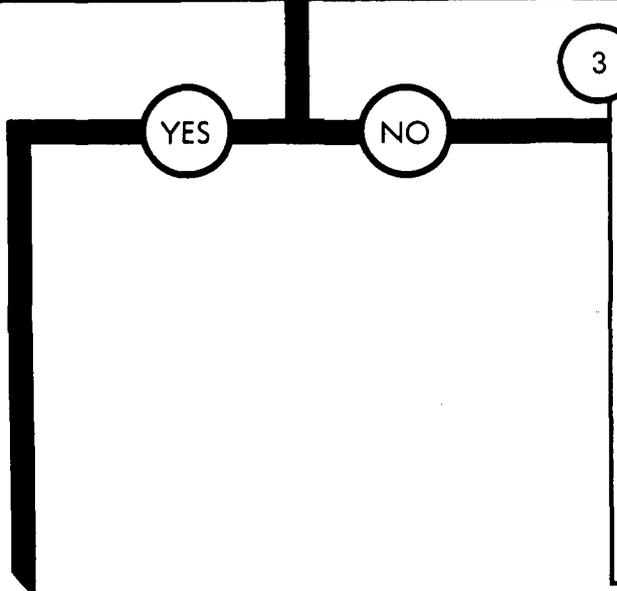

- 3
- Put speedometer cable back on gage
 - Put core in gage opening
 - Screw on cable and tighten
 - Using 3/4-inch wrench tighten cable bolt
 - Put speedometer cable back in drive adapter
 - Line up key on cable core with keyway in drive adapter
 - Push cable core into drive adapter
 - Screw in cable fitting and tighten using 3/4-inch wrench

GO

TA 115182

Figure 98-1 (Sheet 1 of 5)

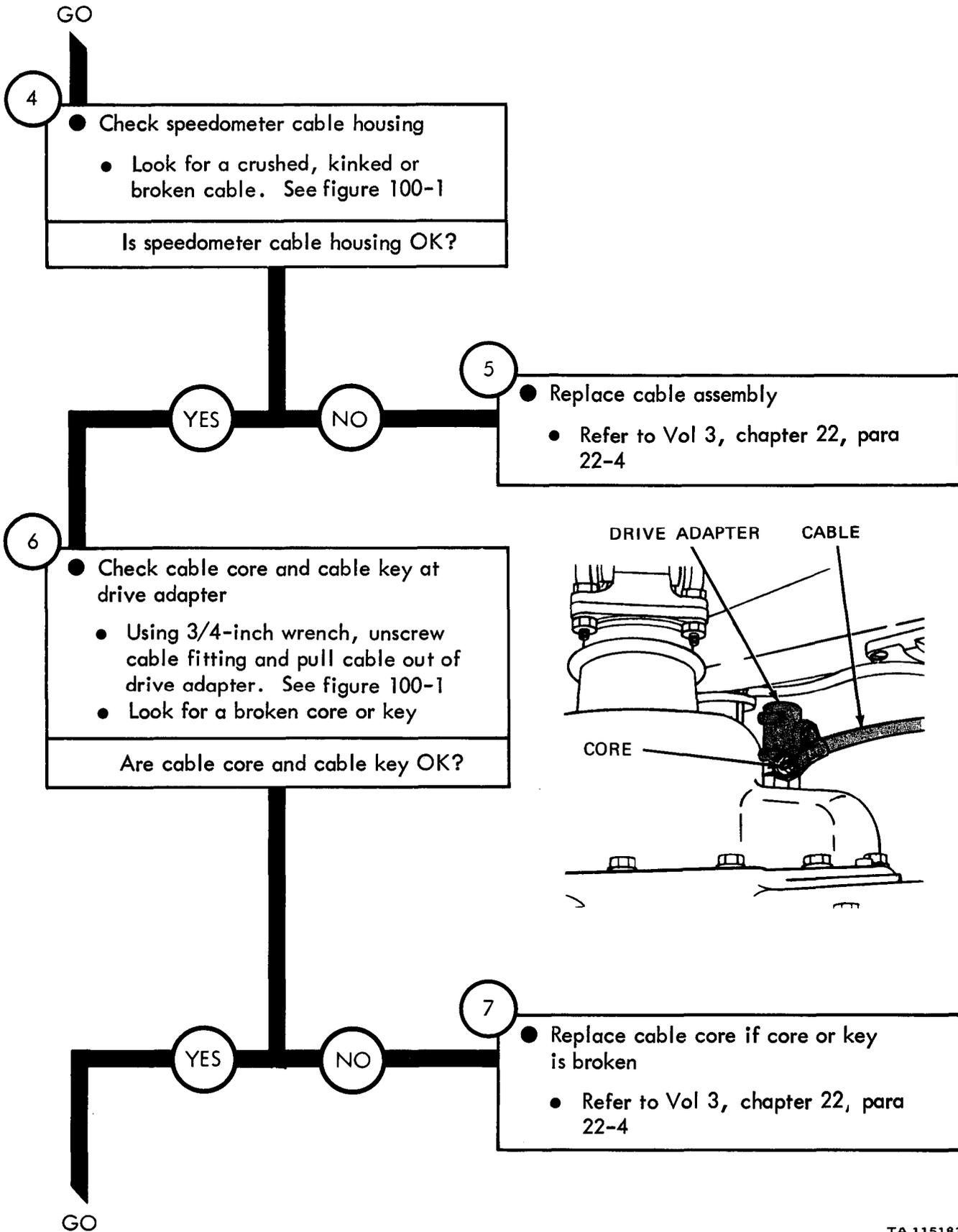

Figure 98-1 (Sheet 2 of 5)

TA 115183

GO

8

- Check cable core at speedometer assembly
 - Using 3/4-inch wrench, unscrew and pull out cable core from gage
 - Look for a broken core

Is cable core OK?

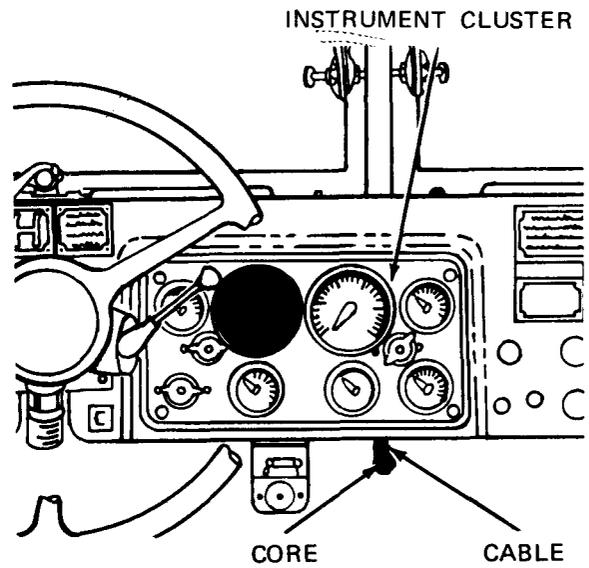

9

- Replace cable core if it is broken
 - Refer to Vol 3, chapter 22, para 22-4

YES

NO

NOTE

The next step will need the use of two soldiers. The lead soldier will be called Soldier A and the helper will be called Soldier B

GO

Figure 98-1 (Sheet 3 of 5)

GO

10

● Check speedometer cable as follows

SOLDIER B: ● Crawl under transfer

SOLDIER A: ● Go to driver's seat
● Tell SOLDIER B to turn speedometer core

SOLDIER B: ● Turn speedometer core

SOLDIER A: ● See if speedometer cable core turns

Does speedometer core turn?

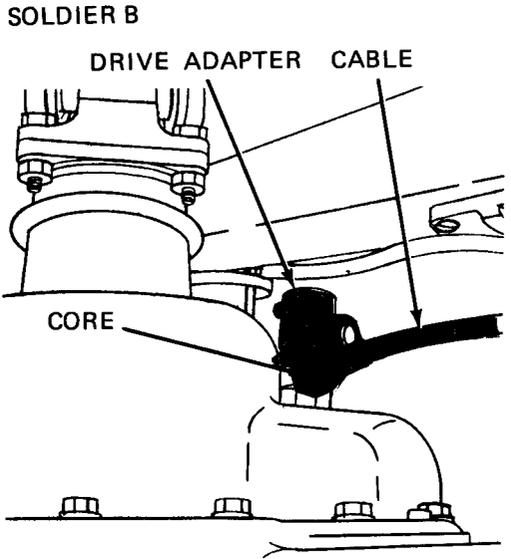
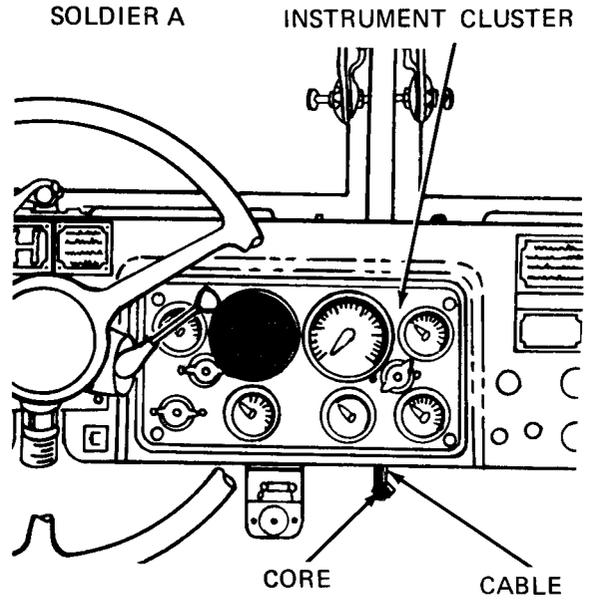

11

● Replace speedometer cable assembly

● Refer to Vol 3, chapter 22, para 22-4

YES

NO

GO

Figure 98-1 (Sheet 4 of 5)

GO

12

- Set up speedometer test
- SOLDIER A:
- Put back core in speedometer gage opening
 - Screw on cable fitting and tighten using 3/4-inch wrench
 - Put a variable speed drill on drive adapter end of cable core

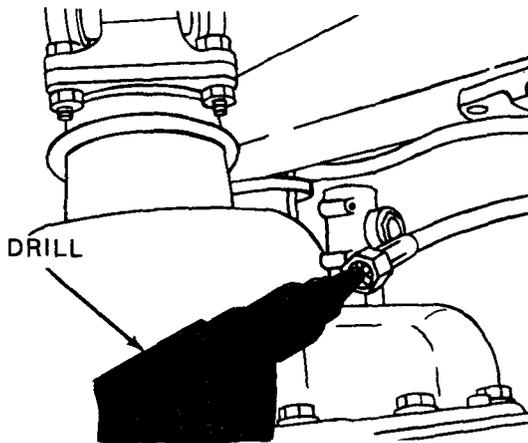

13

- Test speedometer
- SOLDIER B:
- Watch speedometer
- SOLDIER A:
- Run drill at a slow and steady speed for about 30 seconds
- SOLDIER B:
- See if speedometer pointer moves
- Does speedometer pointer move?

NO

14

- Replace speedometer gage assembly
- Refer to Vol 3, chapter 22, para 22-4

YES

15

- Replace speedometer drive adapter
- Refer to Vol 3, chapter 22, para 22-4

Figure 98-1 (Sheet 5 of 5)

Symptom

2 SPEEDOMETER DOES NOT SHOW CORRECT SPEED

1

- Make truck ready for work on speedometer
 - Park truck. Refer to TM 9-2320-209-10

2

- Check speedometer cable
 - Look for a crushed or kinked cable. See figure 100-1

Is speedometer cable OK?

YES NO 3

- Replace crushed or kinked speedometer cable
 - Refer to Vol 3, chapter 22, para 22-4

4

- Replace speedometer drive adapter
 - Refer to Vol 3, chapter 22, para 22-4
 - Road test truck to see if speedometer reads the correct speed
 - Refer to troubleshooting index for speedometer checkout

Is speedometer speed still wrong?

GO

TA 115187

Figure 98-2 (Sheet 1 of 2)

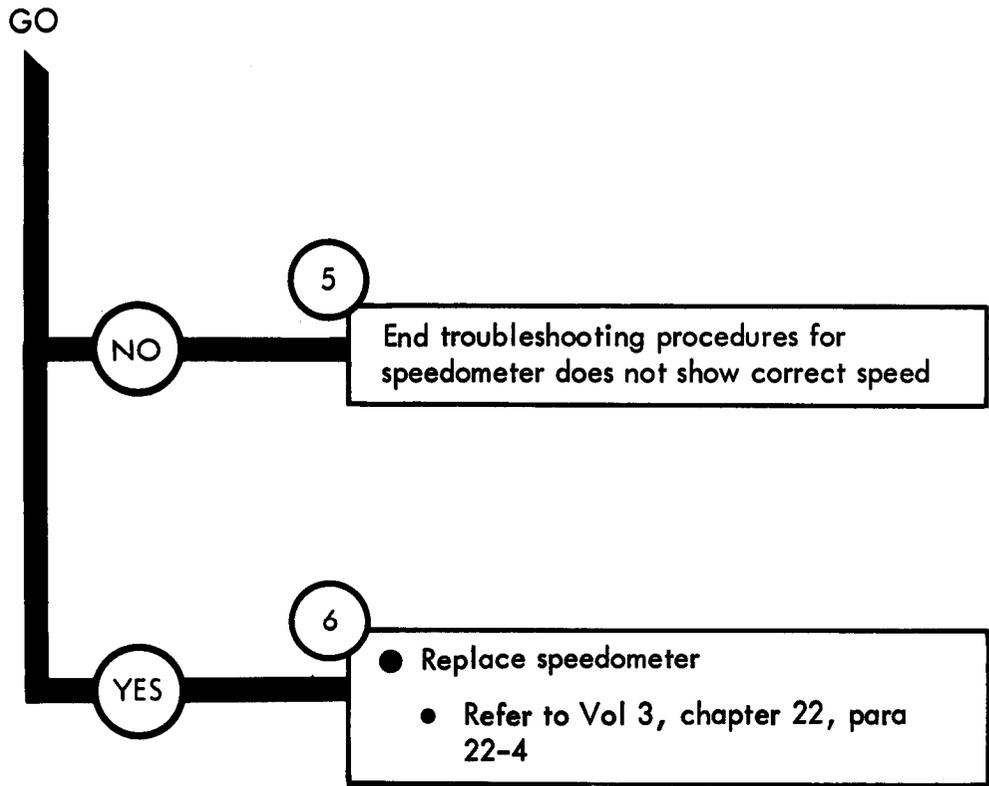
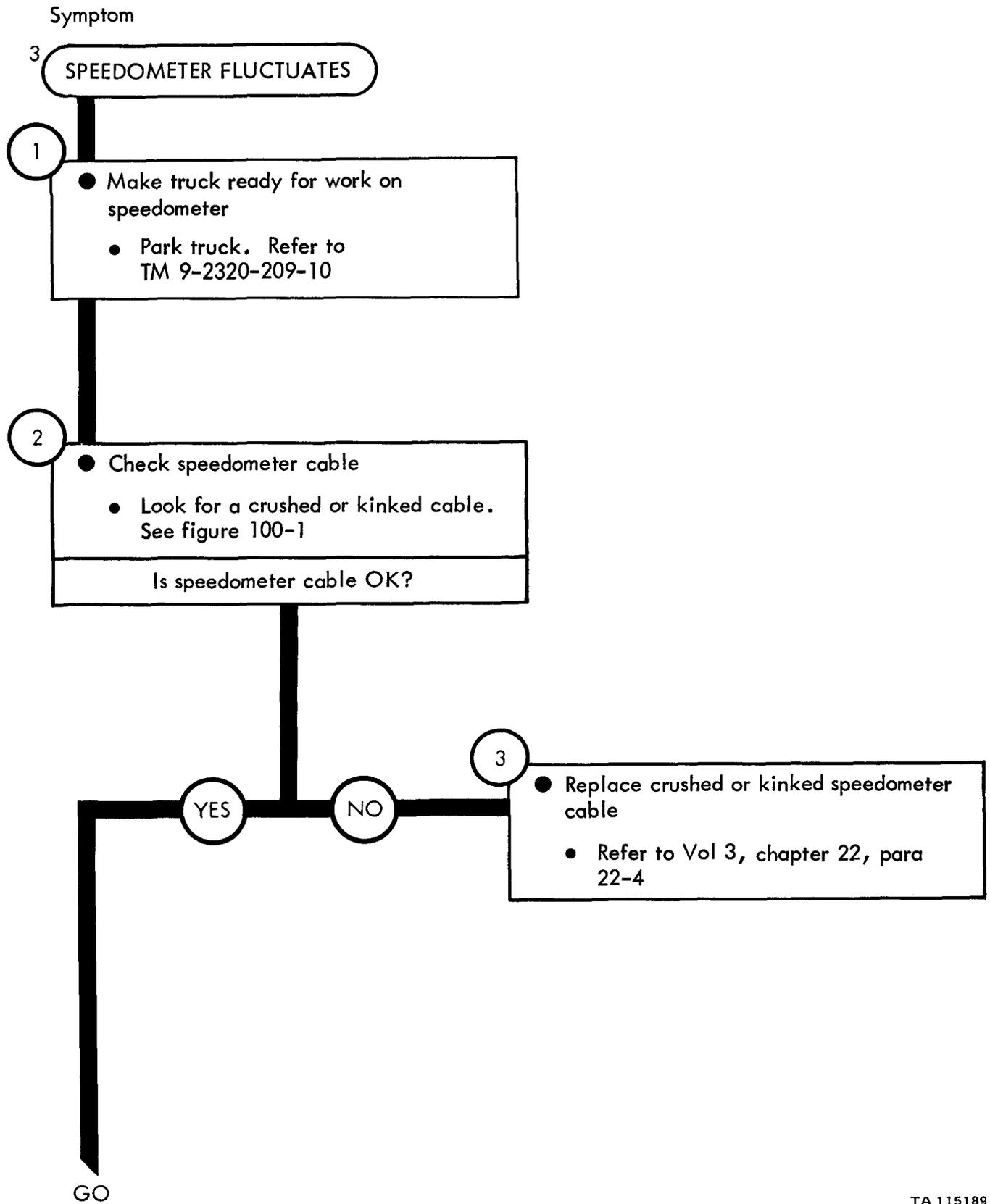

Figure 98-2 (Sheet 2 of 2)

TA 115188



TA 115189

Figure 98-3 (Sheet 1 of 3)

GO

4

- Set up speedometer test
 - Using 3/4-inch wrench, unscrew and takeoff speedometer cable from drive joint assembly. See figure 100-1
 - Put a variable speed drill on cable core end

NOTE

This next step will need the use of two soldiers. The lead soldier will be called Soldier A and the helper will be called Soldier B

5

- Test speedometer
 - SOLDIER B: ● Go to driver's seat and watch speedometer
 - SOLDIER A: ● Run drill at a slow and steady speed for about 30 seconds
 - SOLDIER B: ● See if speedometer pointer moves unevenly

Does speedometer run smoothly?

GO

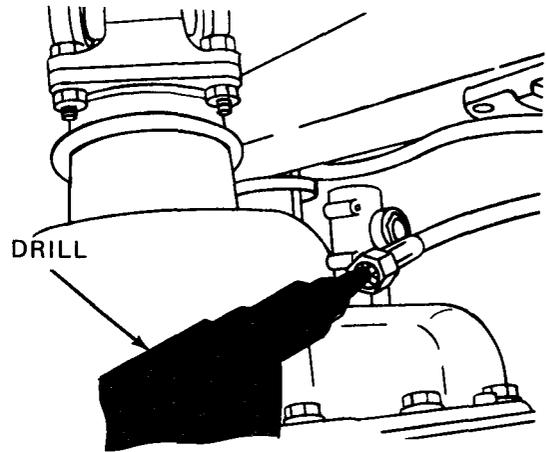
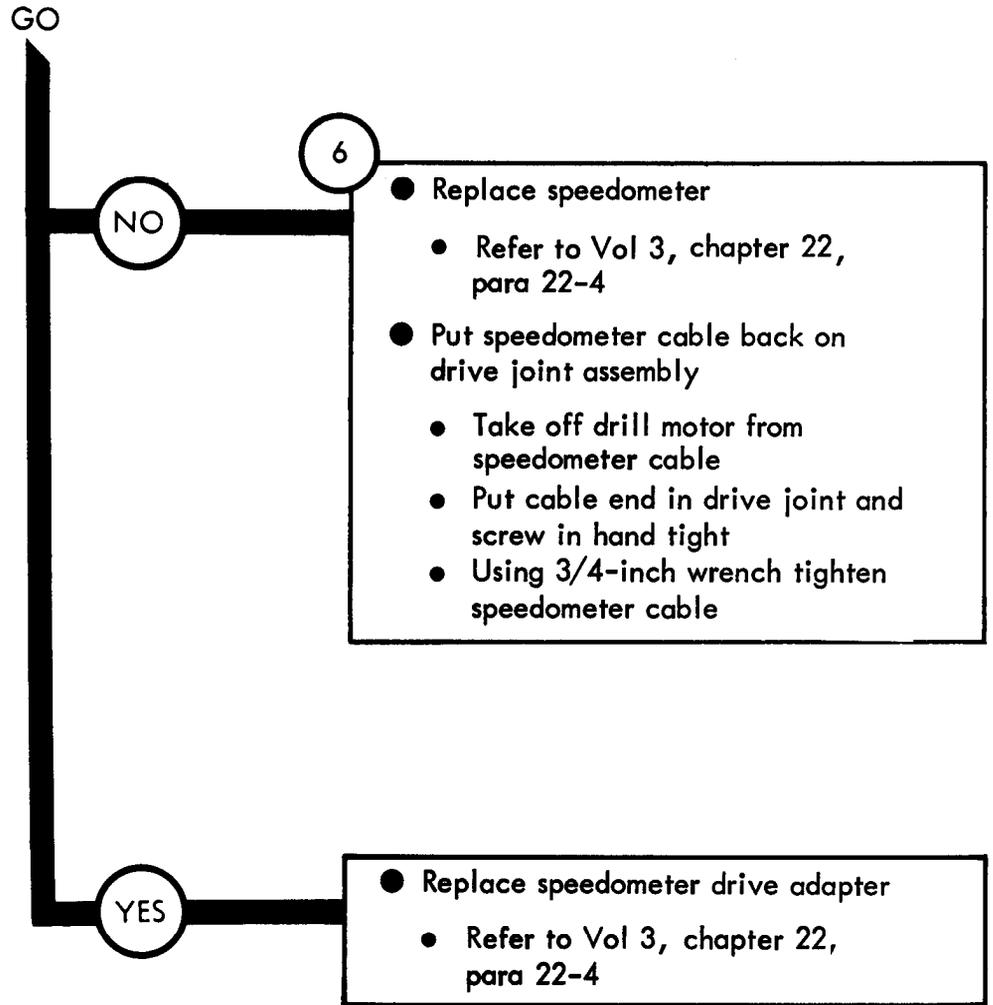

Figure 98-3 (Sheet 2 of 3)

TA 115190



TA 115191

Figure 98-3 (Sheet 3 of 3)

Symptom

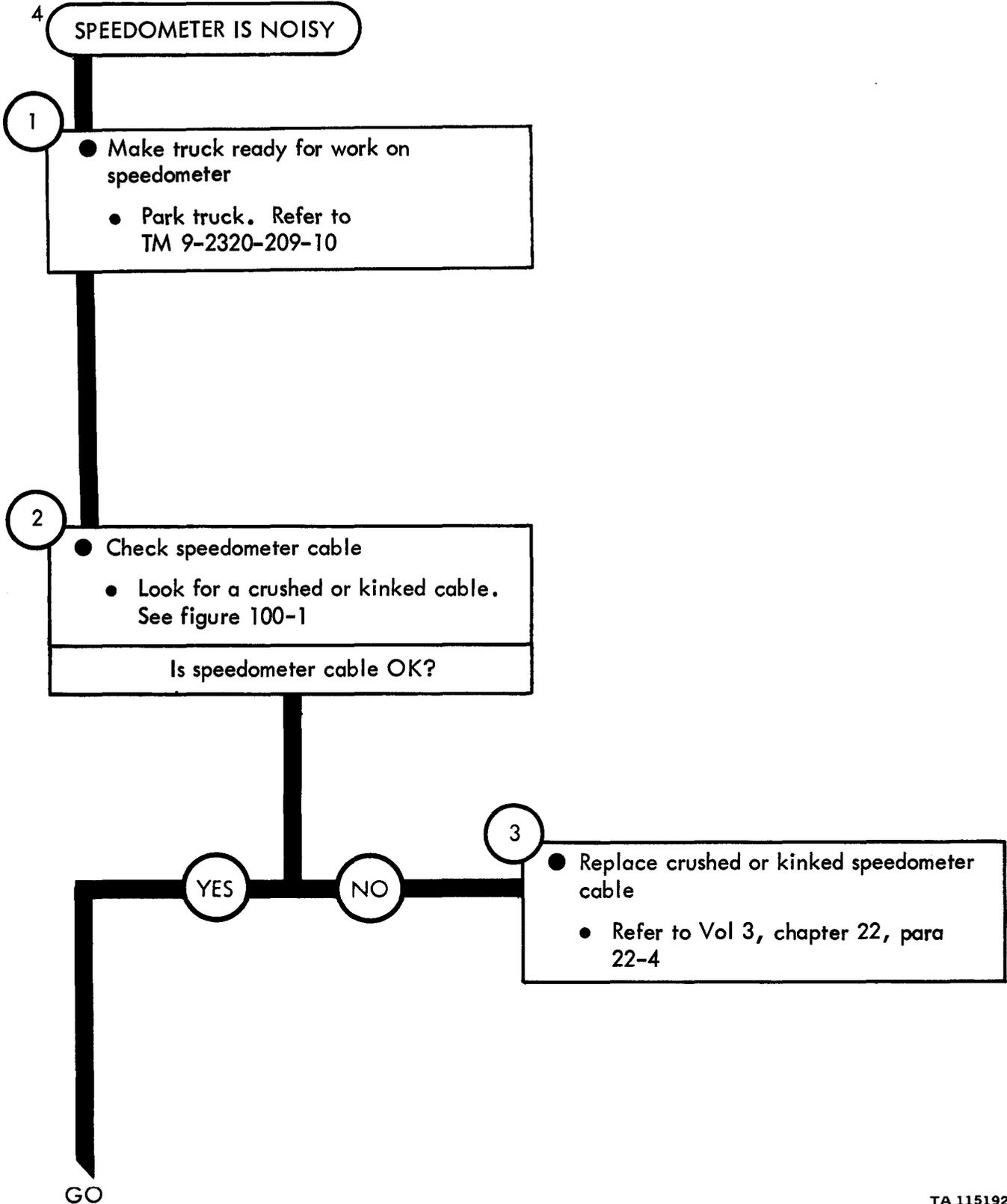

TA 115192

Figure 98-4 (Sheet 1 of 3)

GO

4

- Set up speedometer test
 - Using 3/4-inch wrench, unscrew and take off speedometer cable from drive joint assembly
 - Put a variable speed drill on cable core end

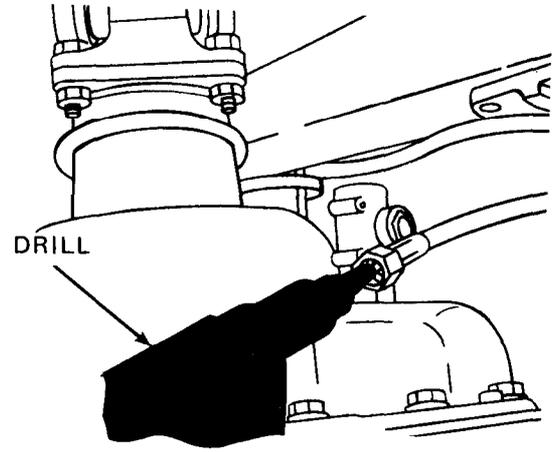

NOTE

This next step will need the use of two soldiers. The lead soldier will be called Soldier A, and the helper will be called Soldier B

5

- Test speedometer
- SOLDIER B: ● Go to driver's seat and listen for noise coming from speedometer when drill is used
- SOLDIER A: ● Run drill at a slow and steady speed for about 30 seconds

Is speedometer quiet?

GO

Figure 98-4 (Sheet 2 of 3)

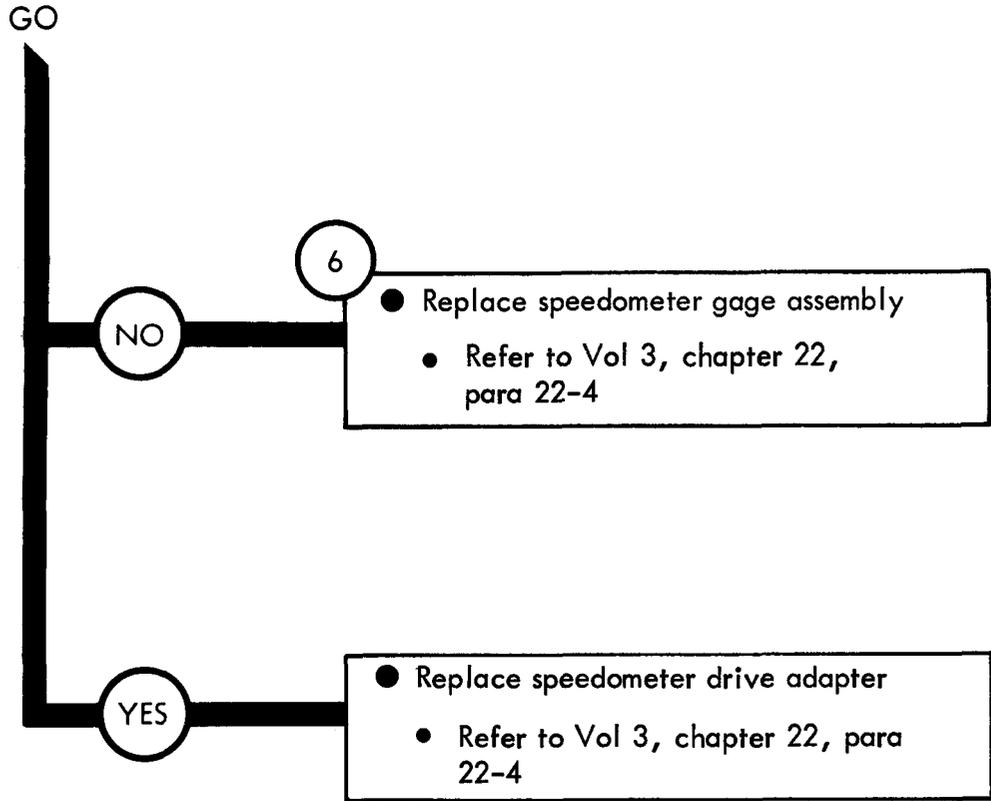

Figure 98-4 (Sheet 3 of 3)

Symptom

5

TACHOMETER DOES NOT WORK

1

- Park truck
- Refer to TM 9-2320-209-10

2

- Check gage end of tachometer cable
 - See if cable has come out of tachometer. See figure 100-1
- Check drive adapter end of tachometer cable
 - See if cable has come out of drive adapter. See figure 100-1

Are both ends of cable OK?

YES

NO

3

- Put tachometer cable back on gage
 - Put cable core in tachometer cable opening
 - Screw cable fitting on gage adapter and tighten
- Put tachometer cable back in drive adapter
 - Line up key on cable core with keyway in drive adapter
 - Push cable core down into drive adapter
 - Screw on cable fitting and tighten using 3/4-inch wrench

GO

TA 115195

Figure 98-5 (Sheet 1 of 3)

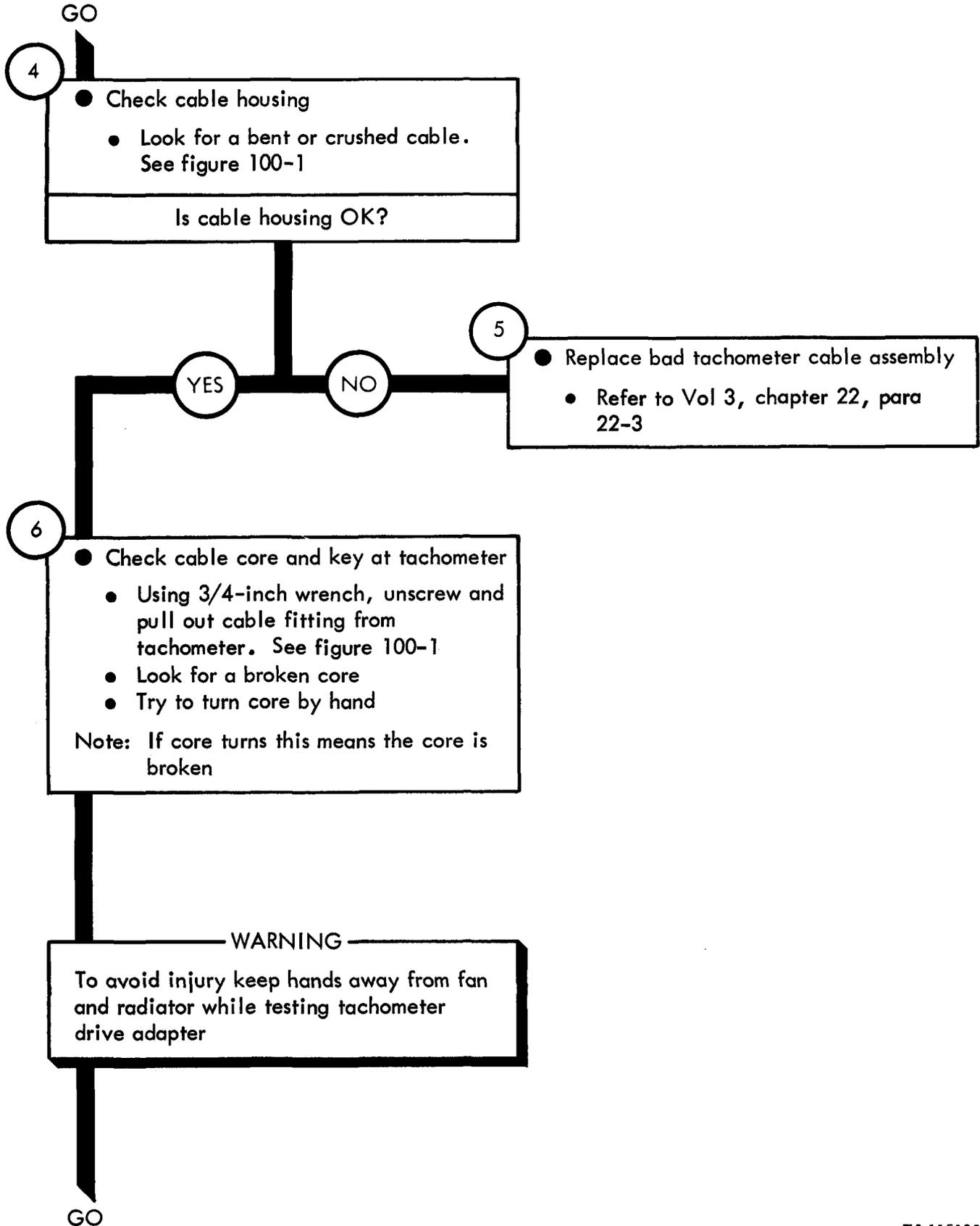
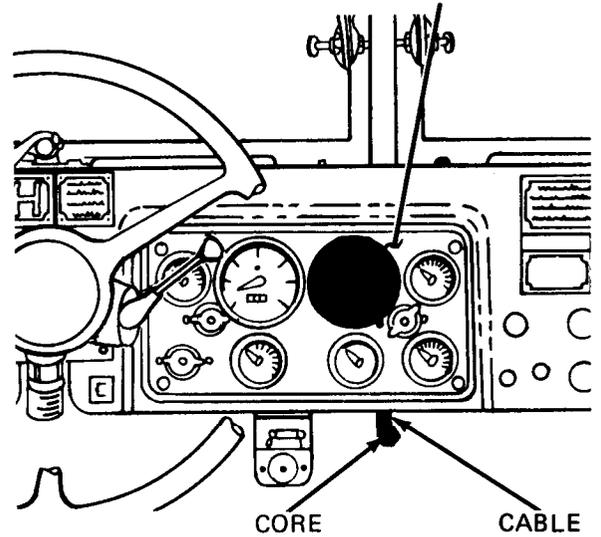

Figure 98-5 (Sheet 2 of 3)

INSTRUMENT CLUSTER



7

- Test tachometer drive adapter
 - Start engine. Refer to TM 9-2320-209-10
 - Look at cable core
 - See if core is turning
 - Turn off engine. Refer to TM 9-2320-209-10

Is tachometer cable core and drive adapter OK?

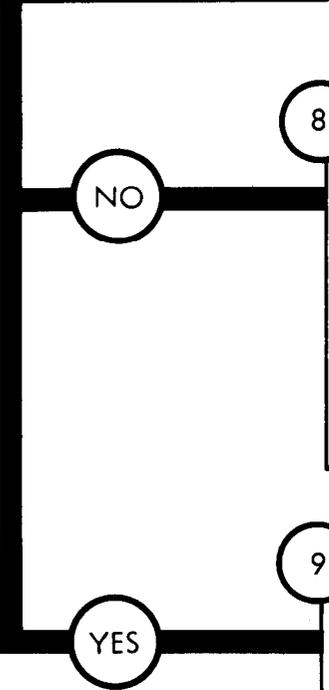

8

- Replace broken cable core
 - Refer to Vol 3, chapter 22, para 22-3
- Replace tachometer drive adapter if drive shaft does not turn
 - Refer to Vol 3, chapter 23, para 22-3

9

- Put tachometer cable back in tachometer
 - Line up key on cable core with keyway in tachometer
 - Push cable core down into tachometer
 - Screw on cable fitting and tighten using 3/4-inch wrench

10

- Replace tachometer gage
 - Refer to Vol 3, chapter 22, para 22-3

Figure 98-5 (Sheet 3 of 3)

Symptom

6 TACHOMETER FLUCTUATES

1

- Park truck
- Refer to TM 9-2320-209-10

2

- Check tachometer cable
- Look for sharp bends, or a crushed cable. See figure 100-1

Is tachometer cable OK?

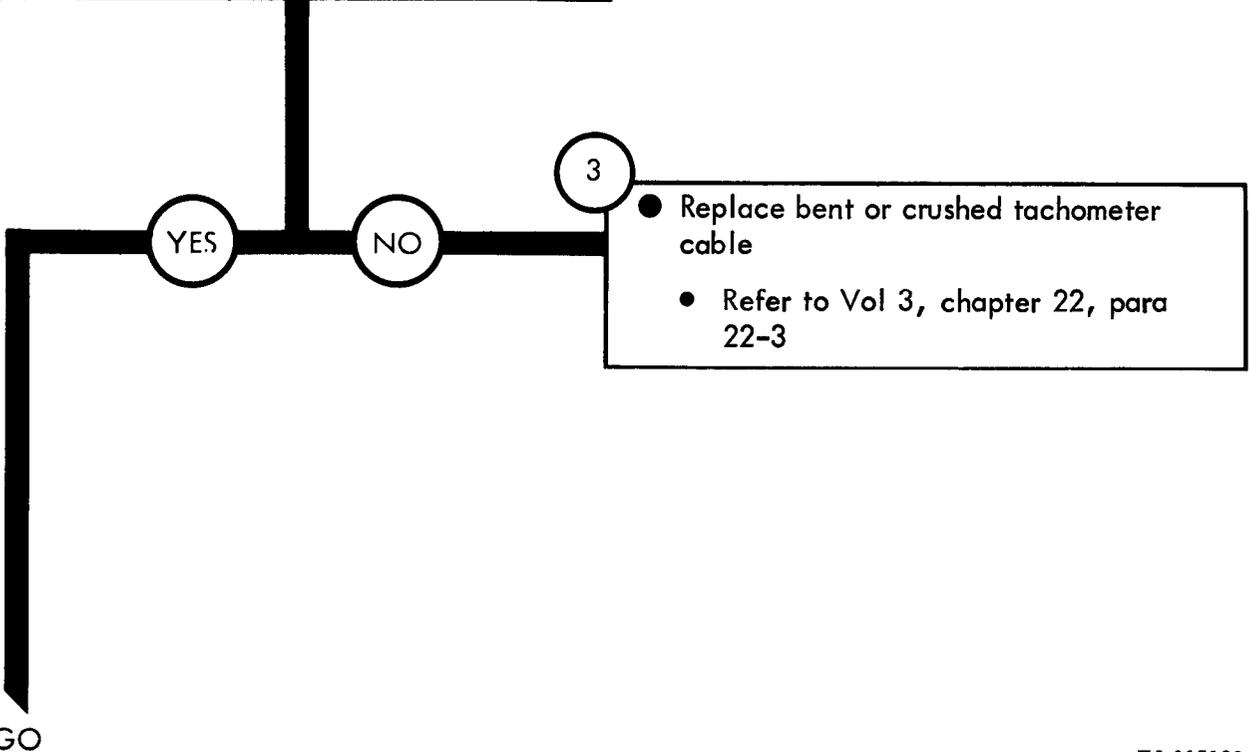

Figure 98-6 (Sheet 1 of 2)

GO

4

- Check tachometer drive adapter
 - Unscrew and pull out cable from tachometer. See figure 100-1
 - Let cable end hang down so that it is just below the instrument cluster
 - Start engine. Refer to TM 9-2320-209-10
 - Run engine at a steady speed and see if cable core turns at a steady speed
 - Turn off engine. Refer to TM 9-2320-209-10

Does cable turn at a steady speed?

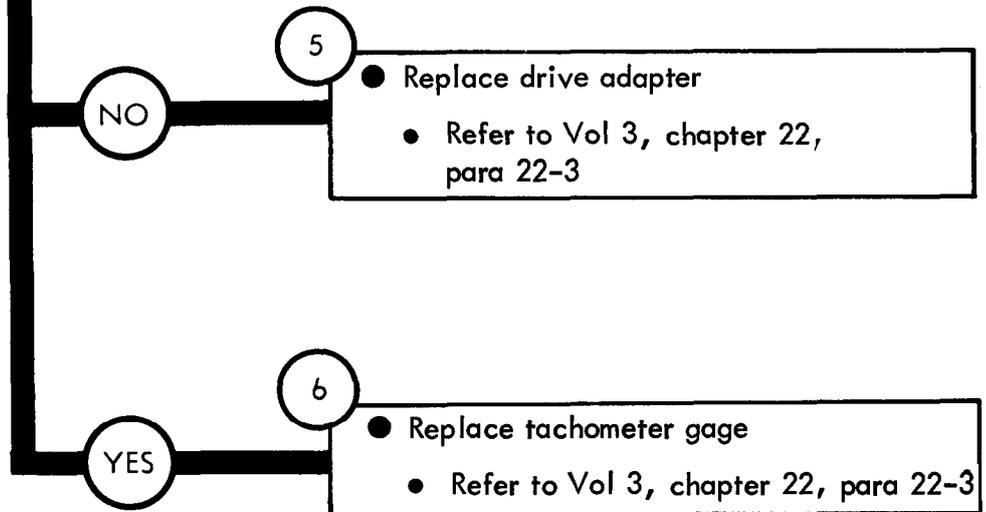
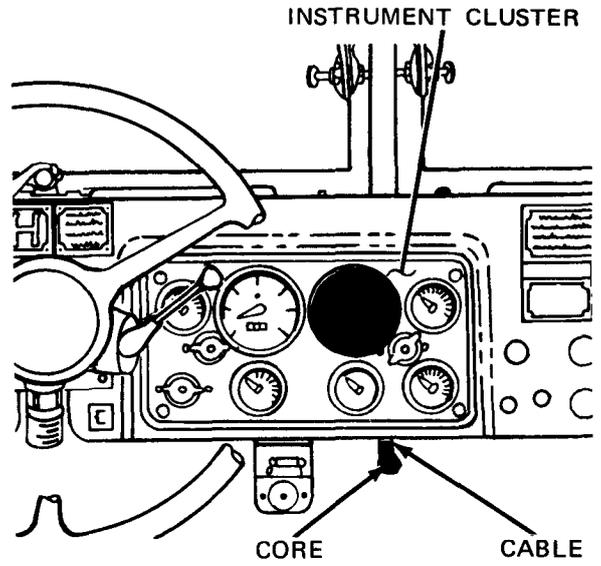

Figure 98-6 (Sheet 2 of 2)

Symptom

7 TACHOMETER DOES NOT SHOW CORRECT READING

1

- Park truck
- Refer to TM 9-2320-209-10

2

- Check tachometer cable
- Look for sharp bends or a crushed cable. See figure 100-1

Is tachometer cable OK?

YES

NO

3

- Replace bent or crushed tachometer cable
- Refer to Vol 3, chapter 22, para 22-3

GO

Figure 98-7 (Sheet 1 of 3)

GO

4

- Check tachometer
 - Start engine and place vehicle in motion. Refer to TM 9-2320-209-10
 - Run truck at 30 miles per hour and make a note of tachometer gage reading
 - Park truck. Refer to TM 9-2320-209-10
 - Unscrew and pull out cable fitting from tachometer. See figure 100-1
 - Screw cable fitting into another tachometer that is known to be good

NOTE

The next step will need the use of two soldiers. The lead soldier will be known as SOLDIER A and the helper will be called SOLDIER B

- SOLDIER B:
- Sit in companion seat and hold tachometer being used for test
- SOLDIER A:
- Start engine and place vehicle in motion. Refer to TM 9-2320-209-10
 - Run truck at 30 miles per hour and make note of the reading on the tachometer being used for test
 - Park truck. Refer to TM 9-2320-209-10
 - Unscrew and pull out cable fitting from tachometer

Are both tachometer readings the same?

GO

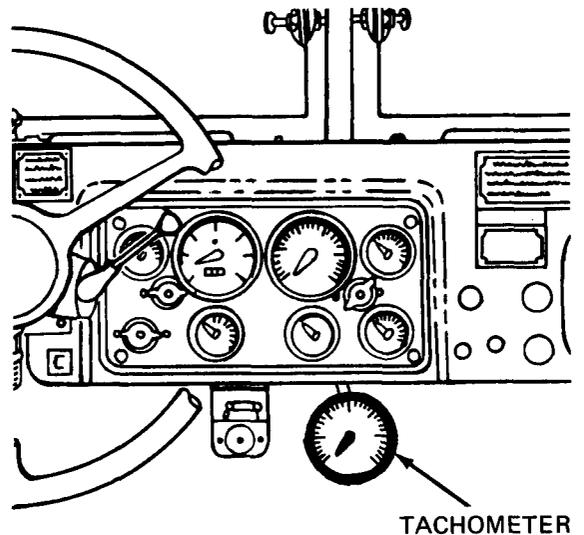

TA 115201

Figure 98-7 (Sheet 2 of 3)

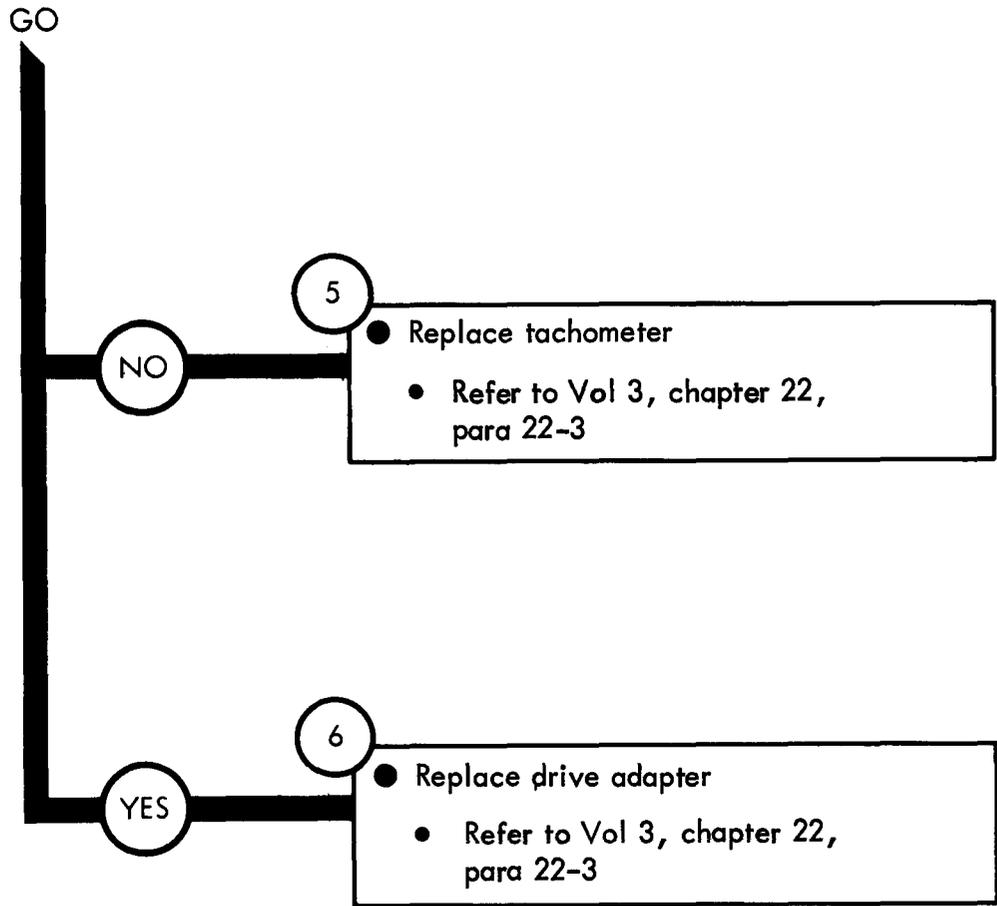
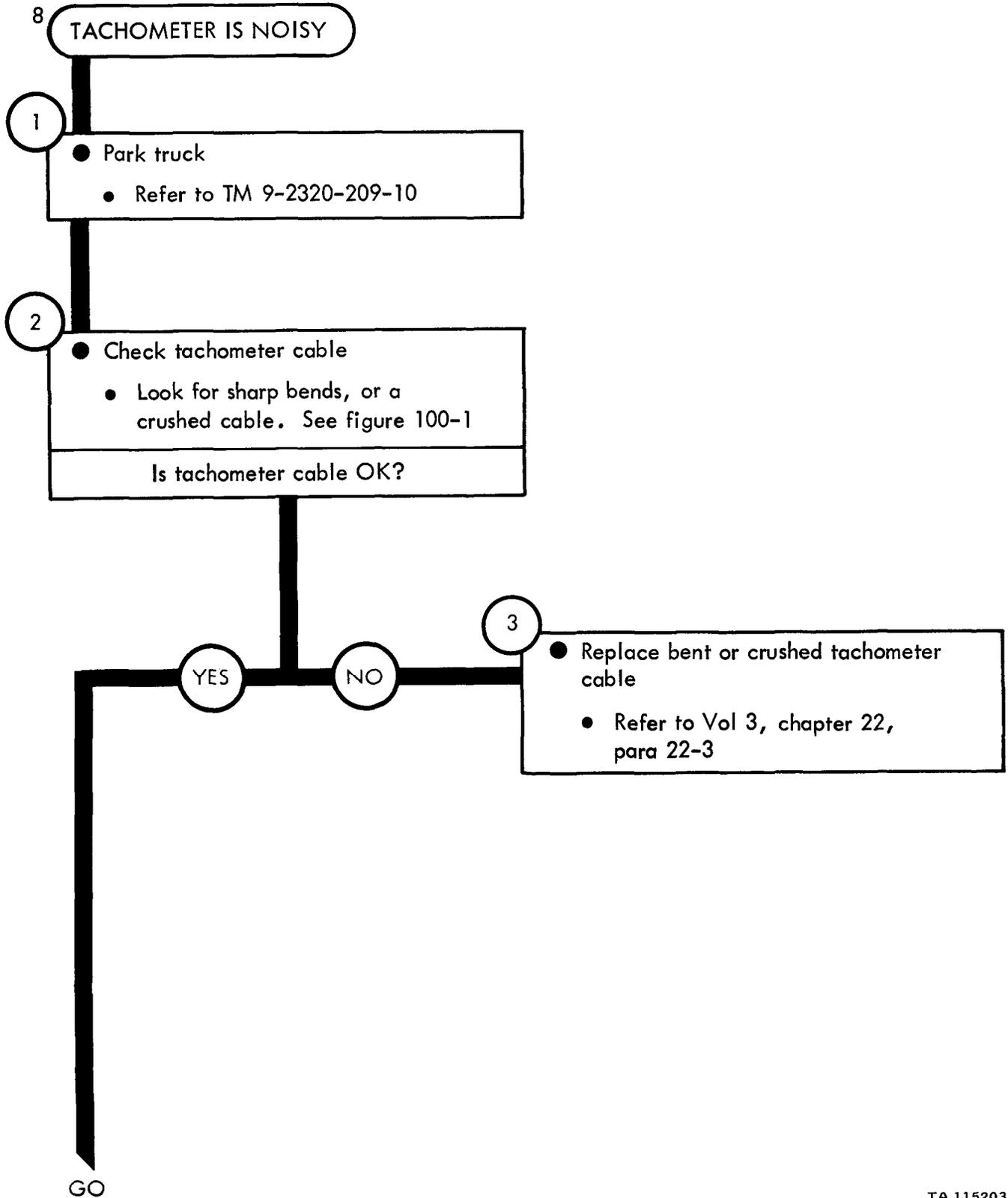

Figure 98-7 (Sheet 3 of 3)

TA 115202

Symptom



TA 115203

Figure 98-8 (Sheet 1 of 2)

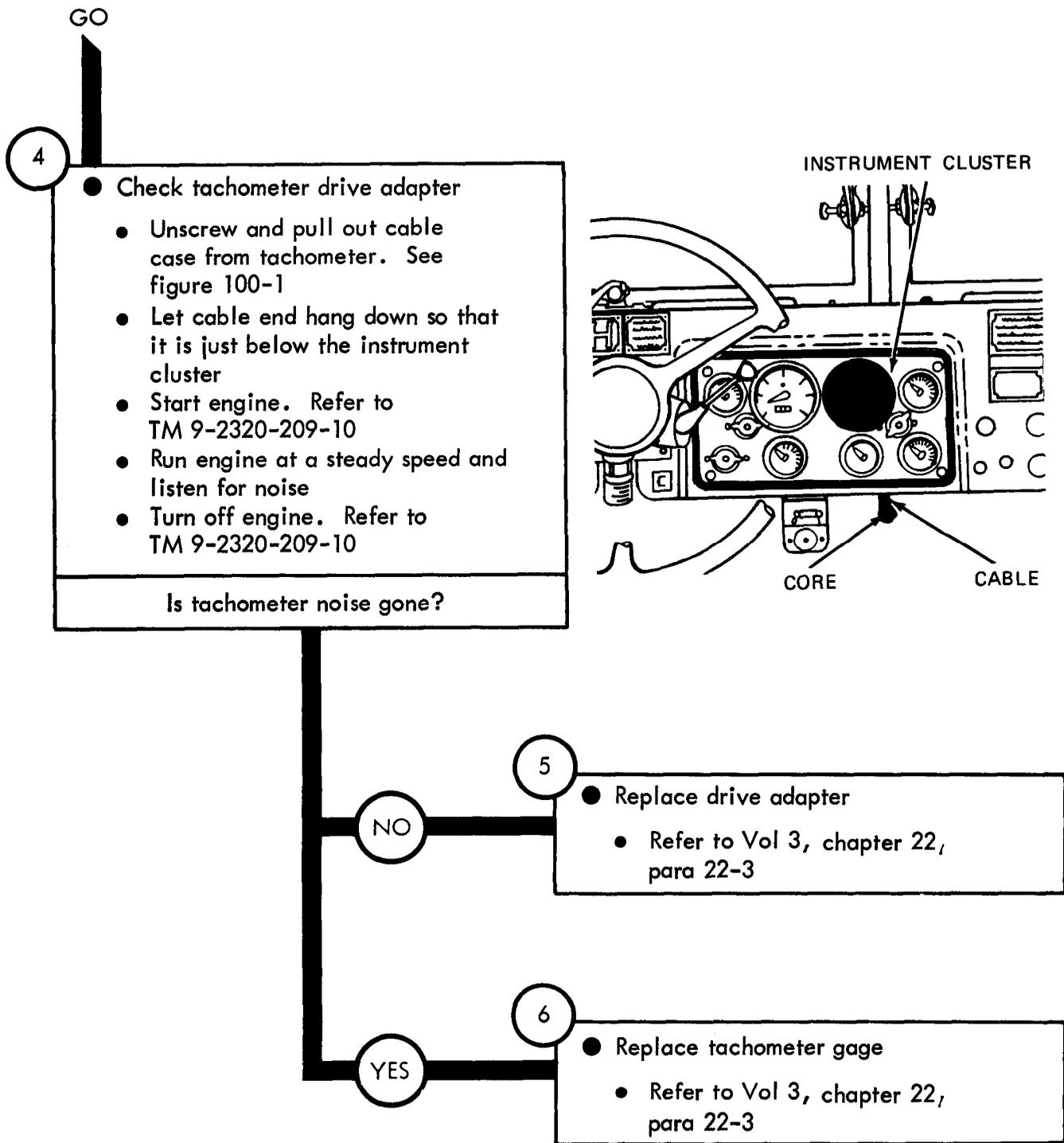

Figure 98-8 (Sheet 2 of 2)

TA 115268

CHAPTER 99

NON-ELECTRICAL GAGES TROUBLESHOOTING SUMMARY

99-1. GENERAL. This chapter gives a summary of troubleshooting procedures given in chapter 98 for the nonelectrical gages.

99-2. PROCEDURES. The summary in this chapter covers all fault symptoms found in the detailed troubleshooting procedures. Chapter 7 outlines a sample troubleshooting procedure. The summary procedures are based on the "what-to-do" portions of the detailed procedures and do not include the "how-to-do-it" instructions. Warnings, cautions, and notes are given where needed.

NON-ELECTRICAL GAGES TROUBLESHOOTING SUMMARY

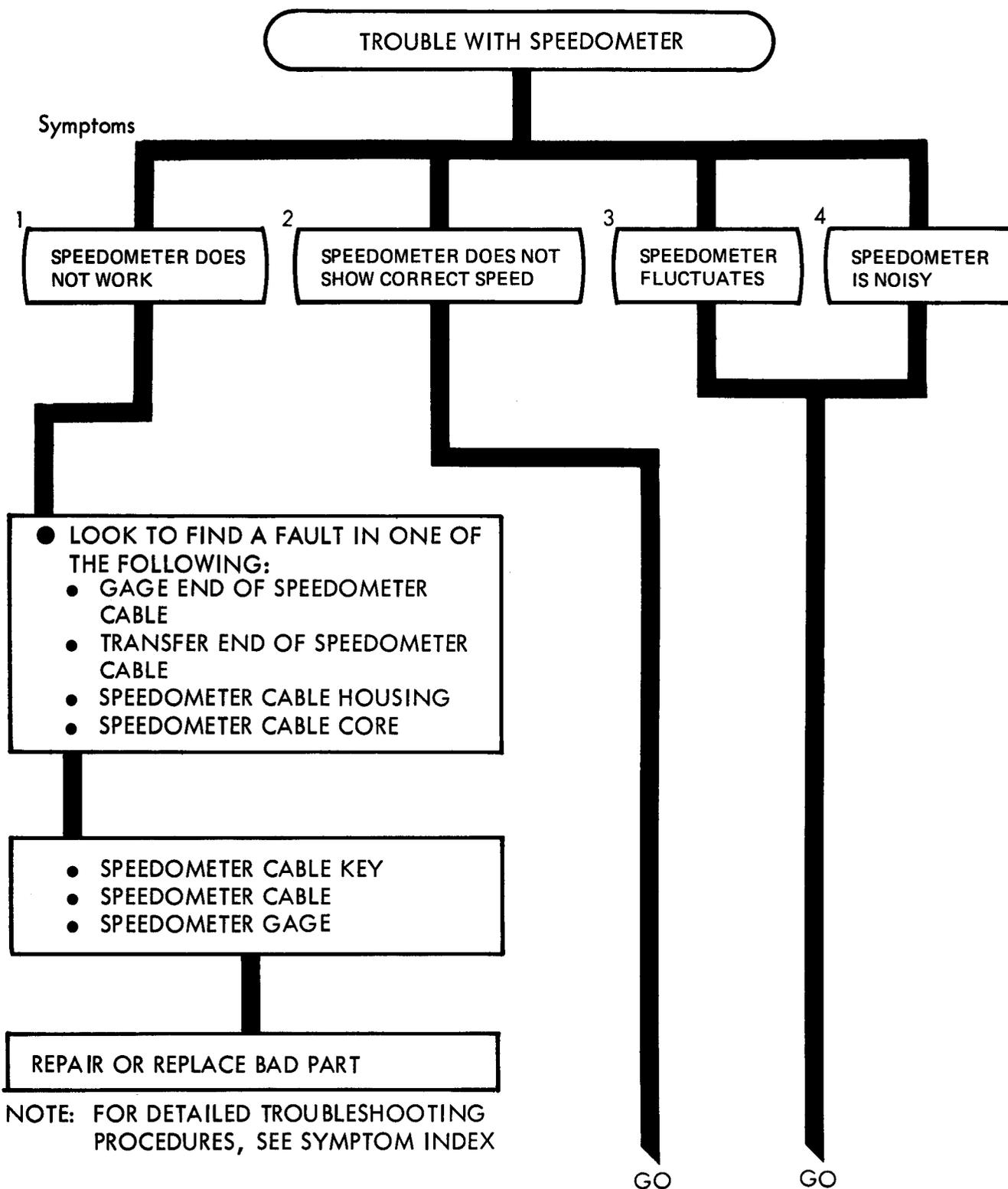

TA 115204

Figure 99-1 (Sheet 1 of 2)

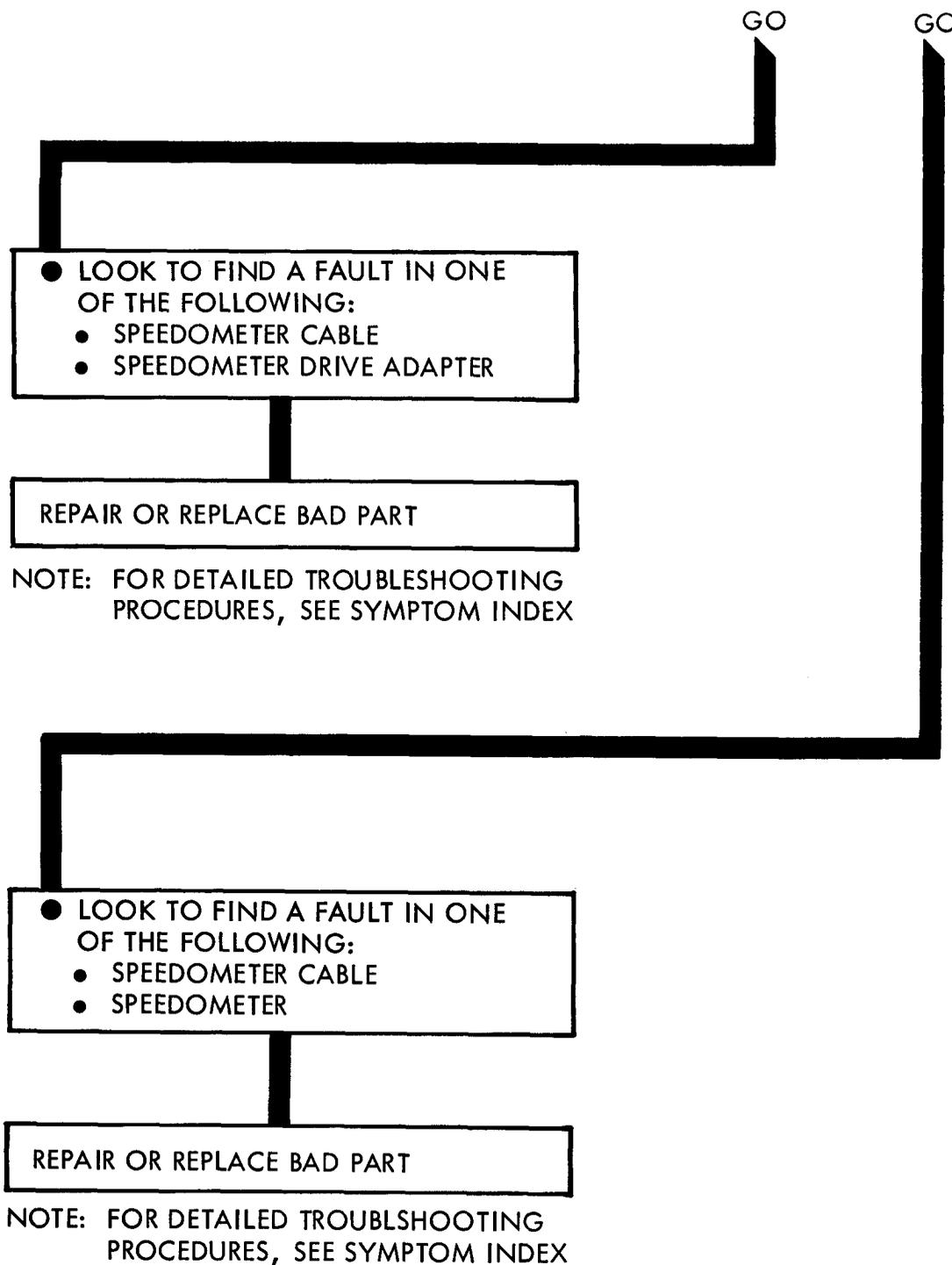
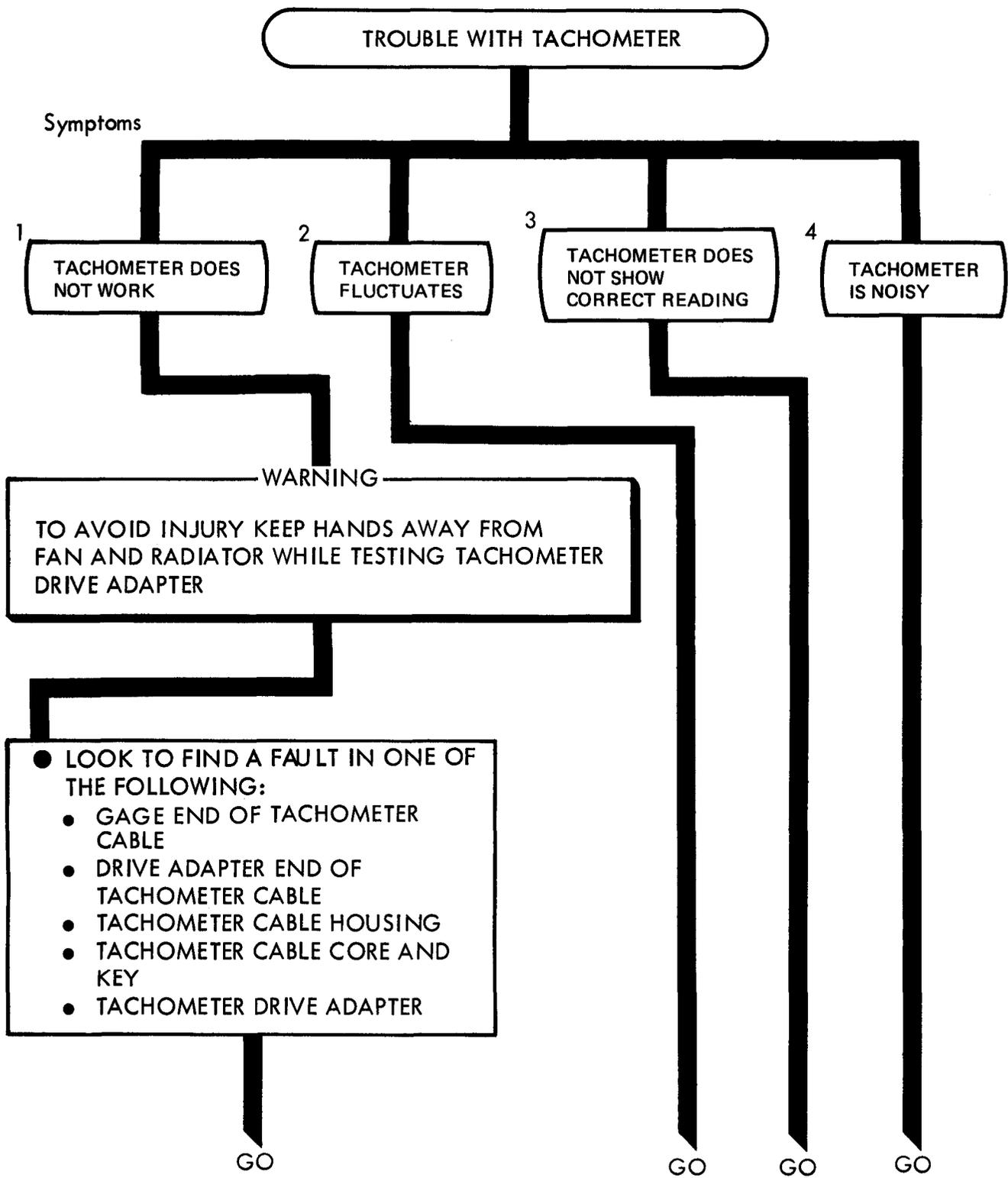

Figure 99-1 (Sheet 2 of 2)



TA 115206

Figure 99-2 (Sheet 1 of 3)

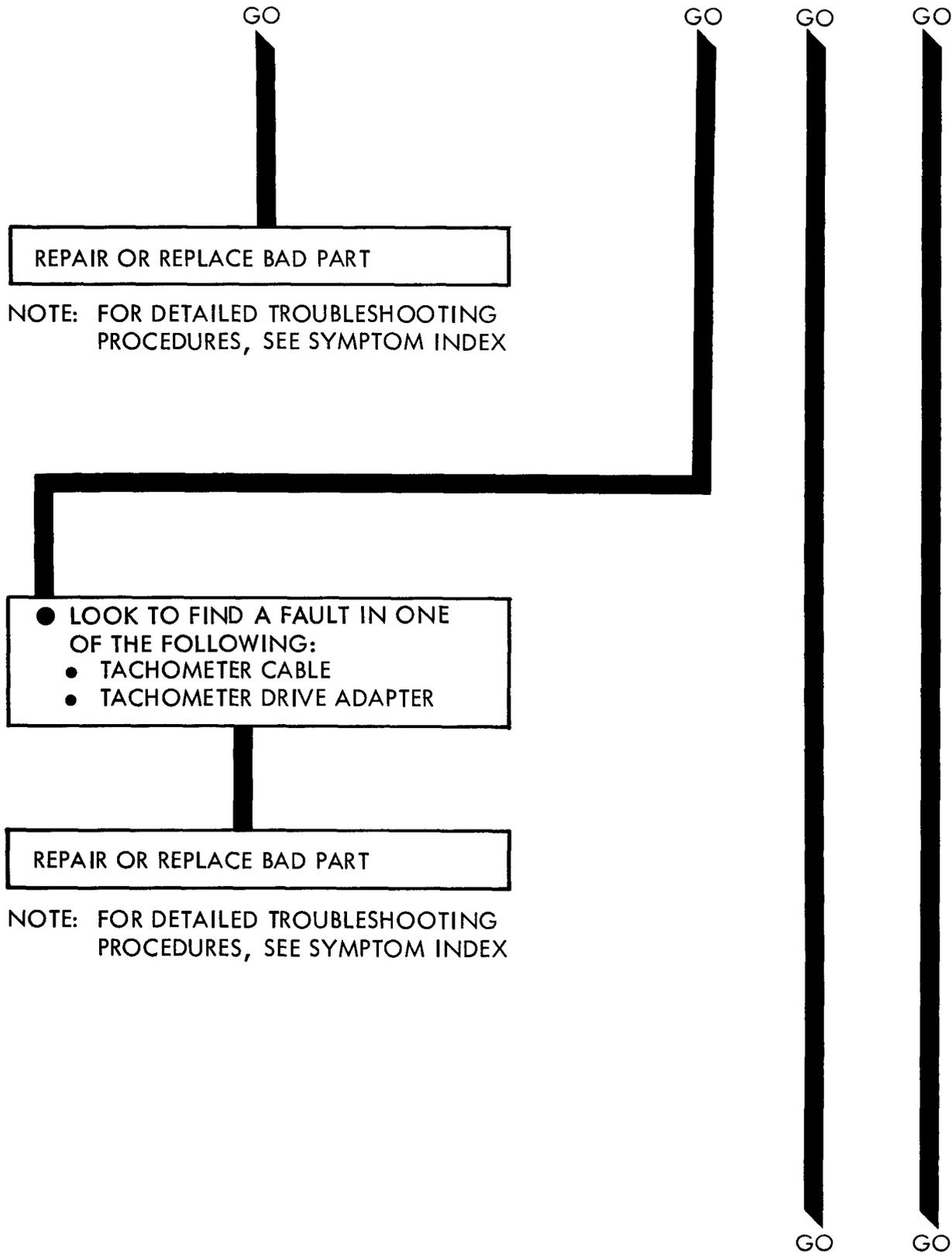
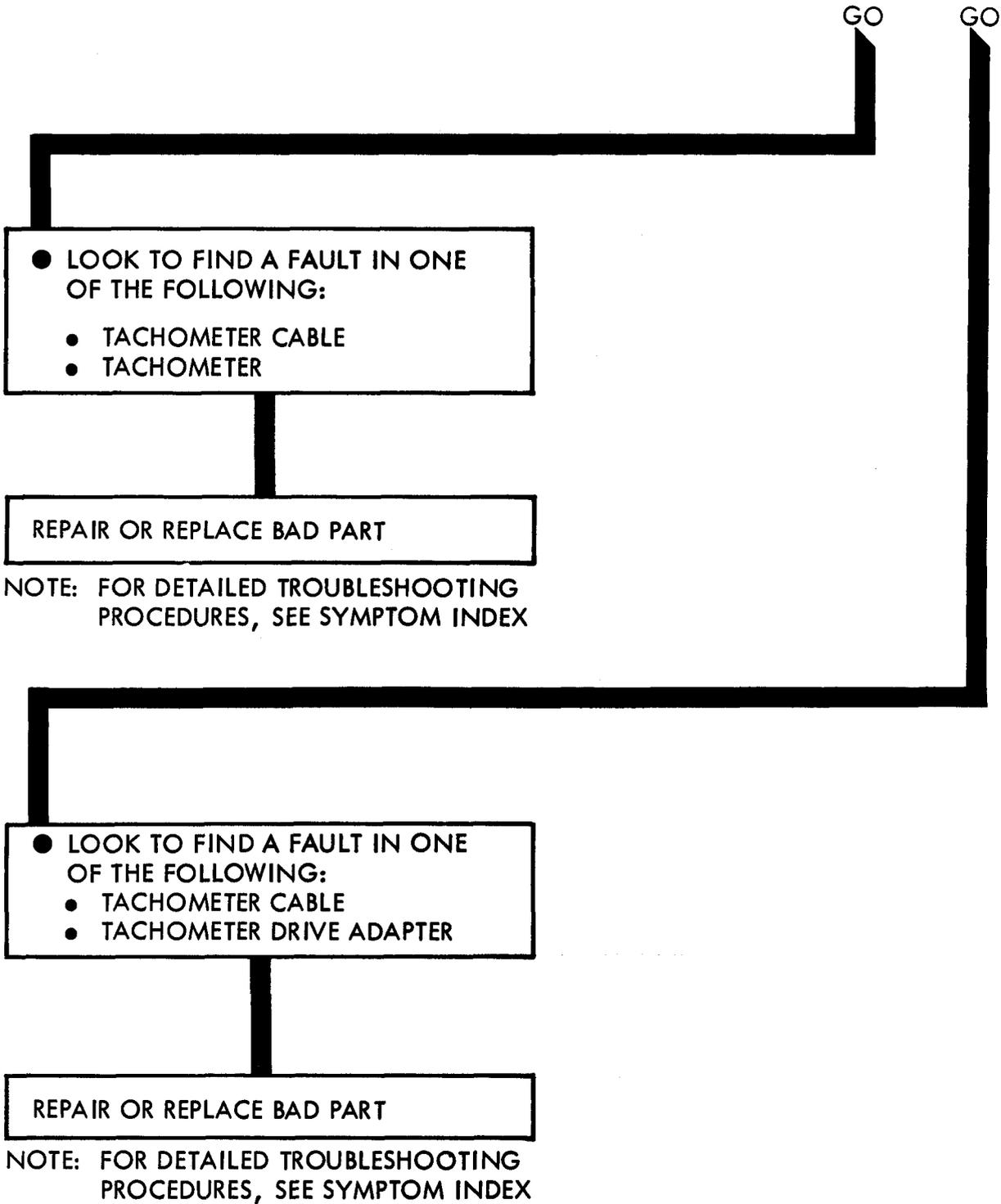

Figure 99-2 (Sheet 2 of 3)



TA 115208

Figure 99-2 (Sheet 3 of 3)

CHAPTER 100

NON-ELECTRICAL GAGES SUPPORT DIAGRAMS

100-1. GENERAL. This chapter gives the diagrams you need when doing troubleshooting procedures in chapter 98. Table 3-1 is a complete listing of all support diagrams used in this manual.

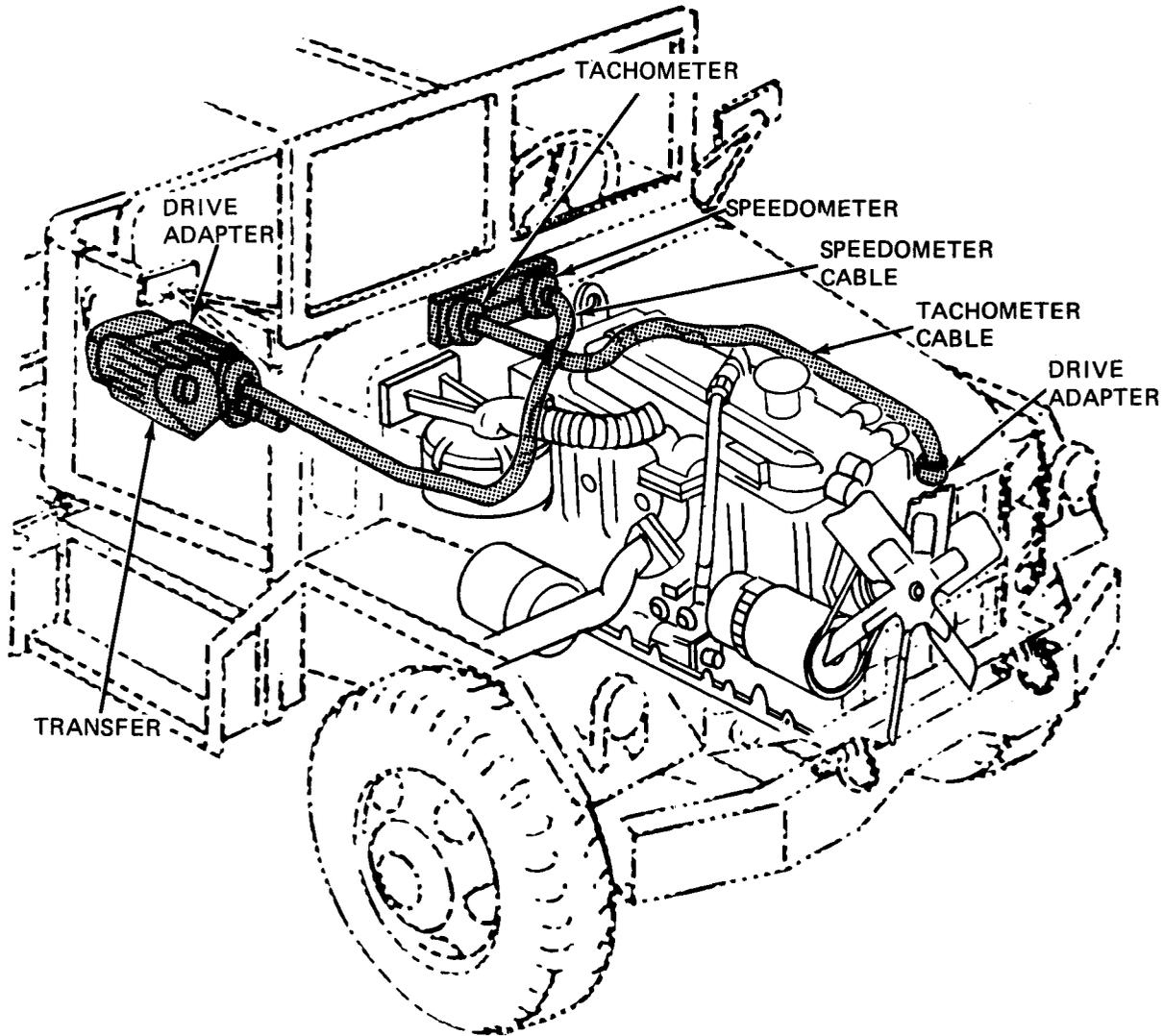

TA 115209

Figure 100-1. Non Electrical Gages Support Diagram

By Order of the Secretaries of the Army and the Air Force:

E. C. MEYER
General, United States Army
Chief of Staff

Official:

J. C. PENNINGTON
Major General, United States Army
The Adjutant General

LEW ALLEN, JR., General, USAF
Chief of Staff

Official:

VAN L. CRAWFORD, JR., Colonel, USAF
Director of Administration

Distribution:

To be distributed in accordance with DA Form 12-38, Organizational Maintenance requirements for 2-1/2-Ton Truck Cargo, 2-1/2-Ton Truck Van, etc.



THEN... JOT DOWN THE DOPE ABOUT IT ON THIS FORM, CAREFULLY TEAR IT OUT, FOLD IT AND DROP IT IN THE MAIL!

SOMETHING WRONG WITH THIS PUBLICATION?

FROM (PRINT YOUR UNIT'S COMPLETE ADDRESS)
 CDR, 1st Bn, 65th ADA
 Attn: SP4 Jane Idone
 Key West, FL 33040

DATE SENT Date sent in

PUBLICATION NUMBER
 TM 9-2320-209-20-2-2

PUBLICATION DATE
 27 May 1981

PUBLICATION TITLE ORGANIZATIONAL TROUBLESHOOTING MANUAL

BE EXACT... PIN-POINT WHERE IT IS

PAGE NO	PARA-GRAPH	FIGURE NO	TABLE NO
69-17		69-6 (Sheet 2 of 2)	
91-15		91-7 (Sheet 1 of 2)	
97-2		97-1 (Sheet 1 of 3)	

IN THIS SPACE TELL WHAT IS WRONG AND WHAT SHOULD BE DONE ABOUT IT:

Box ④, third sentence refers to figure 7-11.
 Should refer to figure 71-1.

Change illustration callouts.
 Reason: callouts for INLET SHUTOFF COCK and RETURN SHUTOFF COCK are reversed.

Box ③, fourth sentence reads "Put transmission gearshift lever in first position."
 Should read "Put transmission gearshift lever in first position and transfer shift lever in low position."

SAMPLE

PRINTED NAME GRADE OR TITLE AND TELEPHONE NUMBER
 SP4 Jane Idone Autovon 222-2224

SIGN HERE
 Jane Idone

FILL IN YOUR
UNIT'S ADDRESS



FOLY

DEPARTMENT OF THE ARMY

OFFICIAL BUSINESS
PENALTY FOR PRIVATE USE \$.

SAMPLE

POSTAGE AND FEES PAID
DEPARTMENT OF THE ARMY
DOD 314



TEAR ALONG PERFORATED LINE

Commander
U.S. Army Tank-Automotive Command
ATTN: DRSTA-MB
Warren, MI 48090

FILL IN YOUR
UNIT'S ADDRESS

FOLD BACK

DEPARTMENT OF THE ARMY

POSTAGE AND FEES PAID
DEPARTMENT OF THE ARMY
DOD 314



OFFICIAL BUSINESS
PENALTY FOR PRIVATE USE \$300

TEAR ALONG PERFORATED LINE

Commander
U.S. Army Tank-Automotive Command
ATTN: DRSTA-MB
Warren, MI 48090

RECOMMENDED CHANGES TO EQUIPMENT TECHNICAL PUBLICATIONS



THEN... JOT DOWN THE DOPE ABOUT IT ON THIS FORM, CAREFULLY TEAR IT OUT, FOLD IT AND DROP IT IN THE MAIL!

SOMETHING WRONG WITH THIS PUBLICATION?

FROM: (PRINT YOUR UNIT'S COMPLETE ADDRESS)

DATE SENT

PUBLICATION NUMBER

TM 9-2320-209-20-2-2

PUBLICATION DATE

27 May 1981

PUBLICATION TITLE

ORGANIZATIONAL TROUBLESHOOTING MANUAL

BE EXACT... PIN-POINT WHERE IT IS

PAGE NO	PARA-GRAPH	FIGURE NO	TABLE NO

IN THIS SPACE TELL WHAT IS WRONG AND WHAT SHOULD BE DONE ABOUT IT:

PRINTED NAME GRADE OR TITLE AND TELEPHONE NUMBER

SIGN HERE

FILL IN YOUR
UNIT'S ADDRESS

FOLD BACK

DEPARTMENT OF THE ARMY

POSTAGE AND FEES PAID
DEPARTMENT OF THE ARMY
DOD 314



OFFICIAL BUSINESS
PENALTY FOR PRIVATE USE \$300

TEAR ALONG PERFORATED LINE

Commander
U.S. Army Tank-Automotive Command
ATTN: DRSTA-MB
Warren, MI 48090

RECOMMENDED CHANGES TO EQUIPMENT TECHNICAL PUBLICATIONS



THEN... JOT DOWN THE DOPE ABOUT IT ON THIS FORM, CAREFULLY TEAR IT OUT, FOLD IT AND DROP IT IN THE MAIL!

SOMETHING WRONG WITH THIS PUBLICATION?

FROM (PRINT YOUR UNIT'S COMPLETE ADDRESS)

DATE SENT

PUBLICATION NUMBER

TM 9-2320-209-20-2-2

PUBLICATION DATE

27 May 1981

PUBLICATION TITLE

ORGANIZATIONAL TROUBLESHOOTING MANUAL

BE EXACT... PIN-POINT WHERE IT IS

PAGE NO

PARA-GRAPH

FIGURE NO

TABLE NO

IN THIS SPACE TELL WHAT IS WRONG AND WHAT SHOULD BE DONE ABOUT IT:

PRINTED NAME GRADE OR TITLE AND TELEPHONE NUMBER

SIGN HERE

FILL IN YOUR
UNIT'S ADDRESS

FOLD BACK

DEPARTMENT OF THE ARMY

POSTAGE AND FEES PAID
DEPARTMENT OF THE ARMY
DOD 314



OFFICIAL BUSINESS
PENALTY FOR PRIVATE USE \$300

Commander
U.S. Army Tank-Automotive Command
ATTN: DRSTA-MB
Warren, MI 48090

TEAR ALONG PERFORATED LINE

THE METRIC SYSTEM AND EQUIVALENTS

LINEAR MEASURE

1 Centimeter = 10 Millimeters = 0.01 Meters = 0.3937 Inches
 1 Meter = 100 Centimeters = 1000 Millimeters = 39.37 Inches
 1 Kilometer = 1000 Meters = 0.621 Miles

WEIGHTS

1 Gram = 0.001 Kilograms = 1000 Milligrams = 0.035 Ounces
 1 Kilogram = 1000 Grams = 2.2 Lb
 1 Metric Ton = 1000 Kilograms = 1 Megagram = 1.1 Short Tons

LIQUID MEASURE

1 Milliliter = 0.001 Liters = 0.0338 Fluid Ounces
 1 Liter = 1000 Milliliters = 33.82 Fluid Ounces

SQUARE MEASURE

1 Sq Centimeter = 100 Sq Millimeters = 0.155 Sq Inches
 1 Sq Meter = 10,000 Sq Centimeters = 10.76 Sq Feet
 1 Sq Kilometer = 1,000,000 Sq Meters = 0.386 Sq Miles

CUBIC MEASURE

1 Cu Centimeter = 1000 Cu Millimeters = 0.06 Cu Inches
 1 Cu Meter = 1,000,000 Cu Centimeters = 35.31 Cu Feet

TEMPERATURE

$5/9 (^{\circ}\text{F} - 32) = ^{\circ}\text{C}$
 212^o Fahrenheit is equivalent to 100^o Celsius
 90^o Fahrenheit is equivalent to 32.2^o Celsius
 32^o Fahrenheit is equivalent to 0^o Celsius
 $9/5 \text{ C}^{\circ} + 32 = \text{F}^{\circ}$

APPROXIMATE CONVERSION FACTORS

<u>TO CHANGE</u>	<u>TO</u>	<u>MULTIPLY BY</u>
Inches	Centimeters	2.540
Feet	Meters	0.305
Yards	Meters	0.914
Miles	Kilometers	1.609
Square Inches	Square Centimeters	6.451
Square Feet	Square Meters	0.093
Square Yards	Square Meters	0.836
Square Miles	Square Kilometers	2.590
Acres	Square Hectometers	0.405
Cubic Feet	Cubic Meters	0.028
Cubic Yards	Cubic Meters	0.765
Fluid Ounces	Milliliters	29.573
Pints	Liters	0.473
Quarts	Liters	0.946
Gallons	Liters	3.785
Ounces	Grams	28.349
Pounds	Kilograms	0.454
Short Tons	Metric Tons	0.907
Pound-Feet	Newton-Meters	1.356
Pounds per Square Inch	Kilopascals	6.895
Miles per Gallon	Kilometers per Liter	0.425
Miles per Hour	Kilometers per Hour	1.609

<u>TO CHANGE</u>	<u>TO</u>	<u>MULTIPLY BY</u>
Centimeters	Inches	0.394
Meters	Feet	3.280
Meters	Yards	1.094
Kilometers	Miles	0.621
Square Centimeters	Square Inches	0.155
Square Meters	Square Feet	10.764
Square Meters	Square Yards	1.196
Square Kilometers	Square Miles	0.386
Square Hectometers	Acres	2.471
Cubic Meters	Cubic Feet	35.315
Cubic Meters	Cubic Yards	1.308
Milliliters	Fluid Ounces	0.034
Liters	Pints	2.113
Liters	Quarts	1.057
Liters	Gallons	0.264
Grams	Ounces	0.035
Kilograms	Pounds	2.205
Metric Tons	Short Tons	1.102
Newton-Meters	Pound-Feet	0.738
Kilopascals	Pounds per Square Inch	0.145
Kilometers per Liter	Miles per Gallon	2.354
Kilometers per Hour	Miles per Hour	0.621

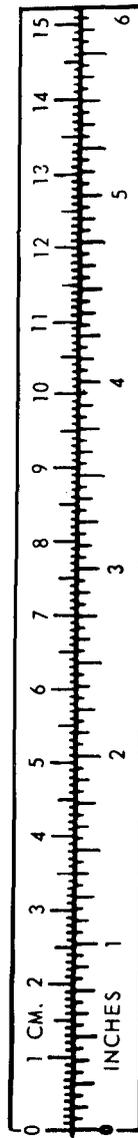

TAO89991

