

TM 9-2320-302-24P

**UNIT, DIRECT SUPPORT, AND GENERAL SUPPORT MAINTENANCE
REPAIR PARTS AND SPECIAL TOOLS LISTS (RPSTL)
(INCLUDING DEPOT MAINTENANCE REPAIR PARTS)**

FOR

**TRUCK, TRACTOR, LINE HAUL:
52,000 GVWR, 6 X 4, M915A3
(NSN 2320-01-432-4847)**

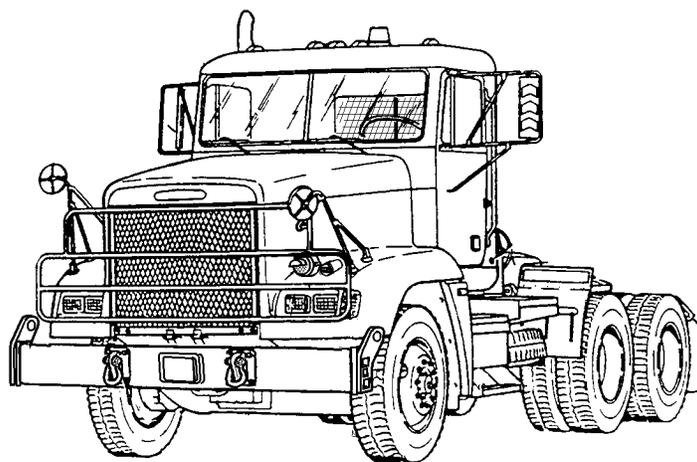

Approved for public release; distribution is unlimited.

HEADQUARTERS, DEPARTMENT OF THE ARMY

May 2001

LIST OF EFFECTIVE PAGES

NOTE

A vertical line in the outer margins of the page indicates the portion of text affected by the change. Changes to illustrations are indicated by miniature pointing hands. Change to wiring diagrams is indicated by shaded areas.

Dates of issue for original and change pages are:

Original. 0 28 May 2001

TOTAL NUMBER OF PAGES IN THIS PUBLICATION IS 824 CONSISTING OF THE FOLLOWING:

Page No.	*Change No.
Cover (Back Blank)	0
A (B Blank)	0
i thru x	0
1 thru 7	0
Figure 1 thru Figure 271	0
I-1 thru I-138	0

UNIT, DIRECT SUPPORT, AND GENERAL SUPPORT MAINTENANCE
REPAIR PARTS AND SPECIAL TOOLS LISTS (RPSTL)
(INCLUDING DEPOT MAINTENANCE REPAIR PARTS)

FOR

TRUCK, TRACTOR, LINE HAUL:
52,000 GVWR, 6 X 4, M915A3
(NSN 2320-01-432-4847)

Current as of 14 November 2000
Approved for Public Release; Distribution is Unlimited

REPORTING ERRORS AND RECOMMENDING IMPROVEMENTS

You can help improve this publication. If you find any mistakes or if you know of a way to improve the procedures, please let us know. Submit your DA Form 2028 (*Recommended Changes to Equipment Technical Publications*), through the Internet, on the Army Electronic Product Support (AEPS) website. The Internet address is <http://aeprs.ria.army.mil>. If you need a password, scroll down and click on "ACCESS REQUEST FORM". The DA Form 2028 is located in the ONLINE FORMS PROCESSING section of the AEPS. Fill out the form and click on SUBMIT. Using this form on the AEPS will enable us to respond quicker to your comments and better manage the DA Form 2028 program. You may also mail, fax or e-mail your letter, DA Form 2028 direct to: AMSTA-LC-CI/TECH PUBS, TACOM-RI, 1 Rock Island Arsenal, Rock Island, IL 61299-7630. The e-mail address is: TACOM-TECH-PUBS@ria.army.mil. The fax number is DSN 793-0726 or Commercial (309) 782-0726.

TABLE OF CONTENTS

	Illus/ Fig	Page
Section I. Introduction		
Section II. Repair Parts List		
GROUP 01 ENGINE		
0100- ENGINE ASSEMBLY		1-1
DRESSED ENGINE AND CONTAINER	1	1-1
FRONT ENGINE SUPPORT	2	2-1
FRONT ENGINE MOUNTING	3	3-1
REAR ENGINE MOUNTING	4	4-1
ENGINE LIFTING BRACKETS	5	5-1
0101- CRANKCASE, BLOCK, CYLINDER HEAD		6-1
CYLINDER HEAD ASSEMBLY	6	6-1
CYLINDER BLOCK	7	7-1
0102- CRANKSHAFT		9-1
CRANKSHAFT ASSEMBLY	8	8-1

TABLE OF CONTENTS (Con't)

	Illus/ Fig	Page
0103- FLYWHEEL ASSEMBLY		9-1
FLYWHEEL HOUSING.....	9	9-1
0104- PISTONS AND CONNECTING RODS		10-1
ROD, PISTON AND PIN	10	10-1
0105- VALVES, CAMSHAFTS, AND TIMING SYSTEM		11-1
CAMSHAFT ASSEMBLY	11	11-1
INTAKE AND EXHAUST VALVES	12	12-1
ROCKER ARMS AND SHAFT ASSEMBLY	13	13-1
ROCKER COVER AND BREATHER TUBE	14	14-1
0106- ENGINE LUBRICATION SYSTEM.....		15-1
ENGINE OIL CHECK AND FILL TUBES.....	15	15-1
OIL PAN ASSEMBLY	16	16-1
ENGINE OIL FILTERS	17	17-1
OIL COOLER ASSEMBLY	18	18-1
OIL DISTRIBUTION SYSTEM	19	19-1
ENGINE OIL PUMP	20	20-1
OIL RELIEF AND REGULATOR VALVES	21	21-1
OIL PRESSURE GAGE HOSE AND ENGINE OIL SAMPLE VALVE	22	22-1
0108- MANIFOLDS		23-1
INTAKE AND EXHAUST MANIFOLDS	23	23-1
0109- ACCESSORY DRIVING MECHANISMS		24-1
BULL GEAR AND ADJUSTABLE IDLER GEAR	24	24-1
ACCESSORY DRIVE	25	25-1
0112- ENGINE BRAKE		26-1
ENGINE RETARDER ASSEMBLY	26	26-1
0125- ACCESSORY DRIVE ASSEMBLY		27-1
GEAR CASE AND FRONT COVER.....	27	27-1
GROUP 03 FUEL SYSTEM		
0301- CARBURETOR, FUEL INJECTOR		28-1
INJECTOR ASSEMBLY	28	28-1
0302- FUEL PUMPS		29-1
FUEL PUMPS	29	29-1
FUEL FILTER, HOSES, FITTINGS AND ADAPTERS	30	30-1
0304- AIR CLEANER.....		31-1
AIR CLEANER TUBING AND ATTACHING HARDWARE	31	31-1
AIR CLEANER ASSEMBLY	32	32-1
AIR CLEANER HOUSING ASSEMBLY	33	33-1
0305- SUPERCHARGER, BLOWER, TURBOCHARGER, OR ALTITUDE COMPENSATOR		34-1
TURBOCHARGERS.....	34	34-1
CHARGE AIR COOLER	35	35-1

TABLE OF CONTENTS (Con't)

	Illus/ Fig	Page
0306- TANKS, LINES, FITTINGS, HEADERS		36-1
FUEL TANK ASSEMBLY AND ATTACHING HARDWARE	36	36-1
FUEL LINES AND FITTINGS	37	37-1
FUEL FILTER ELEMENTS	38	38-1
0311- ENGINE STARTING AIDS		39-1
ETHER STARTING AID	39	39-1
0312- ACCELERATOR, THROTTLE, OR CHOKE CONTROLS		40-1
ELECTRONIC THROTTLE ASSEMBLY	40	40-1
GROUP 04 EXHAUST SYSTEM		
0401- MUFFLER AND PIPES		41-1
EXHAUST PIPES AND MOUNTING HARDWARE	41	41-1
MUFFLER MOUNTING HARDWARE	42	42-1
MUFFLER HEAT SHIELD	43	43-1
GROUP 05 COOLING SYSTEM		
0501- RADIATOR, EVAPORATIVE COOLER, OR HEAT EXCHANGER		44-1
RADIATOR MOUNTING HARDWARE	44	44-1
RADIATOR ASSEMBLY	45	45-1
0502- COWLING, DEFLECTORS, AIR DUCTS, SHROUDS, ETC.....		46-1
AIR RECIRCULATION SHIELD	46	46-1
FAN SHROUD	47	47-1
0503- WATER MANIFOLD, HEATERS, THERMOSTATS, AND HOUSING GASKET		48-1
FAN CLUTCH PLUMBING	48	48-1
RADIATOR PIPING	49	49-1
THERMOSTAT COVER AND THERMOSTAT	50	50-1
0504- WATER PUMP		51-1
WATER PUMP ASSEMBLY	51	51-1
0505 FAN ASSEMBLY		52-1
FAN IMPELLER	52	52-1
FAN MOUNTING SUPPORT	53	53-1
FAN CLUTCH ASSEMBLY	54	54-1
0508 WATER FILTER		55-1
WATER FILTER INSTALLATION	55	55-1
GROUP 06 ELECTRICAL SYSTEM		
0601- GENERATOR, ALTERNATOR		56-1
ALTERNATOR PULLEY, BELT AND ATTACHING HARDWARE	56	56-1
ALTERNATOR ASSEMBLY	57	57-1
0602- GENERATOR REGULATOR (VOLTAGE)		58-1
REGULATOR	58	58-1

TABLE OF CONTENTS (Con't)

	Illus/ Fig	Page
0603- STARTING MOTOR		59-1
STARTER AND ATTACHING PARTS	59	59-1
STARTER ASSEMBLY	60	60-1
STARTER RELAY (MAGNETIC SWITCH).....	61	61-1
0605- IGNITION COMPONENTS		62-1
ELECTRONIC CONTROL MODULE	62	62-1
ELECTRONIC CONTROL MODULE WIRING HARNESS.....	63	63-1
INJECTOR WIRING HARNESS	64	64-1
ENGINE WIRING HARNESS	65	65-1
ENGINE DDEC WIRING HARNESS	66	66-1
POWER DDEC WIRING HARNESS	67	67-1
0607- INSTRUMENT OR ENGINE CONTROL PANEL.....		68-1
INSTRUMENT PANEL SWITCHES	68	68-1
RIGHT DASH PANEL SWITCHES	69	69-1
CENTER DASH PANEL	70	70-1
LEFT AND CENTER DASH PANEL GAGES	71	71-1
ENGINE CHECK SWITCH AND CAB AIR JUNCTION BLOCK WIRING.....	72	72-1
TURN SIGNAL SWITCH	73	73-1
0608- MISCELLANEOUS ITEMS		74-1
FUSE, RELAY, AND CIRCUIT BREAKER PANEL	74	74-1
ABS ECU HARNESS FUSES, RELAYS AND CIRCUIT BREAKERS	75	75-1
ENGINE WIRING HARNESS MOUNTING HARDWARE	76	76-1
CHASSIS WIRING HARNESS MOUNTING HARDWARE	77	77-1
CAB TO FRAME GROUNDING WIRE	78	78-1
0609- LIGHTS.....		79-1
HEADLAMP AND TURN SIGNAL	79	79-1
TAILLIGHTS	80	80-1
BLACKOUT AND MARKER LIGHTS	81	81-1
CLEARANCE LIGHT, UTILITY LIGHT AND BEACON BRACKET	82	82-1
INTERIOR LIGHT AND UTILITY POWER.....	83	83-1
0610- SENDING UNITS AND WARNING SWITCHES.....		84-1
ELECTRONIC CONTROL MODULE SENSORS	84	84-1
CLUTCH TRANSMISSION SWITCH AND SPST SWITCH.....	85	85-1
RPM PULSE SENDER, FUEL PRESSURE SENDER, SWITCH AND OIL PRESSURE SWITCH	86	86-1
WATER LEVEL PROBE, MODULE AND A/C SWITCH.....	87	87-1
ABS SENSORS	88	88-1
SENSORS AND SENDING UNITS	89	89-1
0611- HORN, SIREN		90-1
ELECTRIC HORN	90	90-1
0612- BATTERIES, STORAGE (WET OR DRY).....		91-1
BATTERIES, BATTERY CABLES, EQUALIZER, AND CUTOFF SWITCH	91	91-1
BATTERY BOX ASSEMBLY	92	92-1

TABLE OF CONTENTS (Con't)

	Illus/ Fig	Page
0613- HULL OR CHASSIS WIRING HARNESS		93-1
MAIN CAB WIRING HARNESS	93	93-1
OVERHEAD CAB WIRING HARNESS	94	94-1
CAB FLOOR WIRING HARNESS	95	95-1
CHASSIS WIRING HARNESS	96	96-1
STOP/TAIL/BACKUP LIGHTS WIRING HARNESS	97	97-1
TURN SIGNAL/MARKER LIGHT WIRING HARNESS	98	98-1
TURN SIGNAL (THRU DECK) WIRING HARNESS	99	99-1
BLACKOUT LIGHTS WIRING HARNESS	100	100-1
HARNESS OVERLAY	101	101-1
TRAILER HOOKUP INSTALLATION	102	102-1
TRAILER HOOKUP CABLE AND RECEPTACLE CABLE	103	103-1
FRONT CHASSIS ABS WIRING HARNESS	104	104-1
REAR CHASSIS ABS WIRING HARNESS	105	105-1
ABS COVER AND MOUNTING PLATES	106	106-1
ABS ECU MOUNTING AND RELATED PARTS	107	107-1
ABS DIAGNOSTIC HARNESSSES	108	108-1
ABS TRAILER CAB FLOOR HARNESS	109	109-1
ECU/ABS WIRING HARNESS	110	110-1
ABS WARNING LAMP	111	111-1
ABS FLOOR HARNESS	112	112-1
ABS WIRING HARNESS HARDWARE	113	113-1
PERSONNEL HEATER WIRING HARNESS	114	114-1
TRANSMISSION ECU HARNESS	115	115-1
ABS OVERLAY HARNESS AND INTERFACE ASSEMBLY	116	116-1
TRANSMISSION POWER HARNESS	117	117-1
 GROUP 07 TRANSMISSION		
0705- TRANSMISSION SHIFTING COMPONENTS		118-1
TRANSMISSION SHIFT CONTROL	118	118-1
0710- TRANSMISSION ASSEMBLY AND ASSOCIATED PARTS		119-1
DRESSED TRANSMISSION AND CONTAINER	119	119-1
TRANSMISSION FILLER TUBE, REAR YOKE AND ATTACHING HARDWARE	120	120-1
TRANSMISSION MOUNTING HARDWARE	121	121-1
FLEXPLATE AND ADAPTER	122	122-1
TORQUE CONVERTER ASSEMBLY	123	123-1
TORQUE CONVERTER HOUSING COMPONENTS	124	124-1
FRONT SUPPORT AND OIL PUMP ASSEMBLY	125	125-1
MAIN SHAFT	126	126-1
MAIN HOUSING AND RELATED COMPONENTS	127	127-1
REAR COVER AND COMPONENT PARTS	128	128-1
0713- INTERMEDIATE CLUTCH		129-1
ROTATING CLUTCH ASSEMBLY	129	129-1
C3/C4 CLUTCH ASSEMBLY	130	130-1
P1 PLANETARY ASSEMBLY	131	131-1
P2 PLANETARY ASSEMBLY	132	132-1
P3 PLANETARY ASSEMBLY	133	133-1
CONTROL VALVES AND WIRING HARNESS	134	134-1
TRANSMISSION OIL COOLER, LINES AND FITTINGS	135	135-1

TABLE OF CONTENTS (Con't)

	Illus/ Fig	Page
GROUP 09 PROPELLER, PROPELLER SHAFTS, UNIVERSAL JOINTS, COUPLER, AND CLAMP ASSEMBLY		
0900- PROPELLER SHAFTS		136-1
MAIN PROPELLER SHAFT ASSEMBLY	136	136-1
INTER-AXLE PROPELLER SHAFT ASSEMBLY	137	137-1
GROUP 10 FRONT AXLE		
1000- FRONT AXLE ASSEMBLY		138-1
FRONT AXLE ASSEMBLY	138	138-1
1004- STEERING AND LEANING WHEEL MECHANISM		139-1
TIE ROD KNUCKLES	139	139-1
GROUP 11 REAR AXLE		
1100- REAR AXLE ASSEMBLY		140-1
FORWARD-REAR AXLE DRESSED	140	140-1
REAR-REAR AXLE DRESSED	141	141-1
1102- DIFFERENTIAL		142-1
FORWARD-REAR AXLE DIFFERENTIAL CARRIER ASSEMBLY	142	142-1
FORWARD-REAR AXLE OUTPUT SHAFT ASSEMBLY	143	143-1
REAR-REAR AXLE DIFFERENTIAL CARRIER ASSEMBLY	144	144-1
GROUP 12 BRAKES		
1202- SERVICE BRAKES		145-1
HANGING BRAKE ASSEMBLY	145	145-1
FRONT BRAKE ASSEMBLY	146	146-1
REAR BRAKE ASSEMBLY	147	147-1
FRONT BRAKE CHAMBER	148	148-1
1208- AIRBRAKE SYSTEM		149-1
REAR BRAKE CHAMBER	149	149-1
AIR SYSTEM VALVES, TANKS, LINES AND FITTINGS, PART 1	150	150-1
AIR SYSTEM VALVES, TANKS, LINES AND FITTINGS, PART 2	151	151-1
AIR SYSTEM VALVES, TANKS, LINES AND FITTINGS, PART 3	152	152-1
AIR SYSTEM VALVES, TANKS, LINES AND FITTINGS, PART 4	153	153-1
AIR SYSTEM VALVES, TANKS, LINES AND FITTINGS, PART 5	154	154-1
AIR SYSTEM VALVES, TANKS, LINES AND FITTINGS, PART 6	155	155-1
AIR SYSTEM VALVES, TANKS, LINES AND FITTINGS, PART 7	156	156-1
AIR SYSTEM VALVES, TANKS, LINES AND FITTINGS, PART 8	157	157-1
AIR SYSTEM VALVES, TANKS, LINES AND FITTINGS, PART 9	158	158-1
AIR SYSTEM VALVES, TANKS, LINES AND FITTINGS, PART 10	159	159-1
AIR DRYER ASSEMBLY	160	160-1
1209- TRAILER BRAKE CONNECTIONS AND CONTROLS		161-1
AIR COMPRESSOR LINES AND FITTINGS	161	161-1
AIR COMPRESSOR ASSEMBLY	162	162-1
AIR COMPRESSOR GOVERNOR AND DISCHARGE	163	163-1

TABLE OF CONTENTS (Con't)

	Illus/ Fig	Page
GROUP 13 WHEELS AND TRACKS		
1311- WHEEL ASSEMBLY		164-1
FRONT AXLE HUB ASSEMBLY	164	164-1
REAR AXLE HUB ASSEMBLY	165	165-1
WHEEL ASSEMBLY	166	166-1
1313- TIRES, TUBES, TIRE CHAINS		167-1
TIRES	167	167-1
GROUP 14 STEERING		
1401- MECHANICAL STEERING GEAR ASSEMBLY		168-1
STEERING COLUMN	168	168-1
UNIVERSAL SHAFT AND STEERING BOOT	169	169-1
STEERING LINKAGE	170	170-1
STEERING GEAR MOUNTING HARDWARE	171	171-1
STEERING GEAR ASSEMBLY	172	172-1
1410- HYDRAULIC PUMP OR FLUID MOTOR ASSEMBLY		173-1
HYDRAULIC STEERING PUMP	173	173-1
1411- HOSES, LINES, FITTINGS		174-1
STEERING LINES AND FITTINGS	174	174-1
1413- TANKS, RESERVOIRS		175-1
RESERVOIR ASSEMBLY AND BRACKET	175	175-1
GROUP 15 FRAME, TOWING ATTACHMENTS, DRAWBARS, AND ARTICULATION SYSTEMS		
1501- FRAME ASSEMBLY		176-1
FORWARD FRAME ASSEMBLY	176	176-1
OVERSLUNG CROSSMEMBER AND FRONT ENGINE MOUNTING	177	177-1
CAB ALLIGATOR CROSSMEMBER	178	178-1
TREADPLATE, L/S PLATFORM, MIDSHIPS AND ALLIGATOR CROSSMEMBER	179	179-1
REAR SUSPENSION CROSSMEMBER	180	180-1
REAR CROSSMEMBER AND TIE DOWN	181	181-1
FRONT MUDFLAPS	182	182-1
REAR MUDFLAPS	183	183-1
RAMP INSTALLATION	184	184-1
1503- PINTLES AND TOWING ATTACHMENTS		185-1
FRONT BUMPER, TOW BRACKET AND SLING BRACKET	185	185-1
PINTLE HOOK, REAR	186	186-1
1504- SPARE WHEEL CARRIER AND TIRE LOCK		187-1
SPARE TIRE CARRIER	187	187-1
1506- FIFTH WHEEL		188-1
FIFTH WHEEL ASSEMBLY	188	188-1
FIFTH WHEEL COMPONENTS	189	189-1
WHEEL PLATE ASSEMBLY	190	190-1
SLIDER BRACKET AND PLATE	191	191-1

TABLE OF CONTENTS (Con't)

	Illus/ Fig	Page
GROUP 16 SPRINGS AND SHOCK ABSORBERS		
1601- SPRINGS		192-1
FRONT SPRINGS	192	192-1
REAR SPRING ASSEMBLY	193	193-1
1604- SHOCK ABSORBER EQUIPMENT		194-1
FRONT SHOCK ABSORBER	194	194-1
REAR SHOCK ABSORBER	195	195-1
1605- TORQUE, RADIUS, AND STABILIZER RODS		196-1
REAR SUSPENSION TORQUE RODS AND ATTACHING HARDWARE	196	196-1
GROUP 18 BODY, CAB, HOOD, AND HULL		
1801- BODY, CAB, HOOD, AND HULL ASSEMBLIES		197-1
CAB MOUNTING HARDWARE	197	197-1
CAB FRAME COMPONENTS	198	198-1
CAB COMPONENTS	199	199-1
CAB INTERIOR TRIM COMPONENTS	200	200-1
DASHBOARD ASSEMBLY	201	201-1
CAB OVERHEAD STORAGE COMPONENTS	202	202-1
DOOR ASSEMBLY	203	203-1
EXTERIOR GRAB HANDLES	204	204-1
LATCH AND HOOD MOUNT	205	205-1
HOOD ASSEMBLY	206	206-1
HOOD LINER, INSULATION	207	207-1
TILT ASSIST AND HINGES	208	208-1
BRUSH GUARD	209	209-1
1802- FENDERS, RUNNING BOARDS WITH MOUNTING AND ATTACHING PARTS, OUTRIGGERS, WINDSHIELD, GLASS, ETC.		210-1
STEP ASSEMBLY R/S	210	210-1
LEFT STEP ASSEMBLY	211	211-1
FRONT QUARTERFENDER INSTALLATION	212	212-1
REAR QUARTERFENDER INSTALLATION	213	213-1
WINDSHIELD AND WINDOWS	214	214-1
1805- FLOORS, SUBFLOORS, AND RELATED COMPONENTS		215-1
FLOOR COVERING	215	215-1
1806- UPHOLSTERY, SEATS, AND CARPETS		216-1
INTERIOR CAB PANELS	216	216-1
SEAT MOUNTING BRACKET	217	217-1
SEAT MOUNTING HARDWARE AND SEATBELTS	218	218-1
SEAT ASSEMBLY	219	219-1
SEAT BASE ASSEMBLY	220	220-1
1808- STOWAGE RACKS, BOXES, STRAPS, CARRYING CASES, CABLE REELS, HOSE REELS, ETC.		221-1
PERSONNEL AND TIRE CHAIN BOXES	221	221-1
TRACTOR EQUIPMENT BOX	222	222-1
JACK HOLDDOWN COMPONENTS	223	223-1
FIRE EXTINGUISHER BRACKET	224	224-1

TABLE OF CONTENTS (Con't)

	Illus/ Fig	Page
GROUP 22 BODY, CHASSIS, AND HULL ACCESSORY ITEMS		
2202- ACCESSORY ITEMS		225-1
WINDSHIELD WIPERS, MOTOR AND WASHER BOTTLE	225	225-1
AIR HORN ASSEMBLY AND MOUNTING HARDWARE	226	226-1
REAR VIEW MIRROR AND ATTACHING HARDWARE	227	227-1
REAR VIEW MIRROR (SPOTTER) AND LOOKDOWN MIRROR	228	228-1
RADIO ANTENNA MOUNTING.....	229	229-1
VEHICLE HEATER DUCT ASSEMBLY	230	230-1
HEATER/AC CONTROL ASSEMBLY	231	231-1
VEHICLE HEATER AIR INTAKE	232	232-1
HEATER/AC ASSEMBLY	233	233-1
HEATER HOSES.....	234	234-1
2210- DATA PLATES AND INSTRUCTION HOLDERS		235-1
DATA PLATES	235	235-1
DATA PLATES	236	236-1
FAN DECALS	237	237-1
GROUP 33 SPECIAL PURPOSE KITS		
3301- REUSABLE SHIPPING CONTAINERS		238-1
ENGINE CONTAINER	238	238-1
TRANSMISSION CONTAINER	239	239-1
PERSONNEL ARCTIC HEATER LINES, FITTINGS AND HARDWARE	240	240-1
ARCTIC HEATER ASSEMBLY	241	241-1
PERSONNEL AUXILIARY HEATER AND COMPONENTS	242	242-1
3307- SPECIAL PURPOSE KITS		243-1
AIR DEFLECTOR KIT	243	243-1
GROUP 34 ARMAMENT AND SIGHTING AND FIRE CONTROL MATERIEL		
3401- PRIMARY ARMAMANT		244-1
RIFLE MOUNTING KIT	244	244-1
GROUP 42 ELECTRICAL EQUIPMENT		
4209- SIGNALING DEVICES		245-1
BEACON WARNING LIGHT KIT	245	245-1
GROUP 47 GAGES (NONELECTRICAL), WEIGHING AND MEASURING DEVICES		
4702- GAGES, MOUNTINGS, LINES, AND FITTINGS.....		246-1
AIR PRESSURE GAGES AND AIR RESTRICTION GAGE.....	246	246-1
GROUP 52 REFRIGERATION, AIR CONDITIONER/HEATER, AND AIR CONDITIONING COMPONENTS		
5200- AIR CONDITIONER/HEATER ASSEMBLY AND GAS COMPRESSOR ASSEMBLY		247-1
A/C COMPRESSOR AND MOUNTING HARDWARE	247	247-1
5203- COMPRESSOR DRIVE, PEDESTAL, BASE		248-1
CLUTCH ASSEMBLY, A/C COMPRESSOR	248	248-1
5217- REFRIGERANT PIPING		249-1
A/C HOSES AND BRACKETS	249	249-1

TABLE OF CONTENTS (Con't)

	Illus/ Fig	Page
5230- CONDENSER.....		250-1
A/C CONDENSER AND REC/DRYER.....	250	250-1
GROUP 68 WARNING, SCANNING, AND SIGNALING DEVICES, AND NAVIGATIONAL INSTRUMENTS		
6806- RADAR SYSTEM		251-1
VORAD EXTERNAL COMPONENTS	251	251-1
VORAD CAB WIRING	252	252-1
VORAD INTERNAL CAB COMPONENTS.....	253	253-1
VORAD CHASSIS HARNESS COMPONENTS.....	254	254-1
VORAD CAB HARNESS COMPONENTS.....	255	255-1
GROUP 91 CHEMICAL, BIOLOGICAL, AND RADIOLOGICAL (CBR) EQUIPMENT		
9120- DECONTAMINATION EQUIPMENT		256-1
M13 DECONTAMINATION MOUNTING KIT	256	256-1
GROUP 94 REPAIR KITS EQUIPMENT		
9401- REPAIR KITS		KITS-1
KITS.....	KITS	KITS-1
GROUP 95 GENERAL USE STANDARDIZED PARTS		
9501- HARDWARE SUPPLIES AND BULK MATERIEL, COMMON.....		BULK-1
BULK	BULK	BULK-1
Section III. Special Tools List		
GROUP 26 TOOLS AND TEST EQUIPMENT		
2604- SPECIAL TOOLS		257-1
UNIT SPECIAL TOOLS	257	257-1
UNIT SPECIAL TOOLS	258	258-1
UNIT SPECIAL TOOLS	259	259-1
DIRECT SUPPORT SPECIAL TOOLS.....	260	260-1
DIRECT SUPPORT SPECIAL TOOLS.....	261	261-1
DIRECT SUPPORT SPECIAL TOOLS.....	262	262-1
DIRECT SUPPORT SPECIAL TOOLS.....	263	263-1
DIRECT SUPPORT SPECIAL TOOLS.....	264	264-1
DIRECT SUPPORT SPECIAL TOOLS.....	265	265-1
GENERAL SUPPORT SPECIAL TOOLS.....	266	266-1
GENERAL SUPPORT SPECIAL TOOLS.....	267	267-1
GENERAL SUPPORT SPECIAL TOOLS.....	268	268-1
GENERAL SUPPORT SPECIAL TOOLS.....	269	269-1
GENERAL SUPPORT SPECIAL TOOLS.....	270	270-1
GENERAL SUPPORT SPECIAL TOOLS.....	271	271-1
Section IV. Cross-Reference Indexes		
NATIONAL STOCK NUMBER INDEX.....		I-1
PART NUMBER INDEX.....		I-38

UNIT, DIRECT SUPPORT, AND GENERAL SUPPORT MAINTENANCE REPAIR PARTS AND SPECIAL TOOLS LISTS (RPSTL) (INCLUDING DEPOT MAINTENANCE REPAIR PARTS) - INTRODUCTION

0001 00

SCOPE

This RPSTL lists and authorizes spares and repair parts; special tools; special test, measurement, and diagnostic equipment (TMDE); and other special support equipment required for performance of Unit, Direct Support and General Support maintenance of the M915A3. It authorizes the requisitioning, issue, and disposition of spares, repair parts, and special tools as indicated by the source, maintenance, and recoverability (SMR) codes.

GENERAL

In addition to the Introduction work package, this RPSTL is divided into the following work packages:

- a. **Repair Parts List Work Packages.** Work packages containing lists of spares and repair parts authorized by this RPSTL for use in the performance of maintenance. These work packages also include parts which must be removed for replacement of the authorized parts. Parts lists are composed of functional groups in ascending alphanumeric sequence, with the parts in each group listed in ascending figure and item number sequence. Sending units, brackets, filters, and bolts are listed with the component they mount on. Bulk materials are listed by item name in FIG. BULK at the end of the work packages. Repair parts kits are listed separately in their own functional group and work package. Repair parts for repairable special tools are also listed in a separate work package. Items listed are shown on the associated illustrations.
- b. **Special Tools List Work Packages.** Work packages containing lists of special tools, special TMDE, and special support equipment authorized by this RPSTL [as indicated by Basis of Issue (BOI) information in the DESCRIPTION AND USABLE ON CODE (UOC) column]. Tools that are components of common tool sets and/or Class VII are listed.
- c. **Cross-Reference Indexes Work Packages.** There are two cross-reference indexes work packages in this RPSTL: WP 0004 00 National Stock Number Index and WP 0005 00 Part Number Index.

EXPLANATION OF COLUMNS IN THE REPAIR PARTS LIST AND SPECIAL TOOLS LIST WORK PACKAGES

- a. **Item No. (Column 1).** Indicates the number used to identify items called out in the illustration.
- b. **SMR Code (Column 2).** The SMR code containing supply/requisitioning information, maintenance level authorization criteria, and disposition instruction, as shown in the following breakout:

SOURCE CODE	MAINTENANCE CODE		RECOVERABILITY CODE
XXxxx	xxXXx		xxxxX
1st two positions	3rd position	4th position	5th position
How you get an item.	Who can install, replace or use the item.	Who can do complete repair* on the item.	Who determines disposition action on an unserviceable item.

* *Complete Repair:* Maintenance capacity, capability, and authority to perform all corrective maintenance tasks of the "Repair" function in a use/user environment in order to restore serviceability to a failed item.

UNIT, DIRECT SUPPORT, AND GENERAL SUPPORT MAINTENANCE REPAIR PARTS AND SPECIAL TOOLS LISTS (RPSTL) (INCLUDING DEPOT MAINTENANCE REPAIR PARTS) INTRODUCTION - CONTINUED

0001 00

EXPLANATION OF COLUMNS IN THE REPAIR PARTS LIST AND SPECIAL TOOLS LIST WORK PACKAGES - CONTINUED

- (1) **Source Code.** The source code tells you how to get an item needed for maintenance, repair, or overhaul of an end item/equipment. Explanations of source codes follow:

<u>Code</u>	<u>Application/Explanation</u>
PA PB PC PD PE PF PG	<p>Stocked items; use the applicable NSN to request/requisition items with these source codes. They are authorized to the maintenance category indicated by the code entered in the third position of the SMR code.</p> <p style="text-align: center;"><i>Items coded PC are subject to deterioration.</i></p> <p>.....</p>
KD KF KB	<p>Items with these codes are not to be requested/requisitioned individually. They are part of a kit which is authorized to the maintenance level indicated in the third position of the SMR code. The complete kit must be requisitioned and applied.</p> <p>.....</p>
MO - Made at unit/AVUM Level MF - Made at DS/AVIM Level MH - Made at GS Level ML - Made at SRA MD - Made at Depot	<p>Items with these codes are not to be requested/requisitioned individually. They must be made from bulk materiel which is identified by the part number in the DESCRIPTION AND USABLE ON CODE (UOC) column and listed in the bulk materiel group work package of the RPSTL. If the item is authorized to you by the third position of the SMR code, but the source code indicates it is made at a higher level, order the item from the higher level of maintenance.</p> <p>.....</p>
AO-Assembled by unit/ AVUM level AF-Assembled by DS/ AVIM level AH-Assembled by GS level AL-Assembled by SRA AD-Assembled by Depot	<p>Items with these codes are not to be requested/requisitioned individually. The parts that make up the assembled item must be requisitioned or fabricated and assembled at the level of maintenance indicated by the source code. If the third position of the SMR code authorizes you to replace the item, but the source code indicates the item is assembled at a higher level, order the item from the higher level of maintenance.</p>
XA	Do not requisition an "XA" coded item. Order the next higher assembly. (Refer to NOTE below).
XB	If an item is not available from salvage, order it using the CAGEC and P/N.
XC	Installation drawings, diagrams, instruction sheets, field service drawings; identified by manufacturer's P/N.
XD	Item is not stocked. Order an SD-coded item through normal supply channels using the CAGEC and P/N given, if no NSN is available.

NOTE

Cannibalization of controlled exchange, when authorized, may be used as a source of supply for items with the above source codes, except for those source coded "XA" or those aircraft support items restricted by requirements of AR 750-1.

UNIT, DIRECT SUPPORT, AND GENERAL SUPPORT MAINTENANCE REPAIR PARTS AND SPECIAL TOOLS LISTS (RPSTL) (INCLUDING DEPOT MAINTENANCE REPAIR PARTS) INTRODUCTION - CONTINUED

0001 00

EXPLANATION OF COLUMNS IN THE REPAIR PARTS LIST AND SPECIAL TOOLS LIST WORK PACKAGES - CONTINUED

- (2) **Maintenance Code.** Maintenance codes tell you the level(s) of maintenance authorized to use and repair support items. The maintenance codes are entered in the third and fourth positions of the SMR code as follows:
 - (a) Third Position. The maintenance code entered in the third position tells you the lowest maintenance level authorized to remove, replace, and use an item. The maintenance code entered in the third position will indicate authorization to one of the following levels of maintenance:

<u>Code</u>	<u>Application/Explanation</u>
C.	Crew or Operator maintenance done within Unit/AVUM maintenance.
O	Unit Level/AVUM maintenance can remove, replace, and use the item.
F.	Direct Support/AVIM maintenance can remove, replace, and use the item.
H	General Support maintenance can remove, replace, and use the item.
L	Specialized Repair Activity (SRA) can remove, replace, and use the item.
D	Depot Maintenance can remove, replace, and use the item.

- (b) Fourth Position. The maintenance code entered in the fourth position tells you whether or not the item is to be repaired and identifies the lowest maintenance level with the capability to do complete repair (perform all authorized repair functions).

NOTE

Some limited repair may be done on the item at a lower level of maintenance, if authorized by the Maintenance Allocation Chart (MAC) and SMR codes.

<u>Code</u>	<u>Application/Explanation</u>
O	Unit/AVUM is the lowest level that can do complete repair of the item.
F.	Direct Support/AVIM is the lowest level that can do complete repair of the item.
H	General Support is the lowest level that can do complete repair of the item.
L.	Specialized Repair Activity (SRA) is the lowest level that can do complete repair of the item.
D	Depot is the lowest level that can do complete repair of the item.
Z.	Nonreparable. No repair is authorized.
B.	No repair is authorized. No parts or special tools are authorized for the maintenance of a "B"-coded item. However, the item may be reconditioned by adjusting, lubricating, etc., at the user level.

UNIT, DIRECT SUPPORT, AND GENERAL SUPPORT MAINTENANCE REPAIR PARTS AND SPECIAL TOOLS LISTS (RPSTL) (INCLUDING DEPOT MAINTENANCE REPAIR PARTS) INTRODUCTION - CONTINUED

0001 00

EXPLANATION OF COLUMNS IN THE REPAIR PARTS LIST AND SPECIAL TOOLS LIST WORK PACKAGES - CONTINUED

- (3) **Recoverability Code.** Recoverability codes are assigned to items to indicate the disposition action on unserviceable items. The recoverability code is entered in the fifth position of the SMR code as follows:

<u>Code</u>	<u>Application/Explanation</u>
Z.	Nonreparable item. When unserviceable, condemn and dispose of the item at the level of maintenance shown in the third position of the SMR code.
O	Reparable item. When uneconomically repairable, condemn and dispose of the item at the unit level maintenance.
F.	Reparable item. When uneconomically repairable, condemn and dispose of the item at Direct Support level.
H	Reparable item. When uneconomically repairable, condemn and dispose of the item at General Support level.
D	Reparable item. When beyond lower level repair capability, return to depot. Condemnation and disposal of item are not authorized below depot level.
L.	Reparable item. Condemnation and disposal of item not authorized below Specialized Repair Activity (SRA).
A	Item requires special handling or condemnation procedures because of specific reasons (e.g., precious metal content, high dollar value, critical material, or hazardous material). Refer to appropriate manuals/directives for specific instructions.

- c. **NSN - (Column 3).** The NSN for the item is listed in this column.
- d. **CAGEC (Column 4).** The Commercial and Government Entity Code (CAGEC) is a five-digit code which is used to identify the manufacturer, distributor, or Government agency/activity that supplies the item.
- e. **PART NUMBER (Column 5).** Indicates the primary number used by the manufacturer (individual, company, firm, corporation, or Government activity), which controls the design and characteristics of the item by means of its engineering drawings, specifications, standards, and inspection requirements to identify an item or range of items.

NOTE

When you use an NSN to requisition an item, the item you receive may have a different part number from the part ordered.

- f. **DESCRIPTION AND USABLE ON CODE (UOC) (Column 6).** This column includes the following information:
 - (1) The Federal item name and, when required, a minimum description to identify the item.
 - (2) P/Ns of bulk materials are referenced in this column in the line entry to be manufactured or fabricated.
 - (3) Hardness Critical Item (HCI). A support item that provides the equipment with special protection from electromagnetic pulse (EMP) damage during a nuclear attack.
 - (4) The statement END OF FIGURE appears just below the last item description in column (6) for a given figure in both the repair parts list and special tools list work packages.

UNIT, DIRECT SUPPORT, AND GENERAL SUPPORT MAINTENANCE REPAIR PARTS AND SPECIAL TOOLS LISTS (RPSTL) (INCLUDING DEPOT MAINTENANCE REPAIR PARTS) INTRODUCTION - CONTINUED

0001 00

EXPLANATION OF COLUMNS IN THE REPAIR PARTS LIST AND SPECIAL TOOLS LIST WORK PACKAGES - CONTINUED

- g. **QTY (Column 7).** The QTY (quantity per figure) column indicates the quantity of the item used in the breakout shown on the illustration/figure, which is prepared for a functional group, subfunctional group, group or an assembly. A "V" appearing in this column in lieu of a quantity indicates that the quantity is variable and the quantity may vary from application to application.

EXPLANATION OF CROSS-REFERENCE INDEXES WORK PACKAGES FORMAT AND COLUMNS

- a. **National Stock Number (NSN) Index Work Package.**
 - (1) **STOCK NUMBER Column.** This column lists the NSN by National Item Identification Number (NIIN) sequence. The NIIN consists of the last nine digits of the NSN (i.e., NSN 5305-01-674-1467). When using this column to locate an item, ignore the first four digits of the NSN. However, the complete NSN should be used when ordering items by stock number.
 - (2) **FIG. Column.** This column lists the number of the figure where the item is identified/located. The figures are in numerical order in Section II and Section III.
 - (3) **ITEM Column.** The item number identifies the item associated with the figure listed in the adjacent FIG. column. This item is also identified by the NSN listed on the same line.
- b. **Part Number (P/N) Index Work Package.** Part numbers in this index are listed in ascending alphanumeric sequence (i.e., vertical arrangement of letter and number combination which places the first letter or digit of each group in order A through Z, followed by the numbers 0 through 9 and each following letter or digit in like order).
 - (1) **PART NUMBER Column.** Indicates the P/N assigned to the item.
 - (2) **FIG. Column.** This column lists the number of the figure where the item is identified/located in the repair parts list and special tools list work packages.
 - (3) **ITEM Column.** The item number is the number assigned to the item as it appears in the figure referenced in the adjacent figure number column.

SPECIAL INFORMATION

- a. **Usable On Code (UOC).** The UOC appears in the lower left corner of the DESCRIPTION column heading. Usable on codes are shown as "UOC:" in the Description Column (justified left) on the first line under the applicable item/nomenclature. Uncoded items are applicable to all models. Identification of the UOC's used in the RPSTL are:

<u>Code</u>	<u>Used On</u>
5A3	Model M915A3

- b. **Fabrication Instructions.** Bulk materials required to manufacture items are listed in the Bulk Materiel functional group of this RPSTL. Part numbers for bulk materiel are also referenced in the Description Column of the line item entry for the item to be manufactured/fabricated. Detailed fabrication instructions for items source coded to be manufactured or fabricated are found in TM 9-2320-302-20.
- c. **Index Numbers.** Items which have the word BULK in the figure column will have an index number shown in the item number column. This index number is a cross-reference between the NSN/P/N Index work package and the bulk materiel list in the repair parts list work package.

UNIT, DIRECT SUPPORT, AND GENERAL SUPPORT MAINTENANCE REPAIR PARTS AND SPECIAL TOOLS LISTS (RPSTL) (INCLUDING DEPOT MAINTENANCE REPAIR PARTS) INTRODUCTION - CONTINUED

0001 00

SPECIAL INFORMATION - CONTINUED

- d. **Associated Publications.** The publication(s) listed below pertain to the M915A3 and their components:

Publication	Short Title
TM 9-2320-302-10	Operator's Manual for M915A3
TM 9-2320-302-20	Unit Maintenance Manual for M915A3
TM 9-2320-302-34	Direct Support and General Support Maintenance Manual for M915A3

HOW TO LOCATE REPAIR PARTS

- a. **When National Stock Numbers or Part Numbers are Not Known:**

- (1) **First.** Using the Table of Contents, determine the assembly group to which the item belongs. This is necessary since figures are prepared for assembly groups and subassembly groups, and listings are divided into the same groups.
- (2) **Second.** Find the figure covering the assembly group or subassembly group to which the item belongs.
- (3) **Third.** Identify the item on the figure and note the number(s).
- (4) **Fourth.** Look in the repair parts list work packages for the figure and item numbers. The NSNs and part numbers are on the same line as the associated item numbers.

- b. **When National Stock Number is Known:**

- (1) **First.** If you have the NSN, look in the STOCK NUMBER column of the NSN index work package. The NSN is arranged in NIIN sequence. Note the figure and item number next to the NSN.
- (2) **Second.** Turn to the figure and locate the item number. Verify that the item is the one you are looking for.

- c. **When Part Number is Known.**

- (1) **First.** If you have the P/N and not the NSN, look in the PART NUMBER column of the P/N index work package. Identify the figure and item number.
- (2) **Second.** Look up the item on the figure in the applicable repair parts list work package.

ABBREVIATIONS

For standard abbreviations see MIL-STD-12D, *Military Standard Abbreviations for Use on Drawings, Specifications, Standards, and in Technical Documents.*

<u>Abbreviations</u>	<u>Explanation</u>
NIIN	National Item Identification Number (consists of the last 9 digits of the NSN)
RPSTL	Repair Parts and Special Tools Lists
SMR	Source, Maintenance, and Recoverability Code
TMDE	Test, Measurement, and Diagnostic Equipment

This Page Intentionally Left Blank.

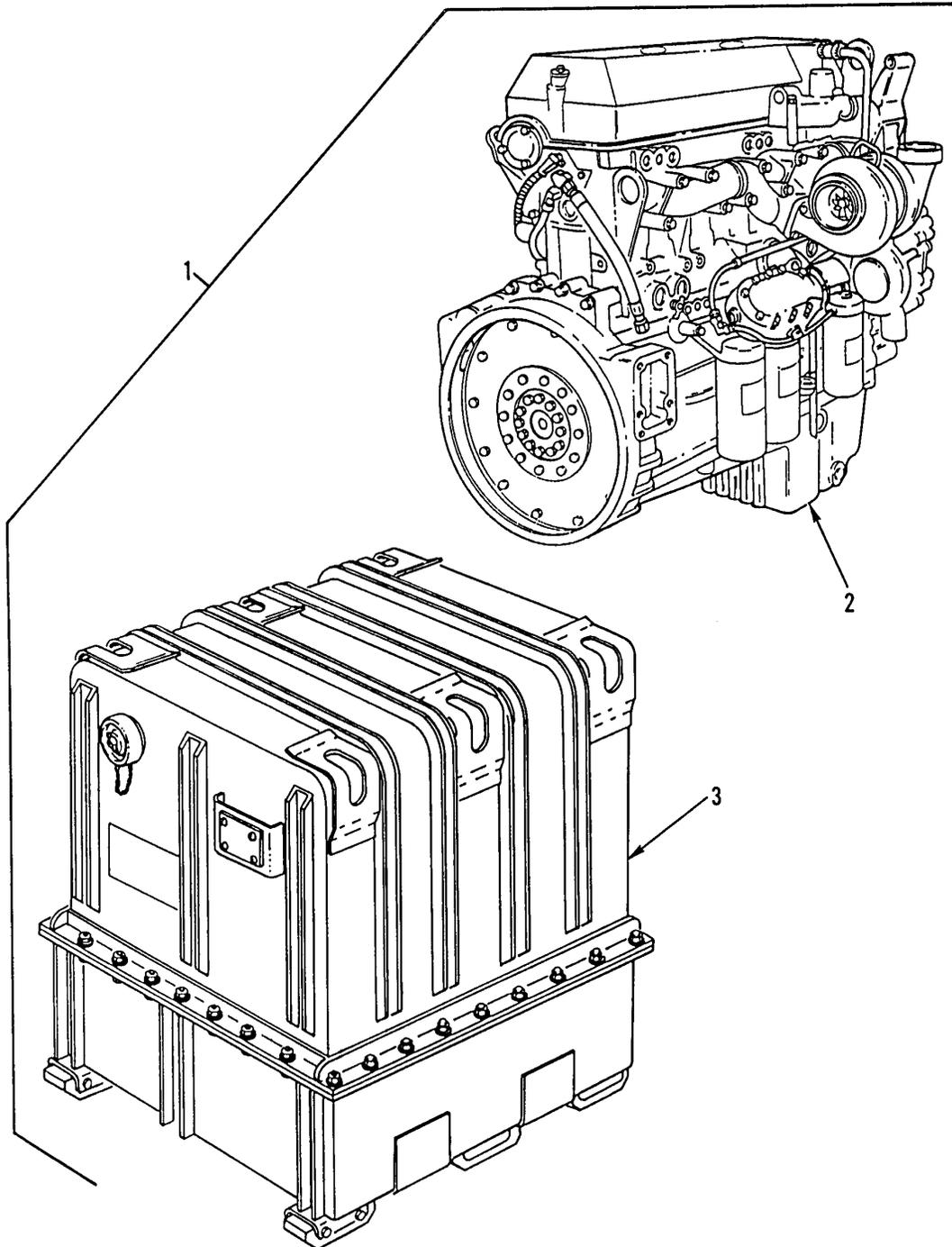

342-1279

Figure 1. Dressed Engine and Container

SECTION II			TM9-2320-302-24P			
(1)	(2)	(3)	(4)	(5)	(6)	(7)
ITEM	SMR			PART		
NO	CODE	NSN	CAGEC	NUMBER	DESCRIPTION AND USABLE ON CODES(UOC)	QTY
					GROUP 01 ENGINE	
					GROUP 0100 ENGINE ASSEMBLY	
					FIG. 1 DRESSED ENGINE AND CONTAINER	
1	PAFHD	2815014794199	19207	57K1748	ENGINE,DIESEL DIESEL ENGINE PN:	1
					12466361 (19207) (ENG. & CONTAINER).	
2	XAFHH		19207	12478859.	.ENGINE,DIESEL INCLUDES STARTER	1
					ASSEMBLY,GOVERNOR ASSEMBLY,SERIES	
					60 DIESEL ENGINE W/DDEC IV.....	
3	PFFFF	8115013492459	19207	12389942	.BOX,SHIPPING SEE FIG 238 FOR	1
					BRAKEDOWN.....	
					END OF FIGURE	

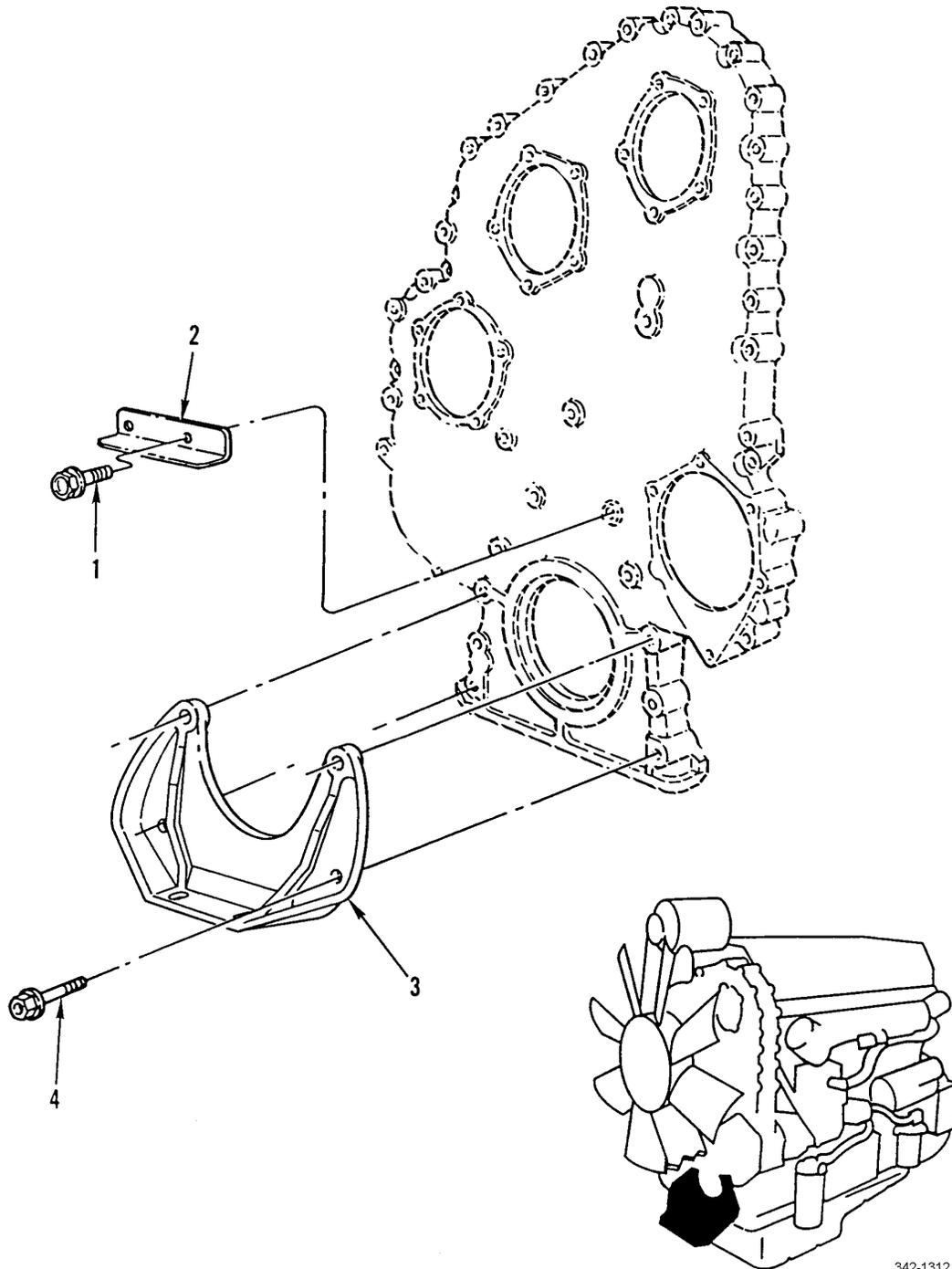
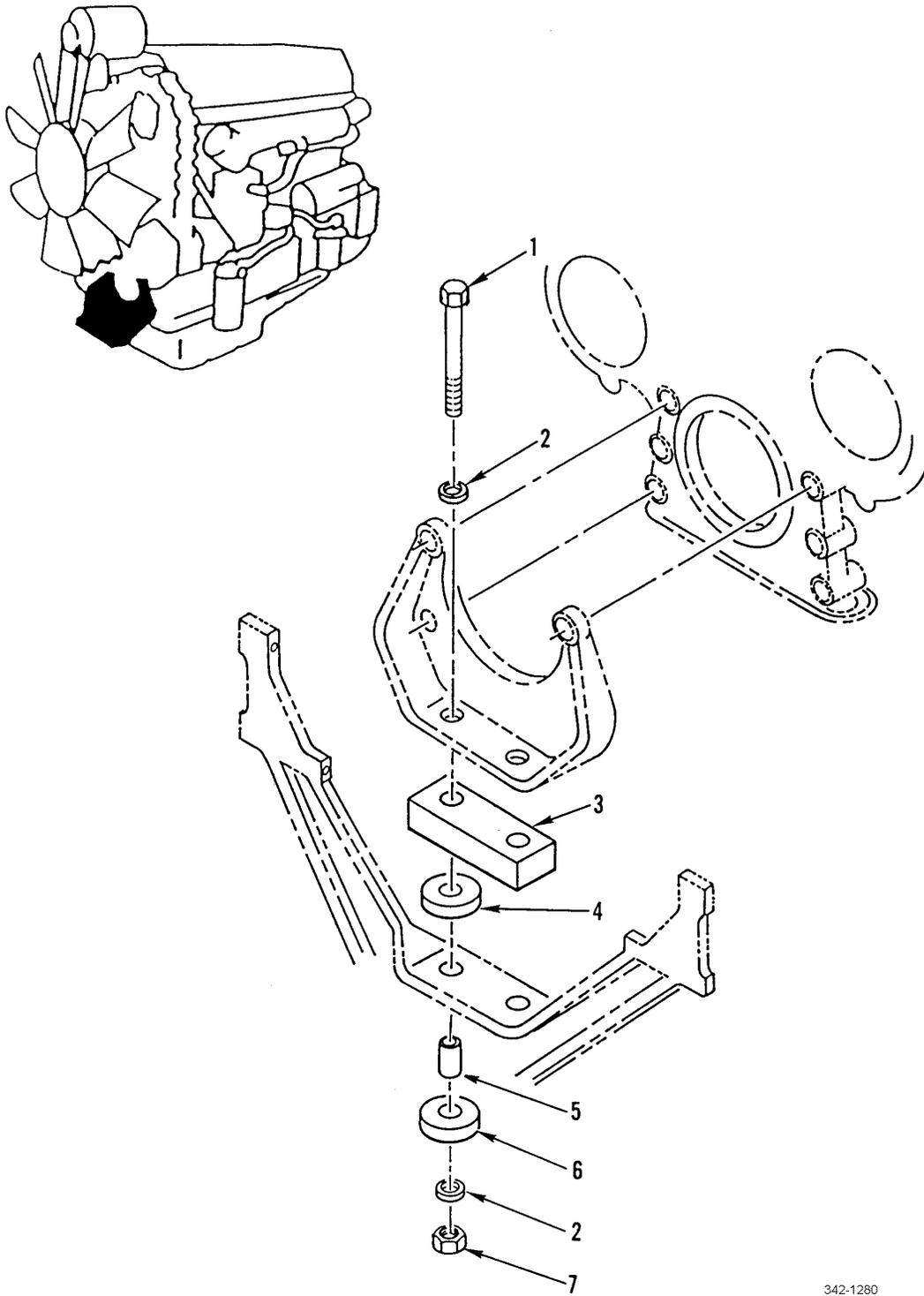

Figure 2. Front Engine Support

SECTION II			TM9-2320-302-24P			
(1)	(2)	(3)	(4)	(5)	(6)	(7)
ITEM	SMR			PART		
NO	CODE	NSN	CAGEC	NUMBER	DESCRIPTION AND USABLE ON CODES(UOC)	QTY
					GROUP 0100 ENGINE ASSEMBLY	
					FIG. 2 FRONT ENGINE SUPPORT	
1	PAFZZ	5306011857051	11862	11504986	BOLT,MACHINE M8 X 1.25 X 14-6G, GR9.8.....	2
2	XDFZZ	5340013555411	72582	23507422	BRACKET,ANGLE.....	1
3	PPFZZ	2510013208289	72582	8929744	BRACKET,ENGINE MOUN.....	1
4	PAFZZ	5305013199882	72582	8929068	SCREW,CAP,HEXAGON H M14 X 2.0 X 140.0 LG, GR10.9.....	4

END OF FIGURE



342-1280

Figure 3. Front Engine Mounting

SECTION II			TM9-2320-302-24P			
(1)	(2)	(3)	(4)	(5)	(6)	(7)
ITEM	SMR			PART		
NO	CODE	NSN	CAGEC	NUMBER	DESCRIPTION AND USABLE ON CODES(UOC)	QTY
GROUP 0100 ENGINE ASSEMBLY						
FIG. 3 FRONT ENGINE MOUNTING						
1	PAFZZ	5305009480677	96906	MS35307-499	SCREW,CAP,HEXAGON H 5.000 X 11UNC-2A.....	2
2	PAFZZ	5310005847799	96906	MS15795-822	WASHER,FLAT .822 ID X 1.469 OD.....	4
3	PAFZZ	5365013326546	64678	01-14976-001	SPACER,PLATE.....	1
4	PAFZZ	5342013327614	76005	SSB33-1001-7	MOUNT,RESILIENT.....	2
5	PAFZZ	5365013333575	64678	01-15047-000	SPACER,SLEEVE.....	2
6	PAFZZ	5342013327615	76005	SSB33-1001-8	MOUNT,RESILIENT.....	2
7	PAFZZ	5310000676356	96906	MS51922-57	NUT,SELF-LOCKING,HE 3/4-10UNC.....	2

END OF FIGURE

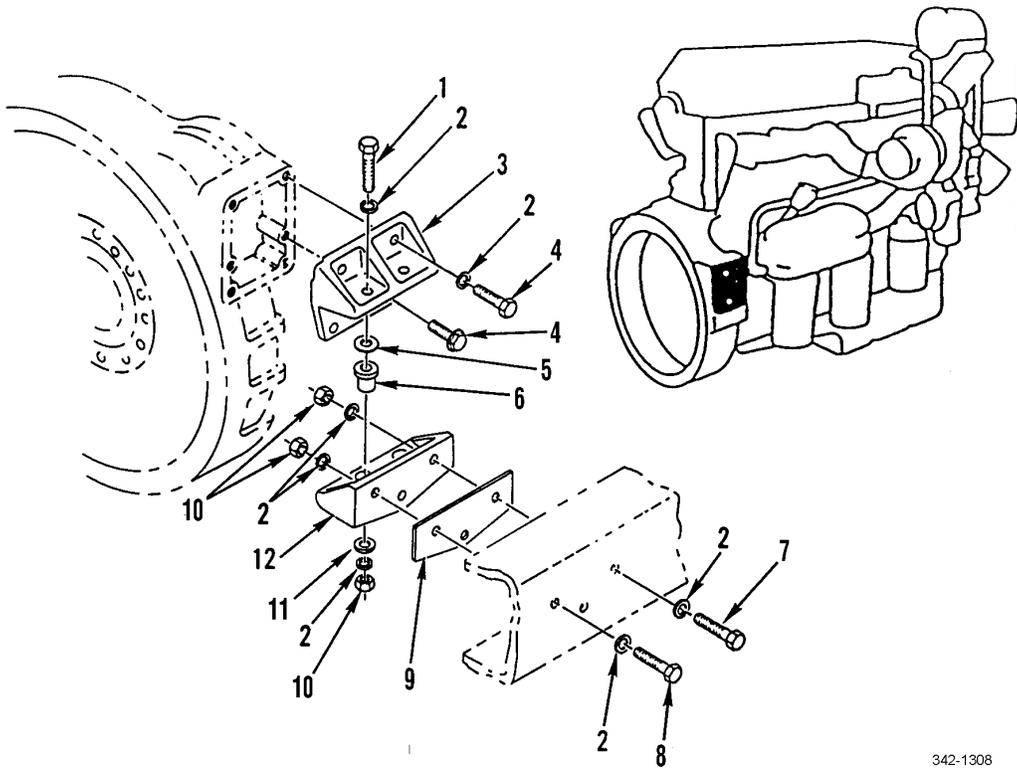

342-1308

Figure 4. Rear Engine Mounting

SECTION II			TM9-2320-302-24P			
(1)	(2)	(3)	(4)	(5)	(6)	(7)
ITEM	SMR			PART		
NO	CODE	NSN	CAGEC	NUMBER	DESCRIPTION AND USABLE ON CODES(UOC)	QTY
GROUP 0100 ENGINE ASSEMBLY						
FIG. 4 REAR ENGINE MOUNTING						
1	PAFZZ	5305009432094	96906	MS35307-470	SCREW,CAP,HEXAGON H 3.500 X 11UNC-2A.....	4
2	PAFZZ	5310007208819	96906	MS15795-821	WASHER,FLAT.....	24
3	PAFZZ	5340013336039	64678	01-20753-000	BRACKET,T.....	2
4	PAFZZ	5305009413580	96906	MS35307-464	SCREW,CAP,HEXAGON H 5/8-11UNC X 2.00,GR8/8.2.....	4
5	PAFZZ	5310013334537	64678	01-20963-000	WASHER,FLAT ENG MTG 2.750 OD X .656 ID X .120 THK.....	4
6	PAFZZ	5342013357854	76005	CBA24-650-17	MOUNT,RESILIENT.....	4
7	PAFZZ	5305009257853	96906	MS35307-465	SCREW,CAP,HEXAGON H 2.250 X 11UNC-2A.....	4
8	PAFZZ	5305007247225	80204	B1821BH063C275N	SCREW,CAP,HEXAGON H 5/8-11 2.75..	2
9	PAFZZ	5365013334556	64678	01-12120-001	SPACER,PLATE.....	2
10	PAFZZ	5310002694040	96906	MS51922-49	NUT,SELF-LOCKING,HE.....	10
11	PAFZZ	5310014748462	64678	01-20963-001	WASHER,FLAT 2.50 OD X .656 ID X .120 THK.....	4
12	PAFZZ	2510013330206	64678	01-15492-000	BRACKET,ENGINE MOUN.....	2

END OF FIGURE

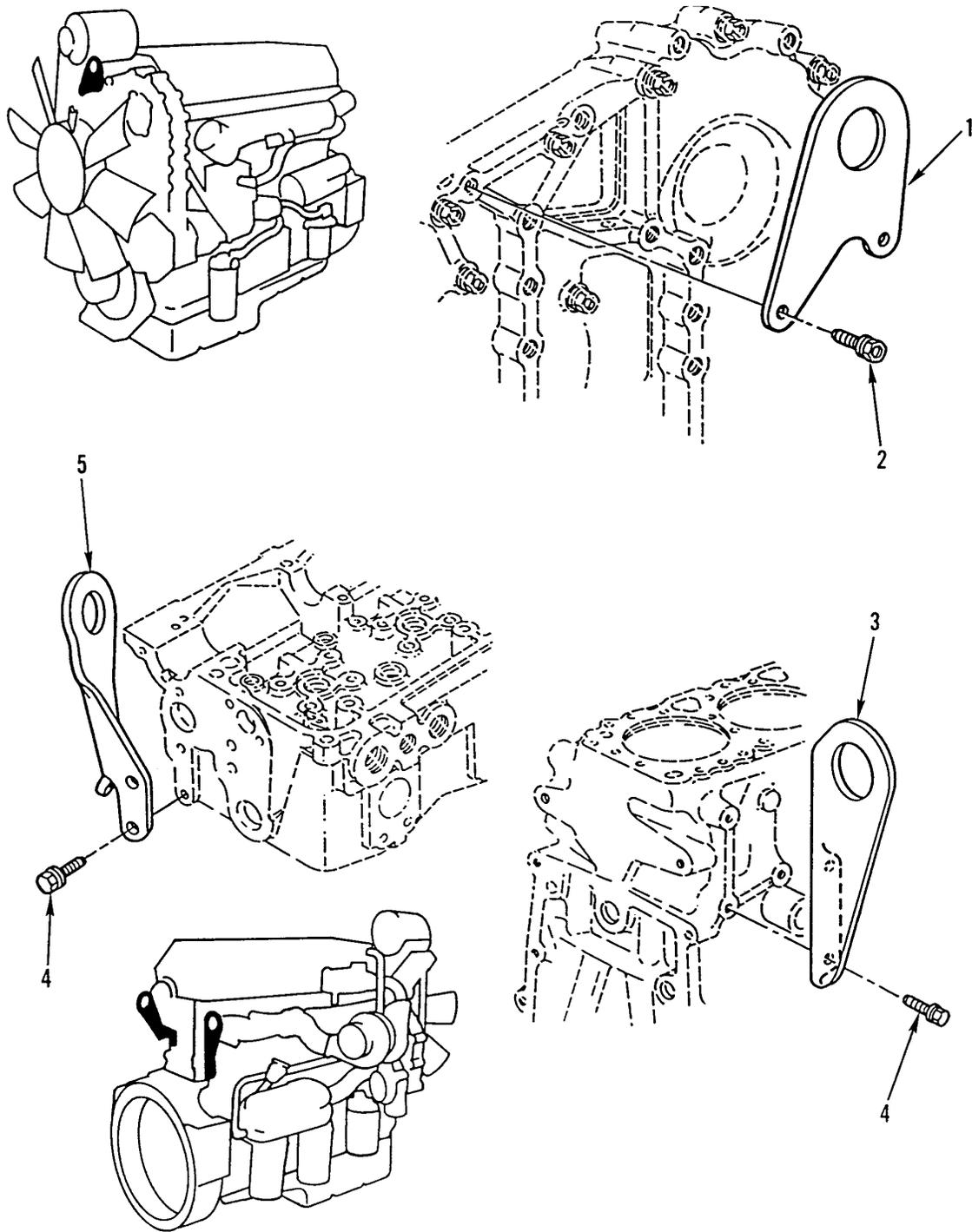

342-1436

Figure 5. Engine Lifting Brackets

SECTION II			TM9-2320-302-24P			
(1)	(2)	(3)	(4)	(5)	(6)	(7)
ITEM	SMR			PART		
NO	CODE	NSN	CAGEC	NUMBER	DESCRIPTION AND USABLE ON CODES(UOC)	QTY
GROUP 0100 ENGINE ASSEMBLY						
FIG. 5 ENGINE LIFTING BRACKETS						
1	PAFZZ	2510013208904	72582	8929754	BRACKET,ENGINE MOUN.....	1
2	PAFZZ	5305013222917	72582	11509530	SCREW,CAP,HEXAGON H M14 X 2 X 40- 6G,GR10.9.....	2
3	PAFZZ	5340013308435	72582	8929408	BRACKET,ANGLE.....	1
4	PAFZZ	5305013207157	72582	11509528	SCREW,CAP,HEXAGON H M12 X 1.75 X 30-6G,GR10.9.....	4
5	PAFZZ	2510013208903	72582	8929638	BRACKET,ENGINE MOUN.....	1

END OF FIGURE

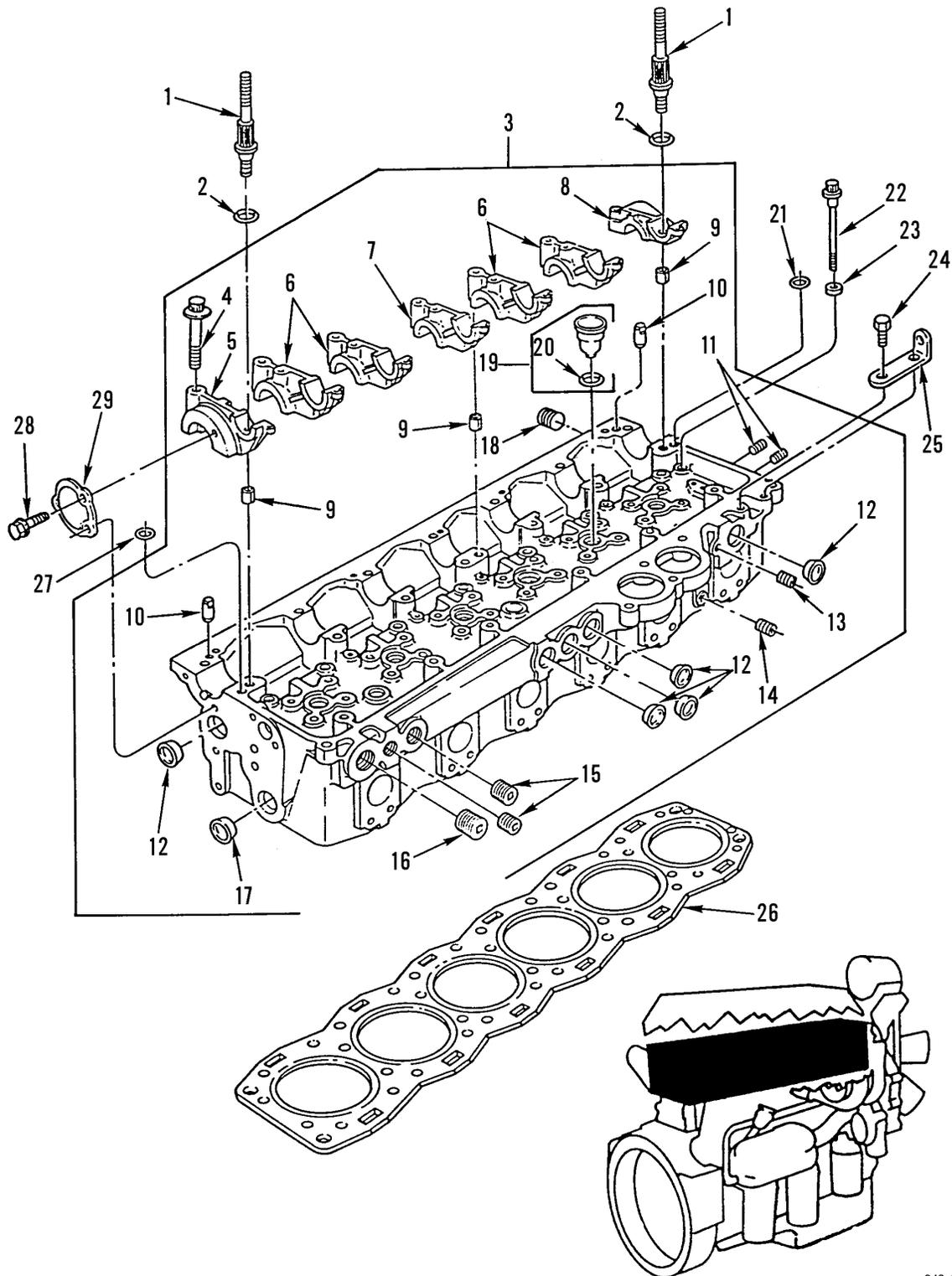
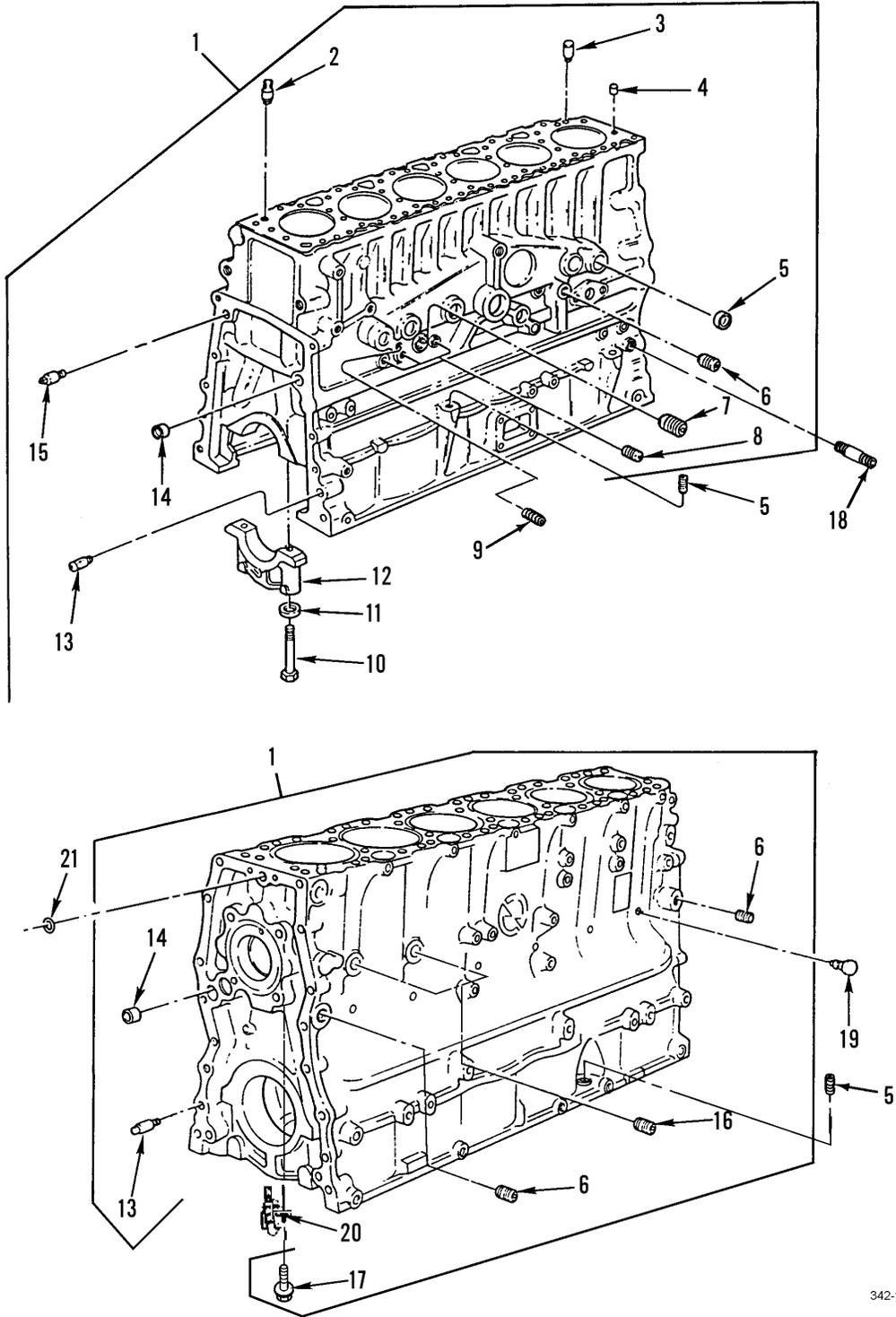

Figure 6. Cylinder Head Assembly

SECTION II			TM9-2320-302-24P			
(1)	(2)	(3)	(4)	(5)	(6)	(7)
ITEM	SMR			PART		
NO	CODE	NSN	CAGEC	NUMBER	DESCRIPTION AND USABLE ON CODES(UOC)	QTY
GROUP 0101 CRANKCASE, BLOCK, CYLINDER HEAD						
FIG. 6 CYLINDER HEAD ASSEMBLY						
1	PAFZZ	5307013308430	72582	8929588	STUD, SHOULDERED M12 X 1.75-6G/4G6 X 122, GR10.9.....	2
2	KFFZZ		72582	23521111	O-RING PART OF KIT P/N 23512691 PART OF KIT P/N 23501572.....	2
3	PGFHH		72582	23523294	CYLINDER HEAD, DIESE.....	1
4	PAFZZ	5306013210556	72582	8929129	.BOLT, MACHINE M12 X 1.75 X 65-G, GR10.9.....	7
5	XAFZZ		72582	8929739	.CAP, C/H CAMSHAFT.....	1
6	XAFZZ		72582	8929870	.CAP, C/H CAMSHAFT.....	4
7	XAFZZ		72582	8929871	.CAP, C/H CAMSHAFT.....	1
8	XAFZZ		72582	23522649	.CAP, CH CAMSHAFT.....	1
9	PFFZZ	5315000943733	72582	5138638	.PIN, SPECIAL.....	7
10	PFHZZ	5315013213220	72582	8929843	.PIN, STRAIGHT, HEADLE.....	3
11	PAFZZ		72582	23513197	.PLUG, MACHINE, THREAD.....	2
12	PAHZZ	5340009192876	72582	5109157	.PLUG, EXPANSION.....	11
13	PAFZZ	4730013987635	72582	8923847	.PLUG, PIPE.....	1
14	PFFZZ	4730012989423	72582	8926993	.PLUG, PIPE.....	1
15	PAFZZ	4730014642348	72582	23511573	.PLUG, PIPE.....	2
16	PAFZZ	4730014117532	72582	23511574	.PLUG, PIPE.....	1
17	PAHZZ	4730012416612	72582	5139991	.PLUG, PIPE.....	2
18	PAHZZ	4730012104252	72582	8923916	.PLUG, PIPE.....	2
19	PAHZZ	2910013185439	72582	23501580	.PARTS KIT, FUEL INJE.....	6
20	PAHZZ	5331001668406	81349	M83248/1-219	..O-RING.....	6
21	KFFZZ		72582	23522975	SEAL PART OF KIT P/N 23512691 PART OF KIT P/N 23501572.....	1
22	PAFZZ	5305013308440	72582	8929123	SCREW, CAP, HEXAGON H M16 X 2.0 X 175-6G, GR10.9.....	38
23	PAFZZ	5310013205919	72582	8929328	WASHER, RECESSED 16.6 X 25.5 X 4.6 MM.....	38
24	PAOZZ	5306011865367	11862	11503454	BOLT, MACHINE M10X1.50 X 20-6G G10.9	2
25	PAFZZ	5340013368885	72582	8929760	BRACKET, ANGLE.....	1
26	PAFZZ		72582	23522588	GASKET PART OF KIT P/N 23512691 PART OF KIT P/N 23501572.....	1
27	PAFZZ	5330013208114	72582	8929740	PACKING, PREFORMED PART OF KIT P/N 23512691 PART OF KIT P/N 23501572...	1
28	PAFZZ	5306013213559	72582	23506222	BOLT, MACHINE M8 X 1.25 X 20-6G, GR10.9.....	3
29	XDFZZ		72582	23514716	COVER, ACCESS.....	1

END OF FIGURE



342-1438

Figure 7. Cylinder Block

SECTION II			TM9-2320-302-24P			
(1)	(2)	(3)	(4)	(5)	(6)	(7)
ITEM	SMR			PART		
NO	CODE	NSN	CAGEC	NUMBER	DESCRIPTION AND USABLE ON CODES(UOC)	QTY
					GROUP 0101 CRANKCASE, BLOCK, CYLINDER HEAD	
					FIG. 7 CYLINDER BLOCK	
1	XDHHH		72582	23517417	ENGINE BLOCK ASSEMB WITH DOWELS....	1
2	PFHZZ	5315013235661	72582	8929153	.PIN,STRAIGHT,HEADLE 20.0 MM, DIAMOND.....	1
3	PFHZZ	5315013203626	72582	8929152	.PIN,STRAIGHT,HEADLE 20 MM, CIRCULAR.....	1
4	PAHZZ	5340008419141	72582	5151272	.PLUG,PROTECTIVE,DUS.....	1
5	PAFZZ	4730012416612	72582	5139991	.PLUG,PIPE.....	5
6	PAHZZ	4730000103885	72582	8924517	.PLUG,PIPE.....	3
7	PAFZZ	4730013197471	72582	8929594	.PLUG,PIPE 3/8".....	1
8	PFOZZ		72582	23516104	.PLUG,MACHINE,THREAD.....	1
9	PAFZZ	4730011293047	72582	8922327	.PLUG,PIPE.....	5
10	PAHZZ	5305013207153	72582	8929124	.SCREW,CAP,HEXAGON H M20 X 2.5 X 173-6G,GR10.9.....	14
11	PAHZZ	5310013212444	72582	8929125	.WASHER,RECESSED 20.5 35 5.1 MM....	14
12	PFHZZ	3130013220935	72582	8929276	.HOUSING,BEARING UNI.....	7
13	PFHZZ	5315013195895	72582	8929015	.PIN,STRAIGHT,HEADLE.....	1
14	PAHZZ	5342011441937	72582	5139988	.PLUG.....	2
15	PFHZZ	5315013208883	72582	8929022	.PIN,STRAIGHT,HEADLE 16.0 MM, DIAMOND.....	2
16	PAFZZ	4730012104252	72582	8923916	.PLUG,PIPE.....	2
17	PAFZZ	5306013213559	72582	23506222	.BOLT,MACHINE.....	6
18	XDHZZ		72582	23509239	STUD M12 X 1.75 X 34.0.....	1
19	PAHZZ	5340013205174	72582	8929432	SHIELD,EXPANSION.....	6
20	PFFZZ		72582	23521375	ADAPTER,FITTING,LUB.....	6
21	PAFZZ	5330013181949	72582	23501572	GASKET AND PREFORME PART OF KIT P/N 23512691 PART OF KIT P/N 23501572...	1

END OF FIGURE

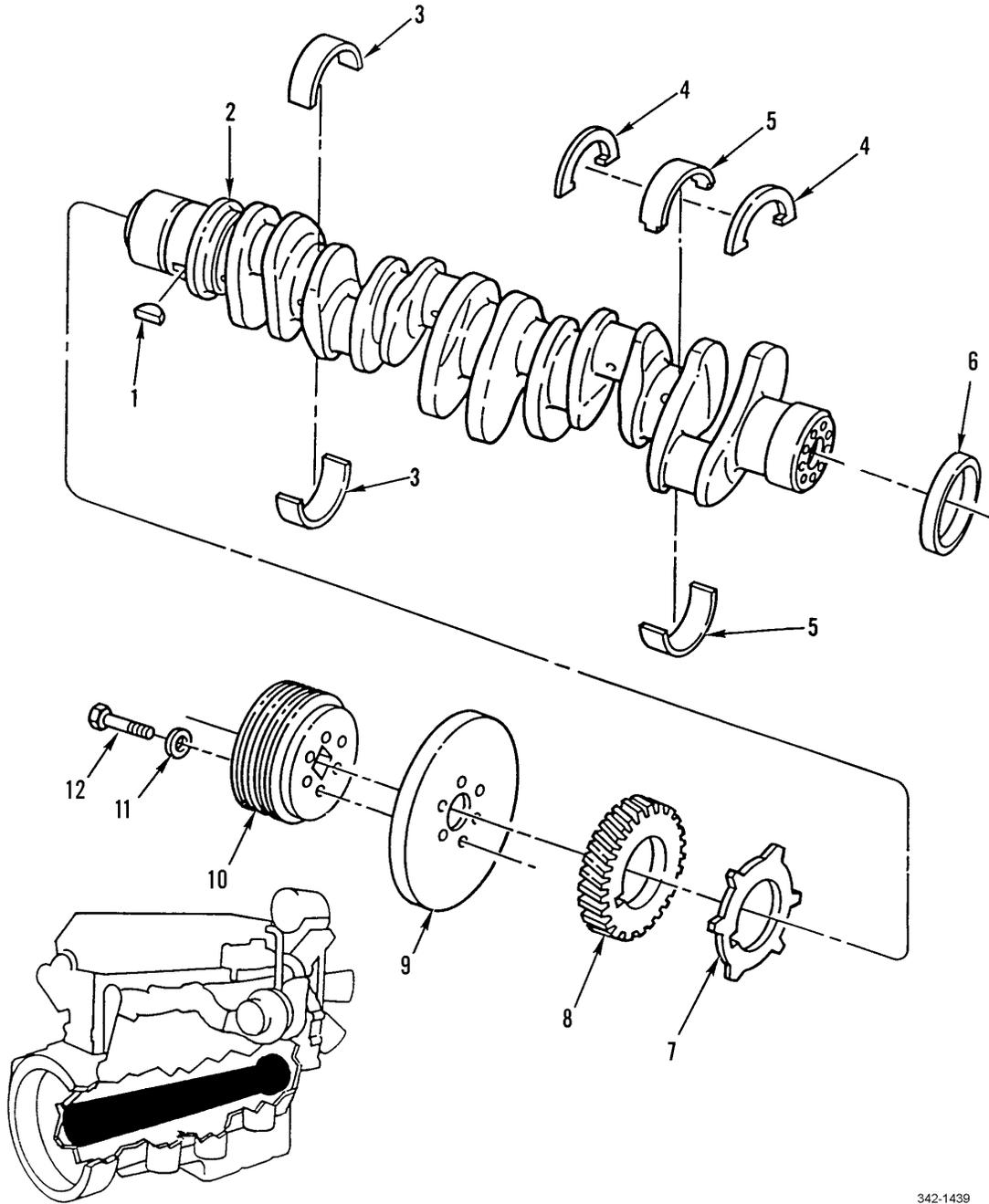

342-1439

Figure 8. Crankshaft Assembly

SECTION II			TM9-2320-302-24P			
(1)	(2)	(3)	(4)	(5)	(6)	(7)
ITEM	SMR			PART		
NO	CODE	NSN	CAGEC	NUMBER	DESCRIPTION AND USABLE ON CODES(UOC)	QTY
GROUP 0102 CRANKSHAFT						
FIG. 8 CRANKSHAFT ASSEMBLY						
1	PAHZZ	5315013192188	72582	8929808	KEY, WOODRUFF.....	1
2	XDHHH		72582	23515598	CRANKSHAFT, ENGINE.....	1
3	PAHZZ	3120013201034	72582	8929670	BEARING SET, SLEEVE STANDARD.....	6
3	PAHZZ	3120013199271	72582	8929671	BEARING SET, SLEEVE 0.254 UNDERSIZE.	V
3	PAHZZ	3120013201035	72582	8929672	BEARING SET, SLEEVE 0.508 UNDERSIZE.	V
3	PAHZZ	3120013198619	72582	8929673	BEARING SET, SLEEVE 0.762 UNDERSIZE.	V
4	PAHZZ	3120013204983	72582	8929085	BEARING, WASHER, THRU STANDARD.....	2
4	PAHZZ	3120013194879	72582	8929697	BEARING, WASHER, THRU.....	V
4	PAHZZ	3120013194880	72582	8929698	BEARING, WASHER, THRU.....	V
5	PAHZZ	3110013202310	72582	8929680	BEARING, ROLLER, THRU STANDARD.....	1
5	PAHZZ	3120013201036	72582	8929681	BEARING SET, SLEEVE 0.254 UNDERSIZE.	V
5	PAHZZ	3120013201037	72582	8929682	BEARING SET, SLEEVE 0.508 UNDERSIZE.	V
5	PAHZZ	3120013201038	72582	8929683	BEARING SET, SLEEVE 0.762 UNDERSIZE.	V
6	PAFZZ		72582	23519651	SEAL, PLAIN.....	1
7	PAHZZ	3020014410433	72582	23513537	SPROCKET WHEEL.....	1
8	PFHZZ	3020013199400	72582	8929497	GEAR, HELICAL.....	1
9	PAFZZ	2815013197851	72582	8929502	DAMPENER, VIBRATION,.....	1
10	PAFZZ	3020013311905	72582	8929077	PULLEY, GROOVE.....	1
11	PAFZZ	5310009330993	72582	5133981	WASHER, FLAT 19/32 X 1.00 X .122.118	6
12	PAFZZ	5306013232292	72582	8929222	BOLT, SELF-LOCKING 9/16-18UNF-2A X 2-1/2.....	6

END OF FIGURE

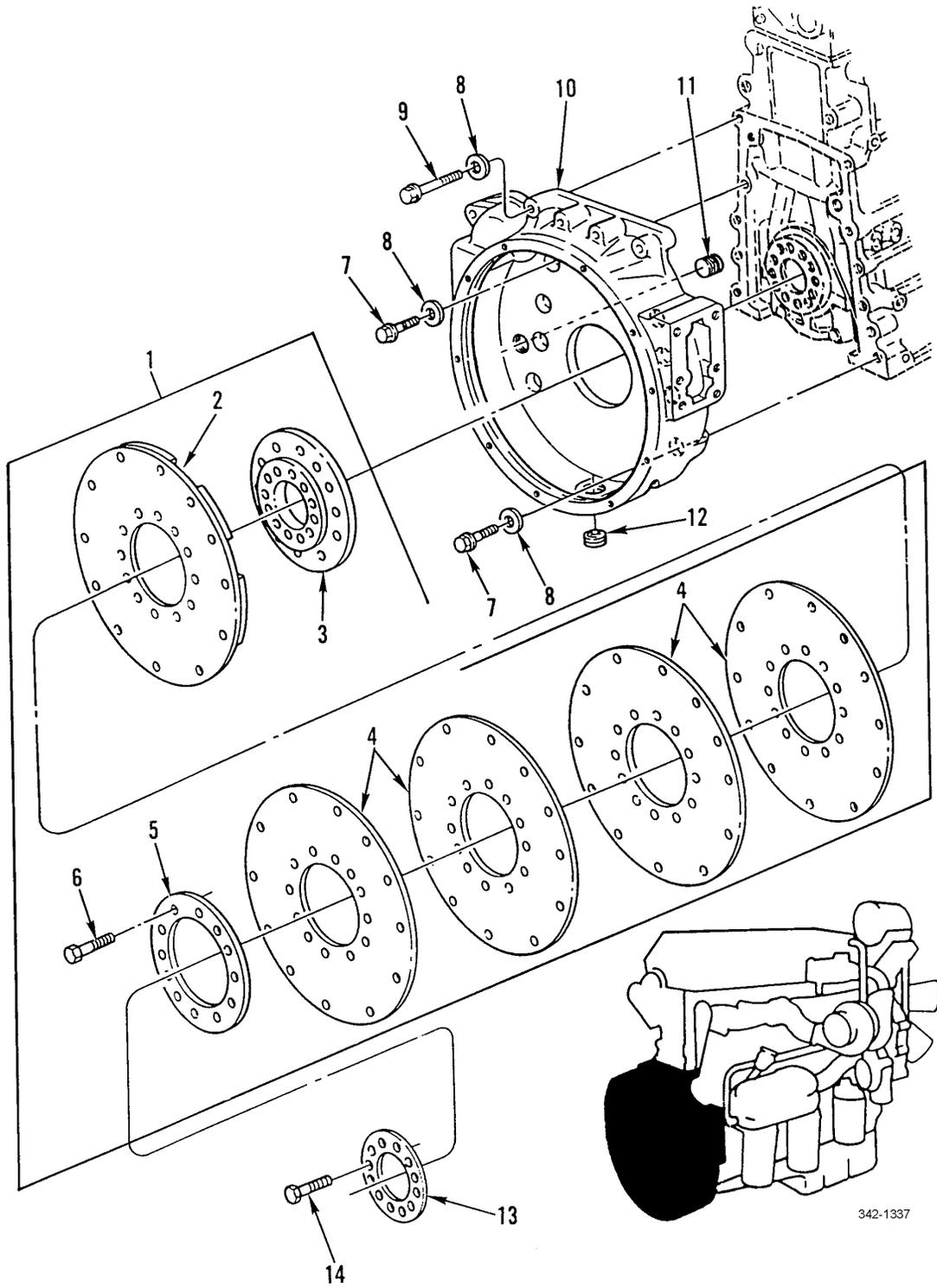

Figure 9. Flywheel Housing

SECTION II			TM9-2320-302-24P			
(1)	(2)	(3)	(4)	(5)	(6)	(7)
ITEM	SMR			PART		
NO	CODE	NSN	CAGEC	NUMBER	DESCRIPTION AND USABLE ON CODES(UOC)	QTY
GROUP 0103 FLYWHEEL ASSEMBLY						
FIG. 9 FLYWHEEL HOUSING						
1	PAFFZ	2815011616540	73342	23046428	FLYWHEEL,ENGINE.....	1
2	PAFZZ	2520003744950	73342	6751516	.DISC ASSEMBLY.....	1
3	PAFZZ	3040013062646	72582	23045507	.HUB,BODY.....	1
4	PAFZZ	3010003744940	73342	6750468	.INSERT,FLEXIBLE COU FOUR PLATES...	4
5	PAFZZ	2520008875522	73342	6753364	.PLATE,MOUNTING.....	1
6	PAFZZ	5306006381936	73342	9409056	.BOLT,MACHINE 1/2-20UNF-2A X 3/4...	12
7	XDHZZ		72582	23522327	SCREW,CAP,HEXAGON H M14 X 2.0 X 50, GR10.9.....	8
8	XDHZZ		72582	23522326	WASHER,FLAT M14.....	12
9	XDHZZ		72582	23522329	SCREW,CAP,HEXAGON H M14 X 2.0 90MM.	4
10	PFHZZ		72582	23522643	HOUSING,FLYWHEEL.....	1
11	XDFZZ		72582	23514442	PLUG,MACHINE,THREAD 1-1/4-11.5NPTF, 0.761 SQ RECESS.....	1
12	PAFZZ	4730014117532	72582	23511574	PLUG,PIPE 1-11.5NPTF, 0.511SQ RECESS.....	1
13	PAFZZ	2815010822134	72582	5100532	PLATE,FLYWHEEL SCUF.....	1
14	PAFZZ	5306013214903	72582	8929805	BOLT,SELF-LOCKING 9/16-18UNF-2A X 1-1/2,GR8.....	12

END OF FIGURE

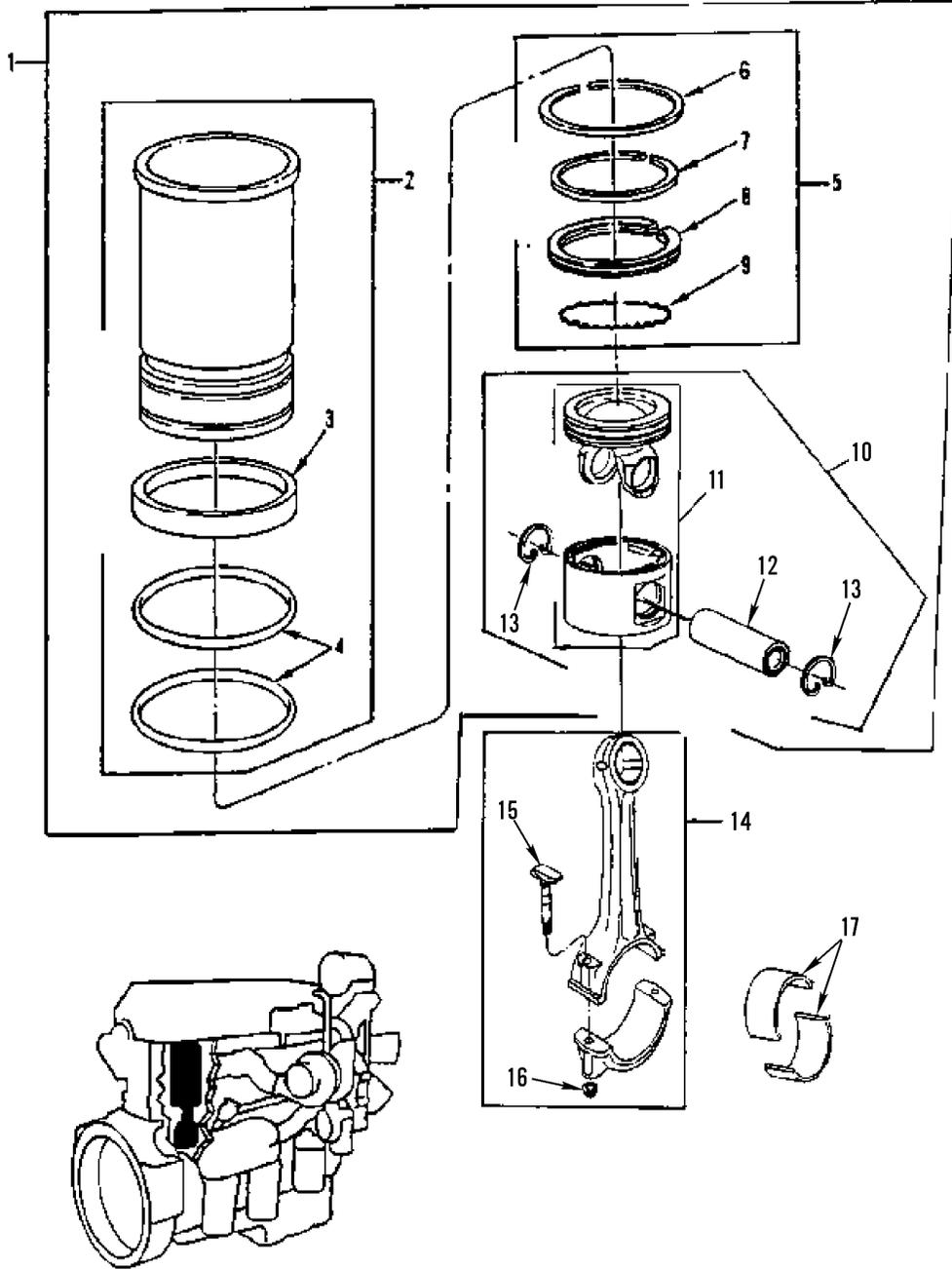
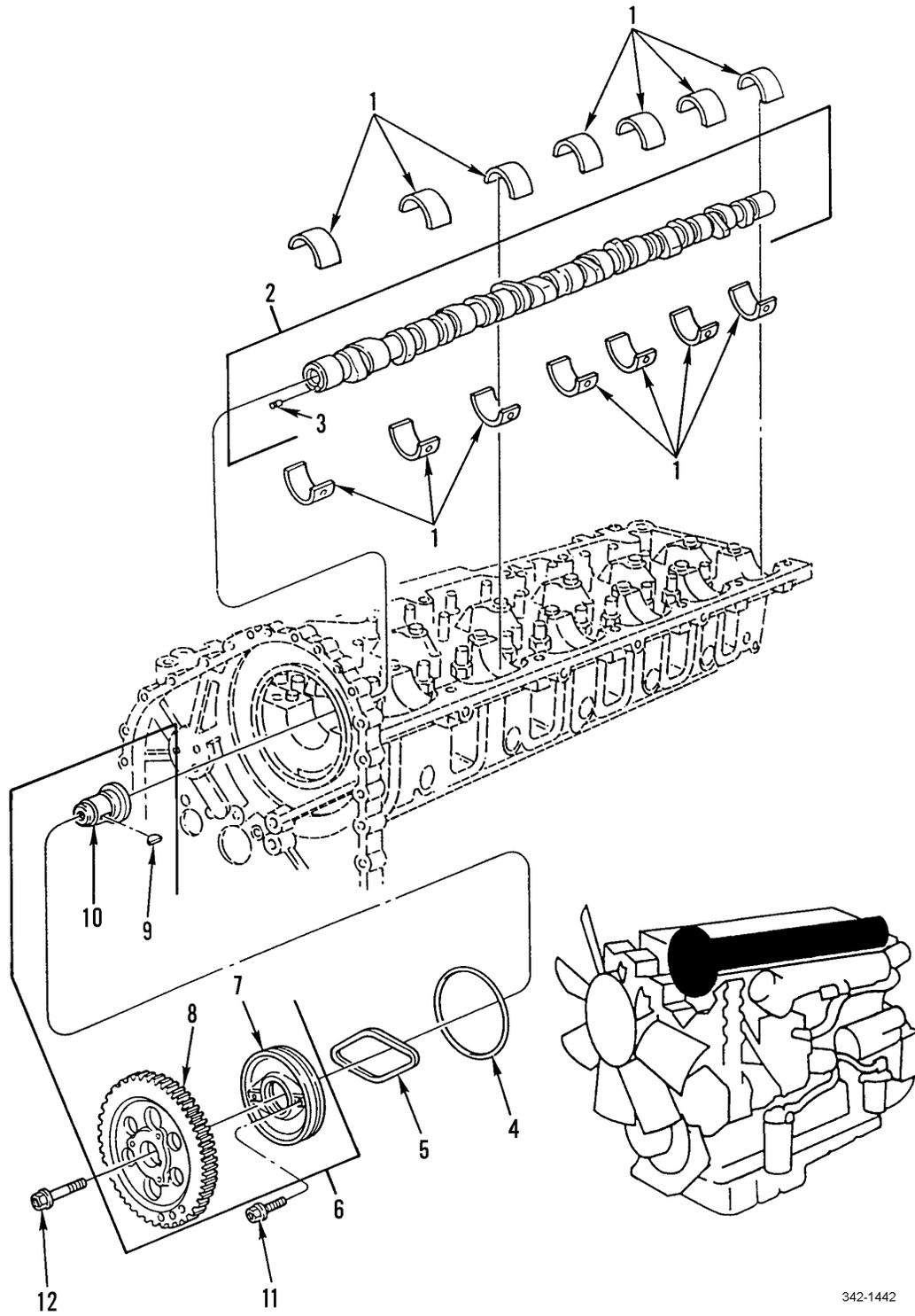

Figure 10. Rod, Piston and Pin

SECTION II			TM9-2320-302-24P			
(1)	(2)	(3)	(4)	(5)	(6)	(7)
ITEM	SMR			PART		
NO	CODE	NSN	CAGEC	NUMBER	DESCRIPTION AND USABLE ON CODES(UOC)	QTY
GROUP 0104 PISTONS AND CONNECTING RODS						
FIG. 10 ROD, PISTON AND PIN						
1	PAHZZ		72582	23524596	CYLINDER SLEEVE AND.....	6
2	PAHZZ	2815014148485	72582	23523948	.LINER, COMBUSTION CH.....	1
3	PAHZZ	5331013212160	72582	8929013	..O-RING.....	1
4	PAHZZ	5330013204926	72582	8929176	..PACKING, PREFORMED.....	2
5	PAHZZ		72582	23525553	.RING SET, PISTON.....	1
6	XAHZZ		72582	23522713	..RING COMP TOP PISTO.....	1
7	XAHZZ		72582	8929845	..RING COMP CENTER.....	1
8	XAHZZ		72582	23515500	..RING, OIL CONTROL.....	1
9	XAHZZ		72582	23515499	..EXPANDER, OIL RING.....	1
10	PBHZZ		72582	23524597	.PISTON, INTERNAL COM.....	1
11	XAHZZ		72582	23524098	..DOME & SKIRT ASSY.....	1
12	XAHZZ		72582	23521649	..PIN, PISTON.....	1
13	PAHZZ		72582	23521781	..RING, RETAINING.....	2
14	XDHZZ		72582	23523195	CONNECTING ROD, PIST.....	6
15	PAHZZ	5306013204894	72582	8929355	.BOLT, MACHINE MJS14 X 1.5 X 108-6G, GR10.9.....	2
16	PAHZZ	5310013212421	72582	8929019	.NUT, PLAIN, EXTENDED MJS14 X 1.5....	2
17	PAHZZ	3120014813139	72582	23523935	BEARING SET, SLEEVE.....	6

END OF FIGURE



342-1442

Figure 11. Camshaft Assembly

SECTION II			TM9-2320-302-24P			
(1)	(2)	(3)	(4)	(5)	(6)	(7)
ITEM	SMR			PART		
NO	CODE	NSN	CAGEC	NUMBER	DESCRIPTION AND USABLE ON CODES(UOC)	QTY
GROUP 0105 VALVES, CAMSHAFTS, AND TIMING SYSTEM						
FIG. 11 CAMSHAFT ASSEMBLY						
1	PAHZZ	3110013202309	72582	8929690	BEARING,ROLLER,CYLI STANDARD.....	7
1	PAHZZ	3120013342776	72582	8929691	BEARING HALF SET,SL 0.254 OVERSIZE.	7
1	PAHZZ	3120013349614	72582	8929695	BEARING HALF SET,SL 0.508 OVERSIZE.	7
1	PAHZZ	3120013342777	72582	8929693	BEARING HALF SET,SL 0.762 OVERSIZE.	7
2	XDFZZ		72582	E23524912	CAMSHAFT,ENGINE EXCHANGE THIS ITEM.	1
3	XDFZZ		72582	8920172	.PIN,STRAIGHT,HEADLE.....	1
4	PAHZZ	5330013347187	72582	8929318	SEAL,PLAIN PART OF KIT P/N 23512691.	1
5	PAHZZ		72582	23521894	GASKET PART OF KIT P/N 23512691 PART OF KIT P/N 23501572.....	1
6	PPFHH		72582	23521895	GEAR AND SHAFT ASSE.....	1
7	XAHZZ		72582	23521892	.PLATE,RETAINING,SHA.....	1
8	PFHZZ	3020013199401	72582	8929379	.GEAR,HELICAL.....	1
9	PFHZZ	5315013192189	72582	8929810	.KEY,WOODRUFF.....	1
10	XDHZZ		72582	23524883	.HUB,BODY.....	1
11	PAFZZ	5305013199881	72582	11504822	SCREW,CAP,HEXAGON H M8 X 1.25 X 30- 6G,GR10.9.....	3
12	XDFZZ		72582	23524882	SCREW,CAP,HEXAGON H M20 X 100-6G, GR10.9.....	1

END OF FIGURE

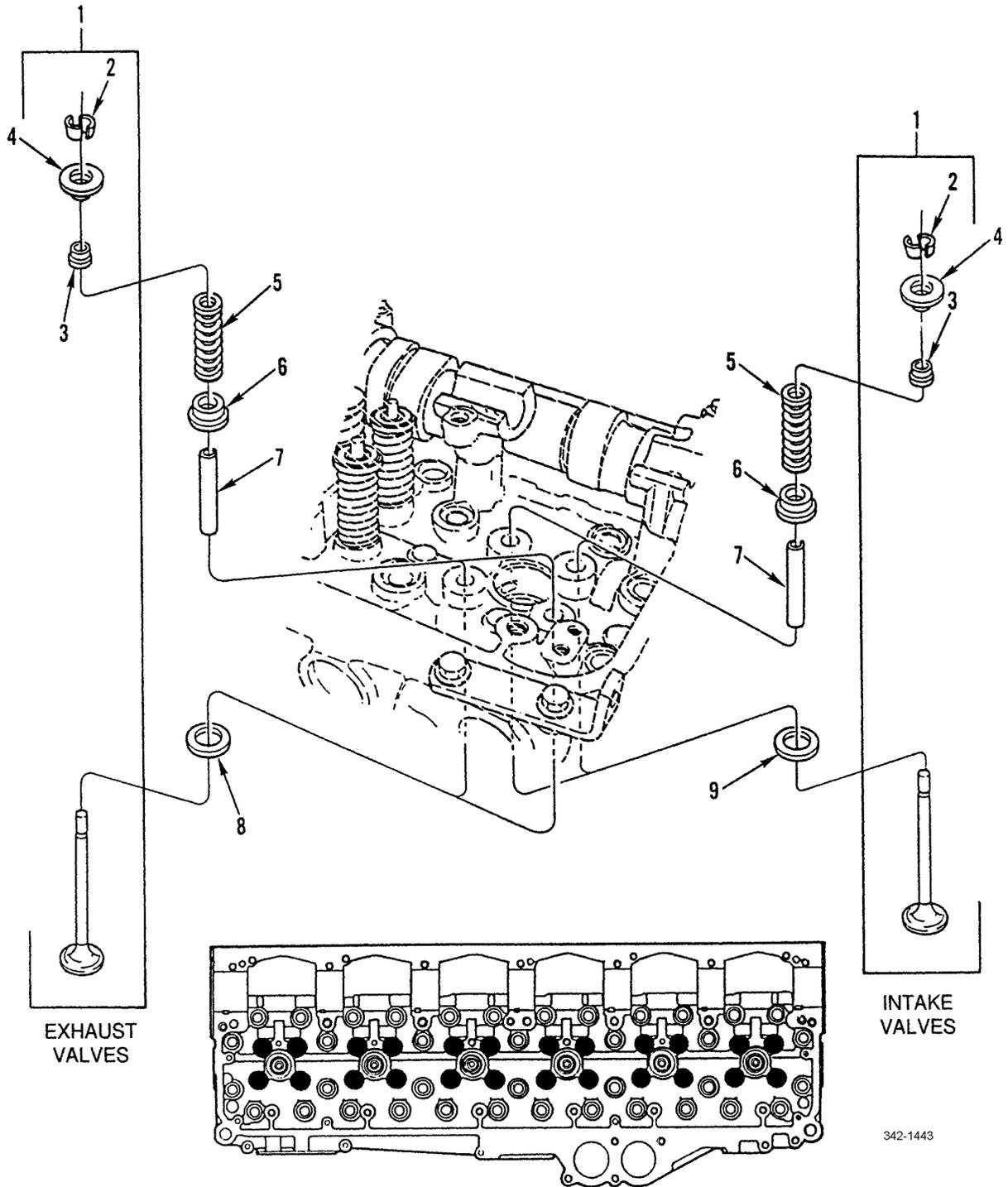

EXHAUST VALVES

INTAKE VALVES

342-1443

Figure 12. Intake and Exhaust Valves

SECTION II			TM9-2320-302-24P			
(1)	(2)	(3)	(4)	(5)	(6)	(7)
ITEM	SMR			PART		
NO	CODE	NSN	CAGEC	NUMBER	DESCRIPTION AND USABLE ON CODES(UOC)	QTY
GROUP 0105 VALVES, CAMSHAFTS, AND TIMING SYSTEM						
FIG. 12 INTAKE AND EXHAUST VALVES						
1	PAHZZ	2815013188471	72582	23501576	PARTS KIT,ENGINE PO INTAKE.....	12
1	PAHZZ	2815014153248	72582	23507504	VALVE,POPPET,ENGINE EXHAUST.....	12
2	PAHZZ	2815013382566	06789	0984-C	.LOCK,VALVE SPRING R.....	2
3	PAHZZ		72582	23523930	.GASKET.....	1
4	PAHZZ	2815013226694	31033	3240-RO-674-99	.ROTOR,ENGINE POPPET.....	24
5	PAHZZ	5360013203689	72582	8929415	SPRING,HELICAL,COMP.....	24
6	PAHZZ	5340013222747	72582	8929076-B	SEAT,HELICAL COMPRE 2.2 - 2.4MM....	24
6	PAHZZ	5340013194908	72582	8929634-ND	RETAINER,HELICAL CO 2.45 - 2.65MM..	V
6	PAHZZ	5340013238363	72582	8929635-ND	RETAINER,HELICAL CO 2.70 - 2.90MM..	V
6	PAHZZ	5310013197295	72582	8929636	WASHER,SHOULDERED 2.95 - 3.15MM....	V
7	PAHZZ	2815013231353	72582	8929631	GUIDE,ENGINE POPPET.....	24
8	PAHZZ	2815013229163	72582	8929126	INSERT,ENGINE VALVE 6.261 - 6.363MM	12
8	PAHZZ	2815013578737	72582	8929628	INSERT,ENGINE VALVE 6.007 - 3.109MM	6
8	PAHZZ	2815013560764	72582	8929629	INSERT,ENGINE VALVE 5.753 - 5.855MM	6
8	PAHZZ	2815013560765	72582	8929630	INSERT,ENGINE VALVE 5.499 - 5.601MM	6
9	PAHZZ	2815013229164	72582	8929127	INSERT,ENGINE VALVE 7.155 - 7.257MM	12
9	PAHZZ	2815013560766	72582	8929625	INSERT,ENGINE VALVE 6.901 - 7.003MM	6
9	PAHZZ	2815013560767	72582	8929626	INSERT,ENGINE VALVE 6.647 - 6.749MM	6
9	PAHZZ	2815013562668	72582	8929627	INSERT,ENGINE VALVE 6.393 - 6.495MM	6

END OF FIGURE

13
|
14

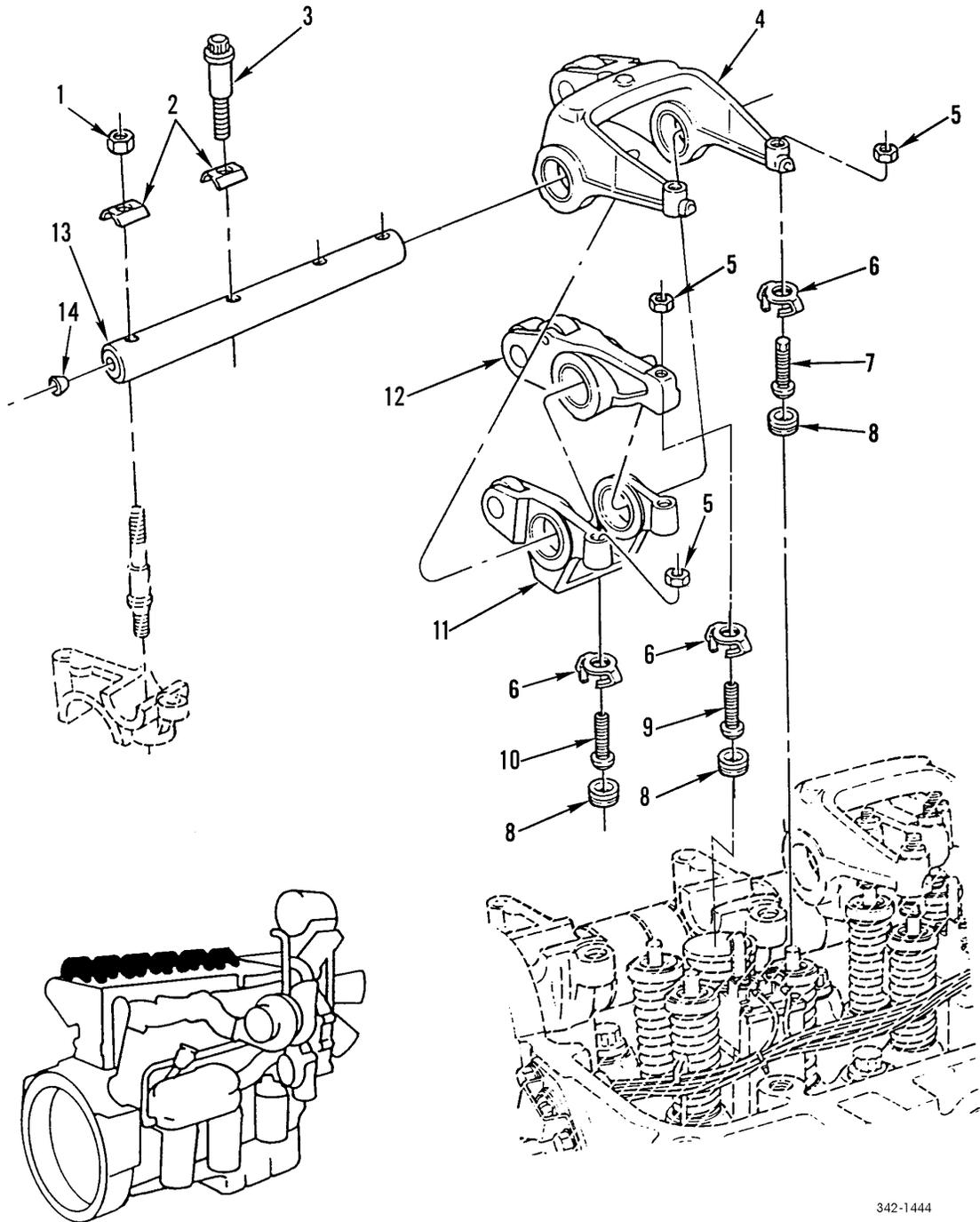

342-1444

Figure 13. Rocker Arms and Shaft Assembly

SECTION II			TM9-2320-302-24P			
(1)	(2)	(3)	(4)	(5)	(6)	(7)
ITEM NO	SMR CODE	NSN	CAGEC	PART NUMBER	DESCRIPTION AND USABLE ON CODES(UOC)	QTY
GROUP 0105 VALVES, CAMSHAFTS, AND TIMING SYSTEM						
FIG. 13 ROCKER ARMS AND SHAFT ASSEMBLY						
1	XDFZZ		72582	23500708	NUT,PLAIN,HEXAGON M12 X 1.75MM.....	2
2	PAFZZ	5365013308392	72582	8929586	SPACER,SLEEVE.....	8
3	PAFZZ	5305013308432	72582	8929587	SCREW,CAP,SOCKET HE M12 X 1.75 X 110-6G,GR10.9.....	6
4	PFFZZ		72582	23523174	ROCKER ARM,ENGINE P.....	6
5	PFFZZ		72582	23514371	NUT,PLAIN,HEXAGON .375-24UNF-3B....	30
6	PAFZZ	2815013190902	72582	23505056	ADJUSTING SCREW,INJ INTAKE VALVE... V	
7	KFFZZ		72582	23519766	SCREW,VALVE ADJUST PART OF KIT P/N 23520014.....	12
8	KFFZZ		72582	23517283	BUTTON,VALVE PART OF KIT P/N 23520013 PART OF KIT P/N 23520014...	30
9	KFFZZ		72582	8929607	SCREW,VALVE ADJUST PART OF KIT P/N 23520013.....	6
10	KFFZZ		72582	23519765	SCREW,VALVE ADJUST PART OF KIT P/N 23520013.....	18
11	PFFZZ		72582	23520644	ROCKER ARM,ENGINE P.....	6
12	PFFZZ		72582	23513939	ROCKER ARM,ENGINE P.....	6
13	PFFZZ		72582	23513530	SHAFT,STRAIGHT.....	2
14	PFFZZ	5340002311964	72582	9421745	.PLUG,PROTECTIVE,DUS.....	4

END OF FIGURE

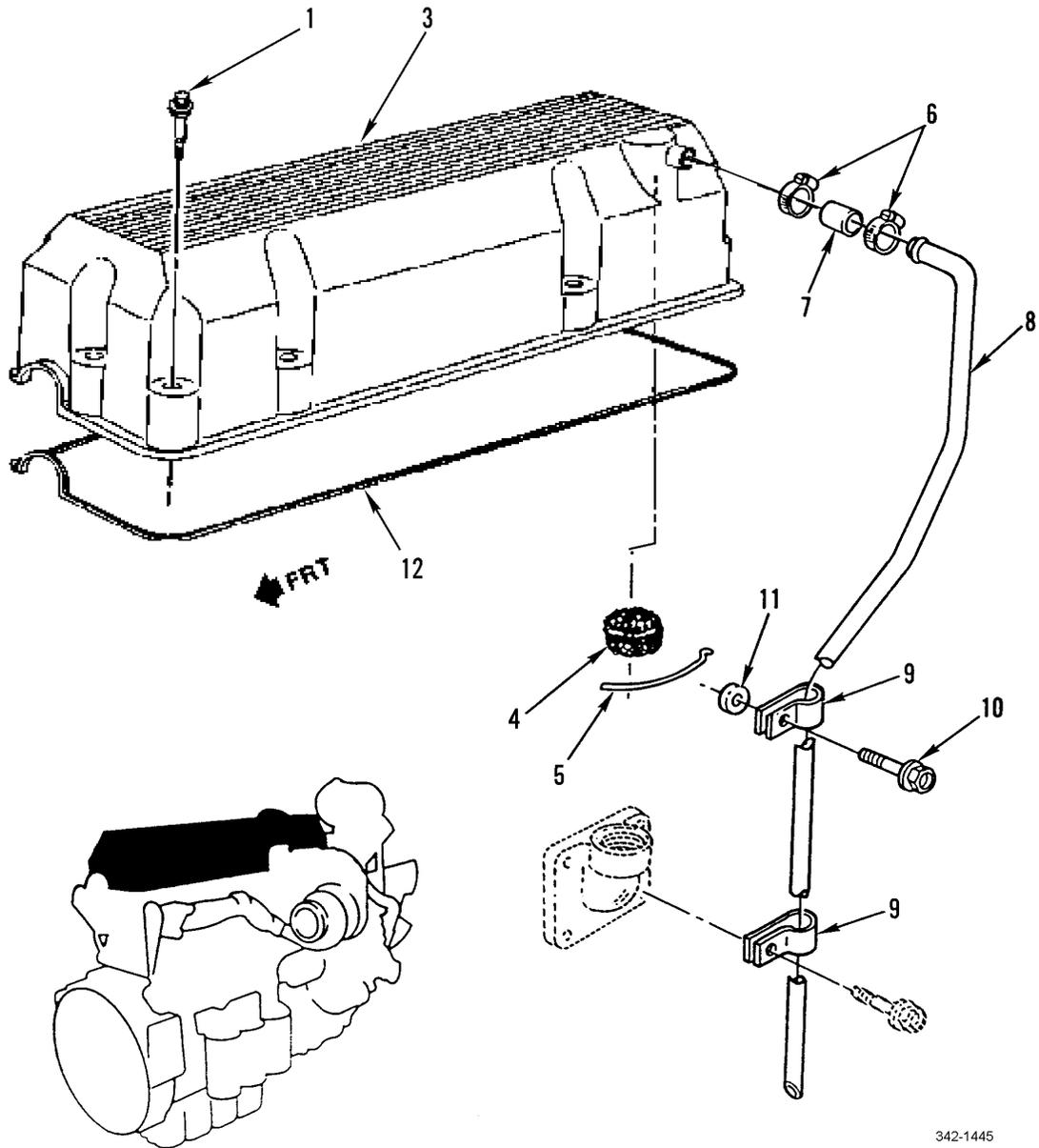
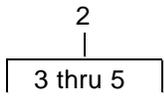

Figure 14. Rocker Cover and Breather Tube

SECTION II			TM9-2320-302-24P			
(1)	(2)	(3)	(4)	(5)	(6)	(7)
ITEM	SMR			PART		
NO	CODE	NSN	CAGEC	NUMBER	DESCRIPTION AND USABLE ON CODES(UOC)	QTY
					GROUP 0105 VALVES, CAMSHAFTS, AND TIMING SYSTEM	
					FIG. 14 ROCKER COVER AND BREATHER TUBE	
1	PAFZZ		72582	23522271	BOLT,ASSEMBLED WASH.....	10
2	PAFFF		72582	23522272	COVER,ACCESS.....	1
3	XAFZZ		72582	23522268	.COVER,ACCESS.....	1
4	PAFZZ	2940000892520	72582	5101760	.FILTERING DISK,FLUI.....	1
5	XDFZZ		72582	23523506	.STRAP,RETAINING.....	1
6	PAFZZ	4730002893141	14242	UBX-212	CLAMP,HOSE.....	2
7	PAFZZ	4720014433020	72582	23504088	HOSE,NONMETALLIC 1.120 ID X 2.50" LG.....	1
8	XDFZZ		72582	23509322	TUBE,METALLIC,BENT.....	1
9	XDFZZ		72582	23506443	CLAMP.LOOP.....	2
10	XDFZZ		72582	23511786	BOLT,MACHINE M10 X 25MM, GR10.9....	1
11	PPFZZ	5365010679583	72582	5157412	SPACER,SPECIAL.....	1
12	PAFZZ		72582	23522269	GASKET.....	1

END OF FIGURE

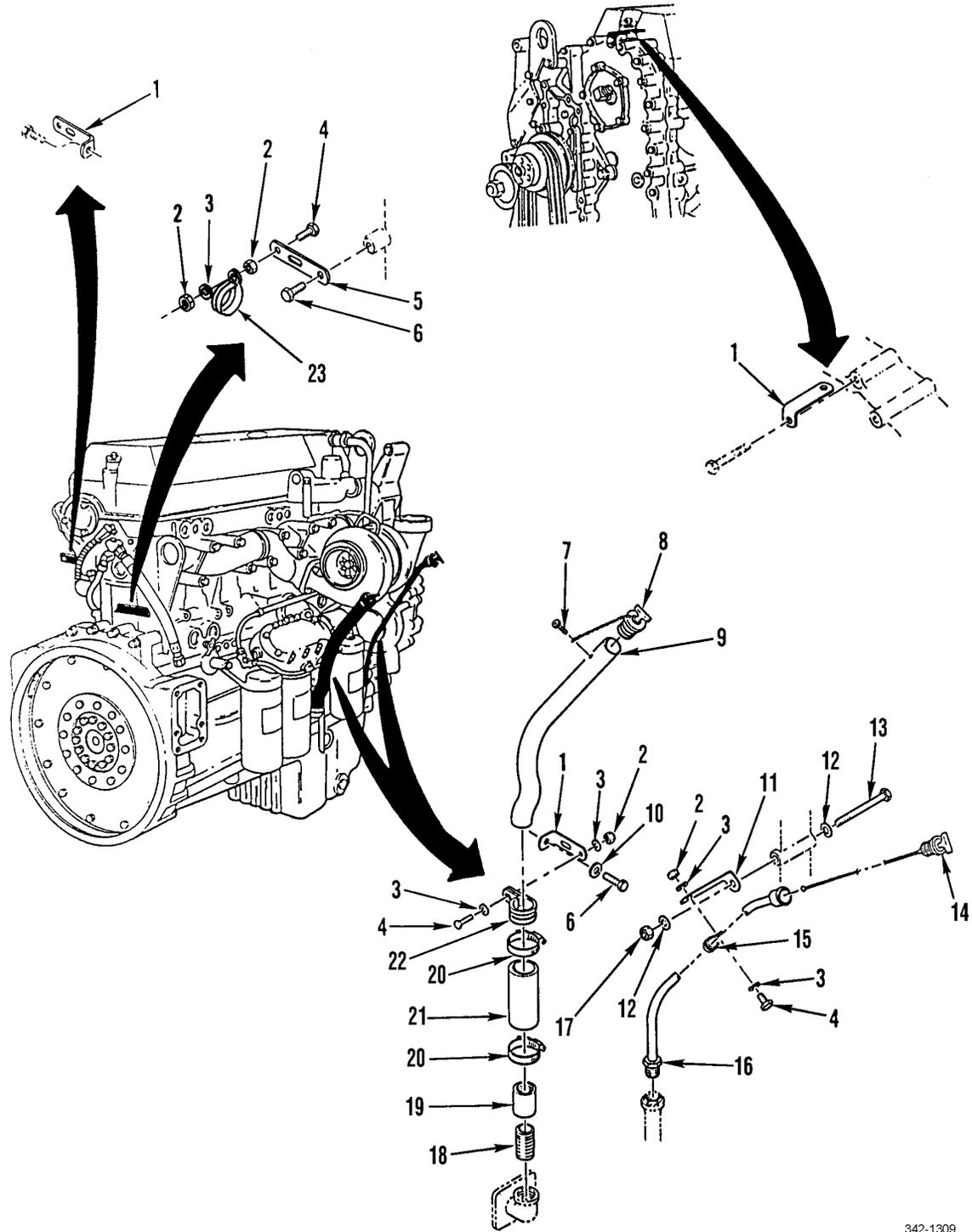
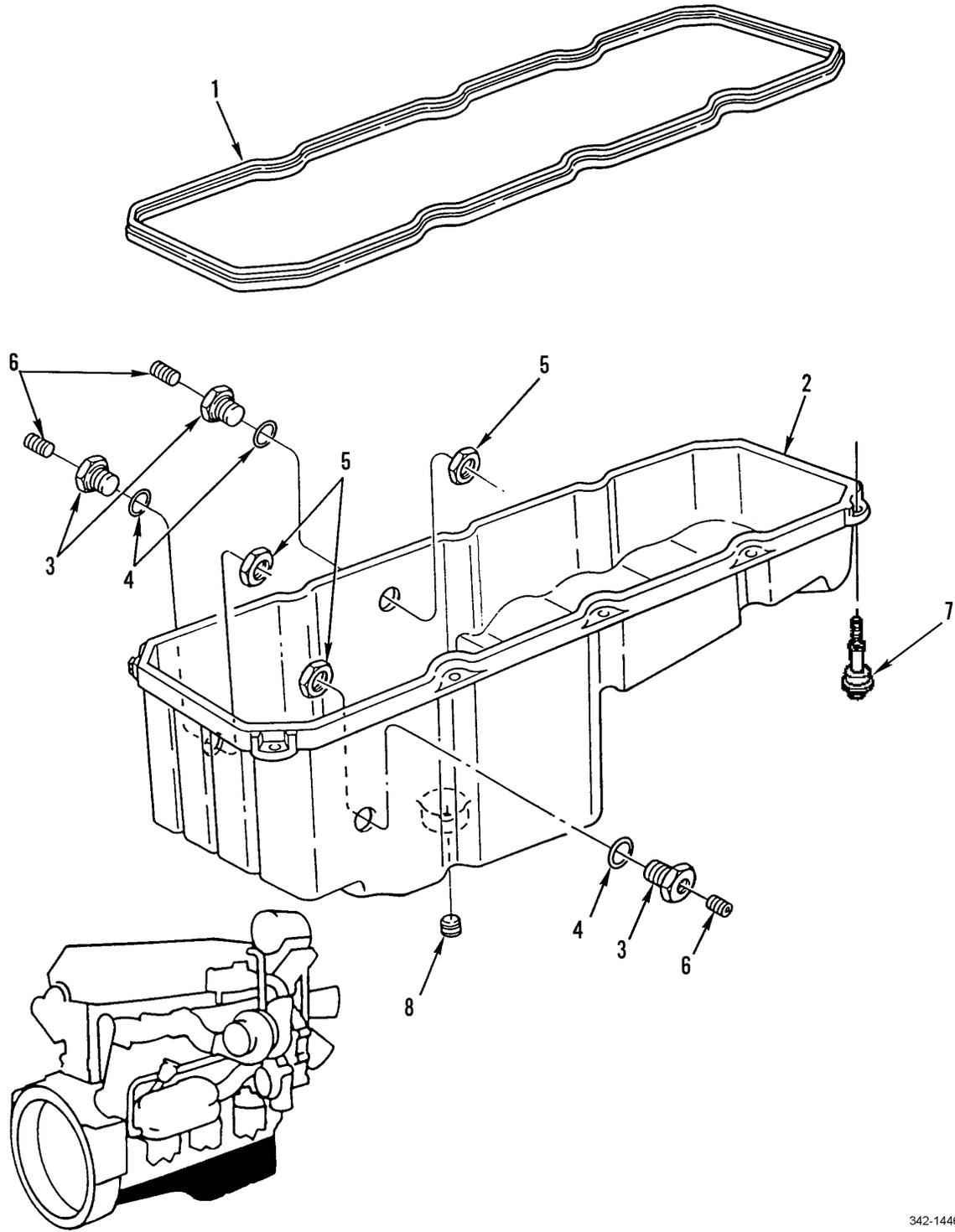

Figure 15. Engine Oil Check and Fill Tubes

SECTION II			TM9-2320-302-24P			
(1)	(2)	(3)	(4)	(5)	(6)	(7)
ITEM	SMR			PART		
NO	CODE	NSN	CAGEC	NUMBER	DESCRIPTION AND USABLE ON CODES(UOC)	QTY
GROUP 0106 ENGINE LUBRICATION SYSTEM						
FIG. 15 ENGINE OIL CHECK AND FILL TUBES						
1	PFOZZ	5340013319466	64678	06-09782-000	BRACKET,ANGLE.....	1
2	PAOZZ	5310000881251	81349	M45913/1-4CG5C	NUT,SELF LOCKING,HE.....	4
3	PAOZZ	5310008094058	96906	MS27183-10	WASHER,FLAT .281 ID X .625 OD X .065 THK.....	4
4	PFOZZ	5305002253843	80204	B1821BH025C100N	SCREW,CAP,HEXAGON H 1/4-20UNC-2A X 1.000.....	2
5	PFOZZ	5365012458802	64678	23-09130-003	SPACER,PLATE.....	1
6	PFOZZ	5306012431346	64678	000933 010174	BOLT,MACHINE DIN933, M10X25, GR 10.9, DBL 8451.21.....	2
7	PAOZZ	5305004324170	96906	MS51861-35	SCREW,TAPPING.....	1
8	PAOZZ	5342013343569	0U276	41596	CAP,FILLER OPENING.....	1
9	PFOZZ	4710014394427	64678	01-21823-000	TUBE,BENT,METALLIC.....	1
10	PAOZZ	5310008094085	96906	MS27183-16	WASHER,FLAT.....	1
11	PAOZZ	5340013326583	64678	01-21193-000	BRACKET,ANGLE.....	1
12	PAOZZ	5310000806004	96906	MS27183-14	WASHER,FLAT .406 ID X .812 OD X .065 THK.....	2
13	PAOZZ	5305008576886	80204	B1821BH038C450N	SCREW,CAP,HEXAGON H 3/8-16UNC-2A X 4.500.....	1
14	PAOZZ	6680013336757	64678	A01-21197-000	GAGE ROD,LIQUID LEV.....	1
15	PFOZZ	5340006164018	01276	900729-1	CLAMP,LOOP.....	1
16	PAOZZ	2590013326050	64678	A01-21192-000	FILLER NECK.....	1
17	PAOZZ	5310000874652	96906	MS51922-17	NUT,SELF-LOCKING,HE 3/8-16UNC.....	1
18	PFOZZ	4730013501589	98441	1X1.5FFF-S	NIPPLE,PIPE 1 X CL,NPT,BLK.....	1
19	PFOZZ	4730013322428	64678	23-09215-006	COUPLING,PIPE W.I. STL 1 IN.....	1
20	PAOZZ	4730014423515	7Z588	B9223-0175B	CLAMP,HOSE.....	2
21	MOOZZ		64678	48-00099-150X3	HOSE MAKE FROM CAGE 24161, PN 24224, 3 IN.....	1
22	PFOZZ	5340013334614	18076	S463-G26	CLAMP,LOOP 1/4-20, USED ON DDEC III	1
23	PFOZZ	5340014411103	18076	S464-G15	CLAMP,LOOP.....	1

END OF FIGURE



342-1446

Figure 16. Oil Pan Assembly

SECTION II			TM9-2320-302-24P			
(1)	(2)	(3)	(4)	(5)	(6)	(7)
ITEM	SMR			PART		
NO	CODE	NSN	CAGEC	NUMBER	DESCRIPTION AND USABLE ON CODES(UOC)	QTY
GROUP 0106 ENGINE LUBRICATION SYSTEM						
FIG. 16 OIL PAN ASSEMBLY						
1	PAFZZ		72582	23522279	GASKET PART OF KIT P/N 23512691.....	1
2	PAFZZ		72582	23522282	OIL PAN.....	1
3	KFFZZ		72582	23520930	.BUSHING,INSERT PART OF KIT P/N 23521330.....	3
4	KFFZZ		72582	23520929	.PACKING,PREFORMED PART OF KIT P/N 23521330.....	3
5	KFFZZ		72582	23520931	.NUT,HEXAGON PART OF KIT P/N 23521330.....	3
6	PAFZZ	4730011883492	72582	8923313	PLUG,PIPE.....	3
7	PAFZZ		72582	23522281	BOLT ASSEMBLED WASH.....	10
8	XDOZZ		72582	23505720	PLUG,PIPE,MAGNETIC.....	1

END OF FIGURE

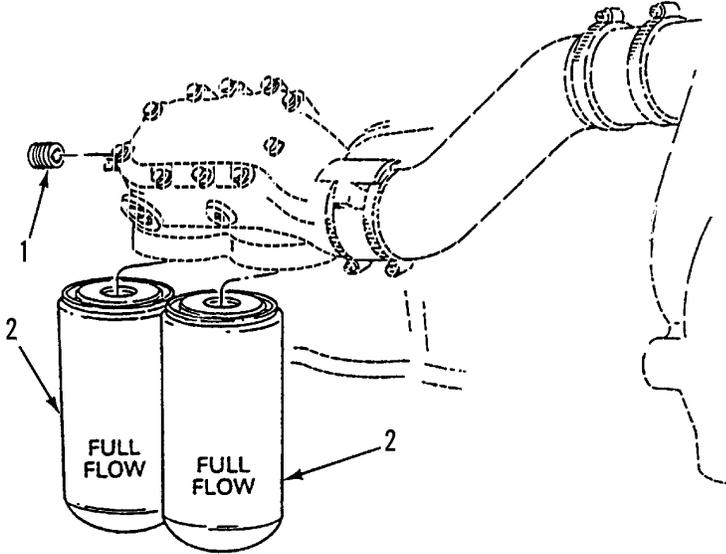

342-1447

Figure 17. Engine Oil Filters

SECTION II			TM9-2320-302-24P			
(1)	(2)	(3)	(4)	(5)	(6)	(7)
ITEM	SMR			PART		
NO	CODE	NSN	CAGEC	NUMBER	DESCRIPTION AND USABLE ON CODES(UOC)	QTY

GROUP 0106 ENGINE LUBRICATION
SYSTEM

FIG. 17 ENGINE OIL FILTERS

1	PAOZZ	4730013987635	72582	8923847	PLUG, PIPE.....	2
2	PAOZZ	2940014125275	70040	PF-2100	FILTER ELEMENT, FLUI.....	2

END OF FIGURE

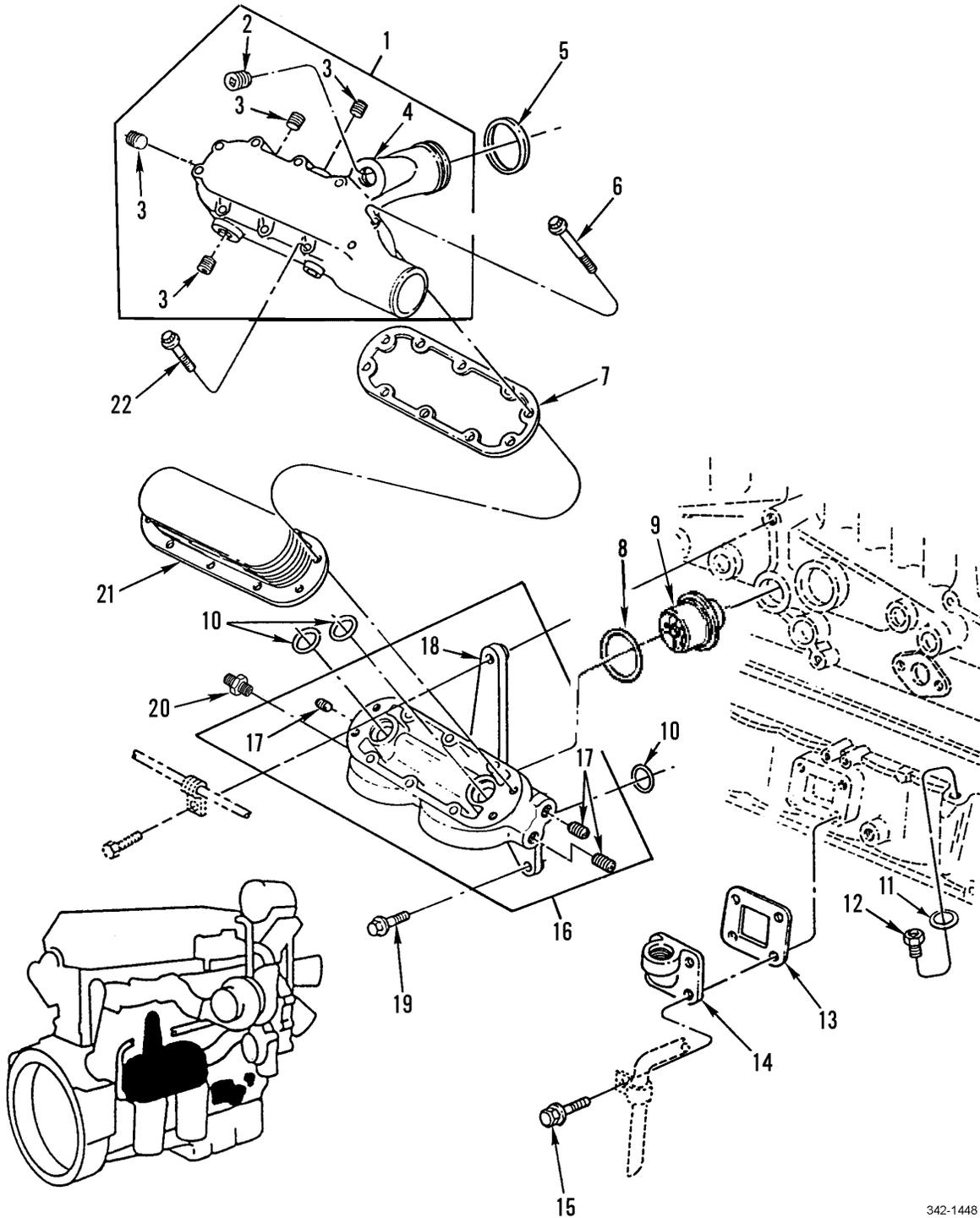
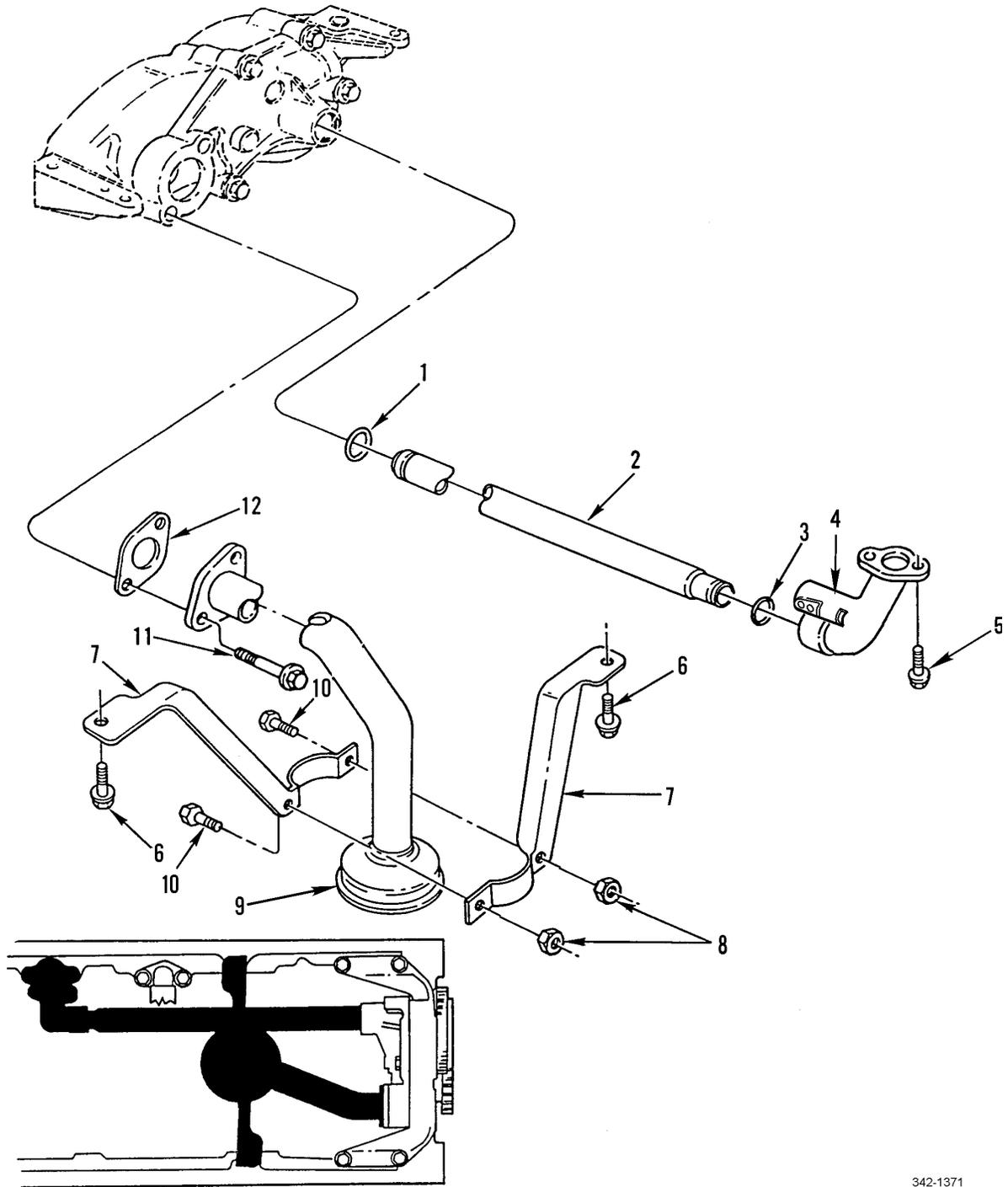

Figure 18. Oil Cooler Assembly

SECTION II			TM9-2320-302-24P			
(1)	(2)	(3)	(4)	(5)	(6)	(7)
ITEM NO	SMR CODE	NSN	CAGEC	PART NUMBER	DESCRIPTION AND USABLE ON CODES(UOC)	QTY
GROUP 0106 ENGINE LUBRICATION SYSTEM						
FIG. 18 OIL COOLER ASSEMBLY						
1	PFOZZ	2590013562690	72582	23507126	HOUSING, HYDRAULIC, G.....	1
2	PAOZZ	4730014117532	72582	23511574	. PLUG, PIPE.....	1
3	PAOZZ	4730014642348	72582	23511573	. PLUG, PIPE.....	4
4	XAOZZ		72582	23518639	. HOUSING, OIL COOLER.....	1
5	PAOZZ	5331013207183	72582	8929289	O-RING PART OF KIT P/N 23512691.....	1
6	PAOZZ	5306013203941	72582	23507183	BOLT, MACHINE M8 X 1.25 X 93-6G, GR10.9.....	7
7	PAOZZ	5330013207191	72582	23506247	GASKET.....	1
8	PAOZZ	5330013342725	72582	23505902	SEAL, PLAIN.....	1
9	PAOZZ	4820014813343	72582	23524520	VALVE, REGULATING, TE.....	1
10	PAOZZ		72582	23508392	O-RING.....	3
11	PAOZZ	5310013951250	72582	23513842	WASHER, FLAT.....	1
12	PAOZZ	4730013193474	72582	23513683	ADAPTER, STRAIGHT, PI.....	1
13	PAOZZ	5330013214132	72582	8929302	GASKET PART OF KIT P/N 23512691.....	1
14	XDOZZ		72582	23514711	FILLER NECK.....	1
15	PAOZZ	5306013213559	72582	23506222	BOLT, MACHINE M8 X 1.25 X 20-6G, GR10.9.....	4
16	XDOZZ		72582	23521365	ADAPTER, OIL COOLER.....	1
17	PAOZZ	4730011883492	72582	8923313	. PLUG, PIPE.....	3
18	XAOZZ		72582	23521672	. ADAPTOR.....	1
19	PAOZZ	5306013203940	72582	23505062	BOLT, MACHINE.....	4
20	PAOZZ	4730013193374	72582	8929833	ELBOW, HOSE.....	1
21	PAOZZ		72582	23522416	COOLER, LUBRICATING.....	1
22	PAOZZ	5305013344468	72582	23507182	SCREW, MACHINE M8 X 1.25 X 73-6G, GR10.9.....	3

END OF FIGURE



342-1371

Figure 19. Oil Distribution System

SECTION II			TM9-2320-302-24P			
(1)	(2)	(3)	(4)	(5)	(6)	(7)
ITEM	SMR			PART		
NO	CODE	NSN	CAGEC	NUMBER	DESCRIPTION AND USABLE ON CODES(UOC)	QTY
GROUP 0106 ENGINE LUBRICATION SYSTEM						
FIG. 19 OIL DISTRIBUTION SYSTEM						
1	PAFZZ	5331013195207	72582	23505891	O-RING.....	1
2	PAFZZ	4710013224975	72582	23505890	TUBE,METALLIC.....	1
3	PAFZZ	5331013195208	72582	23505892	O-RING.....	1
4	PAFZZ		72582	23516767	CONNECTOR,FLUID,PUM.....	2
5	PAFZZ	5305013199881	72582	11504822	SCREW,CAP,HEXAGON H M8 X 1.25 X 30-6G,GR10.9.....	2
6	PAFZZ	5306011865367	7X677	11503454	BOLT,MACHINE.....	2
7	PFFZZ	5340013194862	72582	23519764	BRACKET,ANGLE.....	2
8	PAFZZ	5310012641640	15526	DIN985-M10-A4C	NUT,SELF-LOCKING,HE.....	2
9	PAFZZ	4710013230095	72582	23505887	TUBE AND FITTINGS,M.....	1
10	PAFZZ	5306011857049	11862	11505299	BOLT,MACHINE.....	4
11	PAFZZ	5305013561546	72582	11509514	SCREW,CAP,HEXAGON H.....	2
12	PAFZZ	5330013207190	72582	23505992	GASKET PART OF KIT P/N 23512691.....	1

END OF FIGURE

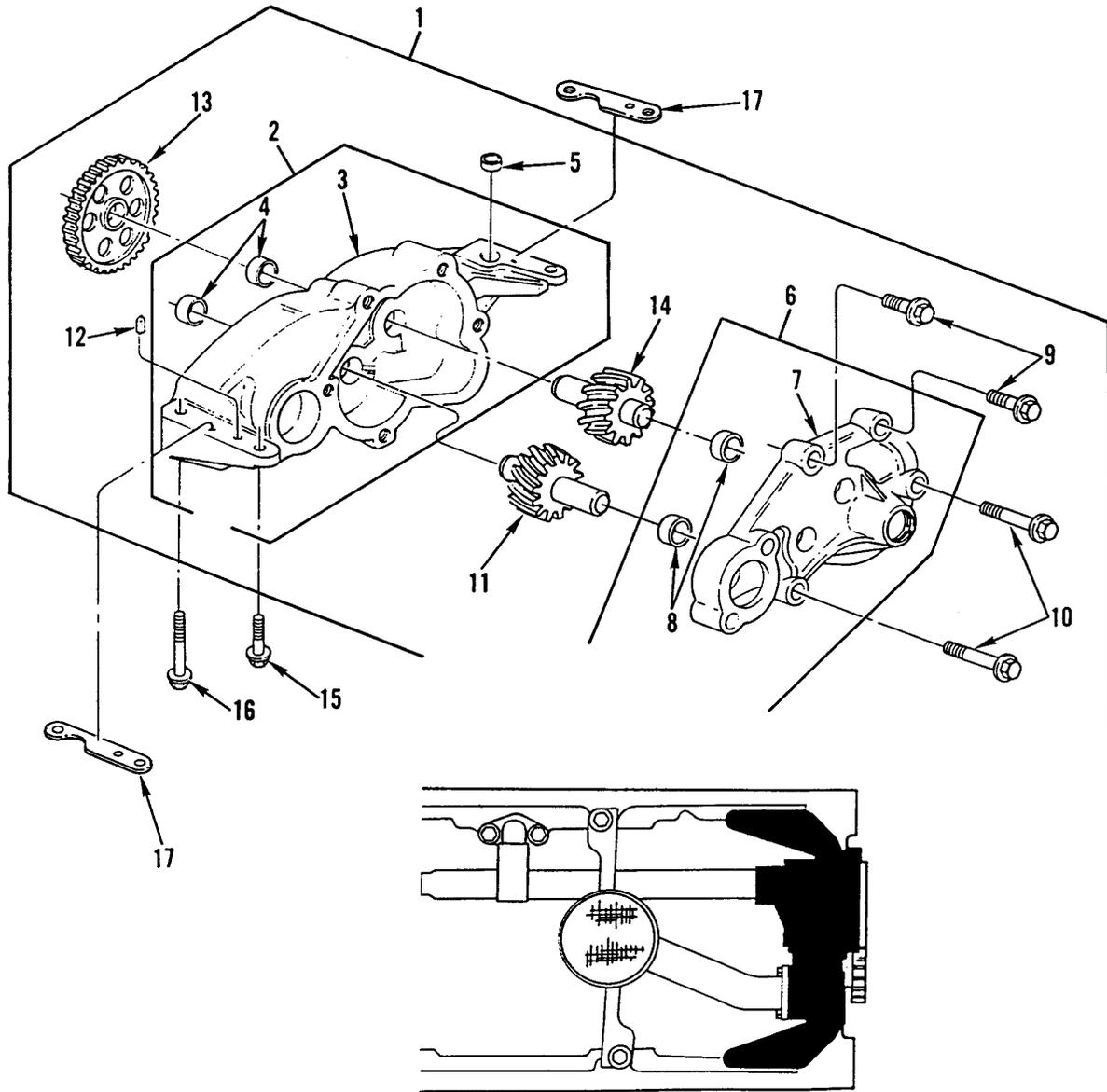

342-1313

Figure 20. Engine Oil Pump

SECTION II			TM9-2320-302-24P			
(1)	(2)	(3)	(4)	(5)	(6)	(7)
ITEM	SMR			PART		
NO	CODE	NSN	CAGEC	NUMBER	DESCRIPTION AND USABLE ON CODES(UOC)	QTY
GROUP 0106 ENGINE LUBRICATION SYSTEM						
FIG. 20 ENGINE OIL PUMP						
1	PAFHF	2815013175521	72582	23505886	OIL PUMP ASSEMBLY,E.....	1
2	PFHZZ	2995013342795	72582	23505878	.HOUSING,OIL PUMP AS.....	1
3	XAHZZ		72582	23505877	..BODY,OIL PUMP.....	1
4	PAHZZ	3120013210598	72582	B-21951	..BEARING,SLEEVE.....	2
5	PFHZZ	5315013203625	72582	23505885	.PIN,STRAIGHT,HEADLE.....	1
6	XAHZZ		72582	23505883	.COVER,ACCESS.....	1
7	XAHZZ		72582	23507338	..COVER,OIL PUMP BODY.....	1
8	PAHZZ	3120013210598	72582	B-21951	..BEARING,SLEEVE.....	2
9	PAHZZ	5306011655583	11862	14060613	.BOLT,MACHINE.....	2
10	PAHZZ	5305013561546	72582	11509514	.SCREW,CAP,HEXAGON H.....	2
11	PAHZZ	3020013379277	72582	23505882	.GEAR,HELICAL.....	1
12	PFHZZ	5315013192509	72582	8929011	.PIN,STRAIGHT,HEADLE.....	1
13	PAHZZ	3020013229945	72582	23505884	.GEAR,SPUR.....	1
14	PAHZZ	3020013357394	72582	23507337	.GEAR SECTOR,HELICAL.....	1
15	PAFZZ	5306013203940	72582	23505062	BOLT,MACHINE.....	2
16	PAFZZ	5305013208043	72582	8929393	SCREW,CAP,HEXAGON H.....	2
17	PFFZZ	5365013560081	75282	23508739	SHIM.....	2
17	PFFZZ	5365013584625	72582	23508740-ND	SHIM.....	2

END OF FIGURE

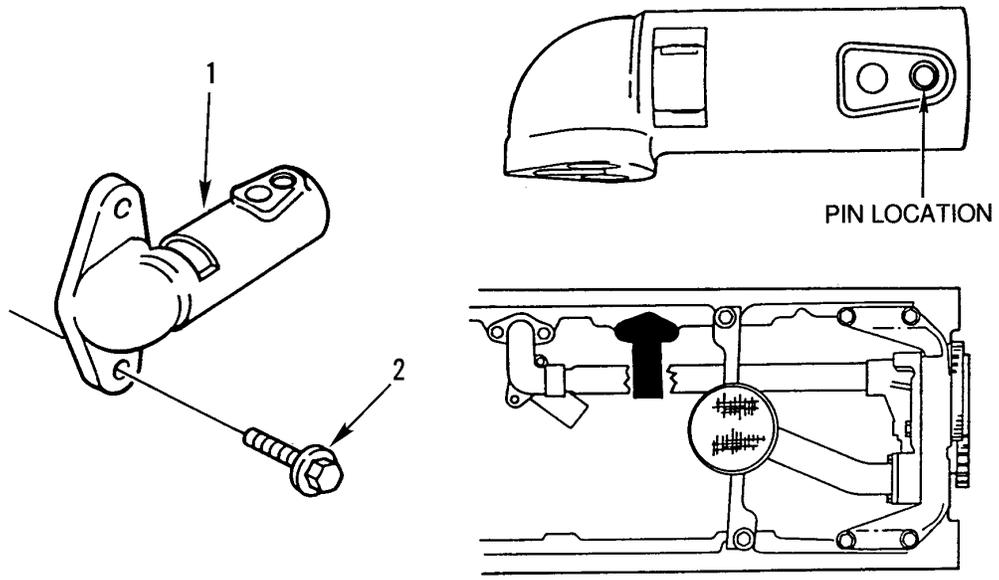

342-1372

Figure 21. Oil Relief and Regulator Valves

SECTION II			TM9-2320-302-24P			
(1)	(2)	(3)	(4)	(5)	(6)	(7)
ITEM	SMR			PART		
NO	CODE	NSN	CAGEC	NUMBER	DESCRIPTION AND USABLE ON CODES(UOC)	QTY
					GROUP 0106 ENGINE LUBRICATION SYSTEM	
					FIG. 21 OIL RELIEF AND REGULATOR VALVES	
1	PAFZZ	4810013193495	72582	23512901	VALVE,REGULATING,FL.....	1
2	PAFZZ	5305013199881	72582	11504822	SCREW,CAP,HEXAGON H.....	4

END OF FIGURE

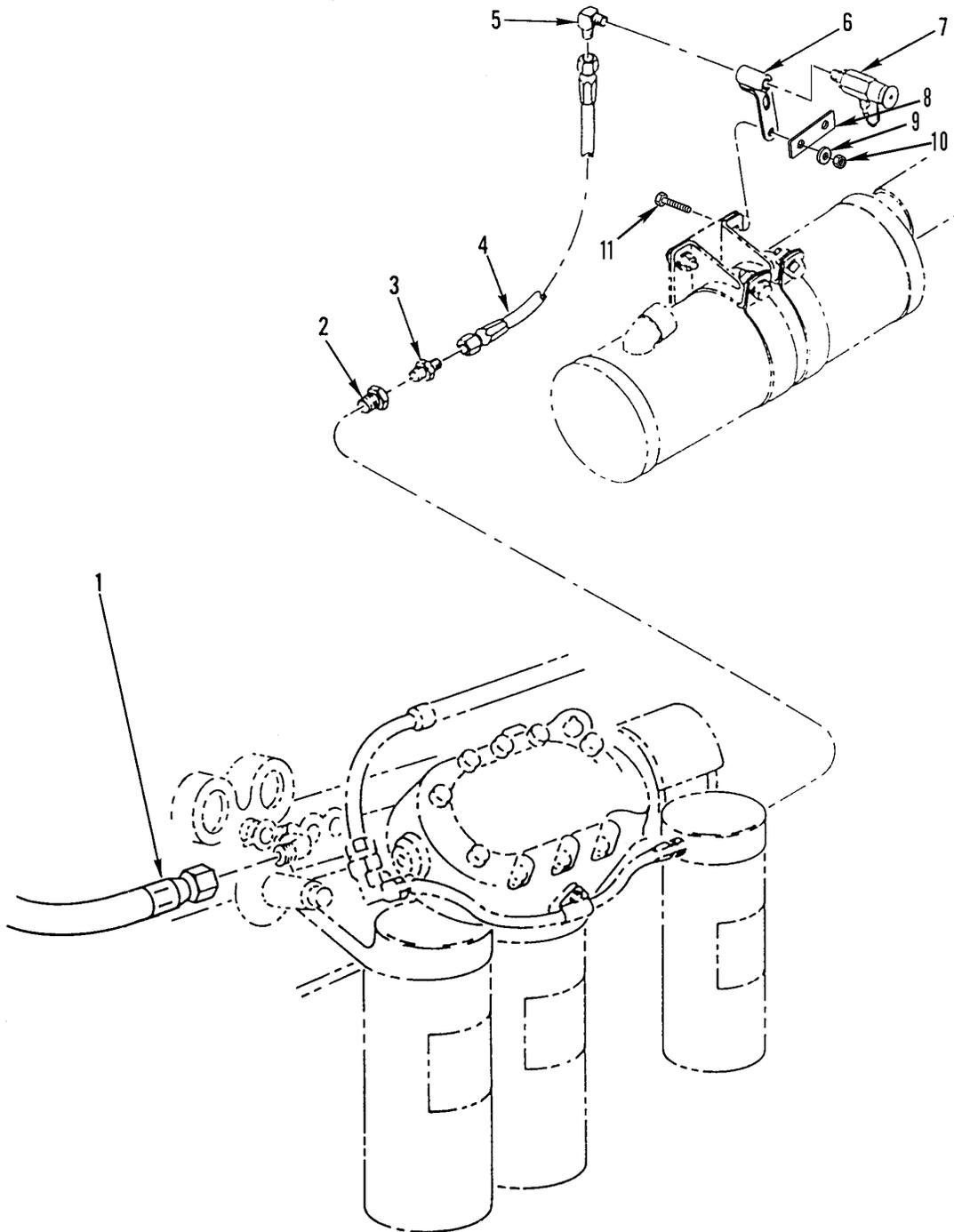

342-1310

Figure 22. Oil Pressure Gage Hose and Engine Oil Sample Valve

SECTION II			TM9-2320-302-24P			
(1)	(2)	(3)	(4)	(5)	(6)	(7)
ITEM	SMR			PART		
NO	CODE	NSN	CAGEC	NUMBER	DESCRIPTION AND USABLE ON CODES(UOC)	QTY
GROUP 0106 ENGINE LUBRICATION SYSTEM						
FIG. 22 OIL PRESSURE GAGE HOSE AND ENGINE OIL SAMPLE VALVE						
1	PAOZZ	4720013325964	64678	A23-02232-080	HOSE ASSEMBLY, NONME WIRE BRAID, NO. 4.....	1
2	PAOZZ	4730012382980	96906	MS14304-1-T-12-06	BUSHING, PIPE.....	1
3	PAOZZ	4730002660534	41947	A1197	ADAPTER, STRAIGHT, PI.....	1
4	PFOZZ	4720013321335	64678	A23-02232-028	HOSE ASSEMBLY, NONME WIRE BRAID, NO. 4.....	1
5	PAOZZ	4730002546225	70334	20723	ELBOW, PIPE TO TUBE.....	1
6	PFOZZ	5340013583686	64678	A01-20695-001	BRACKET, ANGLE.....	1
7	PAOZZ	4820011204532	91816	P59-500	VALVE, BLEEDER, HYDRA.....	1
8	PFOZZ	5340014749584	64678	06-09782-003	BRACKET, MOUNTING.....	1
9	PAOZZ	5310007679425	96906	MS15795-818	WASHER, FLAT 1/2 X 1.06 X 0.14.....	2
10	PAOZZ	5310002256993	81349	M45913/1-8CG5C	NUT, SELF-LOCKING, HE.....	1
11	PAOZZ	5305000213806	96906	MS35307-413	SCREW, CAP, HEXAGON H 1/2-13 X 1.5...	1

END OF FIGURE

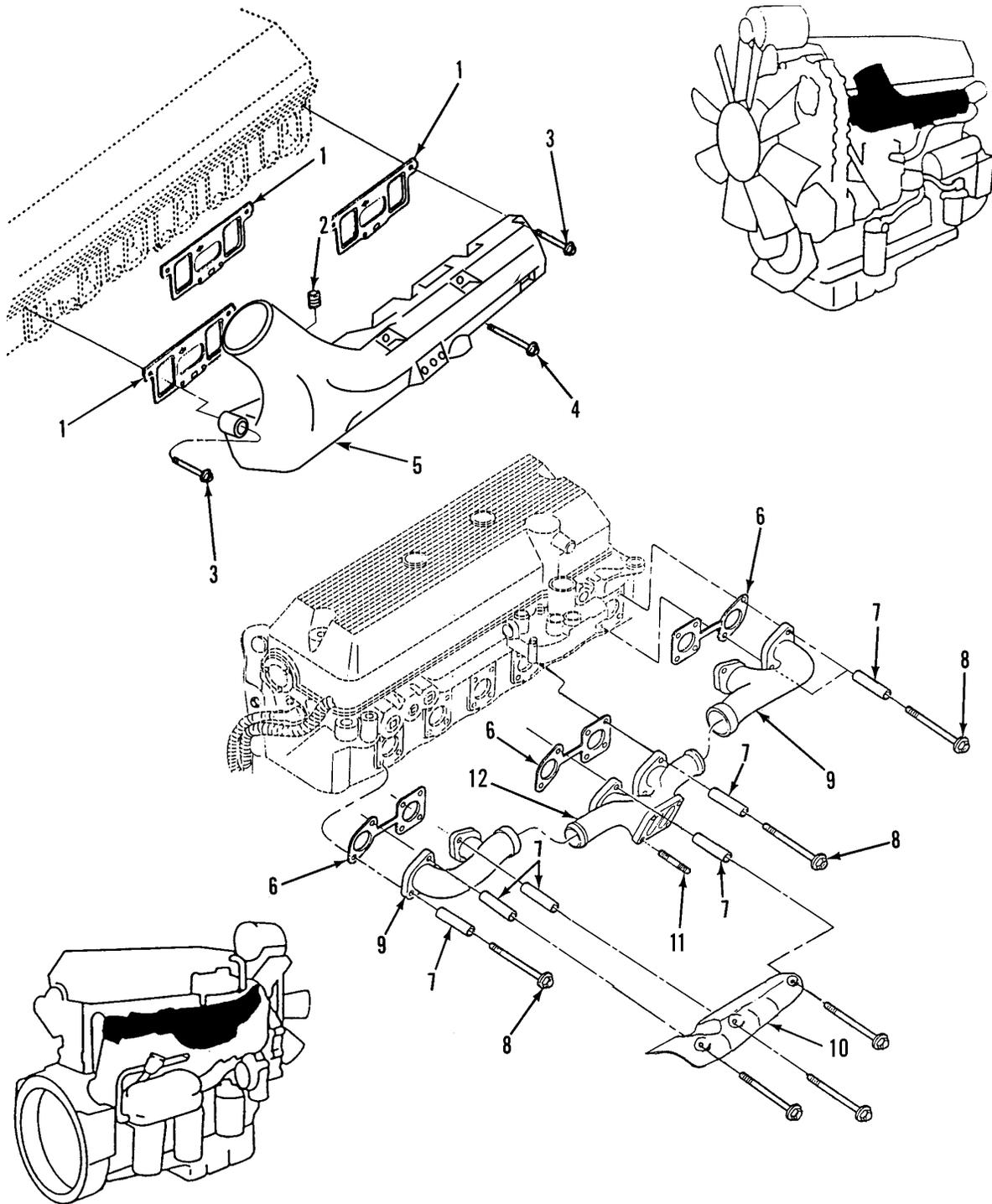

342-1373

Figure 23. Intake and Exhaust Manifolds

SECTION II			TM9-2320-302-24P			
(1)	(2)	(3)	(4)	(5)	(6)	(7)
ITEM	SMR			PART		
NO	CODE	NSN	CAGEC	NUMBER	DESCRIPTION AND USABLE ON CODES(UOC)	QTY
GROUP 0108 MANIFOLDS						
FIG. 23 INTAKE AND EXHAUST MANIFOLDS						
1	PAFZZ	5330014118119	72582	23517875	GASKET PART OF KIT P/N 23501572 PART OF KIT P/N 23512691.....	3
2	PAOZZ	4730011293047	72582	8922327	PLUG,PIPE.....	2
3	PAFZZ	5305013321488	72582	11509799	SCREW,CAP,HEXAGON H.....	2
4	PAFZZ	5305013321487	72582	11509526	SCREW,CAP,HEXAGON H.....	5
5	PAFZZ	2815013193579	72582	23517435	MANIFOLD,INTAKE.....	1
6	PAFZZ	5330013199227	72582	23511666	GASKET GASKET, EXHAUST MANIFOLD PART OF KIT P/N 23512691 PART OF KIT P/N 23501572.....	3
7	PFFZZ	5365014405246	72582	23511667	SPACER,SLEEVE.....	12
8	PAFZZ	5306013203942	72582	8929357	BOLT,MACHINE.....	12
9	PAFZZ	2815013229277	72582	23511222	MANIFOLD,EXHAUST.....	1
9	PAFZZ	2815014405799	72582	23511221	MANIFOLD,EXHAUST FRONT ONLY.....	1
10	XDFZZ		72582	23519124	HEAT SHIELD.....	1
11	PAFZZ	5307013590178	72582	23507438ND	STUD,SHOULDERED.....	4
12	PAFZZ	2815014405796	72582	23514898	MANIFOLD,EXHAUST CENTER.....	1

END OF FIGURE

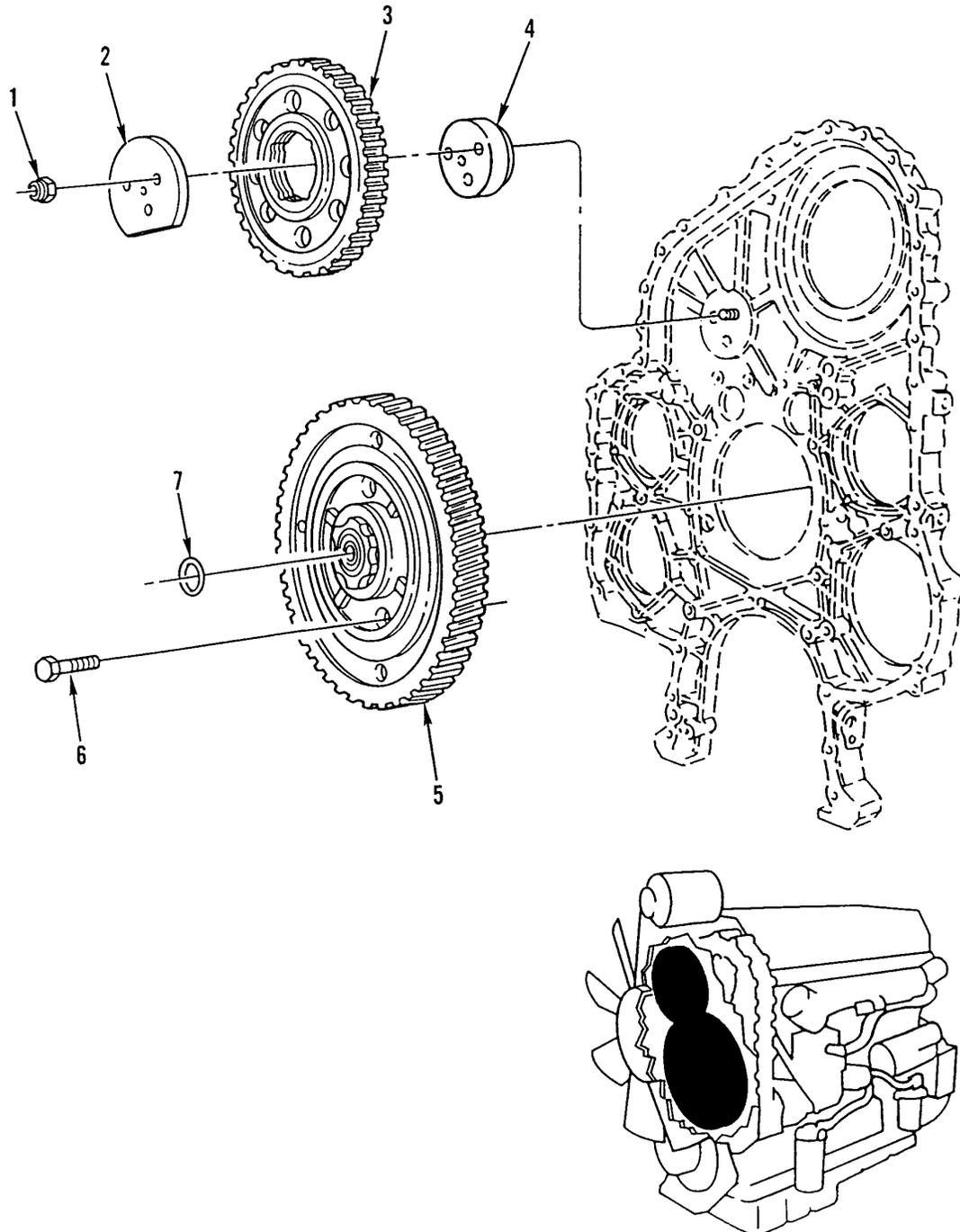

342-1449

Figure 24. Bull Gear and Adjustable Idler Gear

SECTION II			TM9-2320-302-24P			
(1)	(2)	(3)	(4)	(5)	(6)	(7)
ITEM	SMR			PART		
NO	CODE	NSN	CAGEC	NUMBER	DESCRIPTION AND USABLE ON CODES(UOC)	QTY
					GROUP 0109 ACCESSORY DRIVING MECHANISMS	
					FIG. 24 BULL GEAR AND ADJUSTABLE IDLER GEAR	
1	PAHZZ	5310013366222	72582	11509607	NUT, PLAIN, HEXAGON.....	3
2	PFHZZ	5340013205179	72582	8929336	PLATE, MOUNTING.....	1
3	PAHZZ	3020013384547	72582	8929322	GEAR, SPUR.....	1
4	PFHZZ	3040013196983	72582	8929111	BRACKET, EYE, ROTATING.....	1
5	PFHZZ	3020014410430	72582	23513559	GEAR CLUSTER.....	1
6	PAHZZ	5306013380894	72582	8929448	BOLT, MACHINE.....	4
7	PAHZZ	5365000944271	72582	5141452	RING, SEAL PART OF KIT P/N 23512691..	1

END OF FIGURE

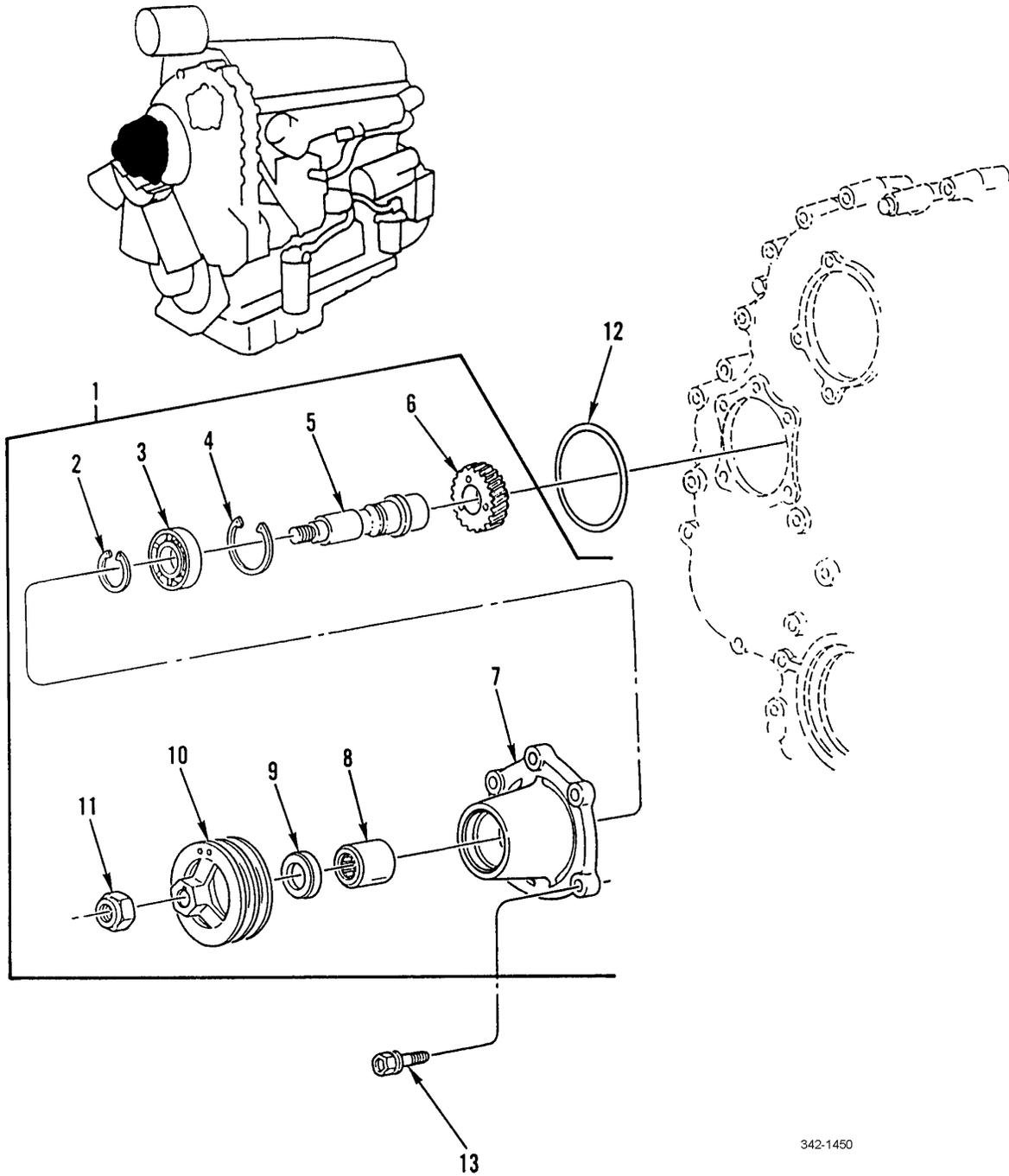

342-1450

Figure 25. Accessory Drive

SECTION II			TM9-2320-302-24P			
(1)	(2)	(3)	(4)	(5)	(6)	(7)
ITEM	SMR			PART		
NO	CODE	NSN	CAGEC	NUMBER	DESCRIPTION AND USABLE ON CODES(UOC)	QTY
GROUP 0109 ACCESSORY DRIVING MECHANISMS						
FIG. 25 ACCESSORY DRIVE						
1	PAFFZ	3040013657779	72582	23509200	DRIVE ASSEMBLY.....	1
2	PAFZZ	5325013207327	07382	VSH-137-2	.RING,RETAINING.....	1
3	PAFZZ	3110013631479	72582	23509203	.BEARING,BALL,THRUST.....	1
4	PAFZZ	5325013629783	72582	23509204	.RING,RETAINING.....	1
5	PFFZZ	3040013644466	72582	23509202	.SHAFT,SHOULDERED.....	1
6	PAFZZ	3020013374220	72582	8929310	.GEAR,HELICAL.....	1
7	PFFZZ	3040013644500	72582	23509201	.HOUSING,MECHANICAL.....	1
8	PAFZZ	3110010385721	60380	JH-2216	.BEARING,ROLLER,NEED.....	1
9	PAFZZ	5330013192435	01212	484156VGR	.SEAL,PLAIN ENCASED.....	1
10	PAOZZ	3020013192831	72582	8929532	.PULLEY,GROOVE.....	1
11	PAOZZ	5310013215302	72582	11509584	.NUT,SELF-LOCKING,HE.....	1
12	PAFZZ	5330013342726	72582	8929253	SEAL,PLAIN PART OF KIT P/N 23512691.	1
13	PAFZZ	5305013199881	72582	11504822	SCREW,CAP,HEXAGON H.....	5

END OF FIGURE

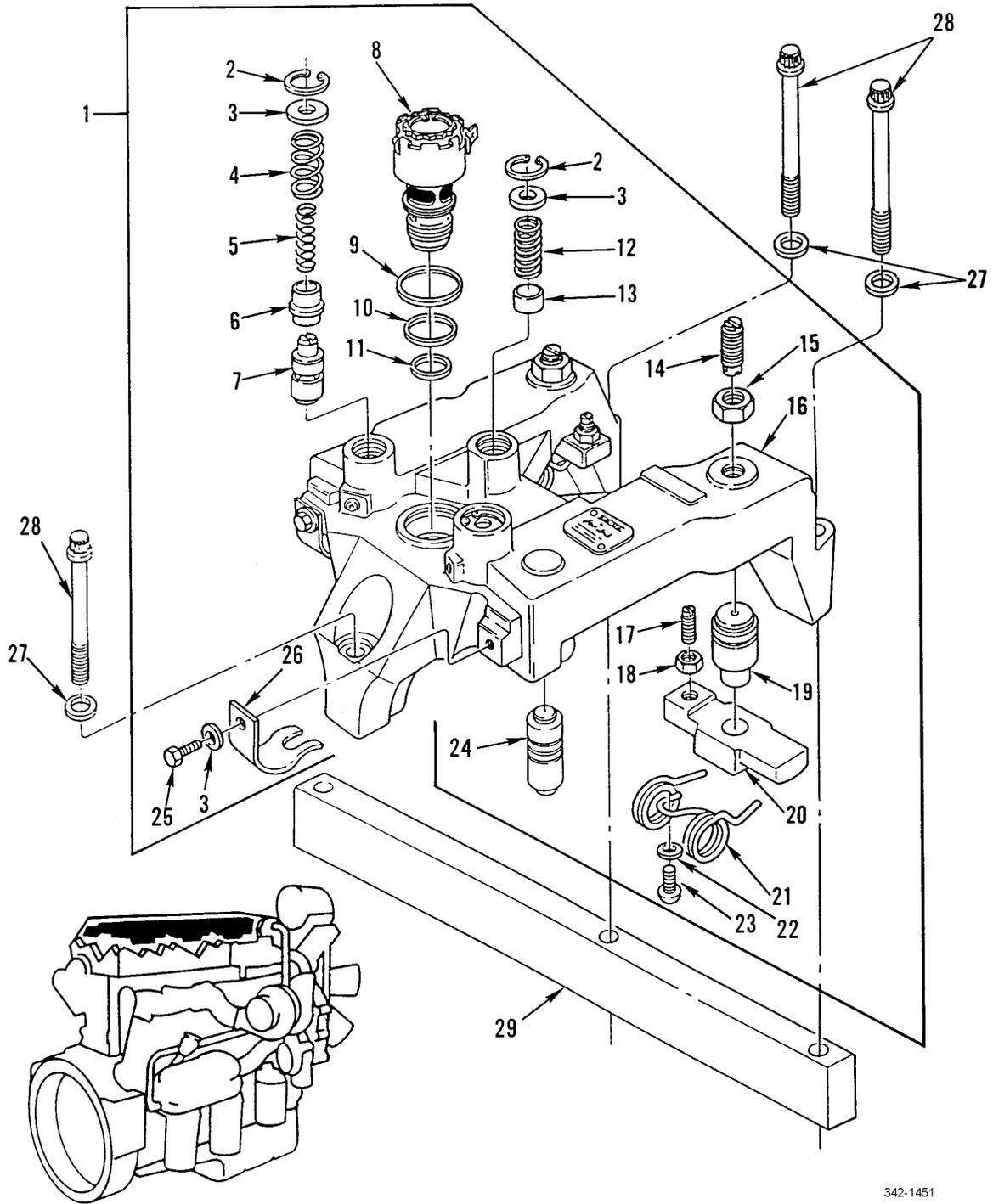
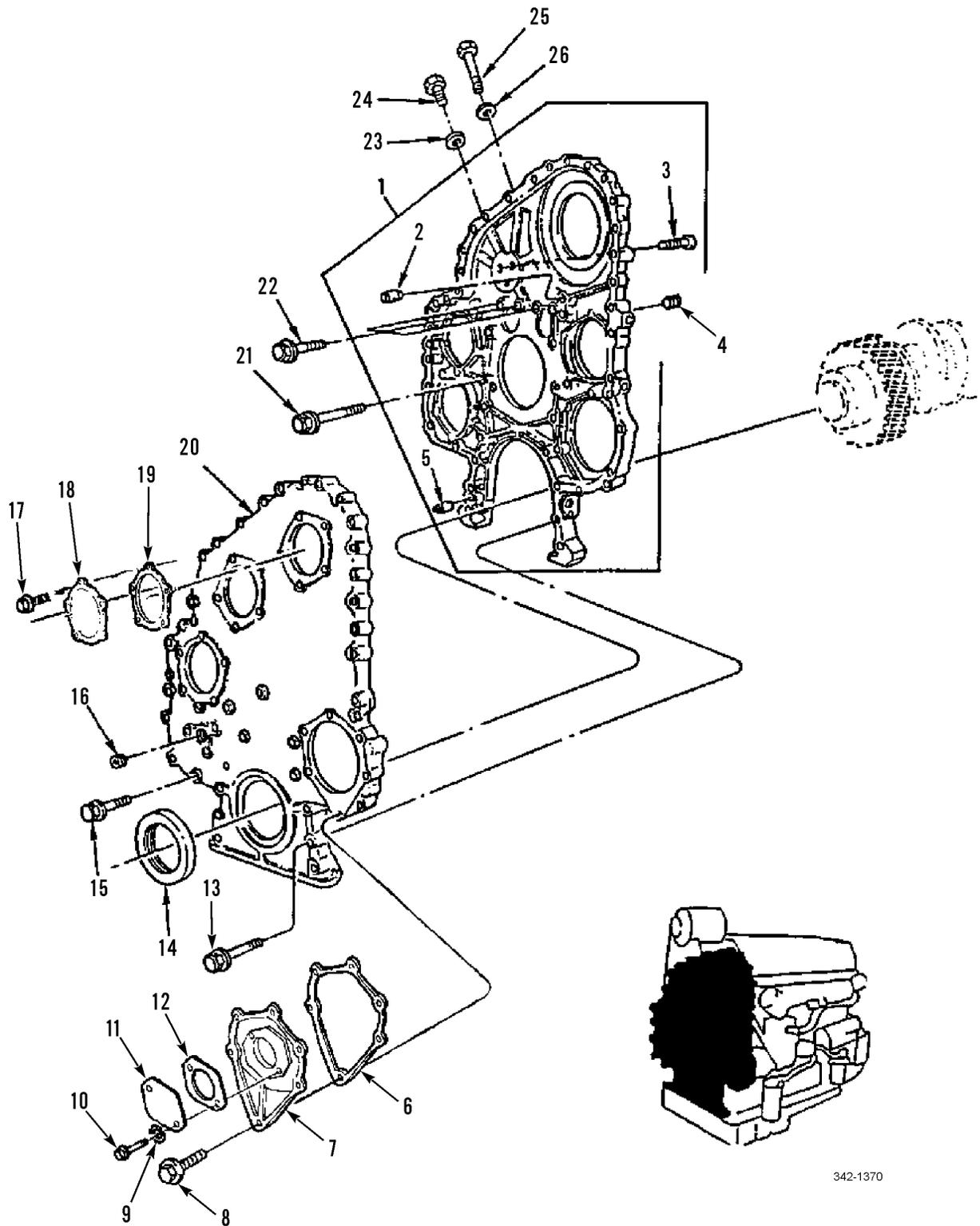

Figure 26. Engine Retarder Assembly

SECTION II			TM9-2320-302-24P			
(1)	(2)	(3)	(4)	(5)	(6)	(7)
ITEM NO	SMR CODE	NSN	CAGEC	PART NUMBER	DESCRIPTION AND USABLE ON CODES(UOC)	QTY
GROUP 0112 ENGINE BRAKE						
FIG. 26 ENGINE RETARDER ASSEMBLY						
1	PBFFF		75078	025911	MOTOR, CONTROL.....	3
2	PAFZZ	5325008049740	96906	MS16625-1081	.RING, RETAINING.....	3
3	PAFZZ	5310013386844	75078	016505	.WASHER, FLAT.....	5
4	PAFZZ	5360010899103	75078	001519	.SPRING.....	2
5	PFFZZ		75078	018179	.SPRING, MOTOR ACTUAT.....	2
6	PAFZZ	5365013235621	75078	00-016557	.SPACER, SLEEVE.....	6
7	PAFZZ	4820013384270	75078	011930	.VALVE, CHECK.....	2
8	PFFZZ		75078	1024612	.VALVE, SOLENOID.....	1
9	PFFZZ		75078	020229	.O-RING.....	1
10	PAFZZ	5331010853105	75078	001082	.O-RING.....	1
11	PAFZZ	5330010866196	75078	001083	.PACKING, PREFORMED.....	1
12	PAFZZ	5360013251570	75078	012990	.SPRING, HELICAL, COMP.....	1
13	PAFZZ	1650013190808	75078	012983	.PISTON, HYDRAULIC AC.....	1
14	PFFZZ		75078	028082	.SETSCREW.....	2
15	PFFZZ		75078	019987	.NUT, PLAIN, HEXAGON.....	2
16	XAFZZ		75078	025914	.HOUSING, ENG RETARD.....	1
17	PAFZZ	5305013207142	75078	011426	.SETSCREW.....	2
18	XDFZZ		75078	16766	.NUT, PLAIN, HEXAGON.....	2
19	PFFZZ		75078	024338	.PISTON, HYDRAULIC BR.....	2
20	XDFZZ		75078	016771	.PLATE, MOUNTING, FLAT.....	2
21	PFFZZ		75078	019576	.SPRING, HEKICAL, TORS.....	2
22	XDFZZ		75078	019741	.WASHER, FLAT.....	2
23	PFFZZ		75078	019740	.SCREW, CAP, SOCKET HE.....	2
24	PAFZZ	2530013190833	75078	071565	.PISTON, HYDRAULIC BR.....	2
25	PAFZZ	5305011458384	75078	001492	.SCREW, CAP, HEXAGON H.....	2
26	PFFZZ		75078	017658	.SPRING, FLAT.....	2
27	XDFZZ		75078	21184	WASHER, FLAT.....	9
28	XDFZZ		75078	21183	BOLT, EXTERNALLY REL.....	9
29	PFFZZ	5365013210574	72582	23504431	SPACER, PLATE.....	2

END OF FIGURE



342-1370

Figure 27. Gear Case and Front Cover

SECTION II			TM9-2320-302-24P			
(1)	(2)	(3)	(4)	(5)	(6)	(7)
ITEM NO	SMR CODE	NSN	CAGEC	PART NUMBER	DESCRIPTION AND USABLE ON CODES(UOC)	QTY
GROUP 0125 ACCESSORY DRIVE ASSEMBLY						
FIG. 27 GEAR CASE AND FRONT COVER						
1	PFHZZ		72582	23511983	HOUSING,MECHANICAL.....	1
2	PFHZZ	5315013195895	72582	8929015	.PIN,STRAIGHT,HEADLE.....	1
3	PAHZZ	5306013208614	72582	8929333	.BOLT,EXTERNALLY REL M12 X 1.75 X 65-6G,GR10.9.....	3
4	PFHZZ	4730003715337	72582	8924380	PLUG,PIPE 3/16, SQ SOCKET DRIVE...	1
5	PFHZZ	5315013208883	72582	8929022	.PIN,STRAIGHT,HEADLE 16.0 MM.....	1
6	PAFZZ	5330013184569	72582	8929299	GASKET PART OF KIT P/N 23512691.....	1
7	XDFZZ		72582	23505272	COVER,POWER STEER.....	1
8	PAFZZ	5305013199881	72582	11504822	SCREW,CAP,HEXAGON H M8 X 1.25 X 30- 6G,GR10.9.....	6
9	XDFZZ		72582	5145225	WASHER,FLAT.....	2
10	XDFZZ		72582	23505299	BOLT.....	2
11	XDFZZ		72582	23505273	COVER.....	1
12	XDFZZ		72582	23516100	GASKET.....	1
13	XDFZZ		72582	11509525	SCREW,CAP,HEXAGON H M10 X 1.5 X 110-6G,GR10.9,FLANGE HD.....	4
14	PFFZZ		72582	23518355	SEAL,PLAIN ENCASED STANDARD.....	1
15	XDFZZ		72582	11509523	SCREW,CAP,HEXAGON H M10 X 1.5 X 55- 6G,GR10.9,FLANGE HD.....	14
16	PAFZZ	4730000103885	72582	8924517	PLUG,PIPE.....	1
17	PAFZZ	5305013199881	72582	11504822	SCREW,CAP,HEXAGON H M8 1.25 30- 6G,GR10.9.....	5
18	PAFZZ	2920013168813	72582	8929007	END BELL,ELECTRICAL.....	1
19	PAFZZ	5330013192136	72582	8929130	GASKET PART OF KIT P/N 23512691 PART OF KIT P/N 23501572.....	1
20	PAFZZ	5340013425635	72582	23505876	COVER,ACCESS.....	1
21	PAHZZ	5306013203940	72582	23505062	BOLT,MACHINE M10 X 1.5 X 40,GR10.9.	9
22	PAHZZ	5306011857049	11862	11505299	BOLT,MACHINE M10 X 1.5 X 30-6G, GR10.9.....	3
23	PAFZZ	5310007375429	19207	7375429	WASHER,FLAT 21/64 X 9/16 X 1/16....	1
24	PAFZZ	5306000212544	72582	181333	BOLT,MACHINE 5/16-24 X 5/8.....	1
25	PAFZZ	5305013202007	72582	11513811	SCREW,CAP,HEXAGON H M12 X 1.75 X 20-6G,GR10.9.....	1
26	PAFZZ	5310013208100	72582	5180370	WASHER,FLAT 0.55 X 0.89 X 0.03.....	1

END OF FIGURE

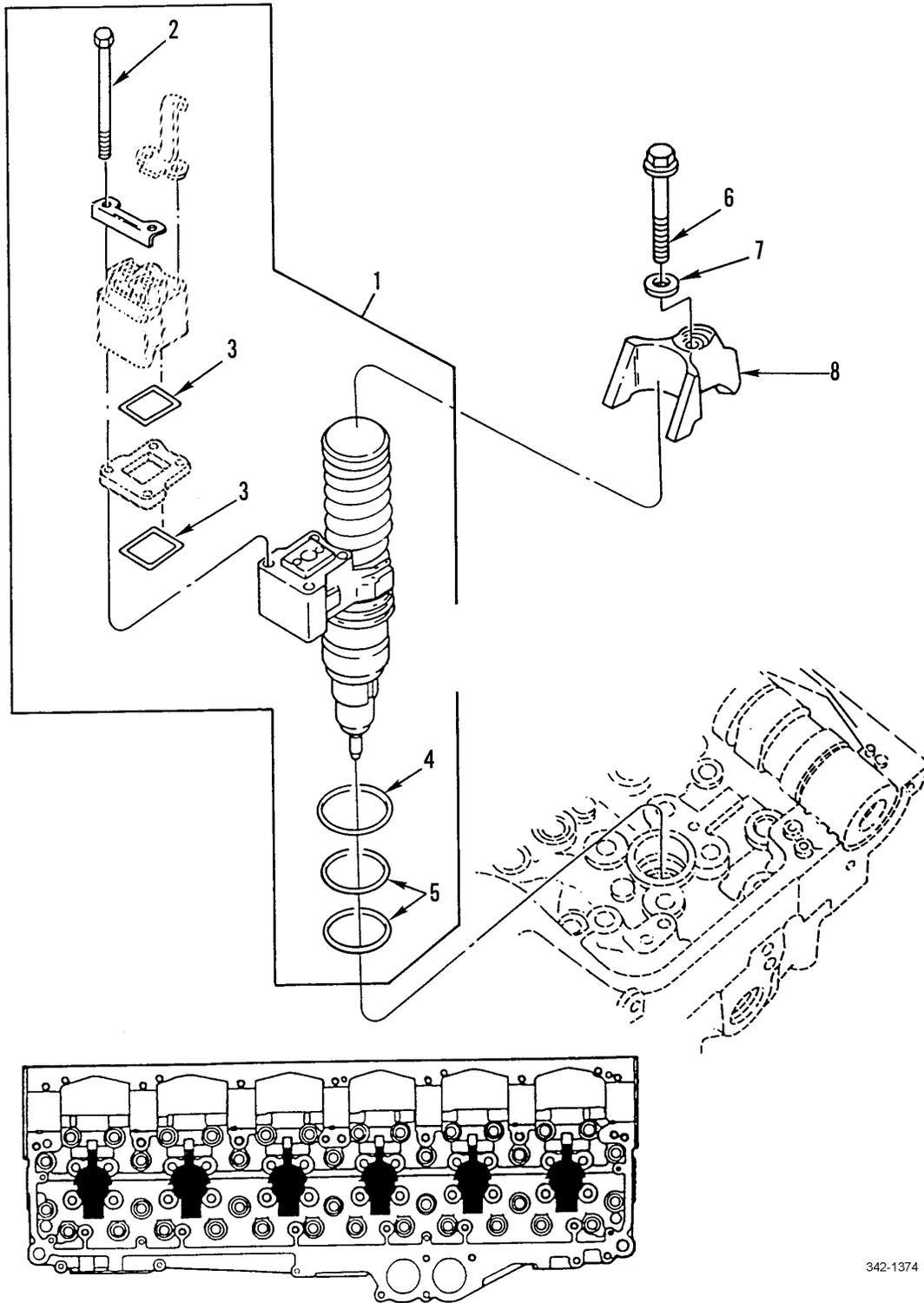

342-1374

Figure 28. Injector Assembly

SECTION II			TM9-2320-302-24P			
(1)	(2)	(3)	(4)	(5)	(6)	(7)
ITEM	SMR			PART		
NO	CODE	NSN	CAGEC	NUMBER	DESCRIPTION AND USABLE ON CODES(UOC)	QTY
GROUP 03 FUEL SYSTEM						
GROUP 0301 CARBURETOR, FUEL INJECTOR						
FIG. 28 INJECTOR ASSEMBLY						
1	PAFDD		72582	R5236977	INJECTOR ASSEMBLY,F.....	6
2	KFFZZ		72582	5235586	.SCREW,HEX HEAD PART OF KIT P/N 5236116.....	4
3	KFFZZ		72582	5234224	.SEAL, SPACER PART OF KIT P/N 5236116.....	2
4	PAFZZ	5331013194857	72582	5234702	.O-RING.....	1
5	PAFZZ	5331013194858	72582	5234699	.O-RING.....	2
6	PAFZZ	5305013208043	72582	8929393	SCREW,CAP,HEXAGON H M10 1.5 70.0-6G,GR10.9.....	6
7	PAFZZ	5310013368850	72582	8929021	WASHER,FLAT 10.9 X 20.4 X 3.3MM....	6
8	PAFZZ	2910013219247	72582	8929088	CLAMP,INJECTOR.....	6

END OF FIGURE

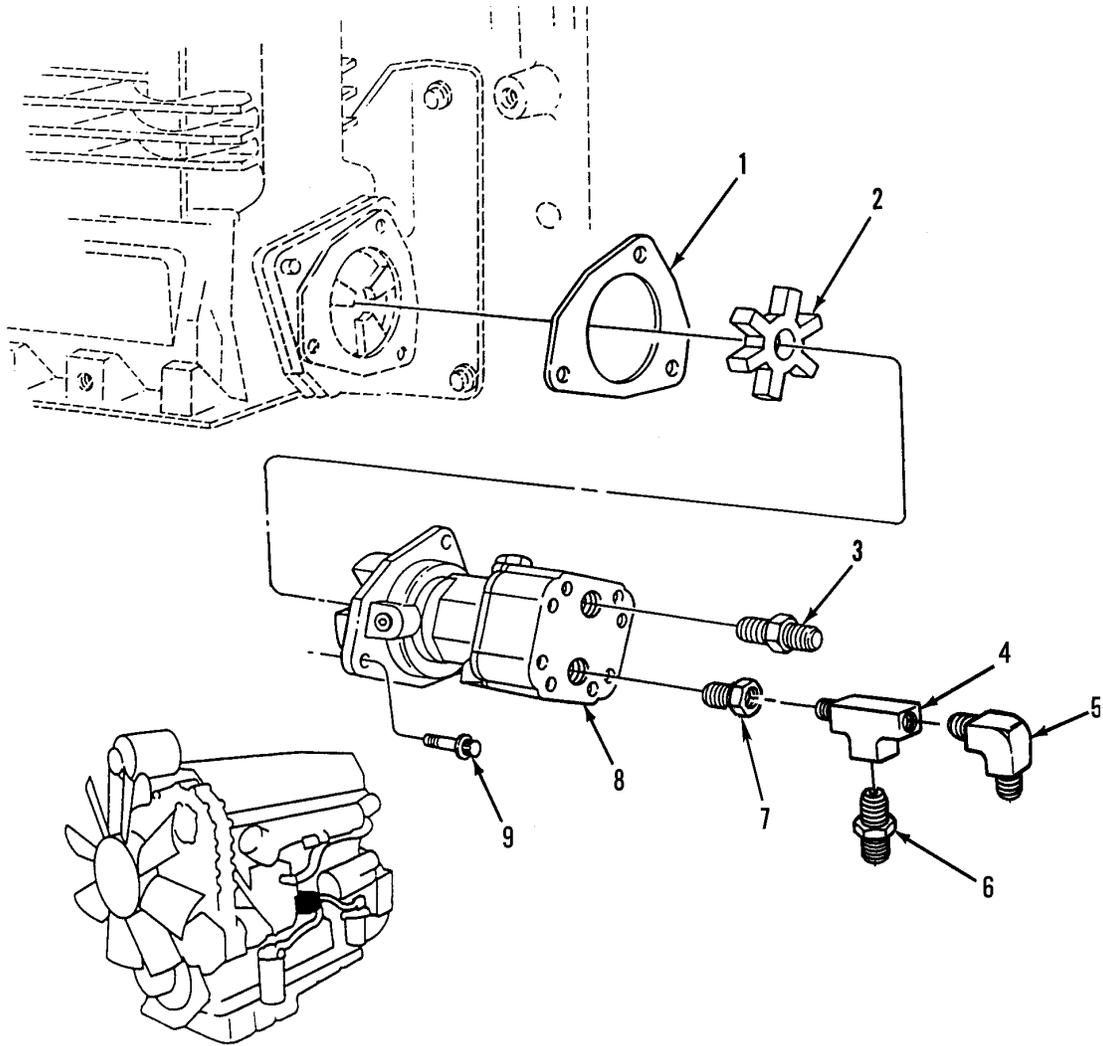

342-1375

Figure 29. Fuel Pumps

SECTION II			TM9-2320-302-24P			
(1)	(2)	(3)	(4)	(5)	(6)	(7)
ITEM	SMR			PART		
NO	CODE	NSN	CAGEC	NUMBER	DESCRIPTION AND USABLE ON CODES(UOC)	QTY
GROUP 0302 FUEL PUMPS						
FIG. 29 FUEL PUMPS						
1	PAOZZ	5330013192035	72582	23505248	GASKET PART OF KIT P/N 23512691.....	1
2	PAOZZ	3010013208941	72582	23505249	INSERT,FLEXIBLE COU.....	1
3	PAOZZ	4730011578925	72582	8924148	ADAPTER,STRAIGHT,PI.....	1
4	PAOZZ	4730014553774	72582	23505246	TEE,PIPE TO TUBE.....	1
5	PAOZZ	4730013503589	72582	8924998	ELBOW,TUBE.....	1
6	PAOZZ	4730013193374	72582	8929833	ADAPTER,STRAIGHT.....	1
7	PAOZZ	4730012163331	72582	8925325	BUSHING,PIPE.....	1
8	PAOZZ	4320013178240	70763	1002931	PUMP,ROTARY.....	1
9	PAOZZ	5306013213559	72582	23506222	BOLT,MACHINE M8 X 1.25 X 20-6G, GR10.9.....	3

END OF FIGURE

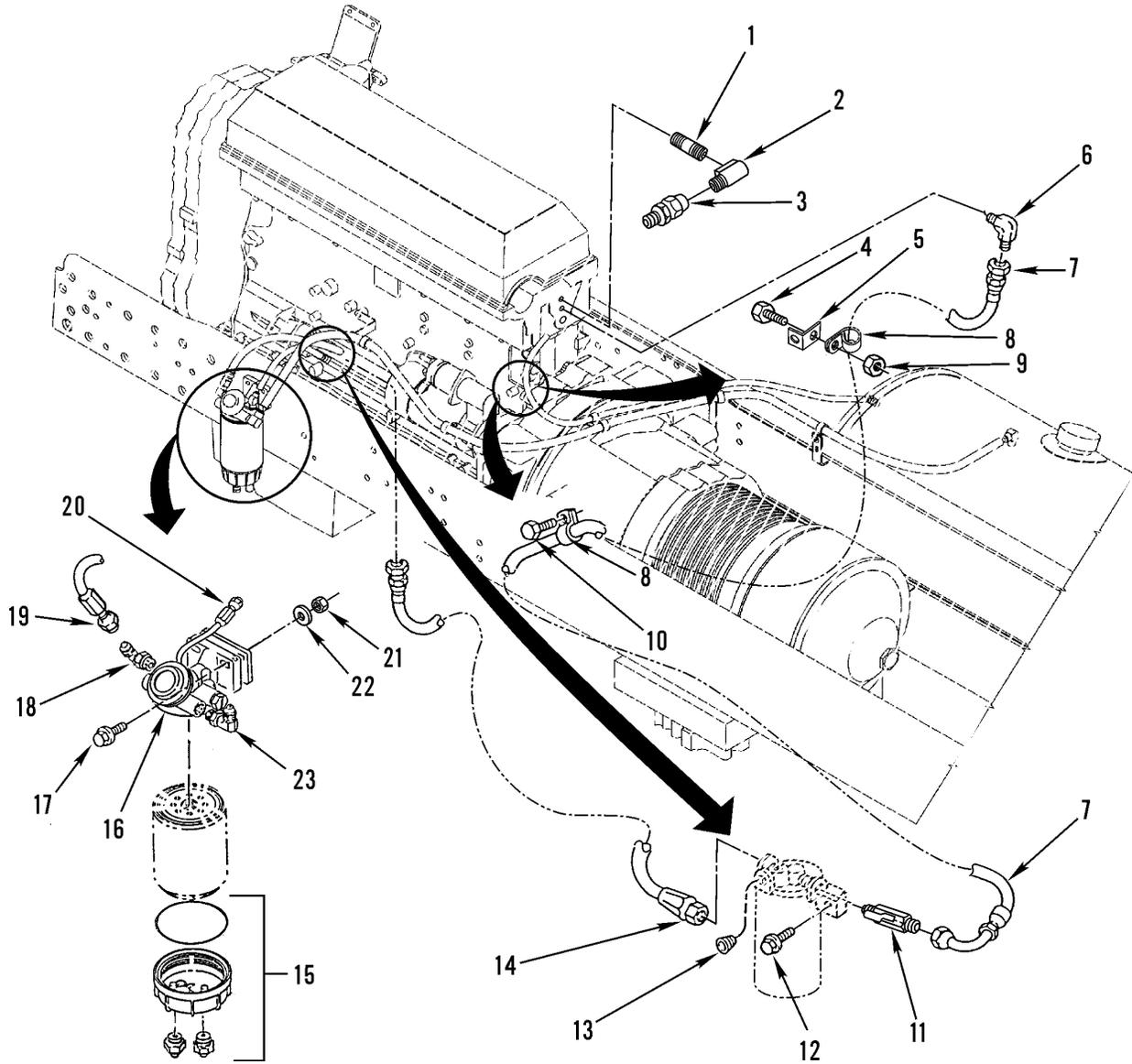

342-1490

Figure 30. Fuel Filter, Hoses, Fittings and Adapters

SECTION II			TM9-2320-302-24P			
(1)	(2)	(3)	(4)	(5)	(6)	(7)
ITEM	SMR			PART		
NO	CODE	NSN	CAGEC	NUMBER	DESCRIPTION AND USABLE ON CODES(UOC)	QTY
GROUP 0302 FUEL PUMPS						
FIG. 30 FUEL FILTER, HOSES, FITTINGS AND ADAPTERS						
1	XDOZZ		72582	23511290	NIPPLE,PIPE.....	1
2	PAOZZ	4730013189668	72582	8929725	ELBOW,PIPE SPECIAL 90 DEG .080R....	1
3	PAOZZ	4820014813346	72582	23516993	VALVE,CHECK.....	1
4	PAOZZ	5306013213559	72582	23506222	BOLT,MACHINE.....	1
5	PAOZZ	5340000782394	72582	5108612	BRACKET,ANGLE.....	1
6	PAOZZ	4730013189675	72582	8929832	ELBOW,PIPE TO HOSE.....	1
7	PAOZZ		72582	MAHU0489	HOSE ASSEMBLY,NONME.....	1
8	XDOZZ		72582	2236474	CLIP,RETAINING.....	3
9	PAOZZ	5310013307592	72582	11507036	NUT,PLAIN,EXTENDED.....	1
10	PAOZZ	5306011857051	11862	11504986	BOLT,MACHINE M8 X 1.25 X 14-6G.....	1
11	PAOZZ	4820014813347	72582	23526109	BALL,VALVE.....	1
12	PAOZZ	5306011857049	7X677	11505299	BOLT,MACHINE M10 X 1.5 X 30-6G, GR10.9.....	2
13	PAOZZ	4730013987635	72582	8923847	PLUG,PIPE.....	1
14	PAOZZ		72582	MAHH0093	HOSE ASSEMBLY,NONME.....	1
15	PAOOO		64678	03-32071-000	SEPARATOR,WATER,LIQ.....	1
16	PAOZZ		72582	23526131	HEAD,FLUID FILTER.....	1
17	PAOZZ	5305000712512	80204	B1821BH025C225N	SCREW,CAP,HEXAGON H 0.25-20UNC X 2.25.....	2
18	PAOZZ		57760	VS249F-8-6	ELBOW,PIPE TO TUBE #8 3/8MPT X 3/4- 16 THD.....	1
19	PAOZZ		64678	A23-12249-020	HOSE ASSEMBLY,NONME 20" LG.....	1
20	PAOZZ		64678	A23-12248-013	HOSE ASSEMBLY,NONME 13", 5/8-18 TREADED ENDS.....	1
21	PAOZZ	5310000874652	81349	M45913/1-6CG5C	NUT,SELF-LOCKING,HE 3/8-16.....	2
22	PAOZZ	5310000806004	96906	MS27183-14	WASHER,FLAT 0.401 ID X 0.805 OD X 0.051 THK.....	4
23	PAOZZ		57760	VS149F-10-6	ELBOW,PIPE TO TUBE #10 3/8MPT X 7/ 8-14 THD.....	1

END OF FIGURE

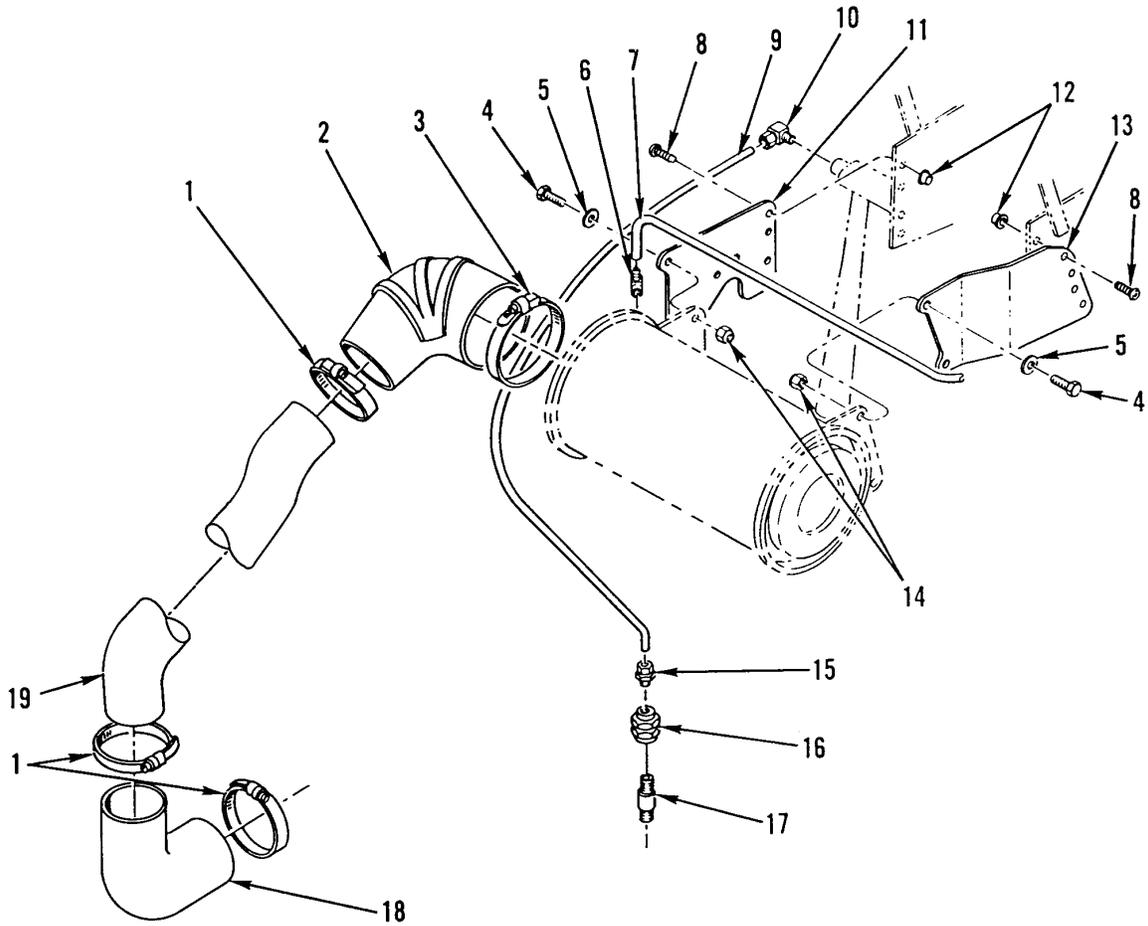

342-1483

Figure 31. Air Cleaner Tubing and Attaching Hardware

SECTION II			TM9-2320-302-24P			
(1)	(2)	(3)	(4)	(5)	(6)	(7)
ITEM	SMR			PART		
NO	CODE	NSN	CAGEC	NUMBER	DESCRIPTION AND USABLE ON CODES(UOC)	QTY
GROUP 0304 AIR CLEANER						
FIG. 31 AIR CLEANER TUBING AND ATTACHING HARDWARE						
1	PFOZZ	4730000054894	7Z588	HTM600	CLAMP,HOSE.....	3
2	PAOZZ	4730014396599	64386	90HL70R50C18	ELBOW,HOSE.....	1
3	PFOZZ	4730011773515	7Z588	HTM800	CLAMP,HOSE.....	1
4	PAOZZ	5305002693211	96906	MS90725-60	SCREW,CAP,HEXAGON H.....	4
5	PAOZZ	5310008094061	96906	MS27183-15	WASHER,FLAT .438 ID X 1.000 OD X .083 THK.....	4
6	PFOZZ	4730012004278	79470	1070X4	ELBOW,PIPE TO HOSE.....	1
7	MOOZZ		64678	12-13367-060	TUBE,NYLON MAKE FROM BULK PFT-4A BLACKX1300 (61424).....	1
8	PFOZZ	5305012987333	64678	23-11036-810	SCREW,TAPPING 1/4 INCH X 5/8.....	8
9	MOOZZ		64678	4246-0410X5	TUBING,NYLON MAKE FROM PN PFT-4A BLACKX1300, CAGE 61424.....	1
10	PAOZZ	4730010864064	93061	269NTA-4-4	ELBOW,PIPE TO TUBE.....	1
11	PFOZZ	5340013405633	64678	03-20537-000	BRACKET,MOUNTING.....	1
12	PFOZZ	3120012987357	64678	23-11037-800	BUSHING,SLEEVE 1/4.....	8
13	PFOZZ	5340013334670	64678	03-17827-000	BRACKET,DOUBLE ANGL.....	1
14	PAOZZ	5310000874652	96906	MS51922-17	NUT,SELF-LOCKING,HE 3/8-16UNC.....	4
15	PFOZZ	4730013325824	64678	A03-20547-000	RESTRICTOR,FLUID FL.....	1
16	PAOZZ	4820013321574	06721	N-30252-D	VALVE,CHECK.....	1
17	PAOZZ	4730013325941	64678	23-09219-021	NIPPLE,PIPE 1/4-18 X 1-1/2 IN.....	1
18	PAOZZ	4730014395324	64386	135HL5	ELBOW,HOSE.....	1
19	PAOZZ	4710014395383	64678	03-22885-000	PIPE,METALLIC.....	1

END OF FIGURE

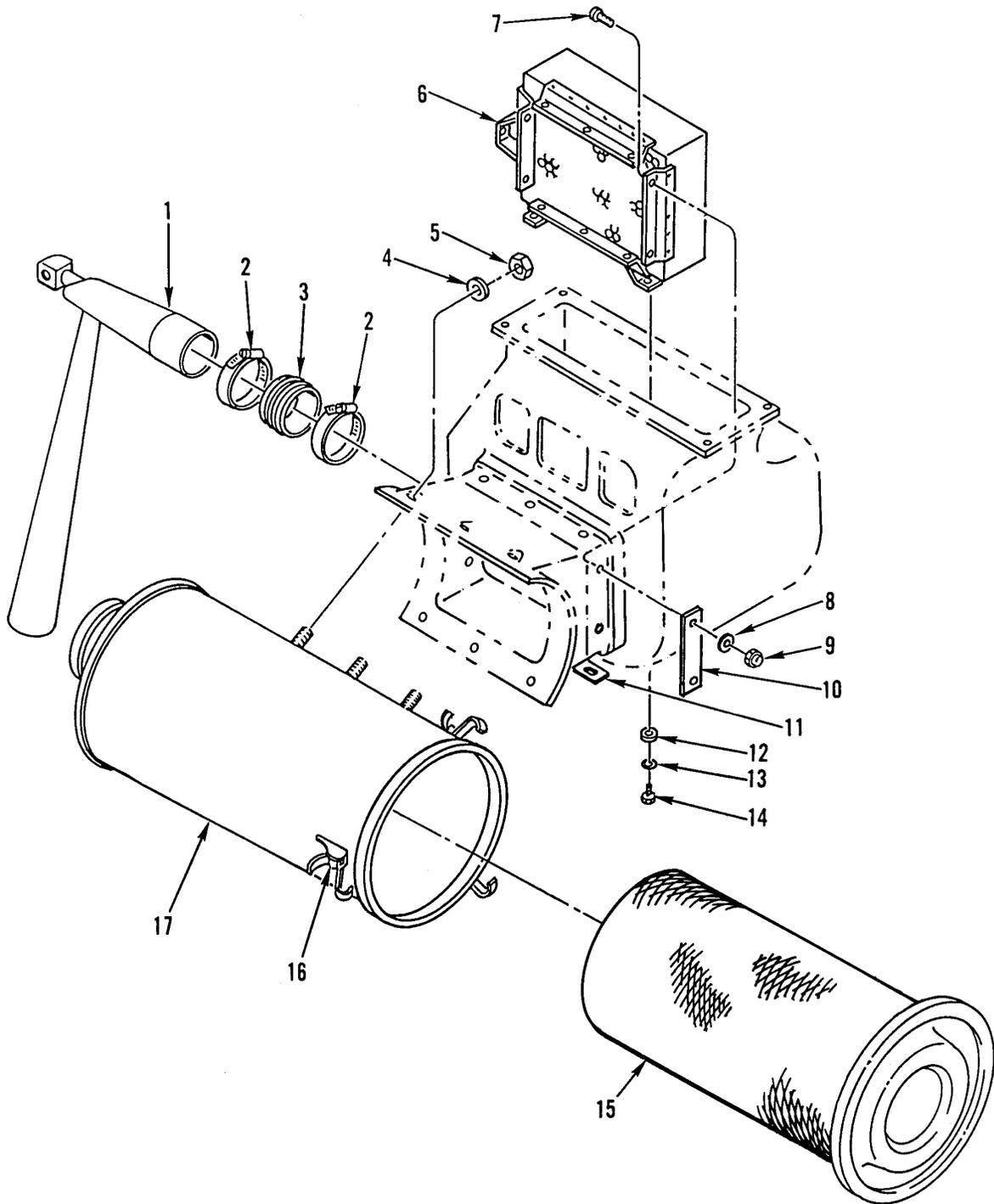

342-1281

Figure 32. Air Cleaner Assembly

SECTION II			TM9-2320-302-24P			
(1)	(2)	(3)	(4)	(5)	(6)	(7)
ITEM	SMR			PART		
NO	CODE	NSN	CAGEC	NUMBER	DESCRIPTION AND USABLE ON CODES(UOC)	QTY
GROUP 0304 AIR CLEANER						
FIG. 32 AIR CLEANER ASSEMBLY						
1	PFOZZ	4710013326121	18265	P52-6745	TUBE ASSEMBLY,METAL.....	1
2	PFOZZ	4730002417651	35871	225-40	CLAMP,HOSE.....	2
3	MOOZZ		18265	P52-6738	COUPLING ASSEMBLY,T MAKE FROM PN 24032, CAGE 24161.....	1
4	PFOZZ	5310000814219	96906	MS27183-12	WASHER,FLAT .344 ID X .688 OD X .065 THK.....	6
5	PFOZZ	5310000881251	81349	M45913/1-4CG5C	NUT,SELF LOCKING,HE 1/4-20UNC.....	6
6	PFOZZ	2940013330723	18265	P52-6746	FILTER ELEMENT,INTA.....	1
7	PAOZZ	5305013469416	18265	P52-6822	SCREW,MACHINE.....	10
8	PAOZZ	5310013483195	18265	P52-6823	WASHER,FLAT.....	10
9	PAOZZ	5310013477051	18265	P52-6824	NUT,SELF-LOCKING,HE.....	10
10	PFOZZ	5340013469471	18265	P52-6817	FRAME,AIR INLET-OUT.....	2
11	PFOZZ	5340013469470	18265	P52-6816	FRAME,AIR INLET-OUT.....	2
12	PAOZZ	5310013326518	18265	P52-6152	WASHER,FLAT .219 ID X 1.00 OD X .060 THK.....	3
13	PAOZZ	5310013327278	18265	P52-6151	WASHER,LOCK NO. 12UNC.....	3
14	PAOZZ	5305013326506	18265	P52-6150	SCREW,TAPPING 12-24UNC X 1/2.....	3
15	PAOZZ	2940013330724	18265	P15-3551	FILTER ELEMENT,INTA.....	1
16	PAOZZ	5342008331236	19207	11602023	LATCH,INTAKE AIR CL.....	1
17	PAOZZ	2940013330720	18265	ECG11-2530	AIR CLEANER,INTAKE.....	1

END OF FIGURE

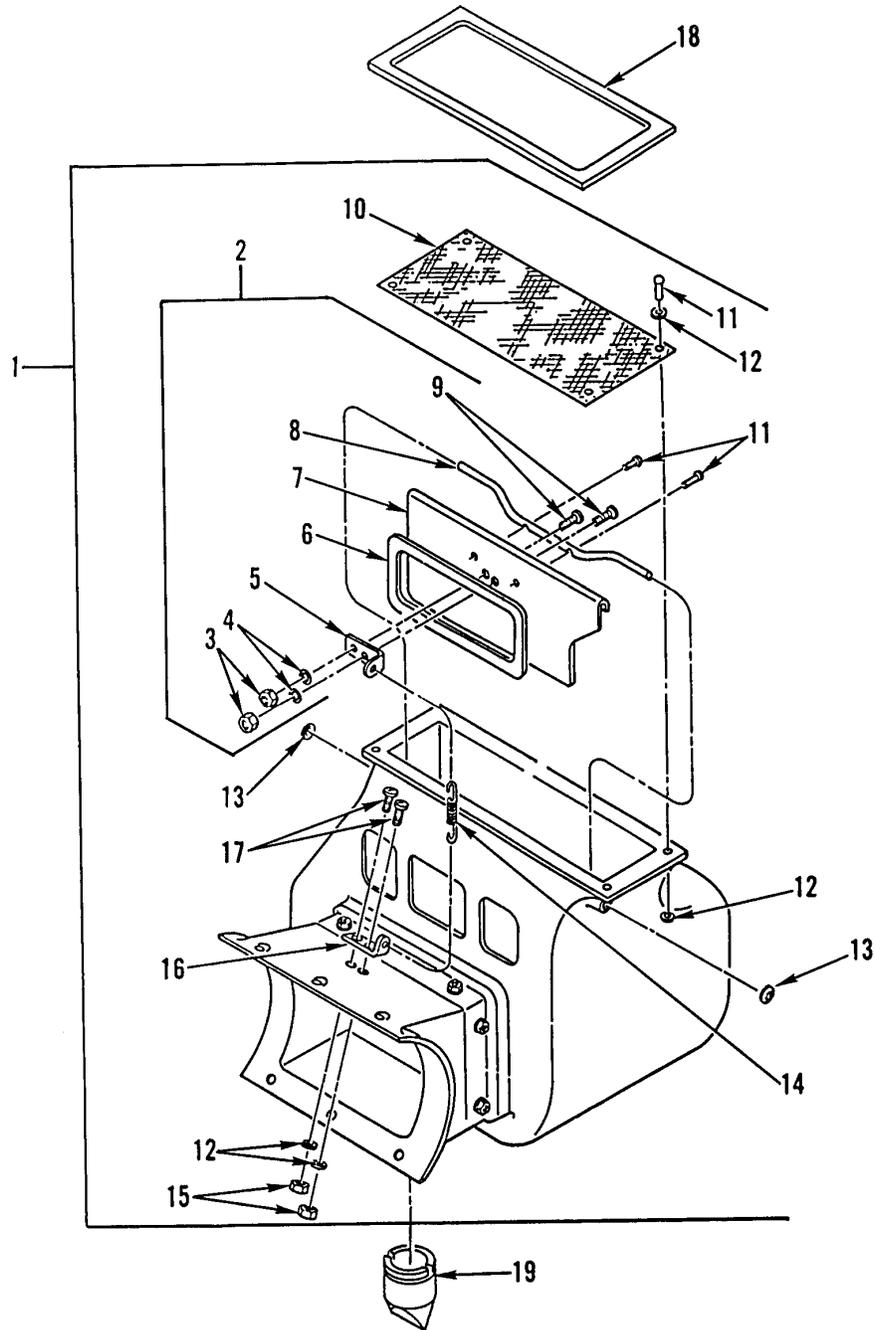

342-1282

Figure 33. Air Cleaner Housing Assembly

SECTION II			TM9-2320-302-24P			
(1)	(2)	(3)	(4)	(5)	(6)	(7)
ITEM	SMR			PART		
NO	CODE	NSN	CAGEC	NUMBER	DESCRIPTION AND USABLE ON CODES(UOC)	QTY
GROUP 0304 AIR CLEANER						
FIG. 33 AIR CLEANER HOUSING ASSEMBLY						
1	PFOOO	4140013291664	18265	P52-6735	HOUSING,CENTRIFUGAL.....	1
2	PFOOO	2540013309287	64678	A03-17757-000	.VALVE,HEATER CONTRO.....	1
3	PFOZZ	5310009825003	96906	MS21045C06	..NUT,SELF-LOCKING,HE .1380-32UNJC-3B.....	1
4	PFOZZ	5310013034701	96906	MS51412-1	..WASHER,FLAT .156 ID X .375 OD....	2
5	PFOZZ	5340013327372	64678	03-17759-000	..BRACKET,ANGLE.....	1
6	PAOZZ	5330013327292	64678	03-17841-000	..GASKET.....	1
7	XAOZZ		64678	NPN-DOOR	..DOOR.....	1
8	PFOZZ	2510013330740	64678	03-17755-000	..HINGE,DOOR VEHICULA.....	1
9	PAOZZ	5305008893000	96906	MS35206-230	..SCREW,MACHINE NO. 6-32 X .500....	2
10	PFOZZ	5335013372521	64678	03-17840-000	.WIRE FABRIC.....	1
11	PFOZZ	5320010321043	56563	101624-01	.RIVET,BLIND.....	7
12	PAOZZ	5310013034701	96906	MS51412-1	.WASHER,FLAT .156 ID X .375 OD....	14
13	PFOZZ	5340013315739	70655	8868	.CLIP,SPRING TENSION.....	2
14	PFOZZ	5360010942428	06092	E0300-037-2000M	.SPRING,HELICAL,EXTE.....	1
15	PAOZZ	5310009825003	96906	MS21045C06	.NUT,SELF-LOCKING,HE .1380-32UNJC-3B.....	2
16	PFOZZ	5340013327372	64678	03-17759-000	.BRACKET,ANGLE.....	1
17	PAOZZ	5305008893000	96906	MS35206-230	.SCREW,MACHINE NO. 6-32 X .500....	4
18	PAOZZ	5330013463816	64678	03-20618-000	GASKET.....	1
19	PFOZZ	2520013499996	64678	03-20493-000	BREATHER.....	1

END OF FIGURE

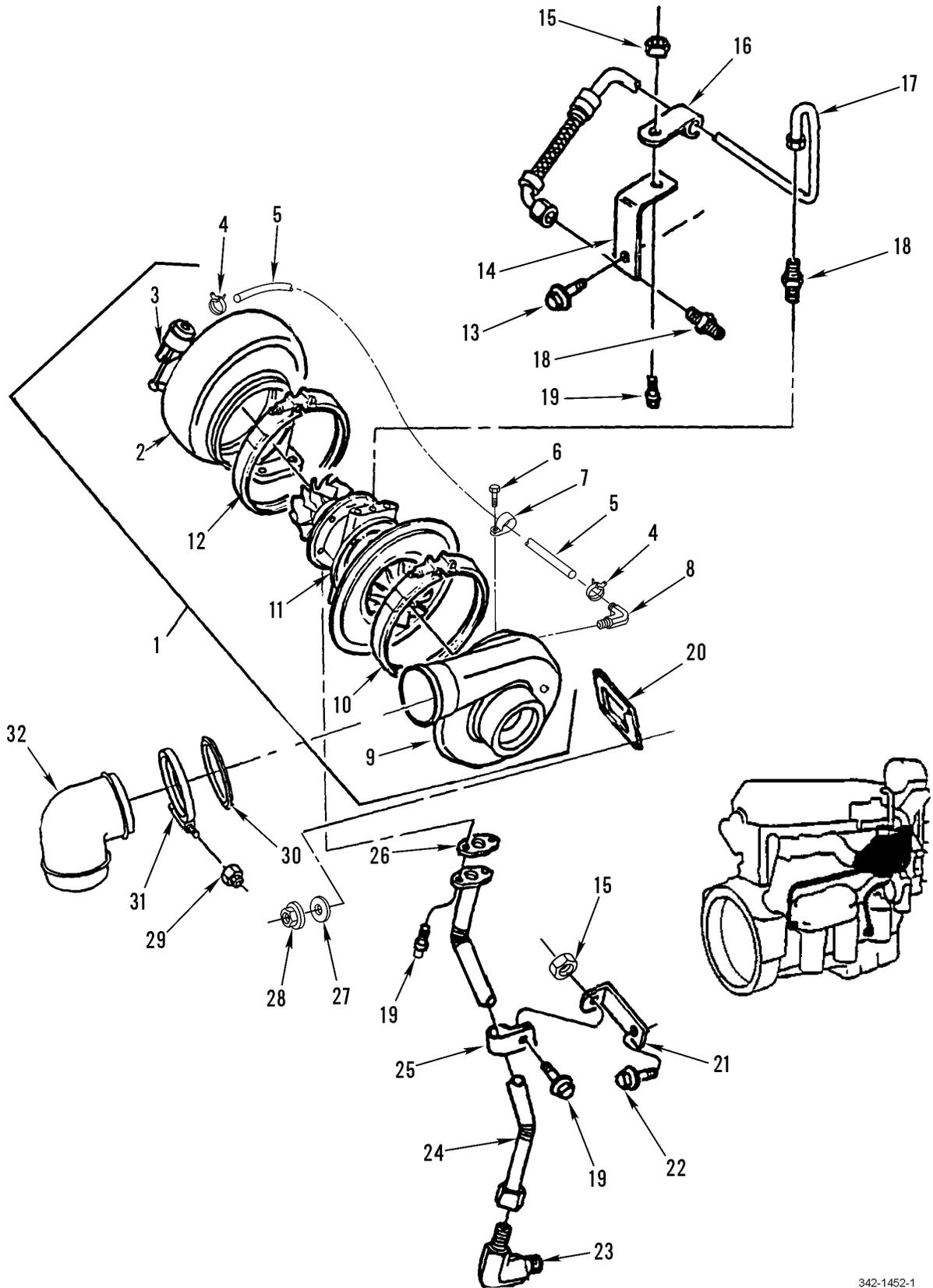
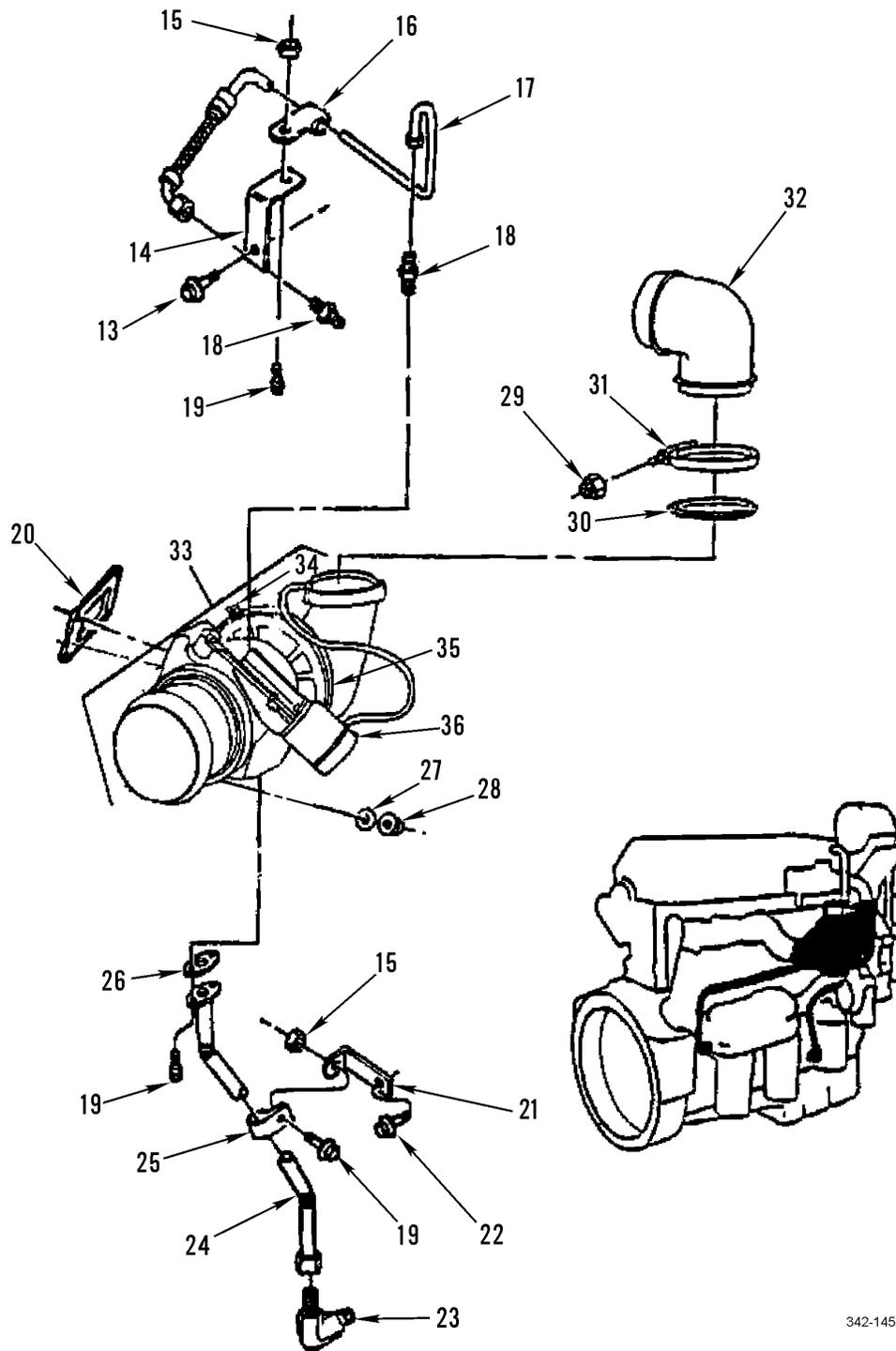

Figure 34. Turbochargers (Sheet 1 of 2)



342-1452-2

Figure 34. Turbochargers (Sheet 2 of 2)

SECTION II			TM9-2320-302-24P			
(1)	(2)	(3)	(4)	(5)	(6)	(7)
ITEM	SMR			PART		
NO	CODE	NSN	CAGEC	NUMBER	DESCRIPTION AND USABLE ON CODES(UOC)	QTY
					GROUP 0305 SUPERCHARGER, BLOWER TURBOCHARGER, OR ALTITUDE COMPENSATOR	
					FIG. 34 TURBOCHARGERS	
1	PBFHH		72582	23522188	TURBOSUPERCHARGER, E GARRETT MODEL..	1
2	XDHHH		08179	451911-27	.HOUSING, AIR COMPRES USE WITH GARRETT MODEL ONLY.....	1
3	PFHZZ		72582	23523120	.ACTUATOR, LINEAR, AIR USE WITH GARRETT MODEL ONLY.....	1
4	KFFZZ		08179	400696-7	.CLAMP, LOOP USE WITH GARRETT MODEL ONLY PART OF KIT P/N 23521436.....	2
5	KFFZZ		08179	400729-111	.HOSE, NONMETALLIC 24" LG USE WITH GARRETT MODEL ONLY PART OF KIT P/N 23521436.....	1
6	KFFZZ		08179	449289-610	.SCREW, MACHINE USE WITH GARRETT MODEL ONLY PART OF KIT P/N 23521436..	1
7	KFFZZ		08179	449094-5	.CLIP, HOSE USE WITH GARRETT MODEL ONLY PART OF KIT P/N 23521436.....	1
8	XDFZZ		08179	400698-1	.ELBOW, PIPE TO TUBE USE WITH GARRETT MODEL ONLY.....	1
9	XDHZZ		08179	447844-17	.HOUSING, AIR COMPRES USE WITH GARRETT MODEL ONLY.....	1
10	XDHZZ		08179	446401-795	.CLAMP, LOOP USE WITH GARRETT MODEL ONLY.....	1
11	PFHZZ		08179	451638-7	.HOUSING, SUPERCHARGE USE WITH GARRETT MODEL ONLY.....	1
12	PFHZZ		08179	446397-460	.CLAMP, LOOP USE WITH GARRETT MODEL ONLY.....	1
13	PAFZZ	5306013203940	72582	23505062	BOLT, MACHINE M10 X 1.50 X 40, GR10.9	1
14	XDFZZ		72582	23505086	BRACKET, ANGLE.....	1
15	PAFZZ	5310013307592	72582	11507036	NUT, PLAIN, EXTENDED M8 X 1.25-6H, GR10.0.....	2
16	PAFZZ	5340014406000	72582	23509256	CLIP, SPRING TENSION.....	1
17	XDFZZ		72582	23521390	TUBE, METALLIC.....	1
18	PAFZZ	4730013193374	72582	8929833	ADAPTER, STRAIGHT.....	2
19	PAFZZ	5306013213559	72582	23506222	BOLT, MACHINE.....	4
20	PAFZZ	5330010374129	72582	8929529	GASKET PART OF KIT P/N 23512691 PART OF KIT P/N 23501572.....	1
21	XDFZZ		72582	23515353	BRACKET.....	1
22	PAFZZ	5306011865367	11862	11503454	BOLT, MACHINE M10 X 1.50 X 20-6G, GR10.9.....	1
23	PAFZZ	4730013193469	72582	23505039	ELBOW, PIPE TO TUBE.....	1
24	XDFZZ		72582	23515354	TUBE ASSEMBLY, METAL.....	1
25	PAFZZ	5342007630482	72582	2476233	CLIP.....	1
26	PAFZZ	5330013198671	72582	8929285	GASKET PART OF KIT P/N 23512691 PART OF KIT P/N 23501572.....	1
27	PAFZZ	5310013212441	72582	8929169-B	WASHER, FLAT 10.5 X 20.6 X 3.4 MM...	4
28	PAFZZ	5310012507679	72582	23521131	NUT.....	4
29	PAHZZ	5310008775796	96906	MS21044-N4	NUT, SELF-LOCKING, HE 1/4-20.....	1
30	PAFZZ	5331014407531	72582	23508408	O-RING.....	1

SECTION II			TM9-2320-302-24P			
(1)	(2)	(3)	(4)	(5)	(6)	(7)
ITEM	SMR			PART		
NO	CODE	NSN	CAGEC	NUMBER	DESCRIPTION AND USABLE ON CODES(UOC)	QTY
31	PAFZZ	5342014404428	72582	23519094	COUPLING, CLAMP, GROO.....	1
32	XDFZZ		72582	23518563	ELBOW, 90 DEGREE.....	1
33	PBFHH		72582	23522188	TURBOSUPERCHARGER, E WARNER TYPE....	1
34	PAHZZ	5310008775796	96906	MS21044-N4	.NUT, SELF-LOCKING, HE 1/4-20, USED WITH WARNER MODEL ONLY.....	1
35	PFHZZ		72582	23523809	.CLAMP, LOOP USED WITH WARNER MODEL ONLY.....	1
36	PFHZZ		72582	23523811	.ACTUATOR, LINEAR, AIR USED WITH WARNER MODEL ONLY.....	1

END OF FIGURE

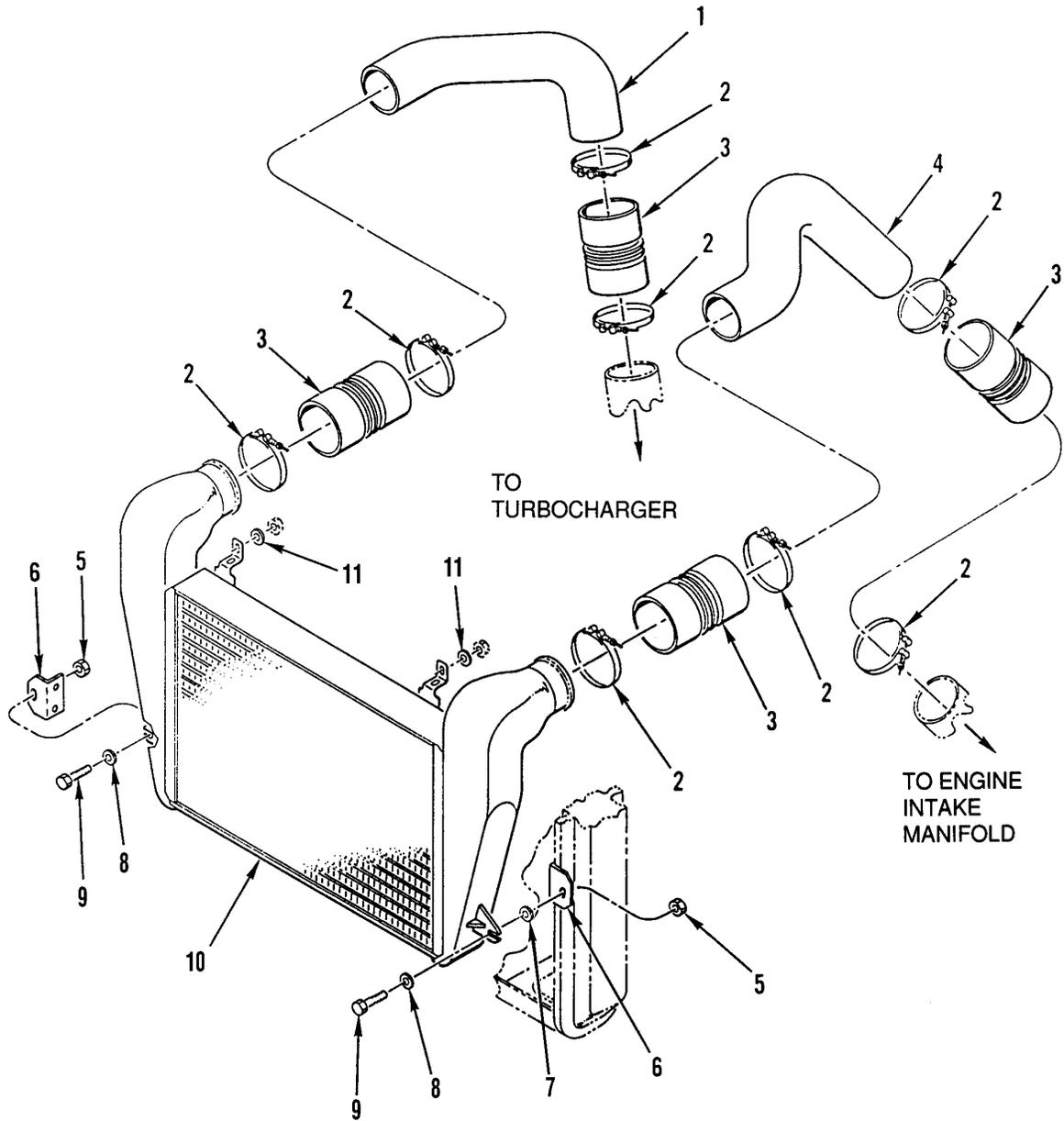

342-1311

Figure 35. Charge Air Cooler

SECTION II			TM9-2320-302-24P			
(1)	(2)	(3)	(4)	(5)	(6)	(7)
ITEM	SMR			PART		
NO	CODE	NSN	CAGEC	NUMBER	DESCRIPTION AND USABLE ON CODES(UOC)	QTY
					GROUP 0305 SUPERCHARGER, BLOWER TURBOCHARGER, OR ALTITUDE COMPENSATOR	
					FIG. 35 CHARGE AIR COOLER	
1	PFOZZ	4710014786094	64678	01-22830-000	TUBE, BENT, METALLIC R.H.....	1
2	PAOZZ	4730013325450	54646	94143-0428	CLAMP, HOSE.....	8
3	PAOZZ	4720013326010	64678	01-21200-001	HOSE, AIR DUCT.....	4
4	PFOZZ	4710013322408	64678	01-16492-000	TUBE, BENT, METALLIC.....	1
5	PAOZZ	5310011511036	45152	115307A	NUT, SELF-LOCKING, EX 3/8-16.....	4
6	XDOZZ		64678	01-23127-000	BRACKET, ANGLE.....	2
7	PAOZZ	5340011571009	76005	CB-1120-3	MOUNT, RESILIENT.....	4
8	PAOZZ	5310013370369	70655	3553	WASHER, FLAT .430 ID X 1.250 OD X .050 THK.....	2
9	PAOZZ	5306014761456	64678	23-11007-200	BOLT, SHOULDER 3/8-16 X 2.00.....	4
10	XDOZZ		64678	01-23132-000	COOLER, AIR, EVAPORAT.....	1
11	PAOZZ	5310007737618	96906	MS15795-814	WASHER, FLAT.....	2

END OF FIGURE

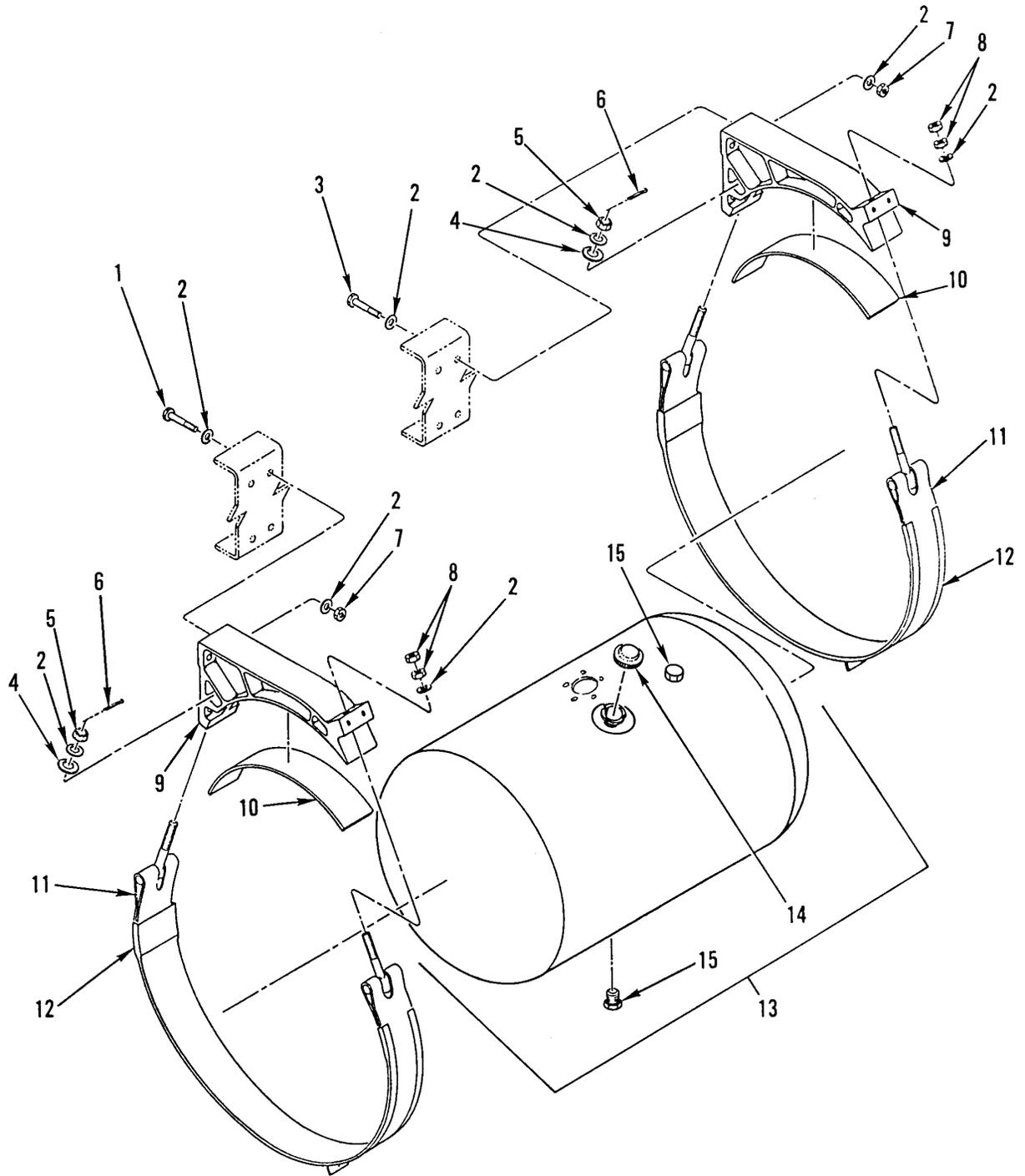

342-1484

Figure 36. Fuel Tank Assembly and Attaching Hardware

SECTION II			TM9-2320-302-24P			
(1)	(2)	(3)	(4)	(5)	(6)	(7)
ITEM	SMR			PART		
NO	CODE	NSN	CAGEC	NUMBER	DESCRIPTION AND USABLE ON CODES(UOC)	QTY
					GROUP 0306 TANKS, LINES, FITTINGS, HEADERS	
					FIG. 36 FUEL TANK ASSEMBLY AND ATTACHING HARDWARE	
1	PAOZZ	5305007247228	80204	B1821BH063C300N	SCREW,CAP,HEXAGON H 5/8-11 X 3.00	4
					REAR BRACKET.....	
2	PAOZZ	5310007208819	96906	MS15795-821	WASHER,FLAT 0.688 ID X 1.750 OD....	18
3	PAOZZ	5305007247225	80204	B1821BH063C275N	SCREW,CAP,HEXAGON H 5/8-11UNC-2A X	4
					2.750 FRONT BRACKET.....	
4	PAOZZ	5365014463725	64678	23-12062-000	SPACER,SPECIAL SHAP.....	2
5	PAOZZ	5310009154891	96906	MS51967-21	NUT,PLAIN,HEXAGON 5/8-11UNC.....	4
6	PAOZZ	5315000137214	88044	AN380-4-7	PIN,COTTER 1/8 X 1-3/4.....	2
7	PAOZZ	5310014748453	64678	23-12063-000	NUT,SELF-LOCKING,HE 5/8-11 UNC-2B,	2
					NYLON LOCKING.....	
8	PAOZZ	5310002694040	96906	MS51922-49	NUT,SELF-LOCKING,HE 5/8-11UNC.....	8
9	XDOZZ		64678	03-21347-000	BRACKET,FUEL TANK.....	2
10	XDOZZ		64678	03-21346-000	CUSHION, ARCHED.....	2
11	XDOZZ		64678	03-27310-004	CUSHION, ARCHED.....	2
12	XDOZZ		64678	A03-30459-000	MOUNTING BRACKET.....	2
13	XDOOO		64678	A03-28234-201	TANK, FUEL,ENGINE.....	1
14	PAOZZ		78528	1961A	.CAP,FILLER OPENING.....	1
15	PAOZZ	4730013325998	64678	23-09200-005	...PLUG,PIPE.....	1

END OF FIGURE

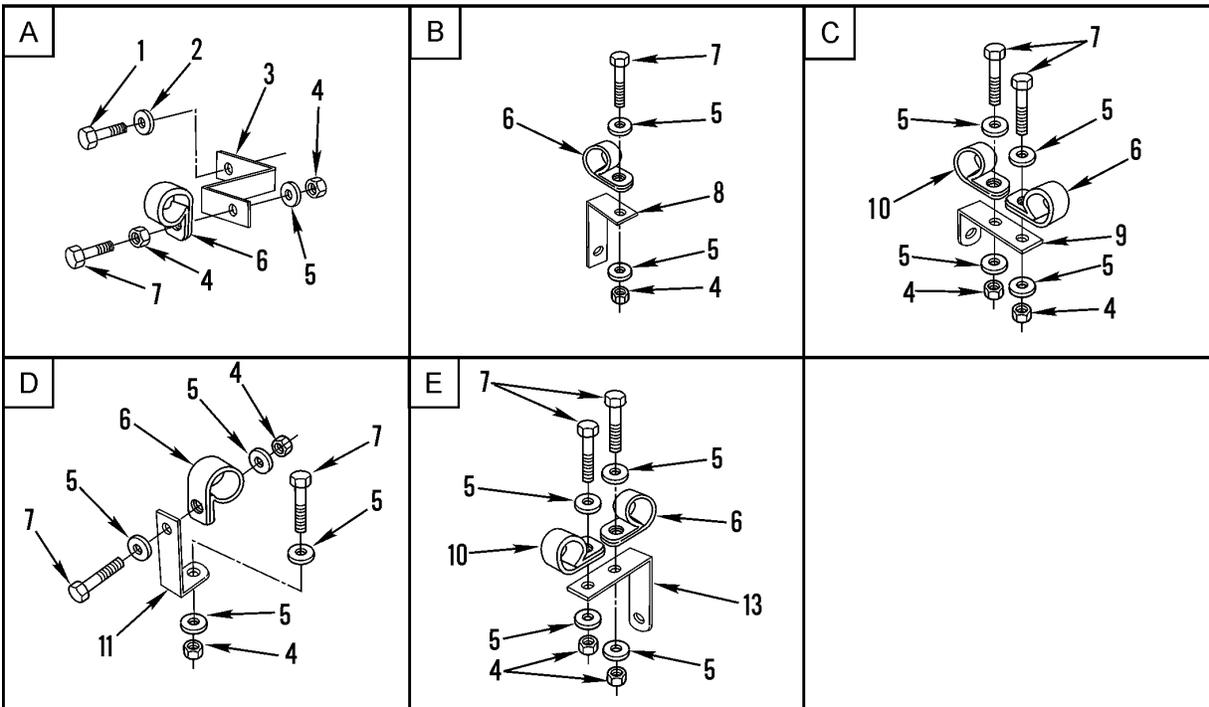
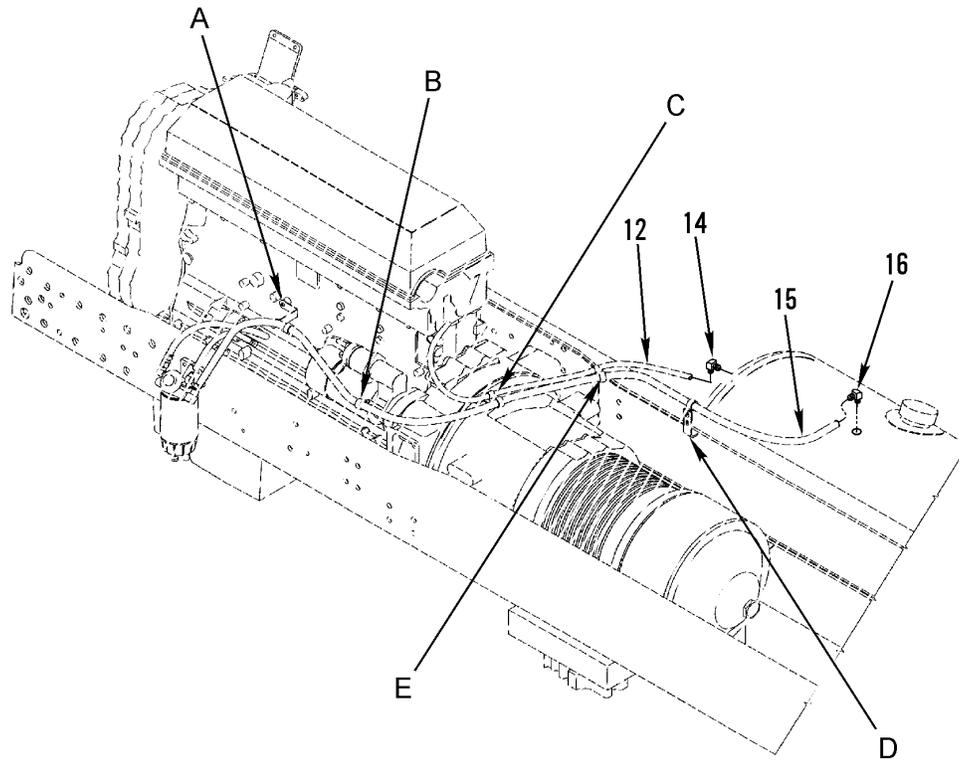
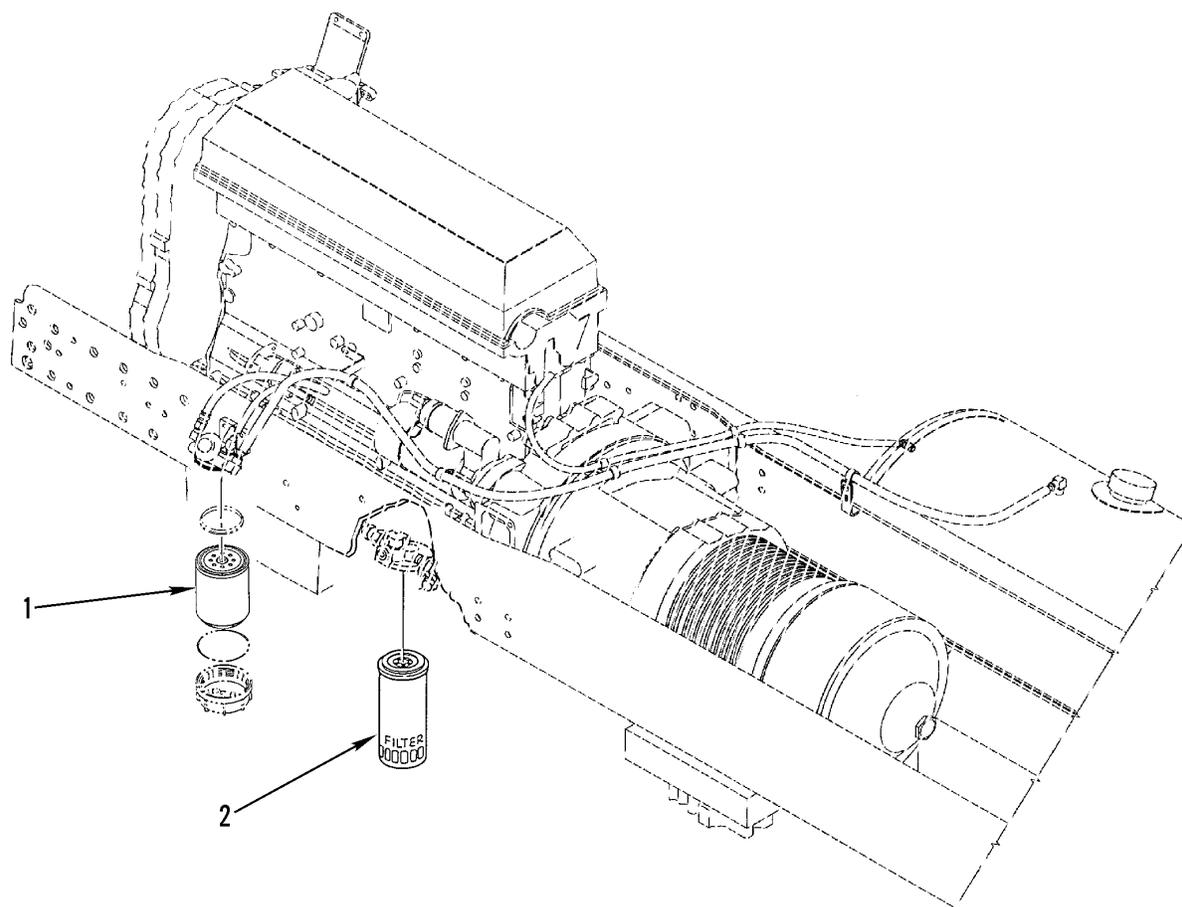

Figure 37. Fuel Lines and Fittings

SECTION II			TM9-2320-302-24P			
(1)	(2)	(3)	(4)	(5)	(6)	(7)
ITEM	SMR			PART		
NO	CODE	NSN	CAGEC	NUMBER	DESCRIPTION AND USABLE ON CODES(UOC)	QTY
GROUP 0306 TANKS, LINES, FITTINGS, HEADERS						
FIG. 37 FUEL LINES AND FITTINGS						
1	PAOZZ	5306012867169	64678	000933 010020	BOLT,MACHINE.....	1
2	XDOZZ		64678	221822 010000	WASHER,FLAT M10.....	1
3	PFOZZ		64678	23-09130-028	BRACKET,DOUBLE ANGL.....	1
4	PAOZZ	5310013570854	64678	23-09900-104	NUT,SELF-LOCKING,HE 1/4-20.....	5
5	PAOZZ	5310008094058	96906	MS27183-10	WASHER,FLAT 1/4".....	10
6	PFOZZ		64678	23-12231-004	CLAMP,LOOP.....	5
7	PAOZZ	5305000680502	96906	MS90725-6	SCREW,CAP,HEXAGON H 1/4-20 X 0.75..	5
8	PFOZZ		64678	23-09130-007	BRACKET,ANGLE.....	1
9	PAOZZ	5340013284367	64678	23-09130-000	BRACKET,ANGLE.....	1
10	PFOZZ		64678	23-12231-003	CLAMP,LOOP.....	2
11	PFOZZ		64678	23-09130-012	BRACKET,ANGLE.....	1
12	PAOZZ		64678	A23-12248-051	HOSE ASSEMBLY,NONME 51" LG.....	1
13	PFOZZ		64678	06-20733-001	BRACKET,DOUBLE ANGL.....	1
14	PAOZZ	4730002546228	41947	A4889	ELBOW,PIPE TO TUBE.....	1
15	PAOZZ		64678	A23-12250-100	HOSE ASSEMBLY,NONME 100" LG.....	1
16	PAOZZ	4730006139339	93061	249F-10-8	ELBOW,PIPE TO TUBE.....	1

END OF FIGURE



342-1453

Figure 38. Fuel Filter Elements

SECTION II			TM9-2320-302-24P			
(1)	(2)	(3)	(4)	(5)	(6)	(7)
ITEM	SMR			PART		
NO	CODE	NSN	CAGEC	NUMBER	DESCRIPTION AND USABLE ON CODES(UOC)	QTY

GROUP 0306 TANKS, LINES, FITTINGS,
HEADERS

FIG. 38 FUEL FILTER ELEMENTS

1	PAOZZ	2910014430385	55752	R90-DDC-01	FILTER ELEMENT,FLUI INCLUDES	1
					GASKET & O-RING.....	
2	PAOZZ	2910010228183	70040	TP916	FILTER ELEMENT,FLUI.....	1

END OF FIGURE

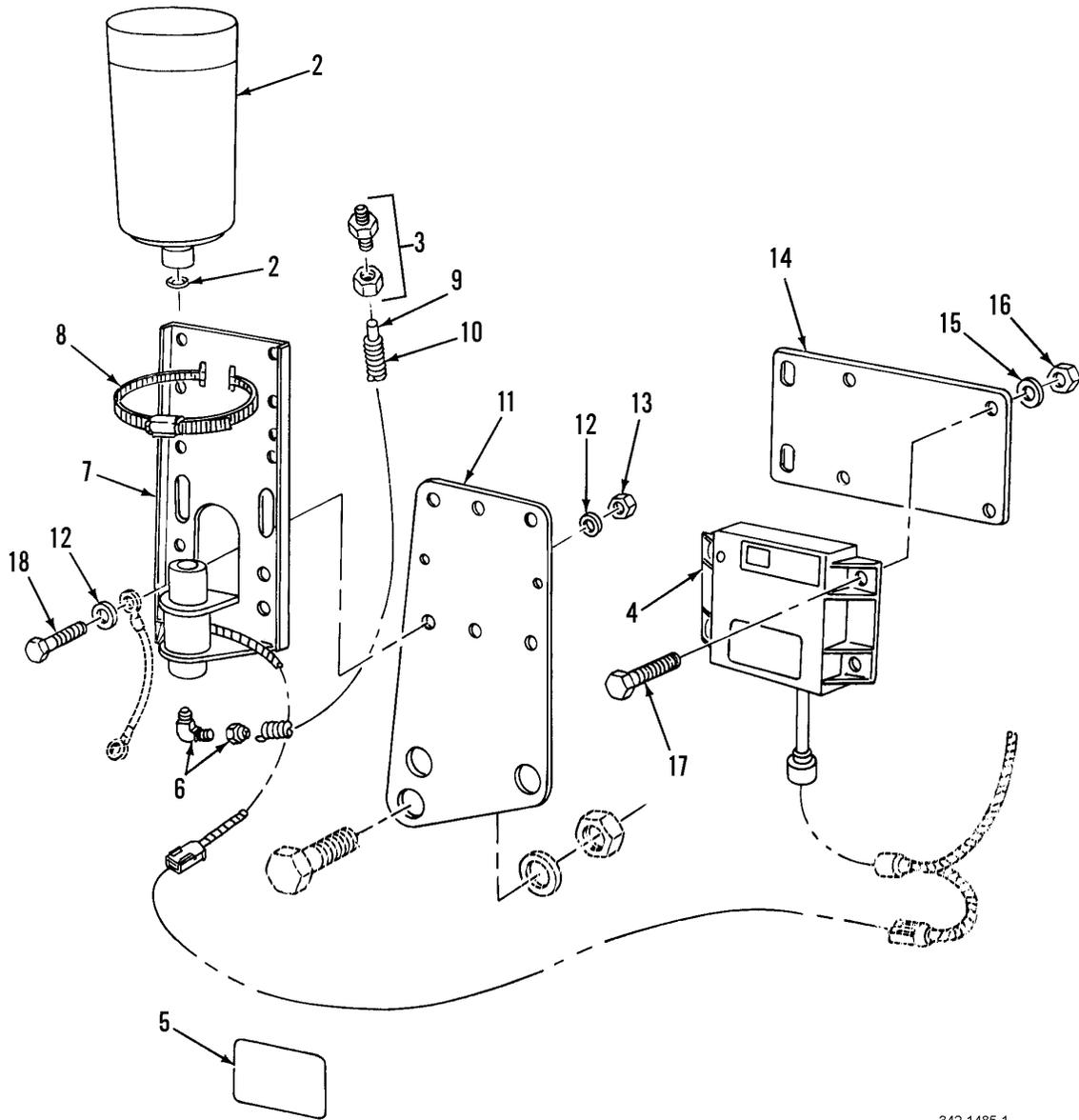
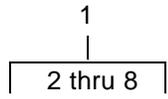

342-1485-1

Figure 39. Ether Starting Aid (Sheet 1 of 2)

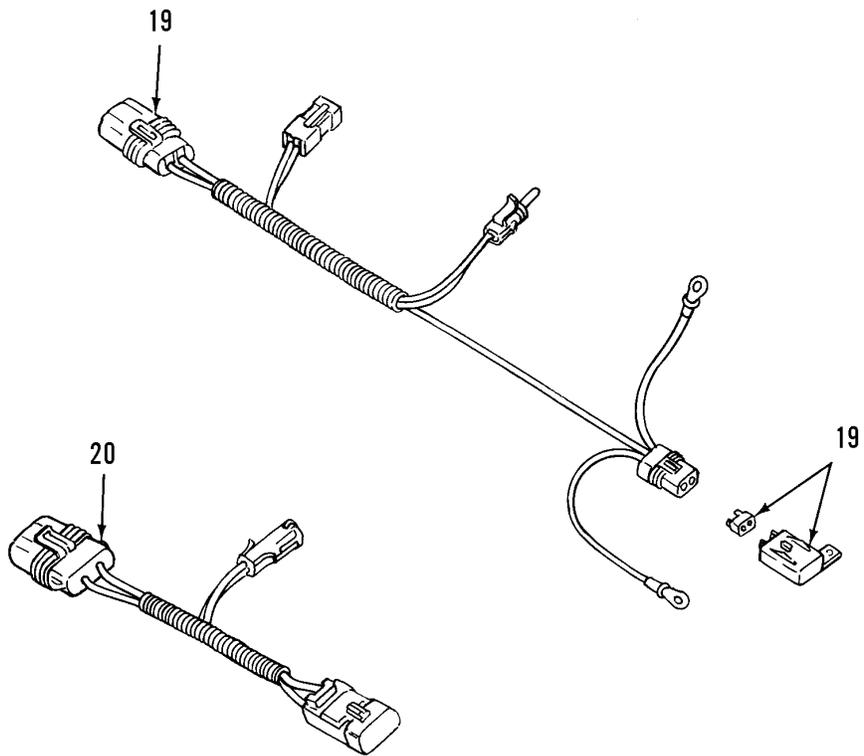

342-1485-2

Figure 39. Ether Starting Aid (Sheet 2 of 2)

SECTION II			TM9-2320-302-24P			
(1)	(2)	(3)	(4)	(5)	(6)	(7)
ITEM	SMR			PART		
NO	CODE	NSN	CAGEC	NUMBER	DESCRIPTION AND USABLE ON CODES(UOC)	QTY
GROUP 0311 ENGINE STARTING AIDS						
FIG. 39 ETHER STARTING AID						
1	PAOOZ	2910014478036	72582	23517769	PARTS KIT,ETHER,STA.....	1
2	PAOZZ	2910006469727	78280	LP-535-1	.CYLINDER,ENGINE STA DDEC III & DDEC IV ONLY.....	1
3	PAOZZ	2910014477956	72582	23517771	.ATOMIZER,STARTING F.....	1
4	PAOZZ	5945014479142	72582	23517781	.RELAY,SOLID STATE.....	1
5	XAOZZ		72582	23518506	.LABEL,AIR FILTER INSTALL ON AIR CLEANER.....	1
6	PAOZZ	4730014473214	72582	23517696	.ELBOW,PIPE.....	1
7	PFOZZ	4810014474578	72582	23517779	.VALVE,SOLENOID.....	1
8	PAOZZ	5340014469624	72582	23517706	.CLAMP,LOOP.....	1
9	MFOZZ		64678	48-00100-829X36	TUBING,NONMETALLIC 36 INCH,MAKE FROM BULK 4246-02277 (64678).....	1
10	MFOZZ		64678	48-02217-025X36	TUBING,NONMETALLIC 36 INCH,MAKE FROM BULK 64498R (77060).....	1
11	XDOZZ		64678	01-23808-001	BRACKET,MOUNTING.....	1
12	PAOZZ	5310008094061	96906	MS27183-15	WASHER,FLAT 3/8 INCH.....	8
13	PAOZZ	5310000874652	81349	M45913/1-6CG5C	NUT,SELF-LOCKING,HE 3/8-16.....	4
14	XDOZZ		64678	01-23914-000	PLATE,MOUNTING.....	1
15	PAOZZ	5310000814219	96906	MS27183-12	WASHER,FLAT 5/16.....	4
16	PAOZZ	5310008807744	96906	MS51967-5	NUT,PLAIN,HEXAGON 5/16-18.....	4
17	PAOZZ	5306002264827	80204	B1821BH031C100N	BOLT,MACHINE 5/16-18 X 1.00.....	4
18	PAOZZ	5305000680510	80204	B1821BH038C100N	SCREW,CAP,HEXAGON H 3/8-16 X 1.00..	4
19	PAOZZ	6150014475601	64678	A06-24520-000	CABLE ASSEMBLY,SPEC.....	1
20	PAOZZ	6150014475600	64678	A06-24521-000	CABLE ASSEMBLY,SPEC.....	1

END OF FIGURE

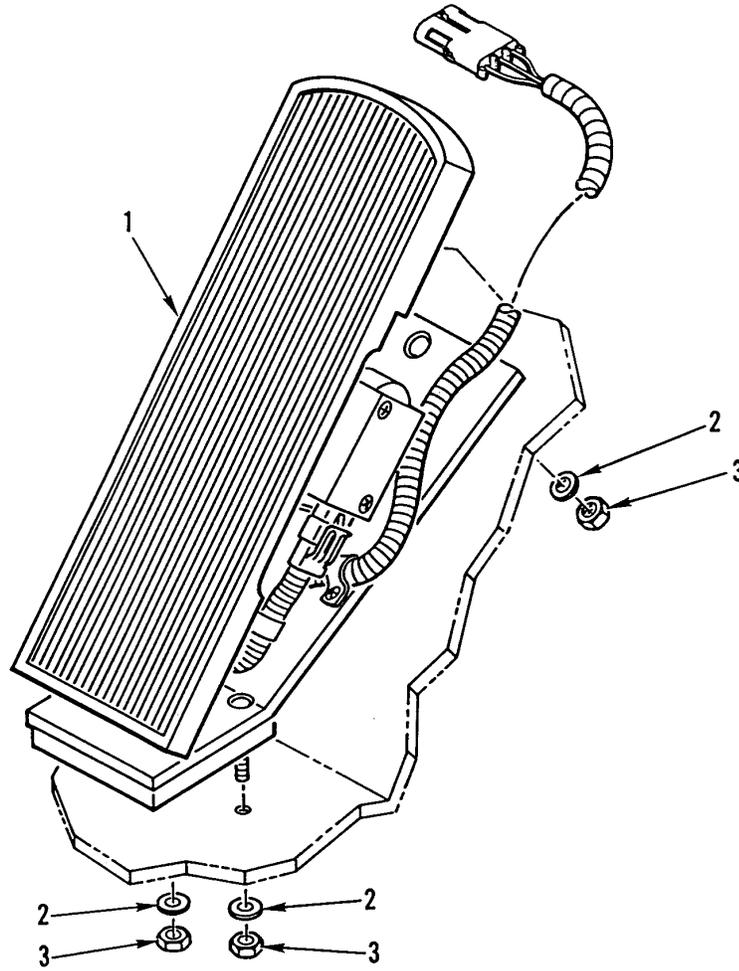

342-1284

Figure 40. Electronic Throttle Assembly

SECTION II			TM9-2320-302-24P			
(1)	(2)	(3)	(4)	(5)	(6)	(7)
ITEM	SMR			PART		
NO	CODE	NSN	CAGEC	NUMBER	DESCRIPTION AND USABLE ON CODES(UOC)	QTY
					GROUP 0312 ACCELERATOR, THROTTLE, OR CHOKE CONTROLS	
					FIG. 40 ELECTRONIC THROTTLE	
1	PBOZZ		11331	351345	PEDAL,CONTROL.....	1
2	PAOZZ	5310008094058	96906	MS27183-10	WASHER,FLAT .281 ID X .625 OD X .065 THK.....	5
3	PAOZZ	5310000881251	81349	M45913/1-4CG5C	NUT,SELF LOCKING,HE 1/4-20UNC.....	4

END OF FIGURE

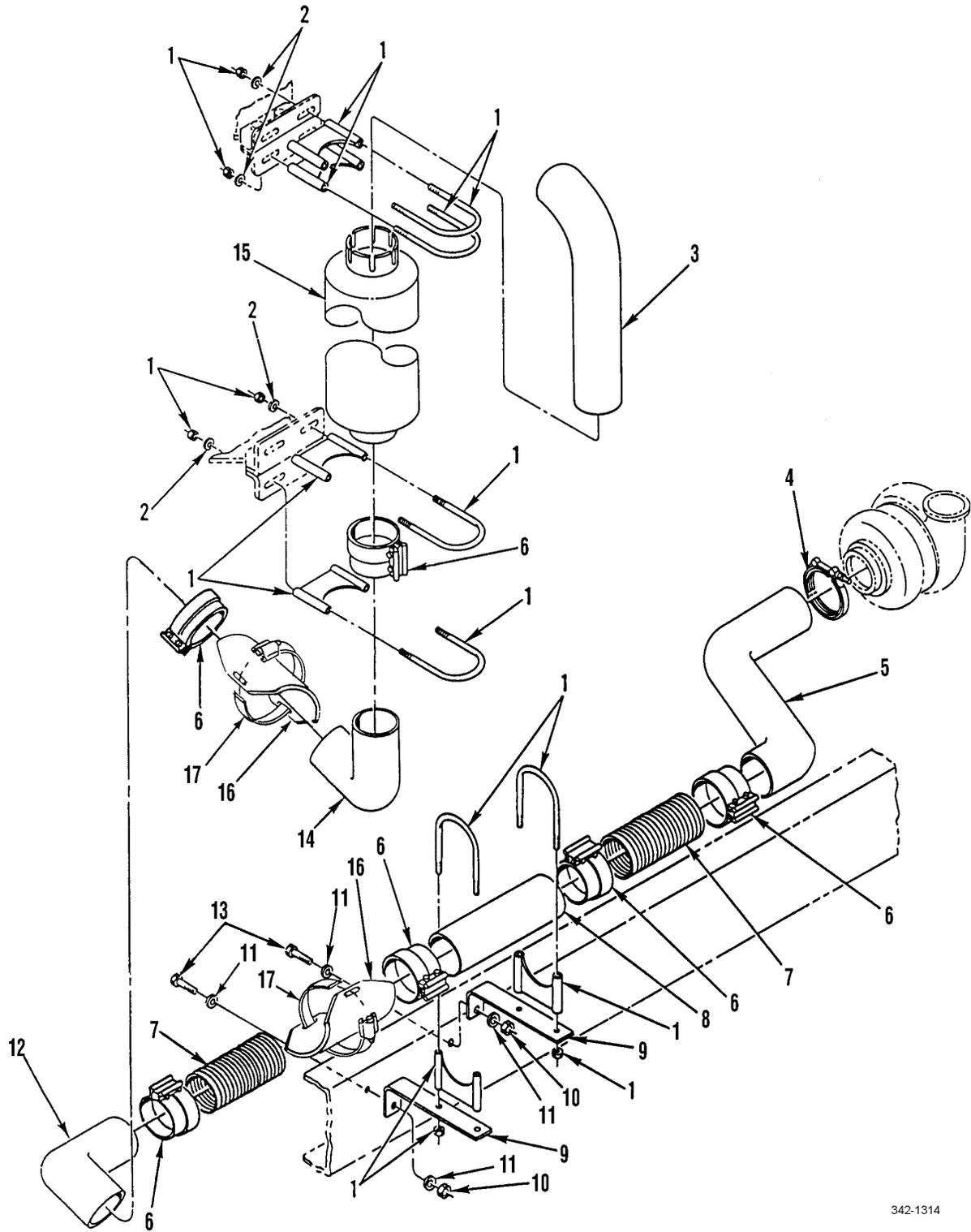

342-1314

Figure 41. Exhaust Pipes and Mounting Hardware

SECTION II			TM9-2320-302-24P			
(1)	(2)	(3)	(4)	(5)	(6)	(7)
ITEM	SMR			PART		
NO	CODE	NSN	CAGEC	NUMBER	DESCRIPTION AND USABLE ON CODES(UOC)	QTY
GROUP 04 EXHAUST SYSTEM						
GROUP 0401 MUFFLER AND PIPES						
FIG. 41 EXHAUST PIPES AND						
1	PAOZZ	5340010796715	01652	U-500	CLAMP, LOOP.....	6
2	PAOZZ	5310000806004	96906	MS27183-14	WASHER, FLAT .406 ID X .812 OD X .065 THK.....	2
3	PAOZZ	2990014786006	64678	04-19338-017	PIPE, EXHAUST.....	1
4	PFOZZ		15434	186917	COUPLING, CLAMP, GROO.....	1
5	PAOZZ	2990014786000	64678	04-17094-030	PIPE, EXHAUST.....	1
6	PAOZZ	5340014790540	64678	04-19249-000	CLAMP, LOOP.....	6
7	PAOZZ	4720014786009	64678	04-19105-013	HOSE, METALLIC.....	2
8	PAOZZ	2990014395607	64678	04-09152-026	PIPE, EXHAUST.....	1
9	PAOZZ	2990013299899	64678	04-14209-000	HANGER, ENGINE EXHAU.....	2
10	PAOZZ	5310002256993	96906	MS51922-33	NUT, SELF-LOCKING, HE 1/2-13UNC.....	4
11	PAOZZ	5310011091977	19207	11628332-2	WASHER, FLAT .531 ID X 1.062 OD X .18 THK.....	4
12	PAOZZ	2990013299896	64678	04-15105-000	CONNECTOR, EXHAUST P.....	1
13	PAOZZ	5305000712070	80204	B1821BH050C175N	SCREW, CAP, HEXAGON H.....	2
14	PAOZZ	2990013299895	64678	04-12099-000	CONNECTOR, EXHAUST P.....	1
15	PAOZZ	2990013300004	76700	22867-A	MUFFLER, EXHAUST.....	1
16	PAOZZ	2990014792450	64678	04-16076-000	HEAT SHIELD, EXHAUST.....	1
17	PAOZZ	4730003551872	7Z588	QS300-M96H	CLAMP, HOSE.....	1

END OF FIGURE

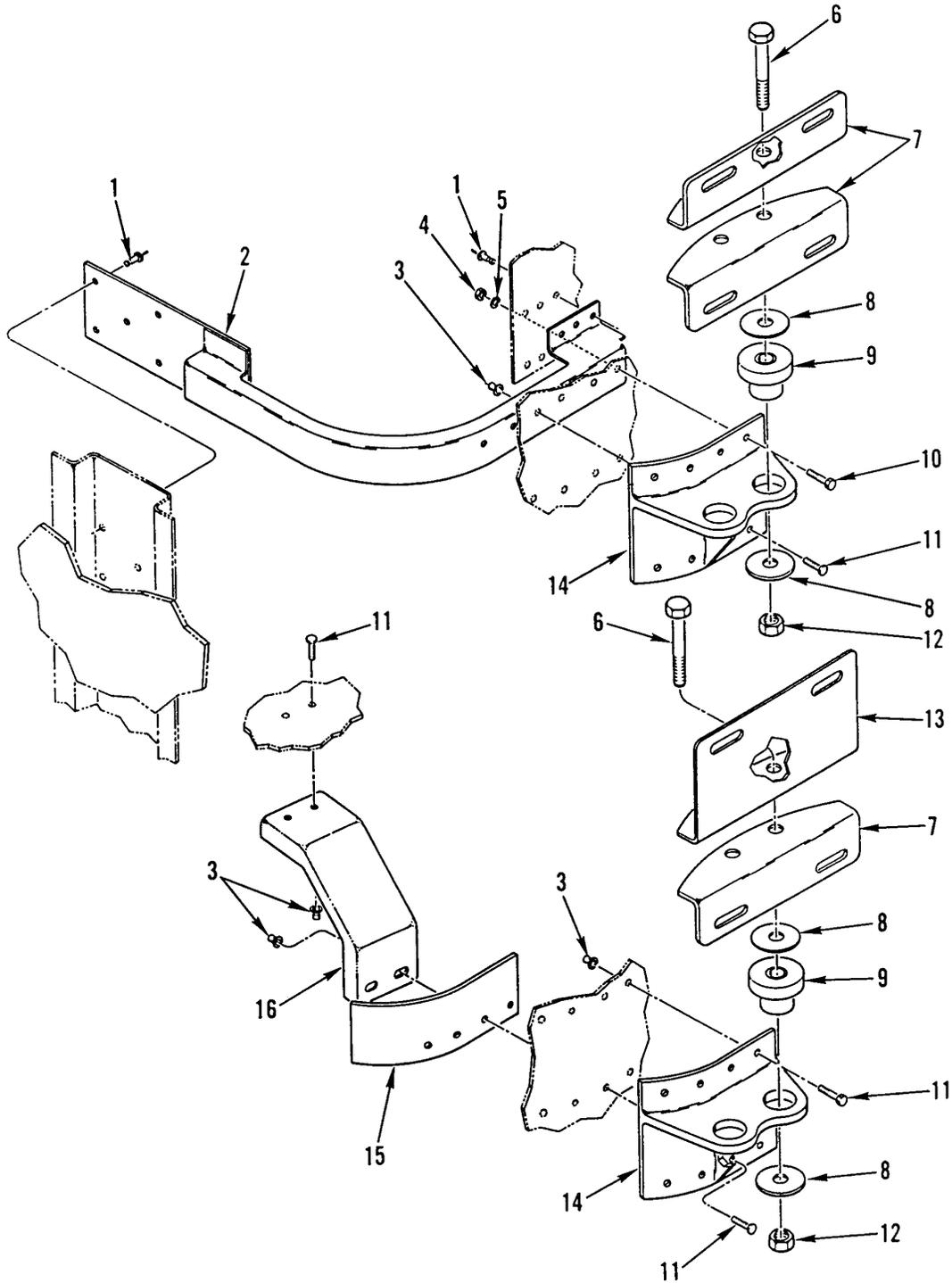

342-1285

Figure 42. Muffler Mounting Hardware

SECTION II			TM9-2320-302-24P			
(1)	(2)	(3)	(4)	(5)	(6)	(7)
ITEM	SMR			PART		
NO	CODE	NSN	CAGEC	NUMBER	DESCRIPTION AND USABLE ON CODES(UOC)	QTY
GROUP 0401 MUFFLER AND PIPES						
FIG. 42 MUFFLER MOUNTING HARDWARE						
1	PAOZZ	5320012702952	19738	2771-0617	RIVET,BLIND.....	11
2	XDOZZ		64678	A18-20931-000	BRACKET,STIF,UPR.....	1
3	PAOZZ	3120012987357	19738	1981-0800	BUSHING,SLEEVE 1/4 INCH.....	16
4	PAOZZ	5310000881251	81349	M45913/1-4CG5C	NUT,SELF LOCKING,HE 1/4-20UNC.....	2
5	PAOZZ	5310008094058	96906	MS27183-10	WASHER,FLAT .281 ID X .625 OD X.065 THK.....	2
6	PAOZZ	5305000712072	80204	B1821BH050C225N	SCREW,CAP,HEXAGON H 1/2-13UNC-2A X 2.250.....	4
7	PFOZZ	5340013284368	64678	04-10259-000	BRACKET,ANGLE.....	3
8	PAOZZ	5310007375065	19207	7375065	WASHER,FLAT 17/32 ID.....	8
9	PAOZZ	5342013319919	64386	1449-380-55640	MOUNT,RESILIENT.....	4
10	PAOZZ	5305002253843	80204	B1821BH025C100N	SCREW,CAP,HEXAGON H 1/4-20UNC-2A X 1.000.....	2
11	PFOZZ	5305012987333	64678	23-11036-810	SCREW,TAPPING 1/4 INCH X 5/8.....	14
12	PAOZZ	5310007680318	96906	MS51967-14	NUT,PLAIN,HEXAGON 1/2-13.....	4
13	PFOZZ	5340013284369	64678	04-11848-000	BRACKET,ANGLE.....	1
14	XDOZZ		64678	04-16554-001	BRACKET,SUPPORT.....	2
15	XDOZZ		64678	04-12585-000	PLATE,BACKING.....	1
16	XDOZZ		64678	04-12584-000	BRACKET,SUPPORT.....	1

END OF FIGURE

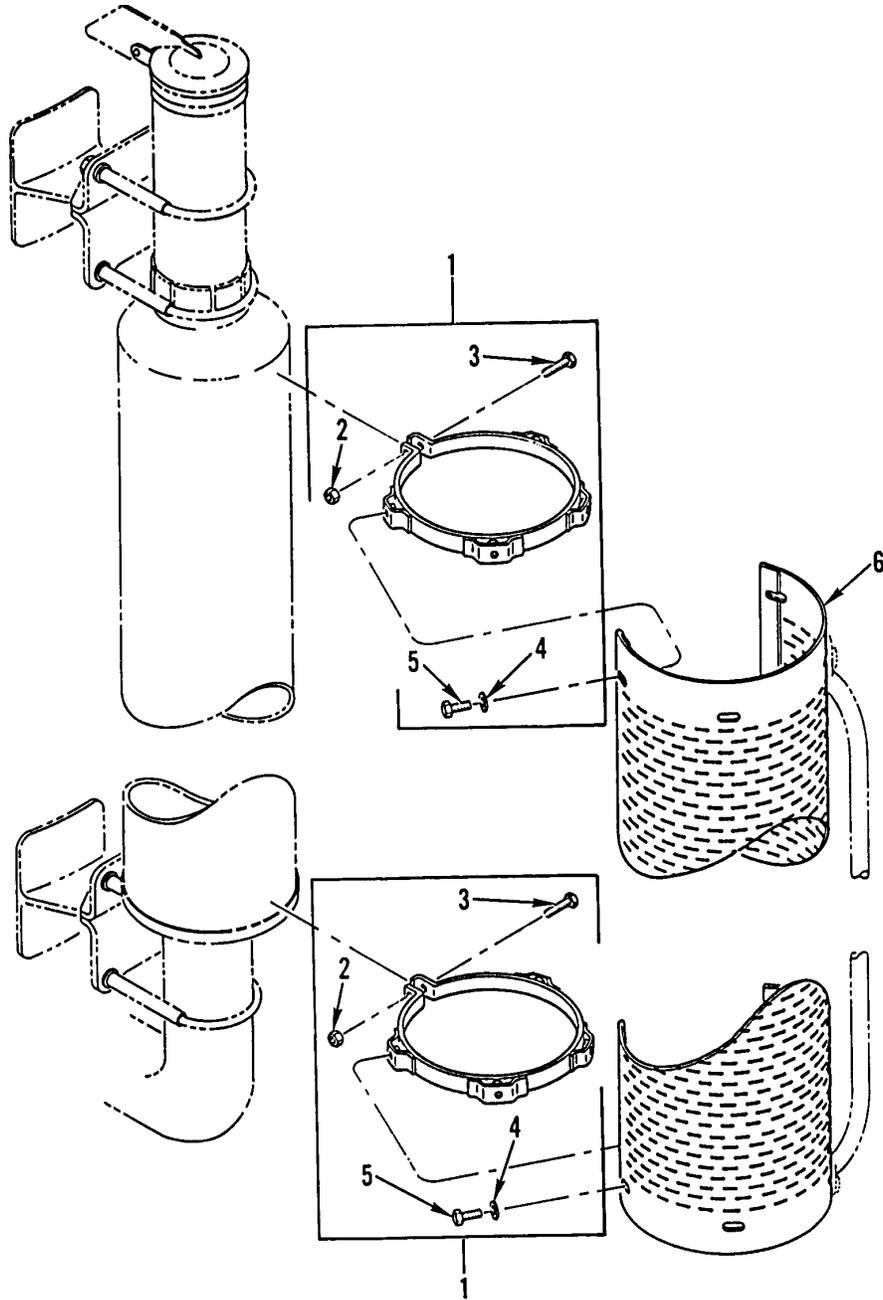

342-1315

Figure 43. Muffler Heat Shield

SECTION II			TM9-2320-302-24P			
(1)	(2)	(3)	(4)	(5)	(6)	(7)
ITEM	SMR			PART		
NO	CODE	NSN	CAGEC	NUMBER	DESCRIPTION AND USABLE ON CODES(UOC)	QTY
GROUP 0401 MUFFLER AND PIPES						
FIG. 43 MUFFLER HEAT SHIELD						
1	PAOZZ	5340013330160	76700	Q-02853	CLAMP, LOOP.....	2
2	PAOZZ	5310004906482	96906	MS9356-06	.NUT, PLAIN, HEXAGON 5/16-18UNC, GR5..	1
3	PAOZZ	5306002264833	80204	B1821BH031C200N	.BOLT, MACHINE 5/16-18UNC X 2, GR5...	1
4	PAOZZ	5310000814219	96906	MS27183-12	.WASHER, FLAT .344 ID X .688 OD X .065 THK.....	4
5	PAOZZ	5306002258492	96906	MS90725-27	.BOLT, MACHINE 5/16-18 X 3/8, GR5....	4
6	PAOZZ	2990013299894	76700	Q-39426	GUARD, MUFFLER-EXHAU.....	1

END OF FIGURE

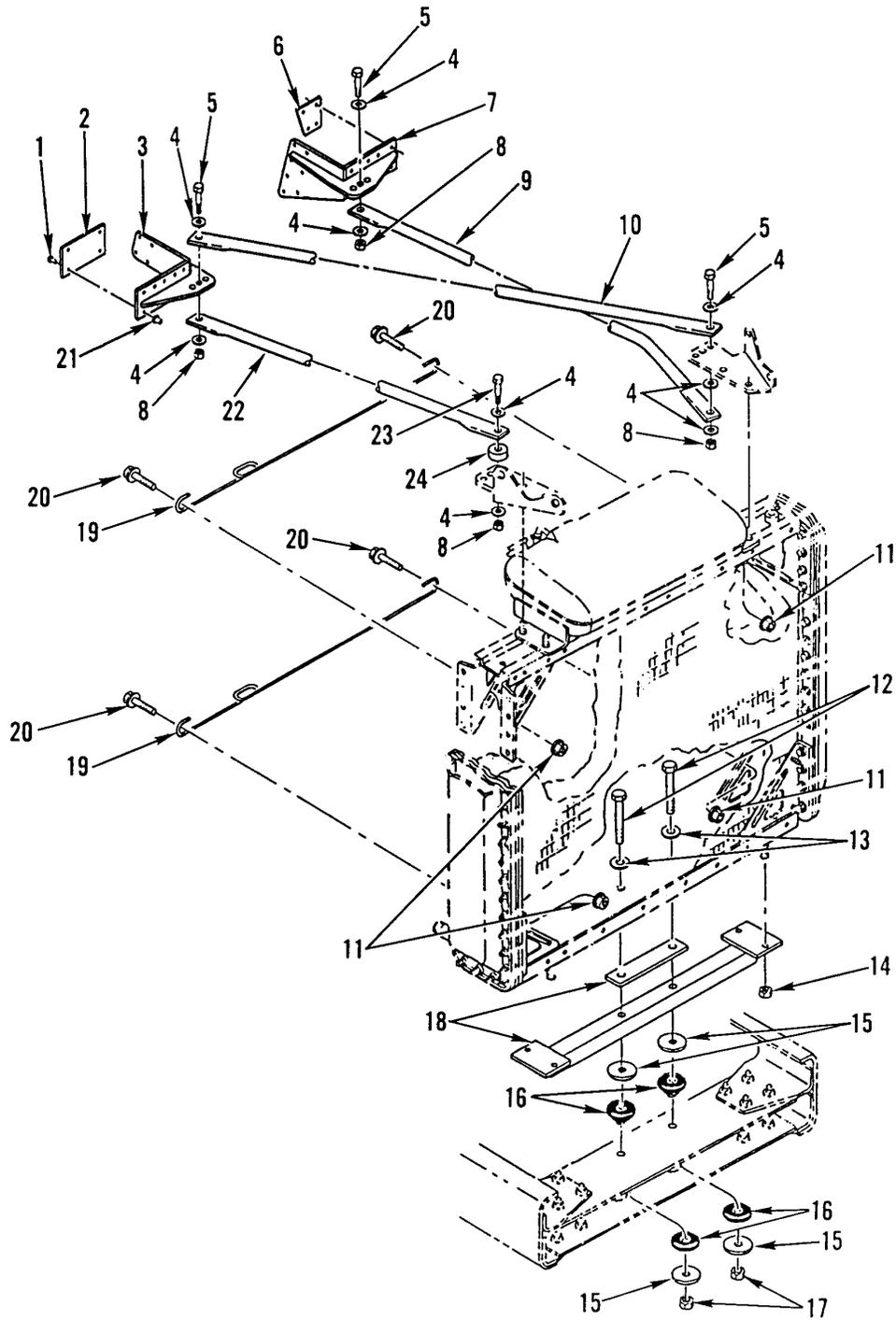

342-1317

Figure 44. Radiator Mounting Hardware

SECTION II			TM9-2320-302-24P			
(1)	(2)	(3)	(4)	(5)	(6)	(7)
ITEM	SMR			PART		
NO	CODE	NSN	CAGEC	NUMBER	DESCRIPTION AND USABLE ON CODES(UOC)	QTY
GROUP 05 COOLING SYSTEM GROUP 0501 RADIATOR, EVAPORATIVE COOLER, OR HEAT EXCHANGER						
FIG. 44 RADIATOR MOUNTING HARDWARE						
1	PAOZZ	5305012987333	19738	1901-0810	SCREW,TAPPING 1/4 INCH X 5/8.....	26
2	PFOZZ	5340013294108	64678	05-13022-000	PLATE,MOUNTING.....	1
3	PFOZZ	5340013293979	64678	A05-12793-001	BRACKET,ANGLE RIGHT.....	1
4	PAOZZ	5310011091977	19207	11628332-2	WASHER,FLAT .531 ID X 1.062 OD X .18 THK.....	9
5	PAOZZ	5305000712069	80204	B1821BH050C150N	SCREW,CAP,HEXAGON H 1/2-13UNC-2A X 1.500.....	3
6	PFOZZ	5340013294107	64678	05-12795-000	PLATE,MOUNTING.....	1
7	PFOZZ	5340013293978	64678	A05-12793-000	BRACKET,ANGLE LEFT.....	1
8	PAOZZ	5310002256993	96906	MS51922-33	NUT,SELF-LOCKING,HE 1/2-13UNC.....	4
9	PAOZZ	5340013294092	64678	05-13033-000	BRACKET,MOUNTING.....	1
10	PAOZZ	5340013294091	64678	05-12952-001	BRACKET,MOUNTING LEFT.....	1
11	PAOZZ	5310001668341	82465	31WLF51618	NUT,PLAIN,EXTENDED 5/16-18.....	2
12	PAOZZ	5305007329207	80204	B1821BH063C550N	SCREW,CAP,HEXAGON H 5/8-11UNC-2A X 5.500.....	2
13	PAOZZ	5310007208819	96906	MS15795-821	WASHER,FLAT .688 ID X 1.750 OD.....	2
14	PAOZZ	5310000874652	96906	MS51922-17	NUT,SELF-LOCKING,HE 3/8-16UNC.....	4
15	PAOZZ	5310011846477	76005	J-2049-54	WASHER,FLAT.....	4
16	PAOZZ	5342013323584	64678	05-16070-000	MOUNT,RESILIENT.....	2
17	PAOZZ	5310002694040	96906	MS51922-49	NUT,SELF-LOCKING,HE 5/8-11UNC.....	2
18	PFOZZ	5340013294106	64678	A05-12792-000	PLATE,MOUNTING.....	1
19	PFOZZ	5340013293719	64678	05-15274-000	HOLDER,SPRING.....	1
20	XDOZZ		73342	9421497	BOLT,SELF-LOCKING .312-18UNC-2A X .639.....	1
21	PAOZZ	3120012987357	19738	1981-0800	BUSHING,SLEEVE 1/4 INCH.....	26
22	PAOZZ	5340013294090	64678	05-12952-000	BRACKET,MOUNTING RIGHT.....	1
23	PAOZZ	5305000712070	80204	B1821BH050C175N	SCREW,CAP,HEXAGON H 1/2-13UNC-2A X 1.750.....	1
24	PFOZZ	5365013320913	64678	23-09331-050	SPACER,SLEEVE AL,.53 IN ID X 1.5 IN OD.....	1

END OF FIGURE

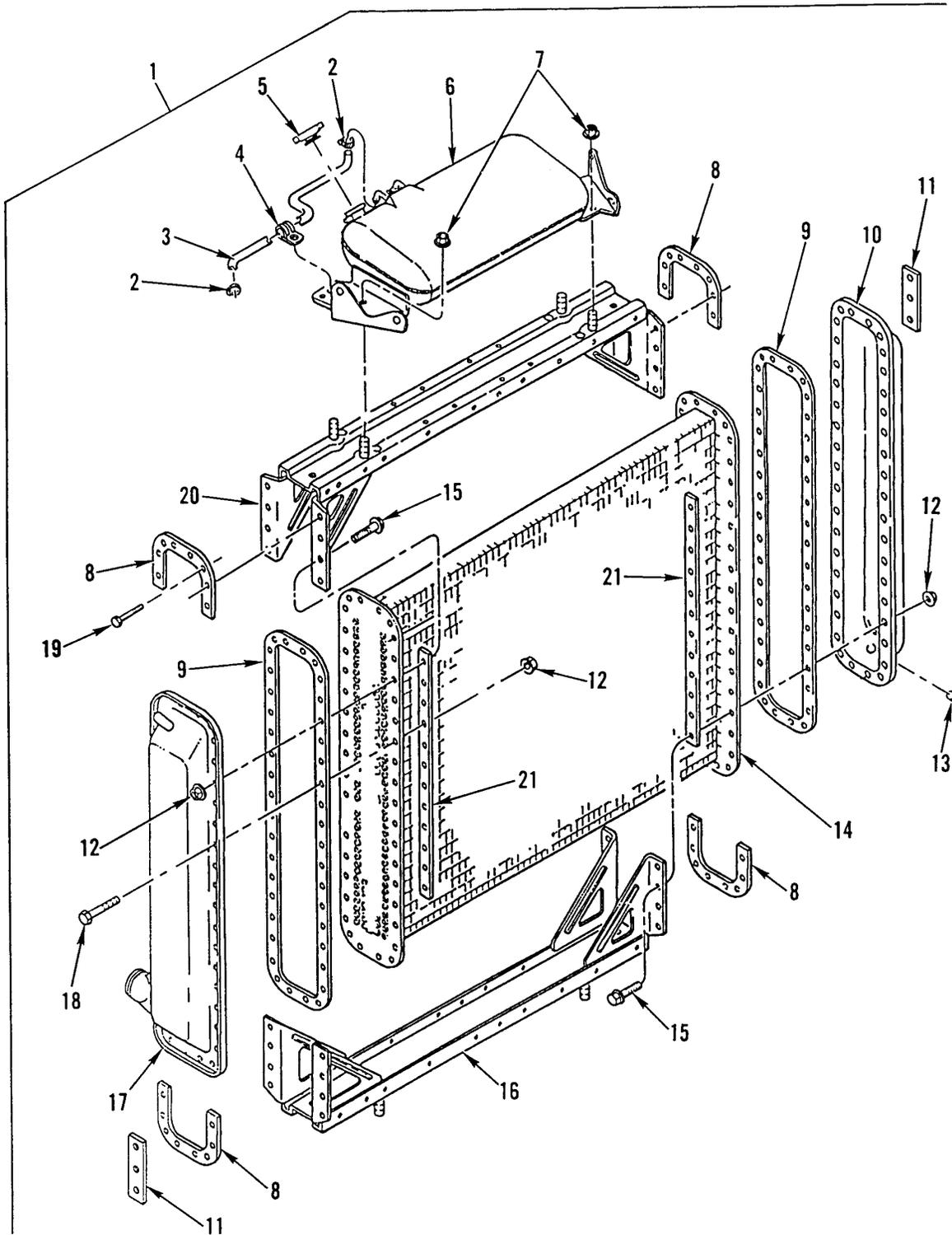

342-1316

Figure 45. Radiator Assembly

SECTION II			TM9-2320-302-24P			
(1)	(2)	(3)	(4)	(5)	(6)	(7)
ITEM	SMR			PART		
NO	CODE	NSN	CAGEC	NUMBER	DESCRIPTION AND USABLE ON CODES(UOC)	QTY
GROUP 0501 RADIATOR, EVAPORATIVE COOLER, OR HEAT EXCHANGER						
FIG. 45 RADIATOR ASSEMBLY						
1	PAOFF		64678	A05-16366-005	RADIATOR,ENGINE COO.....	1
2	PAOZZ	4730013316629	81646	5706	.CLAMP,HOSE.....	2
3	MOOZZ		64678	48-00081-038X24	.HOSE MAKE FROM CAGE 24161,PN 28430,24 IN.....	1
4	PAOZZ	5342013335993	18076	S464-G10	.CLAMP,CIRCLE.....	1
5	PAOZZ	2930012226696	78225	AAX0615	.CAP,FILLER OPENING.....	1
6	PFFZZ	2930013311731	64678	05-15799-000	.TANK,RADIATOR,OVERF.....	1
7	PAFZZ	5310012789527	82465	32WLF3816	.NUT,SELF-LOCKING,EX 3/8-16.....	4
8	PFFZZ	5340013333003	64678	05-12295-000	.PLATE,MOUNTING.....	4
9	PAFZZ	5330013296920	64678	05-12289-000	.GASKET.....	2
10	PFFZZ	5430013318795	64678	A05-12991-000	.TANK SECTION,FLUID.....	1
11	PFFZZ	5340013321540	64678	05-12499-000	.PLATE,MOUNTING.....	2
12	PAFZZ	5310001668341	82465	31WLF51618	.NUT,PLAIN,EXTENDED 5/16-18.....	60
13	PAOZZ	4730011635002	19207	7735571	.PLUG,PIPE.....	1
14	PFFZZ	2930014791384	50022	1AC00044S	.CORE,RADIATOR.....	1
15	PAFZZ	5305013284387	64678	23-09744-150	.SCREW,CAP,HEXAGON H 5/16-18,CD....	10
16	PFFZZ	2930013330744	64678	A05-12959-003	.RETAINER,RADIATOR.....	1
17	PFFZZ	5430013321373	64678	A05-12992-000	.TANK SECTION,FLUID.....	1
18	PAFZZ	5305013284386	64678	23-09744-100	.SCREW,CAP,HEXAGON H 5/16-18,CD....	50
19	XDFZZ		73342	9421497	.BOLT,SELF-LOCKING .312-18UNC-2A X .639.....	20
20	PFFZZ	2930013330743	64678	A05-12959-001	.RETAINER,RADIATOR.....	1
21	PFFZZ	5340013321539	64678	05-12207-000	.PLATE,MOUNTING.....	4

END OF FIGURE

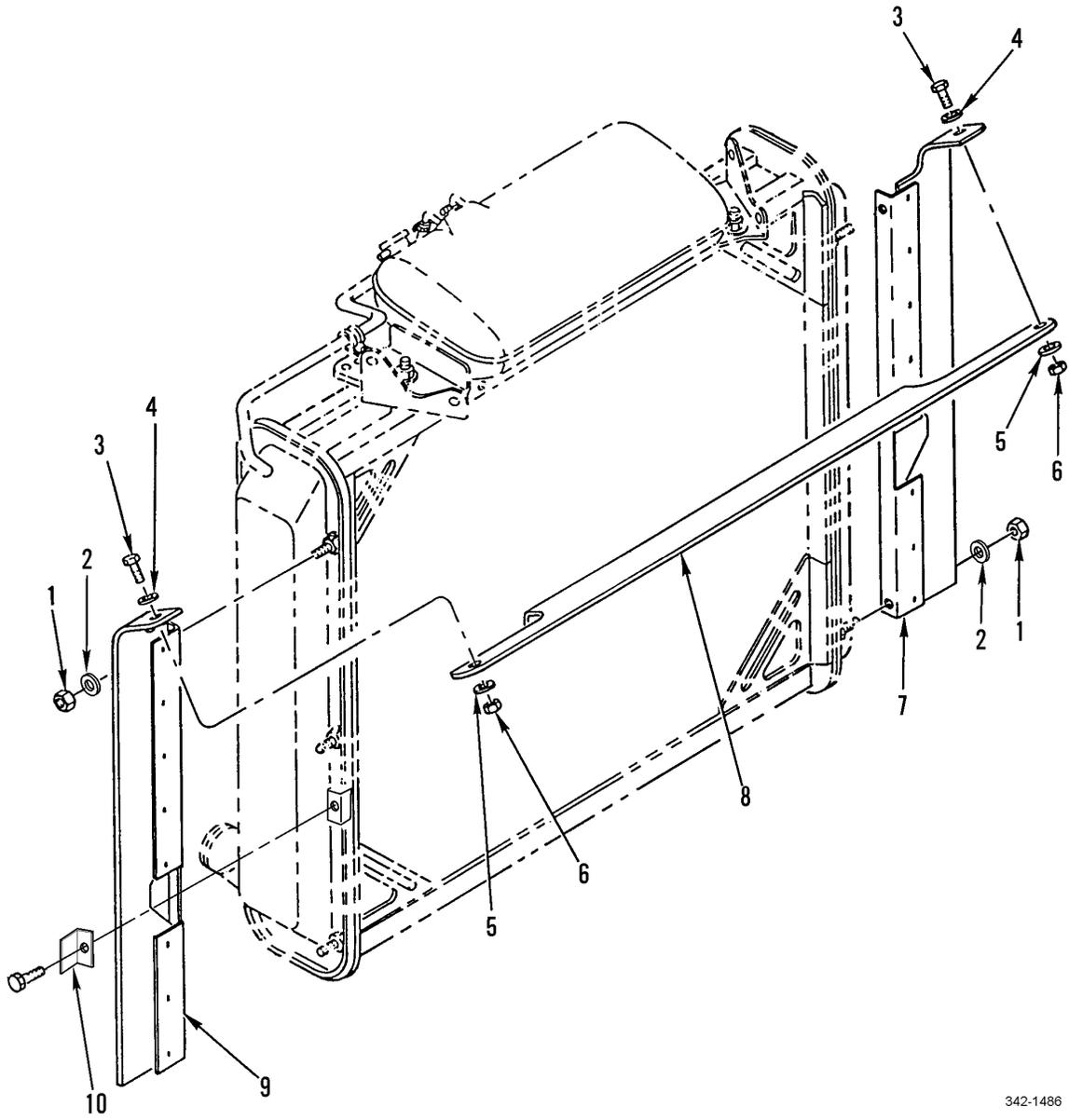

342-1486

Figure 46. Air Recirculation Shield

SECTION II			TM9-2320-302-24P			
(1)	(2)	(3)	(4)	(5)	(6)	(7)
ITEM	SMR			PART		
NO	CODE	NSN	CAGEC	NUMBER	DESCRIPTION AND USABLE ON CODES(UOC)	QTY
					GROUP 0502 COWLING, DEFLECTORS, AIR DUCTS, SHROUDS, ETC.	
					FIG. 46 AIR RECIRCULATION SHIELD	
1	PAOZZ	5310013293697	64678	23-10340-131	NUT,PLAIN,ASSEMBLED 5/16-18.....	6
2	PFOZZ	5310000814219	96906	MS27183-12	WASHER,FLAT .344 ID X .688 OD X .065 THK.....	6
3	PAOZZ	5315014786920	75418	680 990 04 92	FASTENER,TRIM,RIBBE.....	2
4	PAOZZ	5310013323254	31223	17W12580	WASHER,FLAT 1/4 ID X 1 1/4 OD X .05 THK.....	2
5	PAOZZ	5310000806004	96906	MS27183-14	WASHER,FLAT .406 ID X .812 OD X .065 THK.....	2
6	PAOZZ	5310014789004	64678	23-10340-138	NUT,SELF-LOCKING EX 3/8-16.....	2
7	PFOZZ	5340014790563	64678	A05-15513-000	BRACKET,ANGLE LEFT.....	1
8	PFOZZ		64678	A05-16455-000	SEAL,NONMETALLIC SP.....	1
9	PFOZZ		64678	A05-17096-000	BRACKET,ANGLE RIGHT.....	1
10	XDOZZ		64678	05-17081-000	BRACKET,ANGLE.....	1

END OF FIGURE

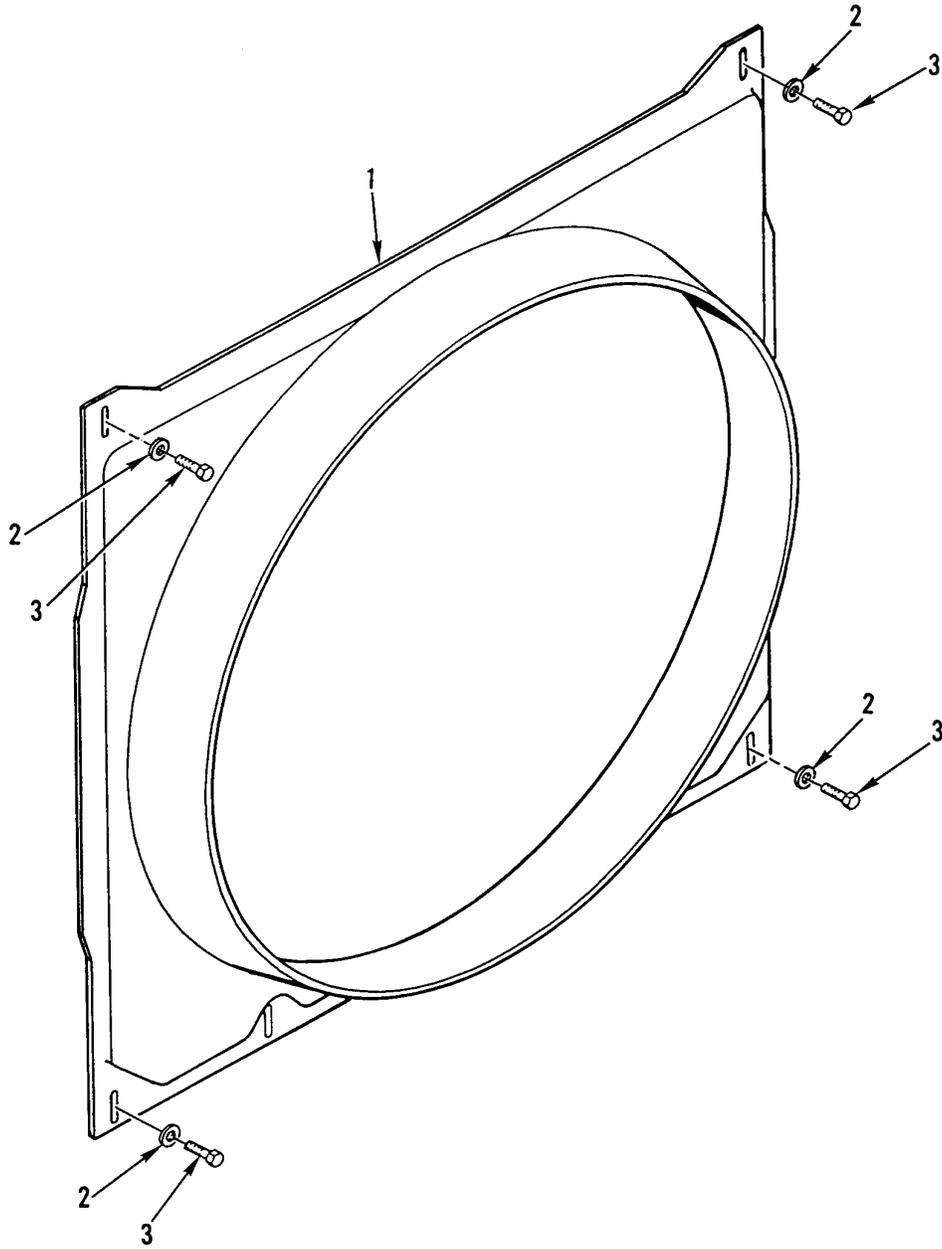

342-1286

Figure 47. Fan Shroud

SECTION II			TM9-2320-302-24P			
(1)	(2)	(3)	(4)	(5)	(6)	(7)
ITEM	SMR			PART		
NO	CODE	NSN	CAGEC	NUMBER	DESCRIPTION AND USABLE ON CODES(UOC)	QTY
					GROUP 0502 COWLING, DEFLECTORS, AIR DUCTS, SHROUDS, ETC.	
					FIG. 47 FAN SHROUD	
1	PAOZZ	2930013299900	64678	681 505 21 55	SHROUD,FAN,RADIATOR.....	1
2	PAOZZ	5310013323254	31223	17W12580	WASHER,FLAT.....	4
3	PAOZZ	5305011373938	96906	MS51871-3	SCREW,TAPPING.....	4

END OF FIGURE

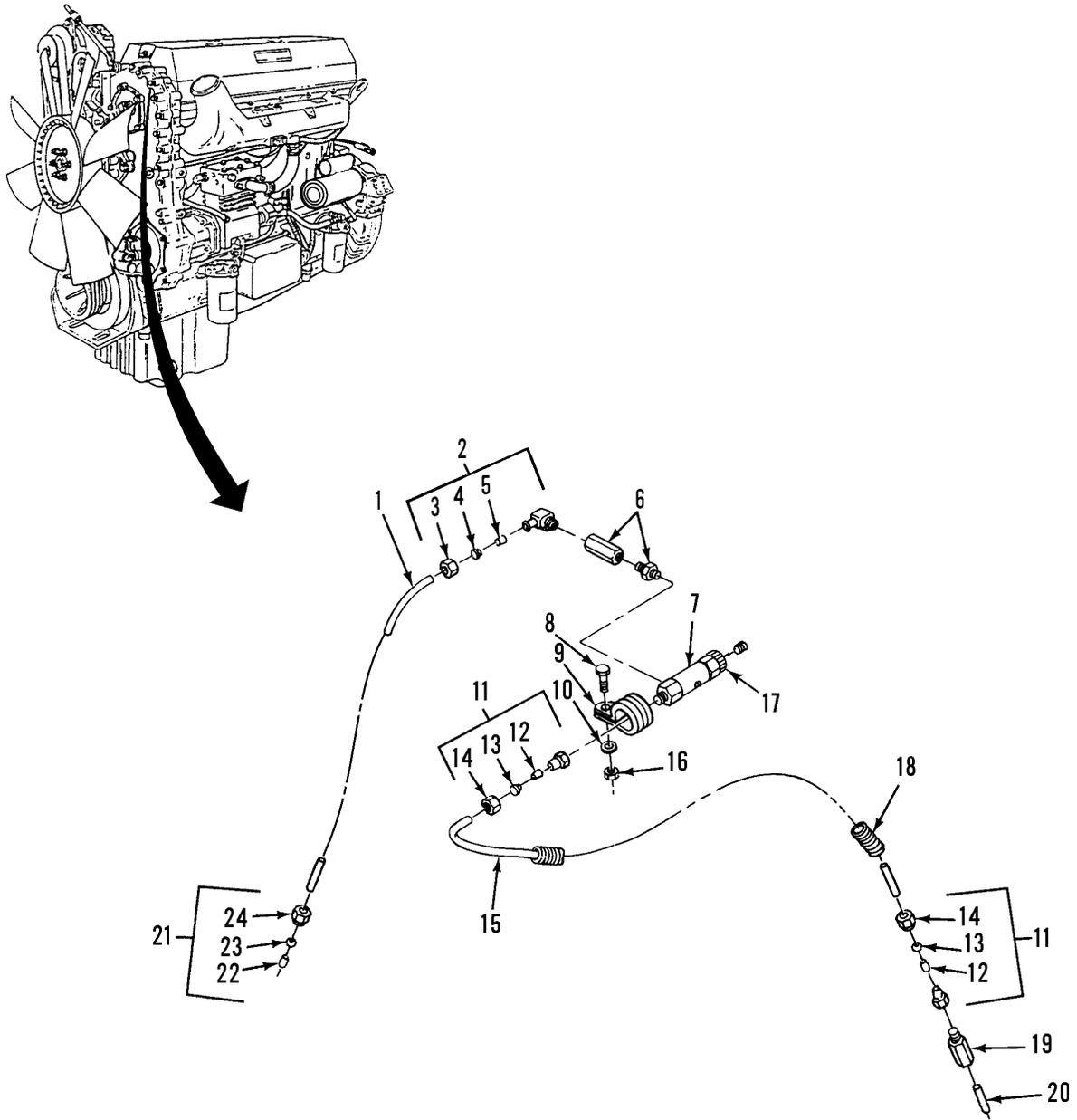

342-1487

Figure 48. Fan Clutch Plumbing

SECTION II			TM9-2320-302-24P			
(1)	(2)	(3)	(4)	(5)	(6)	(7)
ITEM NO	SMR CODE	NSN	CAGEC	PART NUMBER	DESCRIPTION AND USABLE ON CODES(UOC)	QTY
GROUP 0503 WATER MANIFOLD, HEATERS THERMOSTATS, AND HOUSING GASKET						
FIG. 48 FAN CLUTCH PLUMBING						
1	MOOZZ		64678	48-00100-010X15	TUBING,NYLON,1/4" MAKE FROM BULK PN: PFT-4A BLACKX1300 (61424).....	1
2	PAOZZ	4730011340854	93061	68NTA-6-2	ADAPTER,STRAIGHT,PI.....	1
3	PAOZZ	4730010486968	93061	61NTA-4	.NUT,TUBE COUPLING.....	1
4	PAOZZ	4730010486358	93061	60NTA-4	.SLEEVE,COMPRESSION,.....	1
5	PAOZZ	4730010577109	93061	63NTA-4	.INSERT,TUBE FITTING.....	1
6	PAOZZ	2940013920417	64678	GTD 5050	FILTER ELEMENT,INTA.....	1
7	PAOZZ	4810014410851	64678	A06-26631-000	VALVE,SOLENOID.....	1
8	PAOZZ	5305007813930	80204	B1821BH038C475N	SCREW,CAP,HEXAGON H 3/8-16 UNC X 4.75 GR 8.....	1
9	PAOZZ	5945014790302	78528	12244	BRACKET,SOLENOID.....	1
10	PAOZZ	5310007737618	96906	MS15795-814	WASHER,FLAT 3/8 INCH.....	1
11	PAOZZ	4730010887502	81343	4-2-100103BA	ADAPTER,STRAIGHT,PI.....	2
12	PAOZZ	4730010577109	93061	63NTA-4	.INSERT,TUBE FITTING.....	1
13	PAOZZ	4730010486358	93061	60NTA-4	.SLEEVE,COMPRESSION,.....	1
14	PAOZZ	4730010486968	93061	61NTA-4	.NUT,TUBE COUPLING.....	1
15	MOOZZ		64678	48-00100-010X5	TUBING,NYLON,1/4" MAKE FROM BULK PN: PFT-4A BLACKX1300 (61424).....	1
16	PAOZZ	5310007320558	96906	MS51967-8	NUT,PLAIN,HEXAGON 3/8-16UNC.....	1
17	PAOZZ		78528	5060-1	HEAD,SAFETY,PRESSUR 1/8NPT.....	1
18	MOOZZ		64678	48-02217-025X5	CONDUIT,NONMETALLIC MAKE FROM BULK P/N: 64498R (77060).....	1
19	PAOZZ	4730002871614	93061	207P-2	COUPLING,PIPE.....	1
20	PAOZZ	4730014409431	64678	23-09219-014	NIPPLE,PIPE 1/8-27X3 IN.....	1
21	PAOZZ	4730010969128	93061	68NTA-6-6	ADAPTER,STRAIGHT,PI.....	1
22	PAOZZ	4730010564990	93061	63NTA-6	.INSERT,TUBE FITTING.....	1
23	PAOZA	4730010485260	93061	60NTA-6	.SLEEVE,COMPRESSION,.....	1
24	PAOZA	4730010487873	93061	61NTA-6	.NUT,TUBE COUPLING.....	1

END OF FIGURE

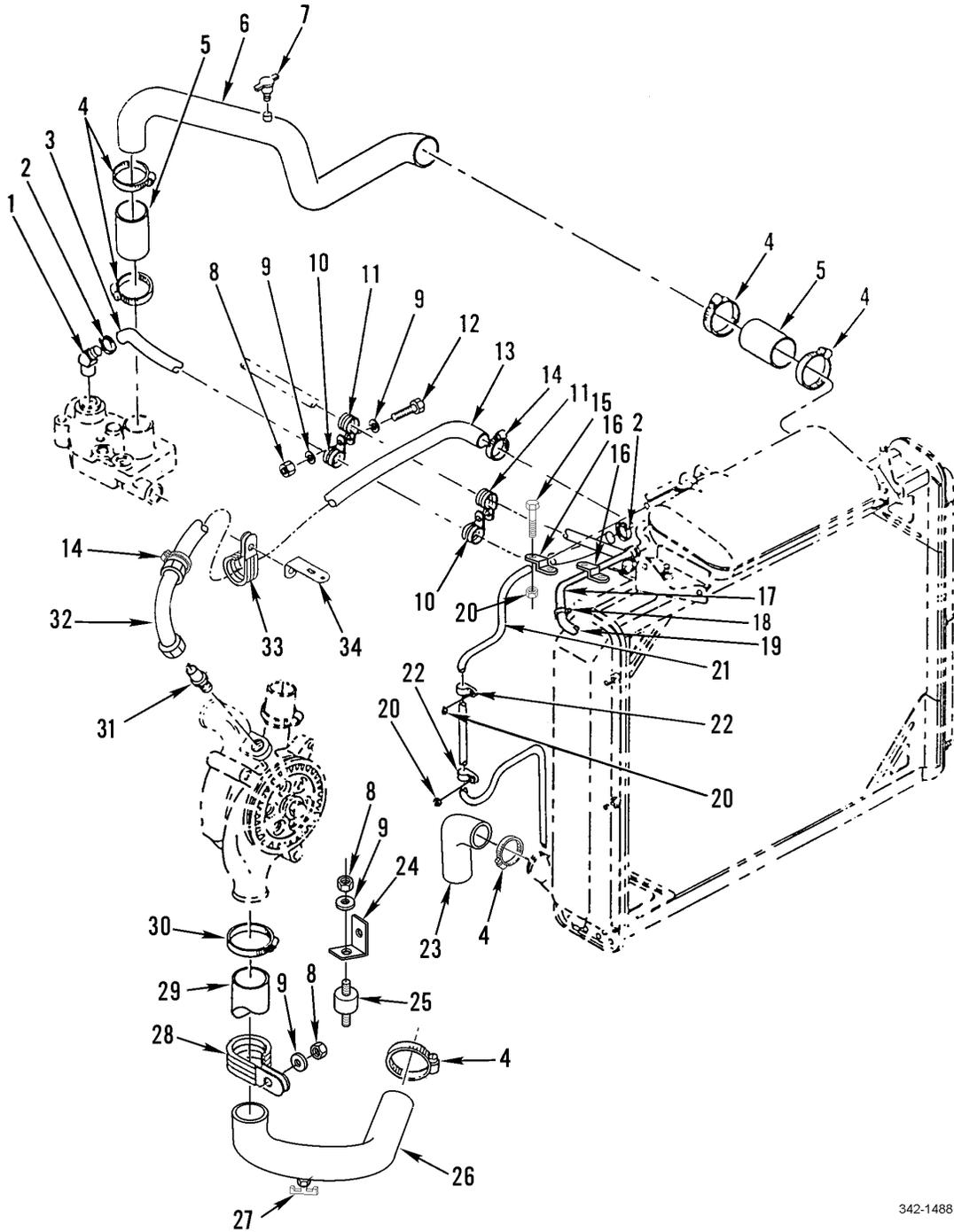

342-1488

Figure 49. Radiator Piping

SECTION II			TM9-2320-302-24P			
(1)	(2)	(3)	(4)	(5)	(6)	(7)
ITEM NO	SMR CODE	NSN	CAGEC	PART NUMBER	DESCRIPTION AND USABLE ON CODES(UOC)	QTY
GROUP 0503 WATER MANIFOLD, HEATERS THERMOSTATS, AND HOUSING GASKET						
FIG. 49 RADIATOR PIPING						
1	PAOZZ	4730013312844	88763	VSHE1 45 6B	ELBOW,PIPE TO HOSE.....	1
2	XDOZZ		05411	B28H	CLAMP,HOSE.....	4
3	MOOZZ		64678	05-12539-043	HOSE,STRAIGHT MAKE FROM CAGE 24161, PN 28430, 43 IN.....	1
4	PAOZZ	4730014396613	7Z588	B9223-0269B	CLAMP,HOSE.....	7
5	MOOZZ		64678	05-09562-006	HOSE,STRAIGHT MAKE FROM CAGE 24161, PN 24240, 6 IN.....	2
6	PAOZZ	4710013316720	64678	A05-12855-000	TUBE ASSEMBLY,METAL.....	1
7	PAOZZ	4820007529040	93061	DC604-2	COCK,DRAIN.....	1
8	PAOZZ	5310000881251	81349	M45913/1-4CG5C	NUT,SELF LOCKING,HE.....	6
9	PAOZZ	5310008094058	96906	MS27183-10	WASHER,FLAT 0.281 ID X 0.625 OD X 0.065 THK.....	10
10	PAOZZ	5340011453232	01276	900729-21	CLAMP,LOOP.....	2
11	PAOZZ	5340007645231	01276	900729-4	CLAMP,LOOP.....	2
12	PAOZZ	5305002253843	80204	B1821BH025C100N	SCREW,CAP,HEXAGON H 1/4-20UNC - 2A X 1.00.....	4
13	MOOZZ		64678	05-12538-028	HOSE 28 IN, MAKE FROM CAGE 24161, PN 4230-0174.....	1
14	XDOZZ		7Z588	CT9216	CLAMP,HOSE 1 IN. ID.....	2
15	PAOZZ	5305014790300	64678	23-12237-075	BOLT,SHOULDER 5/16-18 X 0.75.....	1
16	PFOZZ	5340013454647	64678	23-09130-013	BRACKET,ANGLE 4 IN.....	2
17	MOOZZ		64678	05-12539-024	HOSE,NONMETALLIC 24 IN, MAKE FROM CAGE 24161 PN 4230T-3/8.....	1
18	PAOZZ	5975013554570	16956	08-404	STRAP,TIEDOWN,ELECT.....	1
19	MOOZZ		64678	68240R-006	CONDUIT 6 IN, MAKE FROM CAGE 77060 PN 68240R.....	1
20	PAOZZ	5310001668341	82465	31WLF51618	NUT,PLAIN,EXTENDED 5/16-18.....	2
21	MOOZZ		64678	48-02014-008X48	HOSE 48 IN, MAKE FROM CAGE 24161, PN 4251-0125.....	1
22	PAOZZ	5340013362447	18076	S464-G8	CLAMP,LOOP.....	2
23	PAOZZ	4720014786012	64678	05-18833-000	HOSE,PREFORMED.....	1
24	PFOZZ	5340013284370	64678	05-15353-000	BRACKET,ANGLE.....	1
25	PAOZZ	5340014790560	64678	23-11551-844	MOUNT,RESILIENT,GEN STUDS 1/4-20 X 0.50.....	1
26	XDOZZ		64678	A05-17245-000	PIPE ASSY,PREFORMED.....	1
27	XDOZZ		64678	23-09093-004	COCK,DRAIN 1/2 IN. PIPE THREAD.....	1
28	XDOZZ		7Z588	K231-D-374	STRAP,TIE DOWN SIZE 15.66 IN. (398MM).....	1
29	MOOZZ		64678	05-09562-005	HOSE,NPRN 5 IN, MAKE FROM CAGE 24161, PN 24240.....	1
30	PAOZZ	4730014395343	7Z588	B9223-0325B	CLAMP,HOSE.....	3
31	PAOZZ	4730014489840	93061	VS0103-16-16	ADAPTER,STRAIGHT,PI.....	1
32	PAOZZ	4710014489982	64678	A05-16317-000	TUBE ASSEMBLY,METAL.....	1
33	PAOZZ	5340013487014	18076	S464-G20	CLAMP,LOOP ID = 1.250 INS.....	1
34	PFOZZ	5340013284367	64678	23-09130-000	BRACKET,ANGLE 4 IN.....	1

END OF FIGURE

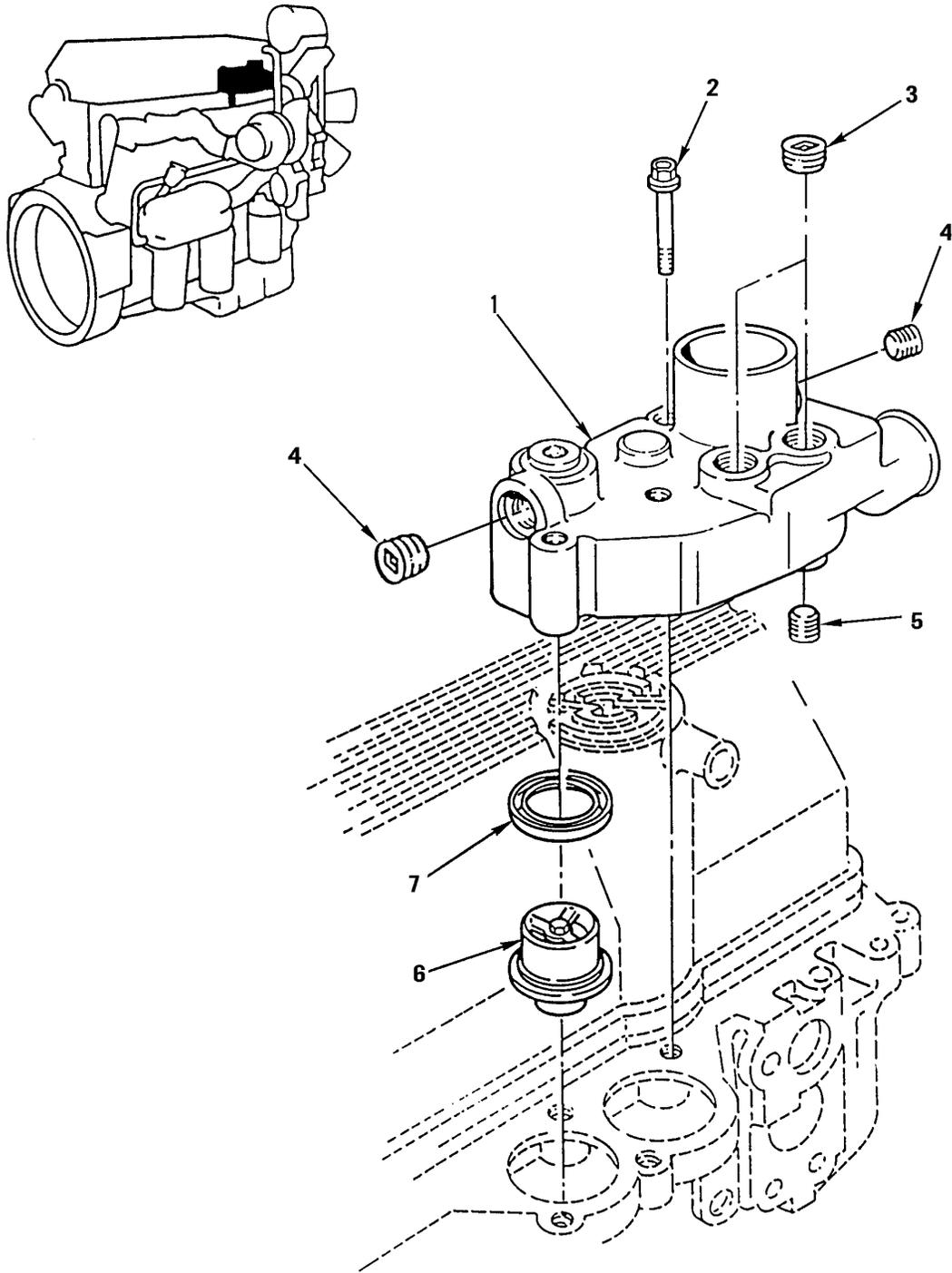

342-1377

Figure 50. Thermostat Cover and Thermostat

SECTION II			TM9-2320-302-24P			
(1)	(2)	(3)	(4)	(5)	(6)	(7)
ITEM NO	SMR CODE	NSN	CAGEC	PART NUMBER	DESCRIPTION AND USABLE ON CODES(UOC)	QTY
					GROUP 0503 WATER MANIFOLD, HEATERS THERMOSTATS, AND HOUSING GASKET	
					FIG. 50 THERMOSTAT COVER AND THERMOSTAT	
1	PAOZZ	2930013192777	72582	8929728	WATER OUTLET,ENGINE.....	1
2	PAOZZ	5305013380428	72582	23505050	SCREW,CAP,HEXAGON H M10 X 1.5 X 85- 6G,GR8.....	4
3	PAOZZ	4730014642348	72582	23511573	PLUG,PIPE.....	2
4	PAOZZ	4730014642375	72582	23511572	PLUG,PIPE.....	2
5	PAOZZ	4730011293047	72582	8922327	PLUG,PIPE.....	1
6	PAOZZ	6620013209060	78493	4R313	THERMOSTAT,FLOW CON.....	2
7	PFOZZ	5330002466380	58312	3S9643-00	SEAL,PLAIN ENCASED PART OF KIT P/N 23512691 PART OF KIT P/N 23501572...	2

END OF FIGURE

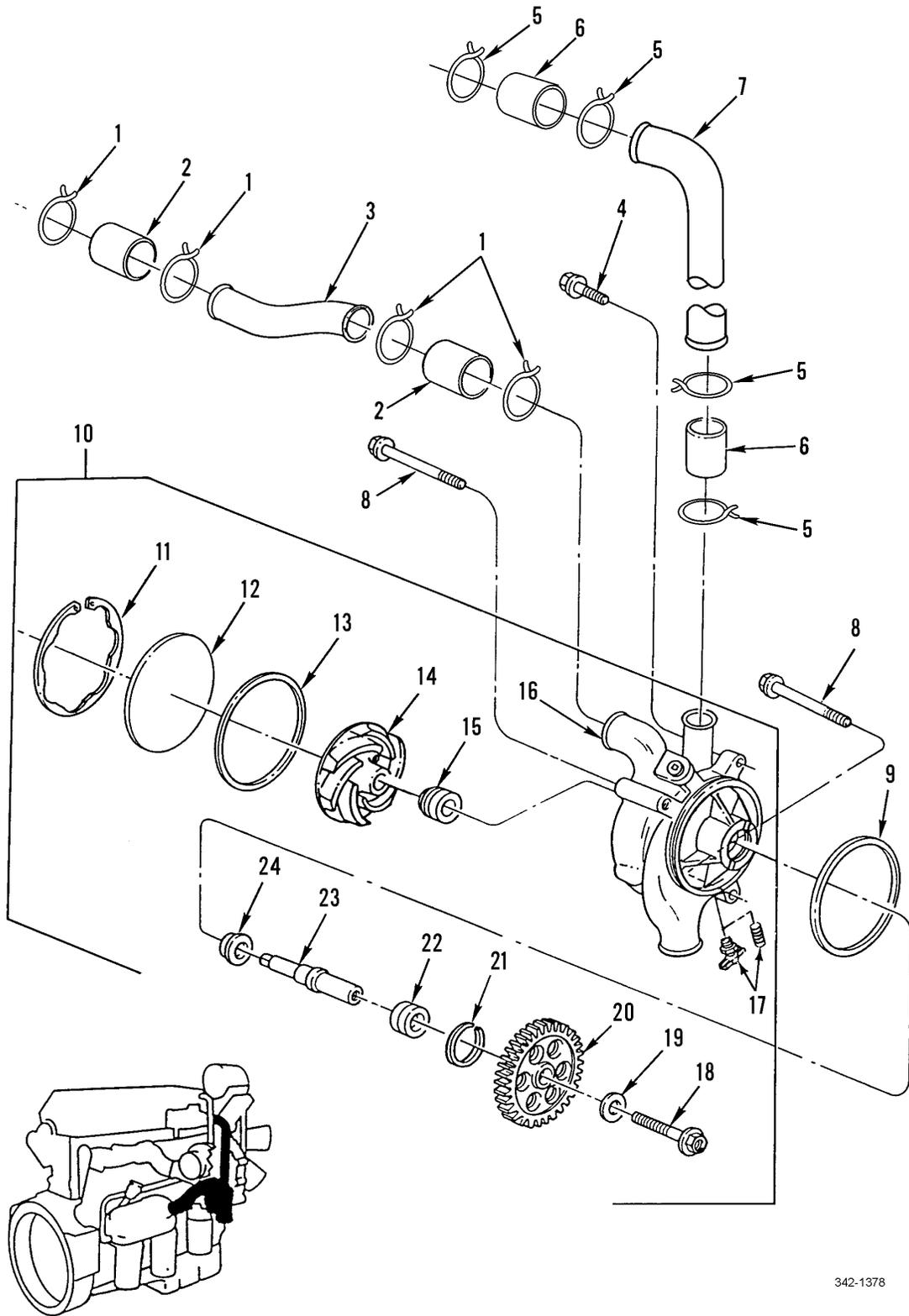

342-1378

Figure 51. Water Pump Assembly

SECTION II		TM9-2320-302-24P				
(1)	(2)	(3)	(4)	(5)	(6)	(7)
ITEM NO	SMR CODE	NSN	CAGEC	PART NUMBER	DESCRIPTION AND USABLE ON CODES(UOC)	QTY
GROUP 0504 WATER PUMP						
FIG. 51 WATER PUMP ASSEMBLY						
1	PFOZZ	4730009086292	96906	MS35842-14	CLAMP,HOSE.....	4
2	PAOZZ	4720011000740	01276	FC352-28	HOSE, NONMETALLIC.....	2
3	PFOZZ	4710013224978	72582	23505899	TUBE, BENT, METALLIC.....	1
4	XDOZZ		72582	11509523	SCREW, CAP, HEXAGON H M10 X 1.5 X 55-6G, GR10.9.....	4
5	PAOZZ	4730009098627	01276	FF9311-36	CLAMP, HOSE.....	4
6	PAOZZ	4720011000740	01276	FC352-28	HOSE, NONMETALLIC.....	2
7	XDOZZ		72582	23505898	TUBE, METALLIC.....	1
8	PAOZZ	5305013228772	72582	11509527	SCREW, CAP, HEXAGON H M10 X 1.5 X 155-6G, GR10.9.....	2
9	PAOZZ	5330013218616	72582	23520377	GASKET PART OF KIT P/N 23509105 PART OF KIT P/N 23509128.....	1
10	PFOFF		72582	23522436	PUMP, COOLING SYSTEM.....	1
11	PAFZZ	5325011666633	72582	8922407	.RING, RETAINING.....	1
12	PAFZZ	5340011664444	72582	8922383	.COVER, ACCESS.....	1
13	PFFZZ		72582	23512048	.SEAL, PLAIN PART OF KIT P/N 23509128	1
14	XDFZZ		72582	23517913	.IMPELLER, PUMP, CENTR.....	1
15	KFFZZ		72582	23522433	.SEAL, WATER PUMP PART OF KIT P/N 23509128.....	1
16	XAFZZ		72582	23517027	.BODY, WATER PUMP.....	1
17	PAFZZ	4730013197471	72582	8929594	.PLUG, PIPE.....	1
18	XDFZZ		72582	23508863	.SCREW, CAP, HEXAGON H M12 X 1.75 X 50MM WITH 1/4-20THREADED HOLE IN HEAD.....	1
19	XDFZZ		72582	23505897	.WASHER, FLAT.....	1
20	PFFZZ	3020013229234	72582	23505910	.GEAR, SPUR.....	1
21	KFFZZ		72582	8929427	.RING, SNAP ROUND PART OF KIT P/N 23509105 PART OF KIT P/N 23509128...	1
22	KFFZZ		60038	A- 46221	.BEARING, ASM W/CONE PART OF KIT P/N 23509105 PART OF KIT P/N 23509128..	1
23	PAFZZ	3040013233261	72582	23505896	.SHAFT, SHOULDERED.....	1
24	KFFZZ		81722	V4458VG	.SEAL, OIL WAT PUMP PART OF KIT P/N 23509105 PART OF KIT P/N 23509128...	1

END OF FIGURE

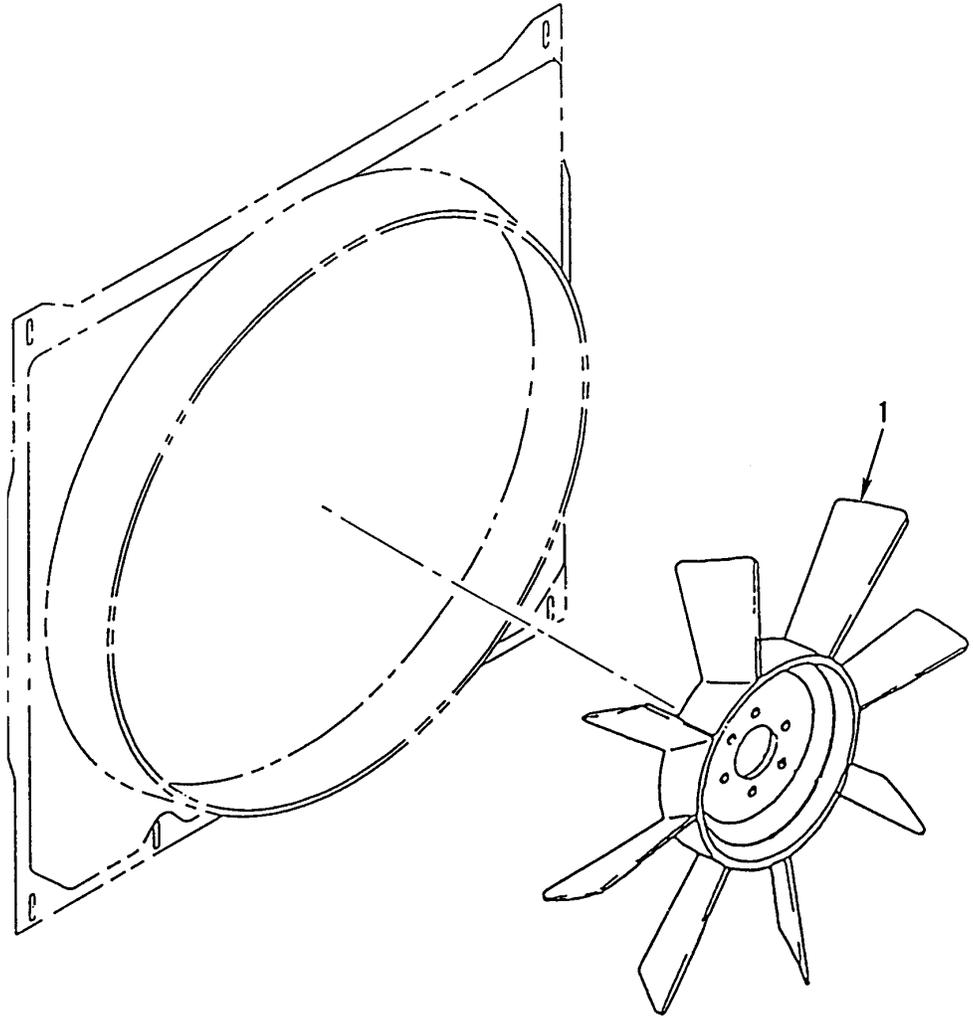

342-1287

Figure 52. Fan Impeller

SECTION II			TM9-2320-302-24P			
(1)	(2)	(3)	(4)	(5)	(6)	(7)
ITEM	SMR			PART		
NO	CODE	NSN	CAGEC	NUMBER	DESCRIPTION AND USABLE ON CODES(UOC)	QTY
					GROUP 0505 FAN ASSEMBLY	
					FIG. 52 FAN IMPELLER	
1	PAOZZ		75418	4735-41392-08	IMPELLER,FAN,AXIAL 9 BLADES, 32" DIA.....	1

END OF FIGURE

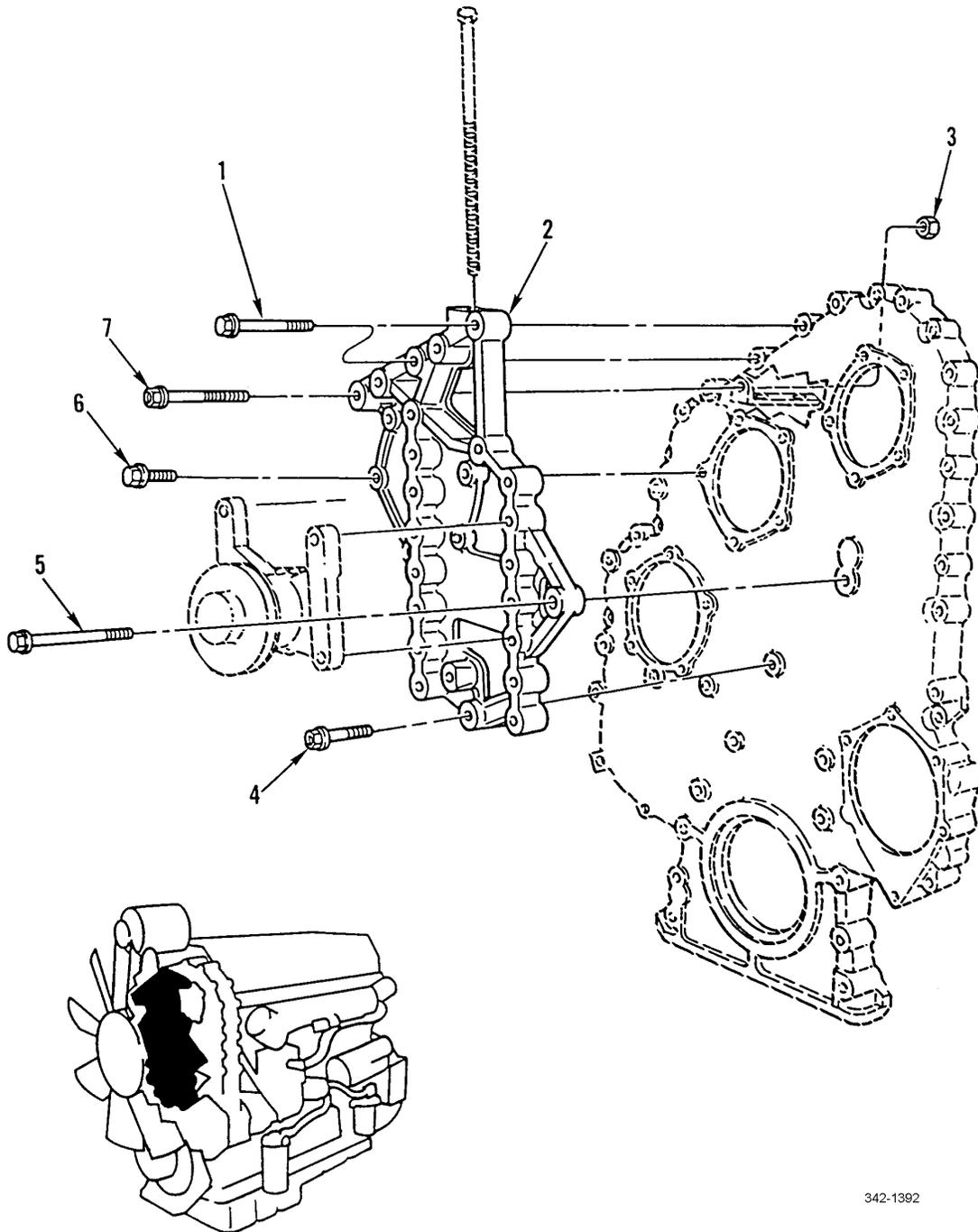

342-1392

Figure 53. Fan Mounting Support

SECTION II			TM9-2320-302-24P			
(1)	(2)	(3)	(4)	(5)	(6)	(7)
ITEM	SMR			PART		
NO	CODE	NSN	CAGEC	NUMBER	DESCRIPTION AND USABLE ON CODES(UOC)	QTY
GROUP 0505 FAN ASSEMBLY						
FIG. 53 FAN MOUNTING SUPPORT						
1	XDFZZ		72582	11509525	SCREW,CAP,HEXAGON H M10 X 1.5 X 110-6G,GR10.9, FLANGE HEAD.....	2
2	XDFZZ		72582	23511356	BRACKET,MOUNTING.....	1
3	PAFZZ	5310012507679	72582	23521131	NUT M10 X 1.5.....	1
4	PAFZZ	5305013390901	72582	11509531	SCREW,CAP,HEXAGON H M14 X 2 X 60- 6G,GR10.9.....	1
5	PAFZZ	5305013198651	72582	11509533	SCREW,CAP,HEXAGON H M14 X 2 X 100- 6G,GR10.9.....	1
6	PAFZZ	5305013199881	72582	11504822	SCREW,CAP,HEXAGON H M8 X 1.25 X 30- 6G,GR10.9.....	5
7	PAFZZ	5306013203943	72582	11513960	BOLT,MACHINE.....	1

END OF FIGURE

1	2	26
2 thru 35	3 thru 25	27 thru 34

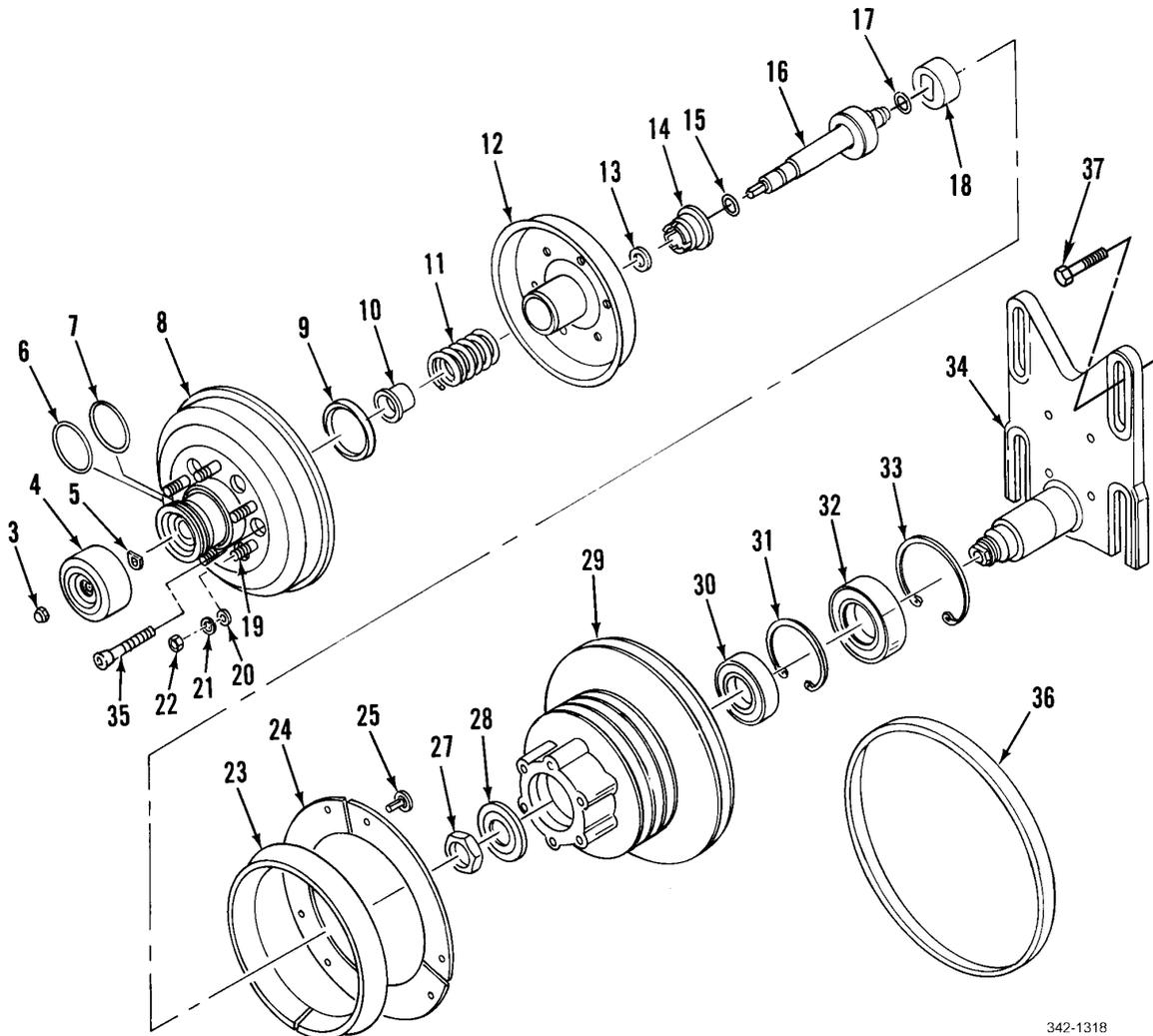

342-1318

Figure 54. Fan Clutch Assembly

SECTION II			TM9-2320-302-24P			
(1)	(2)	(3)	(4)	(5)	(6)	(7)
ITEM	SMR			PART		
NO	CODE	NSN	CAGEC	NUMBER	DESCRIPTION AND USABLE ON CODES(UOC)	QTY
GROUP 0505 FAN ASSEMBLY						
FIG. 54 FAN CLUTCH ASSEMBLY						
1	PAFFF	2930014370479	75418	1093-07896-04	CLUTCH, FAN, ENGINE.....	1
2	XDFFF		75418	1090-08500-01	.FAN CLUTCH.....	1
3	KFFZZ		75418	3029-01371-01	..NUT, CYLINDER PART OF KIT P/N 1033-05435-03.....	1
4	XDFZZ		75418	4043-41795-01	..CYLINDER ASSY.....	1
5	KFFZZ		75418	3018-01609-01	..O-RING PART OF KIT P/N 1033-05435-03.....	1
6	KFFZZ		75418	3018-01612-01	..O-RING PART OF KIT P/N 1033-05435-03.....	1
7	PAFZZ	5330013319283	75418	3018-01519-01	..SEAL, PLAIN.....	1
8	XAFZZ		75418	4040-41131-03	..HOUSING ASSY.....	1
9	PAFZZ	5330013935626	75418	3018-01507-01	..SEAL, PLAIN PART OF KIT P/N 1033-05435-03.....	1
10	PFFZZ	5365013319503	75418	4001-40690-01	..BUSHING BLANK.....	1
11	PAFZZ	5360013929389	75418	4088-40615-01	..SPRING, HELICAL, COMP PART OF KIT P/N 1033-05435-03.....	1
12	XDFZZ		75418	4079-41132-03	..SHAFT ASSEMBLY.....	1
13	PAFZZ	5325013319372	75418	3038-01510-01	..RING, RETAINING.....	1
14	XDFZZ		75418	4001-40691-01	..SPRING CARRIER.....	1
15	KFFZZ		75418	3018-01610-01	..O-RING PART OF KIT P/N 1033-05435-03.....	1
16	XDFZZ		75418	4079-42079-01	..PISTON ROD ASSY.....	1
17	KFFZZ		75418	3018-01613-01	..O-RING PART OF KIT P/N 1033-05435-03 PART OF KIT P/N 1033-07781-01....	1
18	KFFZZ		75418	4038-40903-01	..COUPLING PART OF KIT P/N 1033-05435-03 PART OF KIT P/N 1033-07781-01.....	1
19	PAFZZ	5307011905854	51377	3051-01405-01	..STUD, PLAIN.....	6
20	PAOZZ	5310013319416	75418	3058-00843-07	..WASHER, FLAT.....	6
21	PAOZZ	5310011900283	51377	3059-00870-06	..WASHER, LOCK.....	6
22	PAOZZ	5310011904607	51377	3030-00364-01	..NUT, PLAIN, HEXAGON.....	6
23	KFFZZ		75418	4026-36900-01	..LINING, PIECE, 1 PART OF KIT P/N 1033-08250-01.....	1
24	PAFZZ	5340013319610	75418	4073-38444-01	..PLATE, MOUNTING.....	3
25	KFFZZ		75418	3042-01684-01	..SCREW PART OF KIT P/N 1033-05435-03 PART OF KIT P/N 1033-08250-01....	6
26	XDFFF		75418	1077-07895-04	.FAN HUB ASSY.....	1
27	PAFZZ	5310014409675	75418	3029-01317-03	..LOCKNUT, RAPID ALIGN.....	1
28	PAFZZ	5310014406750	75418	3058-01603-01	..WASHER, FLAT.....	1
29	XDFZZ		75418	4077-42315-01	..PULLEY.....	1
30	KFFZZ		75418	4012-41486-01	..BEARING PART OF KIT P/N 1033-07781-01.....	1
31	KFFZZ		75418	3038-01565-01	..SNAP RING, INTERNAL PART OF KIT P/N 1033-07781-01.....	1
32	KFFZZ		75418	4012-41904-01	..BEARING PART OF KIT P/N 1033-07781-01.....	1
33	KFFZZ		75418	3038-01564-01	..SNAP RING, INTERNAL PART OF KIT P/N 1033-07781-01.....	1

SECTION II			TM9-2320-302-24P			
(1)	(2)	(3)	(4)	(5)	(6)	(7)
ITEM	SMR			PART		
NO	CODE	NSN	CAGEC	NUMBER	DESCRIPTION AND USABLE ON CODES(UOC)	QTY
34	XDFZZ		75418	4011-42175-04	..BASE.....	1
35	PAFZZ	5305014434906	75418	3042-01223-16	.SCREW,CAP,SOCKET HE.....	6
36	PAOZZ	3030014357194	24161	17513	BELTING,V.....	3
37	PAFZZ	5306014761458	64678	210101 012001	BOLT,SHOULDER M12X1.75 X 35MM.....	4

END OF FIGURE

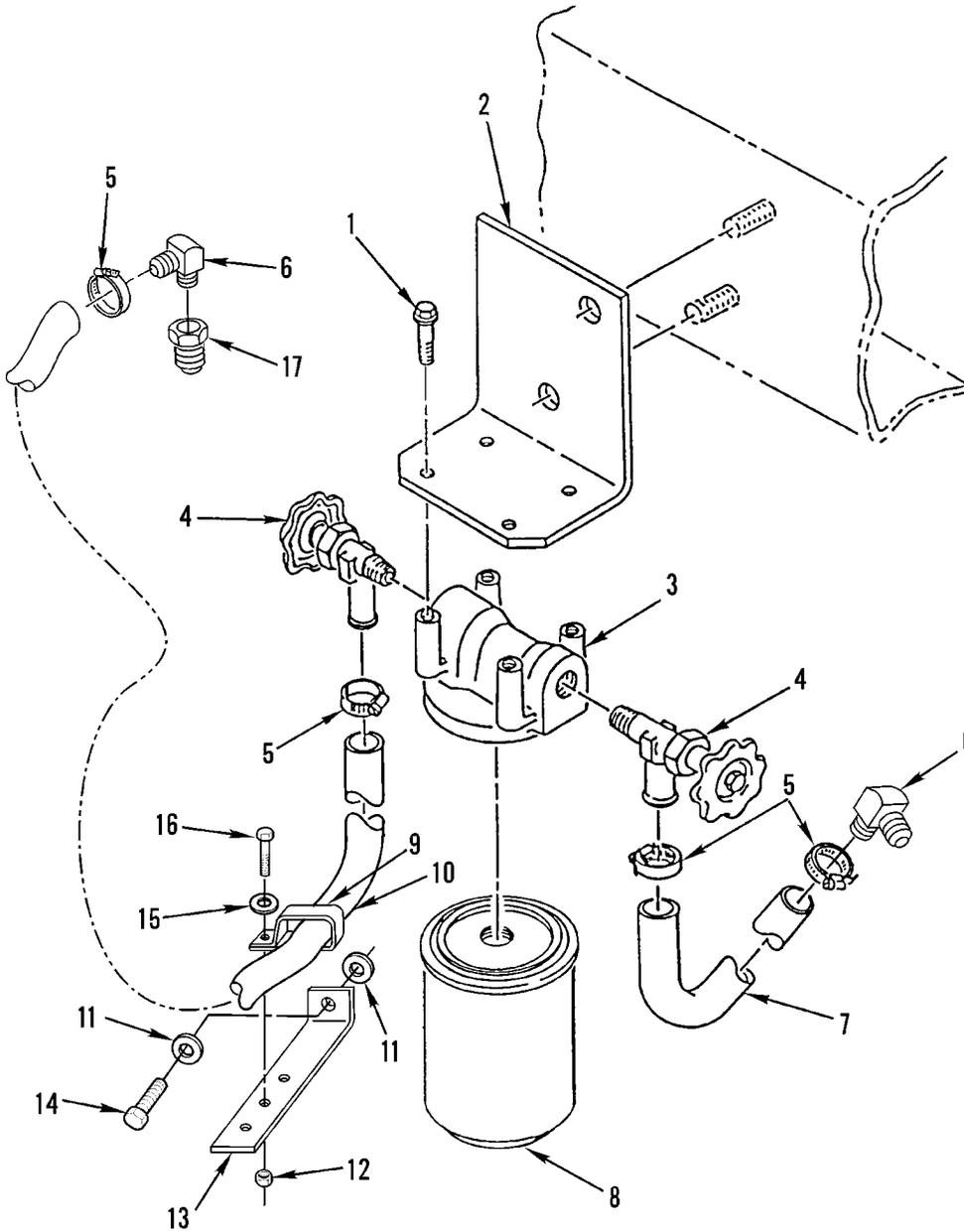

342-1391

Figure 55. Water Filter Installation

SECTION II			TM9-2320-302-24P			
(1)	(2)	(3)	(4)	(5)	(6)	(7)
ITEM	SMR			PART		
NO	CODE	NSN	CAGEC	NUMBER	DESCRIPTION AND USABLE ON CODES(UOC)	QTY
GROUP 0508 WATER FILTER						
FIG. 55 WATER FILTER INSTALLATION						
1	PAOZZ	5306014788505	64678	23-11007-125	BOLT, SHOULDER 3/8-16 X 1.25.....	4
2	PFOZZ	5340013347424	64678	01-21187-000	BRACKET, ANGLE.....	1
3	XDOZZ		15434	204163S	HEAD, FLUID FILTER.....	1
4	PAOZZ	4820013321311	93061	VS404P-10-6	VALVE, ANGLE.....	2
5	PFOZZ	4730011223338	7Z588	30010H	CLAMP, HOSE.....	4
6	PAOZZ	4730011060313	93061	269HB-10-8	ELBOW, PIPE TO HOSE.....	2
7	MOOZZ		64678	22-28607-010	HOSE, RUBBER, HEATER MAKE FROM CAGE 24161, PN 350357, 10 IN.....	1
8	PAOZZ	2910012741915	33457	WF-2077	FILTER ELEMENT, FLUI.....	1
9	PAOZZ	5340014749800	64678	23-11358-035	CLAMP, LOOP FOR SIZE OF TUBE 1.188 IN.....	2
10	MOOZZ		64678	22-28607-061	HOSE, RUBBER MAKE FROM CAGE 96906, PN MS521301A203R, 61 IN.....	1
11	PAOZZ	5310008094058	96906	MS27183-10	WASHER, FLAT.....	4
12	PAOZZ	5310000881251	81349	M45913/1-4CG5C	NUT, SELF-LOCKING, HE.....	2
13	PFOZZ	5340014749827	64678	06-09782-001	BRACKET, MOUNTING.....	2
14	PAOZZ	5305013418926	15526	933-M8X20	SCREW, CAP, HEXAGON H M8 X 1.25 X 20.	2
15	PAOZZ	5310000814219	96906	MS27183-12	WASHER, FLAT.....	2
16	PAOZZ	5305002253843	80204	B1821BH025C100N	SCREW, CAP, HEXAGON H 1/4-20 X 1.....	2
17	PAOZZ	4730001930875	72582	144034	BUSHING, PIPE.....	1

END OF FIGURE

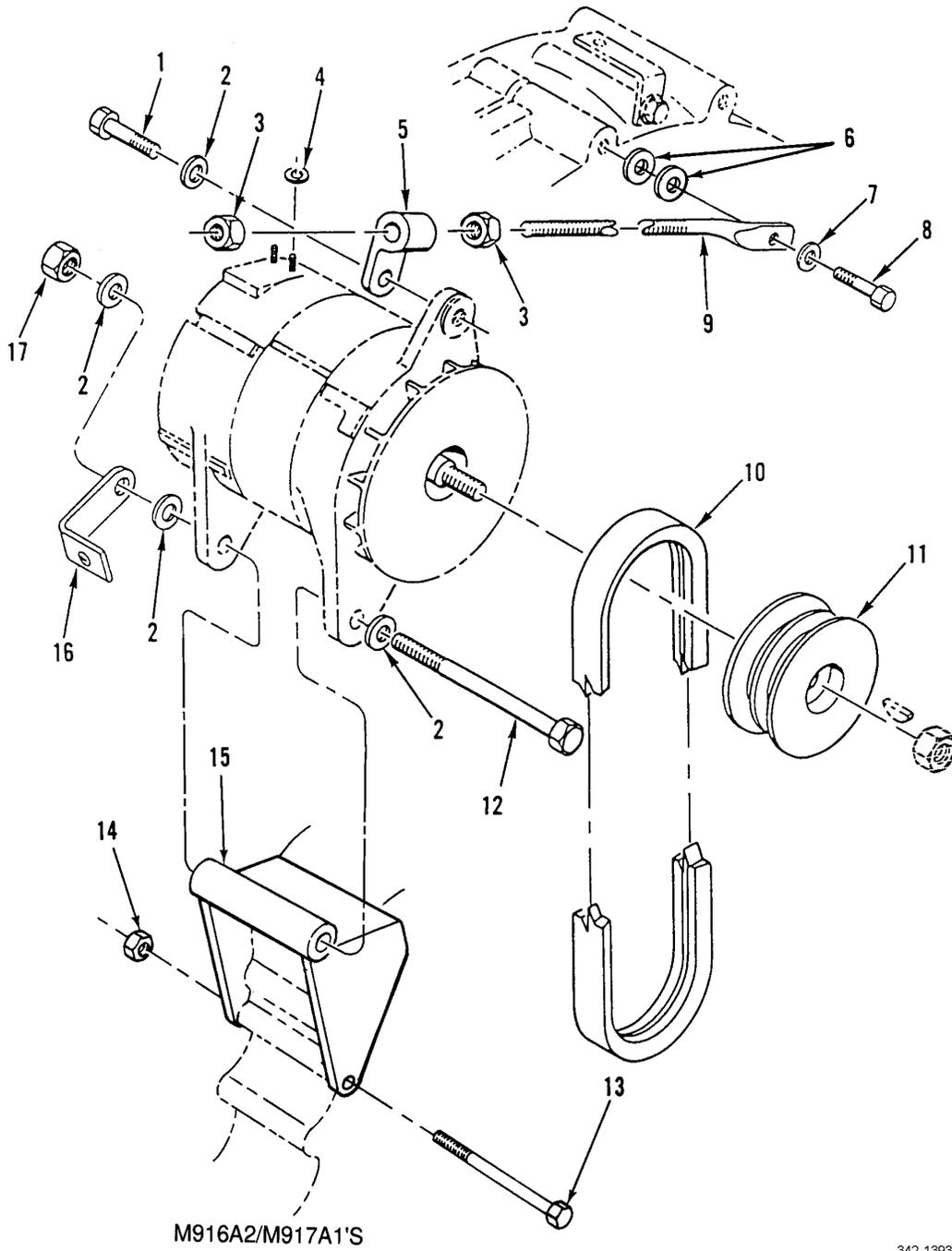

M916A2/M917A1'S

342-1393

Figure 56. Alternator Pulley, Belt and Attaching Hardware

SECTION II			TM9-2320-302-24P			
(1)	(2)	(3)	(4)	(5)	(6)	(7)
ITEM	SMR			PART		
NO	CODE	NSN	CAGEC	NUMBER	DESCRIPTION AND USABLE ON CODES(UOC)	QTY
GROUP 06 ELECTRICAL SYSTEM						
GROUP 0601 GENERATOR, ALTERNATOR						
FIG. 56 ALTERNATOR PULLEY, BELT AND ATTACHING HARDWARE						
1	PAOZZ	5305000213806	96906	MS35307-413	SCREW,CAP,HEXAGON H 1/2-13UNC X 1.50.....	1
2	PAOZZ	5310007679425	96906	MS15795-818	WASHER,FLAT .531 ID X 1.062 OD.....	3
3	PAOZZ	5310008352037	96906	MS35691-53	NUT,PLAIN,HEXAGON 5/8-18UNF.....	2
4	PAOZZ	5310006255756	96906	MS15795-812	WASHER,FLAT .344 ID X .688 OD.....	4
5	PAOZZ	5340013356703	64678	01-11367-000	CONNECTOR,ROD END.....	1
6	PAOZZ	5365014392357	64678	23-11427-050	SPACER,SLEEVE.....	1
7	PAOZZ	5310013798077	15526	DIN127-B10.1-431	WASHER,LOCK 10MM.....	1
8	PFOZZ	5306011740373	S3465	4537800-247	BOLT,MACHINE M10X1.5X45MM, GR 10.9.	1
9	PAOZZ	5306014408202	64678	01-11424-010	BOLT,EYE.....	1
10	PAOZZ	3030013321351	64678	2PB51	BELT,V.....	1
11	PAOZZ	3020014397085	64678	01-22950-000	PULLEY,GROOVE.....	1
12	PAOZZ	5305013327228	64678	23-09440-650	SCREW,CAP,HEXAGON H 1/2-13 X 6.5, GR8,PHOS AND OIL.....	1
13	PAOZZ	5306014431230	72582	23521132	BOLT,MACHINE 7/16-14 X 5.5".....	2
14	PAOZZ	5310012507679	72582	23521131	NUT M10, FLANGED.....	2
15	XDOZZ		72582	23521125	ARM,ADJUSTING,BELT.....	1
16	PFOZZ	5340013338889	64678	23-09130-001	BRACKET,ANGLE.....	1
17	PAOZZ	5310002256993	96906	MS51922-33	NUT,SELF-LOCKING,HE 1/2-13UNC.....	1

END OF FIGURE

SECTION II			TM9-2320-302-24P			
(1)	(2)	(3)	(4)	(5)	(6)	(7)
ITEM NO	SMR CODE	NSN	CAGEC	PART NUMBER	DESCRIPTION AND USABLE ON CODES(UOC)	QTY
GROUP 0601 GENERATOR, ALTERNATOR						
FIG. 57 ALTERNATOR ASSEMBLY						
1	PAOFF	6115013291671	35510	A001 4626AA	GENERATOR,ALTERNATI.....	1
2	PAFZZ	5310006161739	35510	2771	.NUT,PLAIN,HEXAGON 1/4.....	1
3	PAFZZ	5310005825965	99539	CBM21389	.WASHER,LOCK 1/4 INCH.....	1
4	PAFZZ	5310006161739	35510	2771	.NUT,PLAIN,HEXAGON 1/4.....	1
5	PAFZZ	5310005825965	99539	CBM21389	.WASHER,LOCK 1/4 INCH.....	1
6	PAFZZ	5310004293156	35510	59982S	.NUT TERMINAL 1/4-24 UNC.....	4
7	PAFZZ	5970001604066	35510	73545	.INSULATOR,BUSHING.....	2
8	PAFZZ	5310004293127	35510	26175	.NUT,HEXAGON ELASTIC STOP 10-32....	1
9	XDFZZ	5970013408775	35510	78145	.INSULATION SLEEVING.....	3
10	PAFZZ	5310011079715	35510	32172	.NUT,PLAIN,CASTELLAT.....	3
11	PAFZZ	5310009158460	19206	7986694	.WASHER,FLAT.....	3
12	PAFZZ	5940013352924	35510	79444	.TERMINAL,STUD.....	3
13	PAFZZ	5970011205418	35510	79436	.INSULATOR,PLATE.....	2
14	XDFZZ		35510	79435	.INSULATION,BUSHING.....	3
15	PAFZZ	5310011365543	35510	4492	.WASHER,FLAT PACKAGE OF 25,GUARD, 10-32UNF.....	3
16	PAFZZ	5310011069929	35510	2313	.NUT 10-32.....	6
17	PAFZZ	5940001141300	96906	MS20659-105	.TERMINAL,LUG.....	3
18	PAFZZ	5310010779437	35510	79024	.NUT 10-32 UNF.....	3
19	PAFZZ	5330011066101	35510	79403	.SEAL,OIL.....	1
20	PAFZZ	3110011362093	35510	A0790-79406	.BEARING,ROLLER.....	1
21	PAFZZ	5330011064329	35510	79404	.SEAL,PLAIN ENCASED.....	1
22	PAFZZ	5970011041075	35510	79432	.INSULATOR,BUSHING.....	1
23	PAFZZ	5970001604001	35510	73546	.INSULATOR,BUSHING.....	1
24	PAFZZ	5970011041074	35510	79431	.INSULATOR,BUSHING.....	1
25	PAFZZ	6130013335850	35510	78753	.RECTIFIER,METALLIC.....	1
26	PAFZZ	5305011056888	35510	79313	.SCREW TERMINAL 1/4 IN.....	1
27	PAFZZ	5306011069928	35510	79314	.BOLT,SQUARE NECK.....	1
28	PAFZZ	5910001128051	35510	96545	.CAPACITOR,FIXED,PLA.....	1
29	PAFZZ	5305004511623	35510	73543	.SCREW,TAPPING 6-32 UNF X 1/2.....	2
30	PAFZZ	2920012672088	35510	79517	.ROTOR,GENERATOR.....	1
31	XDFZZ		35510	71193	..SLIP RING ASSY.....	1
32	PAFZZ	3110011362090	35510	79424	..BEARING,ROLLER,JOUR.....	1
33	PAFZZ	5310011079269	35510	30806	..NUT,PLAIN,HEXAGON 1-14.....	1
34	XDFZZ		35510	79422	..SHAFT,SHOULDERED.....	1
35	XDFZZ		35510	79516	..ROTOR COIL.....	1
36	XAFZZ		35510	75570	..HUB.....	1
37	PAFZZ	5315006165523	35510	6399	.KEY,WOODRUFF.....	3
38	PAFZZ	2920011411488	35510	78983	.HOUSING,ALTERNATOR,.....	1
39	PAFZZ	5310004510631	35510	59225	.WASHER,KEYWAY SPACER, FAN.....	1
40	PAFZZ	2920010826458	35510	79035	.HOLDER ASSEMBLY,FAN.....	1
41	PAFZZ	5310004323959	35510	76985	.NUT,HEXAGON 5/8-18 UNC.....	1
42	PAFZZ	5305010779659	35510	78991	.SCREW,CAP,HEXAGON H 10-32 UNF X 5.44.....	3
43	PAFZZ	5310004293453	35510	75451	.WASHER,FLAT 10-32 UNF.....	3
44	PAFZZ	3110011365534	35510	78895	.BEARING.....	1
45	PAFZZ	5330011116531	35510	79405	.SEAL.....	1
46	PAFZZ	3110011093058	35510	79486	.PLATE,RETAINING,BEA.....	1

SECTION II			TM9-2320-302-24P			
(1)	(2)	(3)	(4)	(5)	(6)	(7)
ITEM NO	SMR CODE	NSN	CAGEC	PART NUMBER	DESCRIPTION AND USABLE ON CODES(UOC)	QTY
47	PAFZZ	5305004500463	35510	58754	.SCREW,MACHINE FLT HD, 10-32 UNF X .44.....	4
48	XAFZZ		35510	97712	.STATOR.....	1
49	PAFZZ	5330004060664	35510	57611	.PACKING,PREFORMED.....	1
50	PAFZZ	5305009846192	96906	MS35206-244	.SCREW,MACHINE NO. 8-32 X .438.....	4
51	PAFZZ	5310004293135	35510	4340	.NUT,PLAIN,HEXAGON 10-24 UNC.....	4
52	PAFZZ	5310007755139	35510	2434	.WASHER,LOCK NO. 10.....	6
53	PAFZA	2920004316584	35510	58777	.HOLDER,BRUSH.....	1
54	PAFZZ	5977007645530	35510	77302	.BRUSH,ELECTRICAL CO.....	2
55	XDFZZ		35510	57613	.TERMINAL,STUD.....	2
56	PAFZZ	5940004766752	35510	57594	.JUMPER TERMINAL.....	2
57	XDFZZ		35510	73814	.GASKET.....	1
58	PAFZZ	5970004211207	35510	57615	.INSULATOR,PLATE.....	1
59	PAFZZ	5310003646497	35510	5293	.WASHER,FLAT 10-32 UNF.....	2
60	PAFZZ	5310009349751	96906	MS35650-302	.NUT,PLAIN,HEXAGON NO. 10-32.....	2
61	PAFZZ	6150013414886	35510	57246	.LEAD ASSEMBLY,ELECT.....	1
62	PAFZZ	5310004293156	35510	59982S	.NUT TERMINAL 1/4-24 UNC.....	1
63	PAFZZ	3120010829419	35510	77916	.BUSHING,SLEEVE.....	1
64	XDFZZ	2920011065548	35510	71194	.HOUSING,ELECTRICAL.....	1
65	PAFZZ	3120010826996	35510	73547	.BUSHING,SLEEVE.....	1
66	PAFZZ	6130013336779	35510	78752	.RECTIFIER,METALLIC.....	1
67	PAFZZ	5310010238927	35510	52066	.WASHER,FLAT.....	2
68	PAFZZ	5310007814787	35510	2385	.WASHER,FLAT GUARD 10-32 UNF.....	2
69	PAFZZ	5305009931848	96906	MS35207-265	.SCREW,MACHINE NO. 10-32 X .750.....	2

END OF FIGURE

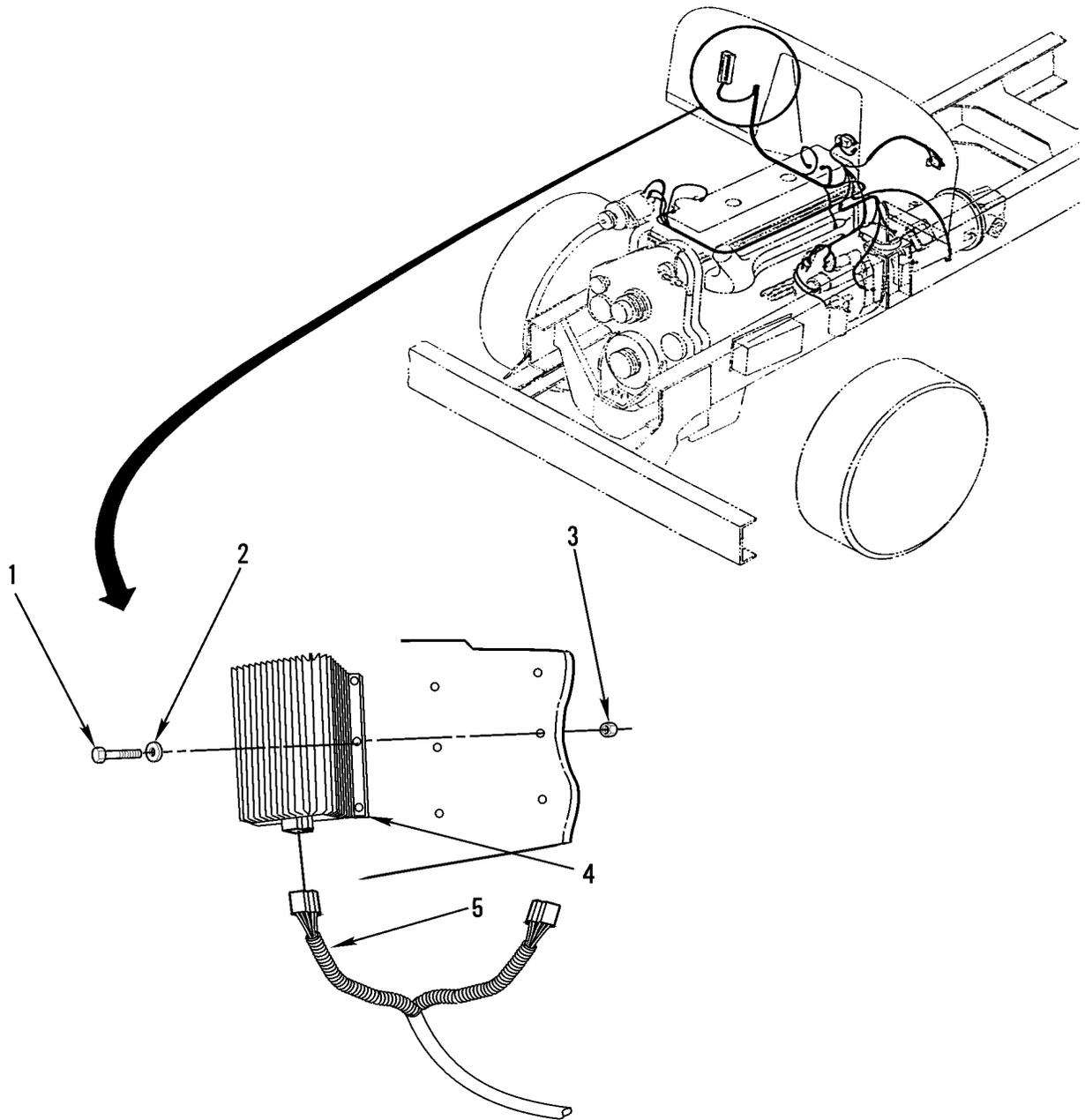
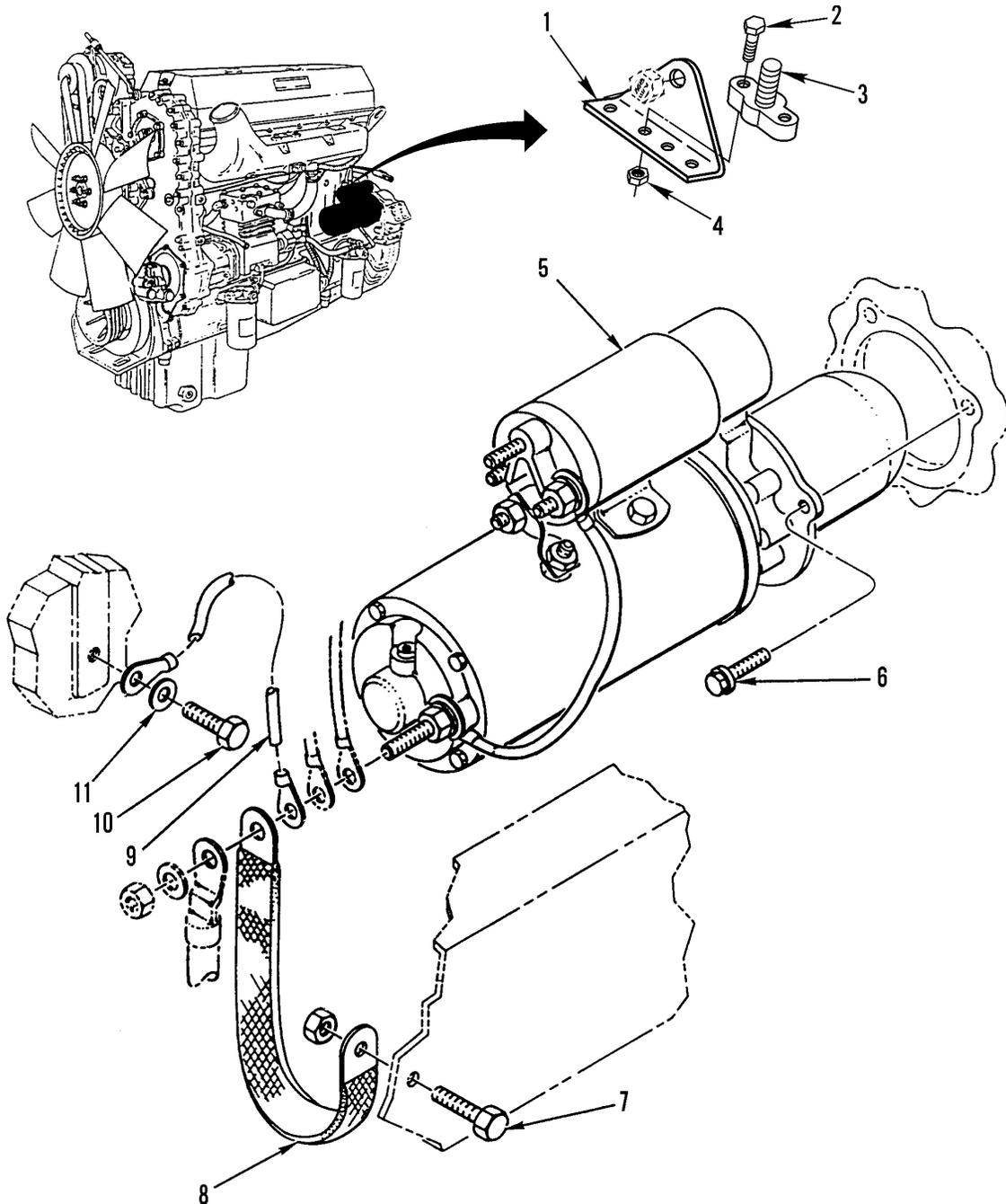

Figure 58. Regulator

SECTION II			TM9-2320-302-24P			
(1)	(2)	(3)	(4)	(5)	(6)	(7)
ITEM	SMR			PART		
NO	CODE	NSN	CAGEC	NUMBER	DESCRIPTION AND USABLE ON CODES(UOC)	QTY
					GROUP 0602 GENERATOR REGULATOR (VOLTAGE)	
					FIG. 58 REGULATOR	
1	PAOZZ		96906	MS35207-265	SCREW,MACHINE NO. 10-32 X .750.....	6
2	PAOZZ		96906	MS35333-39	WASHER,LOCK NO. 10 NOM SIZE.....	6
3	XDOZZ		80205	23-12027-130	NUT,PLAIN,BLIND RIV 10-32.....	6
4	PAOZZ		55156	20430	REGULATOR,VOLTAGE 24V.....	1
5	XDOZZ		64678	A06-37346-000	HARNES, BRANCHED.....	1

END OF FIGURE



342-1390

Figure 59. Starter and Attaching Parts

SECTION II			TM9-2320-302-24P			
(1)	(2)	(3)	(4)	(5)	(6)	(7)
ITEM NO	SMR CODE	NSN	CAGEC	PART NUMBER	DESCRIPTION AND USABLE ON CODES(UOC)	QTY
GROUP 0603 STARTING MOTOR						
FIG. 59 STARTER AND ATTACHING PARTS						
1	XDOZZ		64678	06-15160-000	BRACKET,MOUNTING.....	1
2	PAOZZ	5305014419376	64678	23-12195-075	SCREW,MACHINE 10-24UNC X 0.75 TORX HD, DOG POINT.....	2
3	XDOZZ		06721	BE20301	TERMINAL,STUD,ELEC.....	1
4	PAOZZ	5310013294045	64678	23-09336-005	NUT,SELF-LOCKING,CL CLR LOCK,10-24.	2
5	PAOFF	2920013394308	35510	7400MC	STARTER,ENGINE,ELEC.....	1
6	PAOZZ	5305013335272	72582	9415918	SCREW,MACHINE.....	3
7	PAOZZ	5305000213806	96906	MS35307-413	SCREW,CAP,HEXAGON H 1/2-13UNC X 1.50.....	1
8	PAOZZ	5999013636922	18179	2318BC-FRL12	STRIP,ELECTRICAL GR.....	1
9	PAOZZ	6150013366478	64678	681 540 08 38	CABLE ASSEMBLY,SPEC.....	1
10	PAOZZ	5305002693211	96906	MS90725-60	SCREW,CAP,HEXAGON H.....	1
11	PAOZZ	5310005957237	96906	MS35333-42	WASHER,LOCK.....	1

END OF FIGURE

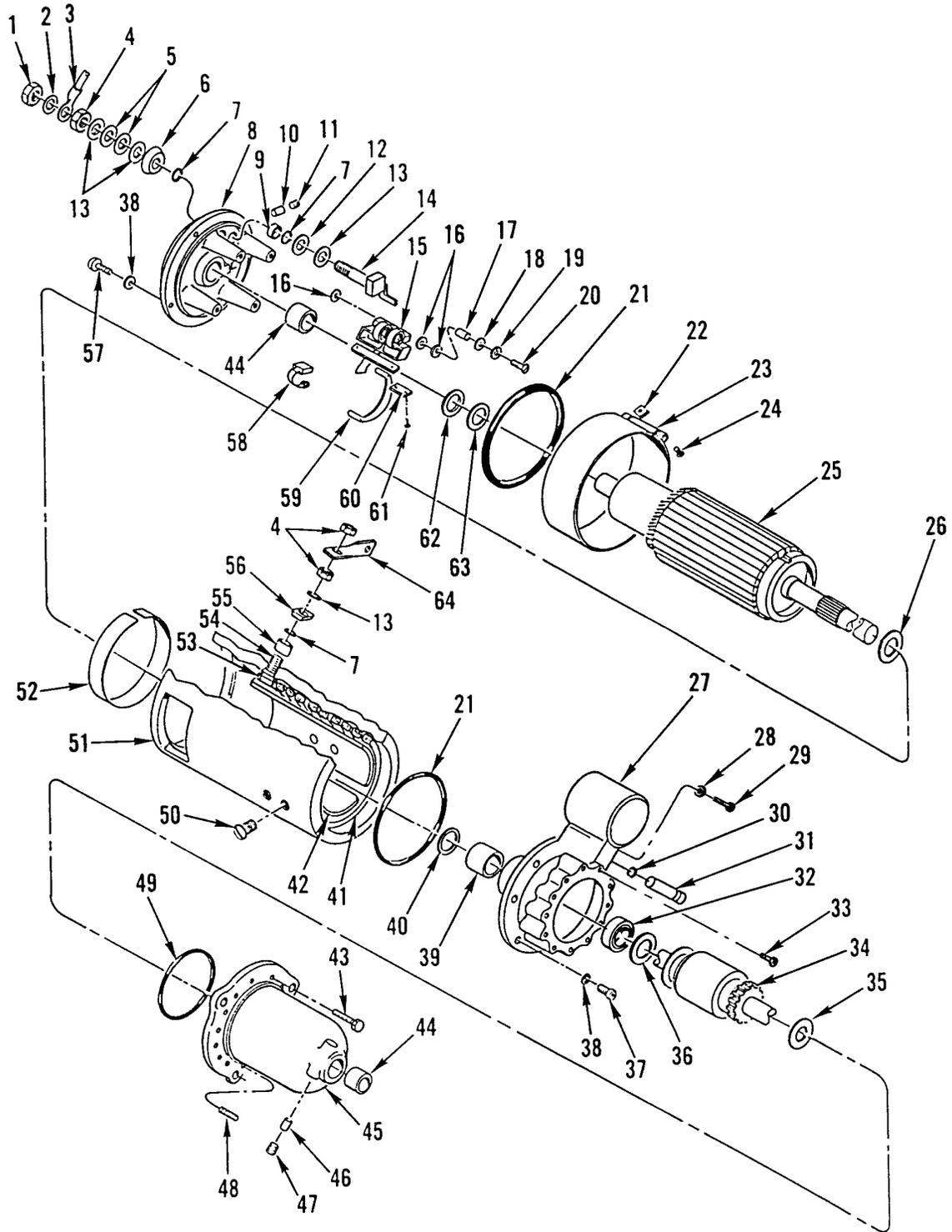

342-1491-1

Figure 60. Starter Assembly (Sheet 1 of 2)

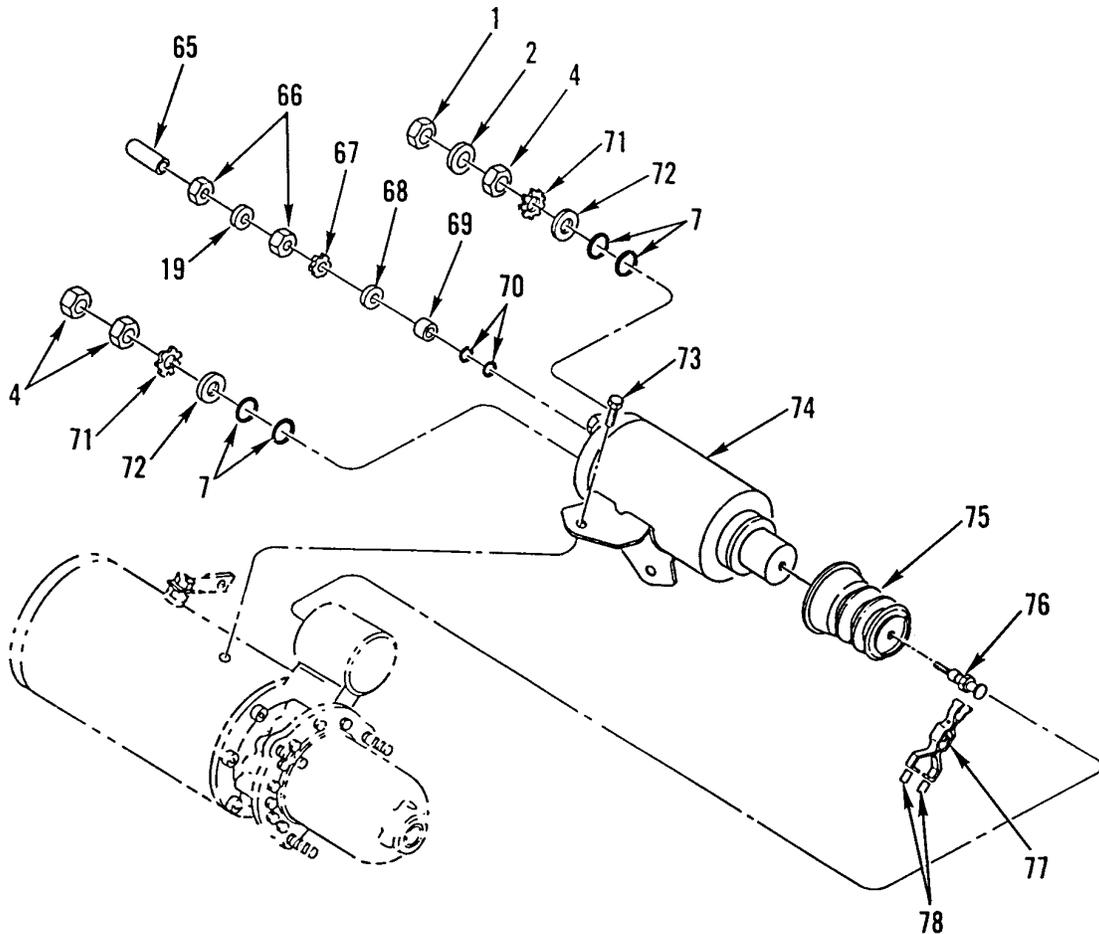

324-1491-2

Figure 60. Starter Assembly (Sheet 2 of 2)

SECTION II			TM9-2320-302-24P			
(1)	(2)	(3)	(4)	(5)	(6)	(7)
ITEM NO	SMR CODE	NSN	CAGEC	PART NUMBER	DESCRIPTION AND USABLE ON CODES(UOC)	QTY
GROUP 0603 STARTING MOTOR						
FIG. 60 STARTER ASSEMBLY						
1	PAFZZ	5310000204787	68505	19X3439	NUT, PLAIN, HEXAGON.....	2
2	PAFZZ	5310011206997	35510	Z0930-78423	WASHER, LOCK.....	2
3	PAFZZ	6150013339318	35510	225087	LEAD, ELECTRICAL.....	1
4	PAFZZ	5310005176564	35510	73450S	NUT, PLAIN, HEXAGON.....	6
5	PAFZZ	5310011121740	35510	75777	WASHER, SPRING TENSI.....	2
6	PAFZZ	5970013080374	35510	95770	INSULATOR, BUSHING.....	1
7	PAFZZ	5331013043453	8E515	Z053095777	O-RING.....	7
8	PFFZZ	2920007647365	35510	73579	HOUSING, COMMUTATOR.....	1
9	PAFZZ	5970013085176	35510	95771	INSULATOR, BUSHING.....	1
10	PAFZZ	9390001128047	35510	38406	WICK.....	1
11	PAFZZ	4730000444688	89346	50410DA	PLUG, PIPE.....	1
12	PAFZZ	5970013076070	35510	95778	INSULATOR, WASHER.....	1
13	PAFZZ	5310002744546	35510	3249	WASHER, FLAT.....	4
14	PAFZZ	2920000586608	24975	M151055272	JUMPER ASSEMBLY.....	1
15	PAFZZ	5977011557352	35510	52720	HOLDER ASSEMBLY, ELE.....	4
16	PAFZZ	5970011186746	35510	78420	INSULATOR, WASHER.....	12
17	PAFZZ	5970011186753	35510	78421	INSULATOR, BUSHING.....	4
18	PAFZZ	5310004420966	83298	19128	WASHER, FLAT.....	4
19	PAFZZ	5310007755139	35510	2434	WASHER, LOCK.....	6
20	PAFZZ	5305013124837	35510	95280	SCREW, MACHINE.....	4
21	PAFZZ	5331008386729	35510	74980	O-RING.....	2
22	PFFZZ	5310005085439	35510	5955	NUT, PLAIN, SQUARE.....	2
23	PFFZZ	5340007647361	35510	74987	COVER, ACCESS.....	1
24	PFFZZ	5305011215475	35510	3966	SCREW, MACHINE.....	2
25	PFFZZ	2920011048951	24975	79390	ARMATURE ASSEMBLY, M.....	1
26	PAFZZ	3120011805624	35510	71245	BEARING, WASHER, THRU.....	1
27	PFFZZ	3040013321633	35510	225265	HOUSING, MECHANICAL.....	1
28	PAFZZ	5310004821999	35510	36900	WASHER.....	1
29	PAFZZ	5305012951317	35510	95648	SETSCREW.....	1
30	PAFZZ	5331006336818	35510	71038	O-RING.....	1
31	PAFZZ	5315013319241	35510	225266	PIN, STRAIGHT, HEADLE.....	1
32	PAFZZ	5330001113795	35510	73498	SEAL, PLAIN.....	1
33	PAFZZ	5305007245903	96906	MS51963-85	SETSCREW.....	1
34	PFFZZ	2920011648123	35510	71157	DRIVE, ENGINE, ELECTR.....	1
35	PAFZZ	3120000820403	35510	71045	BEARING, WASHER, THRU.....	1
36	PAFZZ	5310011121738	35510	78302	WASHER, FLAT.....	1
37	PAFZZ	5305001775568	35510	31757	SCREW, CAP, SOCKET HE.....	5
38	PAFZZ	5310005825965	99539	CBM21389	WASHER, LOCK.....	9
39	PAFZZ	3120001113711	35510	73644	BUSHING, SLEEVE.....	1
40	PAFZZ	5330010796372	35510	97799	SEAL, PLAIN ENCASED.....	1
41	PAFZZ	2920011048950	24975	M027095090	COIL AND JUMPER ASS.....	1
42	PFFZZ	6105010843049	24975	79123	POLE PIECE.....	4
43	PAFZZ	5305004615860	35510	73502	SCREW, CAP, SOCKET HE.....	6
44	PAFZZ	3120000641723	35510	38401	BUSHING, SLEEVE.....	2
45	PFFZZ	3040013321634	35510	79624	HOUSING, MECHANICAL.....	1
46	PAFZZ	9390012047151	35510	99278	WICK.....	1
47	PAFZZ	4730011873645	35510	60263	PLUG, PIPE.....	1
48	PAFZZ	5340011270445	35510	73571	PLUG, PROTECTIVE, DUS.....	6

SECTION II		TM9-2320-302-24P				
(1)	(2)	(3)	(4)	(5)	(6)	(7)
ITEM	SMR			PART		
NO	CODE	NSN	CAGEC	NUMBER	DESCRIPTION AND USABLE ON CODES(UOC)	QTY
49	PAFZZ	5331006336827	35510	71041	O-RING.....	1
50	PAFZZ	5305003354067	35510	7092	SCREW.....	8
51	PAFZZ	2920013326051	35510	79121	HOUSING,ENGINE DRIV.....	1
52	PAFZZ	5970013080375	35510	79529	INSULATOR,SPACER.....	1
53	PAFZZ	5970000355100	35510	71065	INSULATOR.....	1
54	PAFZZ	5940013109565	35510	96021	TERMINAL,STUD.....	1
55	PAFZZ	3120013069870	35510	Z082095780	BUSHING,SLEEVE.....	1
56	PAFZZ	5999013290309	35510	96032	INSULATOR,THERMAL.....	1
57	PAFZZ	5305000680502	96906	MS90725-6	SCREW,CAP,HEXAGON H.....	4
58	PAFZZ	5977007589555	34623	MA35-21072	BRUSH SET,ELECTRICA.....	1
59	PAFZZ	2920010769812	35510	95971	JUMPER,STARTING MOT.....	1
60	PAFZZ	5342011275636	35510	57022	PLATE,LOCK.....	4
61	PAFZZ	5305009846191	96906	MS35206-243	SCREW,MACHINE.....	8
62	PAFZZ	3120004934034	35510	71046	BEARING,WASHER,THRU.....	1
63	PAFZZ	3120000820403	35510	71045	BEARING,WASHER,THRU.....	1
64	PAFZZ	2920010770911	35510	78138	JUMPER,STARTER MOTO.....	1
65	PAFZZ	5340013524352	8E515	95440	CAP,PROTECTIVE,DUST.....	2
66	PAFZZ	5310011069929	35510	2313	NUT.....	4
67	PAFZZ	5310010779648	35510	29968	WASHER,LOCK.....	2
68	PAFZZ	5310003646497	35510	5293	WASHER,FLAT.....	2
69	PAFZZ	5365013366774	35510	225022	BUSHING BLANK.....	2
70	PAFZZ	5330013367291	35510	95781	SEAL,PLAIN.....	4
71	PAFZZ	5310011721991	35510	78328	WASHER,LOCK.....	2
72	PAFZZ	5310011589215	35510	34752	WASHER,FLAT.....	2
73	PAFZZ	5305010804755	35510	73503	SCREW.....	2
74	PAFZZ	2920010826731	35510	S214077452	SWITCH ASSEMBLY,STA.....	1
75	PAFZZ	2530010884432	35510	71163	BOOT,VEHICULAR COMP.....	1
76	PAFZZ	2920011967730	35510	95656	LINK,SPOOL.....	1
77	PAFZZ	2520011873619	35510	97439	SHIFTER FORK,VEHICU.....	1
78	PAFZZ	2920011472208	35510	79144	ARM,CAM LEVER BRASS.....	2

END OF FIGURE

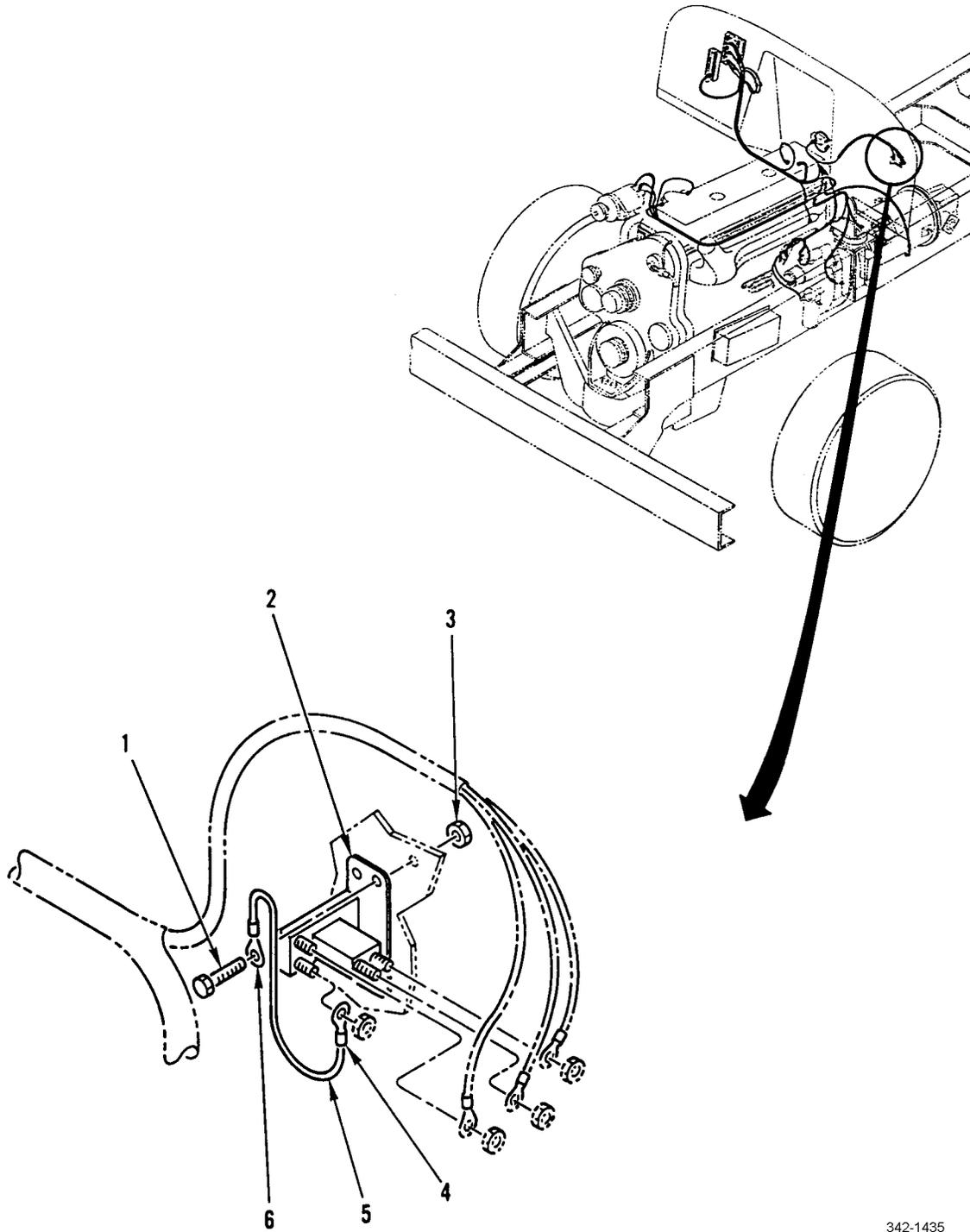

342-1435

Figure 61. Starter Relay (Magnetic Switch)

SECTION II			TM9-2320-302-24P			
(1)	(2)	(3)	(4)	(5)	(6)	(7)
ITEM	SMR			PART		
NO	CODE	NSN	CAGEC	NUMBER	DESCRIPTION AND USABLE ON CODES(UOC)	QTY
					GROUP 0603 STARTING MOTOR	
					FIG. 61 STARTER RELAY (MAGNETIC SWITCH)	
1	PAOZZ	5306001218232	32195	308742	BOLT,MACHINE.....	2
2	PAOZZ	5945013929346	64678	681 546 02 88	SOLENOID,ELECTRICAL.....	1
3	PFOZZ	5310013566158	64678	23-9277-049	NUT,PLAIN,BLIND RIV.....	2
4	PAOZZ	5940001071481	96906	MS20659-104	TERMINAL,LUG.....	1
5	PAOZZ	6145013366678	64678	A06-09664-000	WIRE,ELECTRICAL INCLUDES TERMINAL RINGS.....	1
6	PAOZZ	5940001133145	77060	2984576	TERMINAL,LUG.....	1

END OF FIGURE

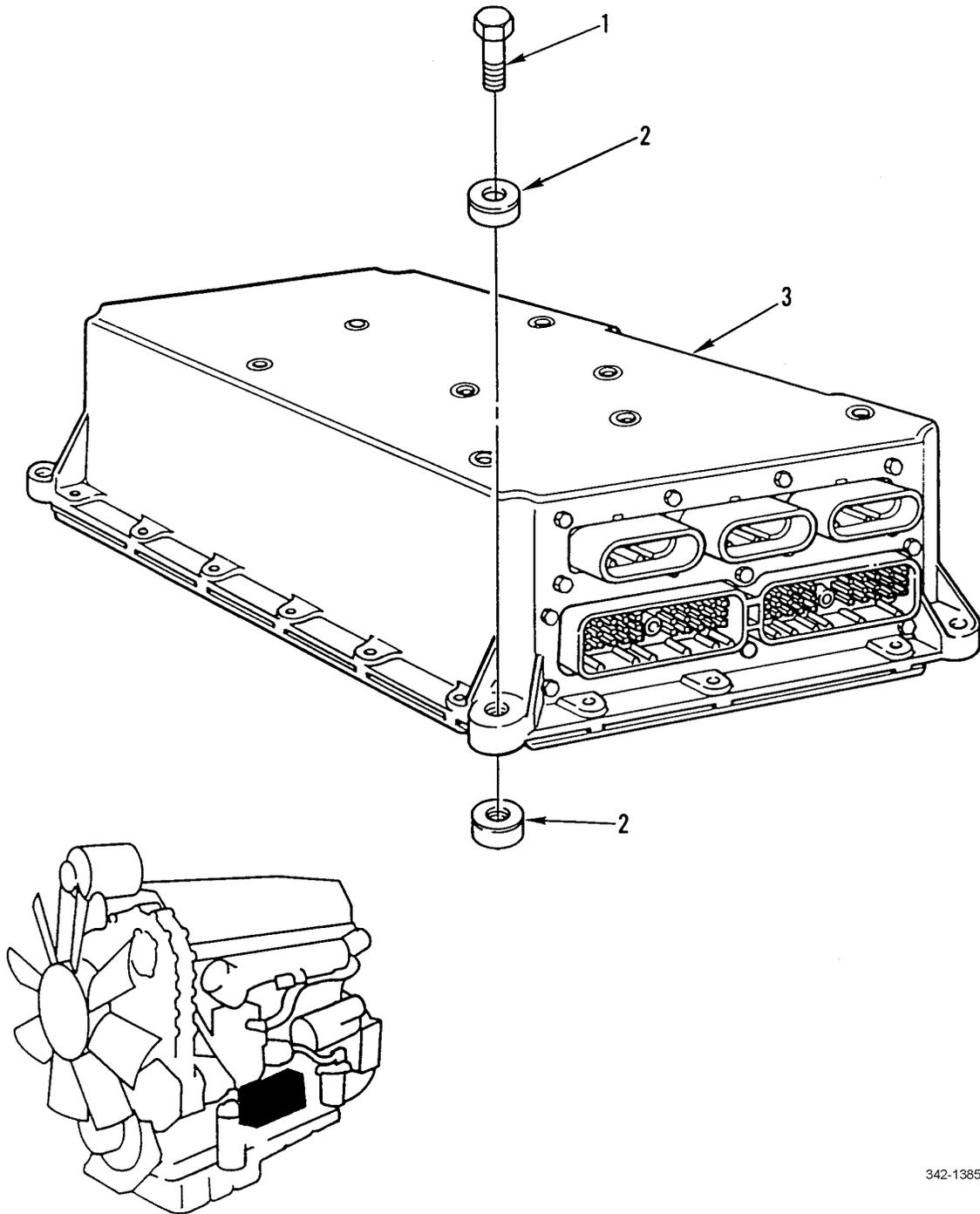

342-1385

Figure 62. Electronic Control Module

SECTION II			TM9-2320-302-24P			
(1)	(2)	(3)	(4)	(5)	(6)	(7)
ITEM	SMR			PART		
NO	CODE	NSN	CAGEC	NUMBER	DESCRIPTION AND USABLE ON CODES(UOC)	QTY
GROUP 0605 IGNITION COMPONENTS						
FIG. 62 ELECTRONIC CONTROL MODULE						
1	PAOZZ		72582	23512309	SCREW,CAP,SOCKET,HE M8 X 1.25 X 40	4
2	PAOZZ	5342014142177	72582	23512307	MM,GR10.9.....	8
3	PAODL		72582	23519308	MOUNT,RESILIENT.....	1
					MODULATOR ASSEMBLY DDC PROGRAMMED	1
					ELECTRONIC CONTROL MODULE.....	

END OF FIGURE

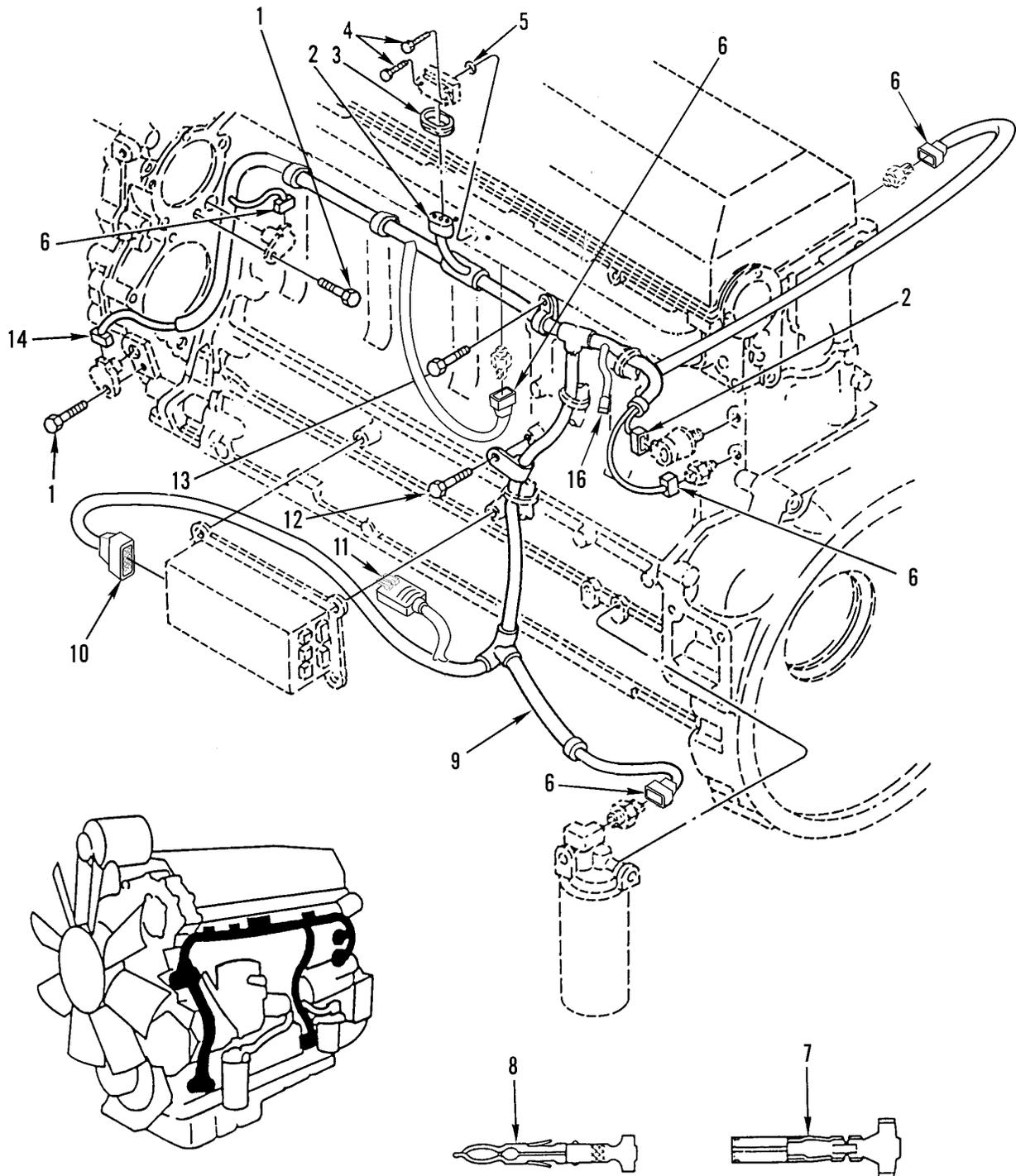

342-1379

Figure 63. Electronic Control Module Wiring Harness

SECTION II			TM9-2320-302-24P			
(1)	(2)	(3)	(4)	(5)	(6)	(7)
ITEM	SMR			PART		
NO	CODE	NSN	CAGEC	NUMBER	DESCRIPTION AND USABLE ON CODES(UOC)	QTY
GROUP 0605 IGNITION COMPONENTS						
FIG. 63 ELECTRONIC CONTROL MODULE WIRING HARNESS						
1	PAOZZ	5306011857051	11862	11504986	BOLT,MACHINE M8 X 1.25 X 14-6G, GR9.8.....	2
2	PFOZZ		77060	12162182	CONNECTOR,PLUG,ELEC.....	2
3	PAOZZ	5330012925293	77060	1201 5284	SEAL,CABLE.....	1
4	XDOZZ		72582	23522719	SCREW,CAP,HEXAGON H M5 X 0.8 X 20MM,GR9.8.....	2
5	PAOZZ	5331006827193	72582	5182977	O-RING.....	1
6	PAOZZ	5935013192334	77060	12040753	CONNECTOR,PLUG,ELEC.....	5
7	PBOZZ	5940013336368	77060	1204 7680	TERMINAL,QUICK DISC.....	V
8	PAOZZ	5940012347272	77060	1208 9040	PIN TERMINAL.....	V
9	PFOZZ		72582	23522323	WIRING HARNESS,BRAN.....	1
10	PAOZZ	5935013181066	77060	12034400	CONNECTOR BODY,PLUG.....	1
11	XDOZZ		77060	12110293	CONNECTOR,PLUG,ELEC.....	1
12	PAOZZ	5306011865367	11862	11503454	BOLT,MACHINE M10 X 1.50 X 20-6G, GR10.9.....	1
13	PAOZZ	5306013213559	72582	23506222	BOLT,MACHINE.....	1
14	PAOZZ	5935013365399	77060	1204 1411	CONNECTOR BODY,PLUG.....	1
15	XDOZZ		77060	12052641	CONNECTOR,PLUG,ELEC.....	1

END OF FIGURE

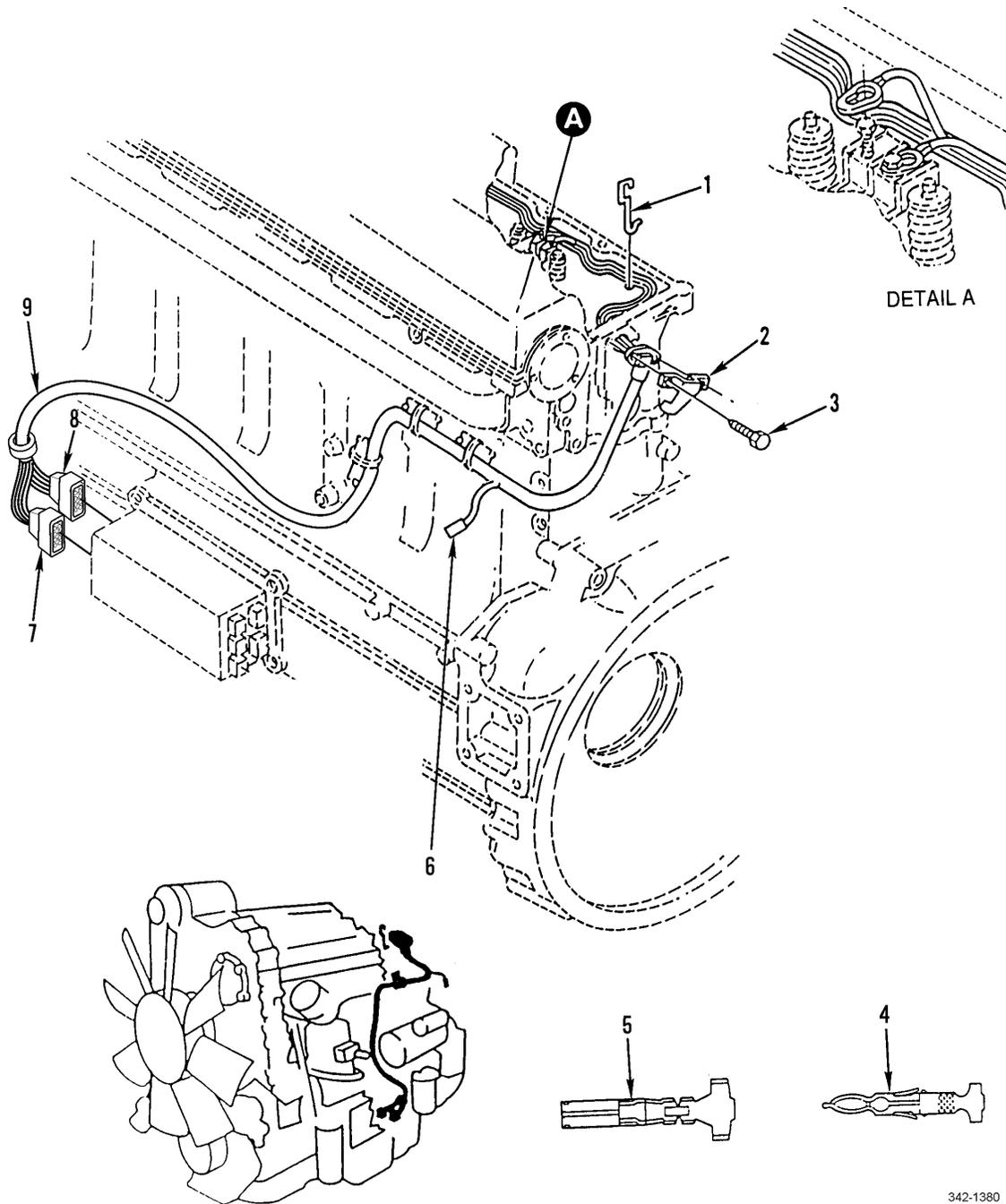

342-1380

Figure 64. Injector Wiring Harness

SECTION II			TM9-2320-302-24P			
(1)	(2)	(3)	(4)	(5)	(6)	(7)
ITEM	SMR			PART		
NO	CODE	NSN	CAGEC	NUMBER	DESCRIPTION AND USABLE ON CODES(UOC)	QTY
GROUP 0605 IGNITION COMPONENTS						
FIG. 64 INJECTOR WIRING HARNESS						
1	PAOZZ	5340013327595	72582	8929534	CLIP,RETAINING.....	1
2	PAOZZ	5340013195305	72582	8929508	COVER,ACCESS.....	1
3	PAOZZ	5306013213559	72582	23506222	BOLT,MACHINE M8 X 1.25 X 20-6G, GR10.9.....	2
4	PAOZZ	5999012149682	77060	1201 0182	CONTACT,ELECTRICAL.....	V
5	PAOZZ	5940013336368	77060	1204 7680	TERMINAL,QUICK DISC.....	V
6	PAOZZ	5935014704143	0FW39	12421884	CONNECTOR BODY,PLUG.....	1
7	PAOZZ	5935013720218	77060	12162825	CONNECTOR BODY,PLUG.....	1
8	PAOZZ	5935013319749	77060	1206 5143	CONNECTOR BODY,PLUG.....	1
9	XDOZZ		72582	23522178	WIRING HARNESS.....	1

END OF FIGURE

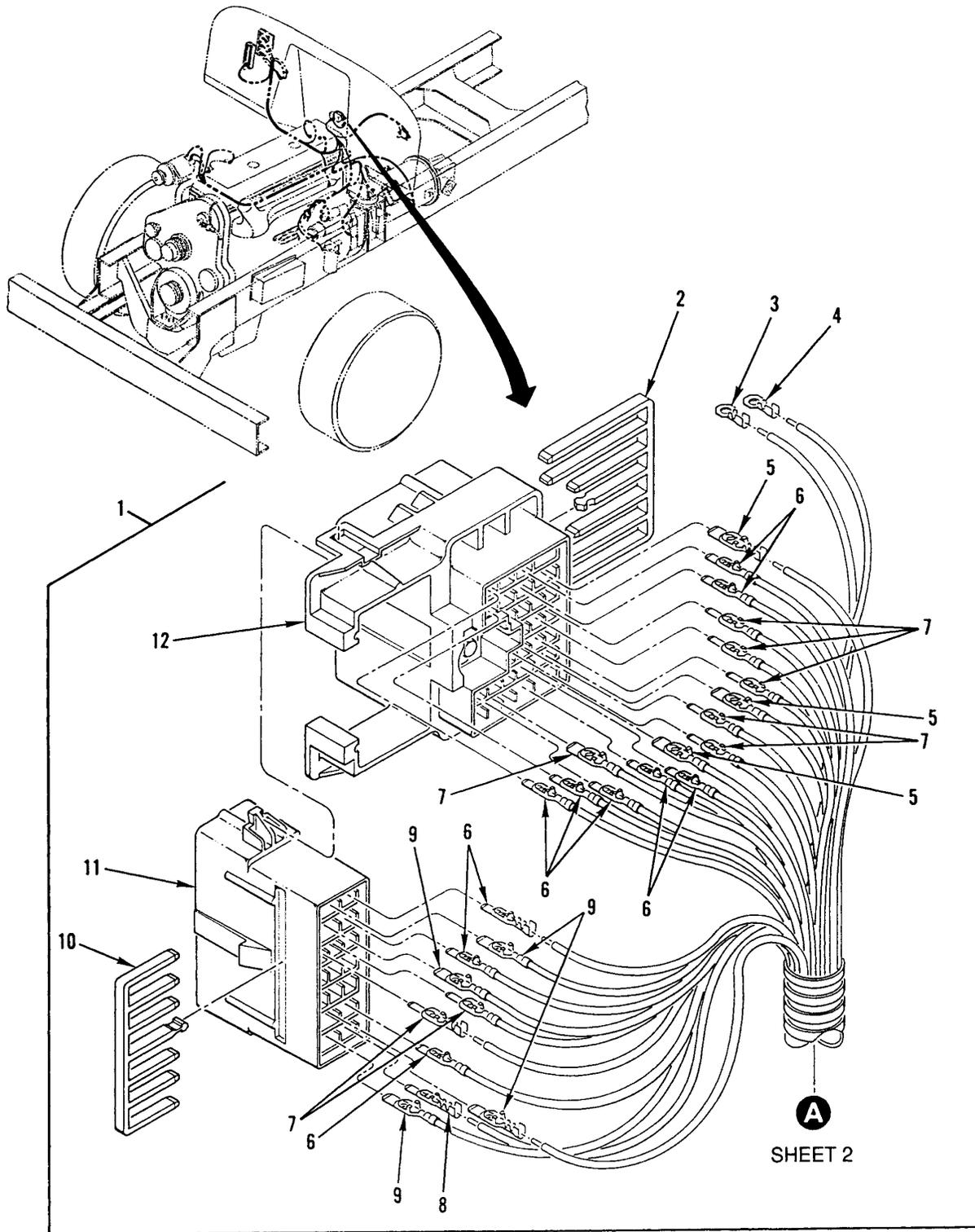

A
SHEET 2

Figure 65. Engine Wiring Harness (Sheet 1 of 3)

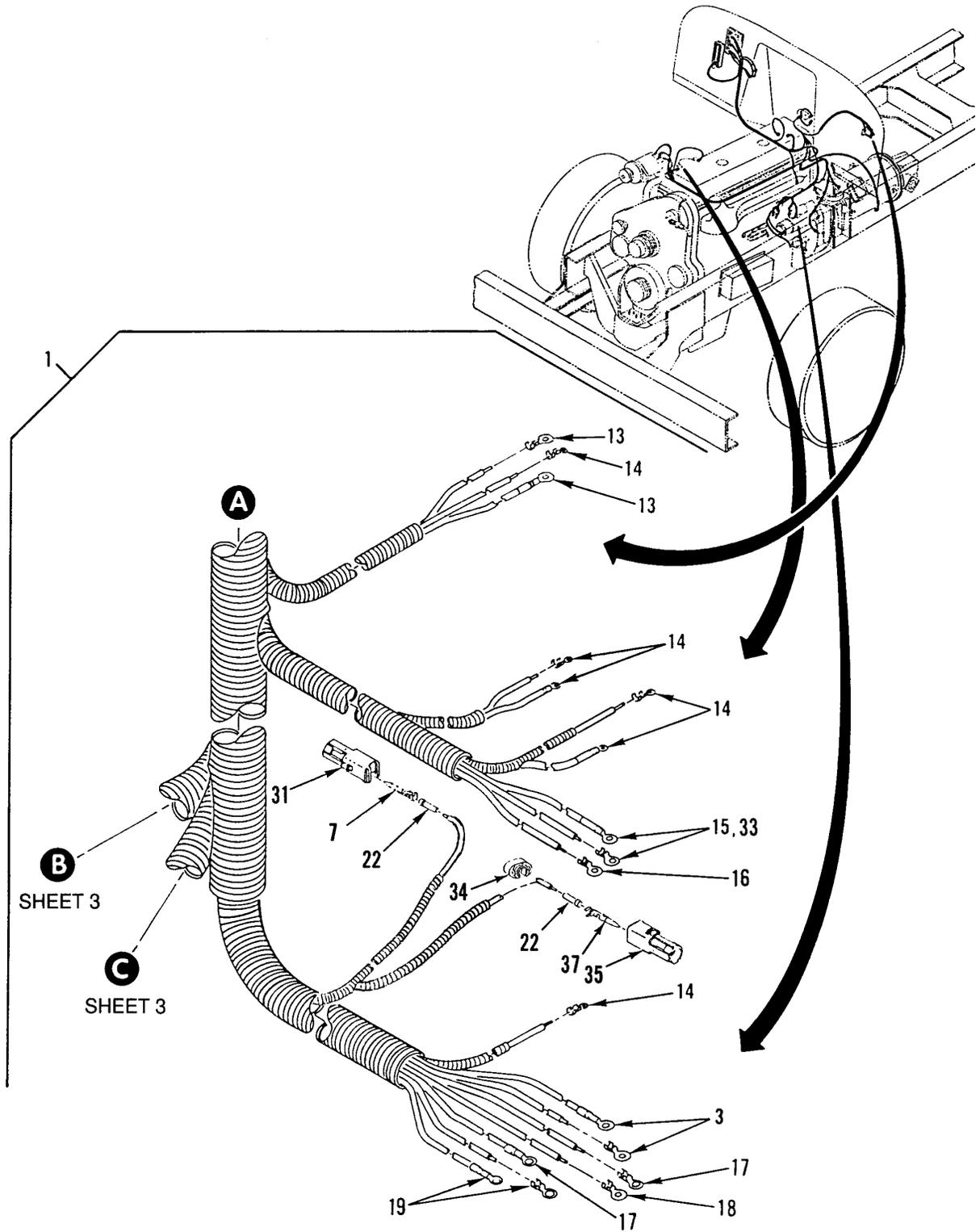

Figure 65. Engine Wiring Harness (Sheet 2 of 3)

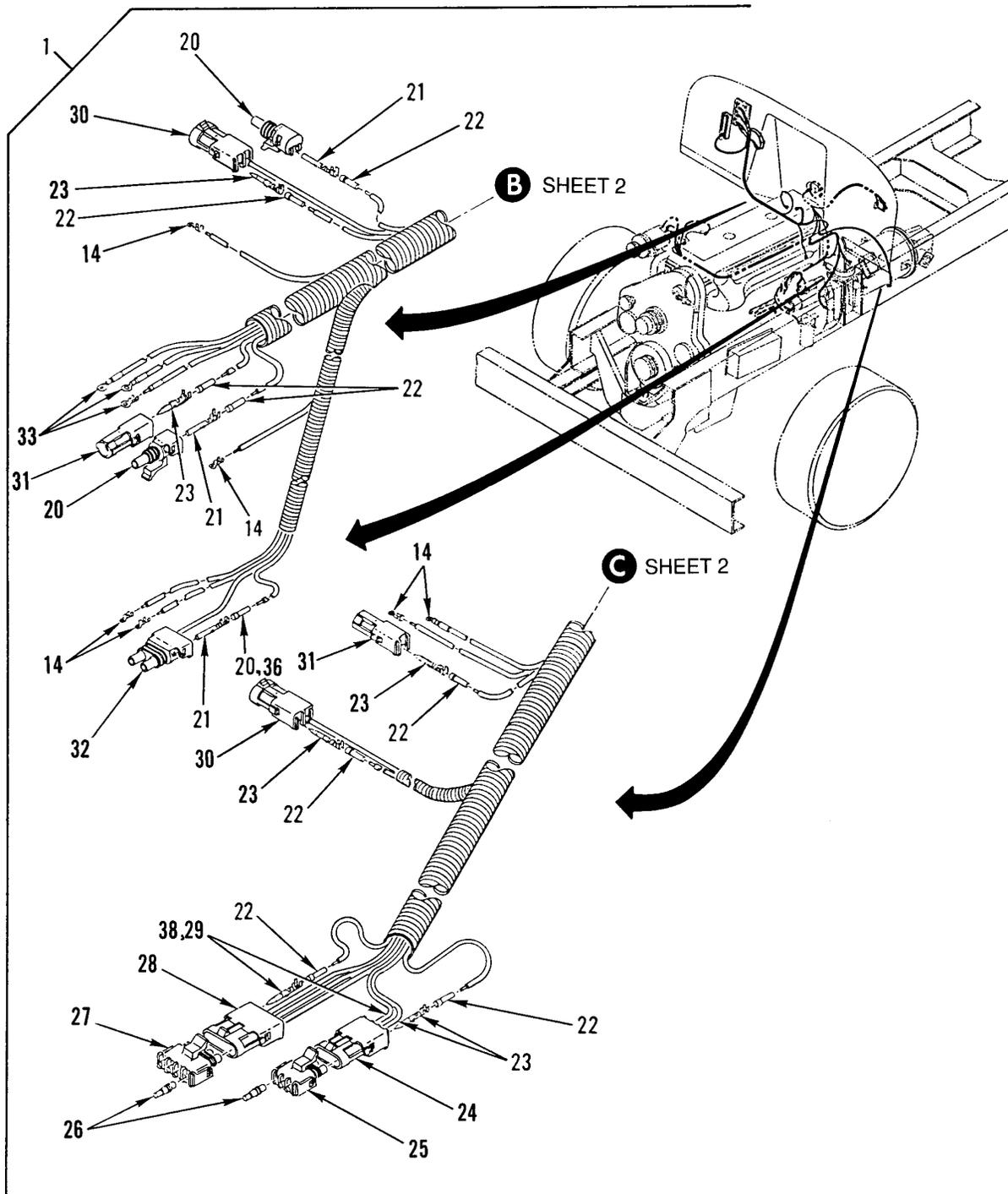
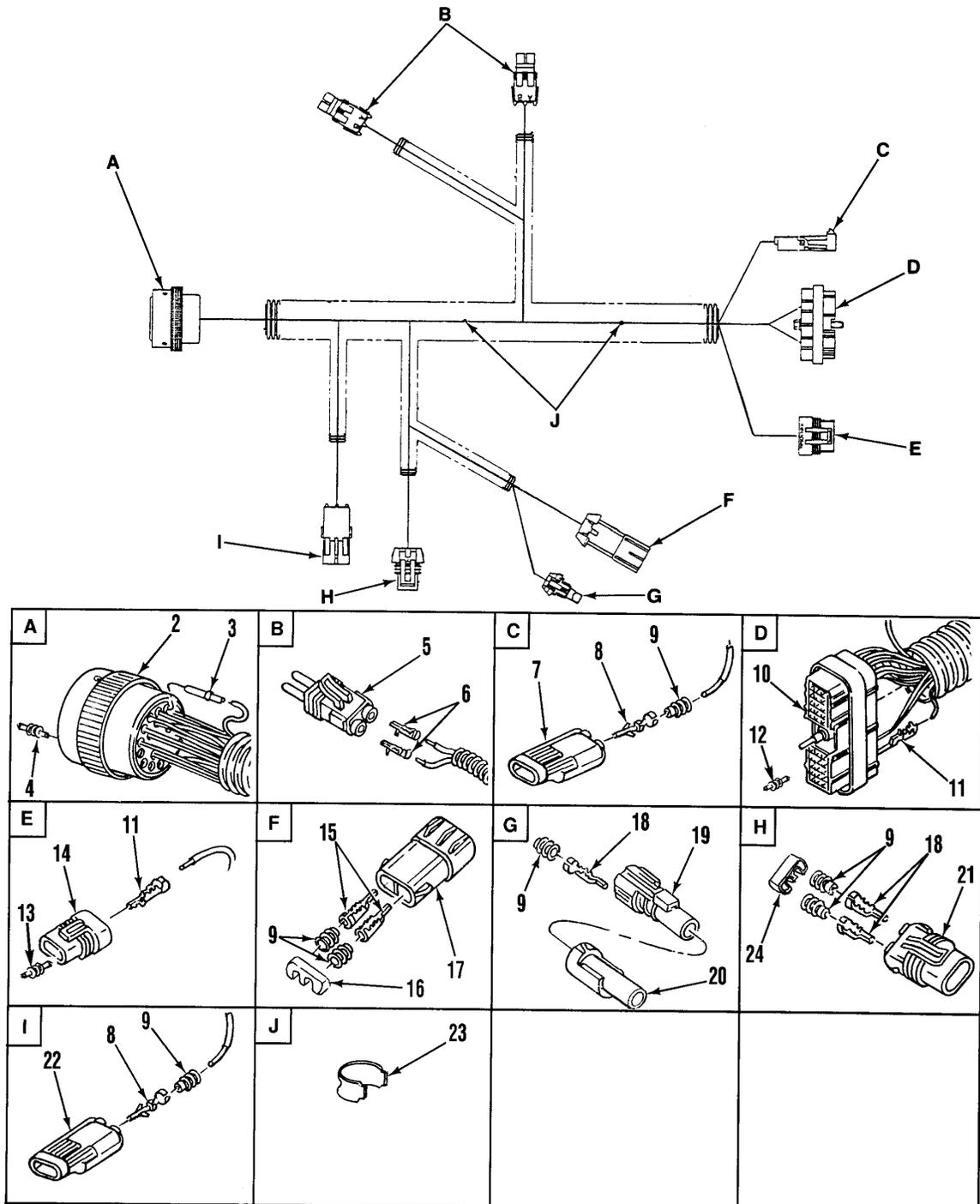

Figure 65. Engine Wiring Harness (Sheet 3 of 3)

SECTION II			TM9-2320-302-24P			
(1)	(2)	(3)	(4)	(5)	(6)	(7)
ITEM	SMR			PART		
NO	CODE	NSN	CAGEC	NUMBER	DESCRIPTION AND USABLE ON CODES(UOC)	QTY
GROUP 0605 IGNITION COMPONENTS						
FIG. 65 ENGINE WIRING HARNESS						
1	XDFFF		64678	A06-23391-000	WIRING HARNESS, BRAN.....	1
2	PFOZZ	5310013507074	77060	1201 5510	.NUT, STAMPED.....	1
3	PAOZZ	5940013365777	77060	2962064	.TERMINAL, STUD.....	3
4	PAOZZ	5940013366322	5R547	101028-B02	.TERMINAL, LUG.....	1
5	PAOZZ	5940013400588	77060	1202 0126	.TERMINAL, QUICK DISC.....	3
6	PAOZZ	5940013421640	77060	1202 0120	.TERMINAL, QUICK DISC.....	6
7	PAOZZ	5940013400587	77060	1202 0116	.TERMINAL, QUICK DISC.....	8
8	PAOZZ	5940013420558	77060	1203 3820	.TERMINAL, QUICK DISC.....	1
9	PAOZZ	5940013366327	77060	12066493	.TERMINAL, QUICK DISC.....	4
10	PFOZZ	5935013369065	77060	1201 5511	.RETAINER, ELECTRICAL.....	1
11	PFOZZ	5935013383534	77060	1202 0629	.CONNECTOR BODY, PLUG.....	1
12	PFOZZ	5935013365395	77060	1201 5509	.CONNECTOR BODY, PLUG.....	1
13	PAOZZ	5940013367056	5R547	110634-AK02	.TERMINAL, LUG.....	2
14	PAOZZ	5940001071481	96906	MS20659-104	.TERMINAL, LUG.....	8
15	PAOZZ	5940013367056	5R547	110634-AK02	.TERMINAL, LUG.....	1
16	PAOZZ	5940001133145	77060	2984576	.TERMINAL, LUG.....	1
17	PAOZZ	5940013366324	00779	61903-1	.TERMINAL, LUG.....	2
18	PAOZZ	5940013366323	77060	12004438	.TERMINAL, LUG.....	1
19	PAOZZ	5940013381964	5R547	110751-D02	.TERMINAL, LUG.....	2
20	PAOZZ	5935012912814	77060	1201 5791	.CONNECTOR, PLUG, ELEC.....	2
21	PAOZZ	5999012149682	77060	1201 0182	.CONTACT, ELECTRICAL.....	4
22	PAOZZ	5975013335974	77060	12015193	.SEAL CABLE.....	12
23	PAOZZ	5999013197394	77060	1208 9305	.CONTACT, ELECTRICAL.....	15
24	PAOZZ	5935013366409	77060	1201 0717	.CONNECTOR BODY, PLUG.....	1
25	PAOZZ	5935012922336	77060	12015793	.CONNECTOR, PLUG, ELEC.....	1
26	PAOZZ	5975013399574	77060	1201 0300	.BOOT, DUST AND MOIST.....	7
27	PAOZZ	5935013088599	77060	1201 5797	.CONNECTOR BODY, PLUG.....	1
28	PAOZZ	5935013365396	77060	1201 0974	.CONNECTOR BODY, PLUG.....	1
29	PAOZZ	5940013367095	64678	1208 9306	.TERMINAL, TAPER RECE.....	5
30	PAOZZ	5935012144163	77060	1201 0973	.CONNECTOR BODY, PLUG.....	1
31	PAOZZ	5935013383532	77060	1201 0996	.CONNECTOR BODY, PLUG.....	2
32	PAOZZ	5935012145259	77060	1201 5792	.CONNECTOR BODY, PLUG.....	1
33	PAOZZ	5940013373812	00779	61868-1	.TERMINAL, LUG.....	4
34	XDOZZ		77060	12065249	.CONNECTOR.....	1
35	XDOZZ		77060	12065171.	.CONNECTOR, RECEPTACL.....	1
36	PAOZZ	5975012268078	77060	1201 0293	.BOOT, DUST AND MOIST.....	2
37	PAOZA	5999014064110	77060	12124582	.CONTACT, ELECTRICAL.....	6
38	XDOZZ		77060	12124587	.TERMINAL, ELEC, PIN.....	5

END OF FIGURE



342-1322

Figure 66. Engine DDEC Wiring Harness

SECTION II			TM9-2320-302-24P			
(1)	(2)	(3)	(4)	(5)	(6)	(7)
ITEM	SMR			PART		
NO	CODE	NSN	CAGEC	NUMBER	DESCRIPTION AND USABLE ON CODES(UOC)	QTY
GROUP 0605 IGNITION COMPONENTS						
FIG. 66 ENGINE DDEC WIRING HARNESS						
1	XDFFF		64678	A06-23390-000	WIRING, HARNESS, BRAN.....	1
2	XDOZZ		11139	HD362431ST	.CONNECTOR BODY, PLUG WITH SOCKET...	1
3	PAOZZ	5999012036687	11139	0462-201-16141	.CONTACT, ELECTRICAL.....	15
4	PAOZZ	5935011741235	11139	114017	.PLUG, END SEAL, ELECT.....	16
5	PAOZZ	5935012145259	77060	1201 5792	.CONNECTOR BODY, PLUG.....	1
6	PAOZZ	5999013234929	77060	1208 9188	.CONTACT, ELECTRICAL.....	4
7	PAOZZ	5935013383532	77060	1201 0996	.CONNECTOR BODY, PLUG.....	1
8	PAOZZ	5940012347272	77060	1208 9040	.PIN TERMINAL.....	1
9	PAOZZ	5330012925293	77060	1201 5284	.SEAL, CABLE.....	12
10	PAOZZ	5935013366408	77060	1203 4398	.CONNECTOR BODY, PLUG.....	1
11	PAOZZ	5940013705059	77060	12103881	.TERMINAL, QUICK DISC.....	21
12	PAOZZ	5935013361792	77060	1203 4413	.PLUG, END SEAL, ELECT.....	10
13	PAOZZ	5340013651035	77060	12059168	.ITEM, SPECIAL.....	5
14	PAOZZ	5940013366544	77060	1206 6317	.TERMINAL JUNCTION B.....	1
15	XDOZZ		77060	12048159	.TERMINAL, MALE.....	2
16	PAOZZ	5340013326696	77060	1530 0014	.STRAP, RETAINING.....	2
17	PAOZZ	5935013393227	77060	1530 0002	.CONNECTOR BODY, PLUG.....	1
18	PAOZZ	5940013533175	77060	12077411	.TERMINAL, QUICK DISC.....	3
19	XDOZZ		77060	12065249	.CONNECTOR.....	1
20	PAOZZ	5935014063802	77060	1206 5172	.CONNECTOR, RECEPTACL.....	1
21	PAOZZ	5935013087866	77060	15300027	.CONNECTOR BODY, PLUG.....	1
22	PAOZZ	5935012144163	77060	1201 0973	.CONNECTOR BODY, PLUG.....	1
23	PFOZZ	5940008425353	77060	1839906	.SPLICE, CONDUCTOR.....	2

END OF FIGURE

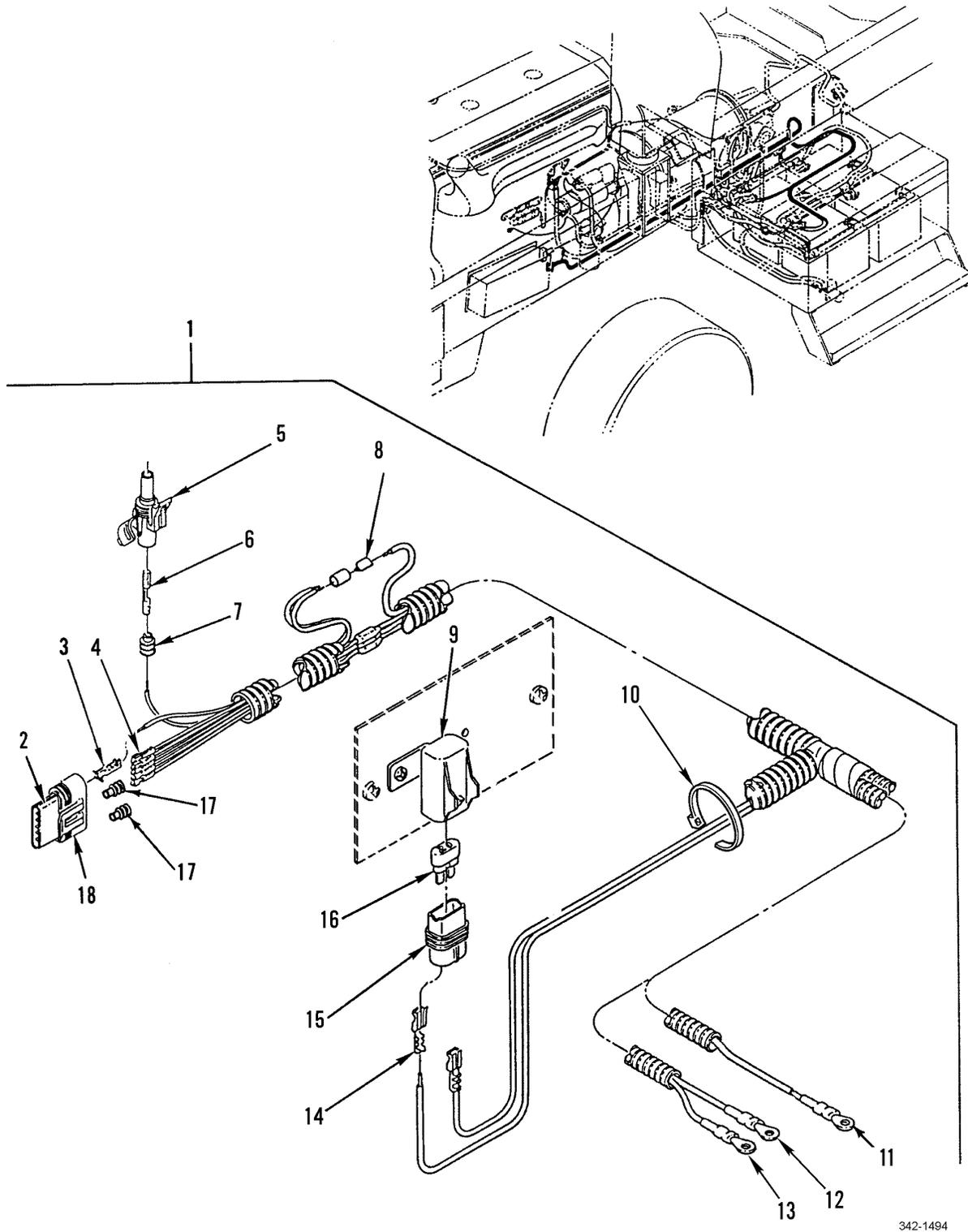

342-1494

Figure 67. Power DDEC Wiring Harness

SECTION II			TM9-2320-302-24P			
(1)	(2)	(3)	(4)	(5)	(6)	(7)
ITEM	SMR			PART		
NO	CODE	NSN	CAGEC	NUMBER	DESCRIPTION AND USABLE ON CODES(UOC)	QTY
GROUP 0605 IGNITION COMPONENTS						
FIG. 67 POWER DDEC WIRING HARNESS						
1	XDOOO		64678	A06-32225-060	WIRING HARNESS.....	1
2	PFOZZ	5935014476280	77060	12124634	.CONNECTOR BODY,PLUG.....	1
3	XDOZZ		77060	12077413	.TERMINAL,QUICK DISC.....	4
4	PAOZZ	5940013533175	77060	12077411	.TERMINAL,QUICK DISC.....	1
5	PAOZZ	5935012912814	77060	1201 5791	.CONNECTOR,PLUG,ELEC.....	1
6	PAOZZ	5999014229740	19207	12420936	.CONTACT,ELECTRICAL.....	1
7	PAOZZ	5975012268078	77060	12010293	.BOOT,DUST AND MOIST.....	1
8	PAOZZ	5940008425353	77060	1839906	.SPLICE,CONDUCTOR.....	2
9	PFOZZ	5935013370288	64678	1208-9272	.DUMMY CONNECTOR,REC.....	1
10	PAOZZ	5975013389190	16956	08-402	STRAP,TIEDOWN,ELECT.....	1
11	PAOZZ	5940001139820	96906	MS20659-128	.TERMINAL,LUG.....	1
12	PAOZZ	5940013382929	00779	61863-2	.TERMINAL,LUG.....	1
13	XDOZZ		77060	12004437	.TERMINAL,LUG 1/2" STUD, 10/12	1
						WIRE SIZE.....
14	PFOZZ	5940013366331	77060	1203 3997	.TERMINAL,QUICK DISC.....	2
15	XDOZZ		77060	12085030	.HOLDER,FUSE.....	1
16	PAOZZ	5920011496952	11862	12004008	.FUSE,INCLOSED LINK 15 AMP.....	1
17	PAOZZ	5975013400600	77060	12015360	.BOOT,DUST AND MOIST.....	4
18	XDOZZ		77060	12052816	.LOCK,SECONDARY.....	1

END OF FIGURE

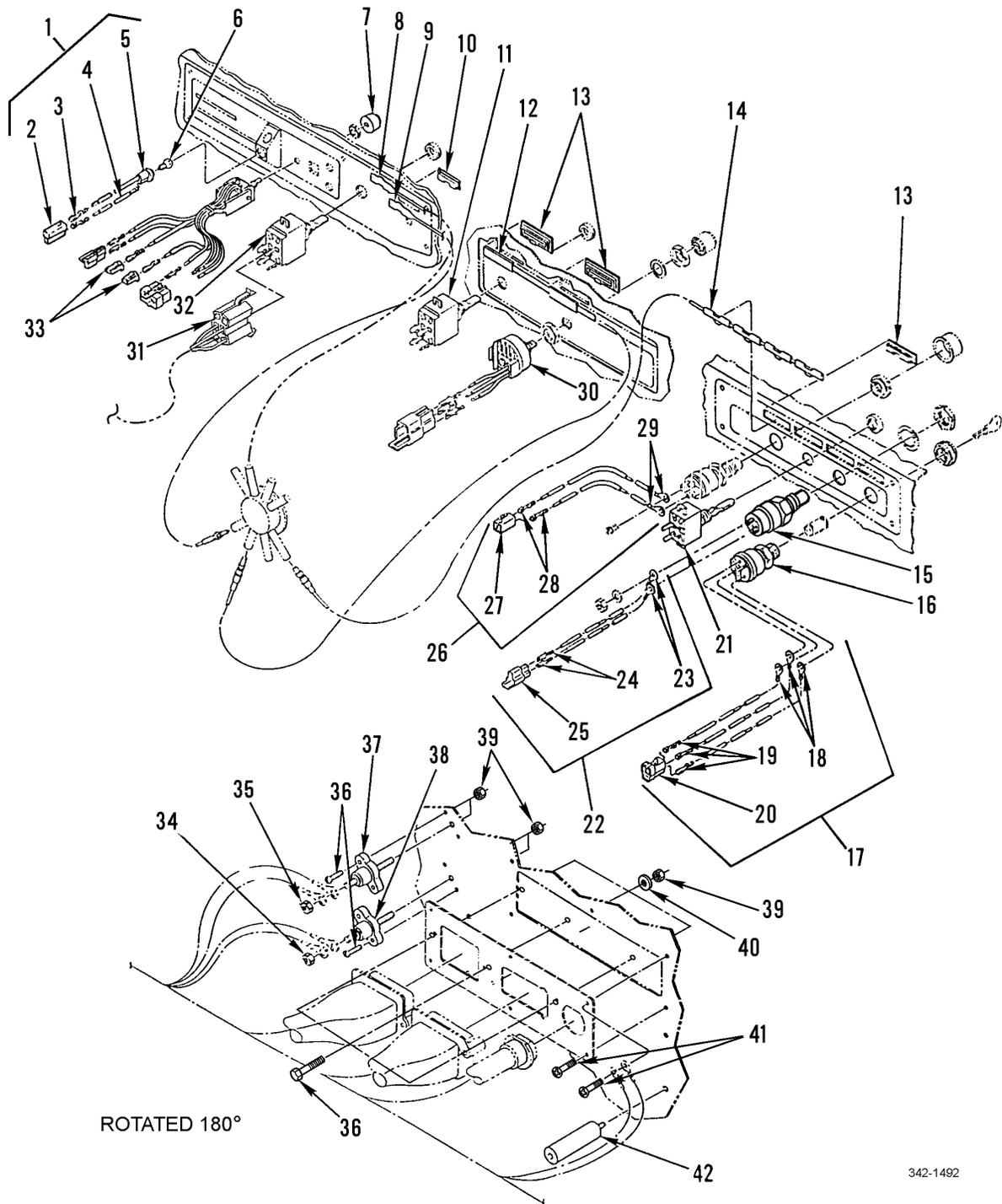
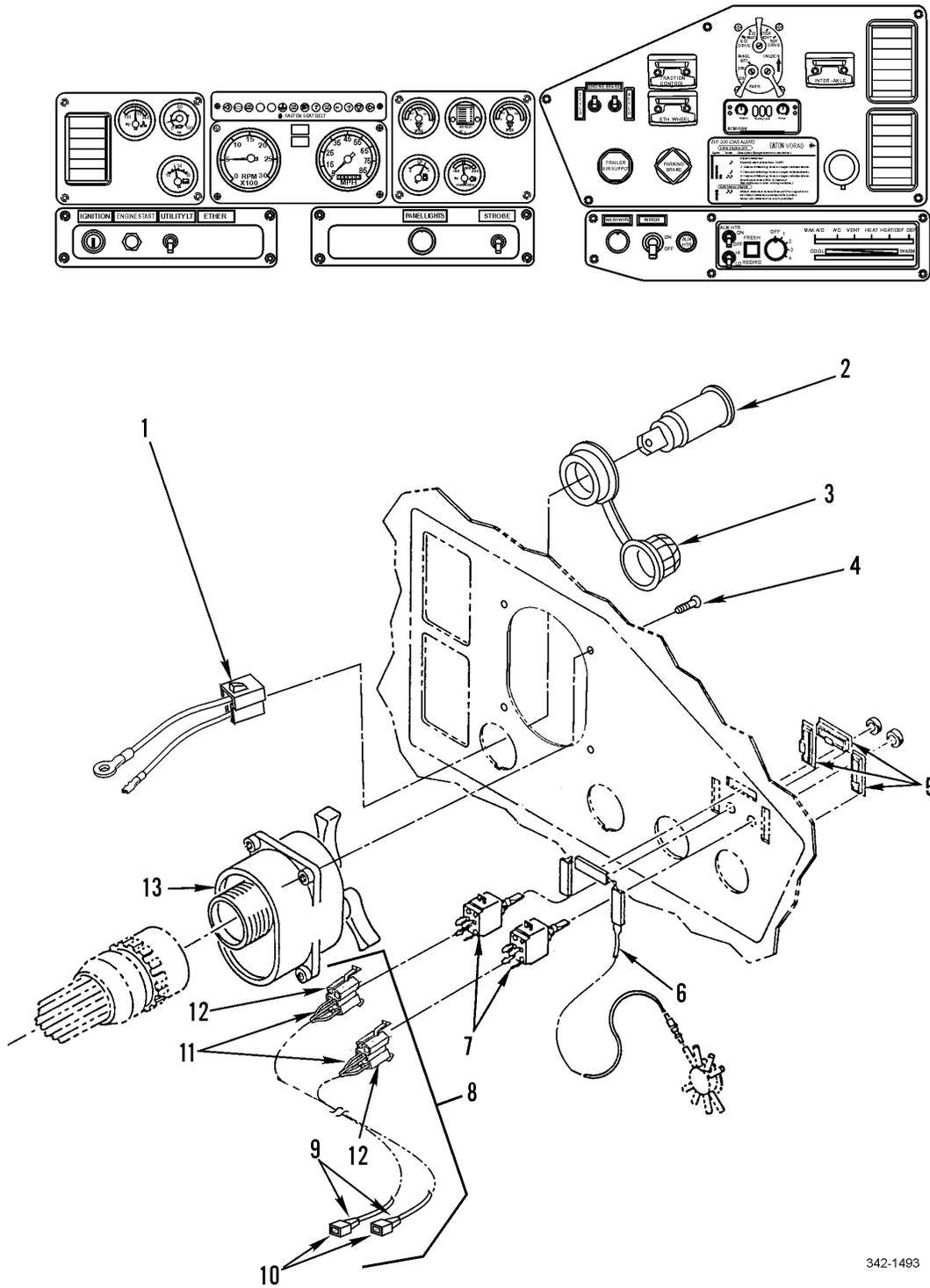

Figure 68. Instrument Panel Switches

SECTION II		TM9-2320-302-24P				
(1)	(2)	(3)	(4)	(5)	(6)	(7)
ITEM NO	SMR CODE	NSN	CAGEC	PART NUMBER	DESCRIPTION AND USABLE ON CODES(UOC)	QTY
GROUP 0607 INSTRUMENT OR ENGINE CONTROL PANEL						
FIG. 68 INSTRUMENT PANEL SWITCHES						
1	PAOZZ	6250014786934	64678	A22-35399-000	LIGHT, INDICATOR.....	1
2	PAOZZ	2920013374135	32498	588-11	SOCKET, LIGHT, VEHICU.....	1
3	PAOZZ	5940013374910	77060	2965141	TERMINAL, QUICK DISC.....	2
4	PAOZZ	5999013574951	64678	A22-16019-000	CONTACT, ELECTRICAL.....	1
5	PAOZZ	5935011618087	77060	2973781	CONNECTOR BODY, PLUG.....	1
6	PAOZZ	6240013450526	79500	293	LAMP, INCANDESCENT.....	1
7	PAOZZ	5355014788725	64678	22-23372-001	KNOB INCLUDES SET SCREW (WIPER CONTROL).....	1
8	PFOZZ	6210014787235	64678	24-00442-000	INSERT, LEGEND, LIGHT MIRROR HEATER..	1
9	PFOZZ		64678	A22-25231-008	LIGHTPIPE, FIBER OPT.....	1
10	XDOZZ		64678	E24-00242-009	BEZEL, INSTRUMENT BEACON.....	1
11	PAOZZ	5930013369056	64678	681 545 10 22	SWITCH, TOGGLE.....	1
12	XDOZZ		64678	A22-35023-000	TAPE ASSY, RH SW.....	1
13	PFOZZ	6695013336750	64678	22-21148-000	BEZEL, INSTRUMENT MO.....	1
14	XDOZZ		64678	A22-35022-000	TAPE ASSY, LH SW.....	1
15	PAOZZ	5930014386328	77326	24-405	SWITCH, ROTARY.....	1
16	PAOZZ	2920013381069	77326	31-200	SWITCH, LOCK, IGNITIO.....	1
17	PFOZZ	6150013391204	64678	A06-18247-000	LEAD ASSEMBLY, ELECT.....	1
18	PAOZZ	5940013417689	77060	12004436	. TERMINAL, LUG.....	3
19	PAOZZ	5940013366326	77060	2965143	. TERMINAL, QUICK DISC.....	3
20	PAOZZ	5935003781253	77060	2984378	. CONNECTOR BODY, RECE.....	1
21	PAOZZ	5930013320680	13445	59024-33	SWITCH, TOGGLE.....	1
22	PFOZZ	6150013366470	64678	A06-18247-001	WIRING HARNESS.....	1
23	PAOZZ	5940001071481	96906	MS20659-104	. TERMINAL, LUG.....	2
24	PAOZZ	5940009563517	77060	2962987	. TERMINAL, QUICK DISC.....	2
25	PAOZZ	5935012963521	77060	2984883	. CONNECTOR BODY, PLUG.....	1
26	PFOZZ	6150013373427	64678	A06-18247-002	WIRING HARNESS, BRAN.....	1
27	XDOZZ		77060	2977373	. CONNECTOR, PLUG, ELEC.....	1
28	PAOZZ	5940007881586	77060	2965142	. TERMINAL, QUICK DISC.....	2
29	PAOZZ	5940001071481	96906	MS20659-104	. TERMINAL, LUG.....	2
30	PAOZZ	5905013574958	58723	6400-7051	RESISTOR, VARIABLE, W.....	1
31	PAOZZ		64678	A06-35602-000	WIRING HARNESS, BRAN HEATED MIRROR..	1
32	PAOZZ	5930013320680	64678	681 545 07 22	SWITCH, TOGGLE MIRROR HEATER.....	1
33	PAOZZ	5935010657984	10988	2977253	CONNECTOR, PLUG, ELEC.....	2
34	PAOZZ	5310000881251	81349	M45913/1-4CG5C	NUT, SELF LOCKING, HE 1/4-20UNC.....	2
35	PAOZZ	5310000874652	96906	MS51922-17A	NUT, SELF-LOCKING, HE 3/8-16UNC.....	1
36	PAOZZ	5305013366595	64678	23-10410-712	SCREW, MACHINE 10-24 X 1 1/4.....	8
37	PAOZZ	5940013396981	11873	JB2520-001	TERMINAL, STUD.....	1
38	PAOZZ	5940013367061	11873	JB3816-202	TERMINAL, FEEDTHRU.....	1
39	PAOZZ	5310013294045	64678	23-09336-005	NUT, SELF-LOCKING, CL CLR LOCK, 10-24.	8
40	PAOZZ	5310000145850	96906	MS27183-42	WASHER, FLAT .219 ID X .500 OD X .049 THK.....	4
41	XDOZZ		64678	23-10414-706	SCREW, MACHINE 1/4-20 X .75 (TORX HEAD).....	6
42	PAOZZ	5340013366115	64678	06-18338-000	POST, ELECTRICAL-MEC.....	4

END OF FIGURE



342-1493

Figure 69. Right Dash Panel Switches

SECTION II			TM9-2320-302-24P			
(1)	(2)	(3)	(4)	(5)	(6)	(7)
ITEM	SMR			PART		
NO	CODE	NSN	CAGEC	NUMBER	DESCRIPTION AND USABLE ON CODES(UOC)	QTY
GROUP 0607 INSTRUMENT OR ENGINE CONTROL PANEL						
FIG. 69 RIGHT DASH PANEL SWITCHES						
1	PAOZZ	6150014786791	64678	A06-32989-000	WIRING HARNESS,BRAN.....	1
2	PAOZA	2540014789089	10966	216806 004	HOUSING,CIGERETTE L 12V.....	1
3	PAOZZ	5999014786780	10966	217131 001	CAP,ELECTRICAL.....	1
4	XDOZZ		64678	23-10411-710	SCREW 10-32UNF X 1.0 (TORX HEAD)...	4
5	PFOZZ	6695013336750	64678	22-21148-000	BEZEL,INSTRUMENT MO.....	3
6	PFOZZ	6220013335592	64678	A22-25231-003	LIGHT,PANEL.....	1
7	PAOZZ	5930013320680	64678	681 545 07 22	SWITCH,TOGGLE.....	2
8	XDOOO		64678	A06-23362-000	WIRING HARNESS,ELEC.....	1
9	PAOZZ	5940013476143	77060	2965439	.TERMINAL,QUICK DISC.....	2
10	PAOZZ	5940012347954	77060	2984528	.TERMINAL BODY,QUICK.....	2
11	PAOZZ	5940013374910	77060	2965141	.TERMINAL,QUICK DISC.....	2
12	PAOZZ	5935010657984	77060	2977253	.CONNECTOR,PLUG,ELEC	2
13	PAOZZ		5A910	DC9653	SWITCH ASSEMBLY.....	1

END OF FIGURE

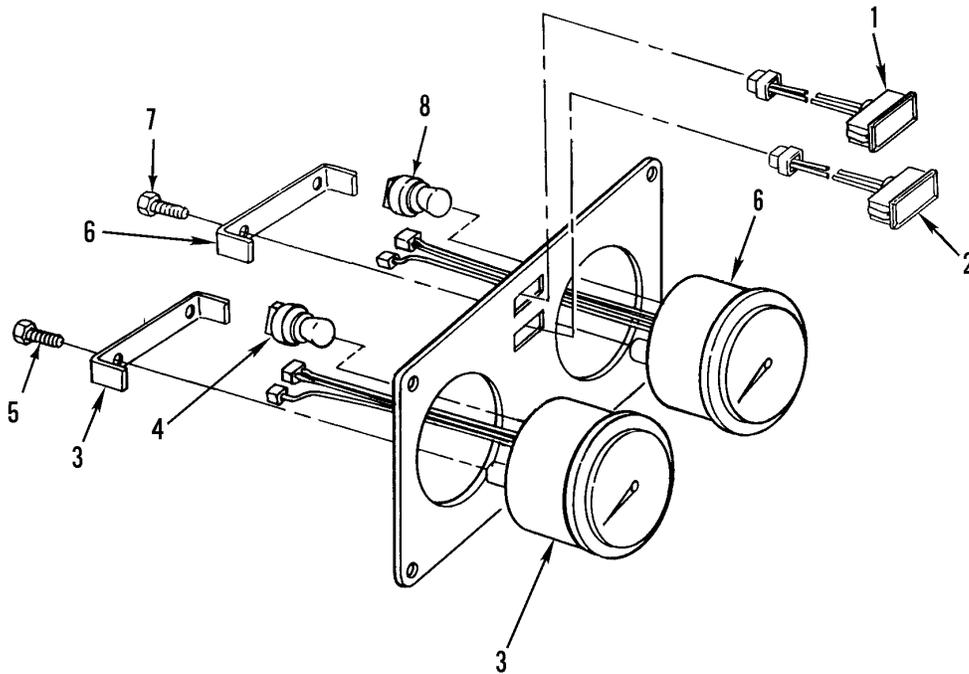
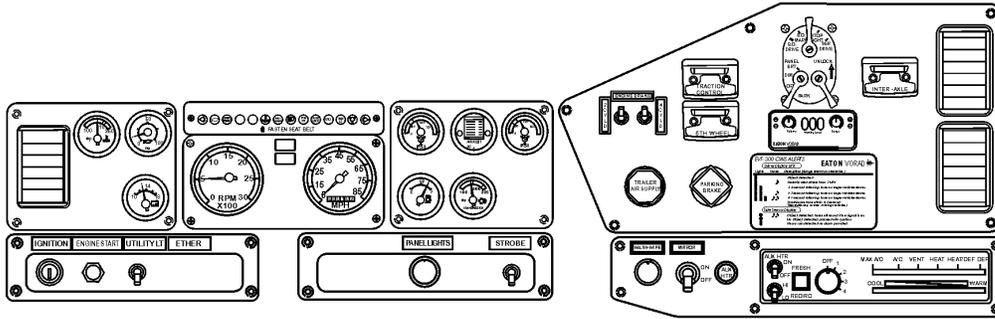
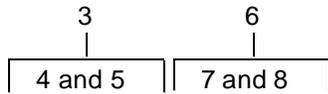

342-1323

Figure 70. Center Dash Panel

SECTION II			TM9-2320-302-24P			
(1)	(2)	(3)	(4)	(5)	(6)	(7)
ITEM	SMR			PART		
NO	CODE	NSN	CAGEC	NUMBER	DESCRIPTION AND USABLE ON CODES(UOC)	QTY
					GROUP 0607 INSTRUMENT OR ENGINE CONTROL PANEL	
					FIG. 70 CENTER DASH PANEL	
1	PAOZZ	6220014421071	64678	06-22309-000	LIGHT,INDICATOR PARKING BRAKE.....	1
2	PAOZZ	6220014402402	64678	06-22309-001	LIGHT,INDICATOR.....	1
3	PAOZZ	6680013918589	64678	A22-38915-000	TACHOMETER,MECHANIC.....	1
4	PAOZZ	6250014430403	64678	AMA/Y101506	.LAMPHOLDER.....	1
5	PFOZZ	5305014440597	64678	23-12067-062	.SCREW,TAPPING 8-16 X 0.62.....	2
6	PAOZZ	6680013918588	64678	A22-38898-000	SPEEDOMETER.....	1
7	PFOZZ	5305014440597	64678	23-12067-062	.SCREW,TAPPING 8-16 X 0.62.....	2
8	PAOZZ	6250014430403	61349	Y101506	.HOLDER,LAMP.....	1

END OF FIGURE

5
|
6 thru 14

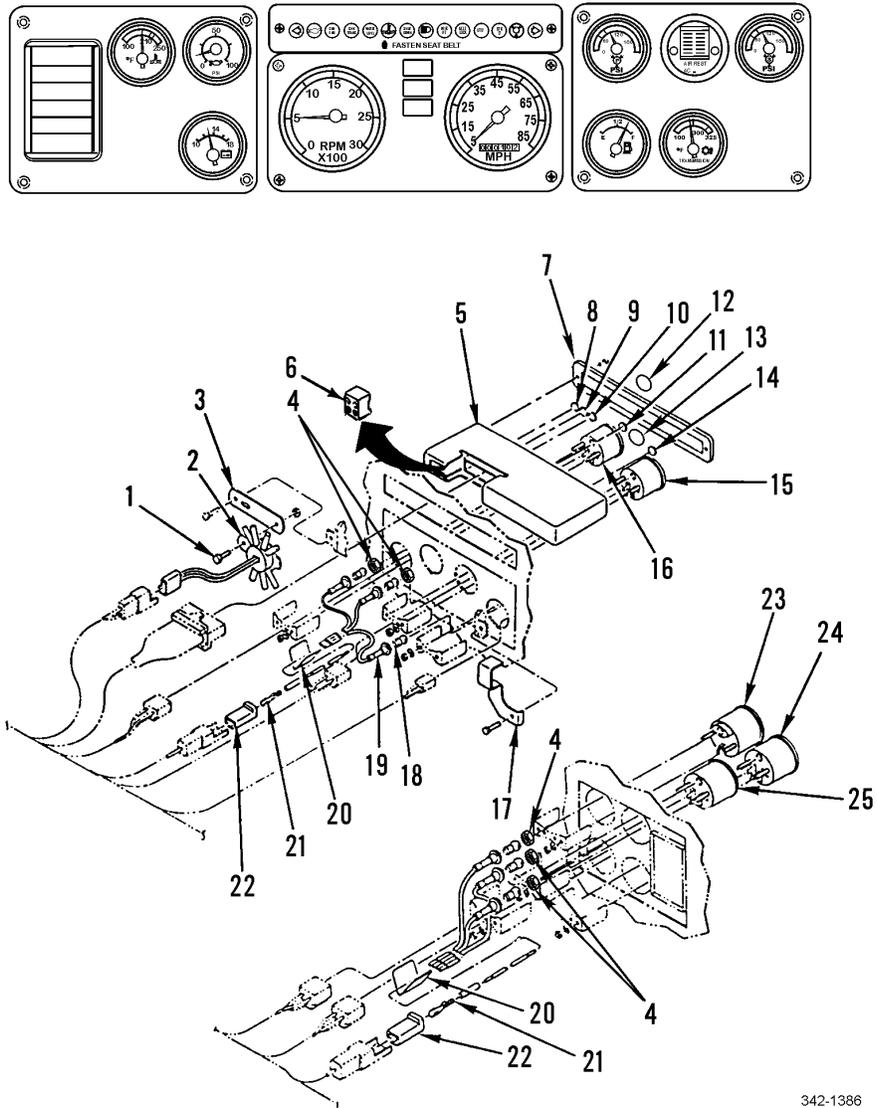

342-1386

Figure 71. Left and Center Dash Panel Gauges

SECTION II			TM9-2320-302-24P			
(1)	(2)	(3)	(4)	(5)	(6)	(7)
ITEM	SMR			PART		
NO	CODE	NSN	CAGEC	NUMBER	DESCRIPTION AND USABLE ON CODES(UOC)	QTY
					GROUP 0607 INSTRUMENT OR ENGINE CONTROL PANEL	
					FIG. 71 LEFT AND CENTER DASH PANEL GAGES	
1	PAOZZ	5305013369151	64678	23-10410-706	SCREW,MACHINE.....	1
2	PFOZZ	6220013385772	28803	500-9302	LAMP UNIT,VEHICULAR.....	1
3	PAOZZ	5340013363269	64678	23-09130-008	BRACKET,ANGLE.....	1
4	PAOZZ	5310013365344	64678	23-09337-105	NUT,SELF-LOCKING,CA.....	2
5	XDOOO		64678	A06-18114-001	PANEL,VEHICULAR,OPE.....	1
6	PAOZZ	2590014354231	06853	550502	.WARNING ASSEMBLY,VE.....	1
7	XAOZZ		64678	22-39473-002	.LIGHTBAR,VIGIL I.....	1
8	PAOZZ	6220013385780	64678	24-00407-006	.LENS,LIGHT.....	1
9	PAOZZ	6220013385779	64678	681 545 50 90	.LENS,LIGHT.....	1
10	PAOZZ	6220013483028	64678	681 545 55 90	.LENS,LIGHT.....	1
11	PAOZZ	6220013385781	64678	681 545 58 90	.LENS,LIGHT.....	1
12	PAOZZ	6210014787219	64678	24-00407-027	.INSERT,LEGEND,LIGHT CHECK TRANS...	1
13	PFOZZ	6210014787230	64678	681 545 47 90	.LENS,LIGHT MIRROR HEATER.....	1
14	PAOZZ	6220013417723	64678	681 545 37 90	.LENS,LIGHT.....	1
15	PAOZZ	6685013419125	57733	467-ED	INDICATOR,TEMPERATU TRANSMISSION OIL.....	1
16	PAOZZ		61349	162309	METER,ARBITRARY SCA FUEL GAGE, INCLUDES MOUNTING HARDWARE.....	1
17	PFOZZ	5340013363930	64678	681 065 01 040	BRACKET,ANGLE.....	1
18	PAOZZ	6240009469654	08108	1895	LAMP,INCANDESCENT.....	8
19	PAOZZ	6250013385816	64678	A22-11731-003	LAMPHOLDER.....	8
20	PAOZZ	5940008425353	77060	1839906	SPLICE,CONDUCTOR.....	2
21	PAOZZ	5940007881586	77060	2965142	TERMINAL,QUICK DISC.....	2
22	PAOZZ	5935010657984	10988	2977253	CONNECTOR,PLUG,ELEC.....	2
23	PAOZZ	6620014787549	61349	162312	GAUGE,PRESSURE,DAIL ENGINE OIL.....	1
24	PAOZZ	6620013385952	64678	A22-39127-000	VOLTMETER.....	1
25	PAOZZ	6685013398261	57733	467-EC	INDICATOR,TEMPERATU ENGINE COOLANT.	1

END OF FIGURE

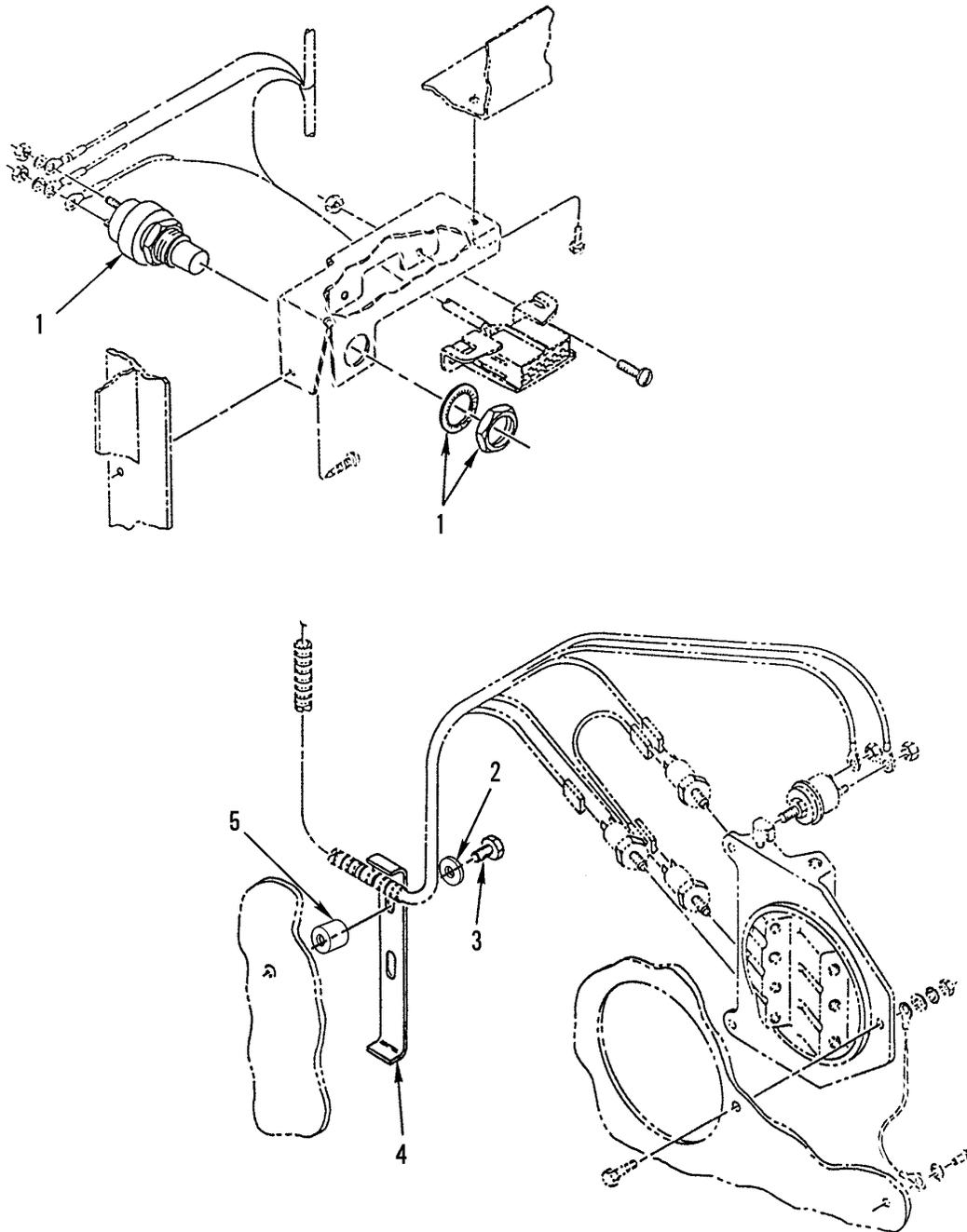

342-1381

Figure 72. Engine Check Switch and Cab Air Junction Block Wiring

SECTION II			TM9-2320-302-24P			
(1)	(2)	(3)	(4)	(5)	(6)	(7)
ITEM NO	SMR CODE	NSN	CAGEC	PART NUMBER	DESCRIPTION AND USABLE ON CODES(UOC)	QTY
					GROUP 0607 INSTRUMENT OR ENGINE CONTROL PANEL	
					FIG. 72 ENGINE CHECK SWITCH AND CAB AIR JUNCTION BLOCK WIRING	
1	PAOZZ	5930014386328	77326	24-405	SWITCH,ROTARY.....	1
2	PAOZZ	5310008094058	96906	MS27183-10	WASHER,FLAT.....	1
3	PAOZZ		64678	23-11164-720	SCREW,MACHINE 1/4-20 X 2.0", TORX HEAD.....	1
4	PAOZZ	5340013366663	64678	12-09068-006	STRAP,RETAINING.....	1
5	PAOZZ	5365013367656	64678	18-24685-000	SPACER,SLEEVE.....	1

END OF FIGURE

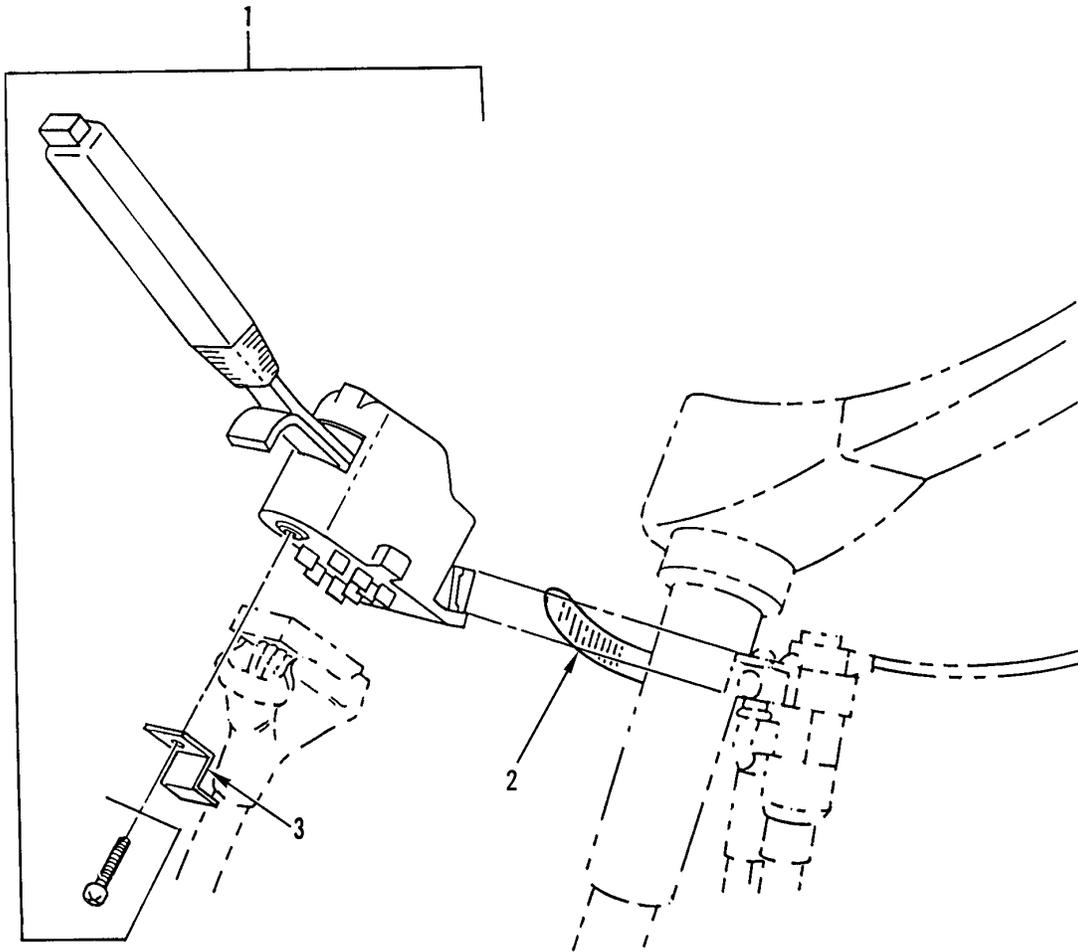

342-1324

Figure 73. Turn Signal Switch

SECTION II			TM9-2320-302-24P			
(1)	(2)	(3)	(4)	(5)	(6)	(7)
ITEM	SMR			PART		
NO	CODE	NSN	CAGEC	NUMBER	DESCRIPTION AND USABLE ON CODES(UOC)	QTY
					GROUP 0607 INSTRUMENT OR ENGINE CONTROL PANEL	
					FIG. 73 TURN SIGNAL SWITCH	
1	PAOZZ	6220013571883	64678	01-4811-77	CONTROL,DIRECTIONAL.....	1
2	PAOZZ	4730014073710	7Z588	62028	CLAMP,HOSE.....	1
3	PFOZZ	5340013555416	64678	06-19807-000	BRACKET,DOUBLE ANGL.....	1

END OF FIGURE

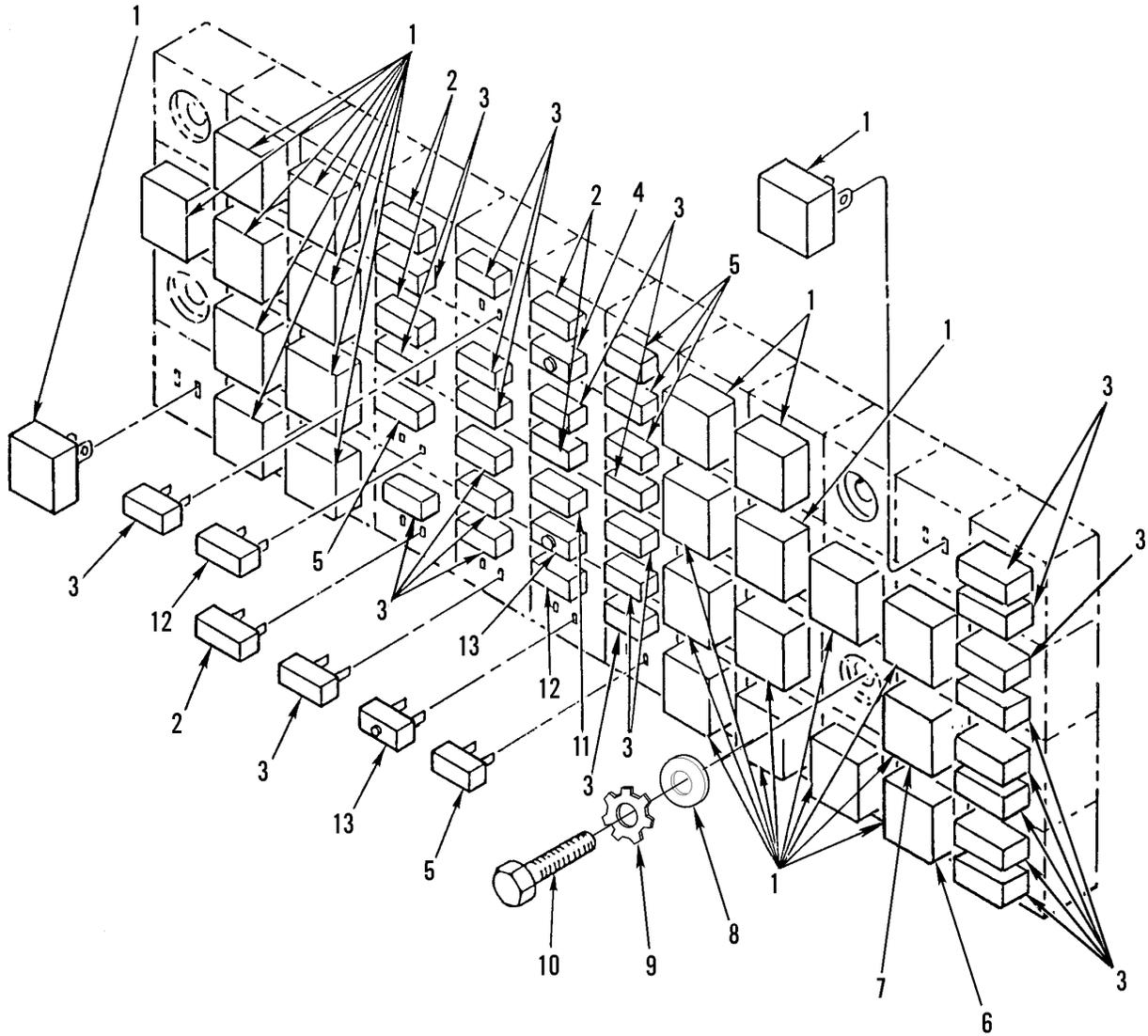

342-1495

Figure 74. Fuse, Relay, and Circuit Breaker Panel

SECTION II			TM9-2320-302-24P			
(1)	(2)	(3)	(4)	(5)	(6)	(7)
ITEM	SMR			PART		
NO	CODE	NSN	CAGEC	NUMBER	DESCRIPTION AND USABLE ON CODES(UOC)	QTY
GROUP 0608 MISCELLANEOUS ITEMS						
FIG. 74 FUSE, RELAY, AND CIRCUIT BREAKER PANEL						
1	PAOZZ	5945010956280	53867	0332-204-101	RELAY,ELECTROMAGNET.....	24
2	PAOZZ	5920011496953	11862	12004010	FUSE,INCLOSED LINK 25 AMP.....	5
3	PAOZZ	5920011496952	75915	257 015	FUSE,INCLOSED LINK 15 AMP.....	24
4	PAOZZ	5925014785959	11873	22315-000	CIRCUIT BREAKER 15 AMP (BLACKOUT LIGHTS).....	1
5	PAOZZ	5920011235211	75915	257 010	FUSE,INCLOSED LINK 10 AMP.....	1
6	XDOZZ		62380	15757A	RELAY,ELECTROMAGNET.....	1
7	XDOZZ		62380	15752A	RELAY,ELECTROMAGNET.....	1
8	PAOZZ	5310008094058	96906	MS27183-10	WASHER,FLAT .281 ID X .625 OD X .065 THK.....	6
9	PAOZZ	5310012519276	96906	MS51414-4	WASHER,LOCK EXT 1/4 IN SAE.....	4
10	PAOZZ	5306011757558	80204	B1821BH025C075L	BOLT,MACHINE 1/4-20 X .75.....	8
11	PAOZZ	5920010850825	11862	12004009	FUSE,INCLOSED LINK 20 AMP.....	1
12	PAOZZ	5920011886294	58536	AA55569/01-011	FUSE,INCLOSED LINK 30 AMP.....	2
13	PAOZZ	5925013361734	11873	17425-4E09F3	CIRCUIT BREAKER 25 AMP.....	2

END OF FIGURE

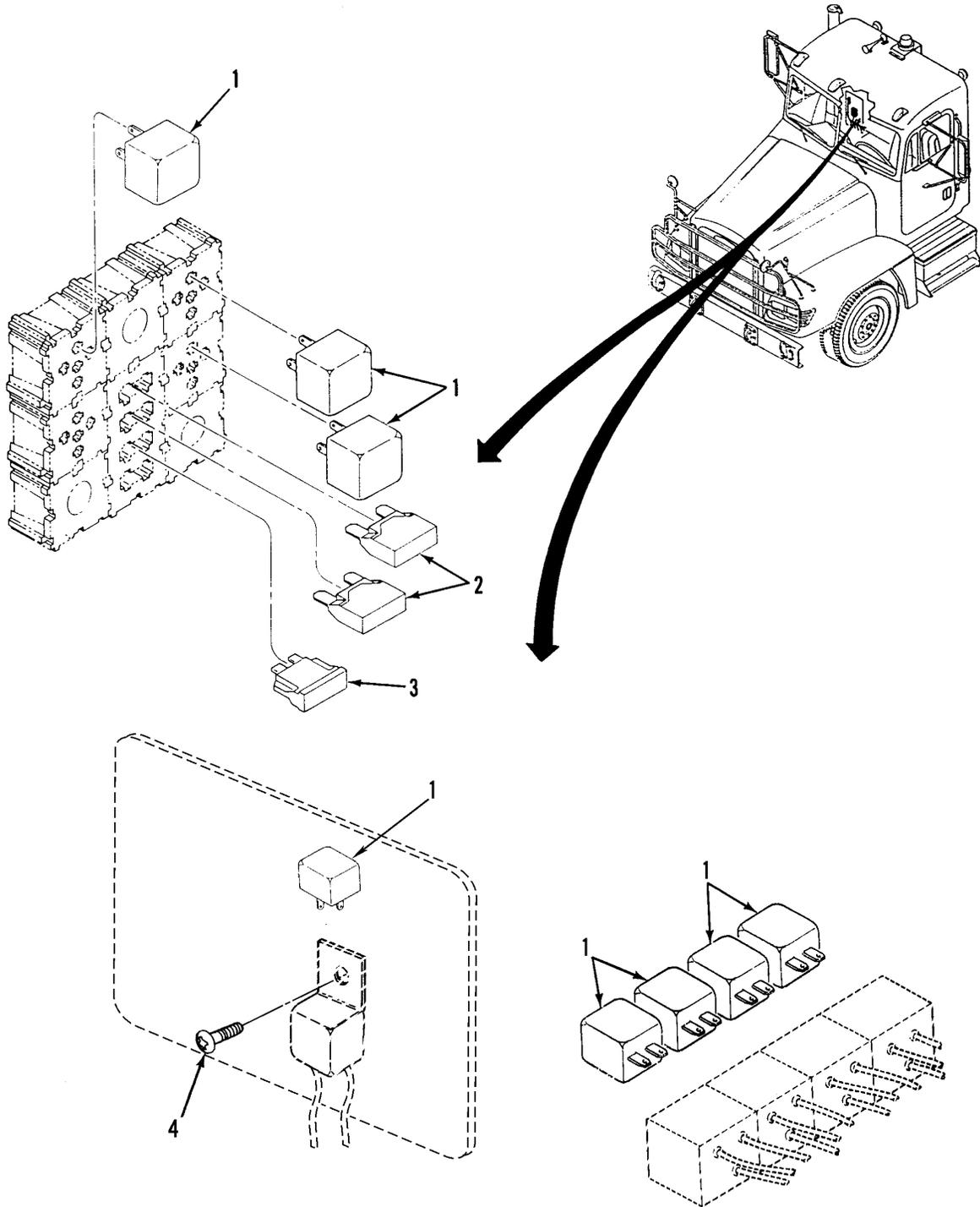

Figure 75. ABS ECU Harness Fuses, Relays and Circuit Breakers

SECTION II			TM9-2320-302-24P			
(1)	(2)	(3)	(4)	(5)	(6)	(7)
ITEM	SMR			PART		
NO	CODE	NSN	CAGEC	NUMBER	DESCRIPTION AND USABLE ON CODES(UOC)	QTY
GROUP 0608 MISCELLANEOUS ITEMS						
FIG. 75 ABS ECU HARNESS FUSES, RELAYS AND CIRCUIT BREAKERS						
1	PAOZZ	5945010956280	53867	0332-204-101	RELAY,ELECTROMAGNET.....	8
2	PAOZZ	5925013479837	11873	19115-01M	CIRCUIT BREAKER.....	2
3	PAOZZ	5920011235212	75915	257 005	FUSE,INCLOSED LINK.....	1
4	PFOZZ	5305013369466	64678	23-11657-305	SCREW,TAPPING.....	1

END OF FIGURE

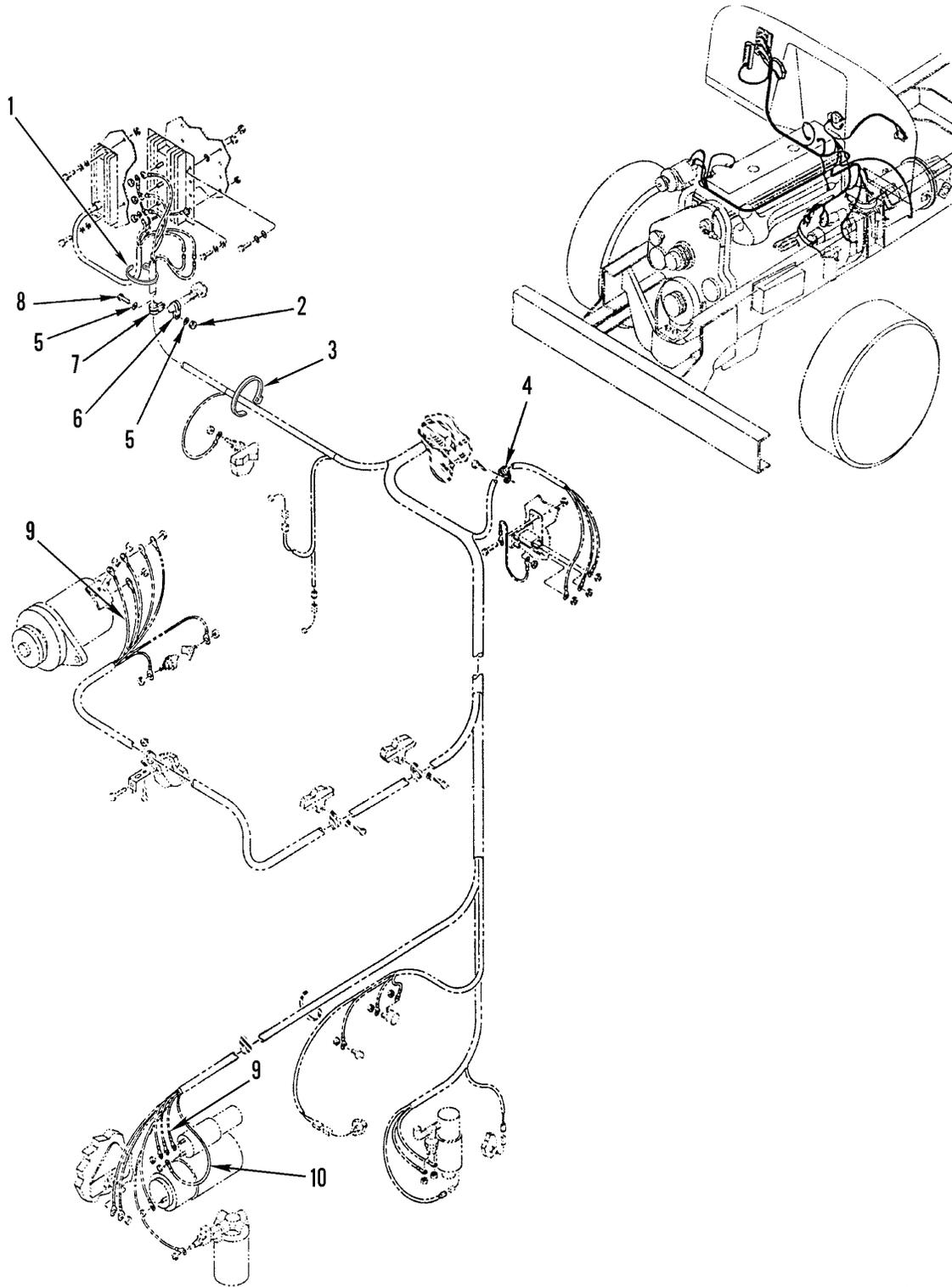
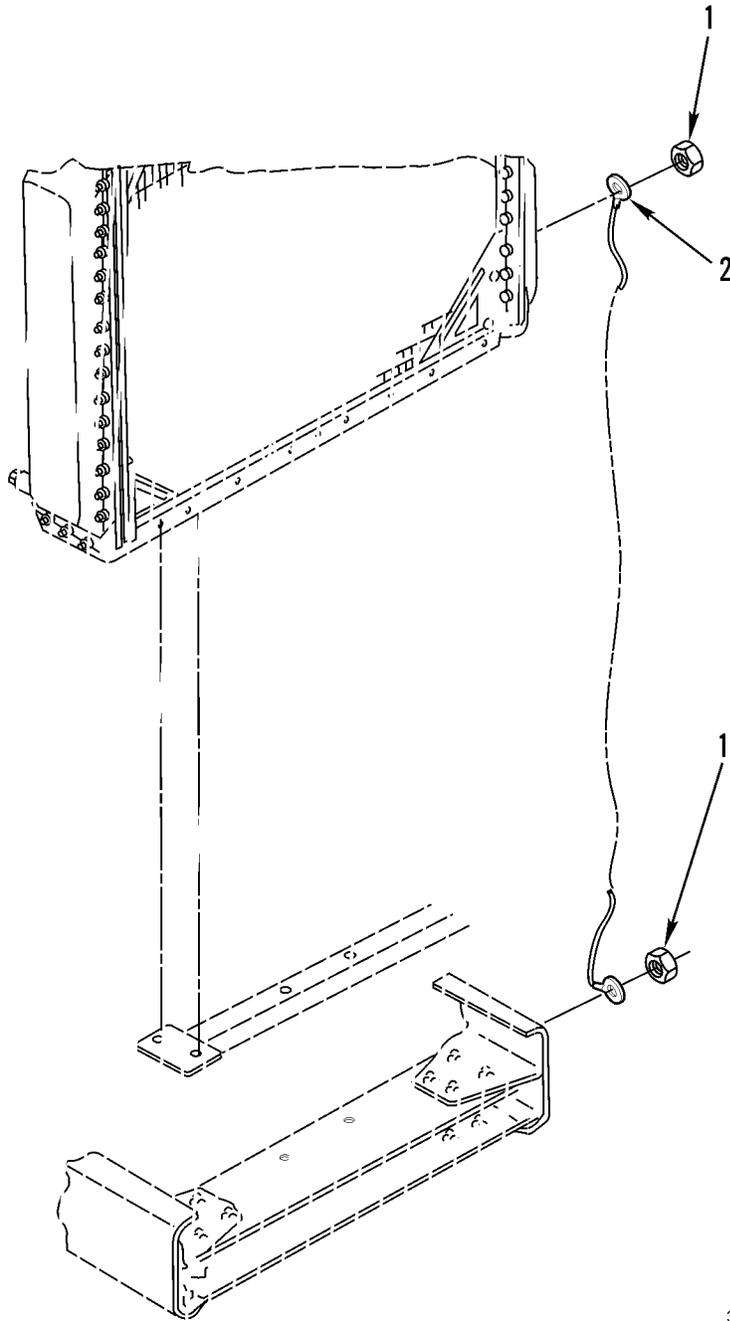

Figure 76. Engine Wiring Harness Mounting Hardware

SECTION II			TM9-2320-302-24P			
(1)	(2)	(3)	(4)	(5)	(6)	(7)
ITEM	SMR			PART		
NO	CODE	NSN	CAGEC	NUMBER	DESCRIPTION AND USABLE ON CODES(UOC)	QTY
GROUP 0608 MISCELLANEOUS ITEMS						
FIG. 76 ENGINE WIRING HARNESS MOUNTING HARDWARE						
1	PAOZZ	5975013554570	16956	08-404	STRAP,TIEDOWN,ELECT.....	4
2	PAOZZ	5310000881251	81349	M45913/1-4CG5C	NUT,SELF LOCKING,HE 1/4-20UNC.....	1
3	PAOZZ	5975013389190	16956	08-402	STRAP,TIEDOWN,ELECT.....	2
4	PAOZZ	5340013394266	64678	23-11358-024	CLAMP,LOOP 7/8 IN, 2 TUBES.....	1
5	PAOZZ	5310008094058	96906	MS27183-10	WASHER,FLAT .281 ID X .625 OD X.065 THK.....	2
6	PAOZZ	5340007645231	01276	900729-4	CLAMP,LOOP.....	1
7	PAOZZ	5340013397022	18076	S463-G18	CLAMP,LOOP.....	1
8	PAOZZ	5306012443973	64678	000933010016	BOLT,MACHINE M10-1.25 X 20MM.....	2
9	XDOZZ		64678	A06-33246-104	CABLE ASSEMBLY.....	1
10	XDOZZ		64678	A06-33247-098	CABLE ASSEMBLY.....	1

END OF FIGURE



342-1504

Figure 77. Chassis Wiring Harness Mounting Hardware

SECTION II			TM9-2320-302-24P			
(1)	(2)	(3)	(4)	(5)	(6)	(7)
ITEM	SMR			PART		
NO	CODE	NSN	CAGEC	NUMBER	DESCRIPTION AND USABLE ON CODES(UOC)	QTY
					GROUP 0608 MISCELLANEOUS ITEMS	
					FIG. 77 CHASSIS WIRING HARNESS MOUNTING HARDWARE	
1	PAOZZ	5310000881251	81349	M45913/1-4CG5C	NUT, SELF LOCKING, HE.....	2
2	PAOZZ	5999013383808	64678	A06-09664-003	STRIP, ELECTRICAL GR.....	1

END OF FIGURE

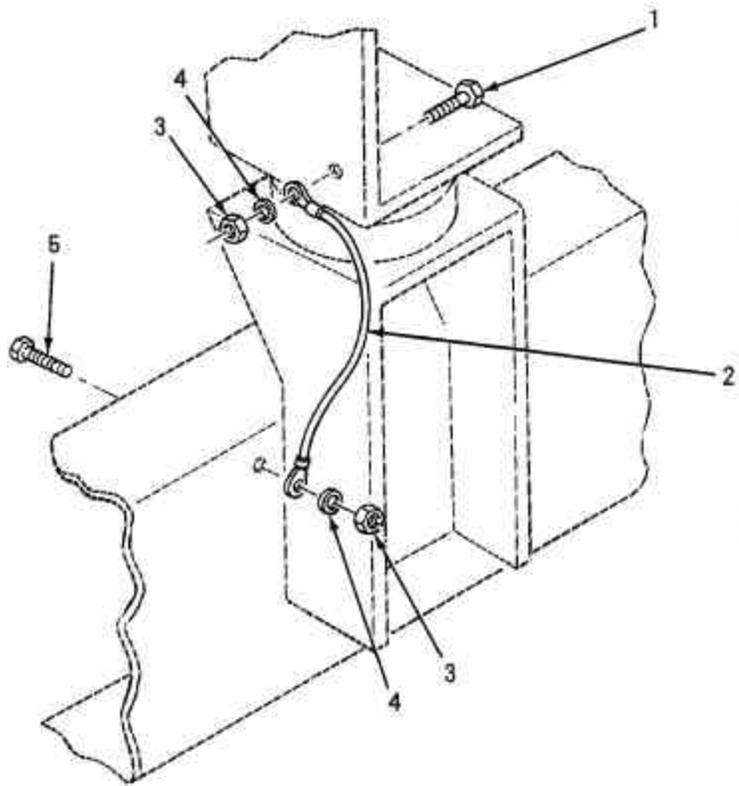

342-1325

Figure 78. Cab to Frame Grounding Wire

SECTION II			TM9-2320-302-24P			
(1)	(2)	(3)	(4)	(5)	(6)	(7)
ITEM	SMR			PART		
NO	CODE	NSN	CAGEC	NUMBER	DESCRIPTION AND USABLE ON CODES(UOC)	QTY
GROUP 0608 MISCELLANEOUS ITEMS						
FIG. 78 CAB TO FRAME GROUNDING WIRE						
1	PAOZZ	5305011373938	96906	MS51871-3	SCREW,TAPPING 1/4 X 3/4.....	1
2	PAOZZ	6150013366489	64678	A06-09547-005	LEAD,ELECTRICAL.....	1
3	PAOZZ	5310000881251	81349	M45913/1-4CG5C	NUT,SELF LOCKING,HE 1/4-20UNC.....	3
4	PAOZZ	5310008094058	96906	MS27183-10	WASHER,FLAT .281 ID X .625 OD X .06 THK.....	2
5	PAOZZ	5305002253843	80204	B1821BH025C100N	SCREW,CAP,HEXAGON H 1/4-20UNC X 1.00.....	1

END OF FIGURE

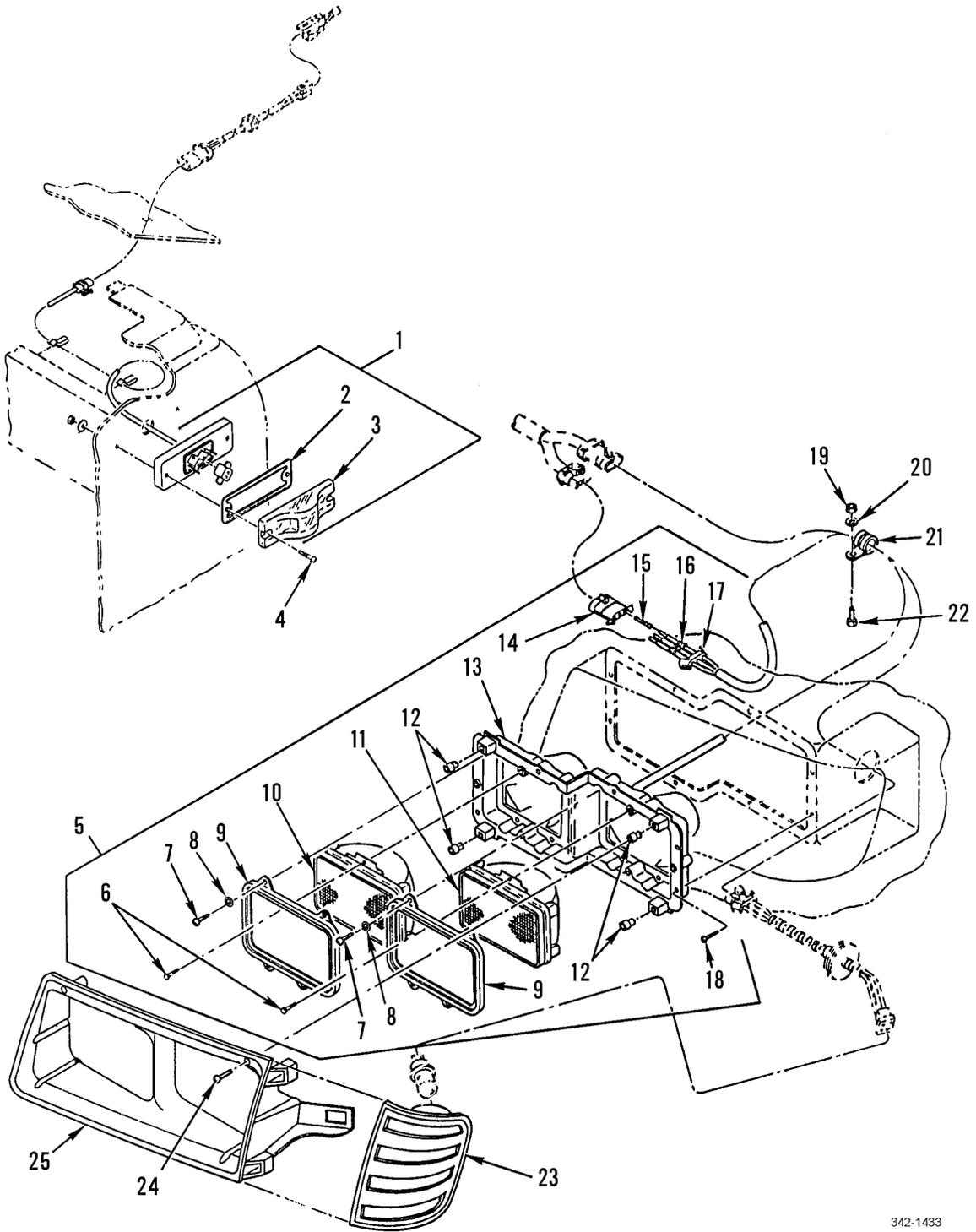
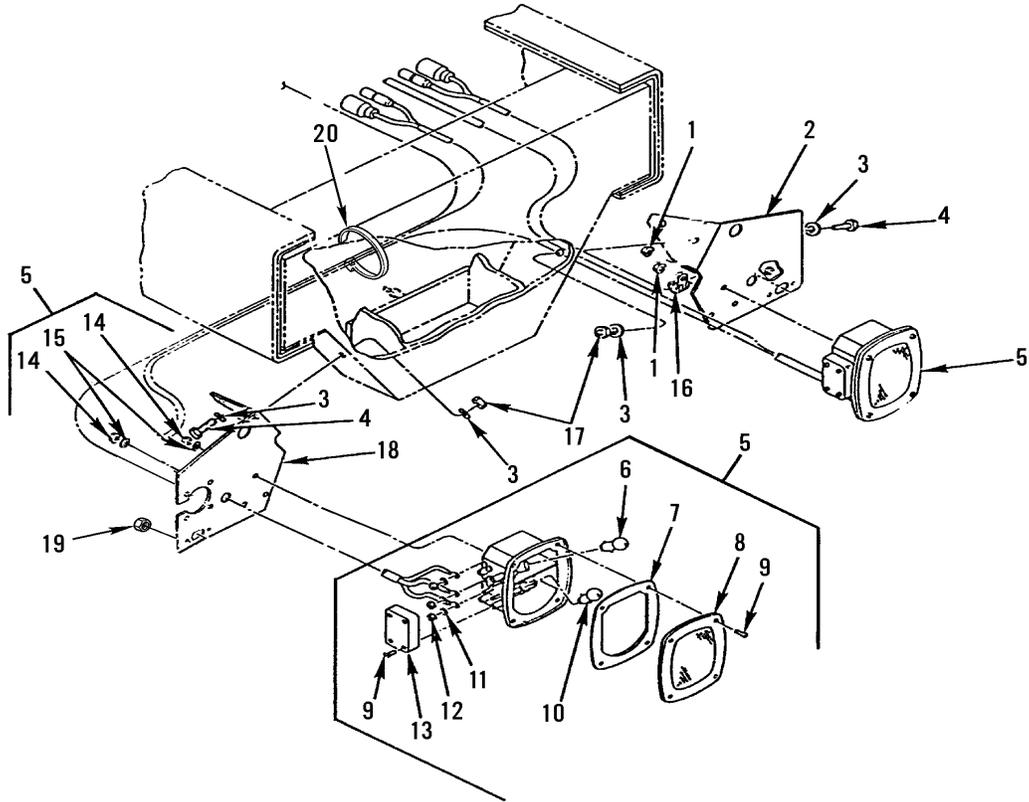

Figure 79. Headlamp and Turn Signal

SECTION II			TM9-2320-302-24P			
(1)	(2)	(3)	(4)	(5)	(6)	(7)
ITEM NO	SMR CODE	NSN	CAGEC	PART NUMBER	DESCRIPTION AND USABLE ON CODES(UOC)	QTY
GROUP 0609 LIGHTS						
FIG. 79 HEADLAMP AND TURN SIGNAL						
1	PAOZZ		64678	9700 005	DIRECTIONAL LIGHT,V SEALED UNIT....	2
2	PAOZZ	5330013366720	81834	61-2078-03	.GASKET.....	1
3	PAOZZ	6220013391192	81834	01-9213-32	.LENS,LIGHT.....	1
4	PAOZZ	5305013366238	64678	23-11609-100	SCREW,MACHINE.....	4
5	PAOOO	6220013579487	64678	A06-15605-007	HEADLIGHT RH.....	1
5	PAOOO	6220013389504	64678	A06-15605-006	HEADLIGHT LH.....	1
6	PAOZZ	5305013598904	81834	23-0136-11	.SCREW,TAPPING.....	2
7	PAOZZ	5305013332822	93907	224-60610	.SCREW,TAPPING 10-14.....	16
8	PAOZZ	5310008094058	96906	MS27183-10	.WASHER,FLAT .281 ID X .625 OD X .065 THK.....	8
9	PAOZZ	6220013573672	75175	42127-001	.RETAINER,LENS.....	2
10	PAOZZ	6240012032106	08805	H4651	.LAMP,INCANDESCENT.....	1
11	PAOZZ	6240013413770	56962	H4739	.LAMP,INCANDESCENT.....	1
12	XDOZZ		02768	212-180602-13	.GROMMET,PLASTIC.....	4
13	XDOZZ		81834	01-6496-74	.BUCKET,HDLAMP,DUAL.....	1
14	PAOZZ	5935013383533	64678	1204 5696	.CONNECTOR BODY,PLUG.....	1
15	PAOZZ	5999013370088	77060	1206 4735	.CONTACT,ELECTRICAL.....	3
16	PAOZZ	5930013365334	77060	12052387	.BOOT,DUST AND MOIST.....	1
17	PAOZZ	5970013441070	77060	1204 5699	.INSULATOR ASSEMBLY.....	1
18	PAOZZ	5305013586668	81834	23-0133-38	.SCREW,TAPPING.....	8
19	PAOZZ	5310014789014	64678	23-11488-110	NUT,SELF-LOCKING HE 10-24 UNC, 3/8 OD WASHER.....	4
20	PAOZZ	5310014788676	64678	23-10900-010	WASHER,FLAT NO 10.....	4
21	PAOZZ	5340006649056	96906	MS21919WG6	CLAMP,LOOP.....	1
22	XDOZZ		64678	23-11609-714	SCREW 10-24 X 1.50 (TORX HEAD).....	4
23	PAOZZ	6220013395102	64678	A06-17139-000	DIRECTIONAL LIGHT,V LEFT.....	1
23	PAOZZ	6220013382055	64678	A06-17139-001	DIRECTIONAL LIGHT,V RIGHT.....	1
24	XDOZZ		64678	23-11623-710	SCREW 10-16 X 1.0 (TORX HEAD).....	8
25	PFOZZ	2590013386044	64678	06-18126-000	MOLDING,METAL LEFT.....	1
25	PFOZZ	6220013385928	64678	06-18126-001	HOUSING,LIGHT RIGHT.....	1

END OF FIGURE



342-1434

Figure 80. Taillights

SECTION II			TM9-2320-302-24P			
(1)	(2)	(3)	(4)	(5)	(6)	(7)
ITEM NO	SMR CODE	NSN	CAGEC	PART NUMBER	DESCRIPTION AND USABLE ON CODES(UOC)	QTY
GROUP 0609 LIGHTS						
FIG. 80 TAILLIGHTS						
1	PAOZZ	5310013336436	64678	23-10340-125	NUT, SELF-LOCKING, AS 1/4-20.....	10
2	PFOZZ	6220013385993	64678	06-18043-001	BRACKET, LIGHT RETEN RIGHT.....	1
3	PAOZZ	5310008093079	96906	MS27183-19	WASHER, FLAT.....	4
4	PAOZZ	5305000712069	80204	B1821BH050C150N	SCREW, CAP, HEXAGON H 1/2-13UNC-2A X 1.500.....	4
5	PAOOO	6220014408056	64678	01-5371-78	LAMP UNIT, VEHICULAR LEFT.....	1
5	PAOOO	6220014408065	81834	01-5377-71	LAMP UNIT, VEHICULAR RIGHT.....	1
6	PAOZZ	6240009247526	08806	1156	.LAMP, INCANDESCENT.....	1
7	PAOZZ	5330011545214	81834	61-2037-03	.GASKET.....	1
8	PAOZZ	6220010952616	12662	445-25	.LENS, LIGHT.....	1
9	KFOZZ		81834	23-0133-36	.SCREW, TAPPING NO. 8-18 X 5/8 PHILLIPS SS PART OF KIT P/N 79-9007-06.....	4
10	PAOZZ	6240008891799	08108	1157	.LAMP, INCANDESCENT.....	1
11	KFOZZ		81834	23-0172-02	.LOCKWASHER 1/4 SPLIT ZINC PLT USS PART OF KIT P/N 79-9007-06.....	4
12	KFOZZ		81834	23-0104-02	.NUT, HEX PART OF KIT P/N 79-9007-06.	4
13	KFOZZ		81834	10-7103-03	.COVER, SIDE PART OF KIT P/N 79-9007-06.....	1
14	KFOZZ		81834	23-0106-06	.NUT, HEX PART OF KIT P/N 79-9007-06.	3
15	KFOZZ		81834	23-0171-02	.LOCKWASHER 1/4 SPLIT ZINC PLT USS PART OF KIT P/N 79-9007-06.....	3
16	PAOZZ	5340013342880	18076	S630-G14	CLAMP, LOOP.....	2
17	PAOZZ	5310002256993	96906	MS51922-33	NUT, SELF-LOCKING, HE 1/2-13UNC.....	4
18	PFOZZ	6220013385992	64678	06-18043-000	BRACKET, LIGHT RETEN.....	1
19	PAOZZ	5310011263664	64678	23-10340-108	NUT, PLAIN, ASSEMBLED 8-32.....	4
20	PAOZZ	5975009441499	96906	MS3368-1-9A	STRAP, TIEDOWN, ELECT.....	5

END OF FIGURE

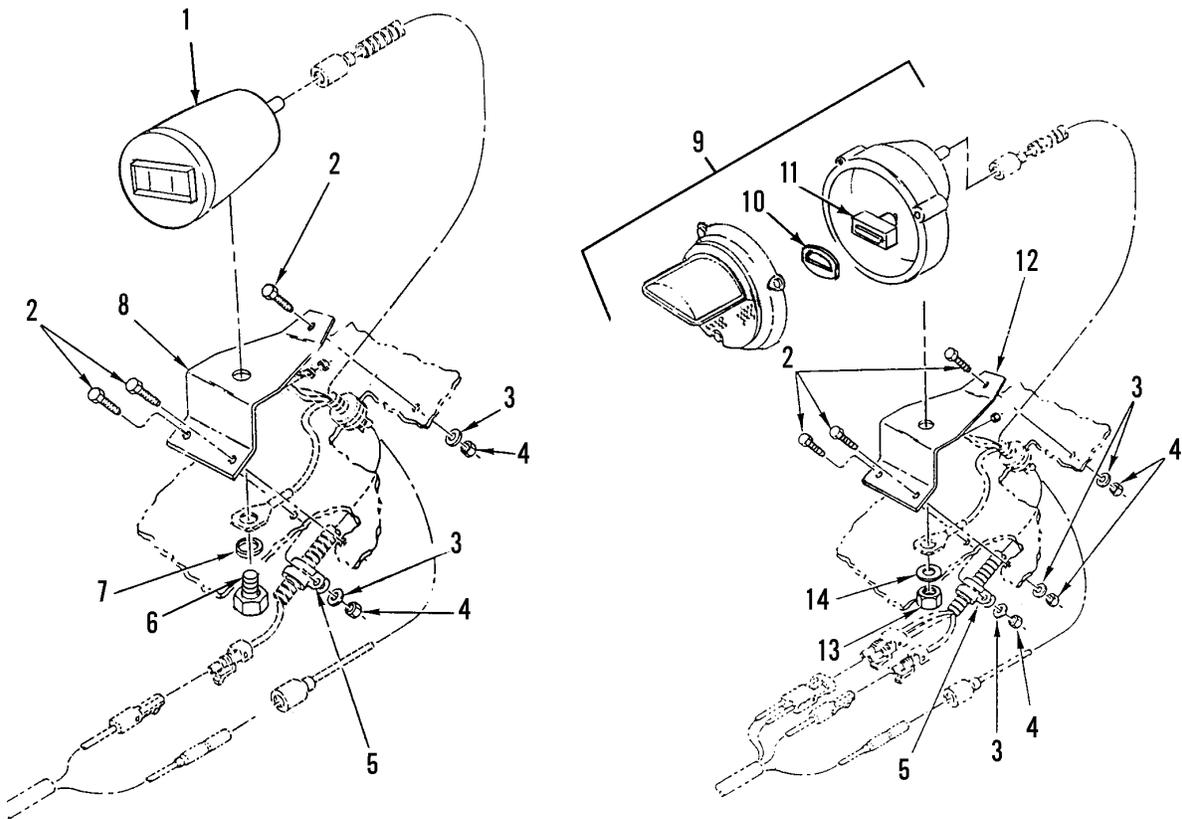

342-1415

Figure 81. Blackout and Marker Lights

SECTION II			TM9-2320-302-24P			
(1)	(2)	(3)	(4)	(5)	(6)	(7)
ITEM	SMR			PART		
NO	CODE	NSN	CAGEC	NUMBER	DESCRIPTION AND USABLE ON CODES(UOC)	QTY
GROUP 0609 LIGHTS						
FIG. 81 BLACKOUT AND MARKER LIGHTS						
1	PAOZZ	6220014113686	5A910	AC-12261	LIGHT, BLACKOUT NEW.....	2
2	PAOZZ	5305002253843	80204	B1821BH025C100N	SCREW, CAP, HEXAGON H 1/4-20UNC-2A X 1.000 NEW.....	9
3	PAOZZ	5310008094058	96906	MS27183-10	WASHER, FLAT .281 ID X .625 OD X .06 THK.....	9
4	PAOZZ	5310000881251	81349	M45913/1-4CG5C	NUT, SELF LOCKING, HE 1/4-20UNC.....	9
5	PAOZZ	5340006164018	01276	900729-1	CLAMP, LOOP.....	2
6	PAOZZ	5305014113449	64678	23-10745-050	SCREW, CAP, HEXAGON H.....	2
7	PAOZZ	5310009746623	96906	MS35338-140	WASHER, LOCK.....	2
8	PFOZZ	5340014107065	64678	06-20072-001	BRACKET, MOUNTING NEW RH.....	1
9	PAOZZ	6220014463528	5A910	12468579-1-383G	HEADLIGHT.....	1
10	PAOZZ	5330014464690	19207	12468576	.GASKET.....	1
11	PAOZZ	6220014459920	19207	12468578-1	.LIGHT, BLACKOUT.....	1
12	PFOZZ	5340014113823	64678	06-20072-000	BRACKET, MOUNTING.....	2
13	PAOZZ	5310007320558	96906	MS51967-8	NUT, PLAIN, HEXAGON 3/8-16UNC.....	1
14	PAOZZ	5310000045033	62793	104J005-29	WASHER, LOCK NO. 8 NOM SIZE.....	1

END OF FIGURE

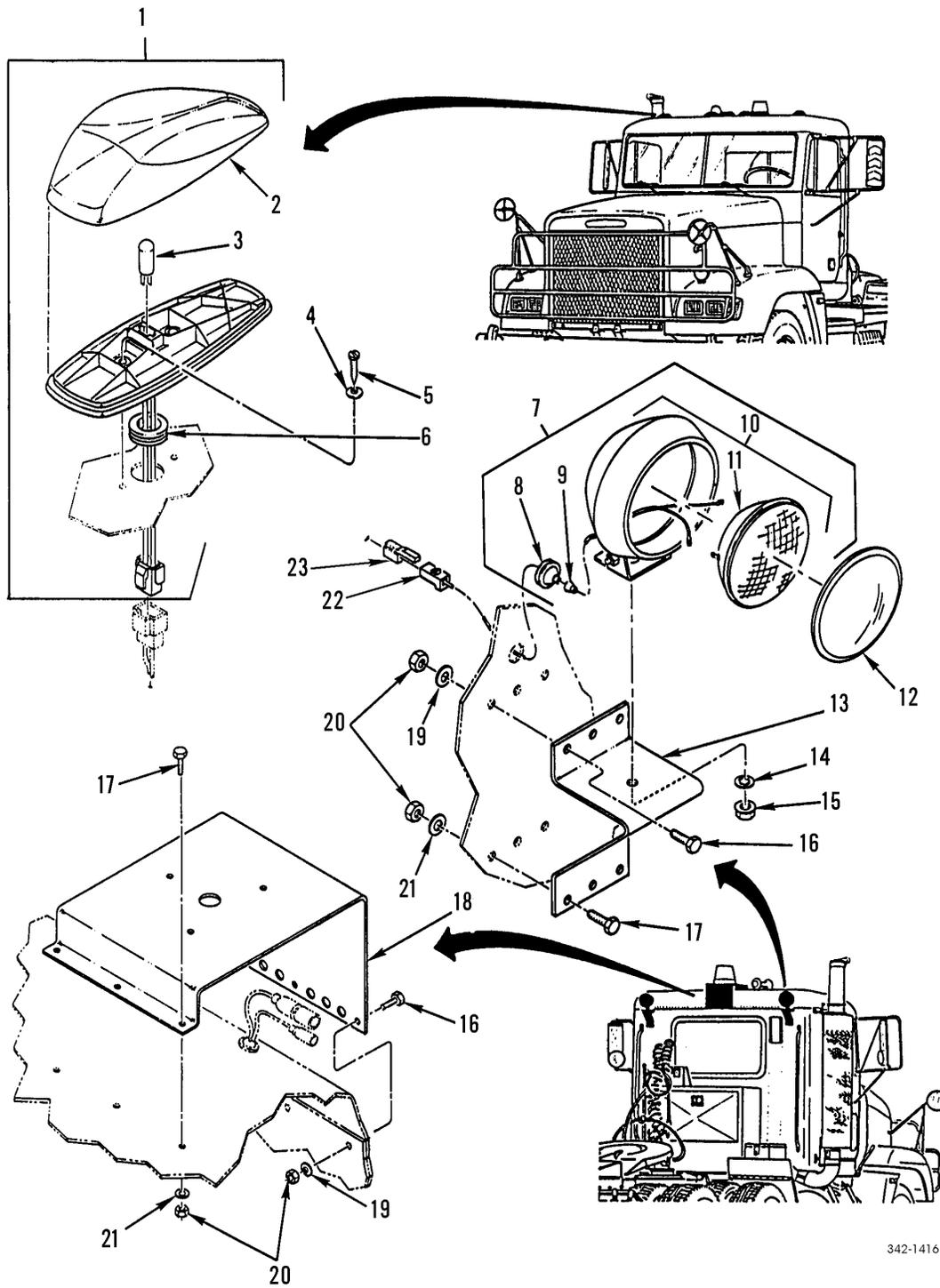

342-1416

Figure 82. Clearance Light, Utility Light and Beacon Bracket

SECTION II			TM9-2320-302-24P			
(1)	(2)	(3)	(4)	(5)	(6)	(7)
ITEM	SMR			PART		
NO	CODE	NSN	CAGEC	NUMBER	DESCRIPTION AND USABLE ON CODES(UOC)	QTY
GROUP 0609 LIGHTS						
FIG. 82 CLEARANCE LIGHT, UTILITY LIGHT AND BEACON BRACKET						
1	PAOOO	6220013396015	64678	A06-14973-000	LAMP UNIT,VEHICULAR.....	5
2	PAOZZ	6220013391193	81834	01-9218-70	.LENS,LIGHT.....	1
3	PAOZZ	6240000692640	08108	193	.LAMP,INCANDESCENT.....	1
4	PAOZZ	5310000145850	96906	MS27183-42	WASHER,FLAT .219 ID X .500 OD X .049 THK.....	2
5	XDOZZ		64678	23-11610-710	SCREW,MACHINE CROSS 10-32 UNF.....	2
6	PAOZZ	5325002766056	70485	2566	GROMMET,NONMETALLIC CENTER CLEARANCE LIGHT.....	1
7	PAOOO	6220013385773	64678	A06-18260-000	LIGHT,UTILITY,VEHIC.....	2
8	PAOZZ	5325013344808	64678	23-11185-000	.GROMMET,NONMETALLIC TAPERED NECK..	1
9	XDOZZ		98688	2486 7022	.GROMMET,NONMETALLIC.....	1
10	PAOZZ	6220012243042	81834	64931-5	.HEADLIGHT.....	1
11	PAOZZ	6240008362079	70418	27035	.LAMP,INCANDESCENT.....	1
12	PAOZZ	6220013389050	13548	99120C	LENS,LIGHT.....	2
13	PFOZZ	5340013366447	64678	E06-13353-000	BRACKET,MULTIPLE AN.....	2
14	PAOZZ	5310005503503	96906	MS35335-36	WASHER,LOCK.....	2
15	PAOZZ	5310011511036	45152	115307A	NUT,SELF-LOCKING,EX.....	2
16	PAOZZ	5305002253843	80204	B1821BH025C100N	SCREW,CAP,HEXAGON H 1/4-20UNC-2A X 1.000.....	3
17	PAOZZ	5305000680502	96906	MS90725-6	SCREW,CAP,HEXAGON H 1/4-20 UNC X .750.....	3
18	XDOZZ		64678	06-18305-001	BRACKET,MULTIPLE AN.....	1
19	PAOZZ	5310008094058	96906	MS27183-10	WASHER,FLAT .281 ID X .625 OD X .065 THK.....	3
20	PAOZZ	5310000881251	81349	M45913/1-4CG5C	NUT,SELF LOCKING,HE.....	12
21	PAOZZ	5310013545785	64678	23-9426-203	WASHER,FLAT 1/4 ID X 1.00 OD X .072 THK.....	3
22	PAOZZ	5940007881586	77060	2965142	TERMINAL,QUICK DISC.....	1
23	PAOZZ	5935010657984	77060	2977253	CONNECTOR,PLUG,ELEC.....	1

END OF FIGURE

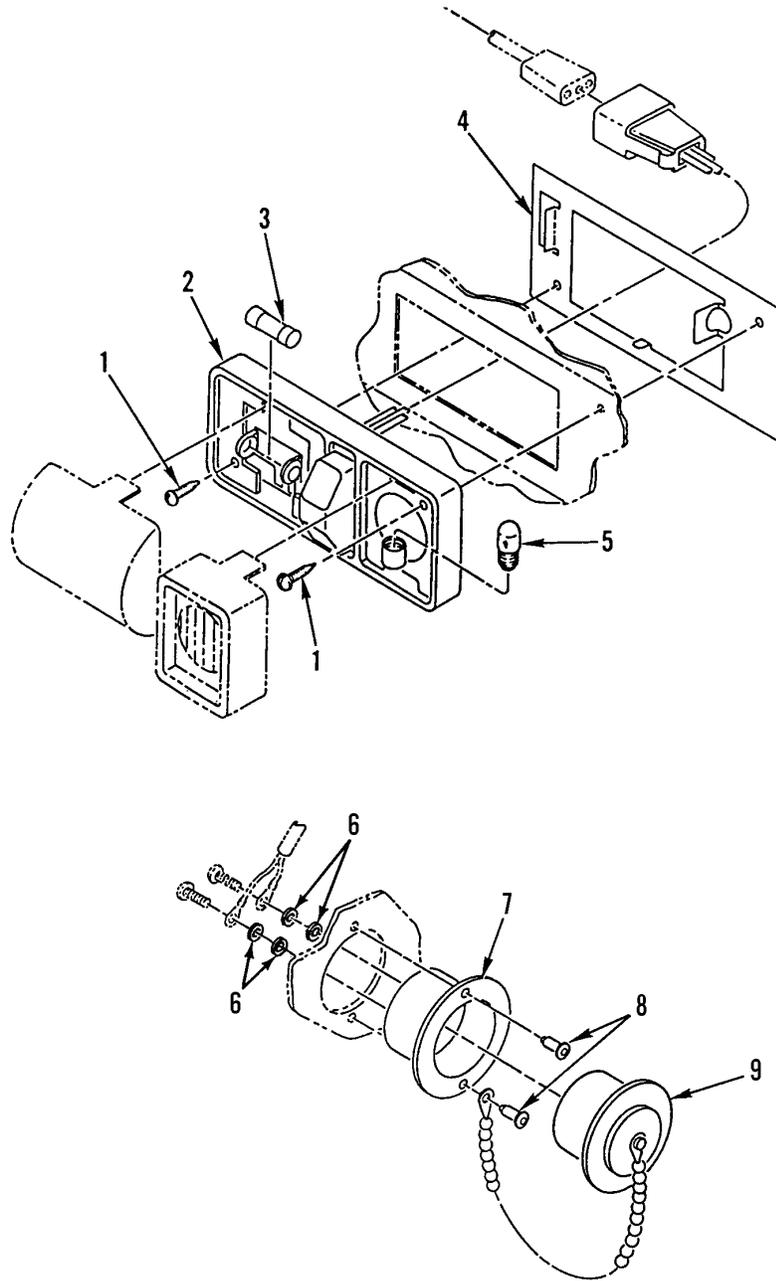

342-1417

Figure 83. Interior Light and Utility Power

SECTION II			TM9-2320-302-24P			
(1)	(2)	(3)	(4)	(5)	(6)	(7)
ITEM NO	SMR CODE	NSN	CAGEC	PART NUMBER	DESCRIPTION AND USABLE ON CODES(UOC)	QTY
GROUP 0609 LIGHTS						
FIG. 83 INTERIOR LIGHT AND UTILITY POWER						
1	PAOZZ	5305013373805	64678	23-10899-075	SCREW,TAPPING 10-16 X 3/4, PAN HEAD, CROSS RECESS.....	4
2	PAOZZ	6220013382057	64678	A22-30594-000	LAMP UNIT,VEHICULAR WITH BULBS.....	2
3	PAOZZ	6240010932131	08108	561	LAMP,INCANDESCENT.....	1
4	XDOZZ		64678	22-30934-000	BRACKET,LAMP.....	2
5	PAOZZ	6240001557949	88044	AN3121-1816	LAMP,INCANDESCENT.....	1
6	PAOZZ	5310009338118	96906	MS35338-135	WASHER,LOCK #8.....	4
7	PFOZZ	5935006446750	74545	7467	SOCKET,PLUG-IN ELEC.....	2
8	PAOZZ	5320010321043	56563	101624-01	RIVET,BLIND.....	4
9	PFOZZ	5935011544586	74545	4890	COVER,ELECTRICAL CO.....	2

END OF FIGURE

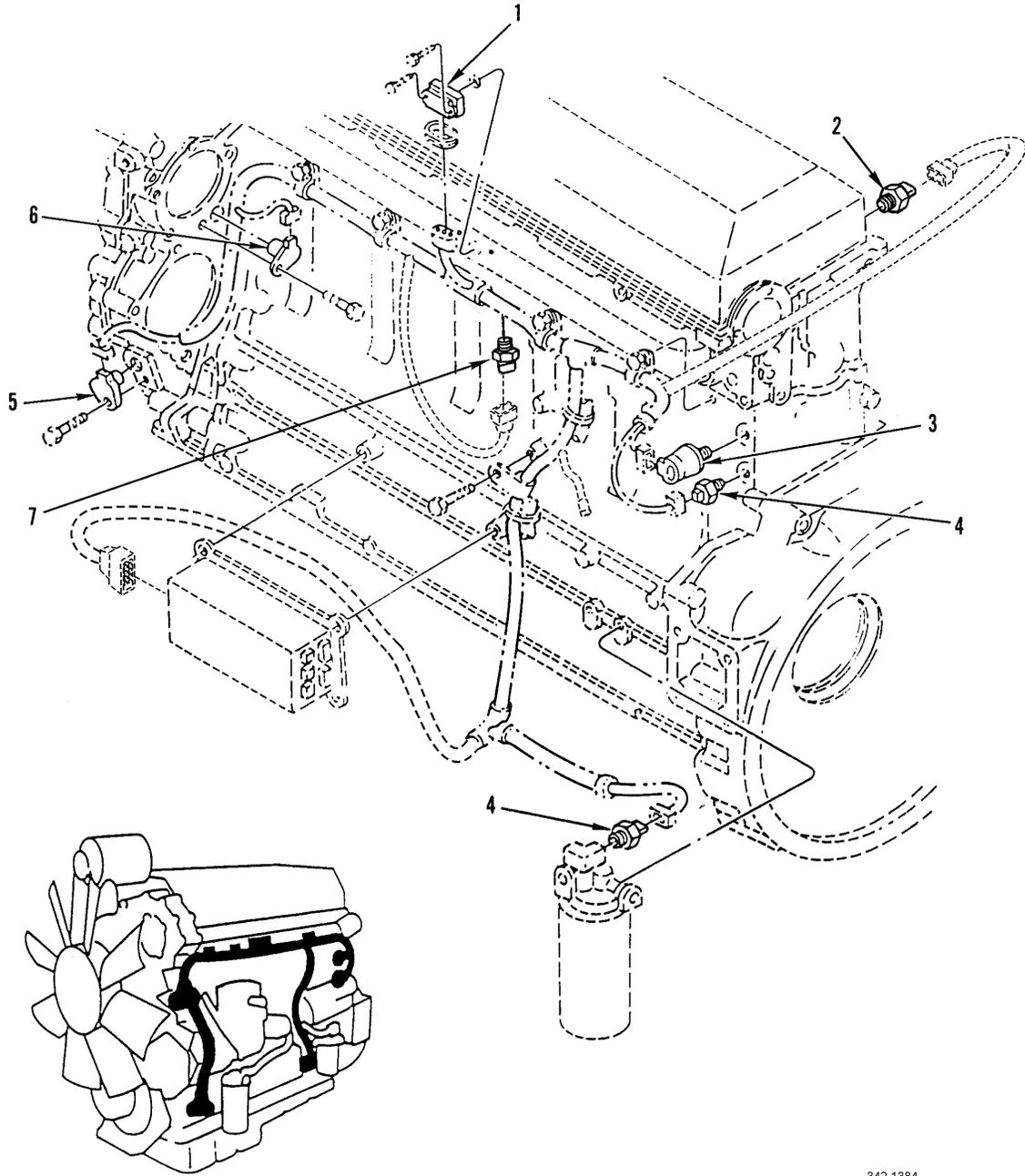

342-1384

Figure 84. Electronic Control Module Sensors

SECTION II			TM9-2320-302-24P			
(1)	(2)	(3)	(4)	(5)	(6)	(7)
ITEM	SMR			PART		
NO	CODE	NSN	CAGEC	NUMBER	DESCRIPTION AND USABLE ON CODES(UOC)	QTY
GROUP 0610 SENDING UNITS AND WARNING SWITCHES						
FIG. 84 ELECTRONIC CONTROL MODULE SENSORS						
1	PAOZZ	2990013189754	72582	16070629	SENSOR,MANIFOLD ABS.....	1
2	PAOZZ	2990014152366	72582	23514708	SENSOR,ENGINE COOLA.....	1
3	PAOZZ	6620013617595	72582	23511176	TRANSMITTER,PRESSUR.....	1
4	PAOZZ	2990013374138	72582	23518092	SENSOR,ENGINE COOLA.....	2
5	PAOZZ	2990013200163	72582	8929388	SENSOR,TIMING.....	1
6	PAOZZ	2990013200162	72582	8929387	SENSOR,SYNCHRONIZE.....	1
7	PAOZZ	2990014131395	72582	23515250	SENSOR,ENGINE COOLA.....	1

END OF FIGURE

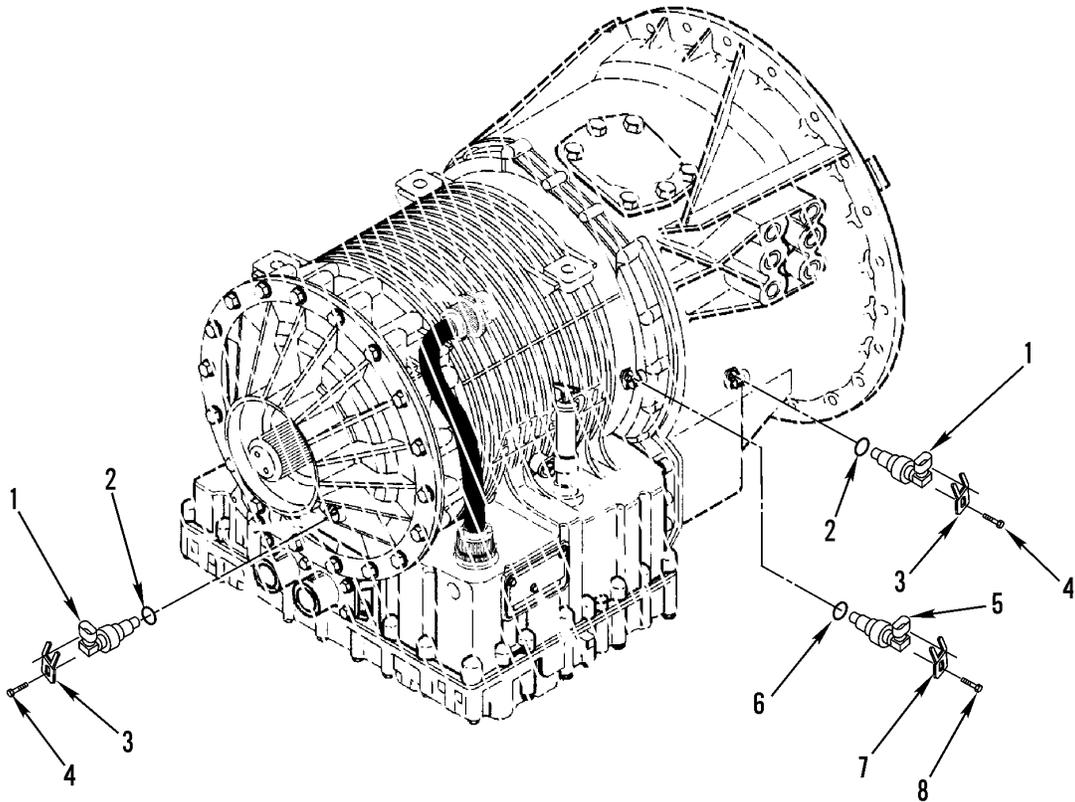

342-1418

Figure 85. Clutch Transmission Switch and SPST Switch

SECTION II			TM9-2320-302-24P			
(1)	(2)	(3)	(4)	(5)	(6)	(7)
ITEM	SMR			PART		
NO	CODE	NSN	CAGEC	NUMBER	DESCRIPTION AND USABLE ON CODES(UOC)	QTY
					GROUP 0610 SENDING UNITS AND WARNING SWITCHES	
					FIG. 85 CLUTCH TRANSMISSION SWITCH AND SPST SWITCH	
1	PAOZZ	6695013616056	73342	29509637	TRANSDUCER,MOTIONAL.....	2
2	PAOZZ	5331013606017	73342	29503383	.O-RING.....	1
3	PAOZZ	5340013601033	73342	29503843	.CLIP,SPRING TENSION.....	1
4	PAOZZ	5305011582041	34914	992 4051	SCREW,CAP,HEXAGON H.....	2
5	PAOZZ	2520014790012	73342	29512201	CONTROL ASSEMBLY,TR SPEED.....	1
6	PAOZZ	5331013606017	73342	29503383	.O-RING.....	1
7	XDOZZ		73342	29511508	.BRACKET,SPEED SENSO.....	1
8	PAOZZ	5305011582041	34914	992 4051	SCREW,CAP,HEXAGON H M8 X 1.25 X 20MM.....	1

END OF FIGURE

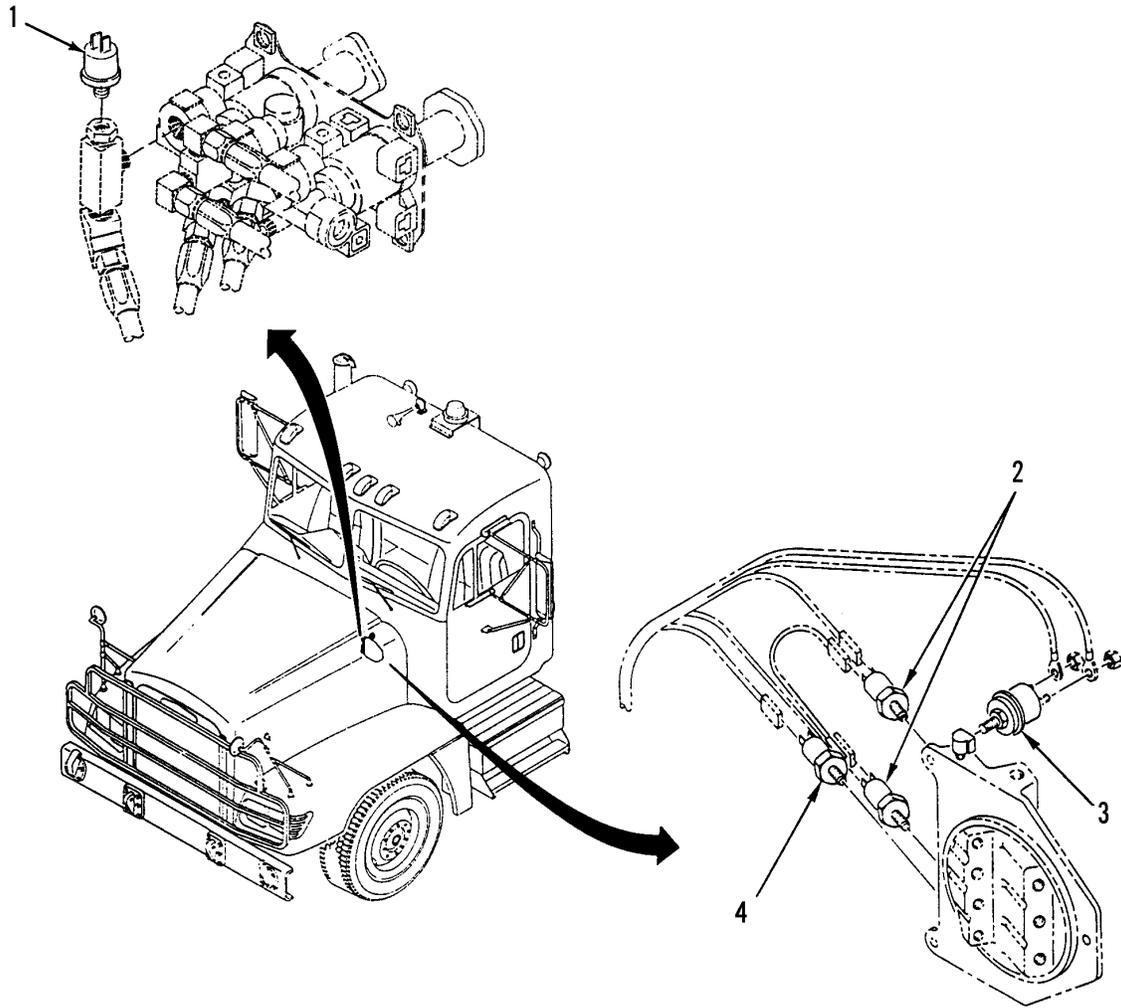

342-1500

Figure 86. RPM Pulse Sender, Fuel Pressure Sender, Switch, and Oil Pressure Switch

SECTION II			TM9-2320-302-24P			
(1)	(2)	(3)	(4)	(5)	(6)	(7)
ITEM	SMR			PART		
NO	CODE	NSN	CAGEC	NUMBER	DESCRIPTION AND USABLE ON CODES(UOC)	QTY
					GROUP 0610 SENDING UNITS AND WARNING SWITCHES	
					FIG. 86 RPM PULSE SENDER, FUEL PRESSURE SENDER, SWITCH AND OIL PRESSURE SWITCH	
1	PAOZZ	5930014421113	58723	2749-2108	SWITCH,PRESSURE PARKING BRAKE INDICATOR.....	1
2	PAOZZ	5930013382035	64678	681 153 04 14	SWITCH,PRESSURE.....	2
3	PAOZZ	2540013374105	06721	N-30255	SWITCH,STOPLIGHT,AU.....	1
4	PAOZZ	5930013365441	64678	681 545 11 24	SWITCH,PRESSURE OIL.....	1

END OF FIGURE

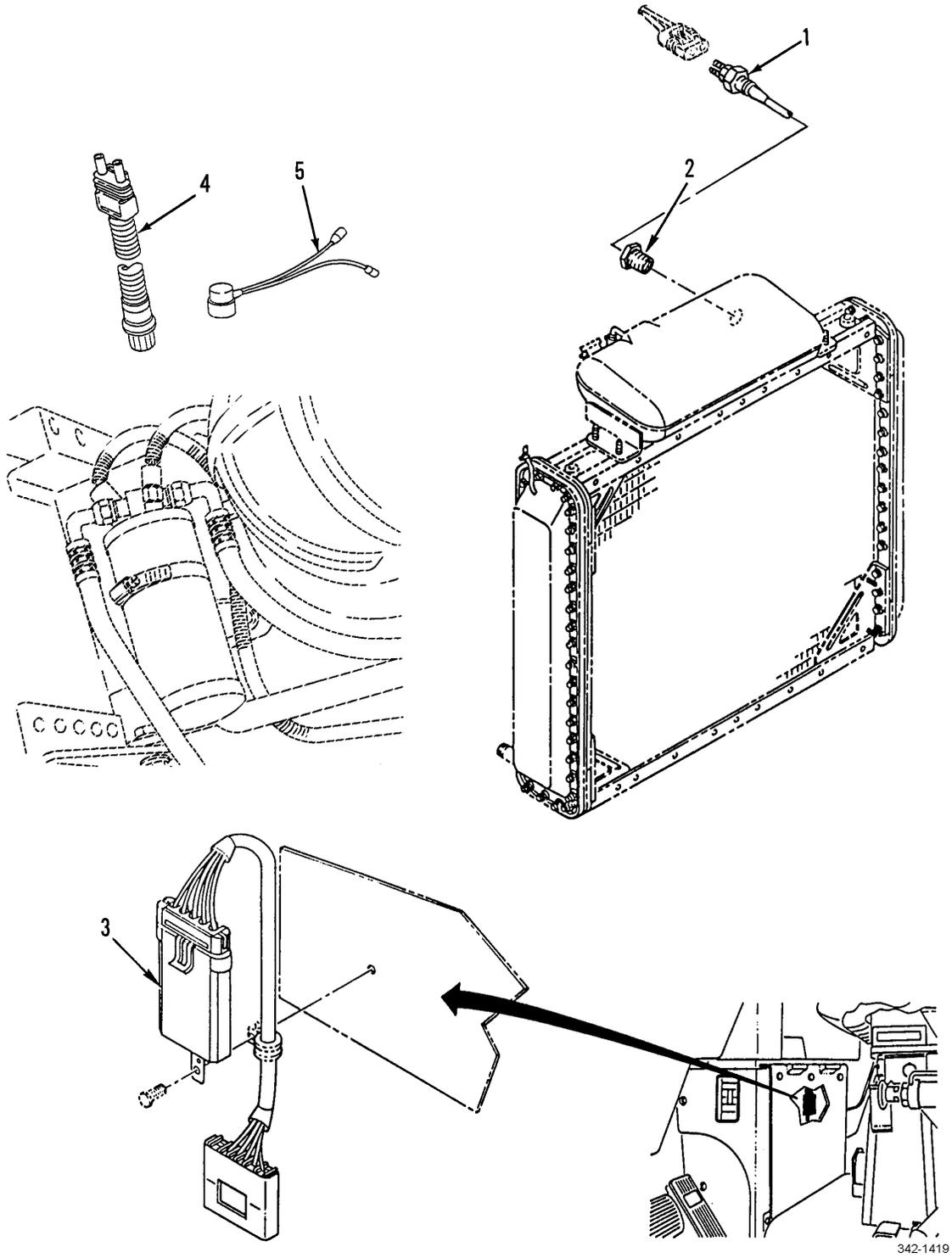
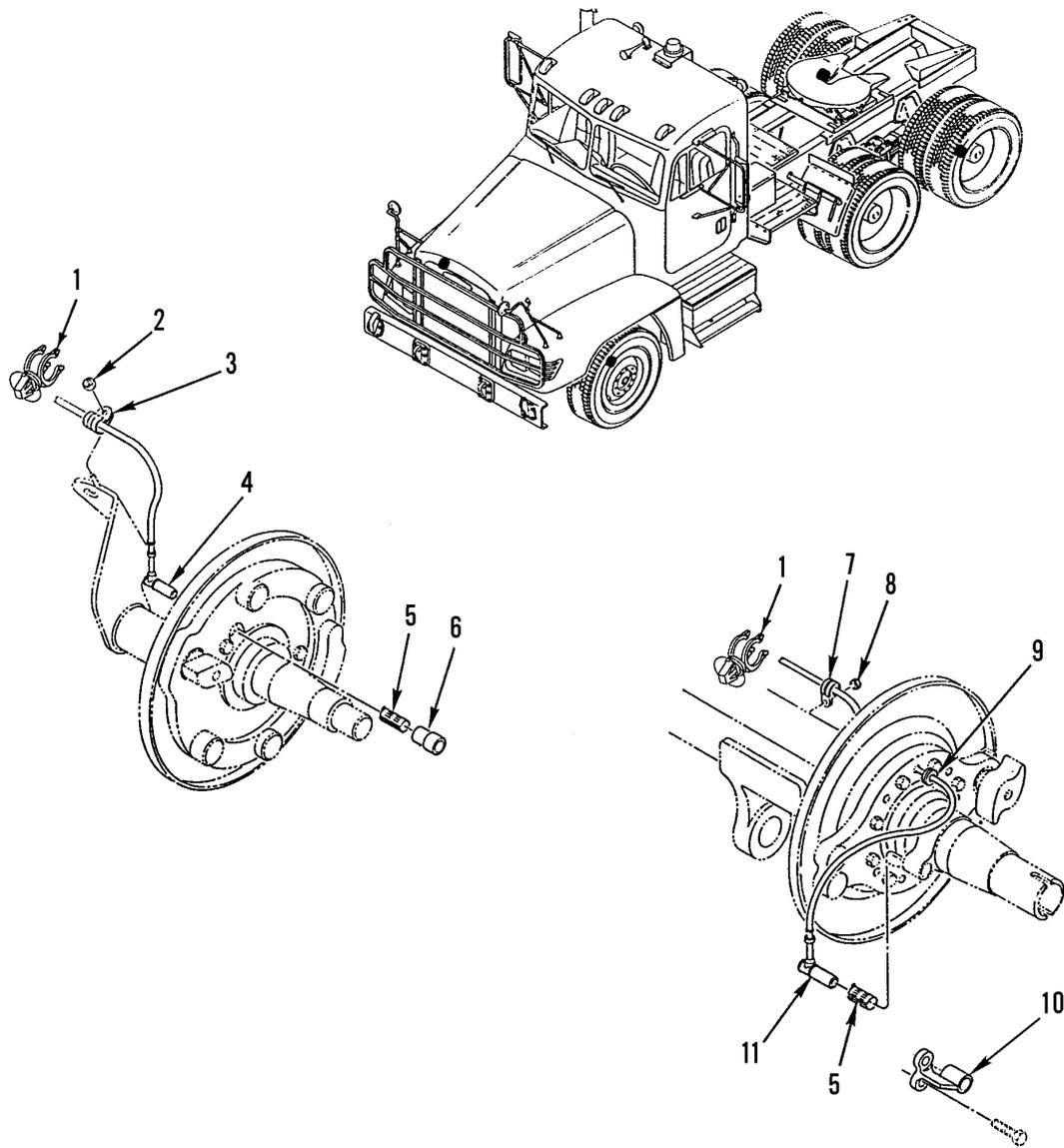

Figure 87. Water Level Probe, Module and A/C Switch

SECTION II			TM9-2320-302-24P			
(1)	(2)	(3)	(4)	(5)	(6)	(7)
ITEM	SMR			PART		
NO	CODE	NSN	CAGEC	NUMBER	DESCRIPTION AND USABLE ON CODES(UOC)	QTY
					GROUP 0610 SENDING UNITS AND WARNING SWITCHES	
					FIG. 87 WATER LEVEL PROBE, MODULE AND A/C SWITCH	
1	PFOZZ	5905013316366	72582	23503510-ND	RESISTOR,THERMAL.....	1
2	PAOZZ	4730002026491	93061	209P-6-4	BUSHING,PIPE.....	1
3	XDOZZ		72582	23505265	SWITCH,ENGINE TEMPE.....	1
4	PAOZZ	5930014350397	14859	TXI40PS15-1	SWITCH,THERMOSTATIC.....	1
5	PFOZZ	5930014431947	64678	A22-36464-000	BOOT,DUST AND MOIST.....	1

END OF FIGURE



342-1501

Figure 88. ABS Sensors

SECTION II			TM9-2320-302-24P			
(1)	(2)	(3)	(4)	(5)	(6)	(7)
ITEM	SMR			PART		
NO	CODE	NSN	CAGEC	NUMBER	DESCRIPTION AND USABLE ON CODES(UOC)	QTY
GROUP 0610 SENDING UNITS AND WARNING SWITCHES						
FIG. 88 ABS SENSORS						
1	XDOZZ		78500	S4419023524	CLIP,CONNECTOR.....	4
2	PAOZZ	5310000881251	81349	M45913/1-4CG5C	NUT,SELF LOCKING,HE.....	4
3	PAOZZ	5340004130070	01276	900729-8	CLAMP,LOOP.....	2
4	PAOZZ	2530014790838	78500	S4410328130	SENSOR,ANTI-LOCK BR FRONT.....	2
5	PAOZZ	5342013507071	78500	899 760 510 4	MOUNT,RESILIENT.....	2
6	PAOZZ	3120014784833	64678	10-12332-000	BUSHING,SLEEVE.....	2
7	PAOZZ	5340013502444	18076	S463-G4	CLAMP,LOOP.....	2
8	PFOZZ	5310010882825	64678	23-09247-104	NUT,PLAIN,HEXAGON.....	2
9	MFOZZ		64678	48-02217-050X3	CONDUIT MAKE FROM CAGE:77060, P/N: 68237R X 3FT, REAR AXLE.....	2
10	PFOZA	2590014789451	4N501	103620G	BRACKET,VEHICULAR C REAR AXLE.....	2
11	PAOZZ		78500	S4410328140	SENSOR,ANTI-LOCK BR REAR AXLE.....	2

END OF FIGURE

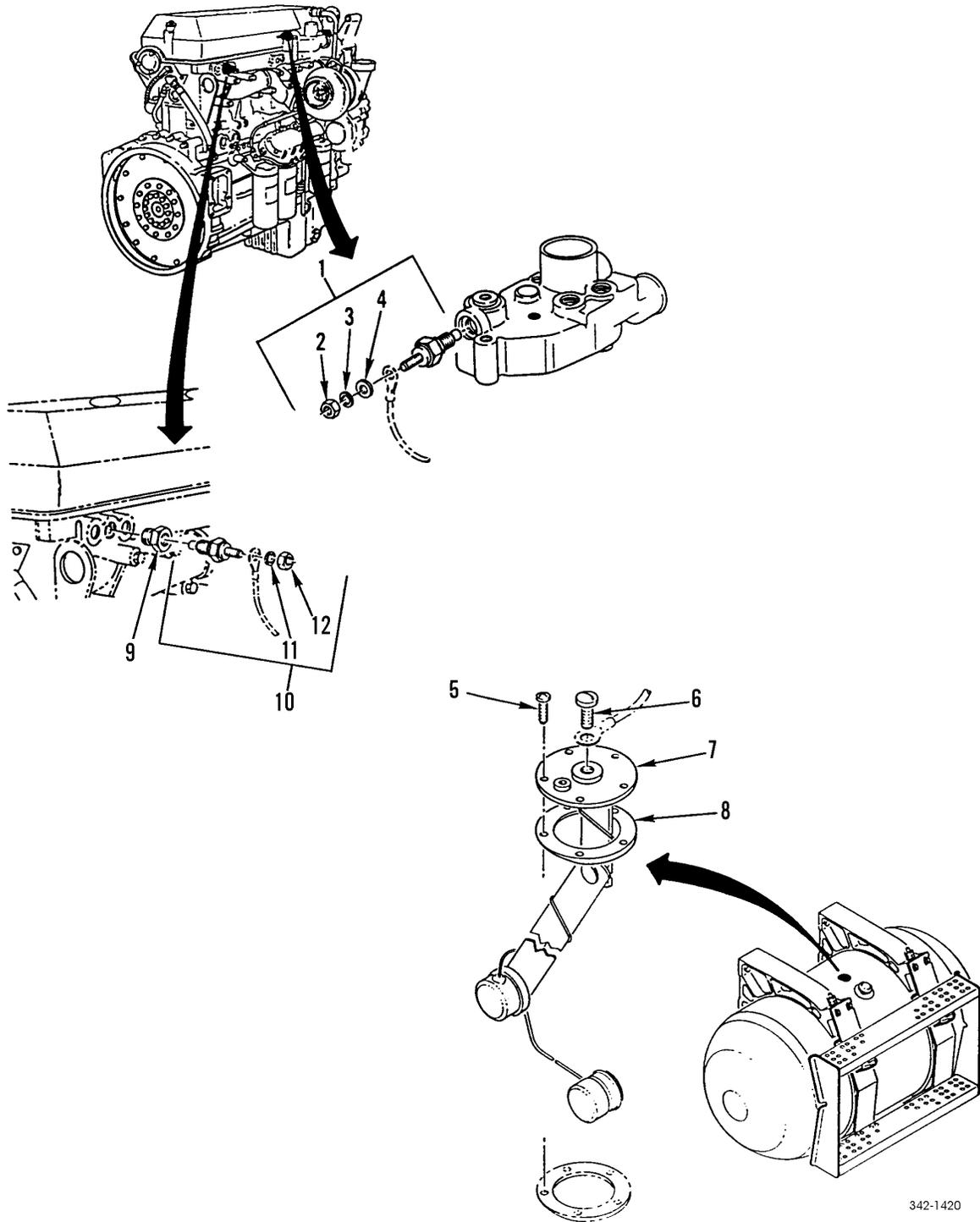

342-1420

Figure 89. Sensors and Sending Units

SECTION II			TM9-2320-302-24P			
(1)	(2)	(3)	(4)	(5)	(6)	(7)
ITEM NO	SMR CODE	NSN	CAGEC	PART NUMBER	DESCRIPTION AND USABLE ON CODES(UOC)	QTY
GROUP 0610 SENDING UNITS AND WARNING SWITCHES						
FIG. 89 SENSORS AND SENDING UNITS						
1	PAOZZ	5905013314103	64678	22-16975-005	RESISTOR, THERMAL.....	1
2	PAOZZ	5310009349766	96906	MS35650-305	.NUT, PLAIN, HEXAGON.....	1
3	PAOZZ	5310011251137	57733	171105	.WASHER, LOCK.....	1
4	PAOZZ	5310000455207	96906	MS15795-908	.WASHER, FLAT.....	1
5	PAOZZ	5305007919426	45722	TAPITS10-12-3-4	SCREW, TAPPING 10-16 X 0.75, SLOTTED.	5
6	PAOZZ	5305013555504	64678	23-11160-025	SCREW, MACHINE 10-24 X .025, TORX....	1
7	PAOZZ	2910013562715	57733	391-NX	SWITCH, LIQUID LEVEL.....	1
8	PAOZZ	5330013557002	64678	22-27156-000	GASKET.....	1
9	PAOZZ	4730013559205	75418	3022-01372-03	BUSHING, PIPE.....	1
10	PAOZZ	2990013325459	75418	1002-07005-35	SENSOR, ENGINE COOLA.....	1
11	PAOZZ	5310011847647	51377	3059-00874-02	.WASHER, LOCK.....	1
12	PAOZZ	5310009349757	96906	MS35649-282	.NUT, PLAIN, HEXAGON.....	1

END OF FIGURE

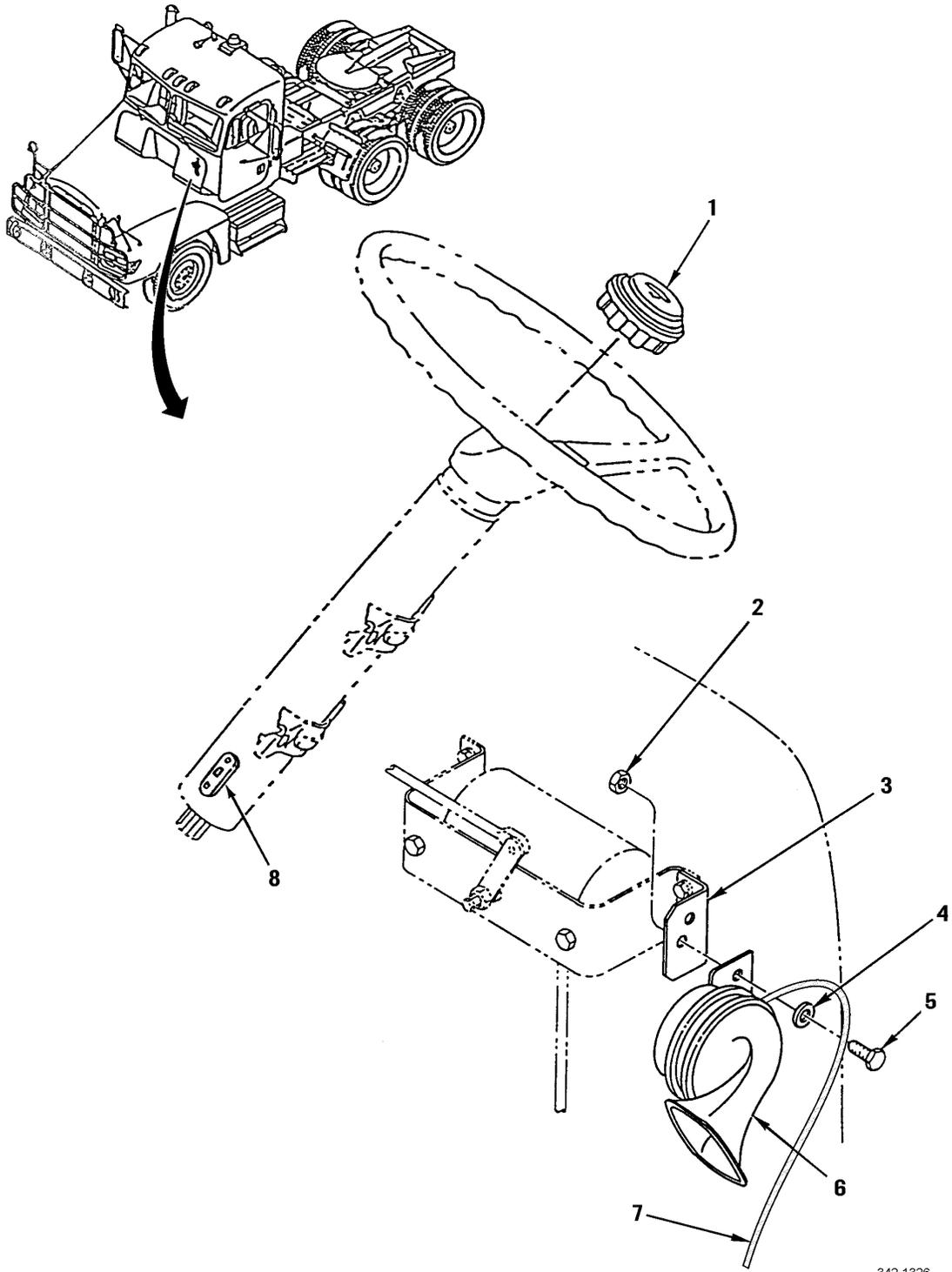

342-1326

Figure 90. Electric Horn

SECTION II			TM9-2320-302-24P			
(1)	(2)	(3)	(4)	(5)	(6)	(7)
ITEM	SMR			PART		
NO	CODE	NSN	CAGEC	NUMBER	DESCRIPTION AND USABLE ON CODES(UOC)	QTY
GROUP 0611 HORN, SIREN						
FIG. 90 ELECTRIC HORN						
1	PAOZZ	2530013295045	64678	681 460 00 40	HORN BUTTON,VEHICLE.....	1
2	XDOZZ	5310013494083	96906	MS9356-04	NUT,PLAIN,HEXAGON .243 X .112-48	1
					IN, UNJF-3B.....	
3	PFOZZ	6350013670757	64678	06-19019-000	BRACKET,HORN.....	1
4	PAOZZ	5310005501130	96906	MS35333-40	WASHER,LOCK.....	1
5	PAOZZ	5305000680508	80204	B1821BH025C075N	SCREW,CAP,HEXAGON H 1/4-20X0.75 IN.	1
6	PAOZZ		64678	FIA 7222821S	HORN,SINGAL,ELECTRI 12V,LOW,400 HZ	1
					ELECTRICAL.....	
7	PAOZZ	6150014786801	64678	A06-30881-000	WIRING,HARNESS.....	1
8	PAOZZ	5945014480189	77640	453094-A2	RELAY,ELECTROMAGNET.....	1

END OF FIGURE

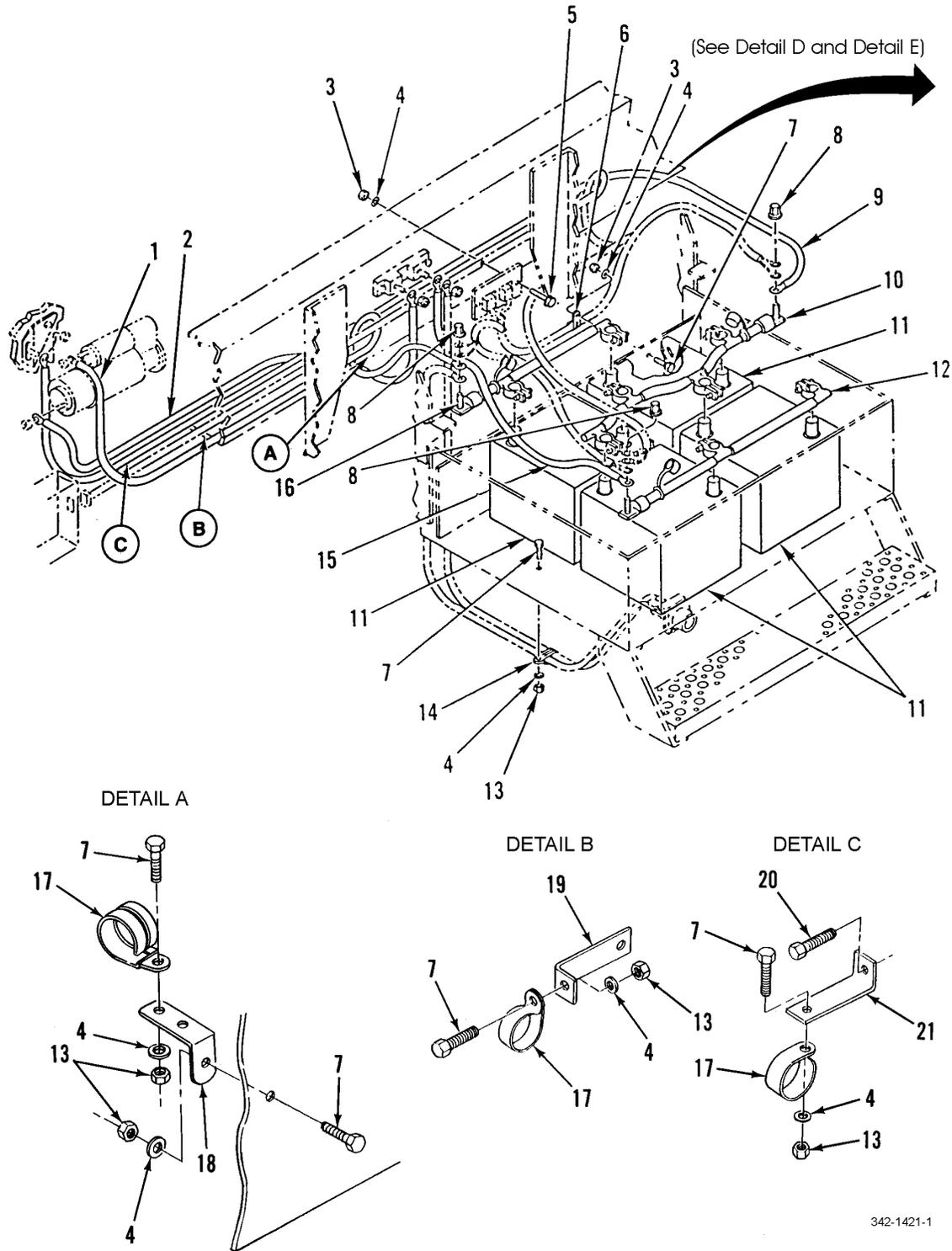
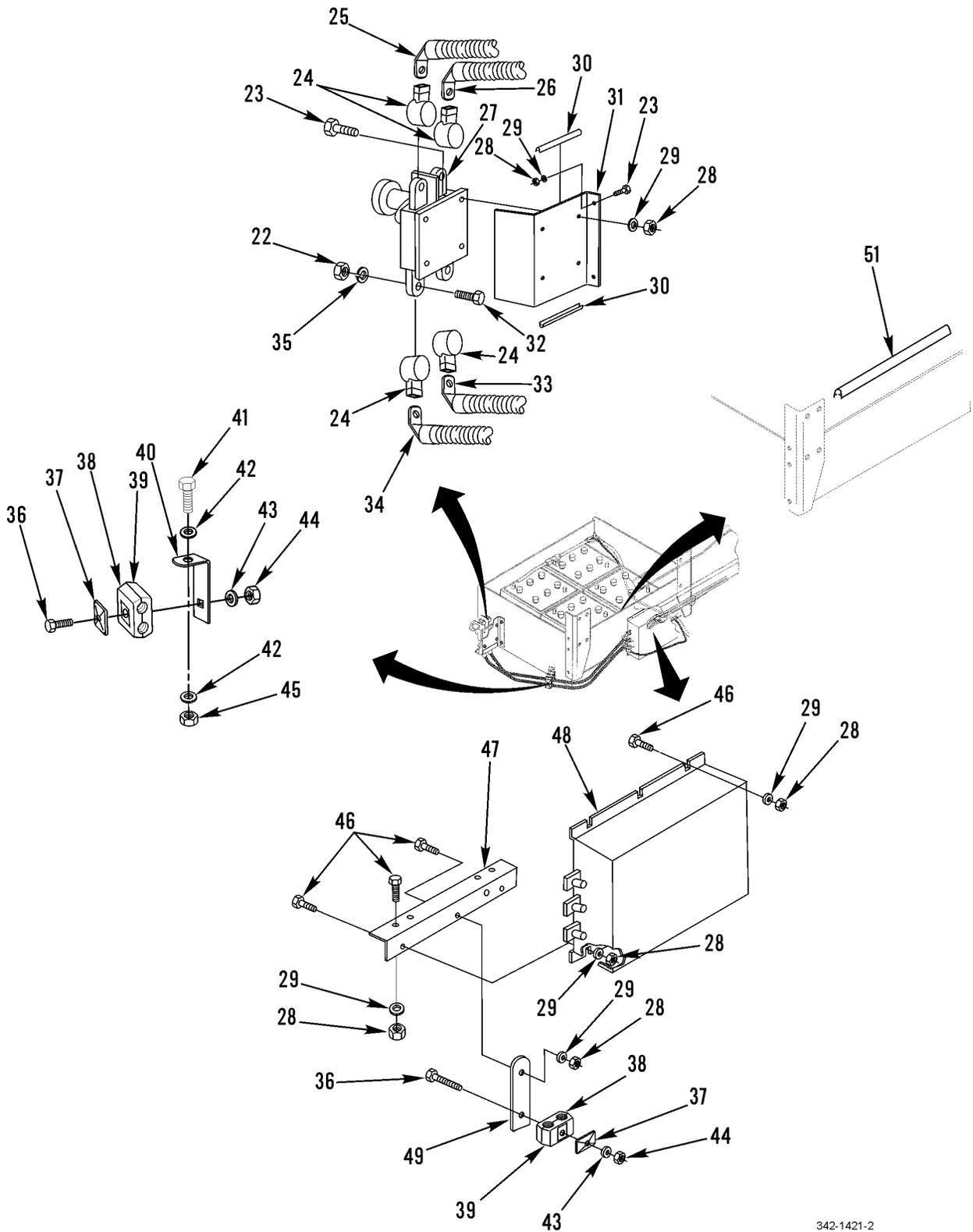

Figure 91. Batteries, Battery Cables, Equalizer, and Cutoff Switch (Sheet 1 of 2)



342-1421-2

Figure 91. Batteries, Battery Cables, Equalizer, and Cutoff Switch (Sheet 2 of 2)

SECTION II			TM9-2320-302-24P			
(1)	(2)	(3)	(4)	(5)	(6)	(7)
ITEM	SMR			PART		
NO	CODE	NSN	CAGEC	NUMBER	DESCRIPTION AND USABLE ON CODES(UOC)	QTY
					GROUP 0612 BATTERIES, STORAGE (WET OR DRY)	
					FIG. 91 BATTERIES, BATTERY CABLES, EQUALIZER, AND CUTOFF SWITCH	
1	PAOZZ	6150013396119	64678	A06-18295-061	LEAD,ELECTRICAL.....	1
2	PAOZZ	6150013396118	64678	A06-18296-055	LEAD,ELECTRICAL.....	1
3	PAOZZ	5310000881251	81349	M45913/1-4CG5C	NUT,SELF LOCKING,HE.....	3
4	PAOZZ	5310008094058	96906	MS27183-10	WASHER,FLAT.....	4
5	PAOZZ	5305000712509	80204	B1821BH025C150N	SCREW,CAP,HEXAGON H.....	2
6	PAOZZ	5340013327473	18076	S463-G23	CLAMP,LOOP.....	1
7	PAOZZ	5305002253843	80204	B1821BH025C100N	SCREW,CAP,HEXAGON H.....	5
8	PAOZZ	3040010366582	19204	12008084	CONNECTING LINK,RIG.....	3
9	PAOZZ	6140013665533	64678	A06-18294-086	LEAD,STORAGE BATTER.....	1
10	PAOZZ	6150013389777	64678	06-19508-000	JUMPER CABLE,BATTER.....	1
11	PAOFA	6140014311172	04055	6TLFP	BATTERY,STORAGE.....	4
12	PAOZZ	6150013366477	64678	06-18159-000	CABLE ASSEMBLY,SPEC.....	1
13	PAOZZ	5310008512674	96906	MS35691-1	NUT,PLAIN,HEXAGON.....	5
14	PAOZZ	5340013394266	64678	23-11358-024	CLAMP,LOOP 7/8 IN,2 TUBES.....	1
15	XDOZZ		64678	A06-14209-072	LEAD,STORAGE BATTER.....	1
16	PAOZZ	6150013399891	64678	06-18158-000	JUMPER CABLE,BATTER.....	1
17	PAOZZ	5340013334614	18076	S463-G26	CLAMP,LOOP.....	3
18	PAOZZ	5340013284371	64678	23-09130-002	BRACKET,ANGLE.....	1
19	PAOZZ	5340013338889	64678	23-09130-001	BRACKET,ANGLE.....	1
20	PAOZZ	5306012708909	15526	DIN933-M8-1.25X2 0-8.8-A4C	BOLT,MACHINE M8-1.25X2.....	1
21	PFOZZ	5340013284367	64678	23-09130-000	BRACKET,ANGLE.....	1
22	XDOZZ		64678	23-09596-050	NUT,PLAIN,HEXAGON 1/2-13UNC.....	4
23	PAOZZ	5305002253843	80204	B1821BH025C100N	SCREW,CAP,HEXAGON H 1/4-20 X 1.00".	7
24	XDOZZ		64678	06-36014-000	BOOT.....	4
25	XDOZZ		64678	A06-35801-050	CABLE ASSEMBLY.....	1
26	XDOZZ		64678	A06-35823-057	CABLE ASSEMBLY.....	1
27	PFOZZ		D1510	2401.00.901	SWITCH ASSEMBLY.....	1
28	PAOZZ	5310000881251	81349	M45913/1-4CG5C	NUT,SELF-LOCKING,HE 1/4-20UNC.....	16
29	PAOZZ	5310008094058	96906	MS27183-10	WASHER,FLAT .281 ID X .625 OD X .065 THK.....	18
30	MOOZZ		64678	48-02188-001X4"	MOLDING TRIM TO FIT.....	2
31	XDOZZ		64678	06-35699-001	BRACKET,DOUBLE ANGL.....	1
32	PAOZZ	5305000712067	80204	B1821BH050C125N	SCREW,CAP,HEXAGON H 1/2-13 X 1.25..	4
33	XDOZZ		64678	A06-37347-036	CABLE ASSEMBLY 36" 24V EQUALIZER TO CUTOFF SWITCH.....	1
34	XDOZZ		64678	A06-37348-036	CABLE ASSEMBLY 36" 12V EQUALIZER TO CUTOFF SWITCH.....	1
35	PAOZZ		96906	MS35338-48	WASHER,LOCK 1/2".....	4
36	PAOZZ	5305013463694	64678	23-10744-350	SCREW,CAP,HEXAGON H 5/16-18 X 3.50"	2
37	XDOZZ		64678	06-19690-000	CAP,ELECTRICAL.....	2
38	XDOZZ		81779	T2062PP	CLAMP,BLOCK.....	2
39	XDOZZ		81779	T3075PP	CLAMP,BLOCK.....	2
40	XDOZZ		64678	06-21383-000	BRACKET,ANGLE.....	1
41	XDOZZ		64678	23-10748-125	SCREW,CAP,HEXAGON H 7/16-14 X 1.25"	1
42	PAOZZ	5310008094085	96906	MS27183-16	WASHER,FLAT 7/16".....	2

SECTION II		TM9-2320-302-24P				
(1)	(2)	(3)	(4)	(5)	(6)	(7)
ITEM NO	SMR CODE	NSN	CAGEC	PART NUMBER	DESCRIPTION AND USABLE ON CODES(UOC)	QTY
43	PFOZZ	5310000814219	96906	MS27183-12	WASHER,FLAT .344 ID X .688 OD X .065 THK.....	2
44	PAOZZ	5310009133366	81349	M45913/1-5CBB	NUT,SELF-LOCKING,HE 5/16-18.....	2
45	XDOZZ		64678	23-09339-009	NUT,PLAIN,HEXAGON 7/16-14.....	1
46	PAOZZ	5305002253843	80204	B1821BH025C100N	SCREW,CAP,HEXAGON H 1/4-20UNC X 1.00.....	2
47	XDOZZ		64678	06-25941-000	BRACKET,ANGLE.....	1
48	PFOZZ		55156	52210	EQUALIZER,BATTERY.....	1
49	PAOZZ	5340013319498	64678	E22-25578-000	BRACKET,DOUBLE ANGL.....	1
50	XDOZZ		64678	A06-37349-054	CABLE ASSEMBLY EQUALIZER GROUND....	1
51	XDOZZ		64678	22-25773-012	MOLDING,EDGE GUARD.....	1

END OF FIGURE

16
|
17

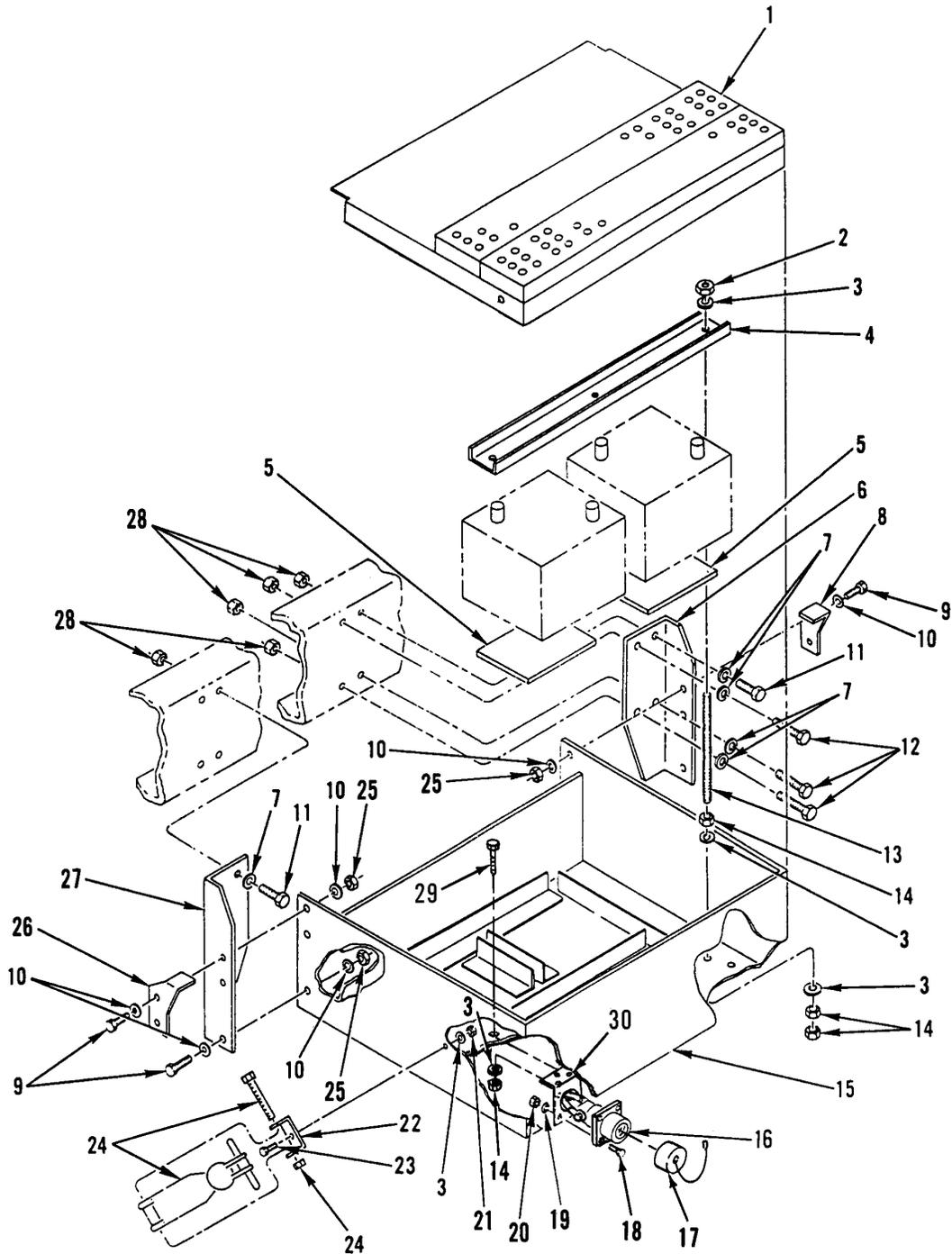

342-1289

Figure 92. Battery Box Assembly

SECTION II			TM9-2320-302-24P			
(1)	(2)	(3)	(4)	(5)	(6)	(7)
ITEM	SMR			PART		
NO	CODE	NSN	CAGEC	NUMBER	DESCRIPTION AND USABLE ON CODES(UOC)	QTY
GROUP 0612 BATTERIES, STORAGE (WET OR DRY)						
FIG. 92 BATTERY BOX ASSEMBLY						
1	PAOZZ	6160013408856	64678	A06-17965-000	COVER, BATTERY BOX.....	1
2	PAOZZ	5310009133366	81349	M45913/1-5CBB	NUT, SELF-LOCKING, HE 5/16-18.....	6
3	PFOZZ	5310000814219	96906	MS27183-12	WASHER, FLAT .344 ID X .688 OD X .065 THK.....	18
4	XDOZZ		64678	06-18405-001	RETAINER, BATTERY.....	2
5	MOOZZ		64678	06-18131-001	LINER, PLYWOOD MAKE FROM CAGE 09814, PN CS122-56GRADECDINTERIOR TYPE, 7 X 7.5 IN.....	1
6	XDOZZ		64678	06-17976-000	BRACKET, ANGLE.....	1
7	PAOZZ	5310007208819	96906	MS15795-821	WASHER, FLAT .688 ID X 1.750 OD.....	8
8	XDOZZ		64678	A06-18198-000	BRACKET, COVER RIGHT.....	1
9	PAOZZ	5305000712069	80204	B1821BH050C150N	SCREW, CAP, HEXAGON H 1/2-13UNC-2A X 1.500.....	6
10	PAOZZ	5310011091977	19207	11628332-2	WASHER, FLAT .531 ID X 1.062 OD X .18 THK.....	12
11	PAOZZ	5305007247221	80204	B1821BH063C175N	SCREW, CAP, HEXAGON H 5/8-11UNC-2A X 1.750.....	8
12	PAOZZ	5305007247224	80204	B1821BH063C250N	SCREW, CAP, HEXAGON H.....	3
13	XDOZZ		64678	06-32041-101	ROD, CONTINUOUS THRE.....	6
14	PAOZA	5310004906482	96906	MS9356-06	NUT, PLAIN, HEXAGON 5/16-18UNC, GR5...	18
15	PAOZZ	6160013408837	64678	A06-17960-001	BATTERY BOX.....	1
16	PAOZZ	6150013670599	96139	MB14106-2	CABLE ASSEMBLY, SPEC.....	1
17	PAOZZ	5340013157223	19207	12342306	.CAP, PROTECTIVE, DUST.....	1
18	PAOZZ	5306013370351	64678	23-9890-100	BOLT, MACHINE 10-24 X 1.00.....	4
19	PAOZZ	5310000145850	96906	MS27183-42	WASHER, FLAT.....	4
20	PAOZZ	5310013294045	64678	23-09336-005	NUT, SELF-LOCKING, CL CLR LOCK, 10-24.	4
21	PAOZZ	5310013336436	64678	23-10340-125	NUT, SELF-LOCKING, AS 1/4-20.....	2
22	PFOZZ	5340013369560	64386	HRM 277-A-80	BRACKET, DOUBLE ANGL ANGL.....	2
23	PAOZZ	5305012853996	80204	1/4-20UNC-2AX1 L G PAN HD	SCREW, MACHINE 1/4-20, ZINK.....	2
24	PAOZZ	4020011066523	64386	66D638	CORD ASSEMBLY, ELAST.....	2
25	PAOZZ	5310002256993	96906	MS51922-33	NUT, SELF-LOCKING, HE 1/2-13UNC.....	6
26	XDOZZ		64678	A06-18198-001	BRACKET, COVER LEFT.....	1
27	XDOZZ		64678	06-17976-001	ANGLE, LWRG.....	1
28	PAOZZ	5310002694040	96906	MS51922-49	NUT, SELF-LOCKING, HE 5/8-11UNC.....	8
29	PAOZZ	5305002253843	80204	B1821BH025C100N	SCREW, CAP, HEXAGON H 1/4-20UNC X 1.00.....	2
30	PAOZZ	5340013911349	64678	06-20879-000	BRACKET, ANGLE.....	1

END OF FIGURE

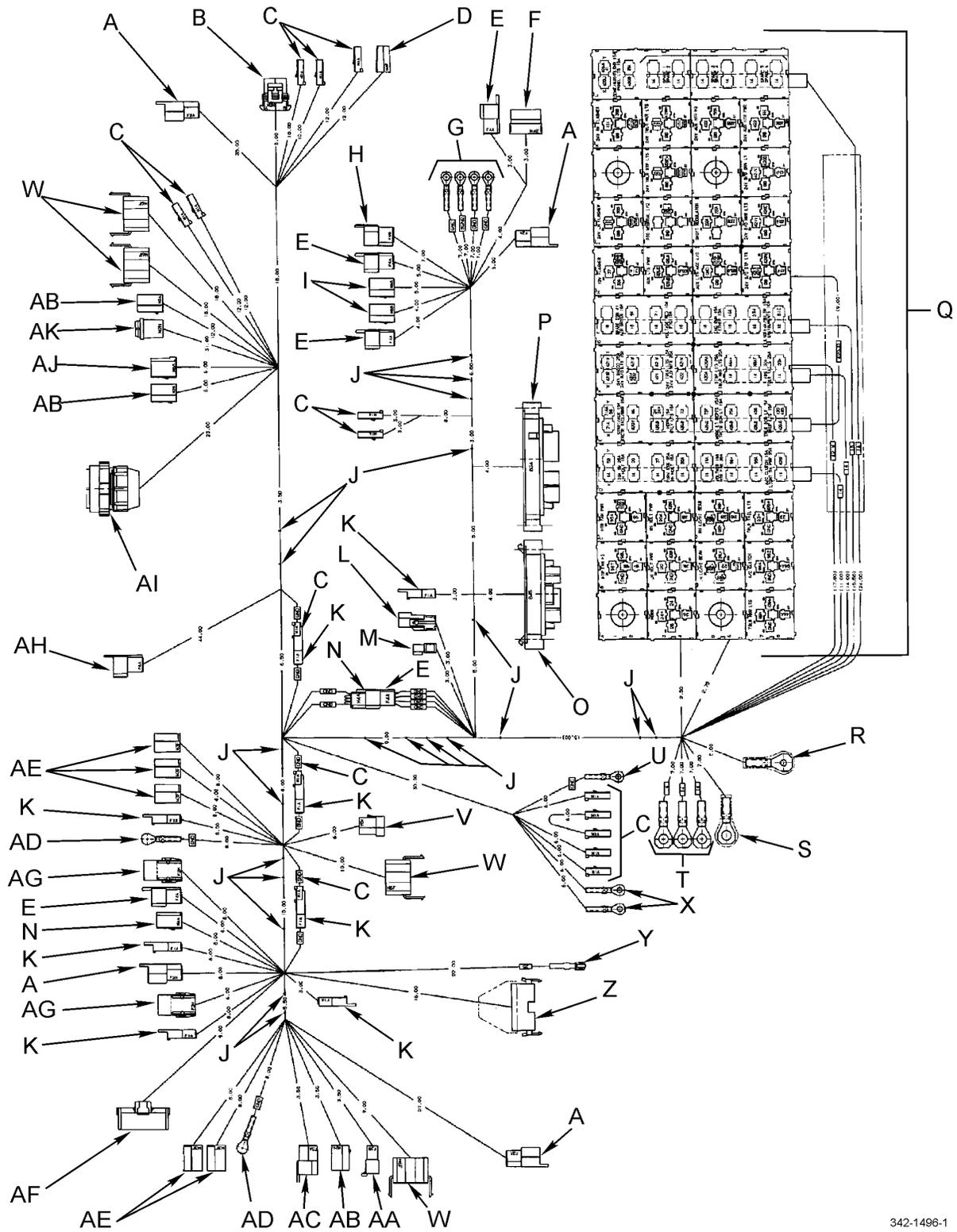

Figure 93. Main Cab Wiring Harness (Sheet 1 of 6)

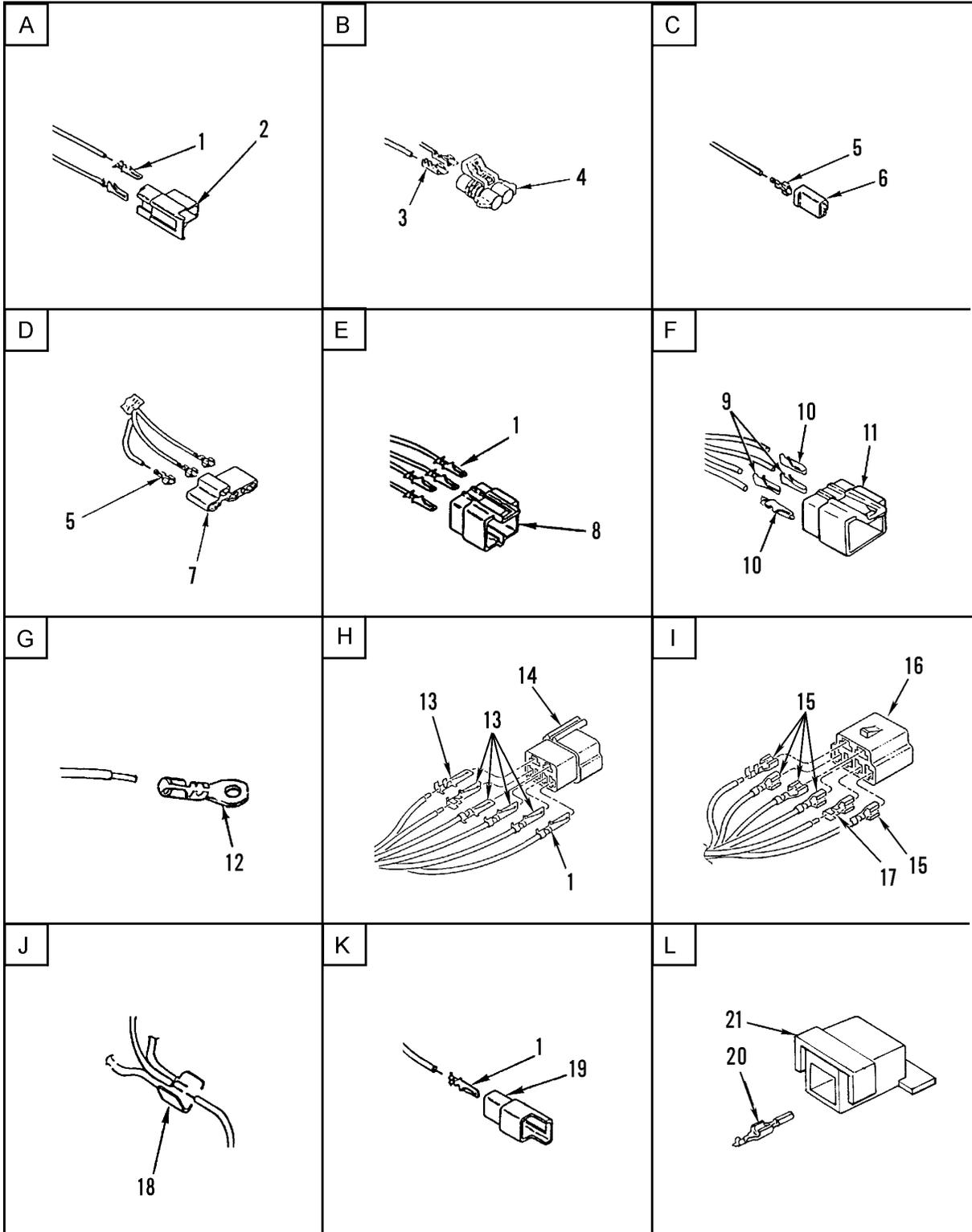

Figure 93. Main Cab Wiring Harness (Sheet 2 of 6)

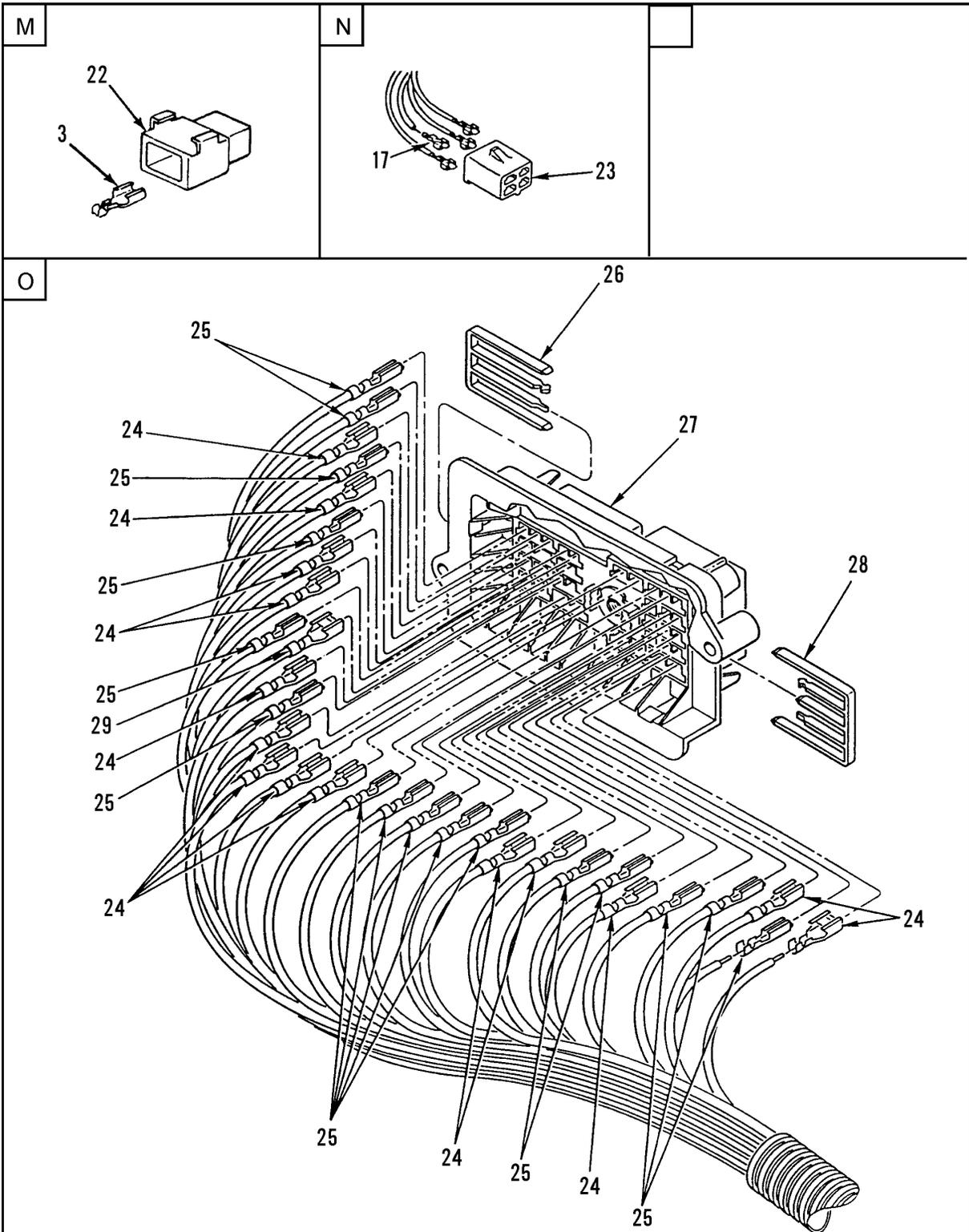
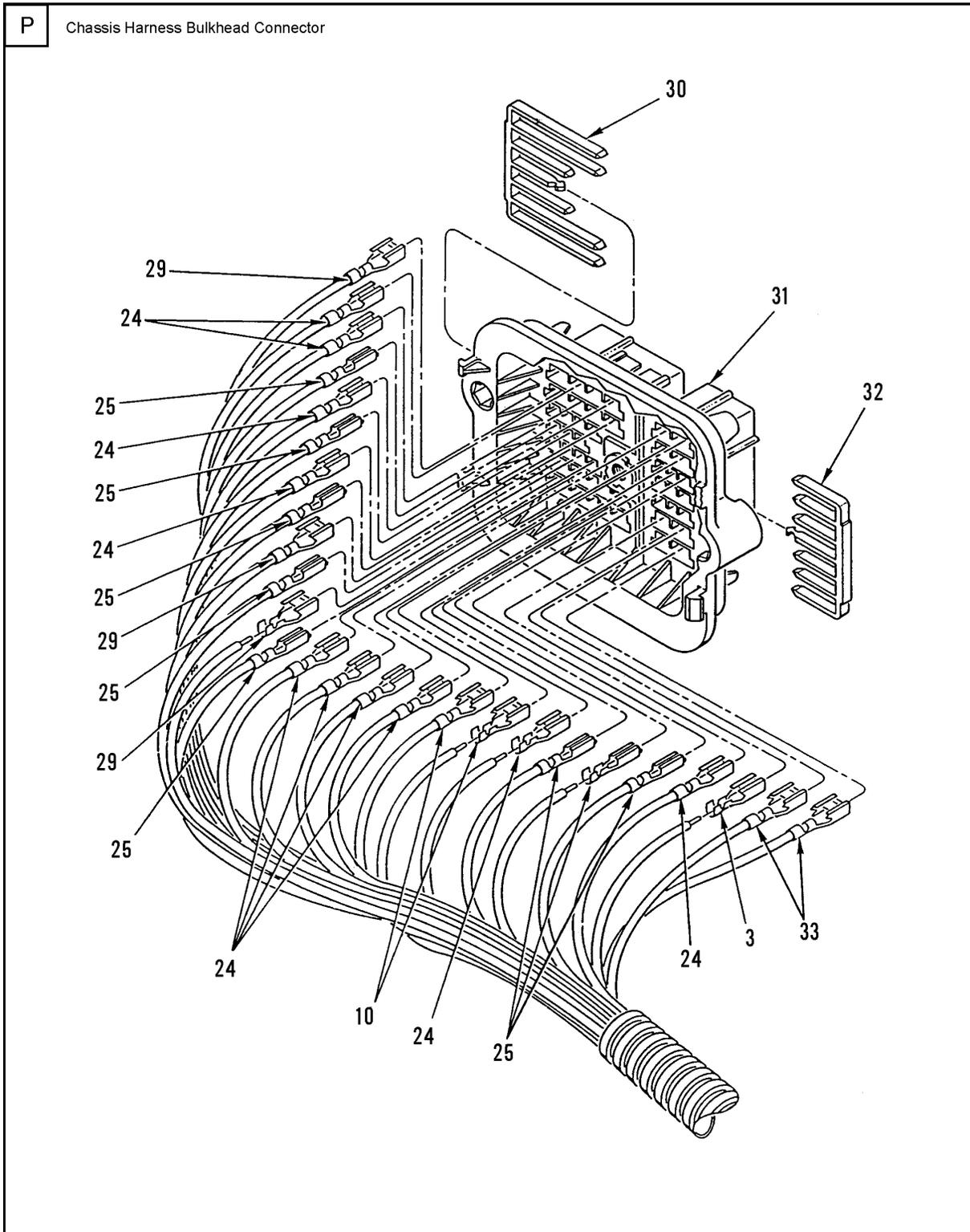

Figure 93. Main Cab Wiring Harness (Sheet 3 of 6)



342-1496-4

Figure 93. Main Cab Wiring Harness (Sheet 4 of 6)

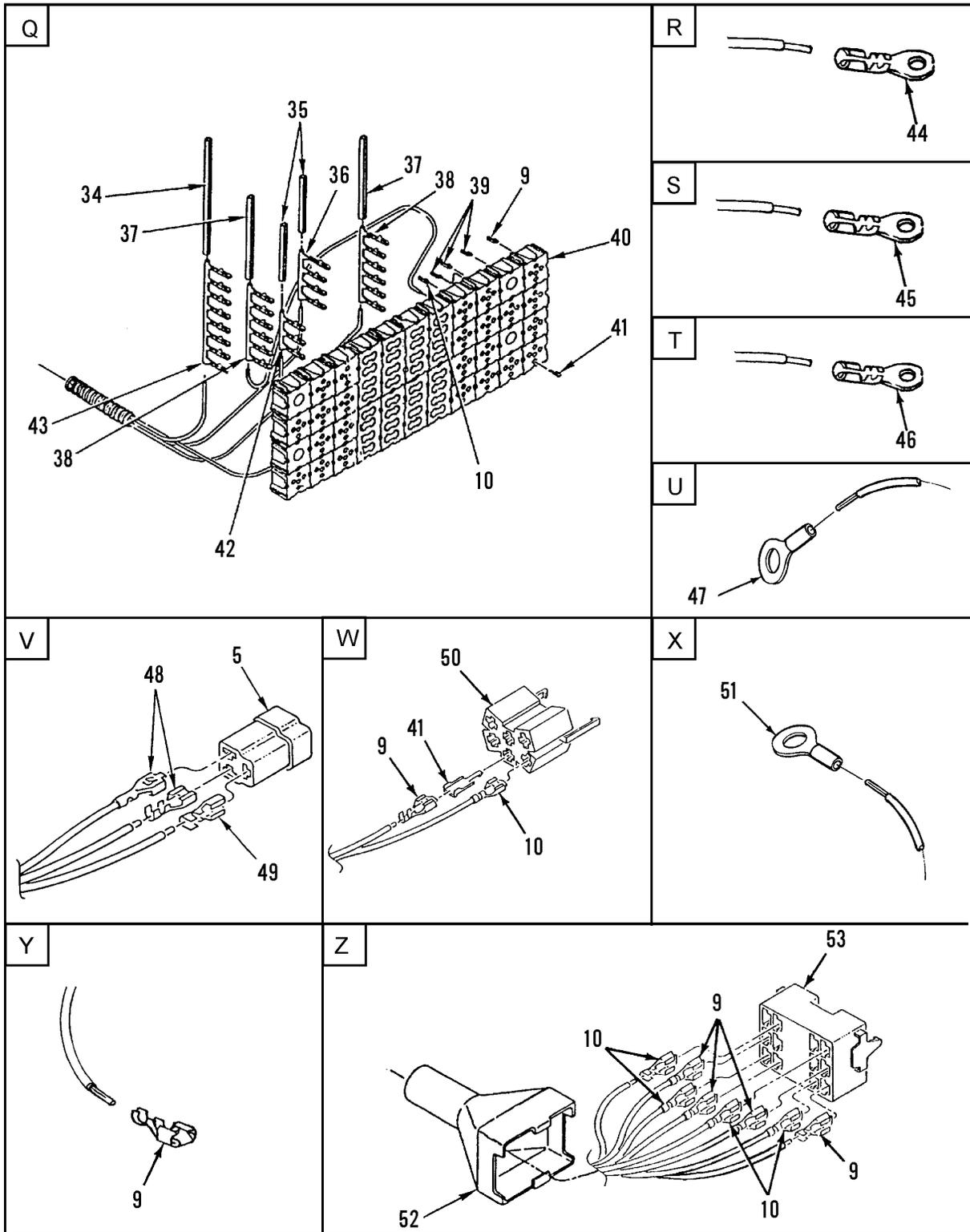

Figure 93. Main Cab Wiring Harness (Sheet 5 of 6)

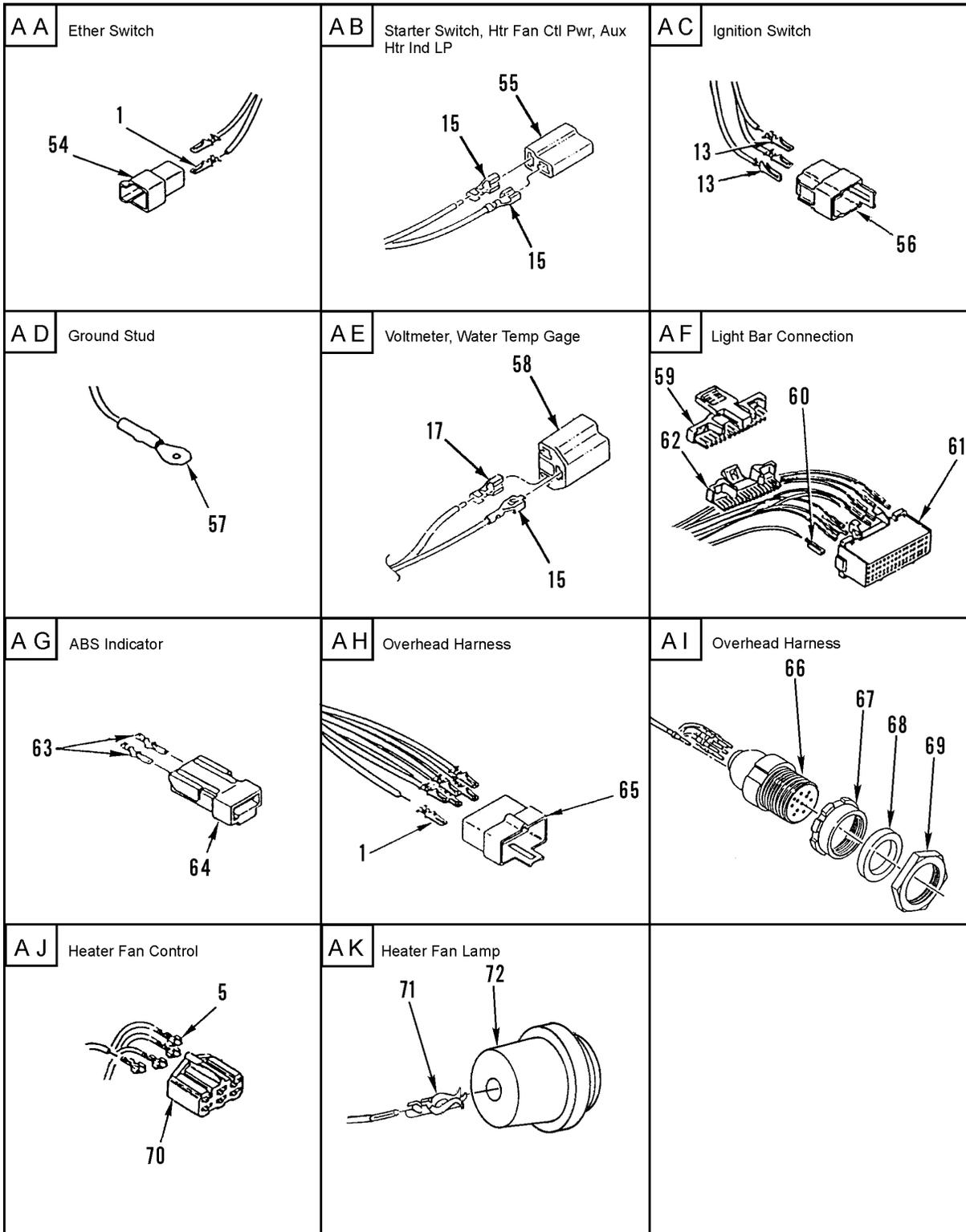
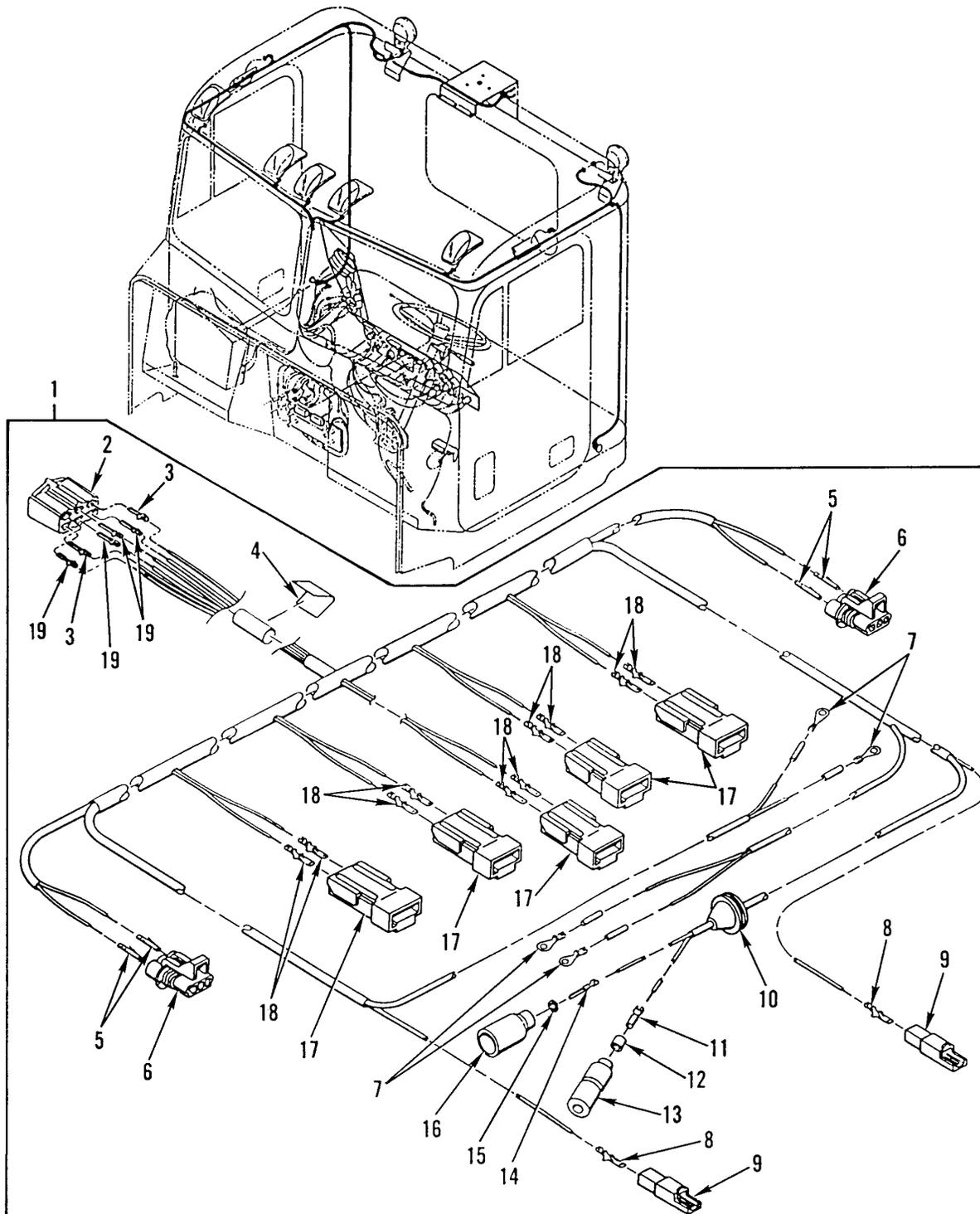

Figure 93. Main Cab Wiring Harness (Sheet 6 of 6)

SECTION II			TM9-2320-302-24P			
(1)	(2)	(3)	(4)	(5)	(6)	(7)
ITEM	SMR			PART		
NO	CODE	NSN	CAGEC	NUMBER	DESCRIPTION AND USABLE ON CODES(UOC)	QTY
GROUP 0613 HULL OR CHASSIS WIRING HARNESS						
FIG. 93 MAIN CAB WIRING HARNESS						
1	PBFFF	6150014357199	64678	A06-23337-000	WIRING HARNESS, BRAN.....	1
2	PAOZZ	5940009563517	77060	2962987	.TERMINAL, QUICK DISC.....	43
3	PAOZZ	5940013410525	77060	12084595	.TERMINAL, QUICK DISC.....	3
4	PAOZZ	5935013369923	77060	1205 2613	.CONNECTOR BODY, PLUG.....	1
5	PAOZZ	5940013366326	77060	2965143	.TERMINAL, QUICK DISC.....	14
6	PAOZZ	5935010657984	77060	2977253	.CONNECTOR, PLUG, ELEC.....	15
7	XDOZZ		77060	2965019	.CONNECTOR BODY, RECE.....	1
8	PAOZZ	5935011680731	77060	6294544	.CONNECTOR BODY, RECE.....	5
9	PAOZZ	5940013409064	77060	1201 5870	.TERMINAL, QUICK DISC.....	71
10	PAOZZ	5940013373319	77060	1208 4590	.TERMINAL, QUICK DISC.....	34
11	XDOZZ		77060	12015664	.CONNECTOR, MALE 4P.....	1
12	PAOZZ	5940001139820	77060	12004437	.TERMINAL, LUG.....	4
13	PAOZZ	5940013373318	77060	2971859	.TERMINAL, QUICK DISC.....	1
14	PAOZZ	5935013365394	77060	6288700	.CONNECTOR BODY, PLUG.....	1
15	PAOZZ	5940007881586	77060	2965142	.TERMINAL, QUICK DISC.....	37
16	PAOZZ	5935013365401	77060	2973890	.CONNECTOR BODY, RECE.....	2
17	PAOZZ	5940013399566	77060	2965467	.TERMINAL, QUICK DISC.....	4
18	PAOZZ	5940008425353	77060	1839906	.SPLICE, CONDUCTOR.....	25
19	PAOZZ	5940012347954	77060	2984528	.TERMINAL BODY, QUICK.....	14
20	PAOZZ	5940013421640	77060	1202 0120	.TERMINAL, QUICK DISC.....	1
21	XDOZZ		77060	12015987	.CONNECTOR, PLUG, ELEC.....	1
22	XDOZZ		77060	12015952	.CONNECTOR, PLUG, ELEC.....	1
23	PAOZZ	5935010657983	77060	2977048	.CONNECTOR, PLUG, ELEC.....	2
24	PAOZZ	5940013431262	77060	12124304	.TERMINAL, QUICK DISC.....	17
25	PAOZZ	5940013476142	77060	1206 6214	.TERMINAL, QUICK DISC.....	21
26	PAOZZ	5310013507074	77060	1201 5510	.NUT, STAMPED.....	1
27	PAFZZ	5935013366412	77060	1201 5508	.CONNECTOR BODY, RECE.....	1
28	PAFZZ	5935013369065	77060	1201 5511	.RETAINER, ELECTRICAL.....	1
29	PAOZZ	5940013409064	77060	1201 5870	.TERMINAL, QUICK DISC.....	71
30	PAFZZ	5970013417697	77060	1201 5969	.INSULATOR, PLATE.....	1
31	PAFZZ	5935013366413	77060	1202 0545	.CONNECTOR BODY, RECE.....	1
32	PAFZZ	5970013417696	77060	1201 5968	.INSULATOR, PLATE.....	1
33	PAOZZ	5975013395950	18179	90PC20R	.BOOT, DUST AND MOIST.....	2
34	PAFZZ	6150013375038	2E480	092576	.BUS, CONDUCTOR.....	1
35	PAFZZ	6150013531002	2E480	092612	.BUS, CONDUCTOR.....	1
36	PAFZZ	6150013375039	2E480	092579	.BUS, CONDUCTOR.....	1
37	PFFZZ	6150013534812	2E480	092587	.BUS, CONDUCTOR.....	2
38	PAFZZ	6150013398299	2E480	092580	.BUS, CONDUCTOR.....	2
39	XDOZZ	5940013476140	77060	1208 4588	.TERMINAL, QUICK DISC.....	16
40	XDFZZ		64678	A06-23561-000	.FUSEHOLDER, BLOCK.....	1
41	PAOZZ	5940013366325	2E480	059056	.TERMINAL, LUG.....	107
42	PAOZZ	6150013595773	2E480	092578	.BUS, CONDUCTOR.....	1
43	PAFZZ	6150013375038	2E480	092576	.BUS, CONDUCTOR.....	1
44	PAOZZ	5940013367056	77060	12004439	.TERMINAL, LUG.....	1
45	XDOZZ		77060	12103505	.TERMINAL, LUG.....	1
46	PAOZZ	5940013365777	5R547	110640-AK02	.TERMINAL, STUD.....	3
47	PAOZZ	5940001133145	77060	2984576	.TERMINAL, LUG.....	1

SECTION II			TM9-2320-302-24P			
(1)	(2)	(3)	(4)	(5)	(6)	(7)
ITEM NO	SMR CODE	NSN	CAGEC	PART NUMBER	DESCRIPTION AND USABLE ON CODES(UOC)	QTY
48	PAOZA	5935003781253	77060	2984378	.CONNECTOR BODY,RECE.....	1
49	PAOZZ	5940013373317	77060	1201 5880	.TERMINAL,QUICK DISC.....	1
50	PAOZZ	5935013366900	64678	681 545 16 28	.CONNECTOR BODY,PLUG.....	6
51	PAOZZ	5940013417689	77060	12004436	.TERMINAL,LUG.....	2
52	PAOZZ	5930013363684	64678	06-17867-000	.BOOT,DUST AND MOIST.....	1
53	PAOZZ	5935013363694	81834	16-9043-07	.CONNECTOR BODY,PLUG.....	1
54	PAOZZ	5940013420559	77060	6294468	.TERMINAL,QUICK DISC.....	1
55	PAOZZ	5935011618087	77060	2973781	.CONNECTOR BODY,PLUG.....	3
56	PAOZZ	5935013363695	77060	2984678	.CONNECTOR BODY,PLUG.....	1
57	PAOZZ	5940013366322	5R547	101028-B02	.TERMINAL,LUG.....	1
58	PAOZZ	5935013425944	2E480	7255-99-00	.CONNECTOR BODY,PLUG.....	6
59	PAOZZ	5935013366410	77060	12045889	.CONNECTOR BODY,PLUG.....	1
60	XDOZZ		77060	12089649	.TERMINAL,FEMALE #18.....	16
61	PAOZZ	5935013490792	77060	1204 5575	.CONNECTOR BODY,RECE.....	1
62	PAOZZ	5935013363693	77060	12045890	.CONNECTOR BODY,PLUG.....	1
63	PAOZZ	5940013400587	77060	1202 0116	.TERMINAL,QUICK DISC.....	4
64	PAOZZ	5935013371028	64678	1201 5271	.CONNECTOR BODY,PLUG.....	2
65	PAOZZ	5935012952863	77060	2977042	.CONNECTOR BODY,PLUG.....	1
66	PAOZZ	5935011799105	5A910	7716895	.CONNECTOR,PLUG,ELEC.....	1
67	PAOZZ	5975007716634	19207	7716634	.NUT,COUPLING,ELECTR.....	1
68	PAOZZ	5365012471114	5A910	7722333	.SPACER,SLEEVE.....	1
69	PAOZZ	5310012483077	5A910	7723309	.NUT,PLAIN,HEXAGON.....	1
70	PAOZZ	5935012962196	77060	2977044	.CONNECTOR BODY,PLUG.....	1
71	XDOZZ		77060	12089134	.TERMINAL,LUG.....	2
72	PAOZZ	6250014329541	77060	12004264	.LAMPHOLDER.....	1

END OF FIGURE



342-1290

Figure 94. Overhead Cab Wiring Harness

SECTION II			TM9-2320-302-24P			
(1)	(2)	(3)	(4)	(5)	(6)	(7)
ITEM NO	SMR CODE	NSN	CAGEC	PART NUMBER	DESCRIPTION AND USABLE ON CODES(UOC)	QTY
GROUP 0613 HULL OR CHASSIS WIRING HARNESS						
FIG. 94 OVERHEAD CAB WIRING HARNESS						
1	PFFFF	6150013391180	64678	A06-18212-000	WIRING HARNESS, BRAN.....	1
2	PAOZZ	5935012962196	77060	2977044	.CONNECTOR BODY, PLUG.....	1
3	PAOZZ	5940007881586	77060	2965142	.TERMINAL, QUICK DISC.....	2
4	PAOZZ	5940008425353	77060	1839906	.SPLICE, CONDUCTOR.....	3
5	PAOZZ	5940013476142	77060	12066214	.TERMINAL, QUICK DISC.....	4
6	PAOZZ	5935013369924	77060	1204 0977	.CONNECTOR BODY, PLUG.....	2
7	XDOZZ		00779	60770-2	.CONNECTOR, PLUG, ELEC.....	4
8	PAOZZ	5940009563517	77060	2962987	.TERMINAL, QUICK DISC.....	2
9	PAOZZ	5940012347954	77060	2984528	.TERMINAL BODY, QUICK.....	2
10	PAOZZ	5325013366929	70485	5436	.GROMMET, NONMETALLIC.....	1
11	PAOZZ	5940003996676	19207	8338564	.TERMINAL SET, QUICK.....	1
12	PAOZZ	5970008338562	19207	8338562	.INSULATOR, BUSHING.....	1
13	PAOZZ	5935008338561	19207	8338561	.SHELL, ELECTRICAL CO.....	1
14	PAOZZ	5999000572929	19204	572929	.CONTACT, ELECTRICAL NO. 14 WIRE	1
GAGE.....						
15	PAOZZ	5310008338567	19207	8338567	.WASHER, SLOTTED.....	1
16	PAOZZ	5975012304370	5A910	8338566	.CABLE NIPPLE, ELECTR.....	1
17	PAOZZ	5935013371028	64678	1201 5271	.CONNECTOR BODY, PLUG.....	5
18	PAOZZ	5940013400587	77060	1202 0116	.TERMINAL, QUICK DISC.....	10
19	PAOZZ	5940013399566	77060	2965467	.TERMINAL, QUICK DISC.....	4

END OF FIGURE

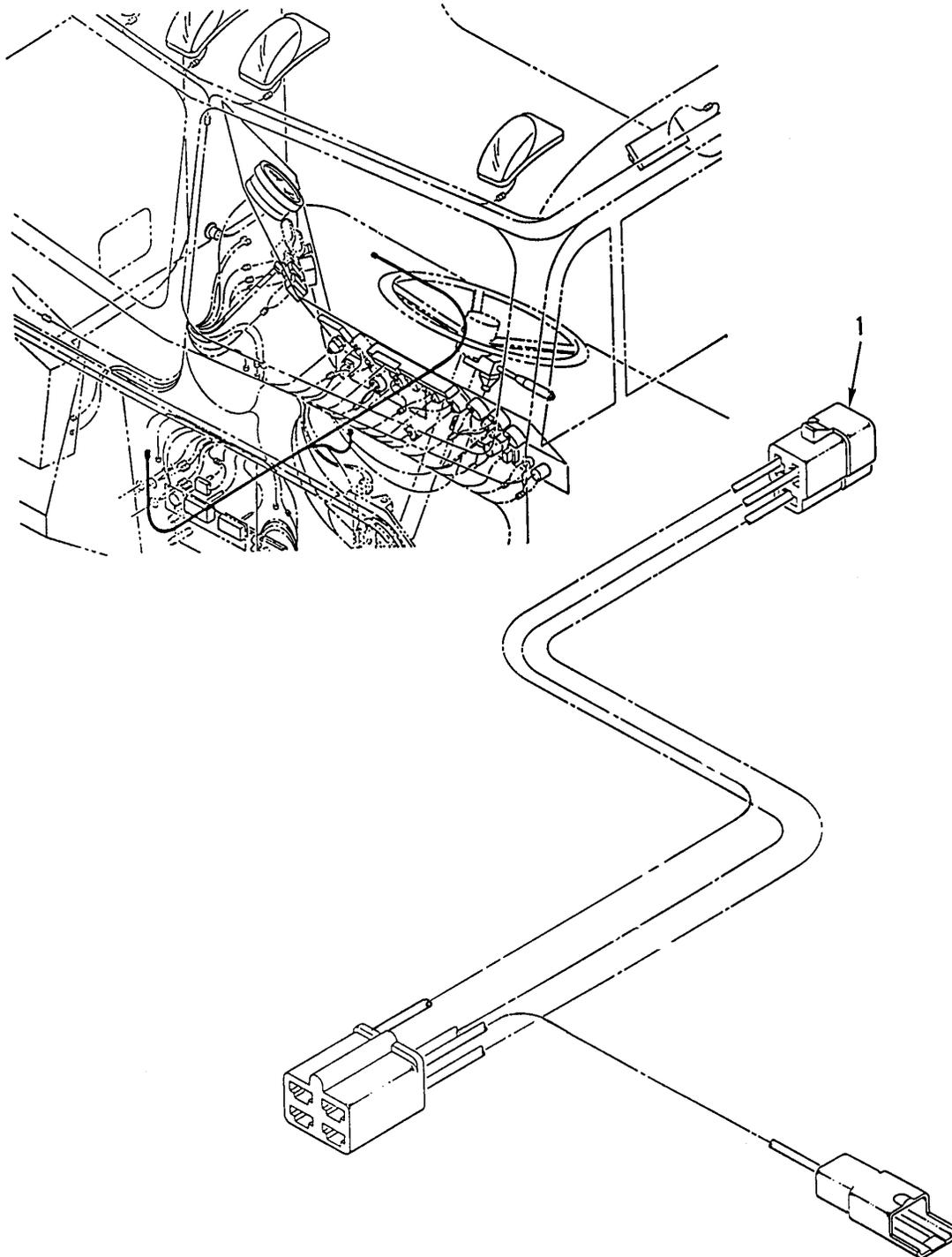

342-1327

Figure 95. Cab Floor Wiring Harness

SECTION II			TM9-2320-302-24P			
(1)	(2)	(3)	(4)	(5)	(6)	(7)
ITEM	SMR			PART		
NO	CODE	NSN	CAGEC	NUMBER	DESCRIPTION AND USABLE ON CODES(UOC)	QTY
					GROUP 0613 HULL OR CHASSIS WIRING HARNESS	
					FIG. 95 CAB FLOOR WIRING HARNESS	
1	PFFZZ	6150013366469	64678	A06-18214-000	WIRING HARNESS.....	1

END OF FIGURE

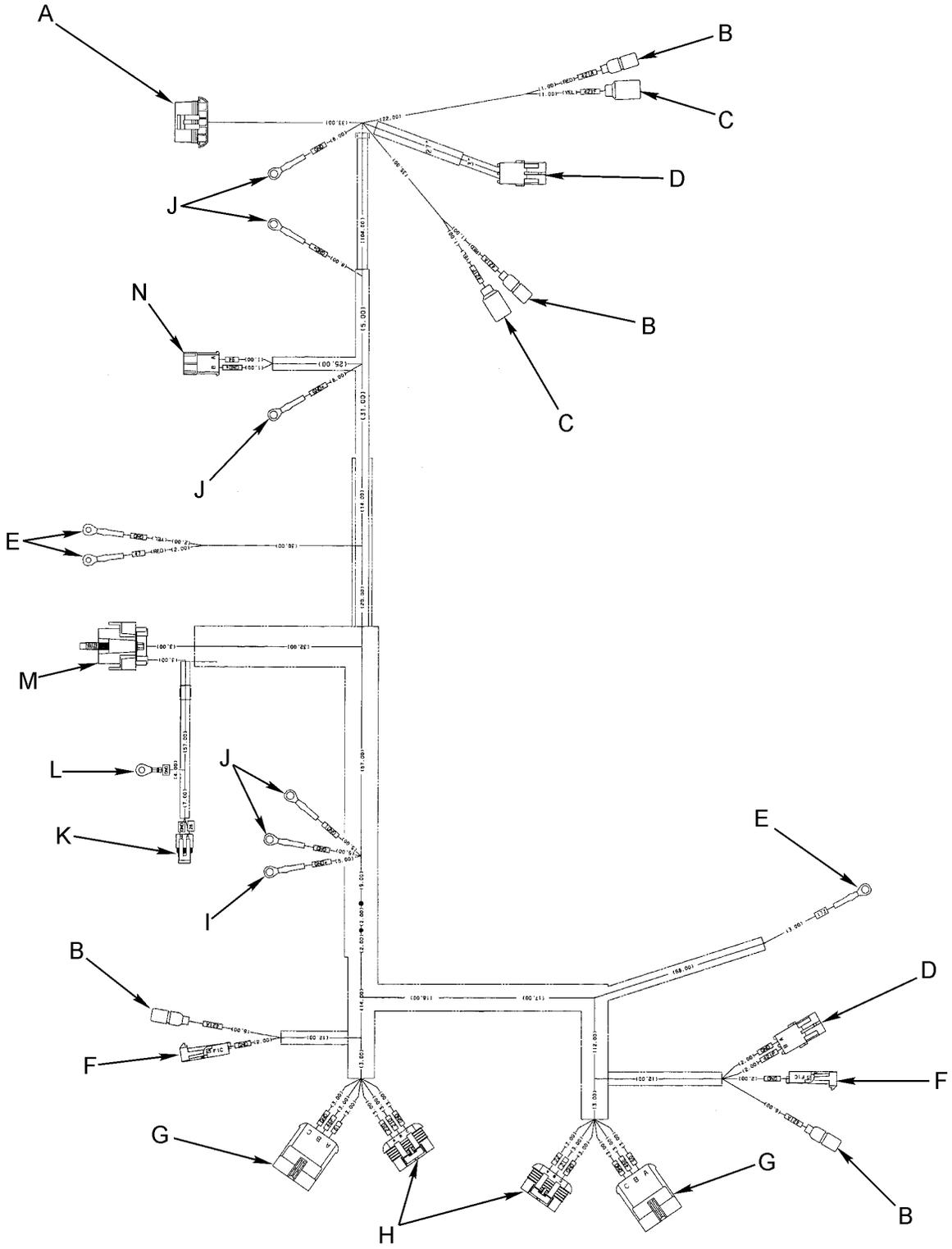
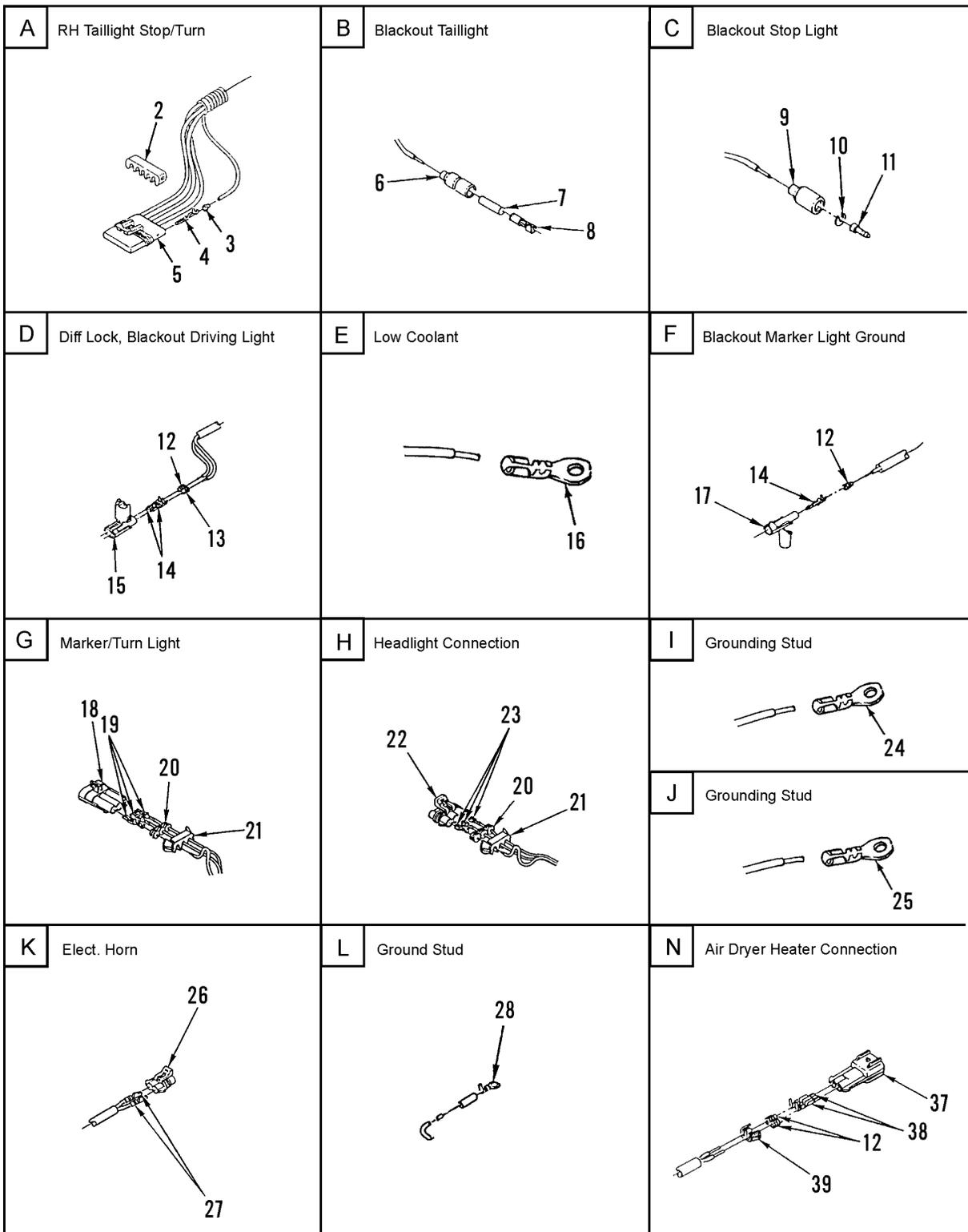

Figure 96. Chassis Wiring Harness (Sheet 1 of 3)



342-1498-2

*See Sheet 3 for View M

Figure 96. Chassis Wiring Harness (Sheet 2 of 3)

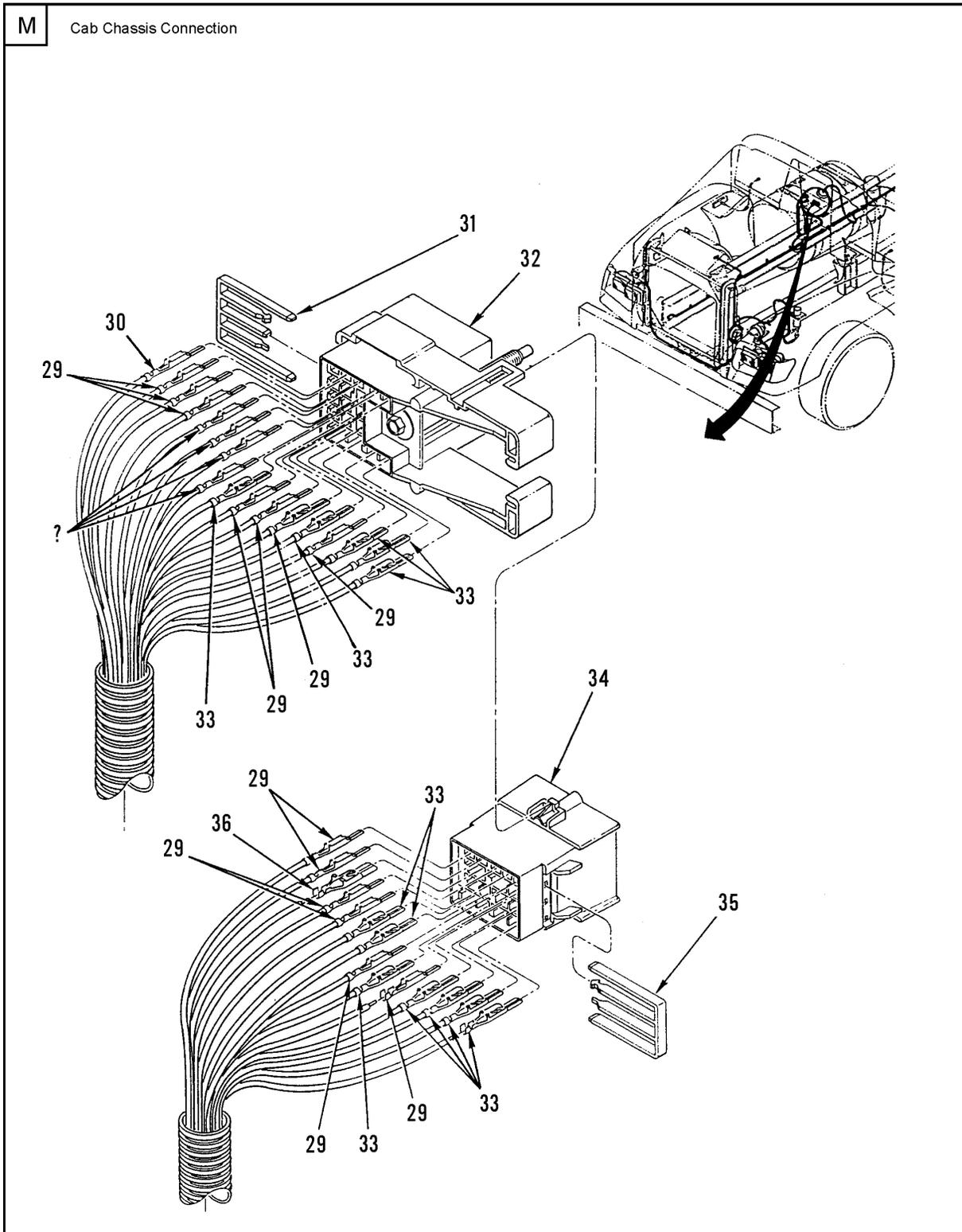

342-1498-3

Figure 96. Chassis Wiring Harness (Sheet 3 of 3)

SECTION II			TM9-2320-302-24P			
(1)	(2)	(3)	(4)	(5)	(6)	(7)
ITEM	SMR			PART		
NO	CODE	NSN	CAGEC	NUMBER	DESCRIPTION AND USABLE ON CODES(UOC)	QTY
					GROUP 0613 HULL OR CHASSIS WIRING HARNESS	
					FIG. 96 CHASSIS WIRING HARNESS	
1	XDFFF		64678	A06-22688-007	WIRING HARNESS, BRAN.....	1
2	PAOZZ	5940013473383	77060	1530 0017	.TERMINAL JUNCTION B.....	1
3	PAOZZ	5975013335974	77060	12015193	.SEAL CABLE.....	5
4	PFOZZ	5940014697988	77060	12129493	.TERMINAL, STUD.....	5
5	XDOZZ		77060	1208 4891	.CONNECTOR, MALE.....	1
6	PAOZZ	5935008338561	19207	8338561	.SHELL, ELECTRICAL CO.....	4
7	PAOZZ	5970008338562	19207	8338562	.INSULATOR, BUSHING.....	4
8	PAOZZ	5940003996676	19207	8338564	.TERMINAL SET, QUICK.....	4
9	PAOZZ	5975012304370	5A910	8338566	.CABLE NIPPLE, ELECTR.....	2
10	PAOZZ	5310008338567	19207	8338567	.WASHER, SLOTTED.....	2
11	PAOZA	5999000572929	19204	572929	.CONTACT, ELECTRICAL NO. 14 WIRE	2
					GAGE.....	
12	PAOZZ	5975012268078	77060	12010293	.BOOT, DUST AND MOIST.....	8
13	PAOZZ	5975012268078	77060	12010293	.BOOT, DUST AND MOIST.....	8
14	PAOZA	5999014064110	77060	12124582	.CONTACT, ELECTRICAL.....	2
15	PAOZZ	5935012144163	77060	1201 0973	.CONNECTOR BODY, PLUG.....	2
16	PAOZZ	5940001071481	77060	2973849	.TERMINAL, LUG.....	2
17	PAOZZ	5935013383532	77060	1201 0996	.CONNECTOR BODY, PLUG.....	2
18	XDOZZ		77060	12124686	.CONNECTOR BODY, PLUG.....	2
19	PAOZZ	5999013370088	77060	1206 4735	.CONTACT, ELECTRICAL.....	2
20	PAOZZ	5930013365334	77060	12052387	.BOOT, DUST AND MOIST.....	12
21	PAOZZ	5970013441070	77060	1204 5699	.INSULATOR ASSEMBLY.....	2
22	XDOZZ		77060	12124685	.CONNECTOR BODY, PLUG.....	2
23	PAOZZ	5940013423882	77060	1205 2455	.TERMINAL, QUICK DISC.....	3
24	PAOZZ	5940013366322	5R547	101028-B02	.TERMINAL, LUG.....	1
25	PAOZZ	5940001133145	77060	2984576	.TERMINAL, LUG.....	4
26	PAOZZ	5935013192334	77060	1204 0753	.CONNECTOR, PLUG, ELEC.....	1
27	PAOZZ	5940013705059	77060	12103881	.TERMINAL, QUICK DISC.....	2
28	PAOZZ	5940013661561	77060	12004433	.TERMINAL, LUG.....	1
29	PAOZZ	5940013400587	77060	1202 0116	.TERMINAL, QUICK DISC.....	10
30	PAOZZ	5940013919982	77060	12034047	.TERMINAL, LUG.....	1
31	PFOZZ	5970013417696	77060	1201 5968	.INSULATOR, PLATE.....	1
32	PAOZZ	5935013365400	77060	1202 0128	.CONNECTOR BODY, PLUG.....	1
33	PAOZZ	5940013421640	77060	1202 0120	.TERMINAL, QUICK DISC.....	12
34	PAOZZ	5935013366411	77060	1201 5966	.CONNECTOR BODY, RECE.....	1
35	PFOZZ	5970013417697	77060	1201 5969	.INSULATOR, PLATE.....	1
36	PAOZZ	5940013400588	77060	1202 0126	.TERMINAL, QUICK DISC.....	1
37	PAOZZ	5935013393227	77060	1530 0002	.CONNECTOR BODY, PLUG.....	1
38	PAOZZ	5940014621717	77060	12048159	.TERMINAL, LUG.....	2
39	PAOZZ	5340013326696	77060	1530 0014	.STRAP, RETAINING.....	1

END OF FIGURE

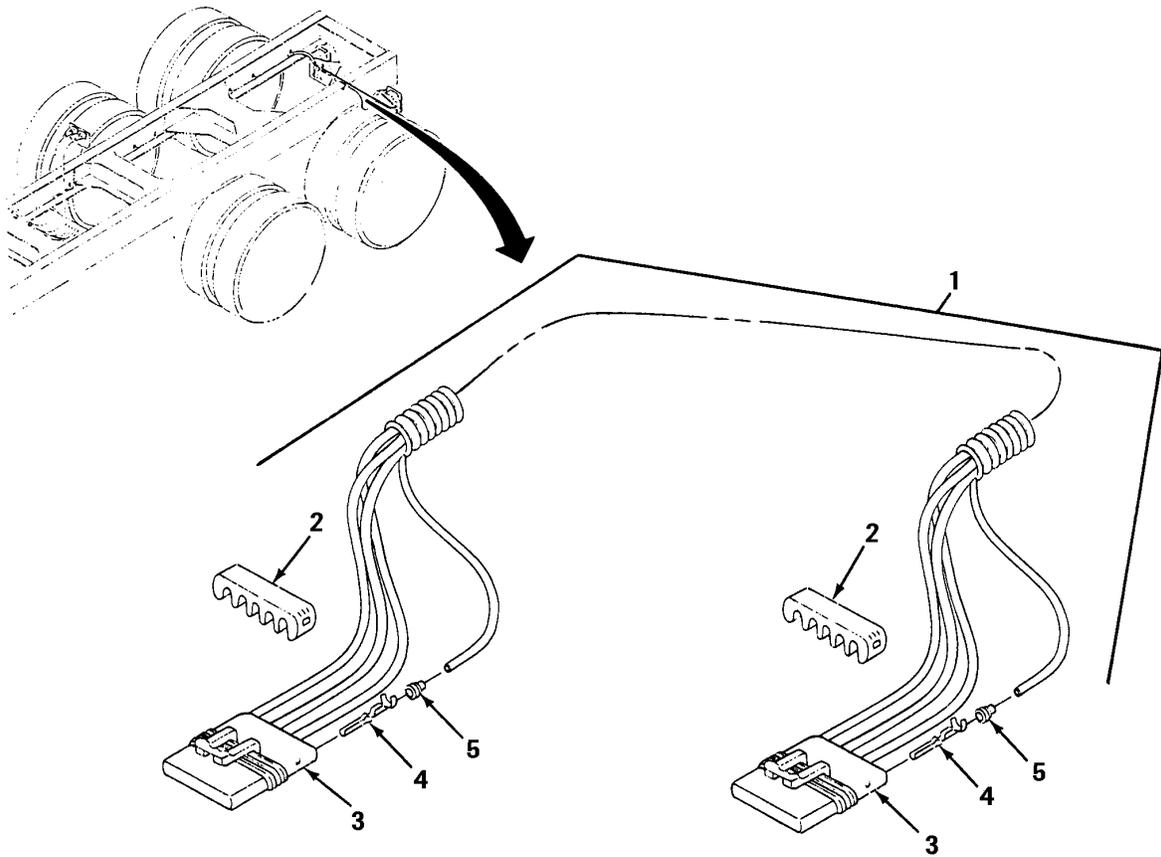

342-1328

Figure 97. Stop/Tail/Backup Lights Wiring Harness

SECTION II			TM9-2320-302-24P			
(1)	(2)	(3)	(4)	(5)	(6)	(7)
ITEM	SMR			PART		
NO	CODE	NSN	CAGEC	NUMBER	DESCRIPTION AND USABLE ON CODES(UOC)	QTY
					GROUP 0613 HULL OR CHASSIS WIRING HARNESS	
					FIG. 97 STOP/TAIL/BACKUP LIGHTS WIRING HARNESS	
1	PFOOO	6150014786501	64678	A06-18319-002	WIRING HARNESS.....	1
2	PFOZZ	5940013473383	77060	15300017	.TERMINAL JUNCTION B.....	2
3	PFOZZ	5935014414919	77060	12065862	.CONNECTOR, PLUG, ELEC.....	2
4	PFOZZ	5940014697988	77060	12129493	.TERMINAL, STUD.....	8
5	PAOZZ	5975013335974	77060	12015193	.SEAL CABLE.....	8

END OF FIGURE

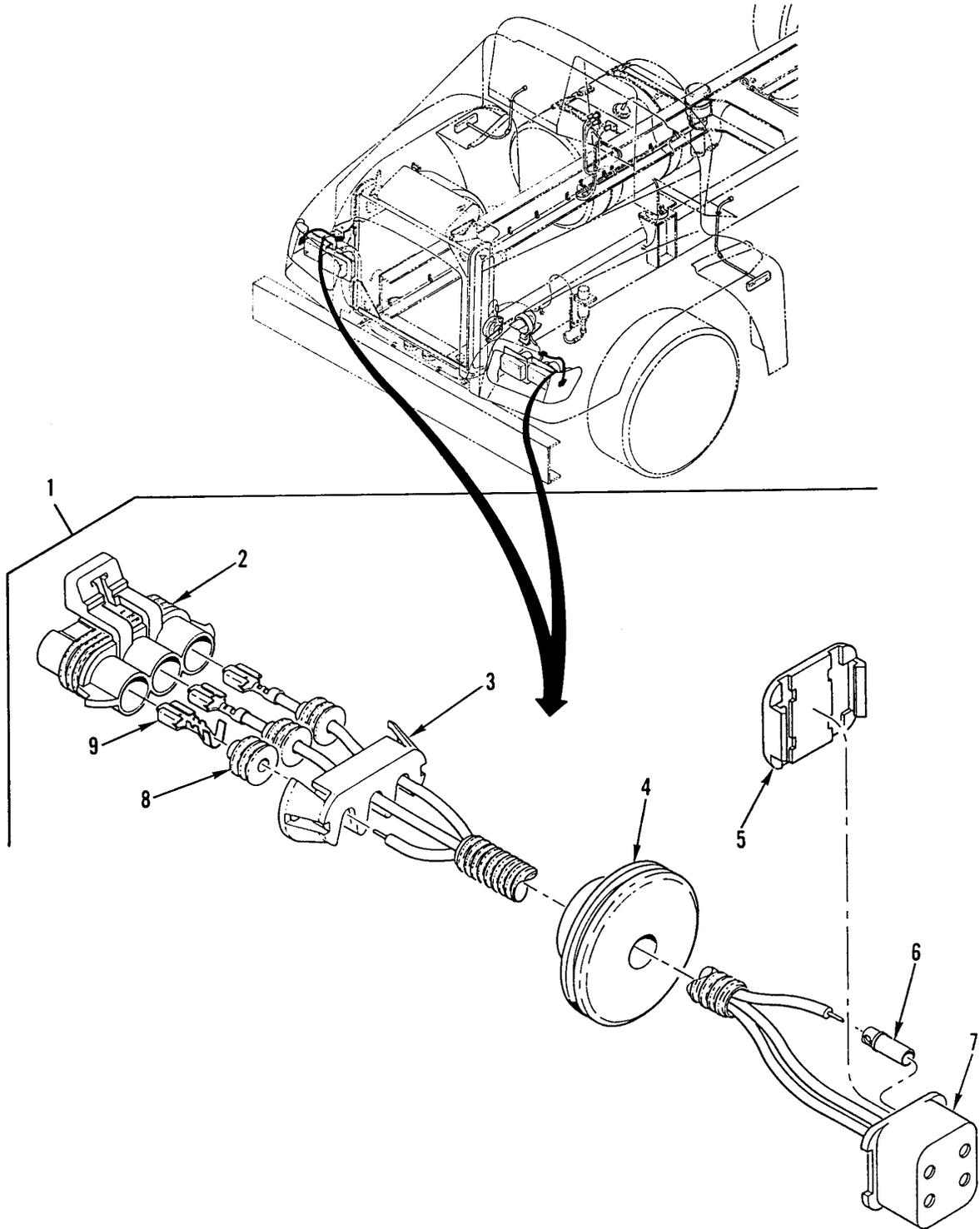

342-1292

Figure 98. Turn Signal/Marker Light Wiring Harness

SECTION II			TM9-2320-302-24P			
(1)	(2)	(3)	(4)	(5)	(6)	(7)
ITEM	SMR			PART		
NO	CODE	NSN	CAGEC	NUMBER	DESCRIPTION AND USABLE ON CODES(UOC)	QTY
					GROUP 0613 HULL OR CHASSIS WIRING HARNESS	
					FIG. 98 TURN SIGNAL/MARKER LIGHT WIRING HARNESS	
1	PFOOO	6150014786819	64678	A06-17188-001	WIRING HARNESS.....	2
2	XDOZZ		77060	1212 4685	.CONNECTOR BODY,PLUG.....	1
3	PAOZZ	5970013441070	77060	1204 5699	.INSULATOR ASSEMBLY.....	1
4	PAOZZ	5325013370387	81834	01-9233-71	.GROMMET, NONMETALLIC.....	1
5	PAOZZ	5340013584652	D8129	1 04 00 23727 0	.COVER, ACCESS.....	1
6	PAOZZ	5999123019403	D8129	10239219160	.CONTACT, ELECTRICAL.....	3
7	PAOZZ	3040013374160	D8129	10400237241	.HOUSING, MECHANICAL.....	1
8	PAOZZ	5930013365334	77060	12052387	.BOOT, DUST AND MOIST.....	3
9	PAOZZ	5940013423882	77060	1205 2455	.TERMINAL, QUICK DISC.....	3

END OF FIGURE

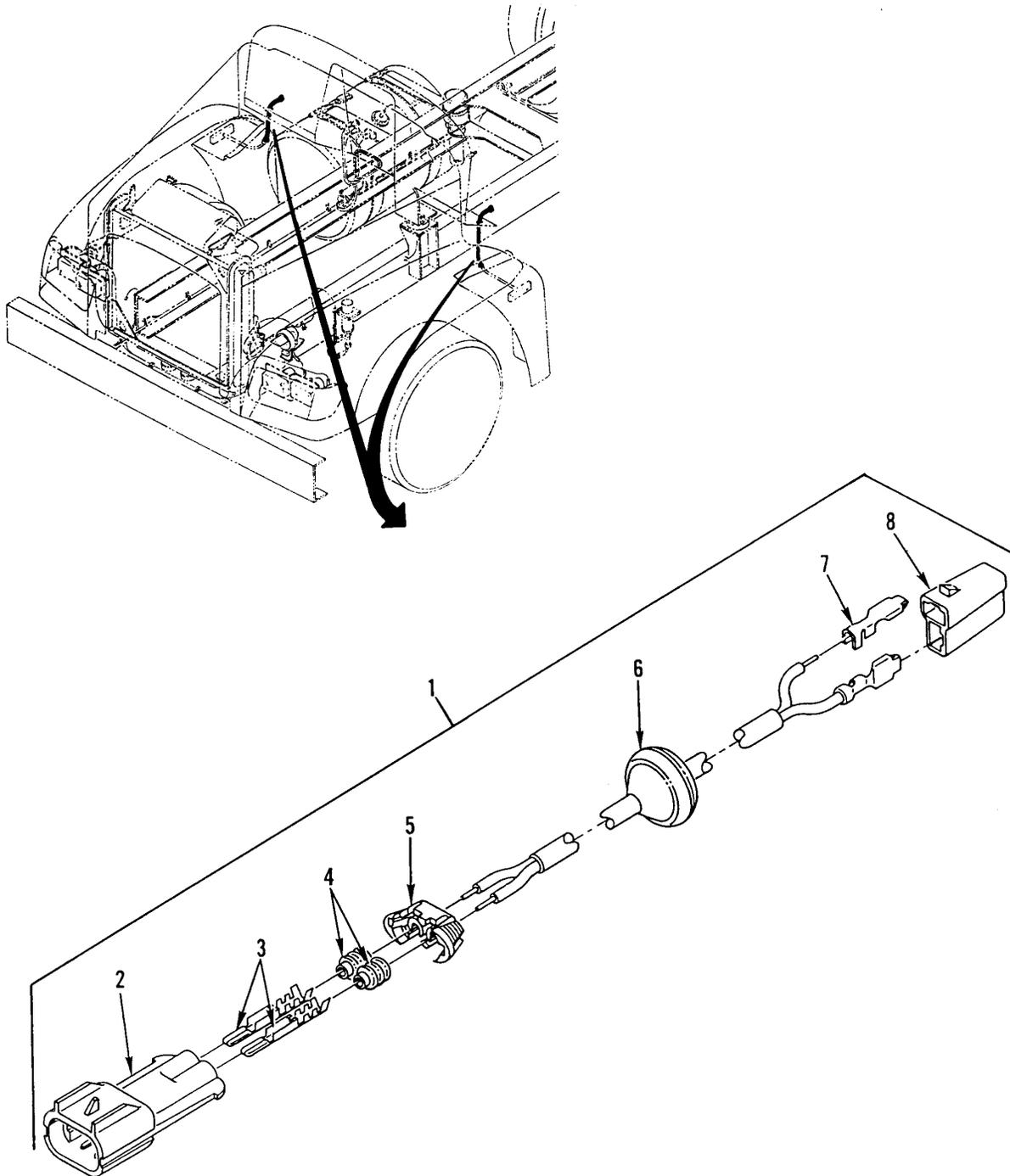

342-1293

Figure 99. Turn Signal (Thru Deck) Wiring Harness

SECTION II			TM9-2320-302-24P			
(1)	(2)	(3)	(4)	(5)	(6)	(7)
ITEM	SMR			PART		
NO	CODE	NSN	CAGEC	NUMBER	DESCRIPTION AND USABLE ON CODES(UOC)	QTY
					GROUP 0613 HULL OR CHASSIS WIRING HARNESS	
					FIG. 99 TURN SIGNAL (THRU DECK) WIRING HARNESS	
1	PFOOO	6150013366472	64678	A06-17569-000	WIRING HARNESS.....	2
2	PAOZZ	5935013393227	77060	1530 0002	.CONNECTOR BODY,PLUG.....	1
3	PAOZZ	5940013400586	77060	1204 0559	.TERMINAL,QUICK DISC.....	2
4	PAOZZ	5975013335974	77060	12015193	.SEAL CABLE.....	2
5	PAOZZ	5340013326696	77060	1530 0014	.STRAP,RETAINING.....	1
6	PAOZZ	5325013366929	70485	5436	.GROMMET,NONMETALLIC.....	1
7	PAOZZ	5940007881586	77060	2965142	.TERMINAL,QUICK DISC.....	2
8	PAOZZ	5935011618087	77060	2973781	.CONNECTOR BODY,PLUG.....	1

END OF FIGURE

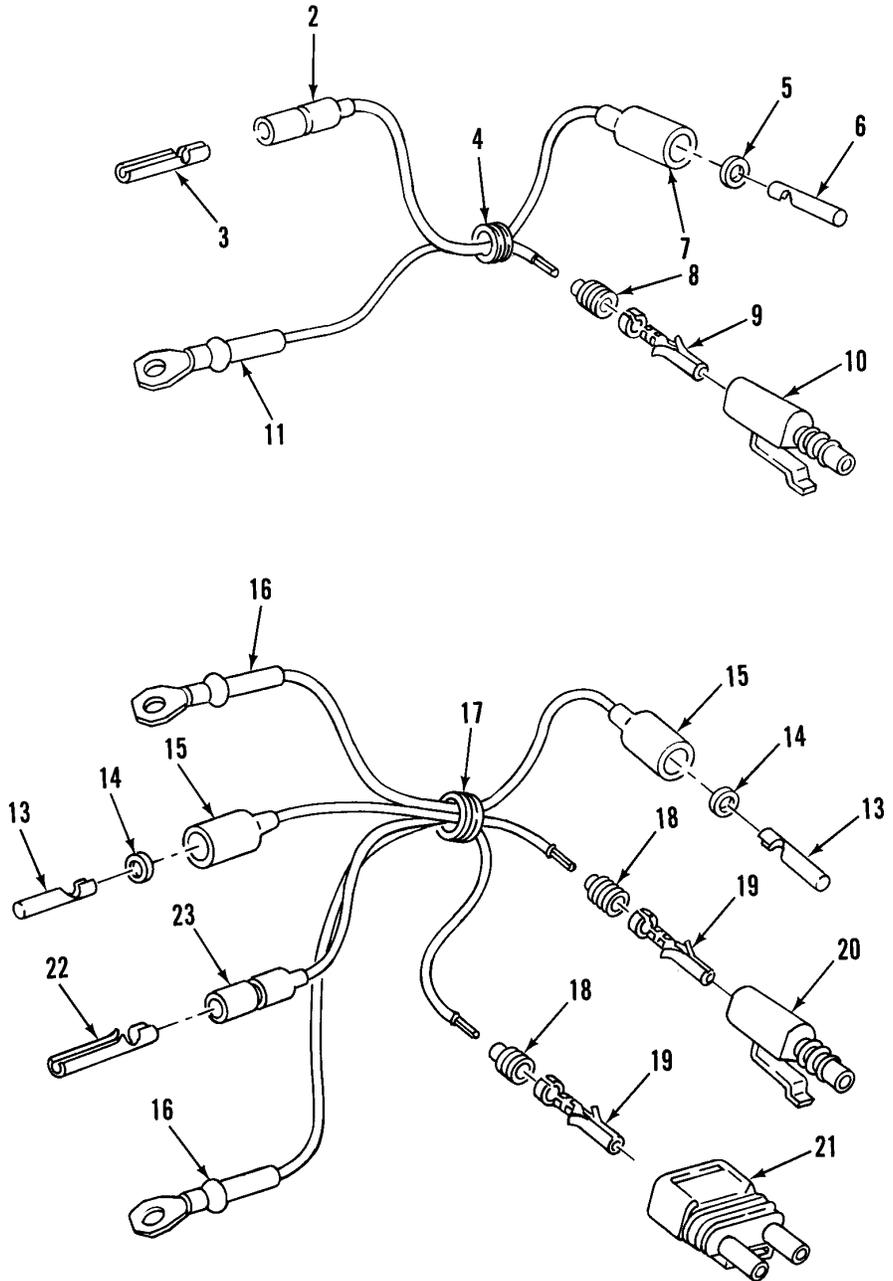

342-1294

Figure 100. Blackout Lights Wiring Harness

SECTION II			TM9-2320-302-24P			
(1)	(2)	(3)	(4)	(5)	(6)	(7)
ITEM NO	SMR CODE	NSN	CAGEC	PART NUMBER	DESCRIPTION AND USABLE ON CODES(UOC)	QTY
					GROUP 0613 HULL OR CHASSIS WIRING HARNESS	
					FIG. 100 BLACKOUT LIGHTS WIRING HARNESS	
1	PFOOO	6150014126544	64678	A06-20074-001	CABLE ASSEMBLY,SPEC HEADLIGHT & BLACKOUT MARKER RH.....	1
2	PAOZZ	5935008338561	19207	8338561	.SHELL,ELECTRICAL CO.....	1
3	PAOZZ	5940003996676	19207	8338564	.TERMINAL SET,QUICK.....	1
4	PAOZZ	5325004327380	76385	Z-3003	.GROMMET,NONMETALLIC.....	1
5	PAOZZ	5310008338567	19207	8338567	.WASHER,SLOTTED.....	1
6	PAOZA	5999000572929	19204	572929	.CONTACT,ELECTRICAL.....	1
7	PAOZZ	5975012304370	5A910	8338566	.CABLE NIPPLE,ELECTR.....	1
8	PAOZZ	5975013335974	77060	12015193	.SEAL CABLE.....	1
9	PAOZZ	5999012149682	77060	1201 0182	.CONTACT,ELECTRICAL.....	1
10	PAOZZ	5935012912814	10988	L124720	.CONNECTOR,PLUG,ELEC.....	1
11	PAOZZ	5940013291096	77060	12004435	.TERMINAL,LUG.....	1
12	PFOOO	6150014126546	64678	A06-20074-000	CABLE ASSEMBLY,SPEC HEADLIGHT & BLACKOUT MARKER LH.....	1
13	PAOZZ	5999000572929	19204	572929	.CONTACT,ELECTRICAL.....	2
14	PAOZZ	5310008338567	19207	8338567	.WASHER,SLOTTED.....	2
15	PAOZZ	5975012304370	5A910	8338566	.CABLE NIPPLE,ELECTR.....	2
16	PAOZZ	5940013291096	77060	12004435	.TERMINAL,LUG.....	2
17	PAOZZ	5325004327380	76385	Z-3003	.GROMMET,NONMETALLIC.....	1
18	PAOZZ	5975013335974	77060	12015193	.SEAL CABLE.....	3
19	PAOZZ	5999012149682	77060	1201 0182	.CONTACT,ELECTRICAL.....	3
20	PAOZZ	5935012912814	10988	L124720	.CONNECTOR,PLUG,ELEC.....	1
21	PAOZZ	5935012145259	77060	1201 5792	.CONNECTOR BODY,PLUG.....	1
22	PAOZZ	5940003996676	19207	8338564	.TERMINAL SET,QUICK.....	1
23	PAOZZ	5935008338561	19207	8338561	.SHELL,ELECTRICAL CO.....	1

END OF FIGURE

1
2 thru 35

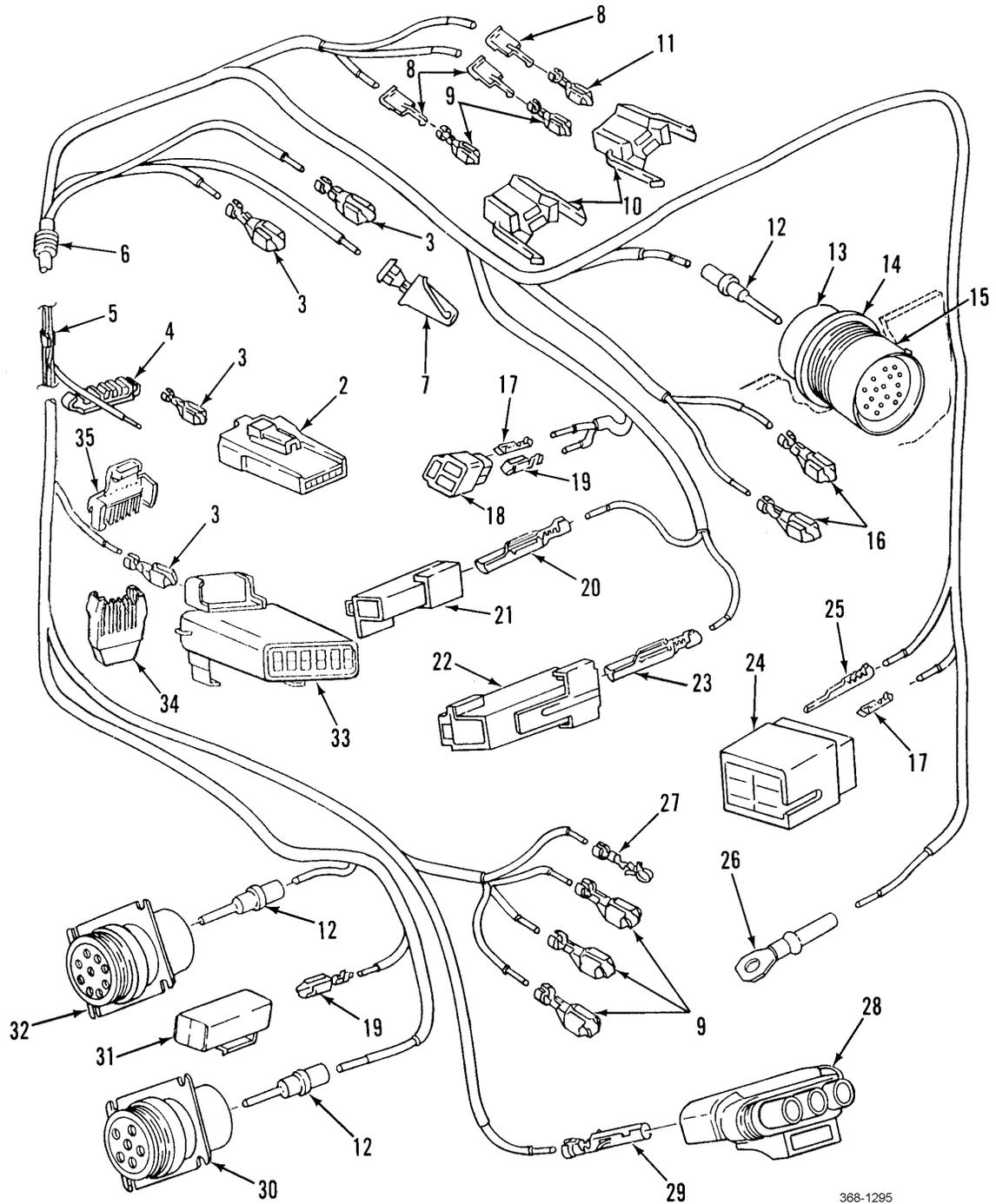
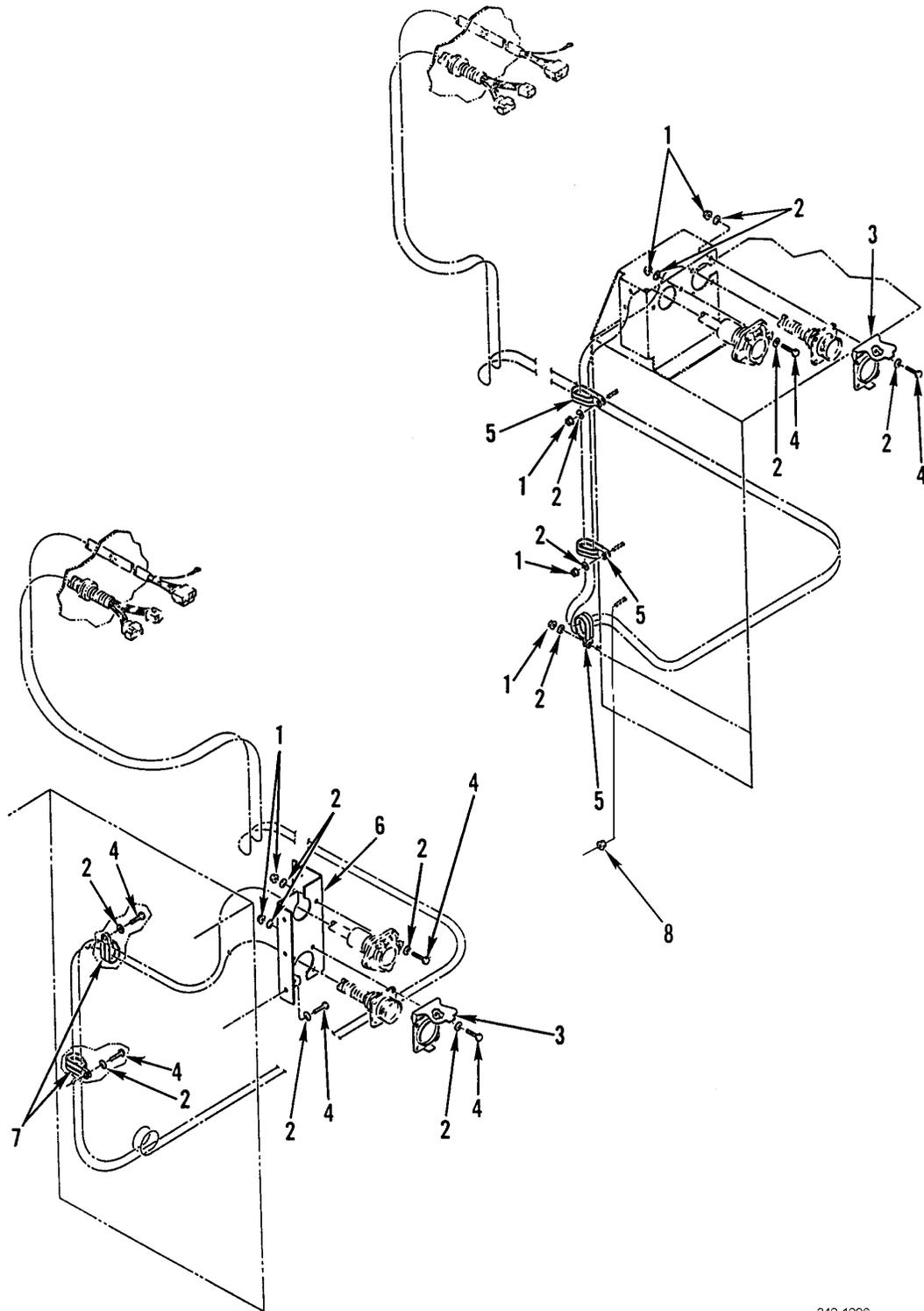

Figure 101. Harness Overlay

SECTION II			TM9-2320-302-24P			
(1)	(2)	(3)	(4)	(5)	(6)	(7)
ITEM NO	SMR CODE	NSN	CAGEC	PART NUMBER	DESCRIPTION AND USABLE ON CODES(UOC)	QTY
GROUP 0613 HULL OR CHASSIS WIRING HARNESS						
FIG. 101 HARNESS OVERLAY						
1	PAFFF		64678	A06-33155-000	WIRING HARNESS.....	1
2	XDFZZ		77060	12064993	.CONNECTOR, PLUG, ELEC 6 PIN.....	1
3	XDFZZ		77060	12089649	.TERMINAL, FEMALE #18 18/20 AWG.....	11
4	XDFZZ		77060	12066170	.LOCK, SECONDARY 6 PIN.....	1
5	PAFZZ	5940008425353	77060	1839906	.SPLICE, CONDUCTOR.....	5
6	PAFZZ	5940013476143	77060	2965439	.TERMINAL, QUICK DISC 18/20 AWG.....	1
7	PAFZZ	5935013366900	64678	681 545 16 28	.CONNECTOR BODY, PLUG 6 PIN.....	2
8	XDFZZ		77060	12015869	.TERMINAL, FEMALE #18 18/20 AWG.....	6
9	XDFZZ		77060	12020035	.TERMINAL, FEMALE #18 18 AWG.....	3
10	PAFZZ	5940013366325	2E480	059056	.TERMINAL, LUG.....	8
11	PAFZZ	5935010234871	36378	1003292-07	.CONNECTOR BODY, RECE 16 PIN.....	2
12	PAFZZ	5999011539432	04071	R354273-11	.CONTACT, ELECTRICAL 16/18 AWG.....	2
13	PAFZZ	5310010867726	11139	112263-90	.NUT, PLAIN, HEXAGON.....	1
14	PAFZZ	5310010810799	11139	112264	.WASHER, LOCK.....	1
15	XDFZZ		11139	HD34-24-31PT	.CONNECTOR, PLUG, ELEC 31 PIN.....	1
16	PAFZZ	5999012163648	12361	7-689-000704	.CONTACT, ELECTRICAL 16/18 AWG.....	24
17	XDFZZ		77060	12015345	.CONNECTOR, PLUG, ELEC 6 PIN.....	1
18	PAFZZ	5940013919982	77060	12034047	.TERMINAL, LUG 18/20 AWG.....	4
19	PAFZZ	5940001133145	96906	MS20659-163	.TERMINAL, LUG #10 STUD X 14 AWG.....	1
20	XDFZZ		64678	680 545 42 26	.TERMINAL, FEMALE 14/16 AWG.....	2
21	XDFZZ		77060	12020119	.TERMINAL, MALE 18/20 AWG.....	1
22	XDFZZ		77060	12015987	.CONNECTOR, PLUG, ELEC 1 PIN.....	1
23	PAFZZ	5940013431262	77060	12124304	.TERMINAL, QUICK DISC 14/16 AWG.....	1
24	XDFZZ		77060	12015952	.CONNECTOR, PLUG, ELEC 1 PIN.....	1
25	PAFZZ	5935012922336	77060	12015793	.CONNECTOR, PLUG, ELEC 3 PIN.....	1
26	PAFZZ	5999013234929	77060	1208 9188	.CONTACT, ELECTRICAL 18/20 AWG.....	3
27	PAFZZ	5975013105011	77060	12015323	.BOOT, DUST AND MOIST 16/18 AWG.....	2
28	XDFZZ		77060	2977373	.CONNECTOR, PLUG, ELEC 2 PIN.....	1
29	PAFZZ	5940013374910	77060	2965141	.TERMINAL, QUICK DISC 18/20 AWG.....	2
30	PAFZZ	5935014476852	11139	HD10-6-12P	.CONNECTOR, RECEPTACL 6 PIN.....	1
31	XDFZZ		11139	HD10-9-96P	.CONNECTOR, PLUG, ELEC 9 PIN.....	1
32	XDFZZ		77060	12048346	.CONNECTOR, PLUG, ELEC 10 PIN.....	1
33	XDFZZ		77060	12048344	.LOCK, SECONDARY 10 PIN.....	1
34	XDFZZ		77060	12048345	.LOCK, SECONDARY 10 PIN.....	1
35	XDFZZ		77060	12048345	.LOCK, SECONDARY.....	1

END OF FIGURE



342-1296

Figure 102. Trailer Hookup Installation

SECTION II			TM9-2320-302-24P			
(1)	(2)	(3)	(4)	(5)	(6)	(7)
ITEM	SMR			PART		
NO	CODE	NSN	CAGEC	NUMBER	DESCRIPTION AND USABLE ON CODES(UOC)	QTY
					GROUP 0613 HULL OR CHASSIS WIRING HARNES	
					FIG. 102 TRAILER HOOKUP INSTALLATION	
1	PAOZZ	5310013336436	64678	23-10340-125	NUT, SELF-LOCKING, AS 1/4-20.....	2
2	PAOZZ	5310008094058	96906	MS27183-10	WASHER, FLAT.....	6
3	PAOZZ	5935007731428	64678	419 546 70 35	COVER, ELECTRICAL CO.....	1
4	PAOZZ	5305002253843	80204	B1821BH025C100N	SCREW, CAP, HEXAGON H.....	6
5	PAOZZ	5340012530128	01276	900729-24	CLAMP, LOOP.....	3
6	XDOZZ		64678	06-18203-001	BRACKET, DOUBLE ANGL.....	1
7	PAOZZ	5340013367794	64678	23-11358-040	CLAMP, LOOP 1 1/4 IN, 2 TUBES.....	3
8	PAOZZ	5310011511036	45152	115307A	NUT, SELF-LOCKING, EX 3/8-16.....	1

END OF FIGURE

1	16
2 thru 15	17 thru 26

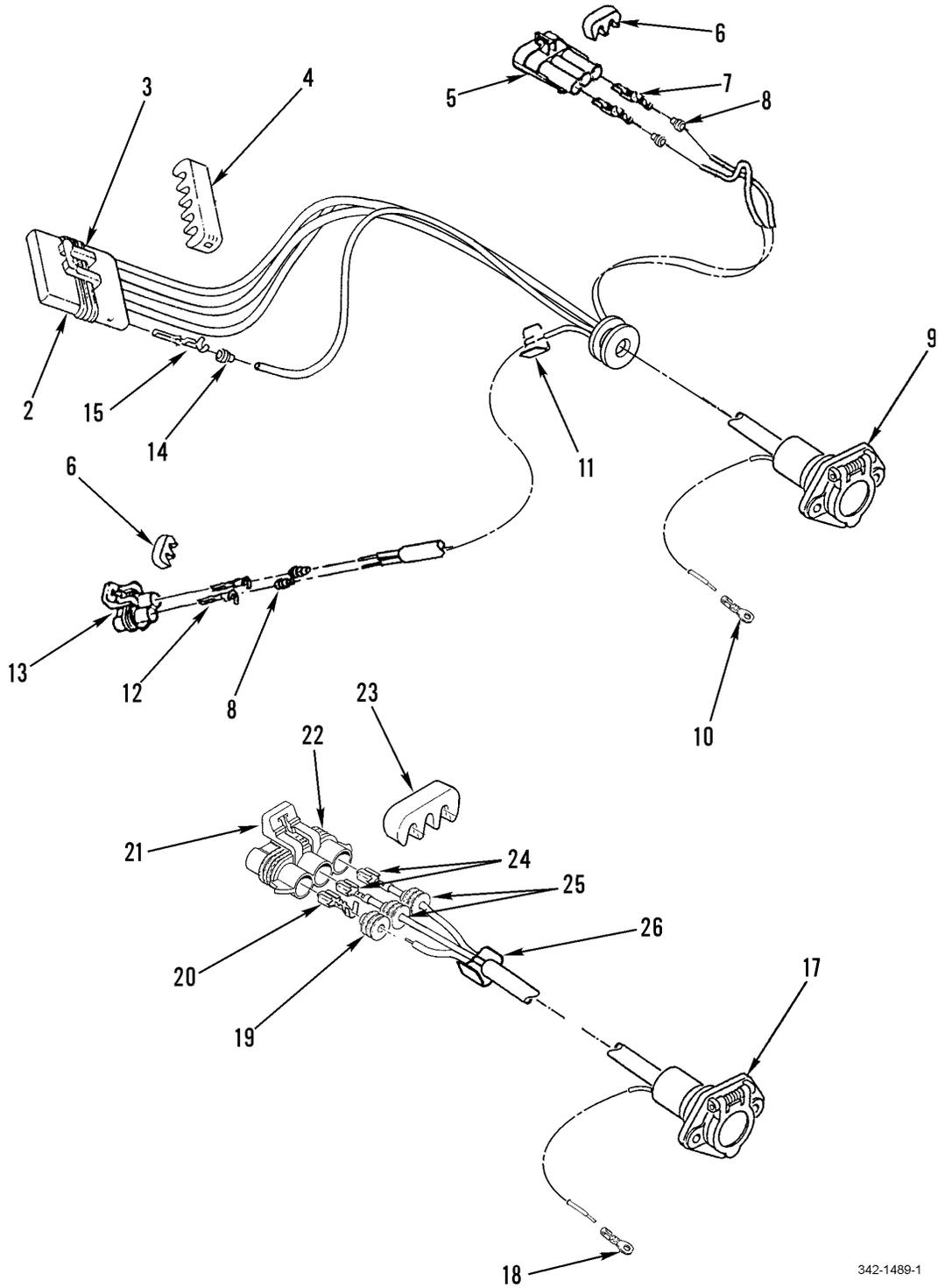

342-1489-1

Figure 103. Trailer Hookup Cable and Receptacle Cable (Sheet 1 of 2)

27	54
28 thru 53	55 thru 63

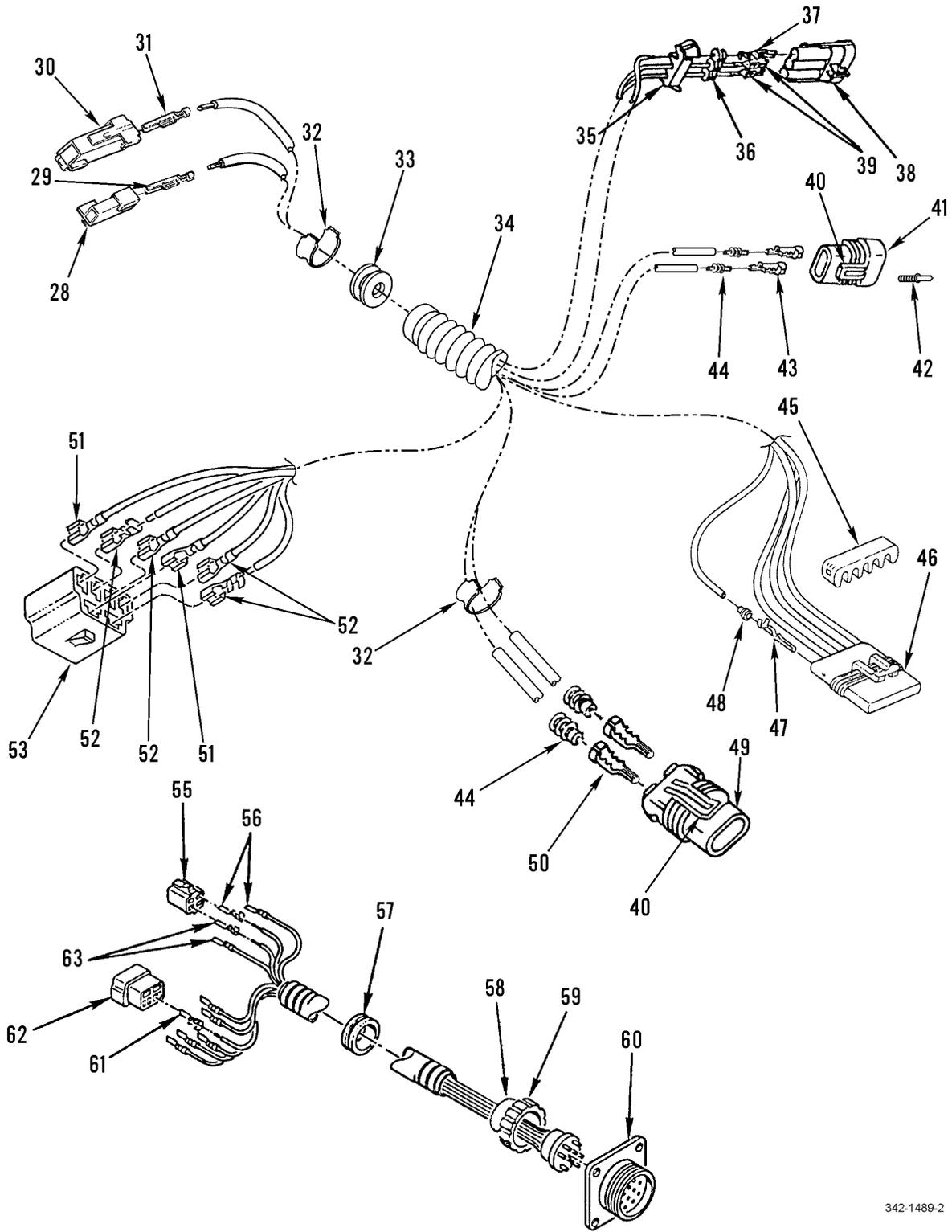

Figure 103. Trailer Hookup Cable and Receptacle Cable (Sheet 2 of 2)

SECTION II			TM9-2320-302-24P			
(1)	(2)	(3)	(4)	(5)	(6)	(7)
ITEM NO	SMR CODE	NSN	CAGEC	PART NUMBER	DESCRIPTION AND USABLE ON CODES(UOC)	QTY
					GROUP 0613 HULL OR CHASSIS WIRING HARNESS	
					FIG. 103 TRAILER HOOKUP CABLE AND RECEPTACLE CABLE	
1	PFOOO	6150014786824	64678	A06-26871-008	CABLE ASSEMBLY, SPEC.....	1
2	XDOZZ		77060	12129600	.CONNECTOR, BODY, ELEC.....	1
3	XDOZZ		77060	12092733	.RETAINER, ELECTRICAL.....	1
4	PFOZZ	5935014711122	77060	12020833	.POLARIZING KEY, ELEC.....	2
5	XDOZZ		77060	12065863	.CONNECTOR BODY, ELEC.....	1
6	XDOZZ		77060	12059897	.RETAINER, ELECTRICAL.....	2
7	XDOZZ		77060	12052172	.TERMINAL, LUG.....	2
8	XDOZZ		77060	12065703	.GROMMET, NONMETALLIC.....	4
9	PAOZZ	5935014787607	64466	16-726	.CONNECTOR, RECEPTACL.....	1
10	PAOZZ	5940013367056	77060	12004439	.TERMINAL, LUG.....	1
11	PAOZZ	5940008425353	77060	1839906	.SPLICE, CONDUCTOR.....	2
12	XDOZZ		77060	12052139	.TERMINAL, LUG.....	2
13	PAOZZ	5935013369923	64678	1205 2613	.CONNECTOR BODY, PLUG.....	1
14	XDOZZ		77060	12059260	.GROMMET, NONMETALLIC.....	4
15	XDOZZ		77060	12048254	.TERMINAL, LUG.....	4
16	PFOOO	6150014786828	64678	A06-26871-000	CABLE ASSEMBLY, SPEC MOUNTED BEHIND CAB.....	1
17	PAOZZ	5935014787605	64466	16 826	.CONNECTOR, RECEPTACL.....	1
18	PAOZZ	5940013367056	77060	12004439	.TERMINAL, LUG.....	1
19	PAOZZ	5930013365334	77060	12052387	.BOOT, DUST AND MOIST.....	1
20	XDOZZ		77060	12064737	.TERMINAL, LUG.....	1
21	PAOZZ	5970013441070	77060	12045699	.INSULATOR ASSEMBLY.....	1
22	XDOZZ		77060	12124686	.CONNECTOR BODY, PLUG.....	1
23	XDOZZ		77060	1202 0833	.LOCK, TERMINAL LUG.....	1
24	XDOZZ		77060	12064736	.TERMINAL, LUG.....	2
25	XDOZZ		77060	12059260	.GROMMET, NONMETALLIC.....	2
26	XDOZZ		77060	5290433	.SPLICE, CONDUCTOR.....	1
27	PFOOO	6150014786810	64678	A06-27385-135	CABLE ASSEMBLY, SPEC.....	1
28	XDOZZ		77060	12015952	.CONNECTOR, PLUG, ELEC 1 PIN.....	1
29	PAOZZ	5940013410525	77060	12084595	.TERMINAL, QUICK DISC.....	1
30	XDOZZ		77060	12015987	.CONNECTOR, PLUG, ELEC 1 PIN.....	1
31	PAOZZ	5940013420558	77060	1203 3820	.TERMINAL, QUICK DISC.....	1
32	PAOZZ	5940008425353	77060	1839906	.SPLICE, CONDUCTOR.....	3
33	PAOZZ	5325010460769	70485	2802	.GROMMET, NONMETALLIC 1.312 ID, 1.625 OD.....	1
34	MOOZZ		64678	48-02217-100X132	.CONDUIT, NONMETALLIC.....	1
35	PAOZZ	5970013441070	77060	12045699	.INSULATOR ASSEMBLY.....	1
36	XDOZZ		77060	12059257	.BOOT, DUST AND MOIST.....	2
37	XDOZZ		77060	12059260	.GROMMET, NONMETALLIC.....	1
38	XDOZZ		77060	12124685	.CONNECTOR BODY, PLUG.....	1
39	XDOZZ		77060	12052456	.TERMINAL, LUG.....	3
40	XDOZZ		77060	12059897	.RETAINER, ELECTRICAL.....	2
41	PAOZZ	5935013369923	64678	1205 2613	.CONNECTOR BODY, PLUG.....	1
42	XDOZZ		77060	12066082	.SEAL/CAVITY.....	2
43	XDOZZ		77060	12052139	.TERMINAL, LUG.....	2
44	XDOZZ		77060	12065703	.GROMMET, NONMETALLIC.....	4

SECTION II			TM9-2320-302-24P			
(1)	(2)	(3)	(4)	(5)	(6)	(7)
ITEM NO	SMR CODE	NSN	CAGEC	PART NUMBER	DESCRIPTION AND USABLE ON CODES(UOC)	QTY
45	XDOZZ		77060	15300016	.INSULATOR CAP.....	1
46	XDOZZ		77060	12129565	.CONNECTOR BODY,RECE.....	1
47	PAOZZ	5940014467607	77060	12077413	.TERMINAL,QUICK DISC.....	4
48	PAOZZ	5975013335974	77060	12015193	.SEAL CABLE.....	4
49	XDOZZ		77060	12065863	.CONNECTOR BODY,ELEC.....	1
50	XDOZZ		77060	12052172	.TERMINAL,LUG.....	2
51	PAOZZ	5940013009339	77060	2984807-5	.TERMINAL,QUICK DISC.....	2
52	PAOZZ	5940013366326	77060	2965143	.TERMINAL,QUICK DISC.....	4
53	PAOZZ	5935013365401	77060	2973890	.CONNECTOR BODY,RECE.....	1
54	PFOOO	6150013382076	64678	A06-18016-000	CABLE ASSEMBLY,SPEC MOUNTED BEHIND CAB.....	1
54	PAOOO	6150013417737	64678	A06-18016-002	CABLE ASSEMBLY,SPEC MOUNTED AT END OF FRAME.....	1
55	PAOZZ	5935010657983	77060	2977048	.CONNECTOR,PLUG,ELEC.....	1
56	PAOZZ	5940007881586	77060	2965142	.TERMINAL,QUICK DISC.....	2
57	PAOZZ	5325001749341	70485	2872	.GROMMET,NONMETALLIC.....	1
58	PAOZZ	5365012471114	5A910	7722333	.SPACER,SLEEVE.....	1
59	PAOZZ	5310012483077	64678	419 990 70 54	.NUT,PLAIN,HEXAGON.....	1
60	PAOZA	5935008463884	96906	MS75021-2	.CONNECTOR,RECEPTACL.....	1
61	PAOZZ	5940009563517	77060	2962987	.TERMINAL,QUICK DISC.....	6
62	PAOZZ	5935013365394	77060	6288700	.CONNECTOR BODY,PLUG.....	1
63	PAOZZ	5940007881586	77060	2965142	.TERMINAL,QUICK DISC.....	2

END OF FIGURE

1
|
2 thru 17

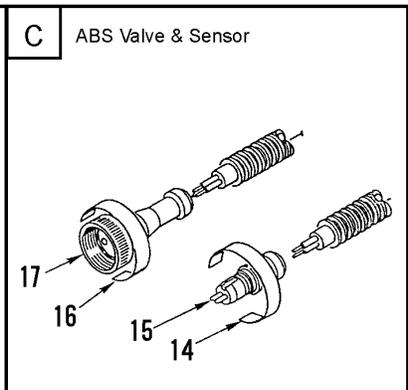
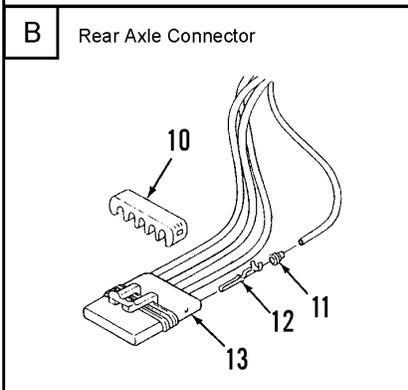
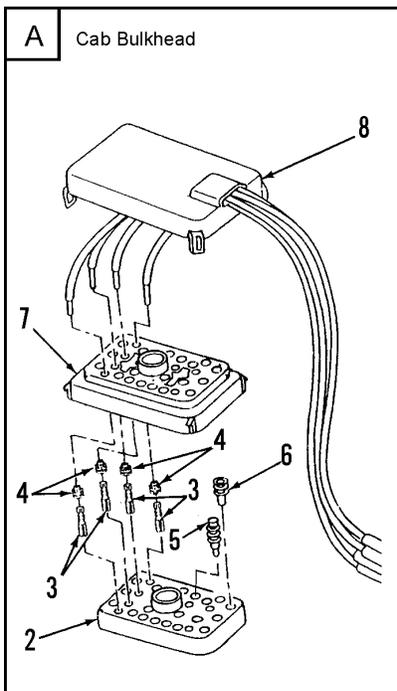
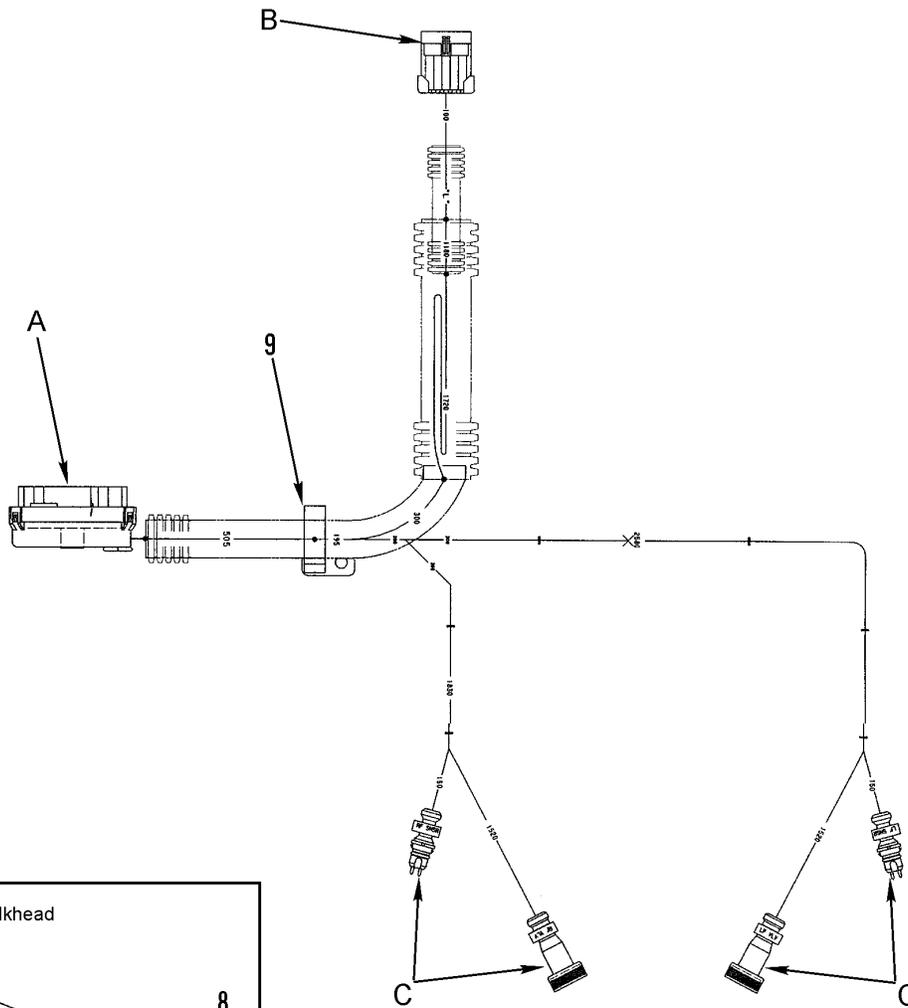
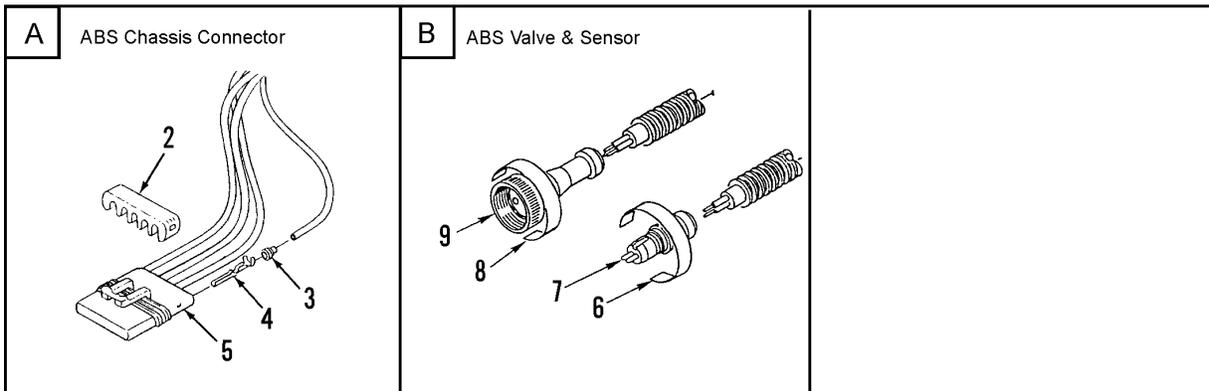
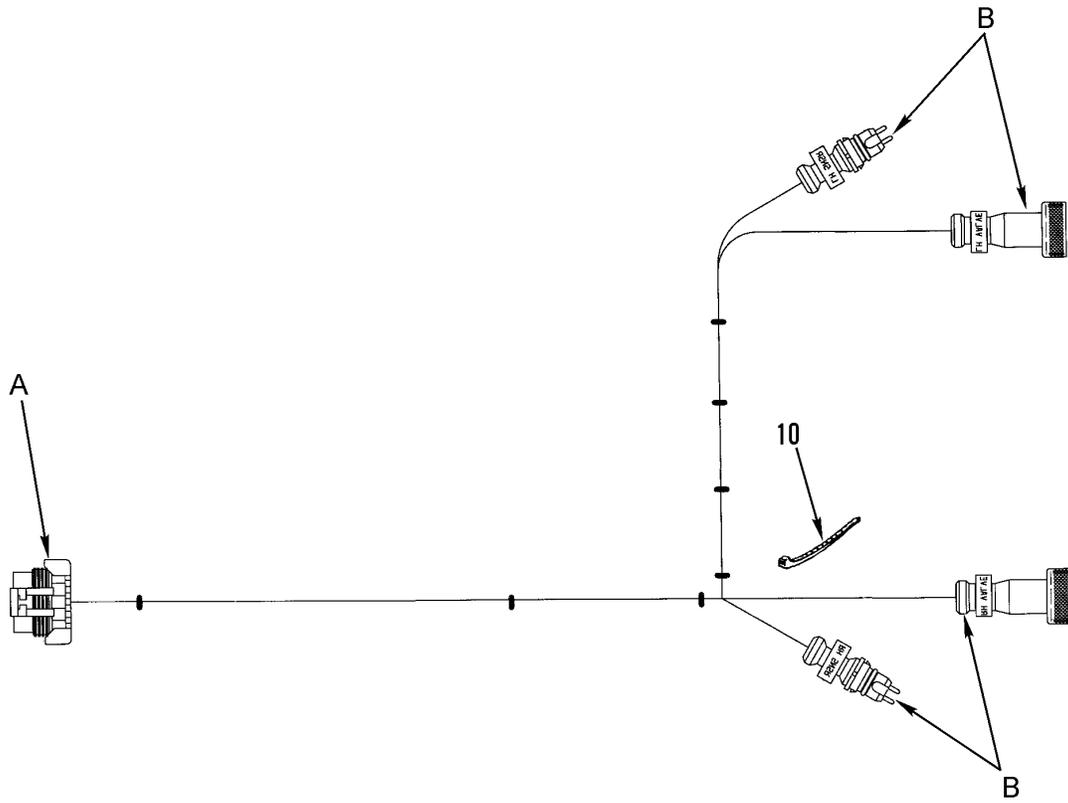
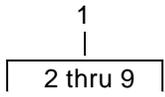

Figure 104. Front Chassis ABS Wiring Harness

SECTION II			TM9-2320-302-24P			
(1)	(2)	(3)	(4)	(5)	(6)	(7)
ITEM	SMR			PART		
NO	CODE	NSN	CAGEC	NUMBER	DESCRIPTION AND USABLE ON CODES(UOC)	QTY
					GROUP 0613 HULL OR CHASSIS WIRING HARNESS	
					FIG. 104 FRONT CHASSIS ABS WIRING HARNESS	
1	XDFFF		64678	A06-25989-000	HARNESS ASSY.....	1
2	XDFZZ		77060	12065850	.CONNECTOR, PLUG.....	1
3	PAFZZ	5940013533175	77060	12077411	.TERMINAL, QUICK DISC.....	20
4	PAFZZ	5330012925293	77060	12015284	.SEAL, CABLE.....	20
5	PAFZZ	5975013399574	77060	1201 0300	.BOOT, DUST AND MOIST.....	4
6	XDFZZ		77060	12066082	.SEAL/CAVITY.....	6
7	XDFZZ		77060	12066050	.LOCK, SECONDARY.....	1
8	XDFZZ		77060	12066129	.COVER, CONNECTOR.....	1
9	PAFZZ	5975014755309	77060	12066240	.CLAMP, COUPLING NUT,.....	1
10	PAFZZ	5340013651034	77060	12045810	.CLIP, SPRING TENSION.....	10
11	PAFZZ	5325014468320	77060	12052924	.GROMMET BLANK, NONME.....	10
12	PAFZZ	5999013641237	77060	12045773	.CONTACT, ELECTRICAL.....	10
13	PAFZZ	5935013644696	77060	12045808	.CONNECTOR, PLUG, ELEC.....	1
14	XDOZZ		64678	24-00613-000	.LABEL, RH ABS SENSOR.....	1
14	XDOZZ		64678	24-00613-001	.LABEL, LH ABS SENSOR.....	2
15	XDFZZ		78500	449 711 046 0	.CABLE ASSY, ABS.....	2
16	XDOZZ		64678	24-00613-002	.LABEL, RH ABS VALVE.....	2
16	XDOZZ		64678	24-00613-003	.LABEL, LH ABS VALVE.....	2
17	PFFZZ	6150014703205	78500	894 601 075 2	.CABLE ASSEMBLY, POWE.....	2

END OF FIGURE



342-1502

Figure 105. Rear Chassis ABS Wiring Harness

SECTION II			TM9-2320-302-24P			
(1)	(2)	(3)	(4)	(5)	(6)	(7)
ITEM	SMR			PART		
NO	CODE	NSN	CAGEC	NUMBER	DESCRIPTION AND USABLE ON CODES(UOC)	QTY
					GROUP 0613 HULL OR CHASSIS WIRING HARNESS	
					FIG. 105 REAR CHASSIS ABS WIRING HARNESS	
1	XDOFF		64678	A06-25990-000	WIRING HARNESS ASSY.....	1
2	XDOZZ		77060	12176336	.LOCK,SECONDARY.....	1
3	PAOZZ	5325014468320	64678	PAC/12052924	.GROMMET BLANK,NONME.....	10
4	PAOZZ	5940013661563	77060	12048074	.TERMINAL,QUICK DISC.....	10
5	PAOZZ	5935013645211	77060	12065425	.CONNECTOR,PLUG,ELEC.....	1
6	XDOZZ		64678	24-00613-000	.LABEL,RH ABS SENSOR.....	2
6	XDOZZ		64678	24-00613-001	.LABEL,LH ABS SENSOR.....	2
7	XDOZZ		78500	S4497110150	.CABLE ASSY,ABS SENS.....	2
8	XDOZZ		64678	24-00613-002	.LABEL,RH ABS VALVE.....	2
8	XDOZZ		64678	24-00613-003	.LABEL,LH ABS VALVE.....	2
9	XDOZZ		78500	S8946010732	.CABLE ASSY,ABS VALV.....	2
10	PAOZZ	5975009441499	96906	MS3368-1-9A	STRAP,TIEDOWN,ELECT.....	4

END OF FIGURE

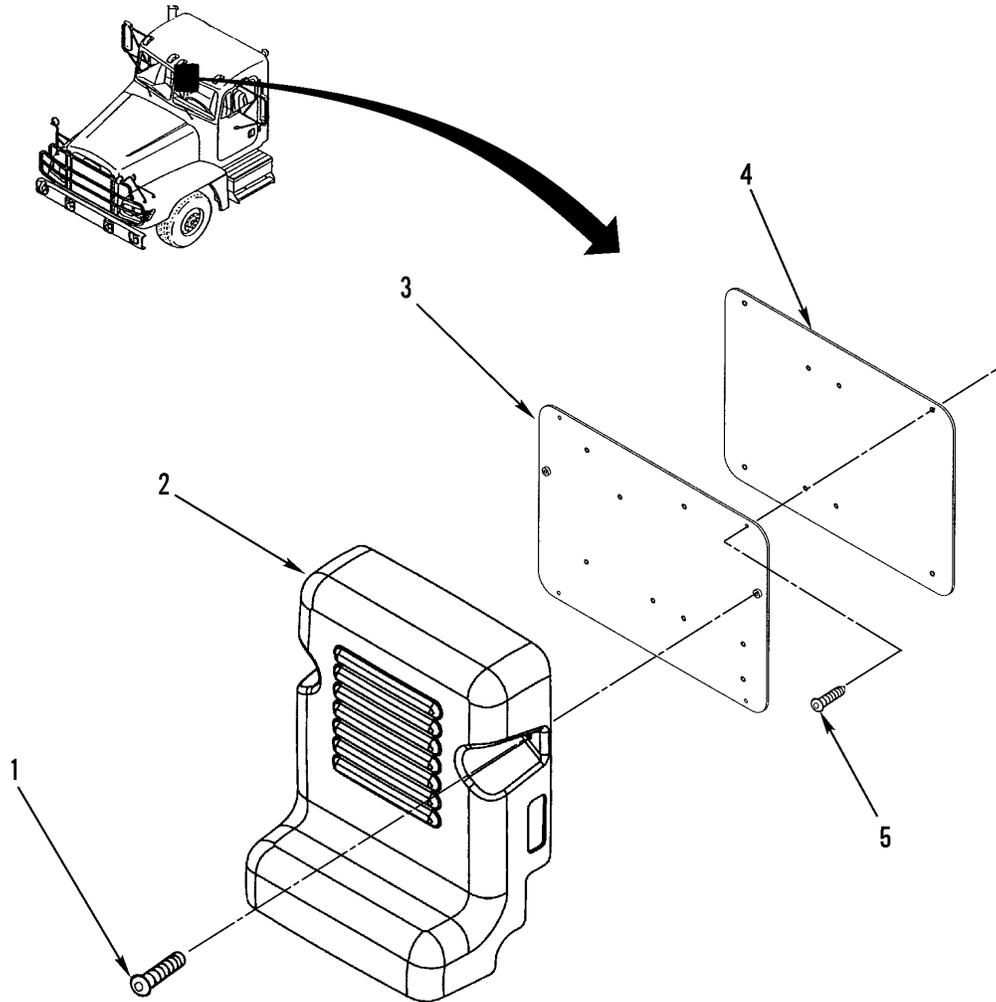

342-1506

Figure 106. ABS Cover and Mounting Plates

SECTION II			TM9-2320-302-24P			
(1)	(2)	(3)	(4)	(5)	(6)	(7)
ITEM	SMR			PART		
NO	CODE	NSN	CAGEC	NUMBER	DESCRIPTION AND USABLE ON CODES(UOC)	QTY
					GROUP 0613 HULL OR CHASSIS WIRING HARNES	
					FIG. 106 ABS COVER AND MOUNTING PLATES	
1	PAOZZ	5305013375637	64678	23-10410-704	SCREW,MACHINE 10-24, ZINK/CD.....	2
2	XDOZZ		64678	06-27069-000	COVER,ACCESS.....	1
3	XDOZZ		64678	A06-27038-000	PLATE,MOUNTING ABS.....	1
4	XDOZZ		64678	18-32853-000	PLATE,MOUNTING ECU.....	1
5	XDOZZ		64678	23-10056-705	SCREW 10-16 X 5/8 IN (TORX HEAD)...	4

END OF FIGURE

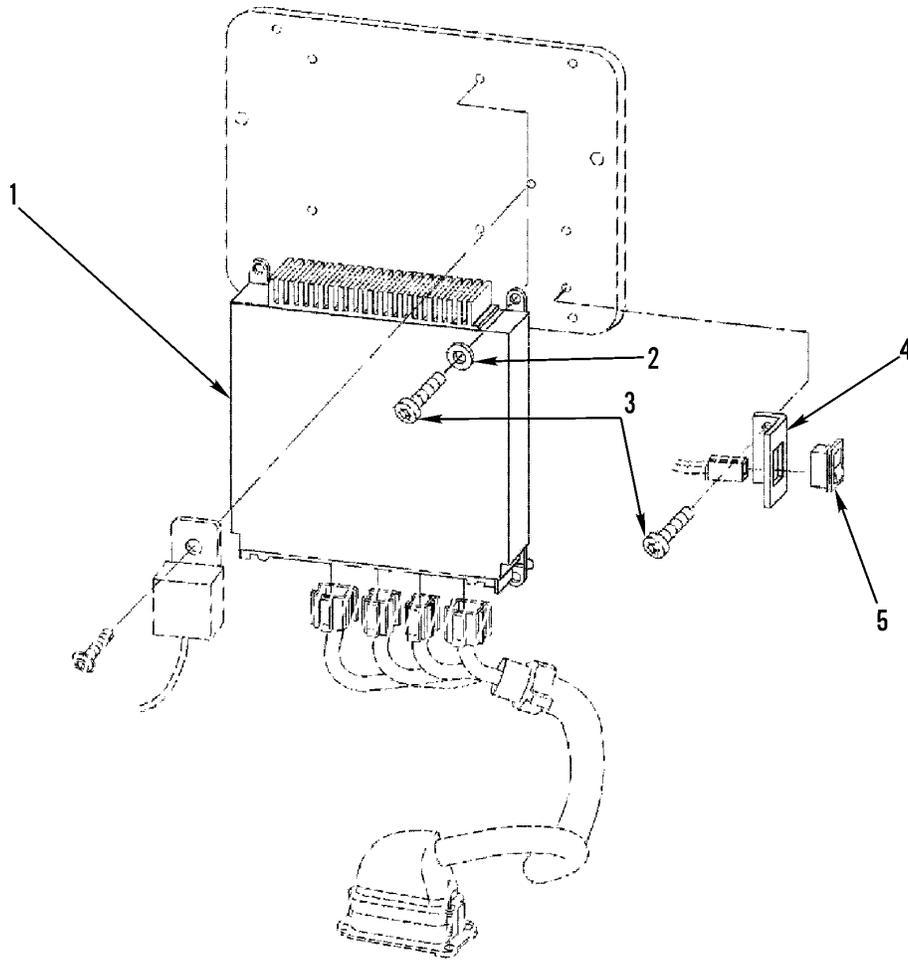

342-1510

Figure 107. ABS ECU Mounting and Related Parts

SECTION II			TM9-2320-302-24P			
(1)	(2)	(3)	(4)	(5)	(6)	(7)
ITEM	SMR			PART		
NO	CODE	NSN	CAGEC	NUMBER	DESCRIPTION AND USABLE ON CODES(UOC)	QTY
					GROUP 0613 HULL OR CHASSIS WIRING HARNES	
					FIG. 107 ABS ECU MOUNTING AND RELATED PARTS	
1	PAOZZ	2530014754935	78500	S4460044260	CONTROL, ANTI-LOCK B ABS.....	1
2	PAOZZ	5310000145850	96906	MS27183-42	WASHER, FLAT .219 ID X .500 OD X .049 THK.....	4
3	PAOZZ	5305013375637	64678	23-10410-704	SCREW, MACHINE.....	6
4	XDOZZ		64678	06-26822-000	BRACKET, MOUNTING.....	1
5	PAOZZ	5930014750077	64678	ETN/8981K529	SWITCH, TOGGLE.....	1

END OF FIGURE

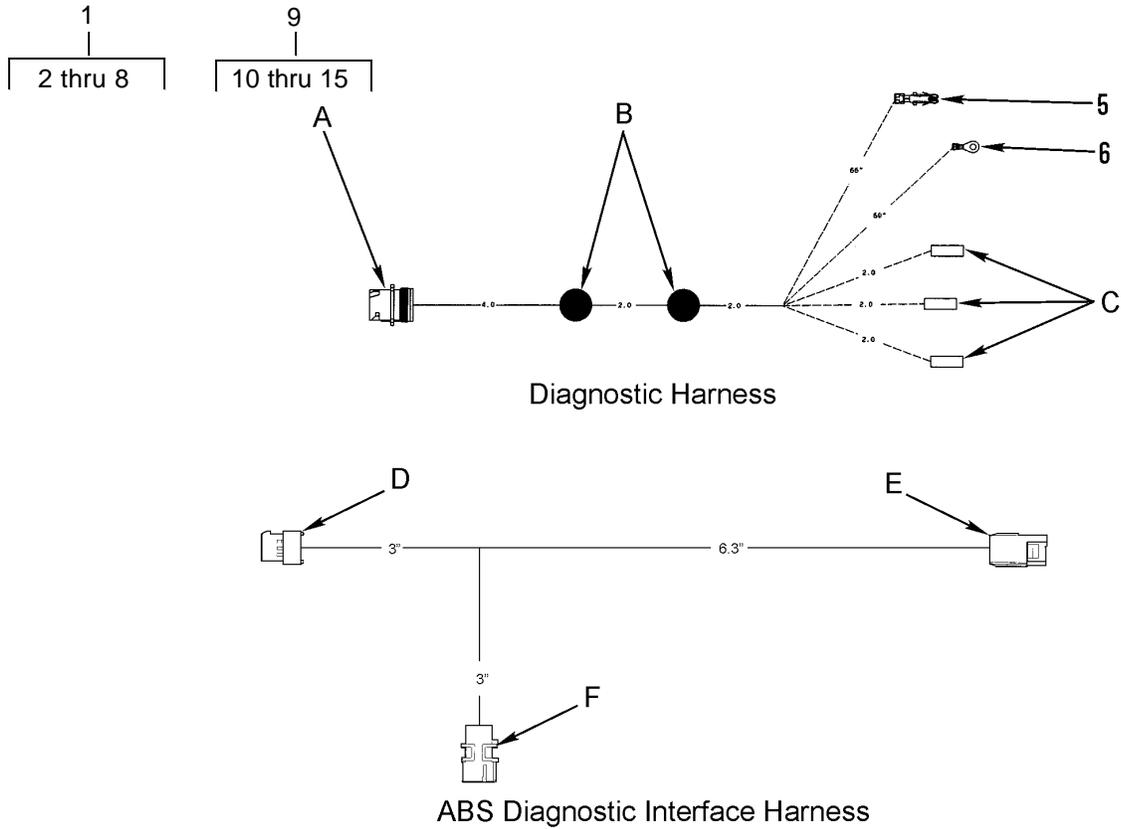

<p>A Diagnostic Connector</p>	<p>B</p>	<p>C</p>
<p>D DDEC O/L Harness</p>	<p>E Trans Harness</p>	<p>F ABS Floor Harness</p>

Figure 108. ABS Diagnostic Harnesses

SECTION II			TM9-2320-302-24P			
(1)	(2)	(3)	(4)	(5)	(6)	(7)
ITEM NO	SMR CODE	NSN	CAGEC	PART NUMBER	DESCRIPTION AND USABLE ON CODES(UOC)	QTY
					GROUP 0613 HULL OR CHASSIS WIRING HARNESS	
					FIG. 108 ABS DIAGNOSTIC HARNESSES	
1	XDOOO		64678	A06-29783-000	WIRING HARNESS.....	1
2	PAOZZ	5935014476852	11139	HD10 6 12P	.CONNECTOR,RECEPTACL.....	1
3	PAOZZ	5940014467581	11139	0460-220-1231	.TERMINAL,STUD.....	4
4	PAOZZ	5940008425353	77060	1839906	.SPLICE,CONDUCTOR.....	2
5	PAOZZ		77060	12103505	.TERMINAL,LUG.....	2
6	PAOZZ	5940013366322	00779	62691-2	.TERMINAL,LUG.....	1
7	PAOZZ	5935013371028	77060	12015271	.CONNECTOR BODY,PLUG.....	3
8	PAOZZ	5940013400587	77060	12020116	.TERMINAL,QUICK DISC.....	6
9	XDOOO		64678	A06-32540-000	LEAD ASSEMBLY,ELECT.....	1
10	PAOZZ	5940013919982	77060	12034047	.TERMINAL,LUG.....	6
11	XDOZZ		77060	12015344	.CONNECTOR,PLUG,ELEC.....	1
12	PAOZZ	5935013371028	77060	12015271	.CONNECTOR BODY,PLUG.....	1
13	XDOZZ		77060	12015345	.CONNECTOR,PLUG,ELEC.....	1
14	XDOZZ		77060	12033821	.TERMINAL,FEMALE.....	2
15	XDOZZ		77060	12015823	.TERMINAL,FEMALE,BLA.....	2

END OF FIGURE

1
2 thru 13

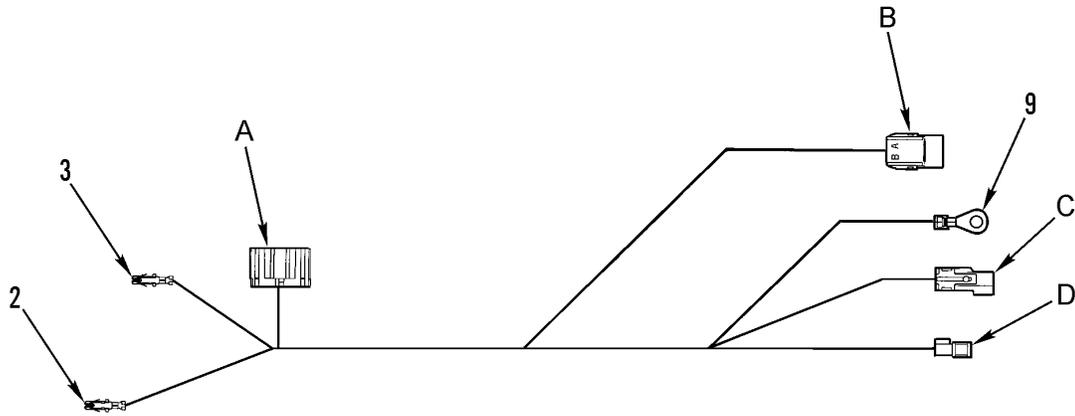

<p>A Electrical Block</p>	<p>B Trailer ABS Indicator Lamp</p>	<p>C Trailer ABS Indicator</p>
<p>D Trailer ABS Power</p>		

342-1514

Figure 109. ABS Trailer Cab Floor Harness

SECTION II			TM9-2320-302-24P			
(1)	(2)	(3)	(4)	(5)	(6)	(7)
ITEM NO	SMR CODE	NSN	CAGEC	PART NUMBER	DESCRIPTION AND USABLE ON CODES(UOC)	QTY
					GROUP 0613 HULL OR CHASSIS WIRING HARNESS	
					FIG. 109 ABS TRAILER CAB FLOOR HARNESS	
1	PAOOO	6150014786805	64678	A06-27386-000	WIRING HARNESS, BRAN ABS.....	1
2	PAOZZ	5940013367062	2E480	023433	.TERMINAL, QUICK DISC.....	1
3	PAOZZ	5940013366329	2E480	023432	.TERMINAL, QUICK DISC.....	2
4	PAOZZ	5935013472657	2E480	059022	.CONNECTOR, PLUG, ELEC.....	1
5	PAOZZ	5940013373319	77060	12084590	.TERMINAL, QUICK DISC.....	4
6	XDOZZ		2E480	059011	.LOCK, MORTISE.....	3
7	PAOZZ	5940013400587	77060	12020116	.TERMINAL, QUICK DISC.....	2
8	PAOZZ	5935013371028	77060	12015271	.CONNECTOR BODY, PLUG.....	1
9	PAOZZ	5940013366322	77060	12004437	.TERMINAL, LUG.....	1
10	PAOZZ	5940013421640	77060	12020120	.TERMINAL, QUICK DISC.....	1
11	XDOZZ		77060	12015987	.CONNECTOR, PLUG, ELEC FEMALE 1 PIN..	1
12	PAOZZ	5940013410525	77060	12084595	.TERMINAL, QUICK DISC.....	1
13	XDOZZ		77060	12015952	.CONNECTOR, PLUG, ELEC MALE 1 PIN....	1

END OF FIGURE

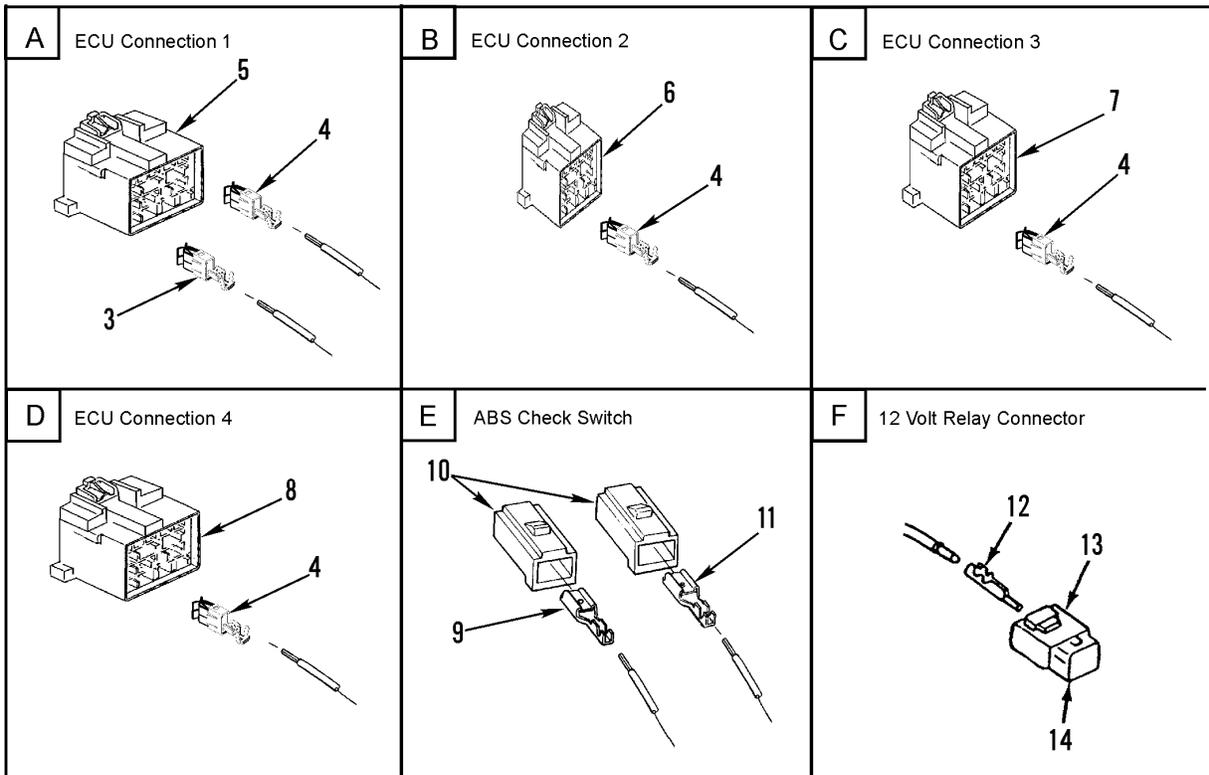
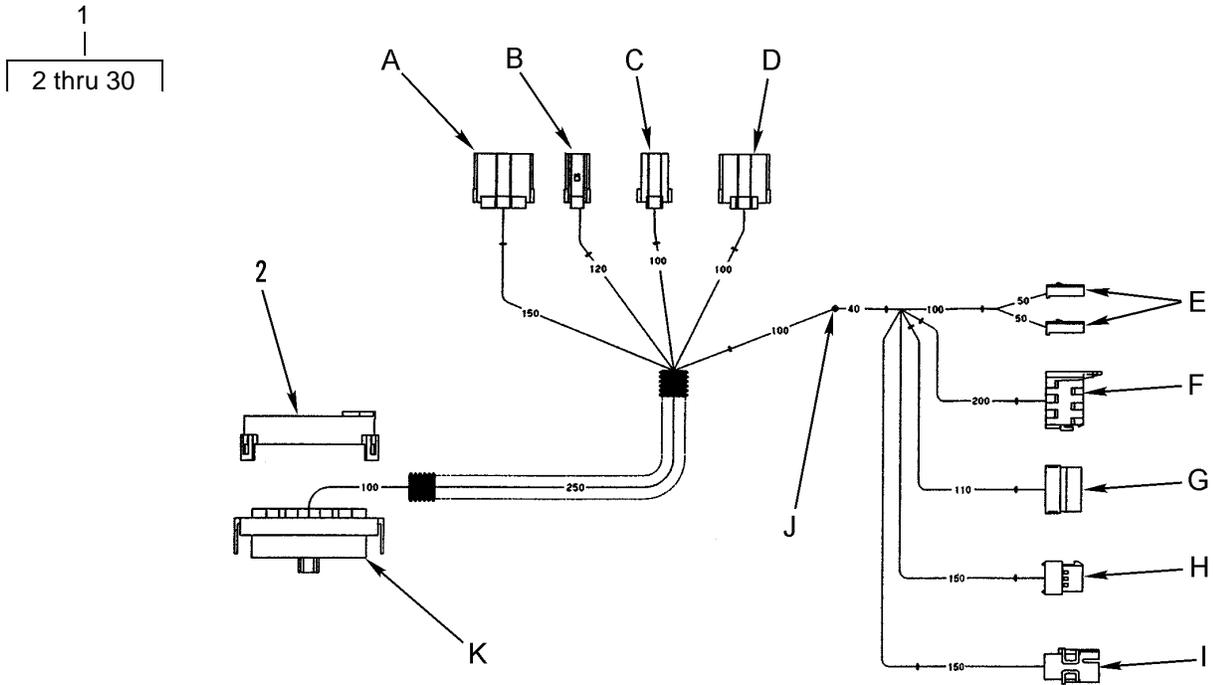

342-1507-1

Figure 110. ECU/ABS Wiring Harness (Sheet 1 of 2)

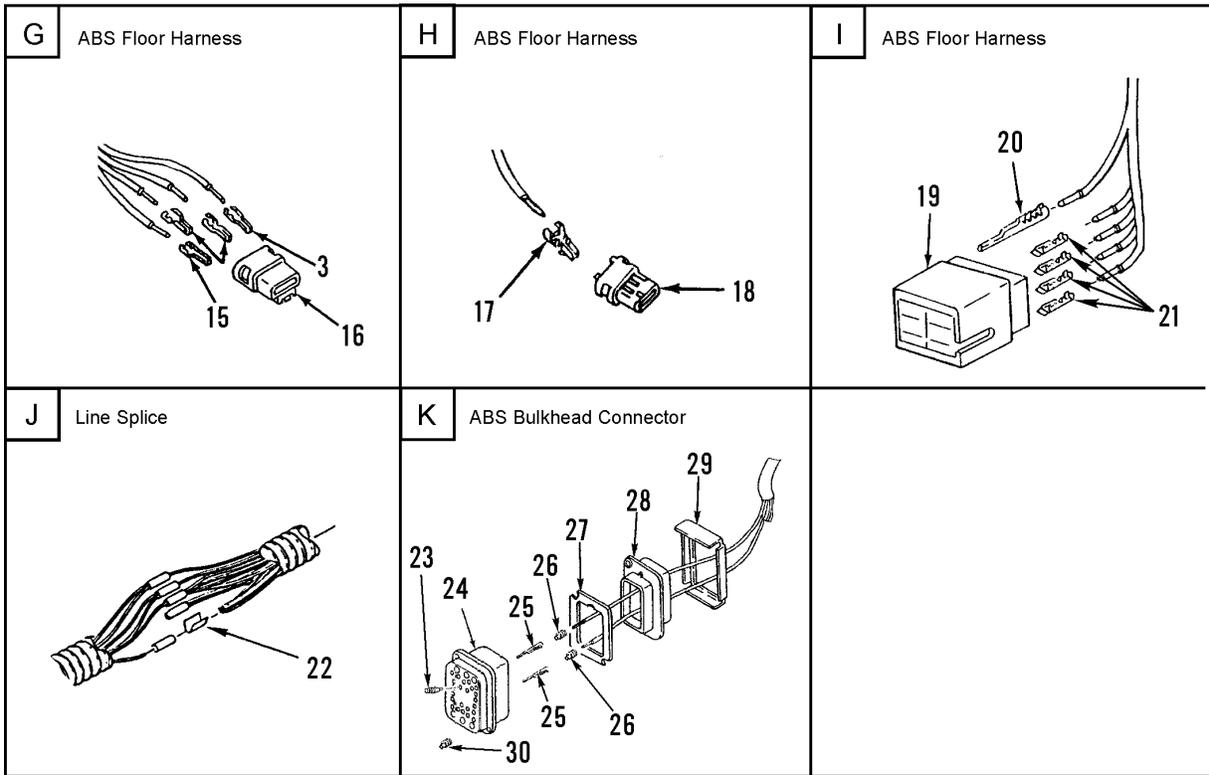

342-1507-2

Figure 110. ECU/ABS Wiring Harness (Sheet 2 of 2)

SECTION II			TM9-2320-302-24P			
(1)	(2)	(3)	(4)	(5)	(6)	(7)
ITEM NO	SMR CODE	NSN	CAGEC	PART NUMBER	DESCRIPTION AND USABLE ON CODES(UOC)	QTY
GROUP 0613 HULL OR CHASSIS WIRING HARNESS						
FIG. 110 ECU/ABS WIRING HARNESS						
1	XDOFF		64678	A06-27300-000	HARNESS ASSY,ABS.....	1
2	XDOZZ		77060	12066129	.COVER,CONNECTOR.....	1
3	XDOZZ		00779	927768 3	.TERMINAL,QUICK DISC.....	4
4	XDOZZ		00779	927775 3	.TERMINAL,QUICK DISC.....	25
5	XDOZZ		00779	1 9673671	.CONNECTOR,SPECIAL.....	1
6	PAOZZ		00779	964561-5	.CONNECTOR BODY,RECE.....	1
7	PAOZZ		00779	964561 4	.CONNECTOR BODY,RECE.....	1
8	XDOZZ		00779	964561 2	.CONNECTOR BODY,RECE.....	1
9	XDOZZ		77060	12124520	.TERMINAL,QUICK DISC.....	1
10	PAOZZ	5935010657984	10988	2977253	.CONNECTOR,PLUG,ELEC.....	1
11	PAOZZ	5999014580082	77060	12124515	.CONTACT,ELECTRICAL.....	1
12	PAOZZ	5940014417557	77060	12015865	.TERMINAL,QUICK DISC.....	2
13	XDOZZ		77060	12033871	.CONNECTOR,RELAY,MTG.....	1
14	XDOZZ		77060	12033872	.CONNECTOR,LOCKING.....	1
15	PAOZZ	5940013409064	77060	12015870	.TERMINAL,QUICK DISC.....	3
16	XDOZZ		77060	12015664	.CONNECTOR,MALE 4P.....	1
17	PAOZZ	5940013570069	77060	12034046	.SPLICE SET,QUICK DI.....	2
18	XDOZZ		77060	12015344	.CONNECTOR,PLUG,ELEC.....	1
19	XDOZZ		77060	12015345	.CONNECTOR,PLUG,ELEC.....	1
20	PAOZZ	5940013400587	77060	12020116	.TERMINAL,QUICK DISC.....	1
21	PAOZZ	5940013919982	77060	12034047	.TERMINAL,LUG.....	4
22	XDOZZ		77060	01864022	.SPLICE,CONDUCTOR.....	1
23	PAOZZ	5975013399574	77060	12010300	.BOOT,DUST AND MOIST.....	4
24	XDOZZ		77060	12160959	.CONNECTOR,HOUSING.....	1
25	XDOZZ		77060	12048159	.TERMINAL,MALE.....	20
26	PAOZZ	5330012925293	77060	12015284	.SEAL,CABLE.....	26
27	PAOZA	5330014407532	77060	1206 5849	.SEAL,NONMETALLIC SP.....	1
28	XDOZZ		77060	12065848	.CONNECTOR,LOCKING.....	2
29	PAOZZ	5340014476352	64678	06-23089-000	.COVER,ACCESS.....	1
30	XDOZZ		77060	12066082	.SEAL/CAVITY.....	6

END OF FIGURE

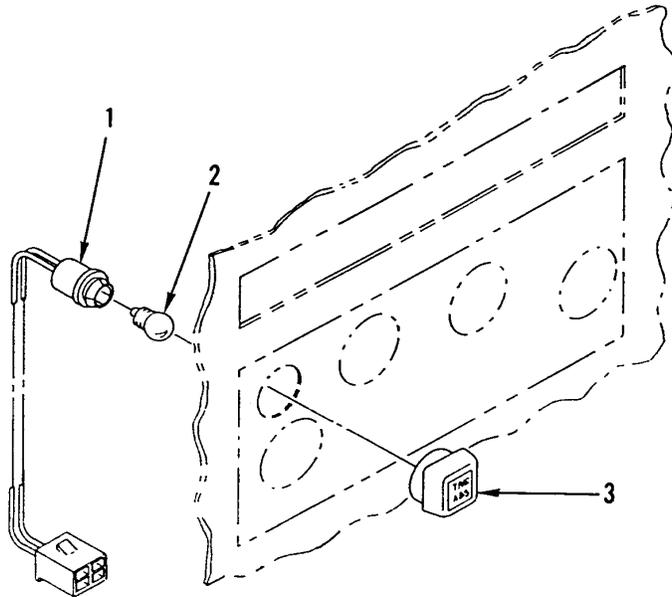
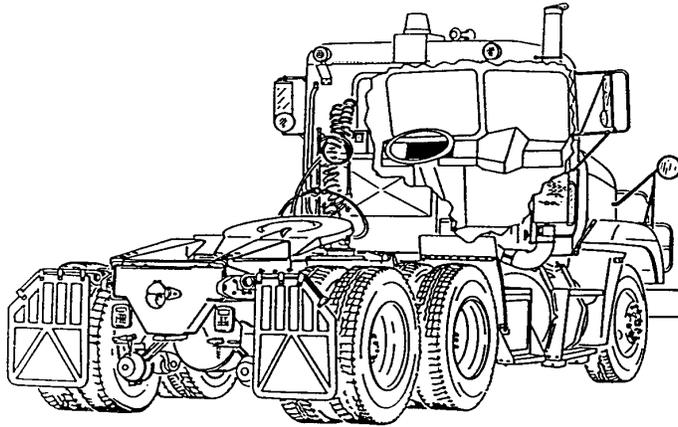

342-1424

Figure 111. ABS Warning Lamp

SECTION II			TM9-2320-302-24P			
(1)	(2)	(3)	(4)	(5)	(6)	(7)
ITEM	SMR			PART		
NO	CODE	NSN	CAGEC	NUMBER	DESCRIPTION AND USABLE ON CODES(UOC)	QTY
					GROUP 0613 HULL OR CHASSIS WIRING HARNESS	
					FIG. 111 ABS WARNING LAMP	
1	PAOZZ		64678	06-22309-002	LIGHT, INDICATOR, ELC TRAILER ABS....	1
2	PAOZZ	6240009441264	62607	194	LAMP, INCANDESCENT.....	1
3	PAOZZ	9905013522213	57733	830540-70	PLATE, INSTRUCTION.....	1

END OF FIGURE

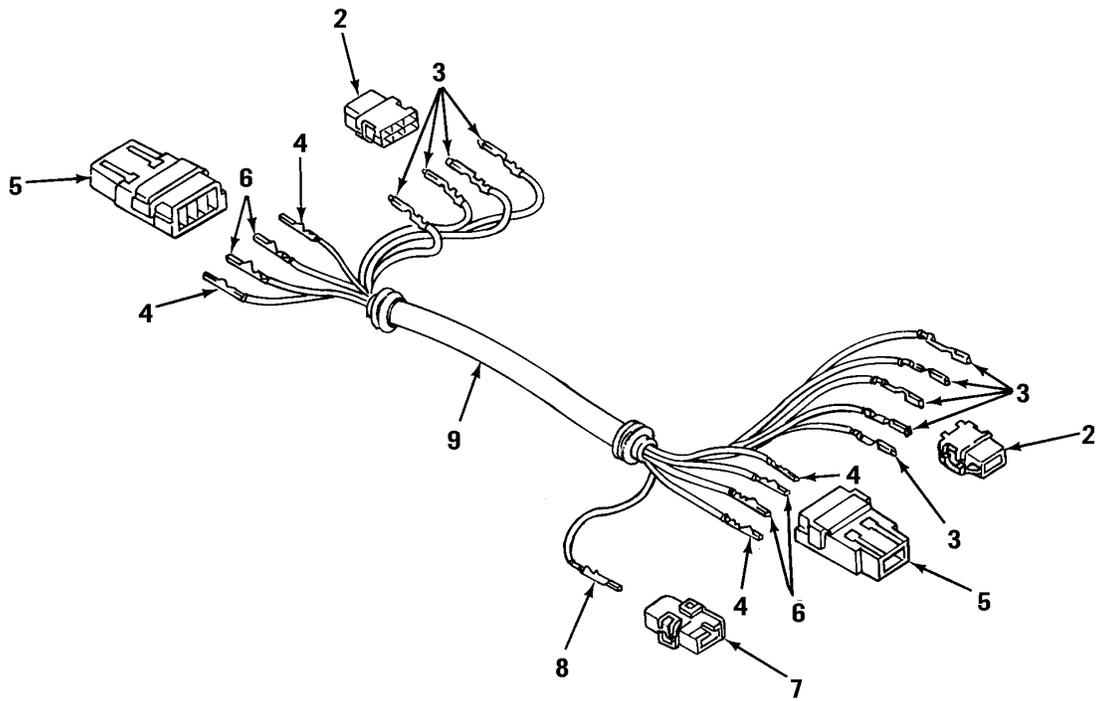
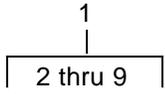

342-1329

Figure 112. ABS Floor Harness

SECTION II			TM9-2320-302-24P			
(1)	(2)	(3)	(4)	(5)	(6)	(7)
ITEM	SMR			PART		
NO	CODE	NSN	CAGEC	NUMBER	DESCRIPTION AND USABLE ON CODES(UOC)	QTY
					GROUP 0613 HULL OR CHASSIS WIRING HARNESS	
					FIG. 112 ABS FLOOR HARNESS	
1	XDOFF		64678	A06-23393-000	WIRING HARNESS, BRAN.....	1
2	XDOZZ		77060	12015344	.CONNECTOR, PLUG, ELEC.....	2
3	PAOZZ	5940013476142	77060	12066214	.TERMINAL, QUICK DISC.....	9
4	PAOZZ	5940013366327	77060	12066493	.TERMINAL, QUICK DISC.....	4
5	XDOZZ		77060	12034295	.HOUSING, CONNECTOR.....	2
6	PAOZZ	5940013400588	77060	1202 0126	.TERMINAL, QUICK DISC.....	4
7	XDOZZ		77060	12015345	.CONNECTOR, PLUG, ELEC.....	1
8	PAOZZ	5940013400587	77060	12020116	.TERMINAL, QUICK DISC.....	1
9	MFOZZ		64678	48-02217-075X57.	.CONDUIT (57.08 IN.) MAKE FROM BULK	1
				08	PN: 68240R (77060).....	

END OF FIGURE

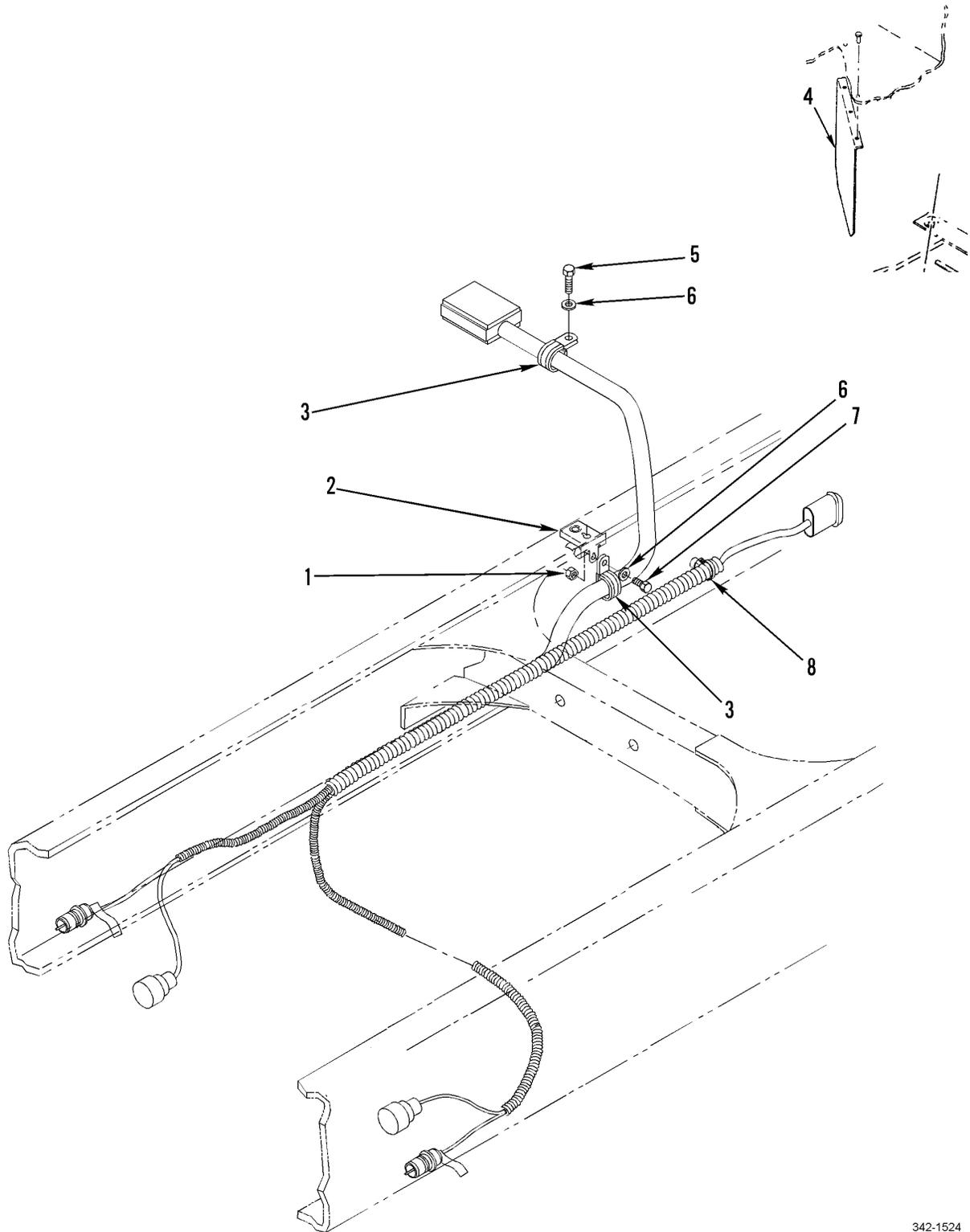

Figure 113. ABS Wiring Harness Hardware

SECTION II			TM9-2320-302-24P			
(1)	(2)	(3)	(4)	(5)	(6)	(7)
ITEM NO	SMR CODE	NSN	CAGEC	PART NUMBER	DESCRIPTION AND USABLE ON CODES(UOC)	QTY
					GROUP 0613 HULL OR CHASSIS WIRING HARNESS	
					FIG. 113 ABS WIRING HARNESS HARDWARE	
1	PAOZZ	5310000881251	81349	M45913/1-4CG5C	NUT, SELF LOCKING, HE 1/4-20UNC.....	3
2	XDOZZ		64678	681 997 06 90	BRACKET, MOUNTING.....	1
3	XDOZZ		18076	S219G18	CLAMP, LOOP.....	2
4	PAOZZ	5999013724955	19207	12419140	CONTACT, ELECTRICAL.....	1
5	PAOZZ	5940009563517	77060	2962987	TERMINAL, QUICK DISC.....	1
6	PAOZZ	5310008094058	96906	MS27183-10	WASHER, FLAT.....	2
7	PAOZZ	5305000680502	96906	MS90725-6	SCREW, CAP, HEXAGON H 1/4-20 UNC X .750.....	1
8	PAOZZ	5975009441499	96906	MS3368-1-9A	STRAP, TIEDOWN, ELECT.....	10

END OF FIGURE

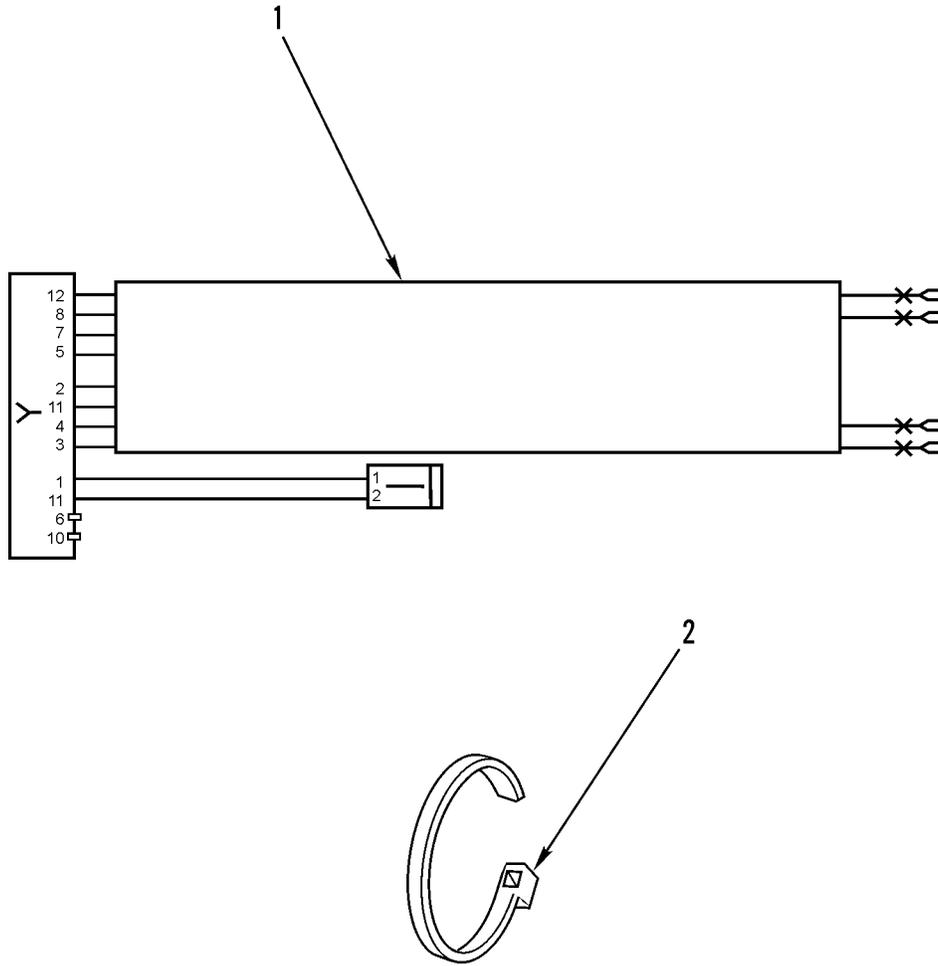
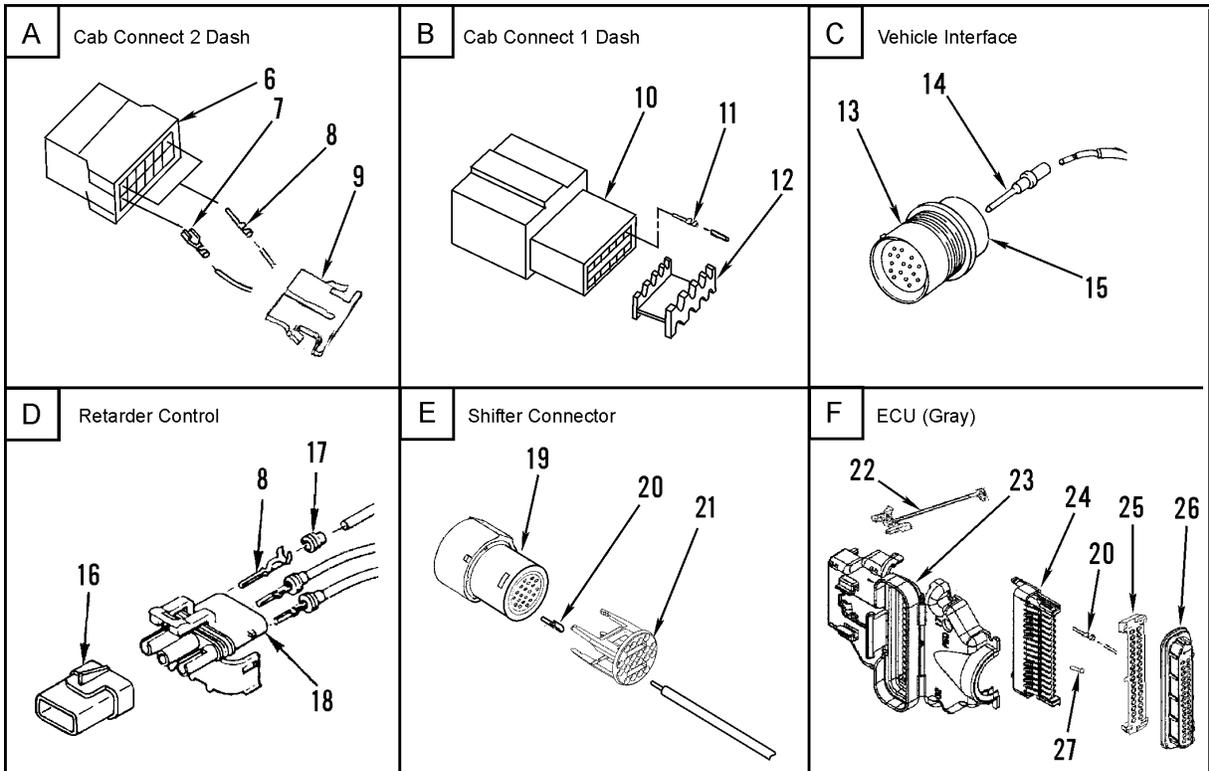
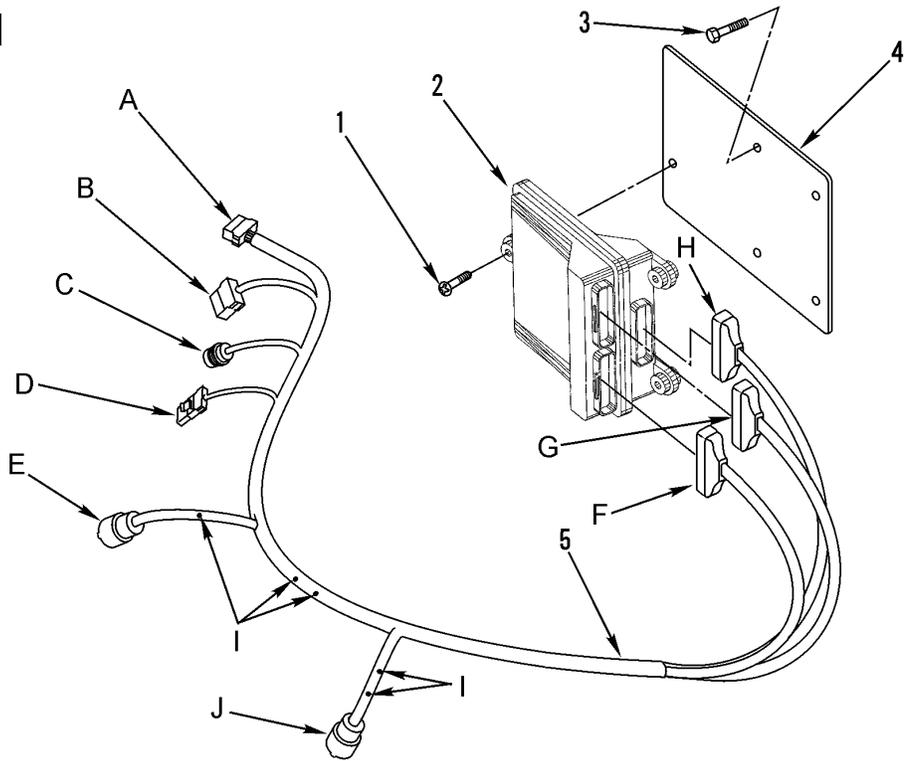

Figure 114. Personnel Heater Wiring Harness

SECTION II			TM9-2320-302-24P			
(1)	(2)	(3)	(4)	(5)	(6)	(7)
ITEM	SMR			PART		
NO	CODE	NSN	CAGEC	NUMBER	DESCRIPTION AND USABLE ON CODES(UOC)	QTY
					GROUP 0613 HULL OR CHASSIS WIRING HARNESS	
					FIG. 114 PERSONNEL HEATER WIRING HARNESS	
1	XDOZZ		62380	906041A	WIRING HARNESS.....	1
2	PAOZZ	5975005709598	96906	MS3367-7-9	STRAP,TIEDOWN,ELECT 11.50 IN.....	10

END OF FIGURE

5
|
6 thru 39



342-1531-1

Figure 115. Transmission ECU Harness (Sheet 1 of 2)

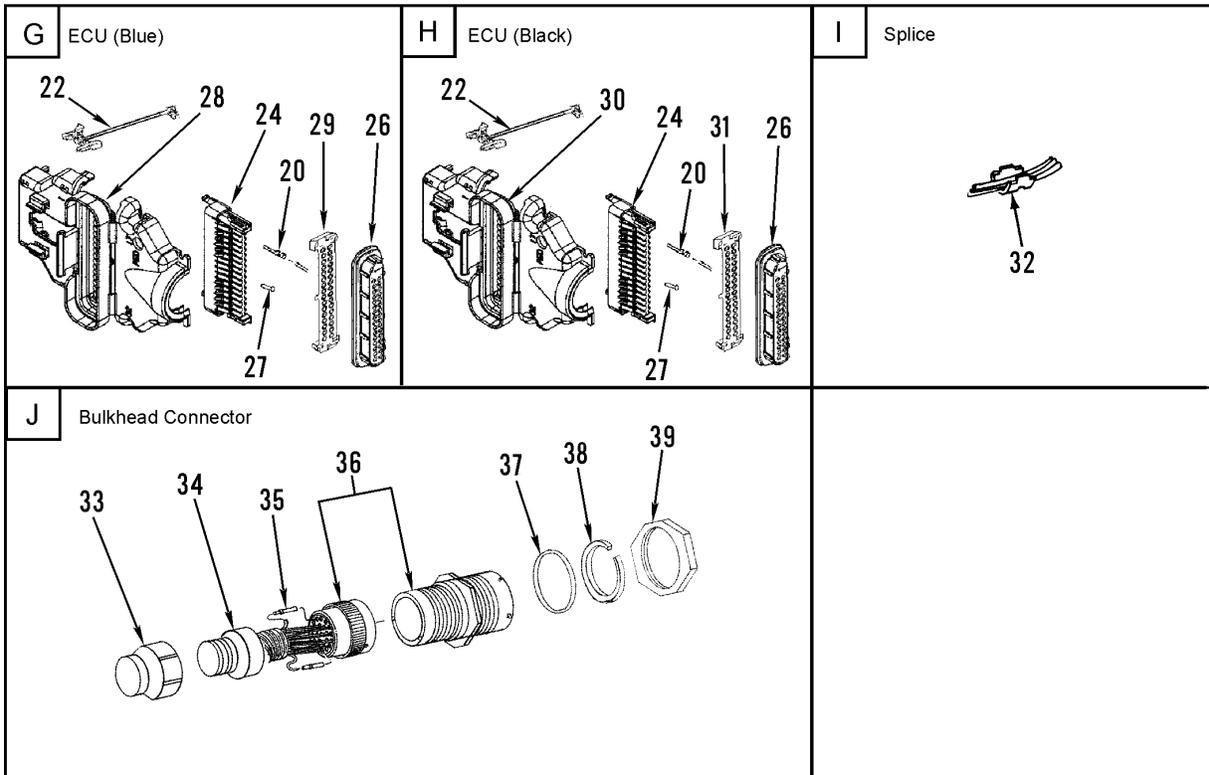

342-1531-2

Figure 115. Transmission ECU Harness (Sheet 2 of 2)

SECTION II			TM9-2320-302-24P			
(1)	(2)	(3)	(4)	(5)	(6)	(7)
ITEM	SMR			PART		
NO	CODE	NSN	CAGEC	NUMBER	DESCRIPTION AND USABLE ON CODES(UOC)	QTY
					GROUP 0613 HULL OR CHASSIS WIRING HARNESS	
					FIG. 115 TRANSMISSION ECU HARNESS	
1	PAOZZ		64678	23-10414-706	SCREW,MACHINE 1/4-20 X .75.....	3
2	PAODL		64678	A06-31940-000	MODULATOR ASSEMBLY WT TRANSMISSION.	1
3	PAOZZ		64678	23-10673-100	SCREW,TAPPING 1/4-20 X 1.00.....	3
4	XDOZZ		64678	A06-29036-000	PLATE,MOUNTING.....	1
5	PAOOO		64678	A06-30356-000	HARNESS,MODULATOR ECU TO TRANS.....	1
6	XDOZZ		77060	1206 4998	.CONNECTOR,PLUG,ELEC.....	1
7	PAOZZ	5940013570069	77060	12034046	.SPLICE SET,QUICK DI.....	8
8	PAOZZ	5940012347272	77060	1208 9040	.PIN TERMINAL.....	3
9	XDOZZ		77060	1206 4999	.LOCK,TERM.....	2
10	XDOZZ		77060	1206 6195	.HOUSING,PLUG,ELECTR.....	1
11	PAOZZ	5940013919982	77060	12034047	.TERMINAL,LUG.....	6
12	XDOZZ		77060	1206 5141	.LOCK,TERM.....	1
13	PAOZZ	5935010241902	36378	1003296-02	.CONNECTOR BODY,PLUG.....	1
14	PAOZZ		00779	66101-2	.CONTACT,ELECTRICAL.....	14
15	PAOZA	5935010305090	00779	206322-1	.CLAMP,CABLE,ELECTRI.....	1
16	XDOZZ		77060	1201 5092	.HOUSING,PLUG,ELECTR.....	1
17	PAOZZ	5330012925293	77060	1201 5284	.SEAL,CABLE.....	3
18	PAOZZ	5935012922336	77060	12015793	.CONNECTOR,PLUG,ELEC.....	1
19	XDOZZ		77060	1216 0493	.CONNECTOR,PLUG,ELEC.....	1
20	PAOZZ	5940014426298	77060	12084912	.TERMINAL,LUG.....	86
21	PAOZZ	5935014455144	77060	12160494	.INSERT,ELECTRICAL C.....	1
22	PAOZZ	5935014602272	77060	12177289	.CONNECTOR,PLUG,ELEC.....	3
23	PAOZZ	5935014602604	77060	12191002	.ADAPTER,CABLE CLAMP.....	1
24	PAOZZ	5935014608050	77060	15305371	.ADAPTER,CABLE CLAMP.....	3
25	XDOZZ		77060	1212 9022	.LOCK,SECONDARY,GRAY.....	1
26	PAOZZ	5930014602495	77060	15305333	.BOOT,DUST AND MOIST.....	3
27	PAOZZ	5935014607491	77060	12129557	.PLUG,END SEAL,ELECT.....	25
28	PAOZZ	5935014667448	77060	12191003	.ADAPTER,CABLE CLAMP.....	1
29	PAOZZ	5935014602601	77060	12129023	.RETAINER,ELECTRICAL.....	1
30	PAOZZ	5935014602478	77060	12191001	.ADAPTER,CABLE CLAMP.....	1
31	PAOZZ	5935014602479	77060	12129021	.RETAINER,ELECTRICAL.....	1
32	PAOZZ	5935013678677	00779	1-86402-2	.CONNECTOR BODY,PLUG.....	5
33	XDOZZ		11139	WTA10-24-01	.SHELL,ELECTRICAL,CO.....	1
34	XDOZZ		11139	WTA10-24-02	.GROMMET BLANK,ONME.....	1
35	PAOZZ	5999012036687	11139	0462-201-16141	.CONTACT,ELECTRICAL.....	29
36	XDOZZ		11139	WTC04B24-31SN	.CONNECTOR,RECEPTACL 31 PIN.....	1
37	XDOZZ		11139	9013-3-0402	.SEAL,O-RING 1.739.....	1
38	XDOZZ		11139	0914-212-2486	.WASHER-SPLIT.....	1
39	XDOZZ		11139	0926-208-2401	.NUT,BLKHD.....	1

END OF FIGURE

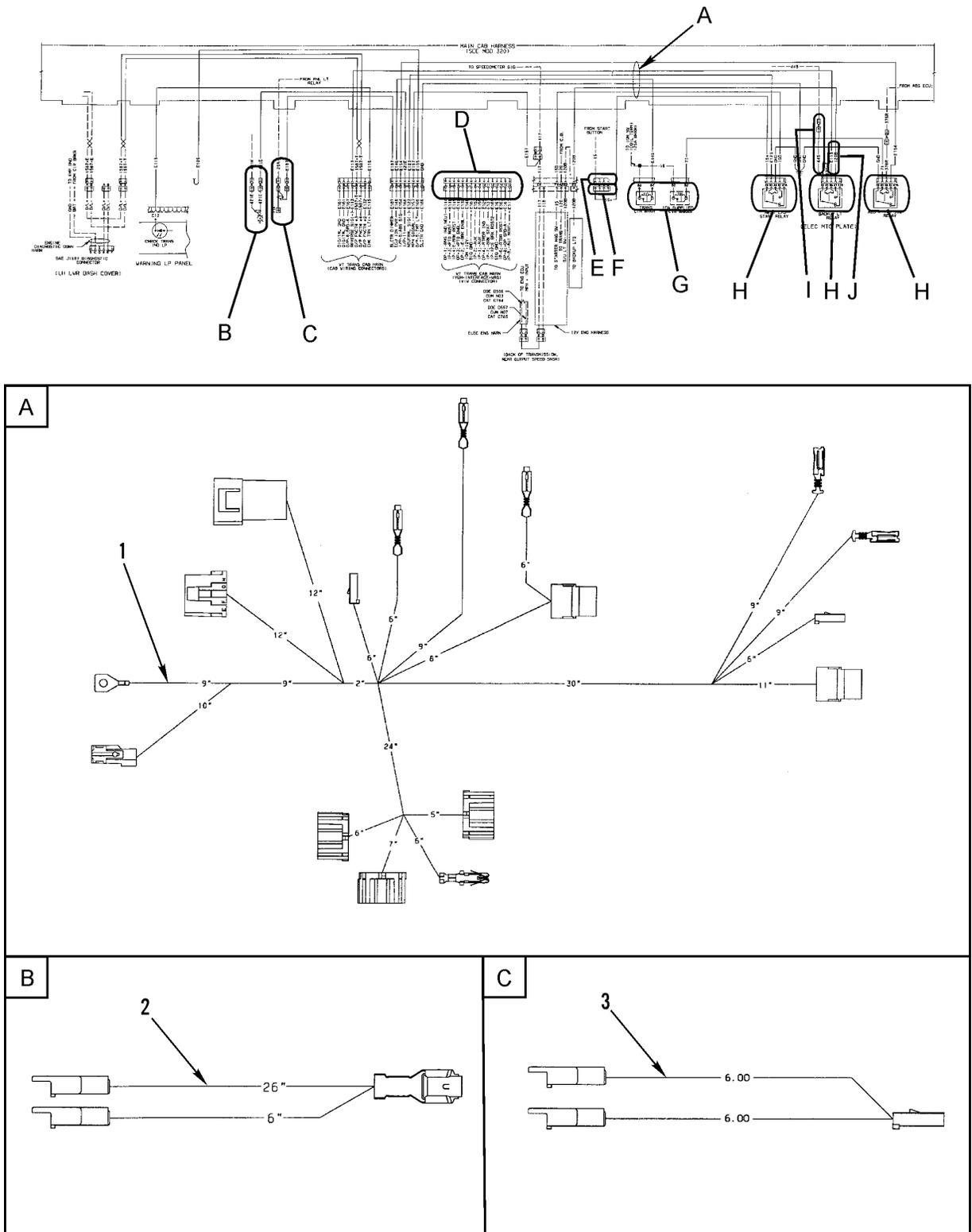

342-1533-1

Figure 116. ABA Overlay Harness and Interface Components (Sheet 1 of 2)

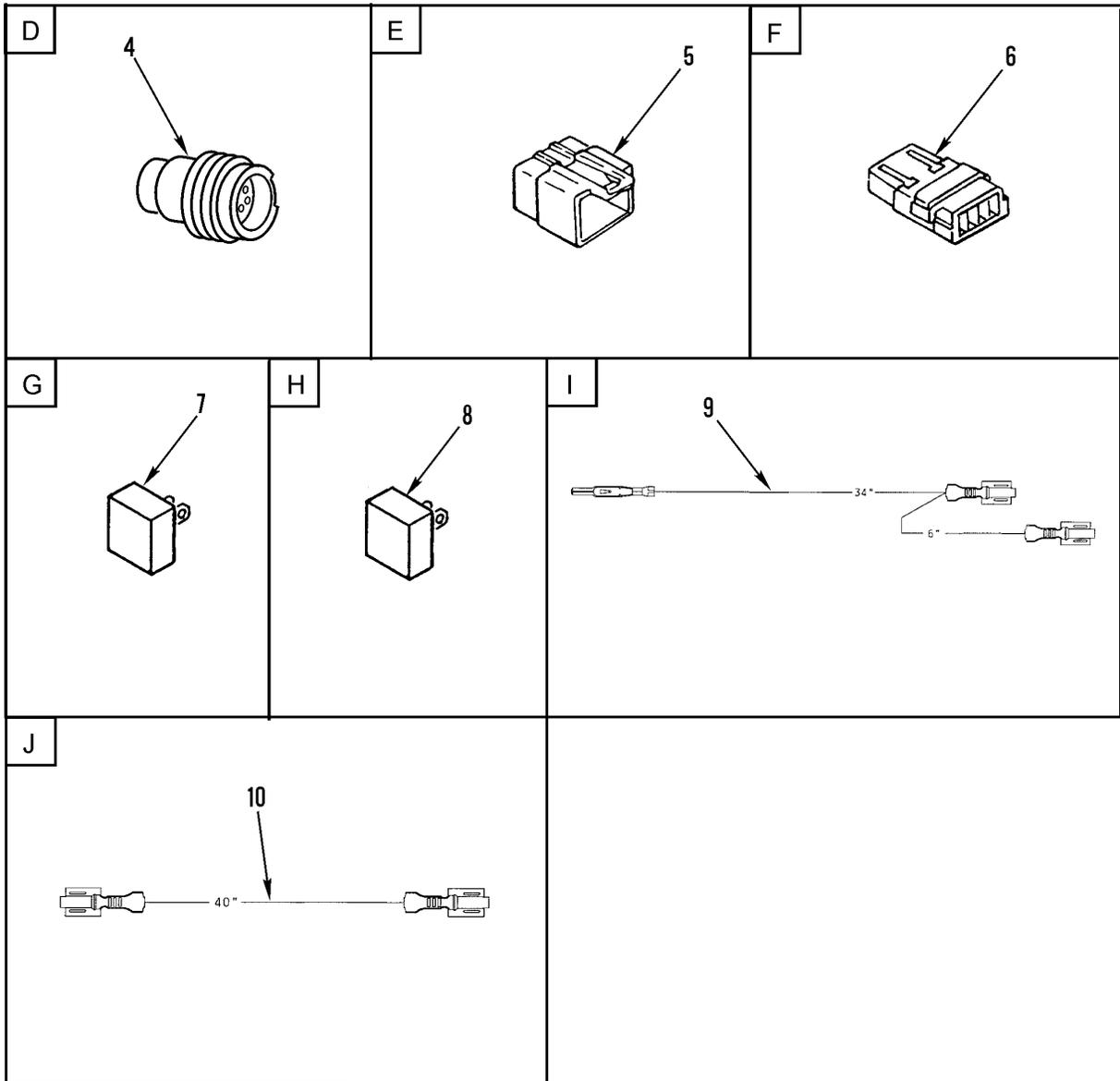

342-1533-2

Figure 116. Overlay Harness and Interface Components (Sheet 2 of 2)

SECTION II			TM9-2320-302-24P			
(1)	(2)	(3)	(4)	(5)	(6)	(7)
ITEM	SMR			PART		
NO	CODE	NSN	CAGEC	NUMBER	DESCRIPTION AND USABLE ON CODES(UOC)	QTY
					GROUP 0613 HULL OR CHASSIS WIRING HARNESS	
					FIG. 116 ABS OVERLAY HARNESS AND INTERFACE COMPONENTS	
1	PAOZZ		64678	A06-29362-000	WIRING HARNESS,BRAN ABS.....	1
2	PAOZZ		64678	A06-29754-000	HARNESS,JUMPER 24V INTERFACE.....	1
3	PAOZZ		64678	A06-29042-000	HARNESS,JUMPER.....	1
4	PAOZZ	5935010234871	36378	1003292-07	CONNECTOR BODY,RECE 16 PIN.....	1
5	XDOZZ		77060	12015664	CONNECTOR,MALE 4P.....	1
6	XDOZZ		77060	12034295	HOUSING,CONNECTOR.....	1
7	PAOZZ		11873	12F10-00	CIRCUIT BREAKER.....	2
8	PAOZZ		77342	VF4-15F11-C01	RELAY,ELECTROMAGNET 12 VOLT.....	3
9	PAOZZ		64678	A06-29754-002	HARNESS,JUMPER.....	1
10	PAOZZ		64678	A06-29754-001	HARNESS,JUMPER.....	1

END OF FIGURE

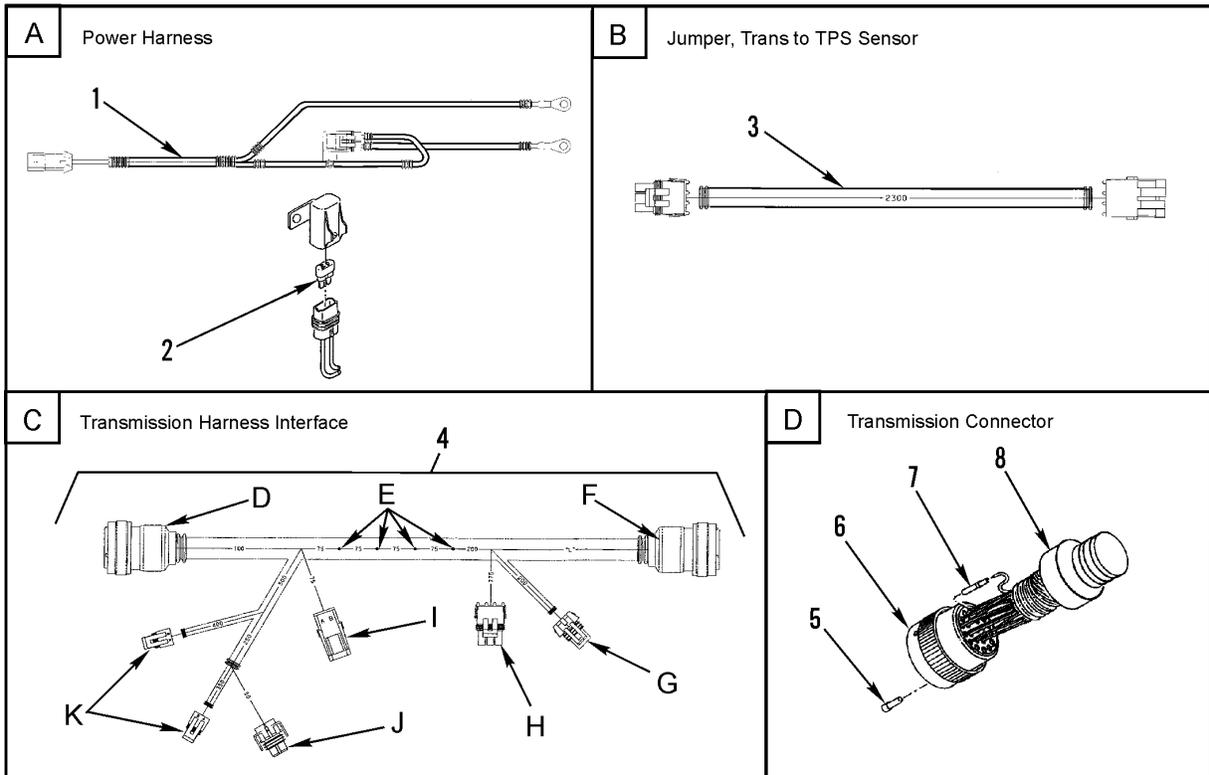
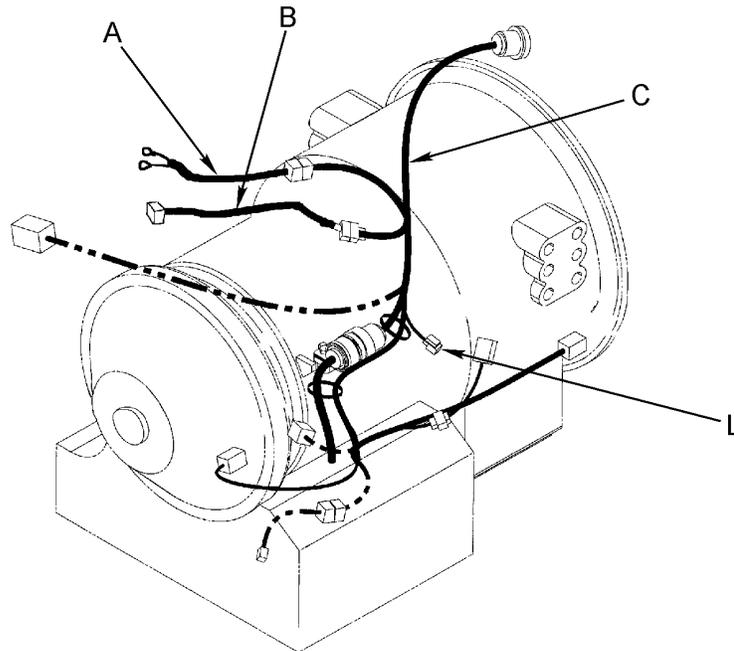
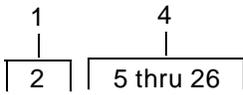

342-1534-1

Figure 117. Transmission Power Harness (Sheet 1 of 2)

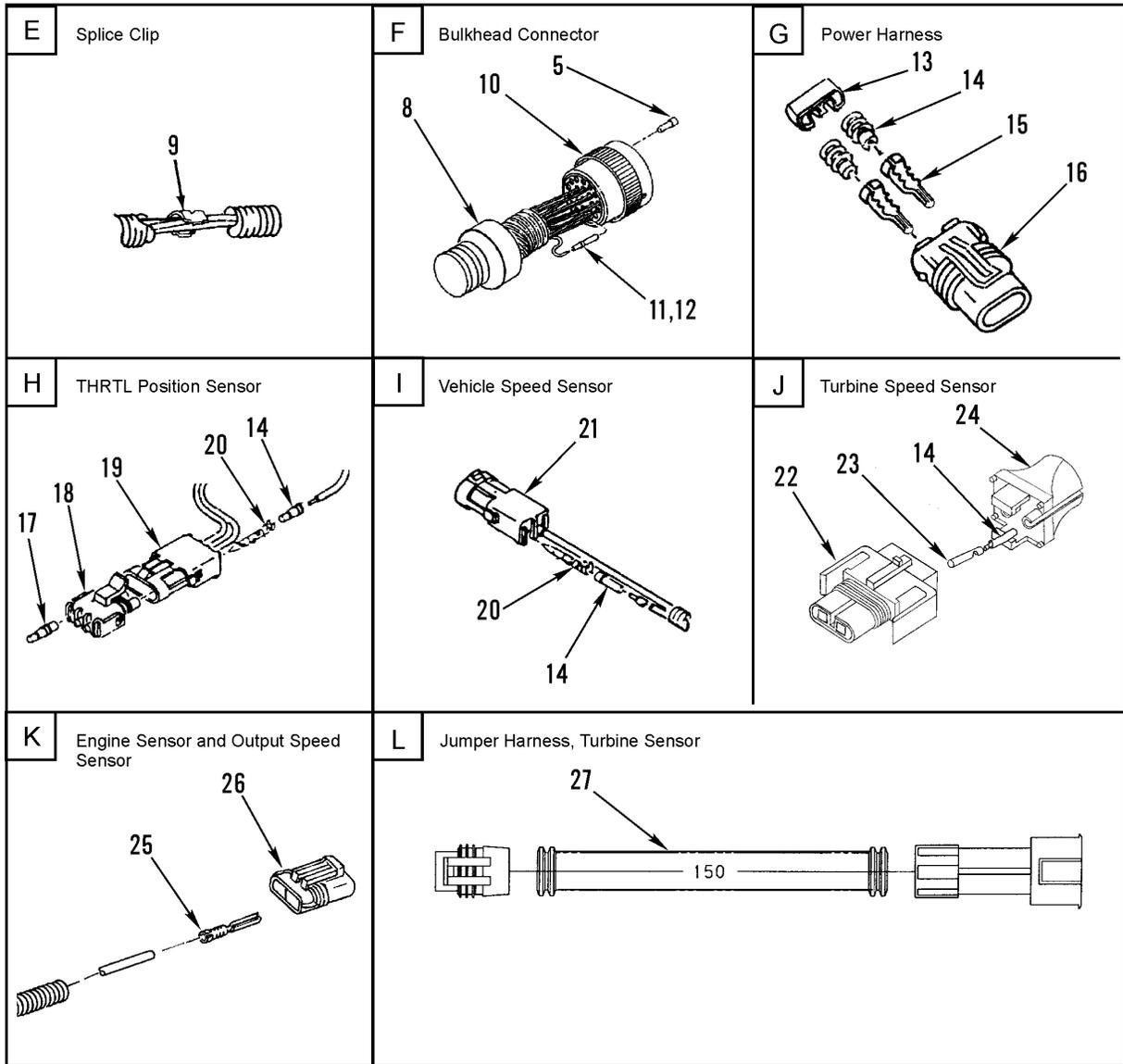

342-1534-2

Figure 117. Transmission Power Harness (Sheet 2 of 2)

SECTION II			TM9-2320-302-24P			
(1)	(2)	(3)	(4)	(5)	(6)	(7)
ITEM NO	SMR CODE	NSN	CAGEC	PART NUMBER	DESCRIPTION AND USABLE ON CODES(UOC)	QTY
					GROUP 0613 HULL OR CHASSIS WIRING HARNESS	
					FIG. 117 TRANSMISSION POWER HARNESS	
1	PAOZZ		64678	A06-29041-000	HARNESS,TRANS POWER BATTERY TO TRANS.....	1
2	PAOZZ	5920011496952	58536	AA5569/01-008	.FUSE,INCLOSED LINK.....	1
3	PAOZZ		64678	A06-28027-000	HARNESS,JUMPER.....	1
4	PAOOO		64678	A06-29039-000	HARNESS,WIRING.....	1
5	PAOZZ	5935011741235	11139	114017	.PLUG,END SEAL,ELECT.....	16
6	XDOZZ		11139	WTC06B24-31SN	.CONNECTOR 31 SOCKET.....	1
7	PAOZZ	5999012036687	11139	046220116141	.CONTACT,ELECTRICAL.....	1
8	XDOZZ		11139	88057 24 31	.SHELL,ELECTRICAL,CO 31 PIN.....	2
9	PAOZZ	5940008425353	77060	1839906	.SPLICE,CONDUCTOR.....	4
10	XDOZZ		11139	WTC06B24-31PN	.CONNECTOR.....	1
11	PAOZZ	5999013734494	11139	0460-215-16141	.CONTACT,ELECTRICAL.....	2
12	XDOZZ		11139	046220216141	.CONTACT,ELECTRICAL #18-16 AWG.....	25
13	PAOZZ	5940014621718	77060	15300014	.TERMINAL,LUG.....	1
14	PAOZZ	5330012925293	77060	12015284	.SEAL,CABLE.....	8
15	PFOZZ	5940014697988	77060	12129493	.TERMINAL,STUD.....	2
16	PAOZZ	5935013087866	77060	15300027	.CONNECTOR BODY,PLUG.....	1
17	PAOZZ	5975013399574	77060	12010300	.BOOT,DUST AND MOIST.....	6
18	PAOZZ	5935013366409	77060	1201 0717	.CONNECTOR BODY,PLUG.....	1
19	PAOZZ	5935012922336	77060	12015793	.CONNECTOR,PLUG,ELEC.....	1
20	PAOZZ	5940012347272	77060	12089040	.PIN TERMINAL.....	4
21	PAOZZ	5935012144163	22785	12010973	.CONNECTOR BODY,PLUG.....	1
22	XDOZZ		77060	12124819	.CONNECTOR,PLUG,ELEC.....	1
23	PAOZZ	5940014621717	77060	12048159	.TERMINAL,LUG.....	2
24	XDOZZ		77060	12020807	.INSERT,ELECTRICAL,C.....	1
25	XDOZZ		77060	12124075	.TERMINAL.....	4
26	PAOZZ	5935014660260	77060	12162193	.CONNECTOR,PLUG,ELEC.....	2
27	XDOZZ		64678	A06-28026-000	HARNESS,JUMPER.....	1

END OF FIGURE

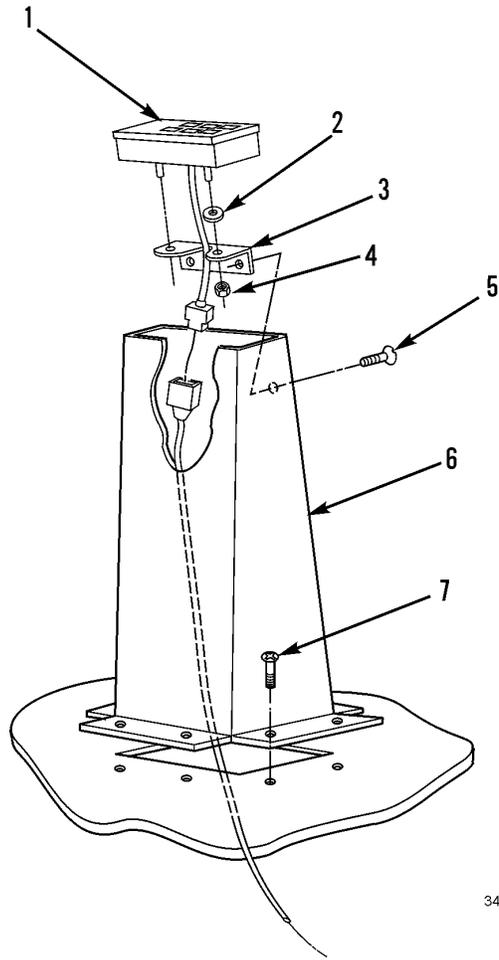

342-1413

Figure 118. Transmission Shift Control

SECTION II			TM9-2320-302-24P			
(1)	(2)	(3)	(4)	(5)	(6)	(7)
ITEM	SMR			PART		
NO	CODE	NSN	CAGEC	NUMBER	DESCRIPTION AND USABLE ON CODES(UOC)	QTY
					GROUP 07 TRANSMISSION	
					GROUP 0705 TRANSMISSION SHIFTING	
					COMPONENTS	
					FIG. 118 TRANSMISSION SHIFT CONTROL	
1	PAOZZ	2520014591944	73342	29529430	CONTROL ASSEMBLY,TR.....	1
2	PAOZZ	5310000145850	96906	MS27183-42	WASHER,FLAT.....	1
3	XDOZZ		64678	A07-16798-000	BRACKET,SHIFTER.....	1
4	PAOZZ	5310008528593	96906	MS35649-103	NUT,PLAIN,HEXAGON.....	2
5	XDOZZ		64678	23-11164-704	SCREW,MACHINE 1/4-20 X .50 TORX	2
					HEAD.....	
6	XDOZZ		64678	A07-14032-000	SHIFT TOWER ASSY.....	1
7	XDOZZ		64678	23-11164-710	SCREW,MACHINE 1/4-20 X 1.00 TORX	8
					HEAD.....	

END OF FIGURE

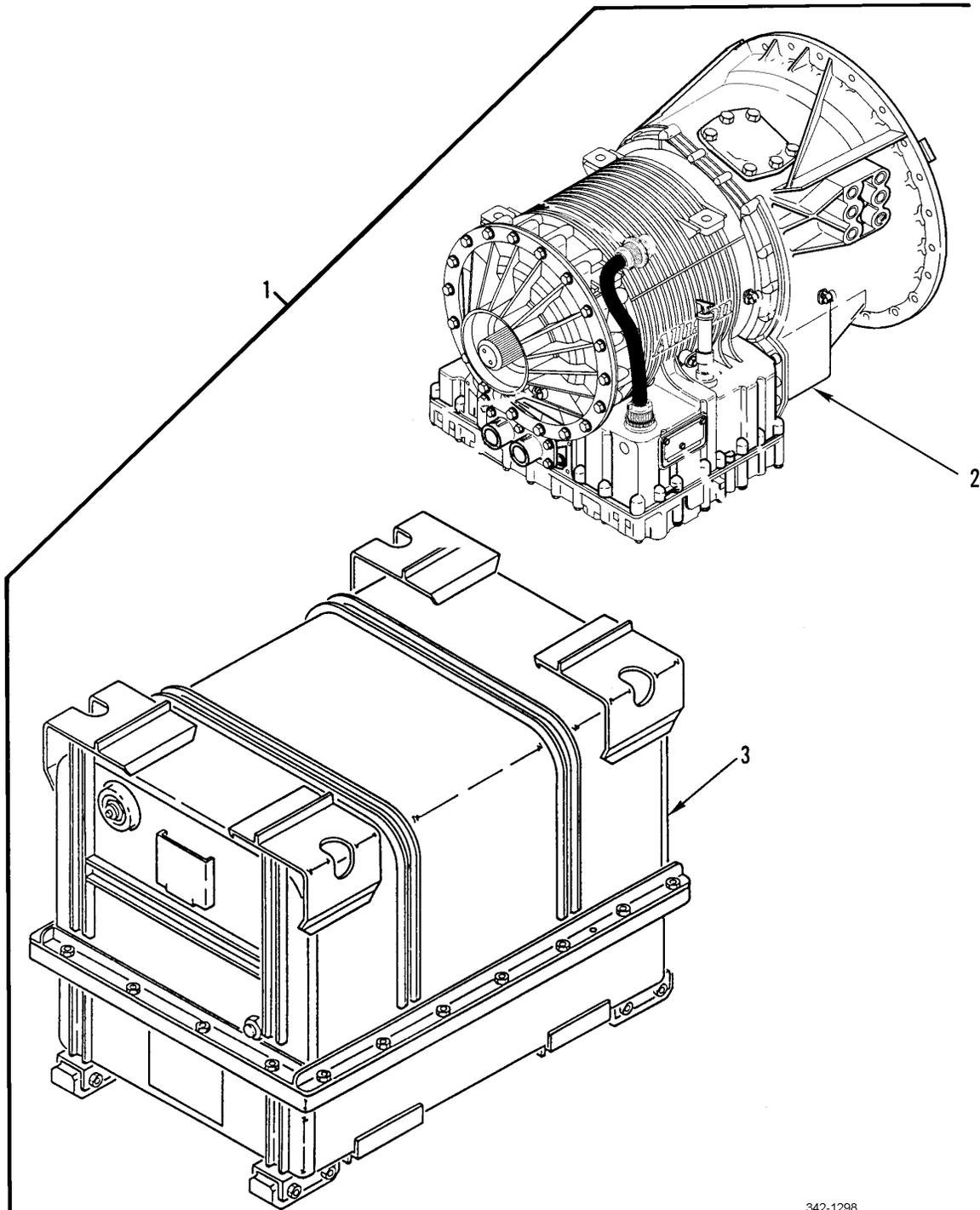

342-1298

Figure 119. Dressed Transmission and Container

SECTION II			TM9-2320-302-24P			
(1)	(2)	(3)	(4)	(5)	(6)	(7)
ITEM	SMR			PART		
NO	CODE	NSN	CAGEC	NUMBER	DESCRIPTION AND USABLE ON CODES(UOC)	QTY
					GROUP 0710 TRANSMISSION ASSEMBLY (HYDRAULIC, HYDROSTATIC, TORQUAMATIC, CROSSDRIVE) AND ASSOCIATED PARTS	
					FIG. 119 DRESSED TRANSMISSION AND CONTAINER	
1	PAFHH	2520014798832	19207	57K1749	TRANSMISSION, HYDROL TRANSMISSION WITH CONTAINER.....	1
2	XAFHH		19207	12478860	.TRANSMISSION.....	1
3	PFFFF	8145013861304	19207	12436544	.SHIPPING AND STORAG.....	1

END OF FIGURE

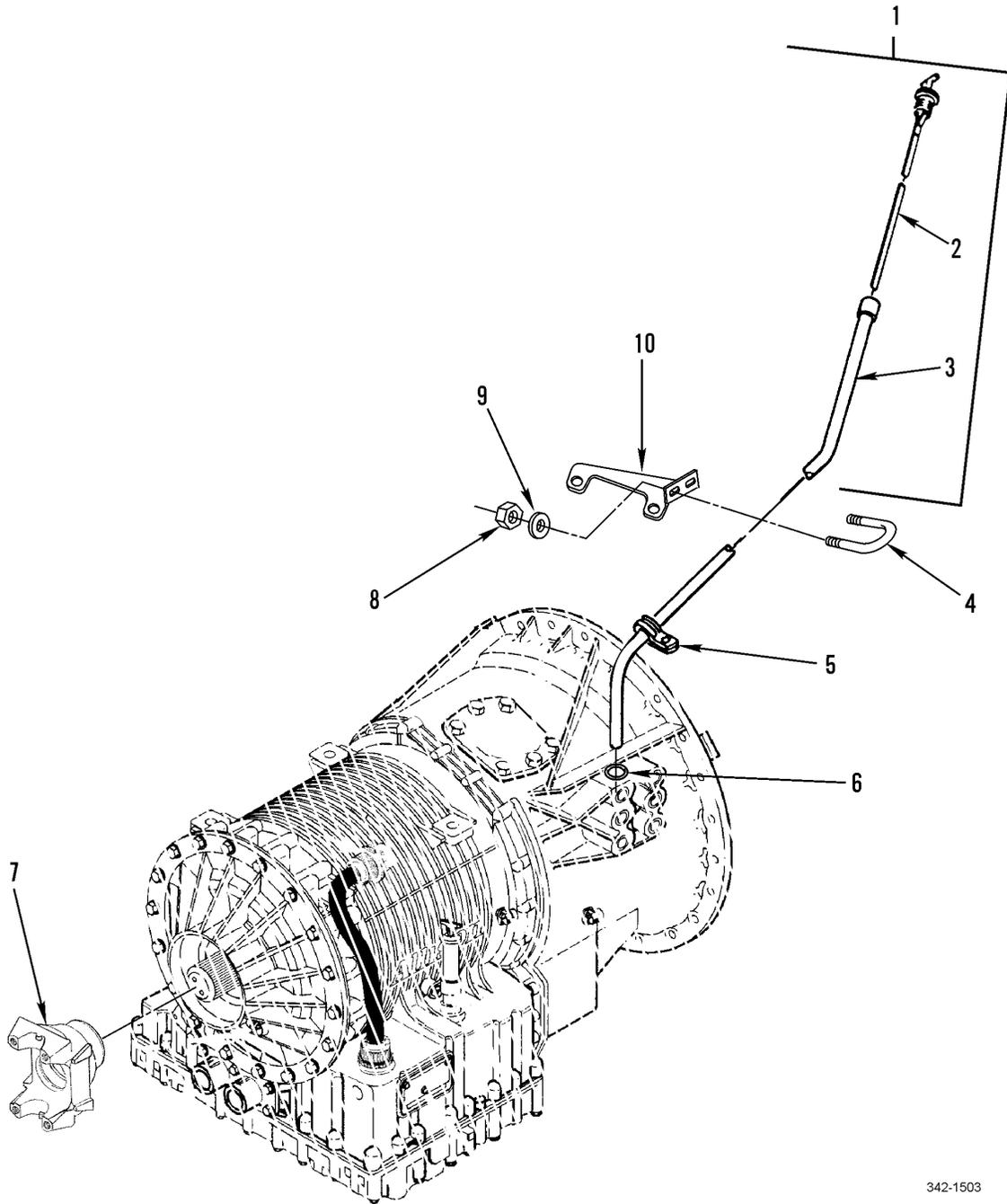

342-1503

Figure 120. Transmission Filler Tube, Rear Yoke and Attaching Hardware

SECTION II			TM9-2320-302-24P			
(1)	(2)	(3)	(4)	(5)	(6)	(7)
ITEM	SMR			PART		
NO	CODE	NSN	CAGEC	NUMBER	DESCRIPTION AND USABLE ON CODES(UOC)	QTY
					GROUP 0710 TRANSMISSION ASSEMBLY (HYDRAULIC, HYDROSTATIC, TORQUAMATIC, CROSSDRIVE) AND ASSOCIATED PARTS	
					FIG. 120 TRANSMISSION FILLER TUBE, REAR YOKE AND ATTACHING HARDWARE	
1	PAOOO	6680014786145	64678	A07-17057-003	GAGE ROD, LIQUID LEV.....	1
2	PAOZZ		OU276	42987	.GAGE, LIQUID, LEVEL.....	1
3	XDOZZ		64678	07-14642-000	.TUBE, TRANS OIL.....	1
4	XDOZZ		64678	23-09021-009	BOLT, U 1/4-20.....	1
5	XDOZZ		73342	29511834	BRACKET, SUPPORT INCLUDES SCREW M08X20.....	1
6	PAOZZ	5330013607826	73342	29507823	SEAL, NONMETALLIC RO.....	1
7	XDFZZ		73342	29510309	YOKE, UNIVERSAL JOIN.....	1
8	PAOZZ	5310013570854	64678	23-09900-104	NUT, SELF-LOCKING, HE 1/4-20UNC.....	2
9	PAOZZ	5310005825965	96906	MS35338-44	WASHER, LOCK 1/4 INCH.....	2
10	XDOZZ		64678	07-14494-000	BRACKET, ANGLE.....	1

END OF FIGURE

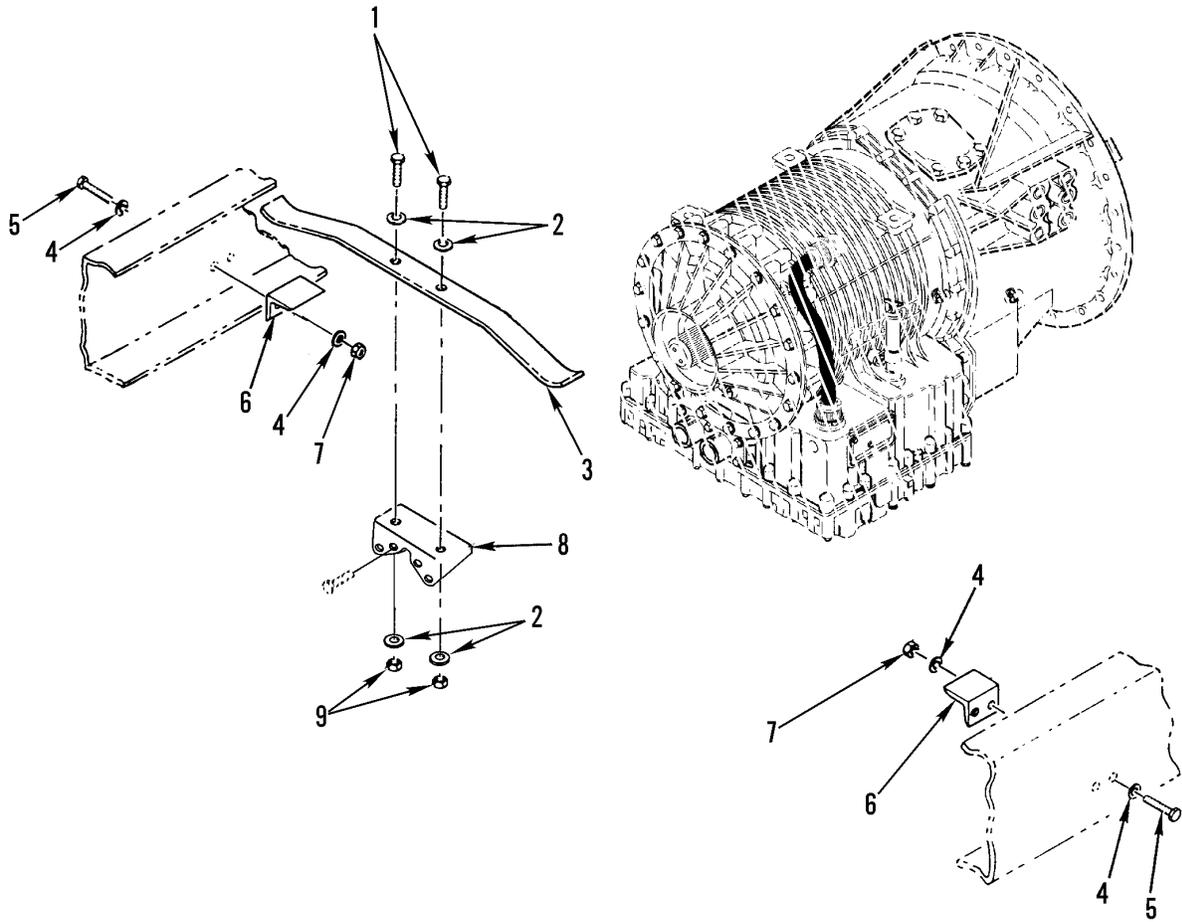

342-1505

Figure 121. Transmission Mounting Hardware

SECTION II			TM9-2320-302-24P			
(1)	(2)	(3)	(4)	(5)	(6)	(7)
ITEM	SMR			PART		
NO	CODE	NSN	CAGEC	NUMBER	DESCRIPTION AND USABLE ON CODES(UOC)	QTY
					GROUP 0710 TRANSMISSION ASSEMBLY (HYDRAULIC, HYDROSTATIC, TORQUAMATIC, CROSSDRIVE) AND ASSOCIATED PARTS	
					FIG. 121 TRANSMISSION MOUNTING HARDWARE	
1	PAFZZ	5305007247220	80204	B1821BH063C150N	SCREW,CAP,HEXAGON H 5/8-11 X 1.50..	2
2	PAFZZ	5310013052539	64678	2309114000	WASHER,FLAT.....	4
3	PAFZZ	5360013455386	64678	07-9485-000	SPRING,LEAF.....	1
4	PAFZZ	5310008095998	96906	MS27183-18	WASHER,FLAT .531 ID X 1.062 OD X .095 THK.....	8
5	PAFZZ	5305007276804	96906	MS35307-414	SCREW,CAP,HEXAGON H 1/2-13 X 1.75..	4
6	PFFZZ	5340013182049	64678	07-11652-000	BRACKET,ANGLE.....	2
7	PAFZZ	5310013192127	64678	23-09901-108	NUT,SELF-LOCKING,HE THDLK,1/2-13UNC	4
8	XDFZZ		73342	29507888	BRACKET,MOUNTING.....	1
9	PAFZZ	5310007638920	96906	MS51967-20	NUT,PLAIN,HEXAGON 5/8-11UNC.....	2

END OF FIGURE

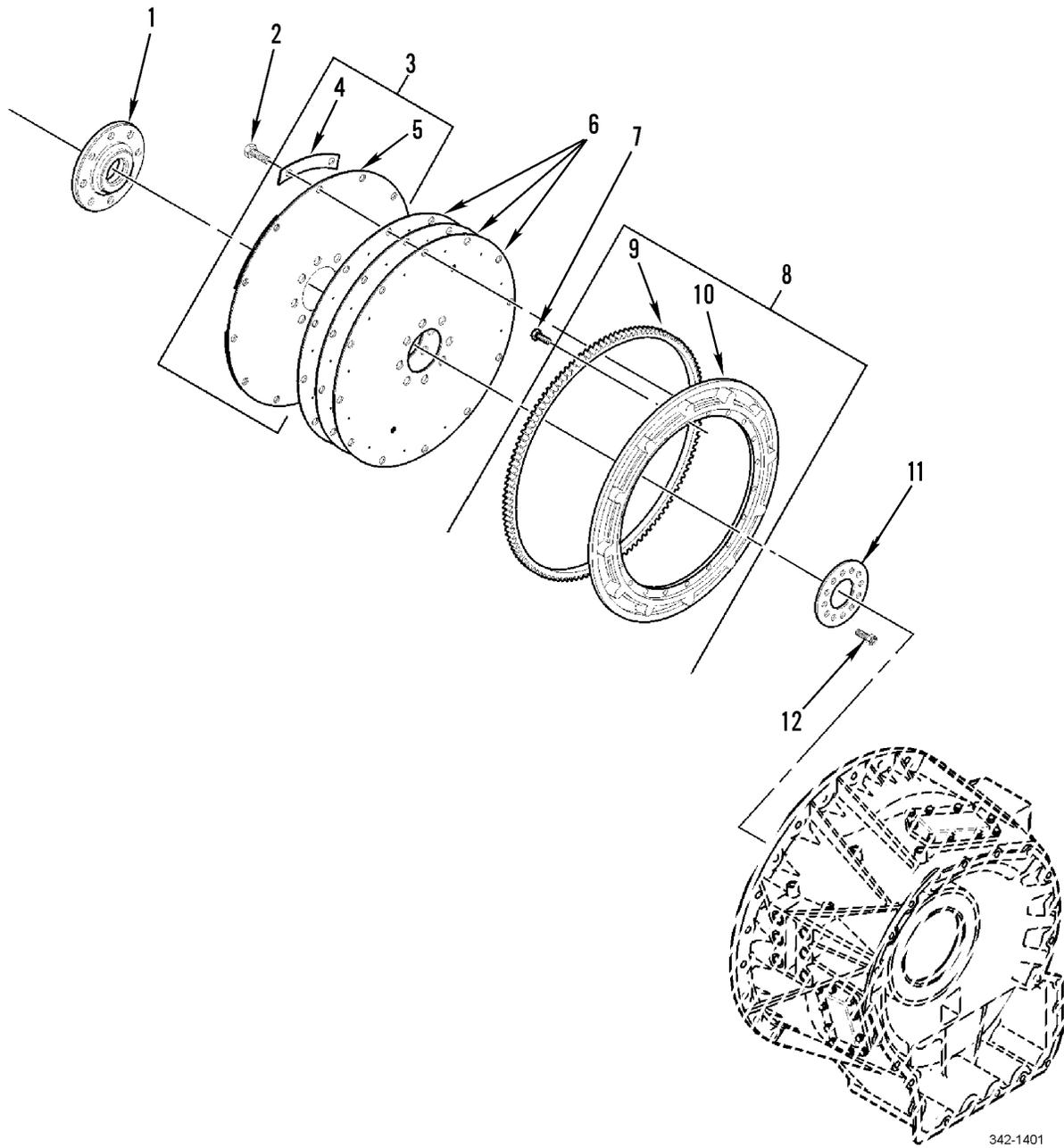

342-1401

Figure 122. Flexplate and Adapter

SECTION II			TM9-2320-302-24P			
(1)	(2)	(3)	(4)	(5)	(6)	(7)
ITEM	SMR			PART		
NO	CODE	NSN	CAGEC	NUMBER	DESCRIPTION AND USABLE ON CODES(UOC)	QTY
					GROUP 0710 TRANSMISSION ASSEMBLY (HYDRAULIC, HYDROSTATIC, TORQUAMATIC, CROSSDRIVE) AND ASSOCIATED PARTS	
					FIG. 122 FLEXPLATE AND ADAPTER	
1	XDFZZ		73342	29510823	ADAPTER, CRANK HUB.....	1
2	PAFZZ	5305011582041	34914	992 4051	SCREW, CAP, HEXAGON H.....	2
3	XDFFF		73342	29513004	FLEXPLATE ASSY.....	1
4	XAFZZ		73342	29511880	. PLATE, BOLT.....	6
5	XAFZZ		73342	29513005	. FLEXPLATE.....	1
6	XDFZZ		73342	29513005	FLEXPLATE.....	3
7	PAFZZ	5305013602038	73342	11505232	SCREW, CAP, HEXAGON H.....	12
8	XDFFF		73342	29513006	ADAPTER ASSY, FLEX P.....	1
9	PAFZZ	3020005177586	72582	5166664	. GEAR, SPUR.....	1
10	XAFZZ		73342	29513007	. ADAPTER, FLEXPLATE.....	1
11	XDFZZ		73342	29514029	PLATE, WEAR.....	1
12	XDFZZ		73342	29513725	BOLT, FLATHEAD M5 X 0.8 X 14MM.....	2

END OF FIGURE

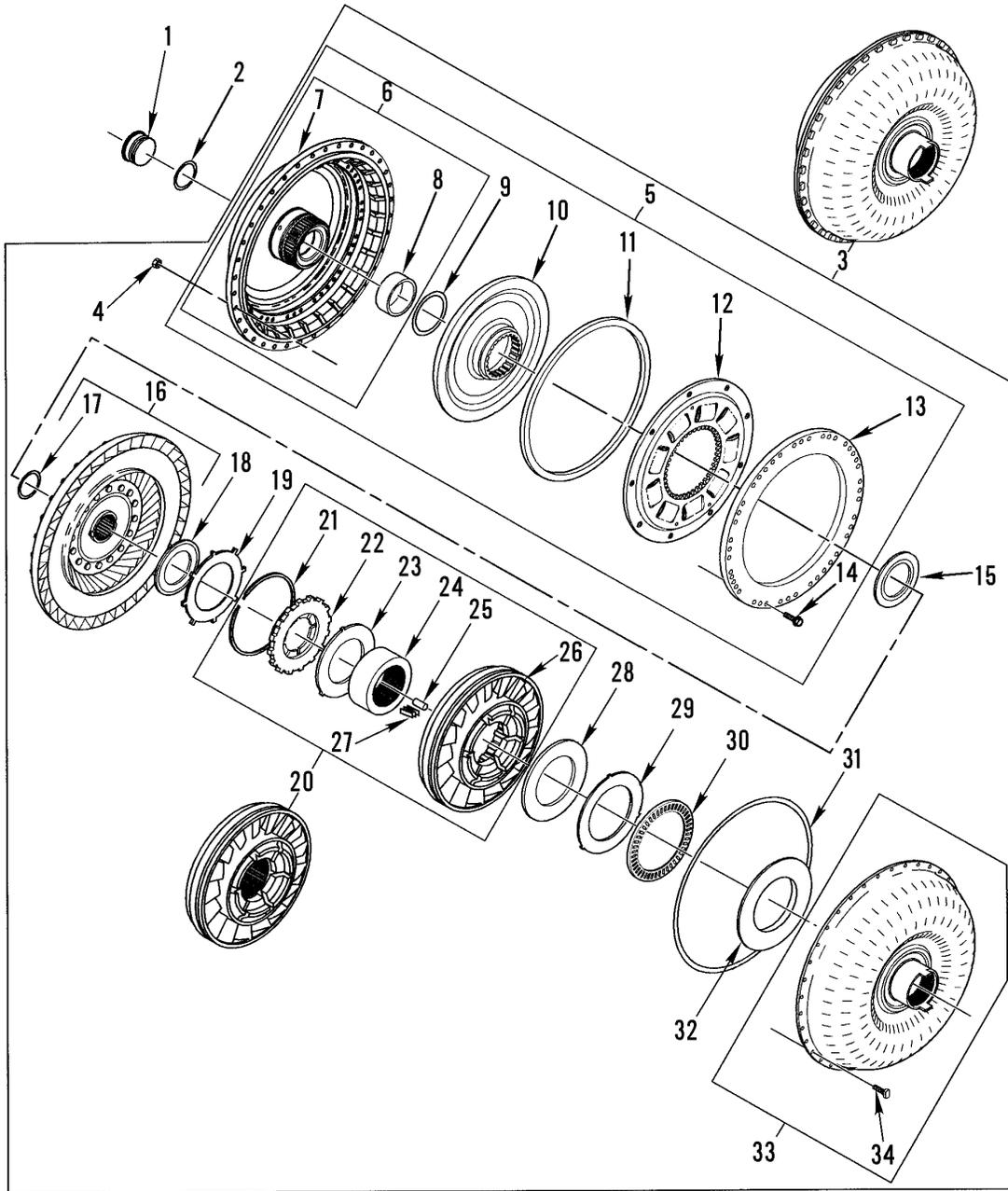

342-1402

Figure 123. Torque Converter Assembly

SECTION II			TM9-2320-302-24P			
(1)	(2)	(3)	(4)	(5)	(6)	(7)
ITEM	SMR			PART		
NO	CODE	NSN	CAGEC	NUMBER	DESCRIPTION AND USABLE ON CODES(UOC)	QTY
GROUP 0710 TRANSMISSION ASSEMBLY (HYDRAULIC, HYDROSTATIC, TORQUAMATIC, CROSSDRIVE) AND ASSOCIATED PARTS						
FIG. 123 TORQUE CONVERTER ASSEMBLY						
1	XDHZZ		73342	29535581	COVER, ACCESS.....	1
2	PAHZZ	5330013619785	73342	29503208	RETAINER, PACKING 45.82 MM ID.....	1
3	AHHHH		73342	29535584	TORQUE CONVERTER.....	1
4	XDHZZ		73342	29501339	.NUT, PLAIN HEXAGON H M8 X 1.25 MM..	36
5	AHHHH		73342	29514154	.COVER ASSEMBLY, CONV.....	1
6	XDHZZ		73342	29535596	..COVER ASSEMBLY, CONV.....	1
7	XAHZZ		73342	29501321	...COVER, CONVERTER.....	1
8	XDHZZ		73342	29505782	BUSHING 66.82 MM ID.....	1
9	XDHZZ		73342	29501323	..SEALRING, LOCKUP 98.42 MM ID.....	1
10	XDHZZ		73342	29505783	..PISTON ASSY, LOCKUP.....	1
11	XDHZZ		73342	29501326	..SEALRING, LOCKUP.....	1
12	XDHZZ		73342	29501327	..DAMPER ASSEMBLY.....	1
13	XDHZZ		73342	29514677	..BACKPLATE, LOCKUP.....	1
14	XDHZZ		73342	29514683	..BOLT, FLANGE HEAD M8 X 1.25 X 25MM	44
15	XDHZZ		73342	29511436	.BEARING ASSEMBLY THRUST BEARING NO. 1.....	1
16	XDHHH		73342	29506620	.TURBINE ASSEMBLY.....	1
17	XDHZZ		73342	29501318	..SEAL, PLAIN 66.784MM OD.....	1
18	XDHZZ		73342	29500713	.BEARING ASSEMBLY THRUST BEARING NO. 2.....	1
19	XDHZZ		73342	29506616	.WASHER, TANGED.....	1
20	XDHHH		73342	29506623	.STATOR ASSY, CONVERT.....	1
21	XDHZZ		73342	29501304	..RING, RETAINING 164.91MM OD.....	1
22	XDHZZ		H1934	29506622	..RING, RETAINING.....	1
23	XDHZZ		73342	29501301	..WASHER, THRUST.....	1
24	XDHZZ		73342	29501298	..RACE, STATOR.....	1
25	XDHZZ		73342	29501299	..ROLLER, STATOR 9.526 X 25.525MM...	13
26	XDHZZ		73342	29503873	..STATOR & CAM ASSY.....	1
27	XDHZZ		73342	29501300	..SPRING, STATOR.....	13
28	XDHZZ		73342	29503879	.SHIM, CONVERTER 0.27MM (0.011 IN), QTY AS REQUIRED.....	1
28	XDHZZ		73342	29503880	.SHIM, CONVERTER 0.48MM (0.019 IN), QTY AS REQUIRED.....	1
28	XDHZZ		73342	29503881	.SHIM, CONVERTER 0.711MM (0.028 IN), QTY AS REQUIRED.....	1
29	XDHZZ		73342	29503876	.RACE, TANGED.....	1
30	XDHZZ		73342	29503877	.BEARING ASSY, THRUST.....	1
31	PAHZZ	5331014787278	73342	29506675	.O-RING 367.8MM ID.....	1
32	XDHZZ		73342	29506629	.RACE, LIPPED.....	1
33	XDHZZ		73342	29514723	.PUMP ASSEMBLY INCLUDES T-HEAD BOLTS.....	1
34	PAHZZ	5306013601970	73342	29500616	..BOLT, TEE HEAD M8 X 1.25 X 19MM...	36

END OF FIGURE

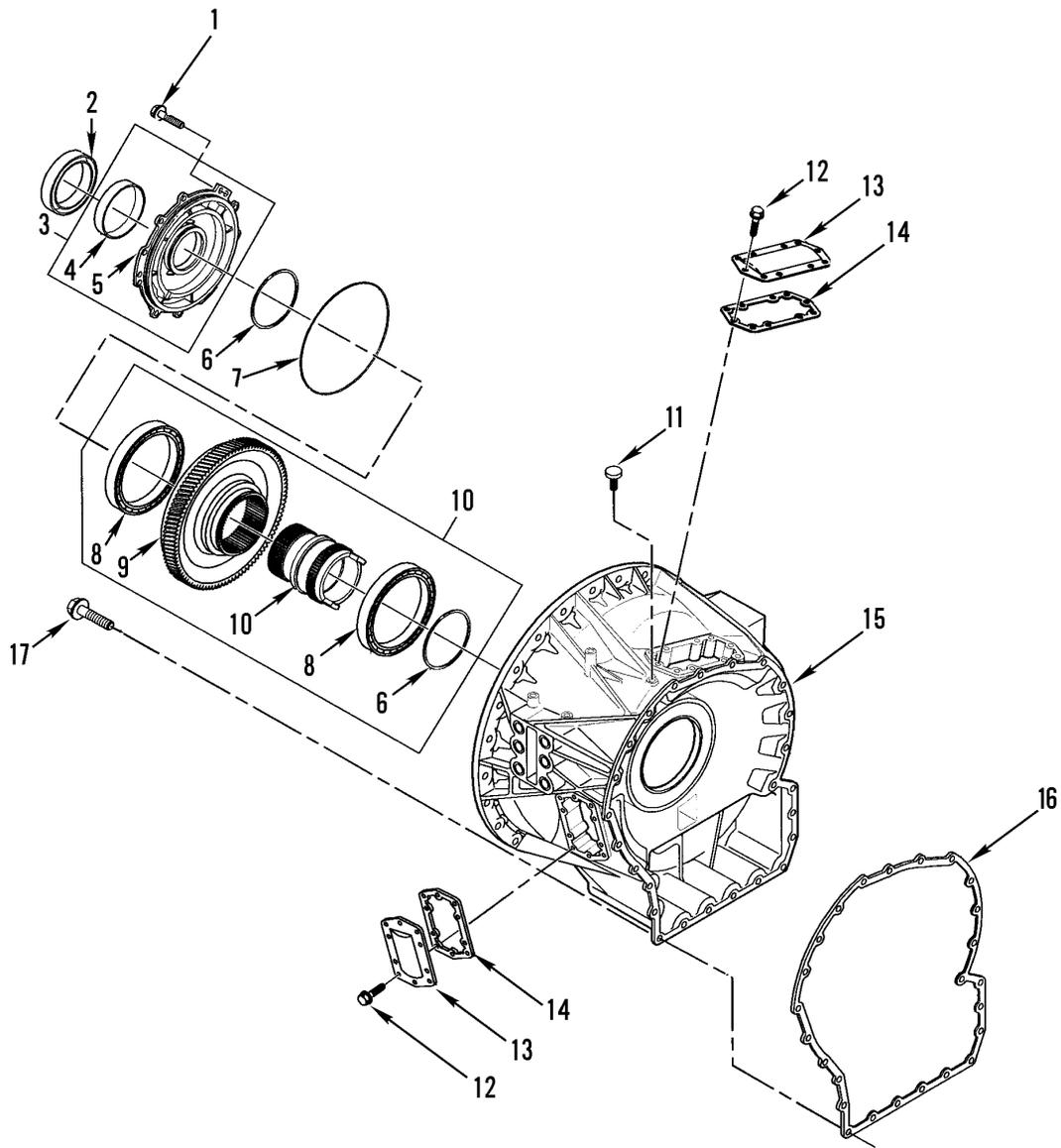

342-1403

Figure 124. Torque Converter Housing Components

SECTION II			TM9-2320-302-24P			
(1)	(2)	(3)	(4)	(5)	(6)	(7)
ITEM	SMR			PART		
NO	CODE	NSN	CAGEC	NUMBER	DESCRIPTION AND USABLE ON CODES(UOC)	QTY
					GROUP 0710 TRANSMISSION ASSEMBLY (HYDRAULIC, HYDROSTATIC, TORQUAMATIC, CROSSDRIVE) AND ASSOCIATED PARTS	
					FIG. 124 TORQUE CONVERTER HOUSING COMPONENTS	
1	PAHZZ	5305011531375	7X677	11500930	SCREW,CAP,HEXAGON H.....	11
2	PAHZZ	5330014669015	26095	29505859	PACKING ASSEMBLY 10.27MM OD.....	1
3	PFHHH		73342	29511448	RETAINER & BUSHING.....	1
4	XDHZZ		73342	29537060	.BUSHING.....	1
5	XAHZZ		73342	29501420	.RETAINER,BEARING.....	1
6	PAHZZ		73342	29518438	SEALRING .108MM OD.....	2
7	PAHZZ		73342	23047945	SEALRING 245.57MM OD.....	1
8	PAHZZ		73342	29501421	BEARING ASSY,BALL.....	2
9	XDHZZ		73342	29514709	GEAR,PTO.....	1
10	XDHZZ		73342	29515650	HUB,PTO DRIVE.....	1
11	PAOZZ	2520013884778	73342	23047102	BREATHER.....	1
12	PAHZZ	5306013383981	21969	DIN933-M10X25-8. 8-B3B	BOLT,MACHINE M10 X 1.5 X 25MM.....	20
13	PAHZZ	5340013601048	73342	23048038	COVER,ACCESS.....	2
14	PAHZZ	5330013607520	73342	23048037	GASKET.....	2
15	XDHZZ		73342	29524122	HOUSING, CONVERTER.....	1
16	PAHZZ	5330014787279	73342	29505858	GASKET.....	1
17	PAOZZ	5305012511626	7X677	12337902	SCREW,CAP,HEXAGON H M10 X 1.5 X 35MM.....	25

END OF FIGURE

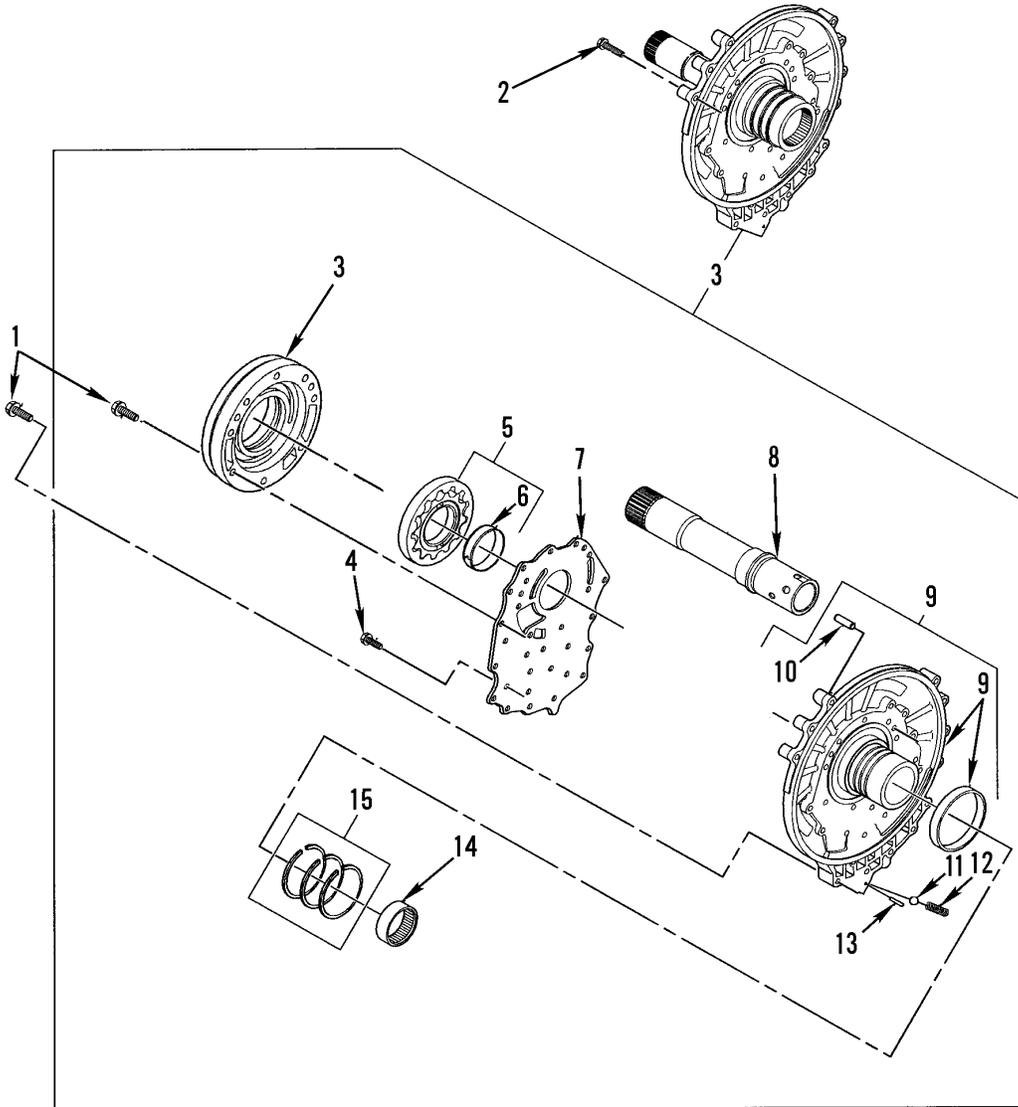

342-1404

Figure 125. Front Support and Oil Pump Assembly

SECTION II			TM9-2320-302-24P			
(1)	(2)	(3)	(4)	(5)	(6)	(7)
ITEM NO	SMR CODE	NSN	CAGEC	PART NUMBER	DESCRIPTION AND USABLE ON CODES(UOC)	QTY
					GROUP 0710 TRANSMISSION ASSEMBLY (HYDRAULIC, HYDROSTATIC, TORQUAMATIC, CROSSDRIVE) AND ASSOCIATED PARTS	
					FIG. 125 FRONT SUPPORT AND OIL PUMP ASSEMBLY	
1	XDHZZ		73342	11501822	BOLT M10 X 1.5 X 65MM.....	15
2	PAHZZ	5305012511626	7X677	12337902	SCREW,CAP,HEXAGON H M10 X 1.5 X 35MM.....	7
3	XDHZZ		73342	29505699	HOUSING,PUMP.....	1
4	PAHZZ	5306013383981	21969	DIN933-M10X25-8. 8-B3B	BOLT,MACHINE M10 X 1.5 X 25MM.....	14
5	XDHHH		73342	29515688	GEAR SET.....	1
6	PAHZZ		73342	29527102	.BUSHING.....	1
7	XDHZZ		73342	29501013	PLATE,WEAR.....	1
8	XDHZZ		73342	29516490	SLEEVE,GROUND.....	1
9	XDHHH		73342	29512739	SUPPORT ASSY,FRONT.....	1
10	PAHZZ	5315013605913	73342	29501135	.PIN,STRAIGHT,HEADLE 10 X 32MM.....	2
11	PAHZZ	3110001006170	24617	145651	BALL,BEARING 19.05MM.....	1
12	PAHZZ	5360014532343	73342	29507709	SPRING,HELICAL,COMP 17.96 OD X 52.38MM.....	1
13	PAHZZ	5315014536936	73342	29516030	PIN,STRAIGHT,HEADLE 6 X 34.5MM.....	1
14	PAHZZ	3110014787434	73342	29505573	BEARING,ROLLER,CYLI.....	1
15	XDHZZ		73342	29518440	SEALRING KIT INCLUDES 3 RINGS.....	1

END OF FIGURE

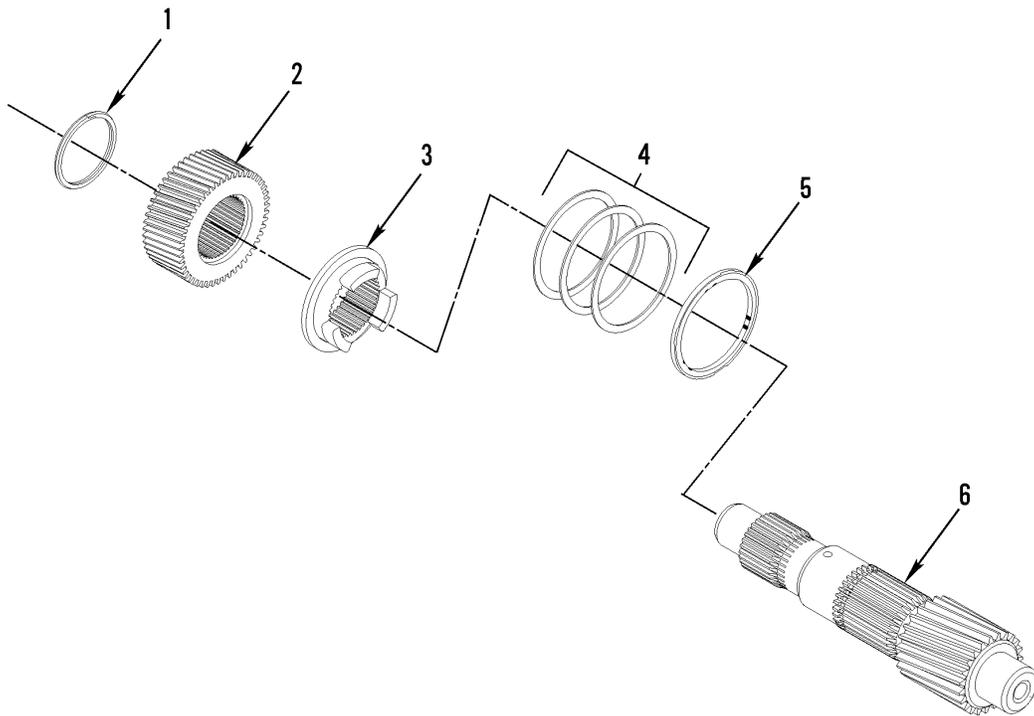

342-1405

Figure 126. Main Shaft

SECTION II			TM9-2320-302-24P			
(1)	(2)	(3)	(4)	(5)	(6)	(7)
ITEM	SMR			PART		
NO	CODE	NSN	CAGEC	NUMBER	DESCRIPTION AND USABLE ON CODES(UOC)	QTY
					GROUP 0710 TRANSMISSION ASSEMBLY (HYDRAULIC, HYDROSTATIC, TORQUAMATIC, CROSSDRIVE) AND ASSOCIATED PARTS	
					FIG. 126 MAIN SHAFT	
1	XDHZZ		73342	29507871	RING,RETAINING 54.6MM ID.....	1
2	XDHZZ		73342	29505607	GEAR,P2 SUN.....	1
3	XDHZZ		73342	29535630	SPACER,BEARING.....	1
4	XDHZZ		73342	29503218	SHIM 0.27 MM (0.01 INCH).....	1
4	XDHZZ		73342	29503219	SHIM 0.54MM (0.02 INCH).....	1
4	XDHZZ		73342	29503220	SHIM 0.81MM (0.03 INCH).....	1
4	XDHZZ		73342	29503221	SHIM 1.08 MM (0.4 INCH).....	1
4	XDHZZ		73342	29503222	SHIM 1.35MM (0.05 INCH).....	1
4	XDHZZ		73342	29503223	SHIM 1.62MM (0.06 INCH).....	1
4	XDHZZ		73342	29503224	SHIM 1.89MM (0.07 INCH).....	1
5	PAHZZ	3120013607544	73342	29503225	BEARING,WASHER,THRU.....	1
6	XDHZZ		73342	29505634	SHAFT,MAIN.....	1

END OF FIGURE

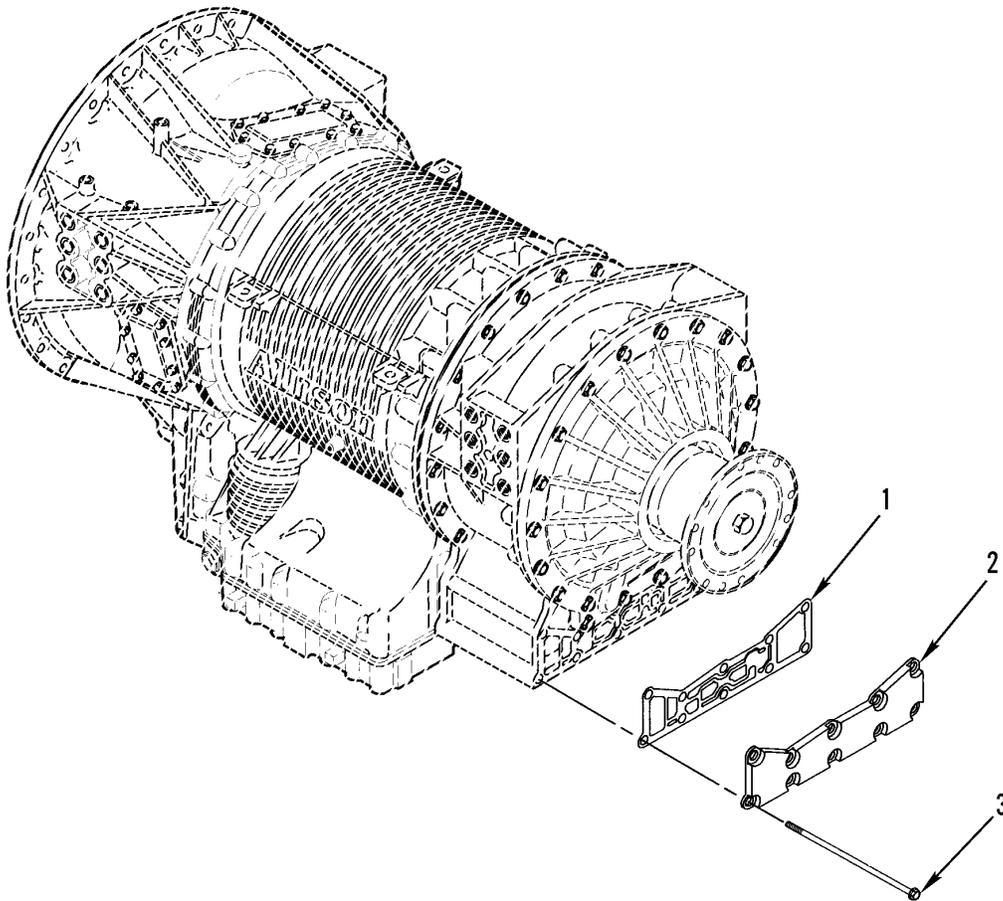

342-1406

Figure 127. Main Housing and Related Components

SECTION II			TM9-2320-302-24P			
(1)	(2)	(3)	(4)	(5)	(6)	(7)
ITEM	SMR			PART		
NO	CODE	NSN	CAGEC	NUMBER	DESCRIPTION AND USABLE ON CODES(UOC)	QTY
					GROUP 0710 TRANSMISSION ASSEMBLY (HYDRAULIC, HYDROSTATIC, TORQUAMATIC, CROSSDRIVE) AND ASSOCIATED PARTS	
					FIG. 127 MAIN HOUSING AND RELATED COMPONENTS	
1	PAHZZ	5330014610587	73342	29503547	GASKET.....	1
2	XDHZZ		73342	29506507	COVER, COOLER PORT.....	1
3	XDHZZ		73342	29507795	BOLT, FLANGE HEAD M10 X 1.5 X 28MM..	6

END OF FIGURE

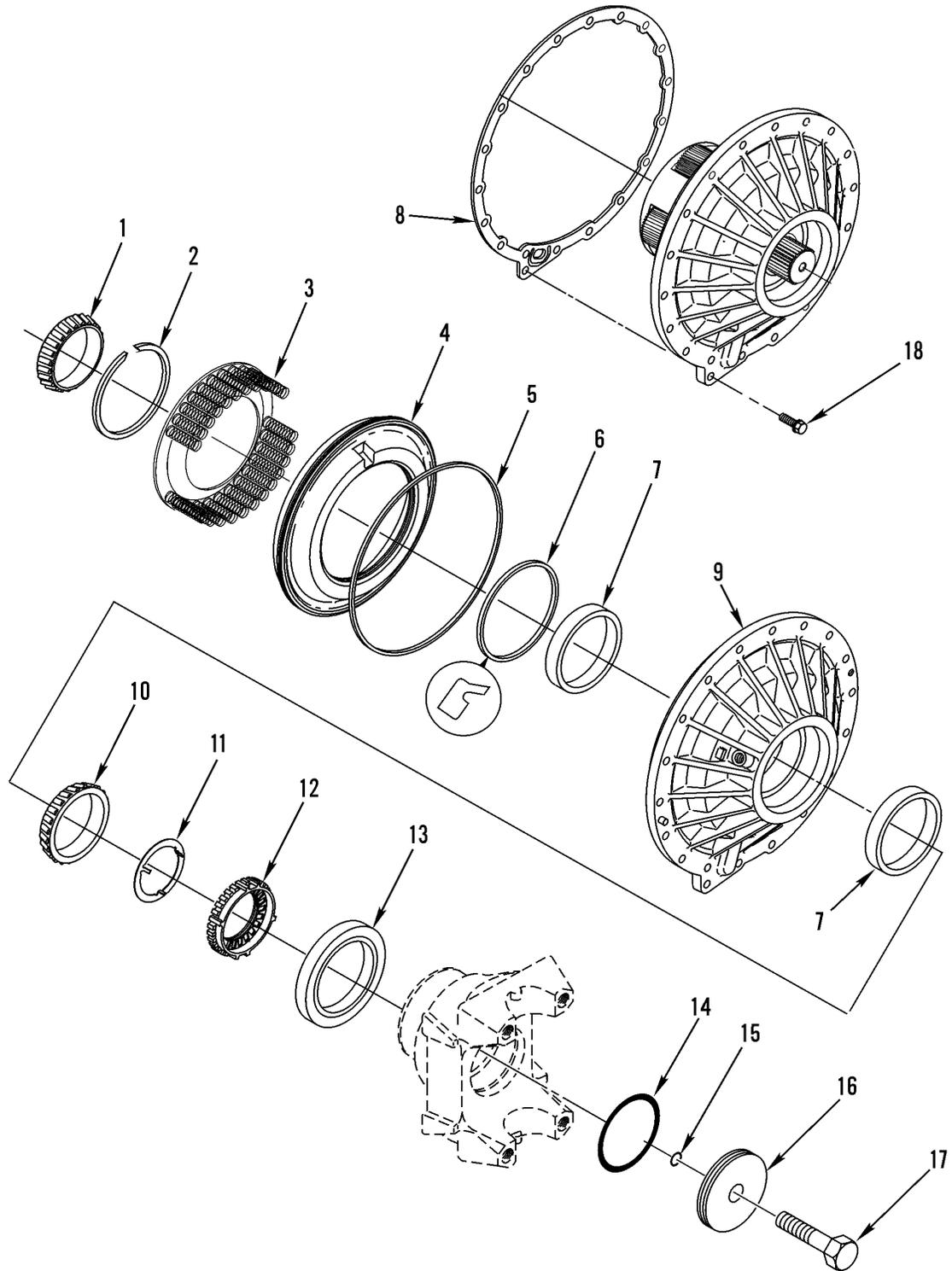

Figure 128. Rear Cover and Component Parts

SECTION II			TM9-2320-302-24P			
(1)	(2)	(3)	(4)	(5)	(6)	(7)
ITEM	SMR			PART		
NO	CODE	NSN	CAGEC	NUMBER	DESCRIPTION AND USABLE ON CODES(UOC)	QTY
					GROUP 0710 TRANSMISSION ASSEMBLY (HYDRAULIC, HYDROSTATIC, TORQUAMATIC, CROSSDRIVE) AND ASSOCIATED PARTS	
					FIG. 128 REAR COVER AND COMPONENT PARTS	
1	XDHZZ		73342	29505613	BEARING ASSY,ROLLER.....	1
2	XDHZZ		73342	29503037	RING,RETAINING 181MM ID.....	1
3	XDHZZ		73342	29503036	SPRING & RETAINER C5 CLUTCH.....	1
4	XDHZZ		73342	29503035	PISTON C5 CLUTCH.....	1
5	PFHZZ		73342	23047920	SEAL RING,EXTERNAL 315.5MM ID.....	1
6	PFHZZ	5331014787281	73342	23048164	O-RING 214.06MM OD.....	1
7	XDHZZ		73342	29505574	CUP,ROLLER BEARING.....	2
8	PAHZZ	5330014787285	73342	29534355	GASKET.....	1
9	XDHZZ		73342	29515664	COVER,REAR.....	1
10	XDHZZ		73342	29505613	BEARING ASSY,ROLLER.....	1
11	PFHZZ	5325014789348	73342	29511429	RING,RETAINING.....	1
12	XDHZZ		73342	29511450	NUT,SPECIAL.....	1
13	PFHZZ		73342	29515691	SEAL,PLAIN 165.61MM OD.....	1
14	PAFZZ	5331014669013	73342	29511444	O-RING 75.88MM ID.....	1
15	PAFZZ	5331014787287	73342	29512875	O-RING 12.29MM ID.....	1
16	XDFZZ		73342	29535215	PLATE,RETAINING.....	1
17	XDFZZ		73342	29535219	BOLT M14 X 50MM.....	1
18	PAHZZ	5306013602033	73342	11515190	BOLT,MACHINE.....	19

END OF FIGURE

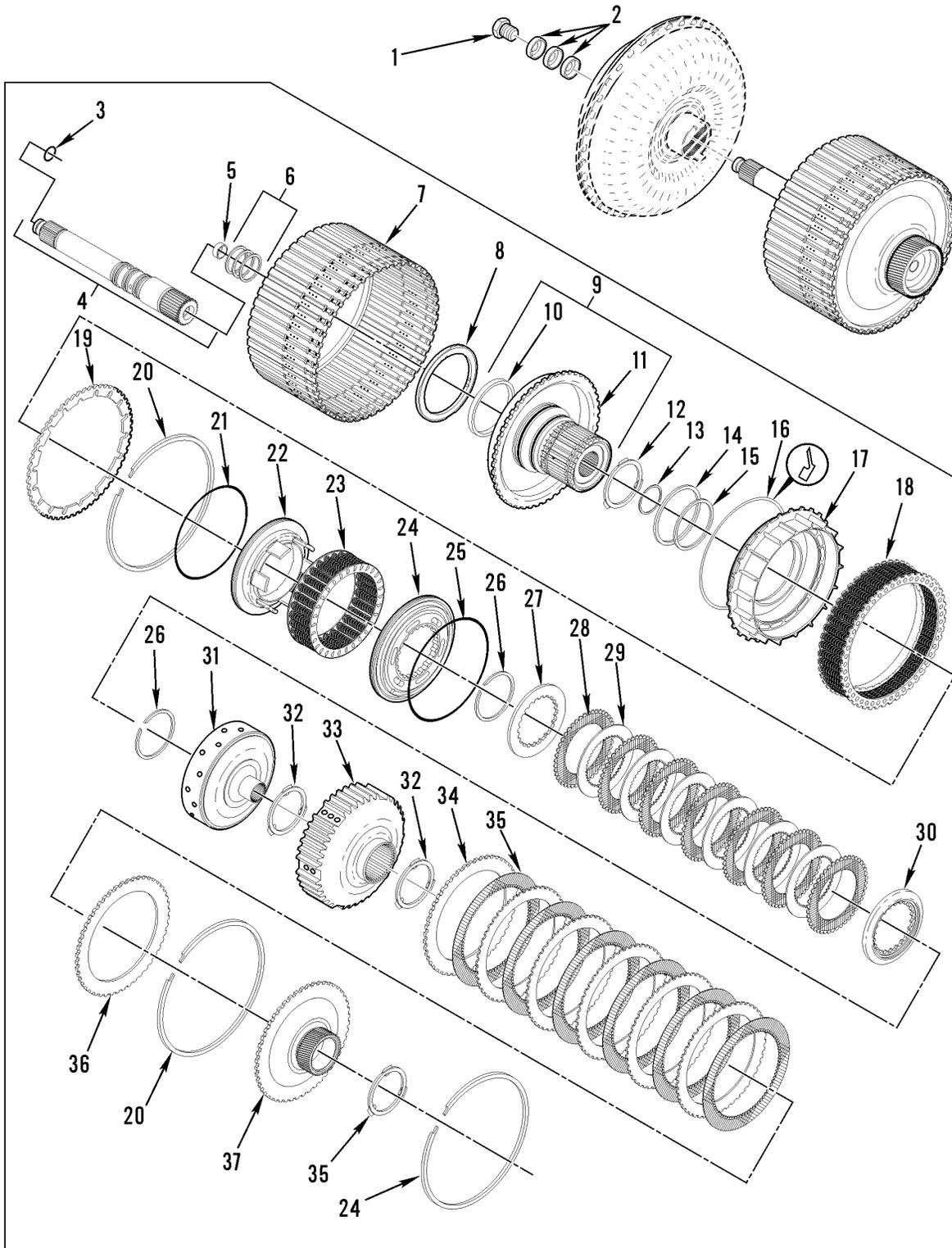
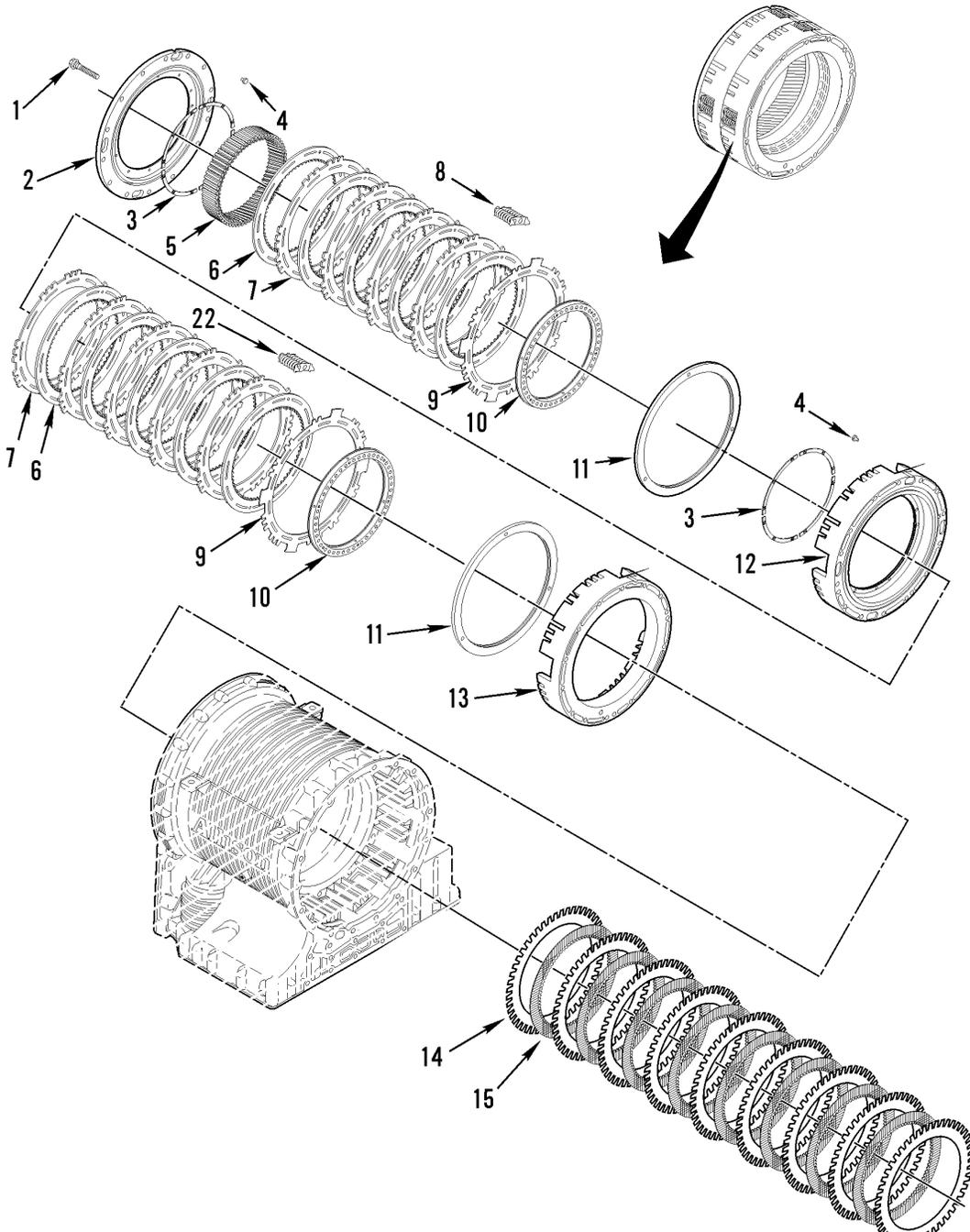

Figure 129. Rotating Clutch Assembly

SECTION II		TM9-2320-302-24P				
(1)	(2)	(3)	(4)	(5)	(6)	(7)
ITEM NO	SMR CODE	NSN	CAGEC	PART NUMBER	DESCRIPTION AND USABLE ON CODES(UOC)	QTY
GROUP 0713 INTERMEDIATE CLUTCH						
FIG. 129 ROTATING CLUTCH ASSEMBLY						
1	PAHZZ	5305013297038	75755	19M8029	SCREW,CAP,HEXAGON H M16 X 2 X 30MM.	1
2	XDHZZ		73342	29507794	SHIM 5.448MM (0.214 INCH), AS REQUIRED.....	1
2	XDHZZ		73342	29507793	SHIM 5.270MM (0.207 INCH), AS REQUIRED.....	1
2	PAHZZ	5365013601017	73342	29505686	SHIM 5.092MM (0.200 INCH), AS REQUIRED.....	1
2	PAHZZ	5365013601721	73342	29505685	SHIM 4.914MM (0.193 INCH), AS REQUIRED.....	1
2	PAHZZ	5365013601018	73342	29505684	SHIM 4.736MM (0.186 INCH), AS REQUIRED.....	1
2	PAHZZ	5365013601019	73342	29505683	SHIM 4.559MM (0.179 INCH), AS REQUIRED.....	2
2	PAHZZ	5365013601020	73342	29505682	SHIM 4.381MM (0.172 INCH), AS REQUIRED.....	1
2	PAHZZ	5365013601021	73342	29505681	SHIM 4.203MM (0.165 INCH), AS REQUIRED.....	1
2	PAHZZ	5365013601022	73342	29505688	SHIM 4.0MM (0.157 INCH), AS REQUIRED.....	1
3	PAHZZ	5331013606018	73342	23046274	O-RING 25.4MM ID.....	1
4	XDHZZ		73342	29516499	SHAFT ASSEMBLY.....	1
5	PFHZZ	3120014787470	73342	29505605	BUSHING,SLEEVE 28MM ID.....	1
6	PFHZZ	5330014787289	73342	29518439	GASKET AND SEAL SET 59.4MM OD.....	1
7	XDHZZ		73342	29505715	DRUM,CLUTCH.....	1
8	XDHZZ		73342	29505572	BEARING ASSY,THRUST.....	1
9	XDHZZ		73342	29534504	HUB ASSEMBLY,CLUTCH.....	1
10	XDHZZ		73342	29501485	BUSHING 99MM ID.....	1
11	XAHZZ		73342	29534503	HUB ASSEMBLY,CLUTCH.....	1
12	PAHZZ	3120013607544	73342	29503225	BEARING,WASHER,THRU.....	1
13	XDHZZ		73342	23048131	RING,RETAINING 60.07MM ID.....	1
14	PAHZZ	5330014787291	73342	23048095	SEAL,PLAIN 156MM.....	1
15	PFHZZ	5330014787292	73342	23048096	SEAL,PLAIN 126MM.....	1
16	PFHZZ	5330014787293	73342	23048098	SEAL RING,METAL 262MM.....	1
17	XDHZZ		73342	29505717	PISTON C2.....	1
18	XDHZZ		73342	29505719	SPRING ASSEMBLY C2 PISTON.....	1
19	XDHZZ		73342	29505716	PLATE C2 SPRING.....	1
20	XDHZZ		73342	23049409	RING,RETAINING 337.4MM OD.....	3
21	PAHZZ	5330013609103	73342	23045615	SEAL RING,METAL 222MM, C1 PISTON...	1
22	XDHZZ		73342	29534577	PISTON C1.....	1
23	XDHZZ		73342	29509453	SPRING ASSEMBLY C1 PISTON.....	1
24	XDHZZ		73342	29534576	PISTON,BALANCE.....	1
25	PAHZZ	5331014787295	73342	23048104	O-RING 262MM.....	1
26	XDHZZ		73342	23048105	RING,RETAINING 11MM ID.....	2
27	XDHZZ		73342	29534573	PLATE C1 CLUTCH.....	1
28	XDHZZ		73342	29511462	PLATE C1 FRICTION.....	7
29	XDHZZ		73342	29505759	PLATE C1 REACTION.....	6
30	XDHZZ		73342	29534572	BACKPLATE C1 CLUTCH.....	1
31	XDHZZ		73342	29511461	HUB C1 DRIVE.....	1

SECTION II			TM9-2320-302-24P			
(1)	(2)	(3)	(4)	(5)	(6)	(7)
ITEM	SMR			PART		
NO	CODE	NSN	CAGEC	NUMBER	DESCRIPTION AND USABLE ON CODES(UOC)	QTY
32	XDHZZ		73342	29501221	BEARING ASSY,THRUST.....	3
33	XDHZZ		73342	29501068	HUB C2 DRIVE.....	1
34	XDHZZ		73342	29505720	PLATE C2 REACTION.....	7
35	XDHZZ		73342	29505823	PLATE C2 FRICTION.....	7
36	XDHZZ		73342	29505714	BACKPLATE C2 CLUTCH.....	1
37	XDHZZ		73342	39534511	GEAR ASSEMBLY P1 SUN.....	1

END OF FIGURE



342-1409

Figure 130. C3/C4 Clutch Assembly

SECTION II			TM9-2320-302-24P			
(1)	(2)	(3)	(4)	(5)	(6)	(7)
ITEM	SMR			PART		
NO	CODE	NSN	CAGEC	NUMBER	DESCRIPTION AND USABLE ON CODES(UOC)	QTY
GROUP 0713 INTERMEDIATE CLUTCH						
FIG. 130 C3/C4 CLUTCH ASSEMBLY						
1	PAHZZ	5305013599445	73342	11515469	SCREW,CAP,HEXAGON H M10 X 1.5 X 100MM.....	14
2	XDHZZ		73342	29507815	BACKPLATE ASSY,CLUT.....	1
3	XDHZZ		73342	29501110	PLATE USE 4 EA FOR C3 AND C4 CLUTCHES.....	8
4	PAHZZ	5320013600925	73342	11506706	RIVET,BLIND USE 12 AT EACH END OF C3 CLUTCH, 3 O.D. X 6MM.....	4
5	XDHZZ		73342	29505630	GEAR P1 PLANETARY RING.....	1
6	XDHZZ		73342	29529291	PLATE USE 5 EACH FOR C3 AND C4 CLUTCHES.....	10
7	XDHZZ		73342	29505765	PLATE USE 4 ON C3 CLUTCH AND USE 5 ON C4 CLUTCH.....	9
8	PFHZZ	5325014789347	73342	29506206	SPRING,HELICAL,COMP USE 4 EACH FOR C3 AND C4 CLUTCHES.....	8
9	XDHZZ		73342	29501426	PLATE,PISTON RETURN USE 1 EACH FOR C3 AND C4 CLUTCHES.....	2
10	XDHZZ		73342	29515628	RETAINER ASSEMBLY USE 1 EACH FOR C3 AND C4 CLUTCHES.....	2
11	XDHZZ		73342	29514114	PISTON ASSEMBLY USE 1 EACH FOR C3 AND C4 CLUTCHES.....	2
12	XDHZZ		73342	29505691	HOUSING C3 CLUTCH.....	1
13	XDHZZ		73342	29505690	HOUSING C4 CLUTCH.....	1
14	XDHZZ		73342	29505771	PLATE C5 CLUTCH.....	9
15	XDHZZ		73342	29534834	PLATE C5 CLUTCH.....	8

END OF FIGURE

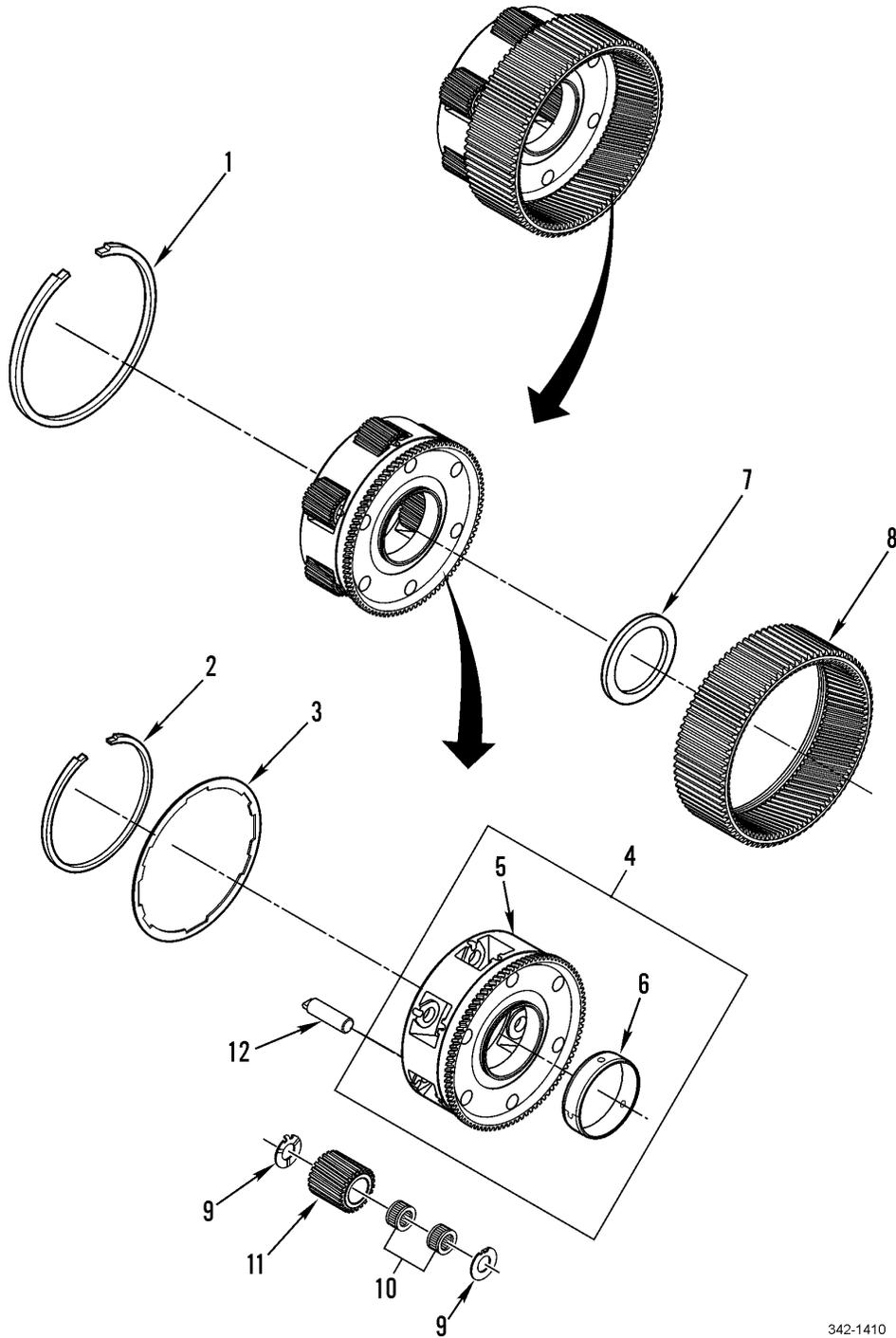

342-1410

Figure 131. P1 Planetary Assembly

SECTION II			TM9-2320-302-24P			
(1)	(2)	(3)	(4)	(5)	(6)	(7)
ITEM	SMR			PART		
NO	CODE	NSN	CAGEC	NUMBER	DESCRIPTION AND USABLE ON CODES(UOC)	QTY
GROUP 0713 INTERMEDIATE CLUTCH						
FIG. 131 P1 PLANETARY ASSEMBLY						
1	XDHZZ		73342	29501024	RING,RETAINING 256MM OD.....	1
2	XDHZZ		73342	29501034	RING,RETAINING 219MM OD.....	1
3	XDHZZ		73342	29501593	RING P1 INDEXING.....	1
4	XDHHH		73342	29507817	CARRIER/BUSHING P1.....	1
5	XAHZZ		73342	29505906	.CARRIER P1 PLANETARY.....	1
6	PFHZZ	3120014787481	73342	29535956	.BUSHING,SLEEVE P1 CARRIER.....	1
7	XDHZZ		73342	29514684	BEARING ASSY,THRUST.....	1
8	XDHZZ		73342	29505631	RING GEAR P2.....	1
9	XDHZZ		73342	29506051	WASHER,THRUST P1.....	9
10	XDHZZ		73342	29501037	BEARING ASSY,ROLLER.....	12
11	XDHZZ		73342	29507807	GEAR SET SET CONTAINS SIX 29505625	1
					GEARS,P1.....	
12	XDHZZ		73342	29501586	SPINDLE P1 PINION.....	6

END OF FIGURE

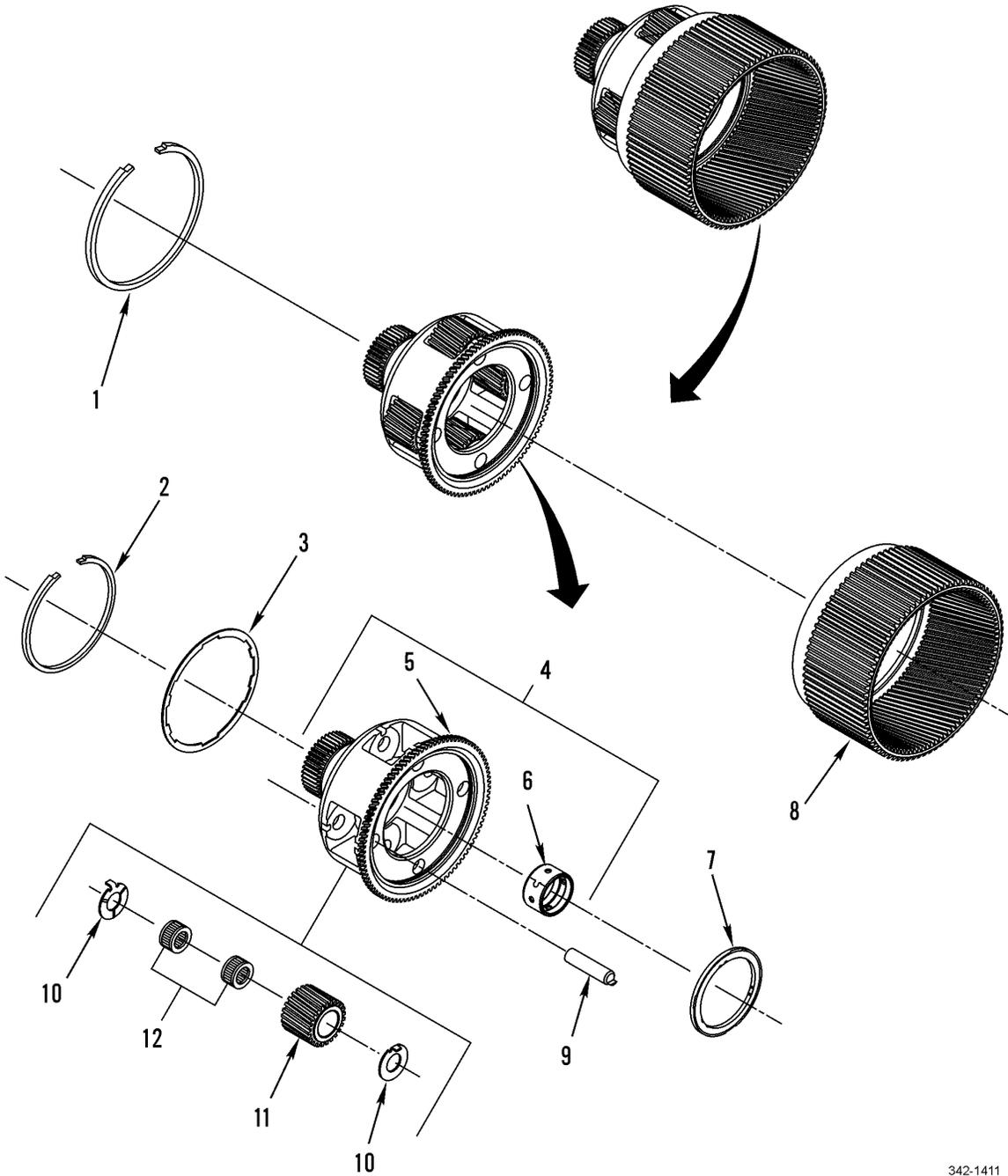

342-1411

Figure 132. P2 Planetary Assembly

SECTION II			TM9-2320-302-24P			
(1)	(2)	(3)	(4)	(5)	(6)	(7)
ITEM	SMR			PART		
NO	CODE	NSN	CAGEC	NUMBER	DESCRIPTION AND USABLE ON CODES(UOC)	QTY
GROUP 0713 INTERMEDIATE CLUTCH						
FIG. 132 P2 PLANETARY ASSEMBLY						
1	XDHZZ		73342	29501024	RING,RETAINING 256MM OD.....	1
2	XDHZZ		73342	29501034	RING,RETAINING 219MM OD.....	1
3	XDHZZ		73342	29501593	RING P2 INDEXING.....	1
4	XDHZZ		73342	29506317	BUSHING & CARRIER.....	1
5	XAHZZ		73342	29514686	CARRIER P2.....	1
6	PFHZZ	3120014787477	73342	29535957	BUSHING,SLEEVE 53MM ID.....	1
7	XDHZZ		73342	29501197	THRUST BEARING ASSY.....	1
8	XDHZZ		73342	29534835	GEAR P3 PLANETARY RING.....	1
9	XDHZZ		73342	29501588	GEAR SET P2 PINION.....	4
10	XDHZZ		73342	29506053	WASHER,THRUST P2 PINION.....	8
11	XDHZZ		73342	29507805	GEAR SET P2 PINION.....	1
12	XDHZZ		73342	29501053	BEARING ASSY,ROLLER.....	8

END OF FIGURE

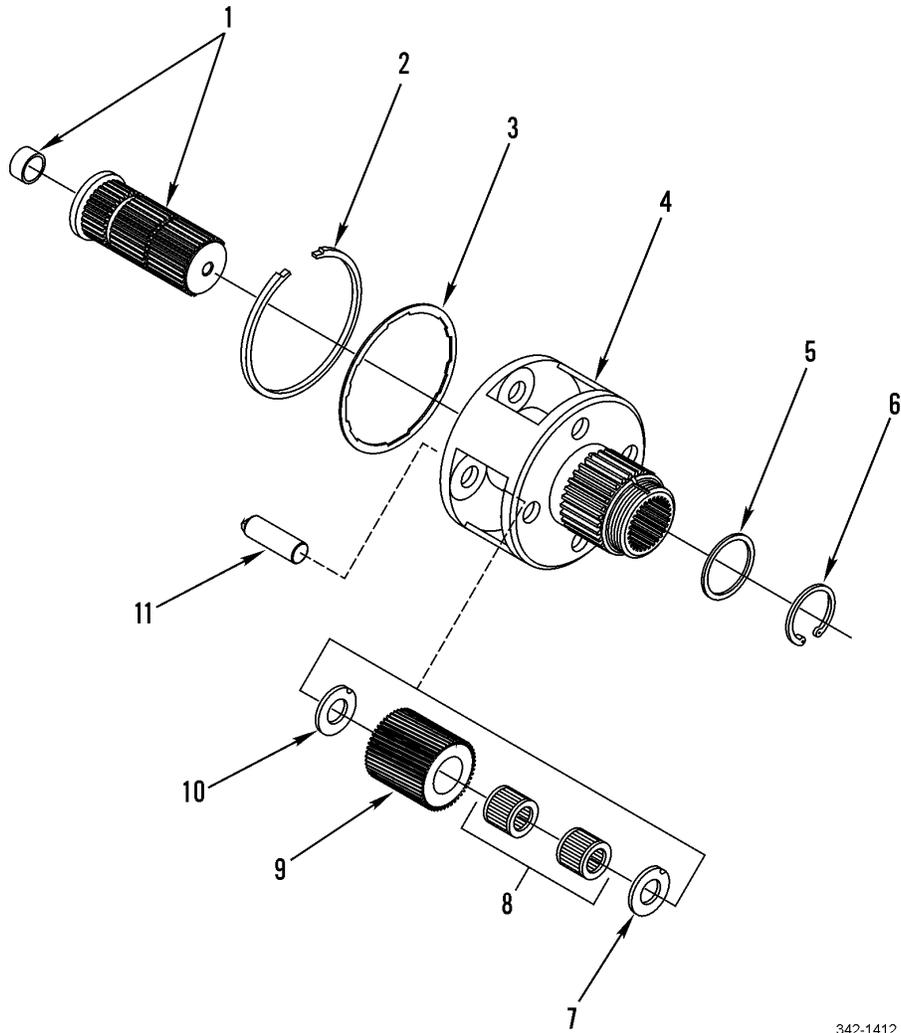

342-1412

Figure 133. P3 Planetary Assembly

SECTION II			TM9-2320-302-24P			
(1)	(2)	(3)	(4)	(5)	(6)	(7)
ITEM	SMR			PART		
NO	CODE	NSN	CAGEC	NUMBER	DESCRIPTION AND USABLE ON CODES(UOC)	QTY
GROUP 0713 INTERMEDIATE CLUTCH						
FIG. 133 P3 PLANETARY ASSEMBLY						
1	XDHZZ		73342	29535235	SHAFT ASSEMBLY.....	1
2	XDHZZ		73342	29501034	RING,RETAINING 219MM OD.....	1
3	XDHZZ		73342	29501593	RING P3 INDEXING.....	1
4	XDHZZ		73342	29511431	CARRIER P3.....	1
5	XDHZZ		73342	29535224	WASHER,THRUST.....	1
6	XDHZZ		73342	29505803	RING,RETAINING 64MM ID.....	1
7	XDHZZ		73342	29506055	WASHER,THRUST P3.....	4
8	XDHZZ		73342	29501066	BEARING ASSY,ROLLER.....	8
9	XDHZZ		73342	29507803	GEAR SET FOR P3.....	1
10	XDHZZ		73342	29506056	WASHER,THRUST P3.....	4
11	XDHZZ		73342	29501590	SPINDLE,PINION P3 PLANETARY.....	4

END OF FIGURE

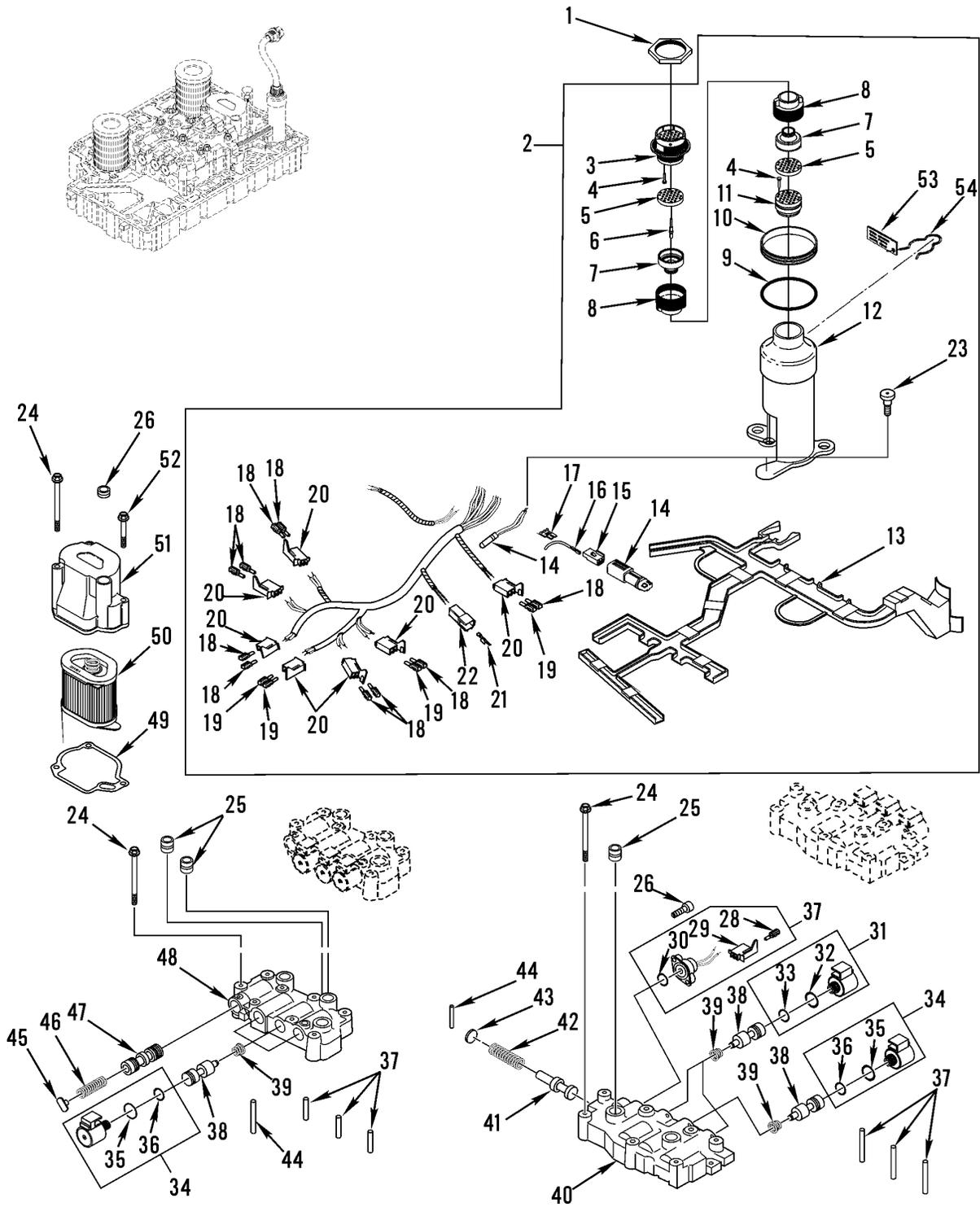

342-1414-1

Figure 134. Control Valves and Wiring Harness (Sheet 1 of 2)

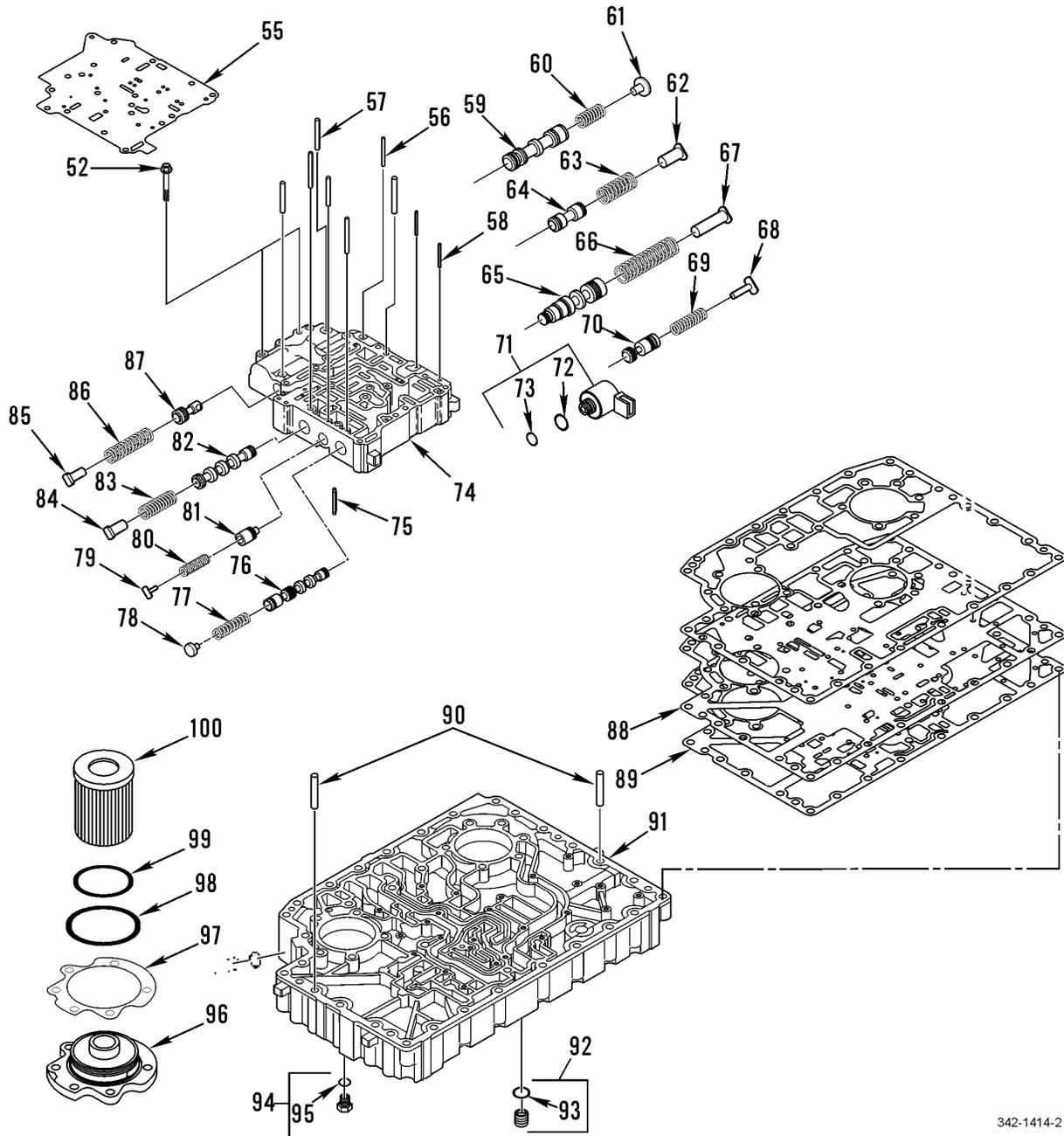

342-1414-2

Figure 134. Control Valves and Wiring Harness (Sheet 2 of 2)

SECTION II			TM9-2320-302-24P			
(1)	(2)	(3)	(4)	(5)	(6)	(7)
ITEM	SMR			PART		
NO	CODE	NSN	CAGEC	NUMBER	DESCRIPTION AND USABLE ON CODES(UOC)	QTY
GROUP 0713 INTERMEDIATE CLUTCH						
FIG. 134 CONTROL VALVES AND WIRING HARNESS						
1	XDHZZ		73342	29527000	NUT, PANEL.....	1
2	PFHHA	2520014790244	73342	29533656	CONTROL ASSEMBLY, TR.....	1
3	XDHZZ		73342	29511368	.CONNECTOR, RECEPTACL.....	1
4	XDHZZ		73342	29511371	.PLUG AS REQUIRED.....	1
5	PAHZZ	5935014599907	73342	29514043	.INSERT, ELECTRICAL C.....	2
6	XDHZZ		73342	29511369	.TERMINAL, PIN.....	1
7	PAHZZ	5935014599848	73342	29514042	.ADAPTER, CABLE CLAMP.....	1
8	PAHZZ	5935014599908	73342	29514041	.SHELL, ELECTRICAL CO.....	2
9	PAHZZ	5331014601190	73342	12092195	.O-RING.....	1
10	PAHZZ	5330014610588	73342	29520396	.SEAL, PLAIN.....	1
11	XDHZZ		73342	29524006	.GROMMET.....	1
12	XDHZZ		73342	29516328	.STANDOFF.....	1
13	XDHZZ		73342	29529973	.PLATE.....	1
14	PAHZZ	5905014772349	73342	12129691	.SENSOR, TEMPERATURE.....	1
15	XDHZZ		73342	12047662	.CONNECTOR.....	1
16	XDHZZ		73342	12047767	.TERMINAL, SOCKET.....	2
17	XDHZZ		73342	12047664	.LOCK, SECONDARY.....	1
18	PAHZZ	5940014612236	73342	12124639	.TERMINAL, LUG.....	1
19	XDHZZ		73342	12124618	.TERMINAL, SOCKET.....	1
20	PAHZZ	5935014599845	73342	12092420	.CONNECTOR, RECEPTACL.....	7
20	PAHZZ	5940014612236	73342	12124639	.TERMINAL, LUG.....	11
21	PAHZZ	5940014612235	73342	12066337	.TERMINAL, LUG.....	2
22	PAHZZ	5935014602344	73342	12110139	.CONNECTOR, RECEPTACL.....	1
23	XDHZZ		73342	29515393	BOLT, SHOULDER.....	3
24	PAHZZ	5306013599429	73342	11515310	BOLT, MACHINE M6 X 1.0 X 95MM.....	17
25	PAHZZ	5330013606006	73342	23046376	SEAL, NONMETALLIC RO.....	4
26	PAHZZ	5305014754853	73342	29535575	SCREW, CAP, SOCKET HE.....	2
27	PAHHZ	5930013605002	73342	29506484	SWITCH, PRESSURE.....	1
27	PAHZZ	5935014599845	73342	12092420	.CONNECTOR, RECEPTACL.....	1
30	PAHZZ	5331013881528	73342	29501439	.O-RING 7.64MM ID.....	1
31	PAHHZ	5945013605162	73342	29507454	SOLENOID, ELECTRICAL.....	2
32	PAHZZ	5331013606017	73342	29503383	.O-RING 1506MM ID.....	1
33	PAHZZ	5331013606013	73342	29503382	.O-RING 14MM ID.....	1
34	PAHHZ	5945013605161	73342	29507453	SOLENOID, ELECTRICAL.....	4
35	PAHZZ	5331014758687	73342	23016455	.O-RING 16.89MM ID.....	1
36	PAHZZ	5331013606016	73342	23014057	.O-RING 12.24MM ID.....	1
37	PAHZZ	5315013606729	73342	29511647	PIN, STRAIGHT, HEADLE 2.5 X 30MM.....	6
38	PAHZZ	4810013604314	73342	29507464	SLIDE, DIRECTIONAL C.....	6
39	PAHZZ	5360013597944	73342	29502195	SPRING, HELICAL, COMP 11.05 OD X 6.48MM LONG.....	6
40	PAHZZ	4820013602421	73342	29507432	BODY, VALVE.....	1
41	PAHZZ	4820014610599	73342	29507459	SLIDE, DIRECTIONAL C.....	1
42	PAHZZ	5360014601139	73342	29507455	SPRING, HELICAL, COMP 11.68 OD X 43.6MM LONG.....	1
43	PAHZZ	4820014600245	73342	29507457	STOP, VALVE.....	1
44	PAHZZ	5315013604771	73342	23049372	PIN, SPRING 5 X 30MM.....	1
45	PAHZZ	5340013598849	73342	23049343	STOP, MECHANICAL.....	1

SECTION II		TM9-2320-302-24P			(6)	(7)
(1)	(2)	(3)	(4)	(5)		
ITEM	SMR			PART		
NO	CODE	NSN	CAGEC	NUMBER	DESCRIPTION AND USABLE ON CODES(UOC)	QTY
46	PAHZZ	5360013597945	73342	23049332	SPRING,HELICAL,COMP 7.75 OD X 26.6MM LONG.....	1
47	PAHZZ	4820013602354	73342	23049321	VALVE,RESTRICTOR CH.....	1
48	PAHZZ	4810013604433	73342	29507433	BODY,VALVE.....	1
49	PAHZZ	5330013609034	73342	29503263	GASKET.....	1
50	PAHZZ	4730013604458	73342	29503670	STRAINER,SUCTION.....	1
51	PAHZZ	2940013603389	73342	29502068	COVER,FLUID FILTER.....	1
52	PAHZZ		73342	11515309	BOLT,MACHINE M6 X 1.0 X 60MM.....	3
53	XDHZZ		73342	29516330	TAG,FEEDTHROUGH.....	1
54	PFHZZ	5340014784881	73342	29516329	CLIP,SPRING TENSION.....	1
55	XDHZZ		73342	29507450	PLATE.....	1
56	PAHZZ	5340013607812	73342	29500822	ROD,STRAIGHT,HEADLE 3 X 43MM.....	3
57	PAHZZ	5340013605983	73342	23049345	ROD,STRAIGHT,HEADLE 5 X 43MM.....	5
58	PAHZZ	5340013605984	73342	29500823	ROD,STRAIGHT,HEADLE 2.5 X 40MM.....	1
59	PAHZZ	4820013602355	73342	23049315	VALVE,RESTRICTOR CH.....	5
60	PAHZZ	5360013597946	73342	23049326	SPRING,HELICAL,COMP 14.1 OD X 42.1MM LONG.....	1
61	PAHZZ	5340013598850	73342	23049337	STOP,MECHANICAL.....	1
62	PAHZZ	5340013598851	73342	23049338	STOP,MECHANICAL.....	1
63	PAHZZ	5360013597947	73342	23049327	SPRING,HELICAL,COMP 11.10 X 46.3MM LONG.....	1
64	PAHZZ	4820013606160	73342	23049316	VALVE,RESTRICTOR CH.....	1
65	PAHZZ	4820013611924	73342	23049312	VALVE,RESTRICTOR CH.....	1
66	PAHZZ	5360013597948	73342	29500963	SPRING,HELICAL,COMP 22OD 98.5MM LONG.....	1
67	PAHZZ	5340013598852	73342	29503663	STOP,MECHANICAL.....	1
68	PAHZZ	5340013598853	73342	29503674	STOP,MECHANICAL 14.8 OD X 44.6MM LONG.....	1
69	PAHZZ	5360013597949	73342	23049325	SPRING,HELICAL,COMP 14.8 OD X 44.6MM LONG.....	1
70	PAHZZ	4820013609095	73342	29503673	VALVE,RESTRICTOR CH.....	1
71	PAHZZ	5945013605163	73342	29507451	SOLENOID,ELECTRICAL.....	1
72	PAHZZ	5331014749719	73342	29503384	O-RING 18.77MM ID.....	1
73	PAHZZ	5331013606013	73342	29503382	O-RING 14MM ID.....	1
74	XDHZZ		73342	29507430	BODY,CONTROL VALVE.....	1
75	PAHZZ	5315013604772	73342	11513011	PIN,SPRING 5 X 55MM.....	1
76	PAHZZ	4820014610598	73342	29507460	SLIDE,DIRECTIONAL C.....	1
77	PAHZZ	5360013597950	73342	29501071	SPRING,HELICAL,COMP 11.43 OD X 41.3MM LONG.....	1
78	PAHZZ	5340013599416	73342	23049341	STOP,MECHANICAL.....	1
79	PAHZZ	5340013601075	73342	23049342	STOP,MECHANICAL.....	1
80	PAHZZ	5360013597951	73342	23049391	SPRING,HELICAL,COMP 7.8 OD X 29.2MM LONG.....	1
81	PAHZZ	4820013606161	73342	23049320	VALVE,RESTRICTOR CH.....	1
82	PAHZZ	4820013606162	73342	23049318	VALVE,RESTRICTOR CH.....	1
83	PAHZZ	5360013597952	73342	6885065	SPRING,HELICAL,COMP 16.26 OD X 46.23MM LONG.....	1
84	PAHZZ	5340013598854	73342	23049340	STOP,MECHANICAL.....	1
85	XDHZZ		73342	29535946	STOP,VALVE.....	1
86	PAHZZ	5360014601141	73342	29507456	SPRING,HELICAL,COMP 11 OD X 30.3MM LONG.....	1
87	PAHZZ	4820013604408	73342	29507462	SLIDE,DIRECTIONAL C.....	1

SECTION II			TM9-2320-302-24P			
(1)	(2)	(3)	(4)	(5)	(6)	(7)
ITEM	SMR			PART		
NO	CODE	NSN	CAGEC	NUMBER	DESCRIPTION AND USABLE ON CODES(UOC)	QTY
88	XDHZZ		73342	29524398	PLATE.....	1
89	PAHZZ	5330014787298	73342	29530531	GASKET.....	1
90	PAHZZ	5315013605914	73342	23046354	PIN,STRAIGHT,HEADLE 10 X 50MM.....	2
91	XDHZZ		73342	29524445	PLATE.....	1
92	PAHZZ	5365013600937	73342	29534362	PLUG,MACHINE THREAD INCLUDES O-RING	1
93	PAHZZ	5331013610235	73342	23019664	.O-RING 16.36MM ID.....	1
94	PAHZZ	5365013599336	73342	29500034	PLUG,MACHINE THREAD INCLUDES O-RING	8
95	PAHZZ	5331014246629	73342	23043446	.O-RING 8.92MM ID.....	1
96	PAHZZ	5340014430317	73342	29524447	COVER,ACCESS.....	2
97	PAHZZ	5330014408651	73342	29524449	GASKET.....	2
98	PAHZZ	5331014396677	73342	29524448	O-RING 85.32MM ID.....	2
99	PAHZZ	5331013607725	73342	29507437	O-RING 75.92MM ID.....	2
100	PAHZZ	2910014311324	73342	29509723	FILTER,FLUID.....	2

END OF FIGURE

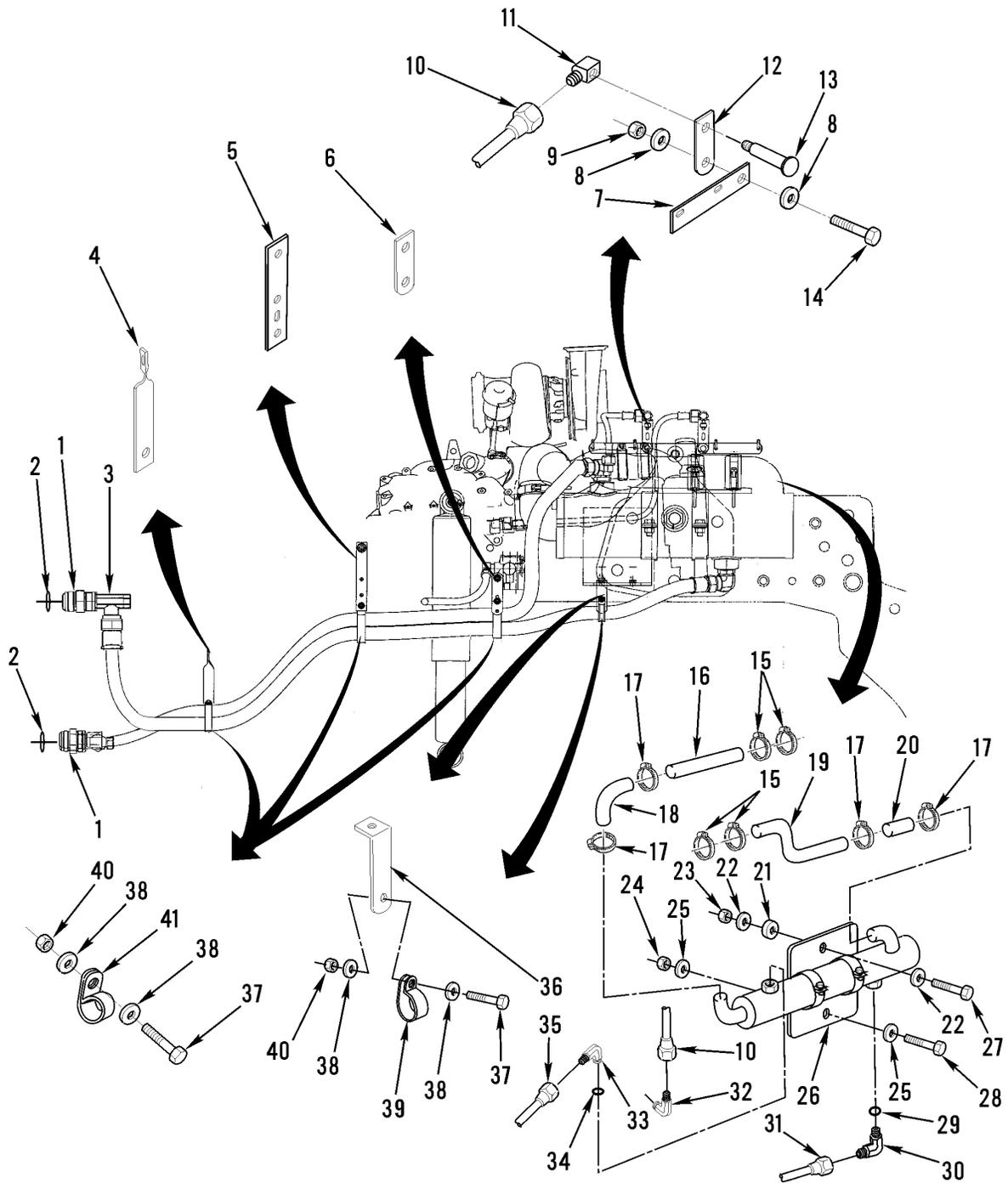

342-1511

Figure 135. Transmission Oil Cooler, Lines and Fittings

SECTION II			TM9-2320-302-24P			
(1)	(2)	(3)	(4)	(5)	(6)	(7)
ITEM NO	SMR CODE	NSN	CAGEC	PART NUMBER	DESCRIPTION AND USABLE ON CODES(UOC)	QTY
GROUP 0713 INTERMEDIATE CLUTCH						
FIG. 135 TRANSMISSION OIL COOLER, LINES AND FITTINGS						
1	PAOZZ	4730009305392	96906	MS51525A16	ADAPTER, STRAIGHT, TU.....	2
2	PAOZZ		87373	3-916 N0552	.O-RING 1.05 ID.....	1
3	XDOZZ		30780	8-16-16GX6JX-S	TEE.....	1
4	XDOZZ		64678	23-09130-024	BRACKET, STANDOFF .531 X .281.....	1
5	PFOZZ	5340014749584	64678	06-09782-003	BRACKET, MOUNTING.....	1
6	PAOZZ	5365012458802	64678	23-09130-003	SPACER, PLATE.....	1
7	PAOZZ	4730014395343	7Z588	B9223-0325B	CLAMP, HOSE.....	4
8	PAOZZ	4720014788827	64678	05-16960-000	ELBOW, HOSE 88 DEGREE X 3.0" ID.....	1
9	XDOZZ		64678	05-17251-000	PIPE, TRANS OIL INLE.....	1
10	XDOZZ		62789	B9226-0306B	CLAMP, HOSE.....	4
11	XDOZZ		64678	05-17252-000	PIPE, TRANS OIL OUTL.....	1
12	MOOZZ		24161	4175-3X8	HOSE 3IN ID X 8.0IN, MAKE FROM BULK PN 4175-3 (24161).....	1
13	PAOZZ	4730013366945	64678	E07-10869-000	ELBOW, TUBE TO BOSS.....	1
14	PAOZZ	5331011256268	83259	3-916N552-90	.O-RING.....	1
15	PAOZZ	5310013192127	64678	23-09901-108	NUT, SELF-LOCKING, HE.....	1
16	PAOZZ	5310008095997	96906	MS27183-17	WASHER, FLAT.....	2
17	XDOZZ		64678	23-09331-100	SPACER .53" ID X .5" OD.....	1
18	PAOZZ	5305000712072	80204	B1821BH050C225N	SCREW, CAP, HEXAGON H.....	1
19	PAOZZ		21563	13357-1-5	COOLER, TRANS OIL 6" DIA.....	1
20	PAOZZ	4730008407236	96906	MS51527A16	ELBOW, TUBE TO BOSS.....	1
21	PAOZZ	5331011256268	83259	3-916N552-90	.O-RING.....	1
22	PAOZZ	5310013369850	64678	23-09901-116	NUT, SELF-LOCKING, HE.....	1
23	PAOZZ	5310013367579	64678	23-09114-008	WASHER, FLAT.....	2
24	PAOZZ	5305009908400	80204	B1821BH100C350N	SCREW, CAP, HEXAGON H.....	1
25	XDOZZ		64678	23-09130-034	BRACKET, STANDOFF 1.1 4.....	1
26	PAOZZ	5310000881251	81349	M45913/1-4CG5C	NUT, SELF-LOCKING, HE.....	4
27	PAOZZ	5310008094058	96906	MS27183-10	WASHER, FLAT.....	8
28	PAOZA	5340014390816	64678	23-09528-076	CLAMP, LOOP.....	1
29	PAOZZ	5305002253843	80204	B1821BH025C100N	SCREW, CAP, HEXAGON H.....	4
30	XDOZZ		64678	23-12231-108	CLAMP, HOSE 2 LINE.....	3
31	PAOZZ	4720014786021	64678	A23-12629-070	HOSE ASSEMBLY, METAL 70 INCH.....	1
32	PAOZZ	4720014786025	64678	A23-12317-080	HOSE ASSEMBLY, METAL.....	1

END OF FIGURE

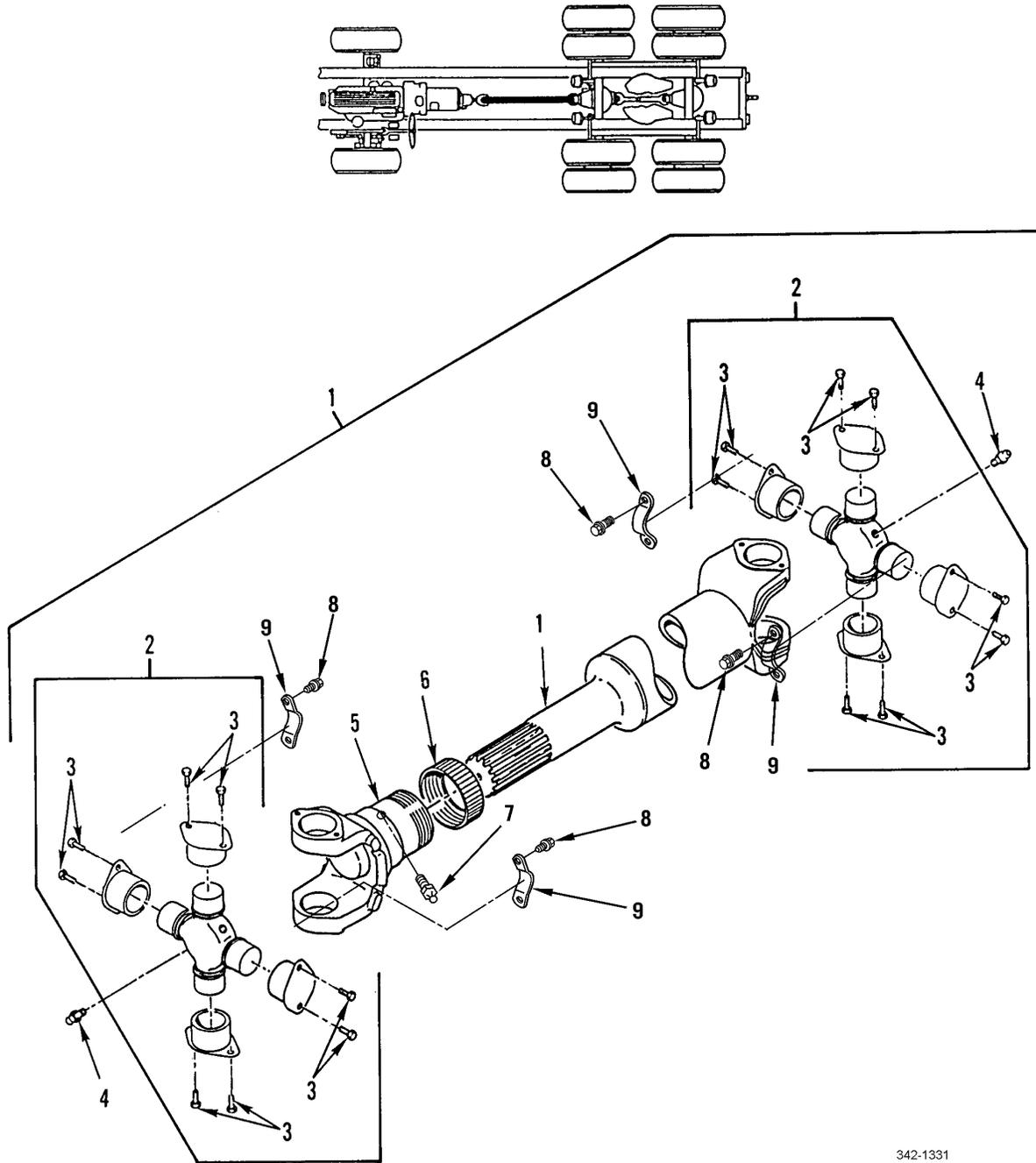

342-1331

Figure 136. Main Propeller Shaft Assembly

SECTION II			TM9-2320-302-24P			
(1)	(2)	(3)	(4)	(5)	(6)	(7)
ITEM	SMR			PART		
NO	CODE	NSN	CAGEC	NUMBER	DESCRIPTION AND USABLE ON CODES(UOC)	QTY
					GROUP 09 PROPELLER, PROPELLER SHAFTS, UNIVERSAL JOINTS, COUPLER, AND CLAMP ASSEMBLY GROUP 0900 PROPELLER SHAFTS	
					FIG. 136 MAIN PROPELLER SHAFT ASSEMBLY	
1	PAOOO	2520014791629	64678	A09-10067-490	PROPELLER SHAFT,WIT MAIN.....	1
2	PAOZZ	2520014387589	72447	5-469X	.SPIDER,UNIVERSAL JO.....	2
3	PAOZZ	5305014214222	95019	6-73-209	..SCREW,CAP,HEXAGON H 3/8-24.....	8
4	PAOZZ	4730000504203	74410	XB-767	..FITTING,LUBRICATION.....	4
5	PAOZZ	2520014790035	72447	6.3-3-41X	.YOKE,UNIVERSAL JOIN.....	1
6	PAOZZ	2520010843251	97271	5-188X	.JOURNAL AND BEARING.....	1
7	PAOZZ	4730009060982	97271	500168-2	.FITTING,LUBRICATION.....	1
8	PAOZZ	5305013388155	7H161	8-73-316	.SCREW,CAP,HEXAGON H .500-20 UNF X 25.4MM.....	8
9	PAOZZ	5340012923904	7H161	6.5-70-89	.STRAP,RETAINING.....	4

END OF FIGURE

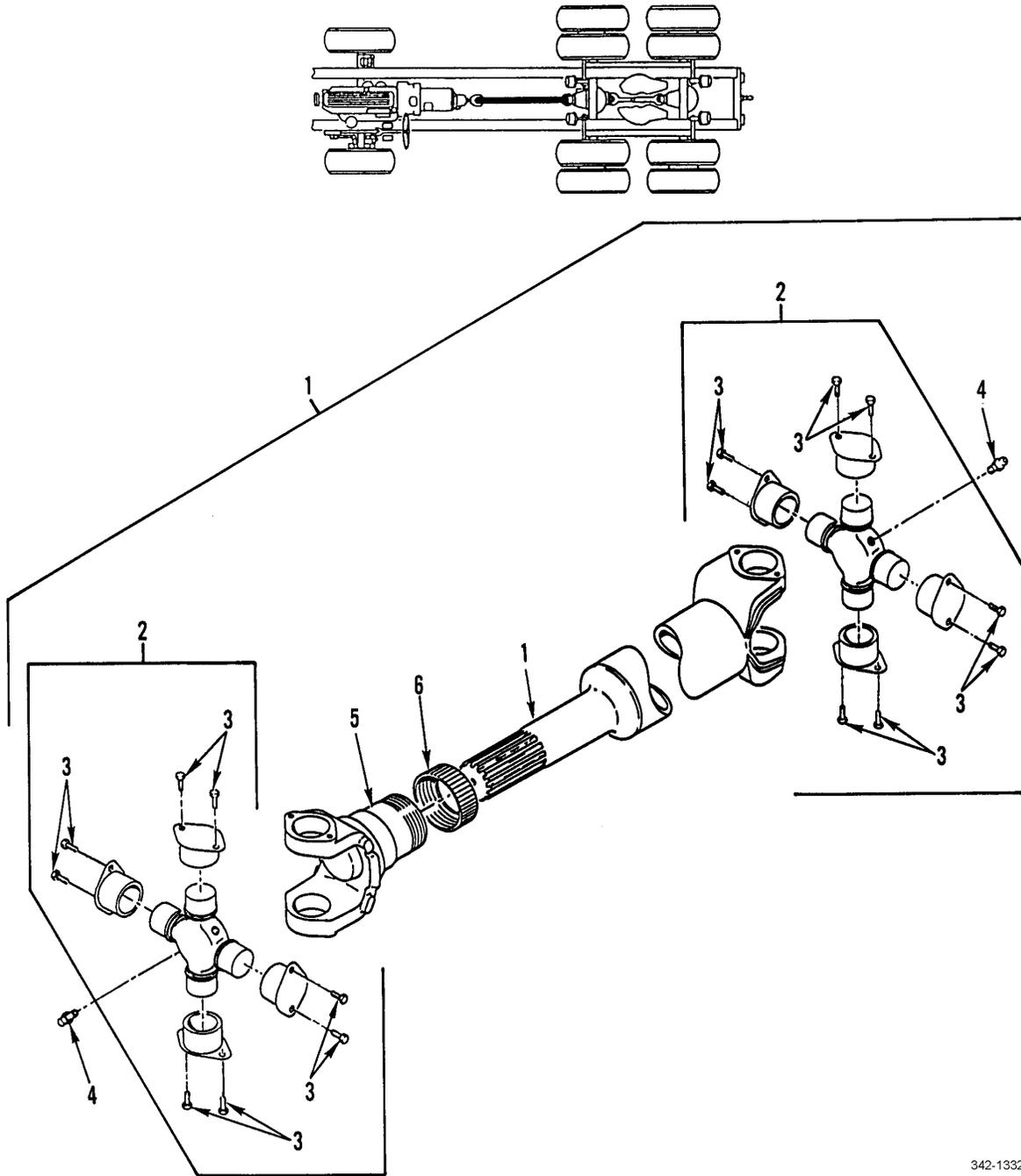

342-1332

Figure 137. Inter-Axle Propeller Shaft Assembly

SECTION II			TM9-2320-302-24P			
(1)	(2)	(3)	(4)	(5)	(6)	(7)
ITEM	SMR			PART		
NO	CODE	NSN	CAGEC	NUMBER	DESCRIPTION AND USABLE ON CODES(UOC)	QTY
GROUP 0900 PROPELLER SHAFTS						
FIG. 137 INTER-AXLE PROPELLER SHAFT ASSEMBLY						
1	PAOOO	2520014737409	64678	A09-09185-250	PROPELLER SHAFT,WIT INTER AXLE 25.0 INCHES.....	1
2	PAOZZ	2520013256405	78500	R280X	.SPIDER,UNIVERSAL JO INNER AXLE....	2
3	PAOZZ	5305014214222	95019	6-73-209	.SCREW,CAP,HEXAGON H 3/8-24.....	8
4	PAOZZ	4730013578736	78500	1199-A-963	.FITTING,LUBRICATION.....	4
5	PAOZZ	2520001143294	95019	6-3-3441KX	.SLEEVE YOKE ASSEMBL.....	1
6	PAOZZ	2520010843251	97271	5-188X	.JOURNAL AND BEARING.....	1

END OF FIGURE

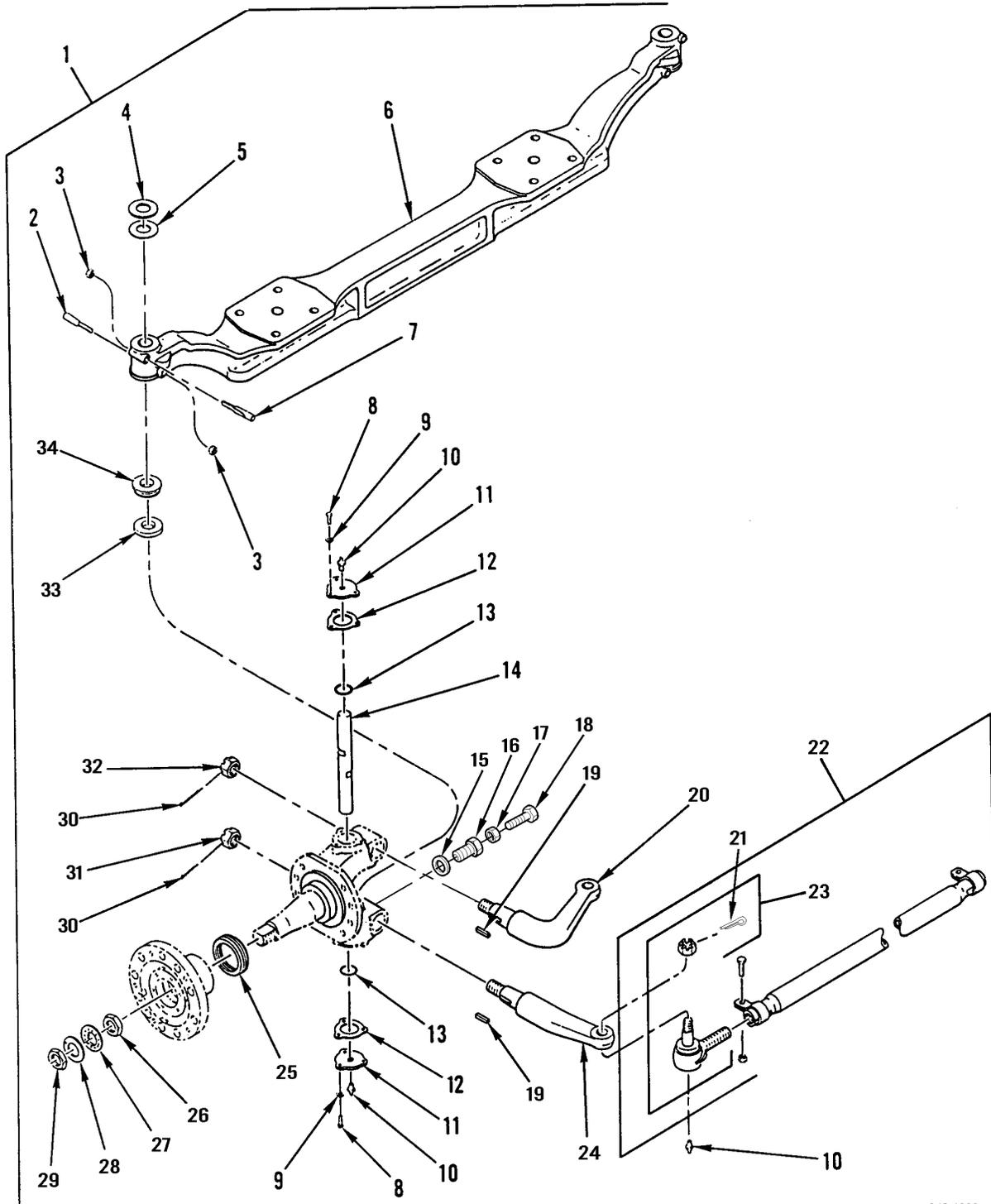

342-1333

Figure 138. Front Axle Assembly

SECTION II			TM9-2320-302-24P			
(1)	(2)	(3)	(4)	(5)	(6)	(7)
ITEM	SMR			PART		
NO	CODE	NSN	CAGEC	NUMBER	DESCRIPTION AND USABLE ON CODES(UOC)	QTY
GROUP 10 FRONT AXLE						
GROUP 1000 FRONT AXLE ASSEMBLY						
FIG. 138 FRONT AXLE ASSEMBLY						
1	PAFFH		19207	12478861	AXLE,VEHICULAR,NOND.....	1
2	PAFZZ	5315013265530	78500	7X-1003	.PIN,STRAIGHT,HEADLE 3.250 LG X .623 DIA.....	2
3	PAFZZ	5310011152550	78500	1227-Z-780	.NUT,PLAIN,HEXAGON 7/16-20 UNF-2B, GR8, FLANGED STYLE.....	4
4	XDFZZ		78500	2203-L-3002	.ISOLATOR,RADIO FREQ.....	2
5	PAFZZ	5365011079291	78500	2203-K-3001	.SHIM.....	2
6	PAFZZ	2530013382348	78500	3100-W-7121	.AXLE ASSEMBLY,VEHIC.....	1
7	PAFZZ	5315013284359	78500	7X-1002	.PIN,SHOULDER,HEADLE 3.680 LG X 1, GR8.....	2
8	PFFZZ	5305013293991	78500	S-258-1	.SCREW,CAP,HEXAGON H 5/16-18UNC X 1,GR8.....	12
9	PAFZZ	5310012009879	78500	1229-E-1669-C	.WASHER,FLAT .34 X .62 X .06.....	12
10	PAFZZ	4730000504208	96906	MS15003-1	.FITTING,LUBRICATION 1/8NPTF,9/32 BASE.....	6
11	XDFZZ		3E158	2297T4752	.CAP,KING PIN.....	4
12	PAFZZ	5330013252623	78500	3208-M-1027	.GASKET.....	4
13	PAFZZ	5330011165309	78500	A-1205-X-1428	.SEAL,PLAIN ENCASED.....	4
14	PAFZZ	5315011121505	78500	3101-W-179	.PIN.....	2
15	XDFZZ		78500	1229E4139	.WASHER,FLAT .781 ID X 1.312 OD....	2
16	XDFZZ		78500	3280B8530	.INSERT,SCREW,THREAD.....	2
17	PAFZZ	5310010839359	78500	13-X-163	.NUT 1/2-20.....	2
18	XDFZZ		78500	26X-1003	.STOP,MECHANICAL 1/2-20 X 2.0.....	2
19	PAFZZ	5315010826938	78500	16X-202	.KEY.....	6
20	PAFZZ	2530013253381	78500	3133-U-6573	.ARM,STEERING GEAR.....	1
21	PAFZZ	5315000137214	88044	AN380-4-7	.PIN,COTTER 1/8 DIA X 1-3/4 LG....	2
22	PAFFF	2530013264647	78500	A2-3102-X-3456	.TIE ROD,STEERING.....	1
23	PAFZZ	2530013184214	78500	A-3144-D-524	.TIE ROD END,STEERIN R.H.....	1
23	PAFZZ	2530013184215	78500	A-3144-E-525	.TIE ROD END,STEERIN L.H.....	1
24	PAFZZ	2530013256410	78500	3133-E-7337	.DRAG LINK-TIE ROD R.H.....	1
24	PAFZZ	2530011787154	78500	3133-C-2551	.ARM,STEERING GEAR L.H.....	1
25	PAFZZ	5330011499677	80201	35066	.SEAL,PLAIN ENCASED.....	2
26	PAFZZ	5310011145637	78500	1227-U-541	.NUT,WHEEL 1 1/2-12 UNF-2B.....	2
27	PAFZZ	2530007001705	78500	1229F474	.LOCK WHEEL.....	2
28	PAFZZ	2530007001709	78500	1229G475	.RING WHEEL BEARING.....	2
29	PAFZZ	5310006382830	78500	1227B106	.NUT,PLAIN,HEXAGON 1.438-12UN-2B...	2
30	PAFZZ	5315008423045	80205	MS24665-499	.PIN,COTTER 3/16 X 2 1/4.....	2
31	PAFZZ	5310004015175	96906	MS35692-1824	.NUT,PLAIN,SLOTTED,H 1-1/8 X 12UNF- 2B.....	1
32	PAFZZ	5310011940658	78500	1227J1544	.NUT,PLAIN,HEXAGON 1-1/8 X 12UNF...	1
33	PAFZZ	3110002273673	60038	T182	.BEARING,ROLLER,THRU.....	2
34	PAFZZ	5330011161132	78500	A-1205-B-1432	.SEAL,PLAIN ENCASED.....	2

END OF FIGURE

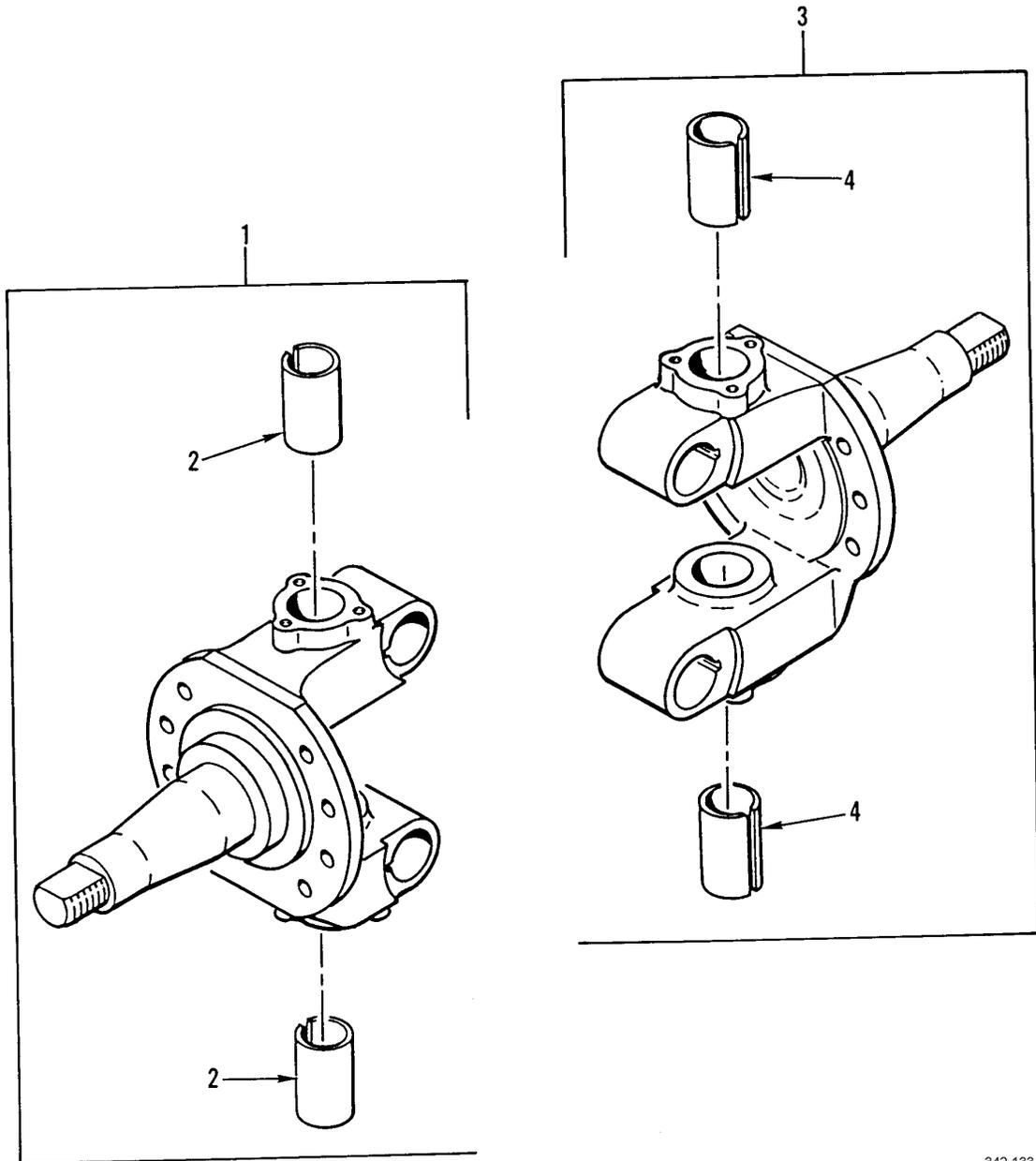

342-1334

Figure 139. Tie Rod Knuckles

SECTION II			TM9-2320-302-24P			
(1)	(2)	(3)	(4)	(5)	(6)	(7)
ITEM	SMR			PART		
NO	CODE	NSN	CAGEC	NUMBER	DESCRIPTION AND USABLE ON CODES(UOC)	QTY
					GROUP 1004 STEERING AND LEANING WHEEL MECHANISM	
					FIG. 139 TIE ROD KNUCKLES	
1	PAFFF	2530013264571	78500	3111-C-2863	SPINDLE,WHEEL,DRIVI.....	1
2	PAFZZ	5365013296987	78500	1225-W-985	.BUSHING,MACHINE THR.....	2
3	PAFFF	2530013275416	78500	3111-L-2950	SPINDLE,WHEEL,DRIVI.....	1
4	PAFZZ	5365013296987	78500	1225-W-985	.BUSHING,MACHINE THR.....	2

END OF FIGURE

1
2 thru 17

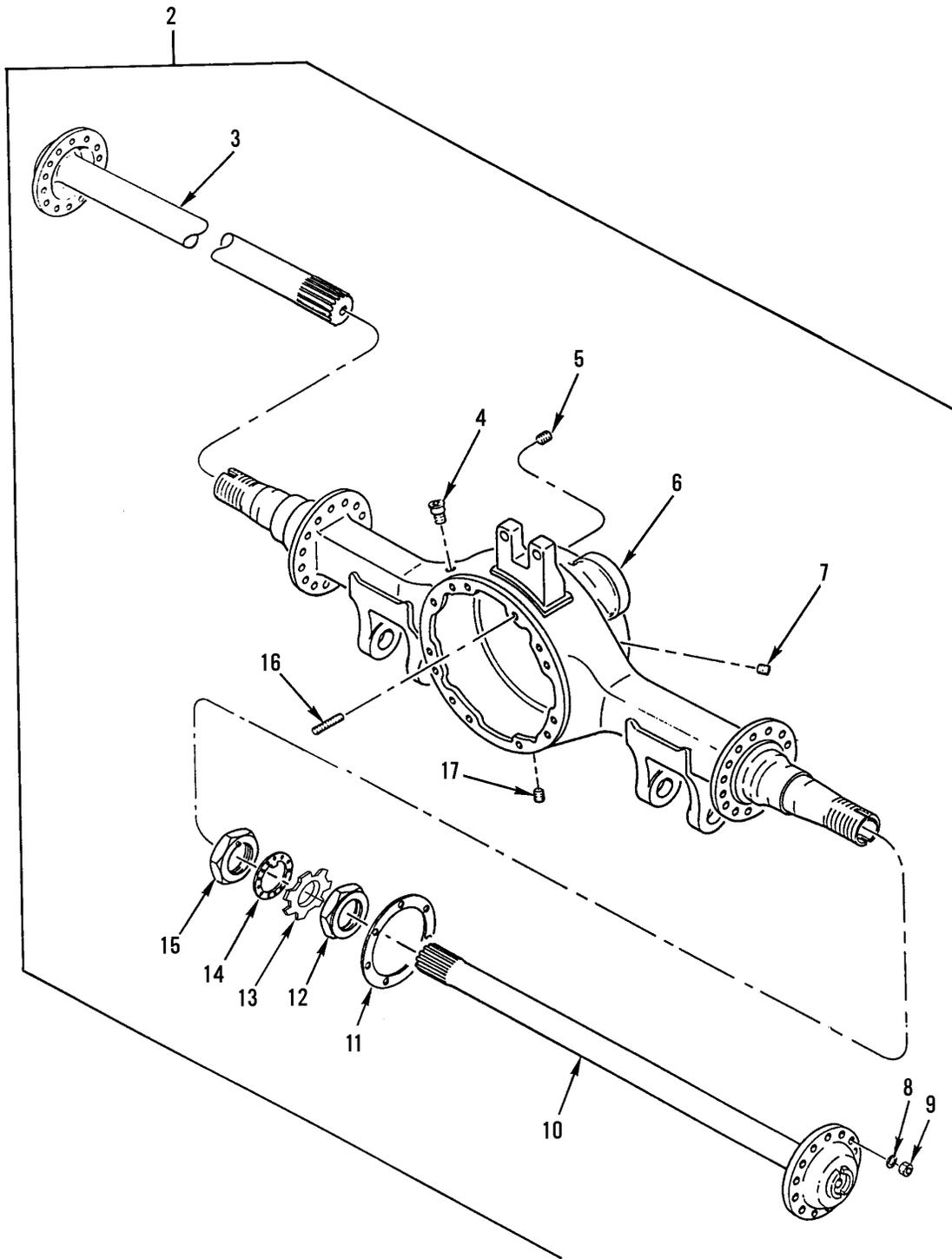

342-1335

Figure 140. Forward-Rear Axle Dressed

SECTION II			TM9-2320-302-24P			
(1)	(2)	(3)	(4)	(5)	(6)	(7)
ITEM NO	SMR CODE	NSN	CAGEC	PART NUMBER	DESCRIPTION AND USABLE ON CODES(UOC)	QTY
					GROUP 11 REAR AXLE	
					GROUP 1100 REAR AXLE ASSEMBLY	
					FIG. 140 FORWARD-REAR AXLE DRESSED	
1	PGFHH	2520014792470	19207	12478862	AXLE ASSEMBLY,AUTOM.....	1
2	XAFHH		78500	RP20145NNN2160-5	.AXLE ASSEMBLY,AUTOM W/O HUBS &	1
				29	DRUMS.....	
3	PAFZZ	2520013300773	78500	3202-S-9483	..SHAFT,AXLE,AUTOMOTI R/S, SHORT...	1
4	PAOZZ	2520003532286	78500	A1199P1394	..BREATHER.....	1
5	PAOZZ	4730013479326	78500	P28-S	..PLUG,PIPE.....	1
6	XAFZZ		78500	C22-3121-R-2280S	..HOUSING,AXLE.....	1
7	PAOZZ	4730000103875	81348	WW-P-471ACBBUE	..PLUG,PIPE.....	1
8	PAFZZ	5310008095997	96906	MS27183-17	..WASHER,FLAT .62 X .937 X .09,HDN,	16
					PL.....	
9	PAFZZ	5310013570821	64678	23-09247-210	..NUT,PLAIN,HEXAGON 5/8-UNF.....	16
10	PAFZZ	2520013300772	78500	3202-T-9484	..SHAFT,AXLE,AUTOMOTI L/S, SHORT...	1
11	PAFZZ	5330005806567	79780	2208X440	..GASKET.....	2
12	PAFZZ	5310012544255	78500	1227-R-330	..NUT,PLAIN,HEXAGON OUTER, 3 1/4-	2
					12 UN-2B.....	
13	PAFZZ		78500	1229F4634S	..WASHER,LOCK BLANK INCLUDES	2
					WASHER W/HOLES & TANGED WASHER.....	
14	PAFZZ		78500	1229J4638	..WASHER,LOCK BLANK.....	2
15	PAFZZ	2520009177434	78500	1227W517	..NUT,WHEEL BEARING INNER, 3 1/4-	2
					12 UN-2B.....	
16	PAFZZ	5307013468672	78500	SN-1019-1	..STUD,PLAIN.....	2
17	PAOZZ	5365011802369	78500	1250-E-473	..PLUG,MACHINE THREAD.....	1

END OF FIGURE

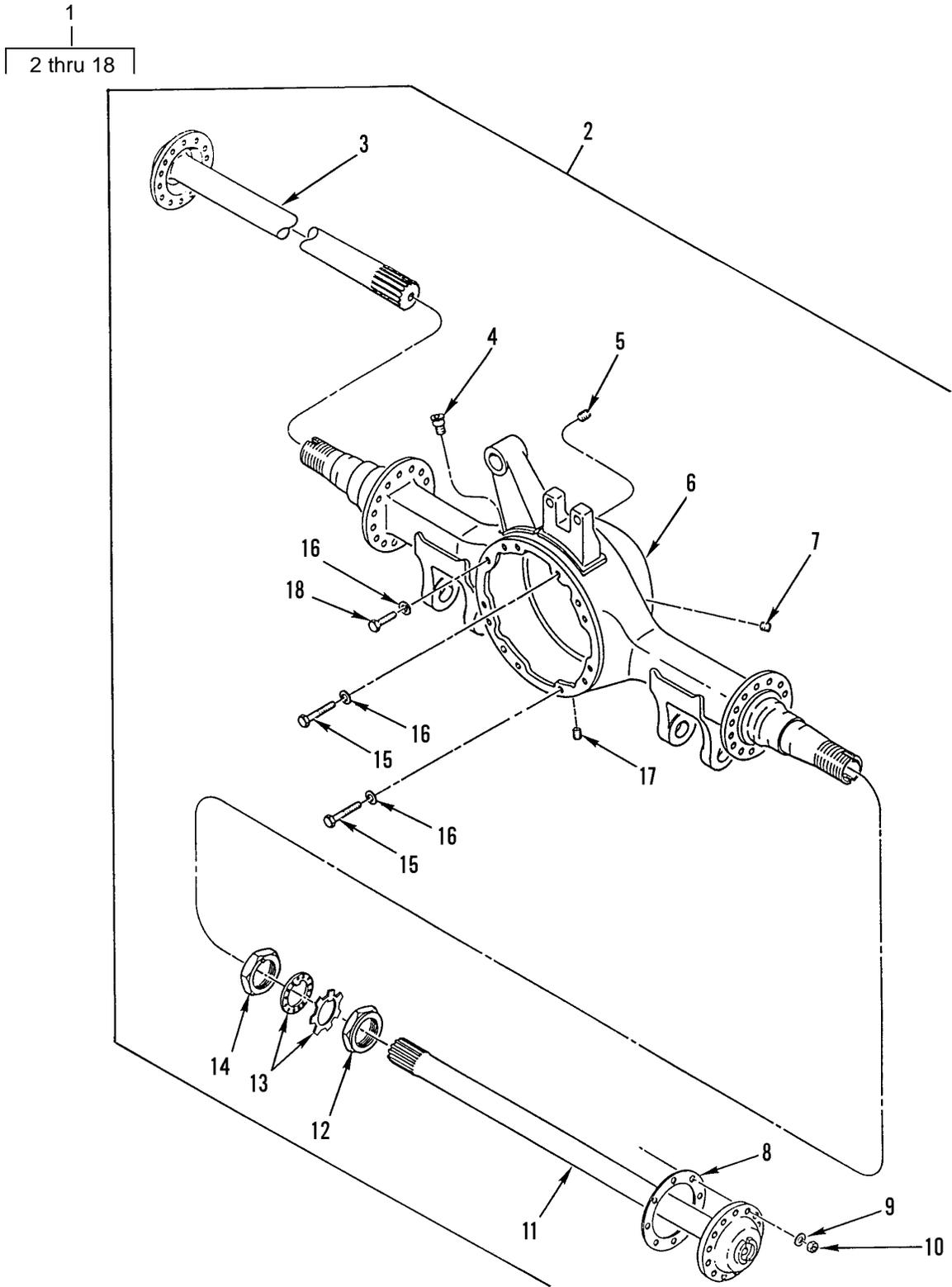

342-1512

Figure 141. Rear-Rear Axle Dressed

SECTION II			TM9-2320-302-24P			
(1)	(2)	(3)	(4)	(5)	(6)	(7)
ITEM	SMR			PART		
NO	CODE	NSN	CAGEC	NUMBER	DESCRIPTION AND USABLE ON CODES(UOC)	QTY
GROUP 1100 REAR AXLE ASSEMBLY						
FIG. 141 REAR-REAR AXLE DRESSED						
1	PGFHH	2520014715061	19207	12478863	AXLE ASSEMBLY,AUTOM.....	1
2	XAFHH		78500	RR20145NFN3281-5 29	.AXLE ASSY,TANDEM.....	1
3	PAFZZ		78500	3206-U-1347	..SHAFT,AXLE,AUTOMOTI R/S, LONG....	1
4	PAOZZ	2520003532286	78500	A1199P1394	..BREATHER.....	1
5	PAOZZ	4730013479326	78500	P28-S	..PLUG,PIPE.....	1
6	XAFZZ		78500	C34-3121P1966S	..HOUSING,AXLE.....	1
7	PAOZZ	4730000103875	81348	WW-P-471ACBBUE	..PLUG,PIPE.....	1
8	PAFZZ	5330005806567	79780	2208X440	..GASKET.....	2
9	PAFZZ	5310008095997	96906	MS27183-17	..WASHER,FLAT .62 X .937 X .09,HDN, PL.....	16
10	PAFZZ	5310013570821	64678	23-09247-210	..NUT,PLAIN,HEXAGON 5/18-18UNF.....	16
11	PAFZZ		78500	3206-T-1346	..SHAFT,AXLE,AUTOMOTI L/S, SHORT...	1
12	PAFZZ	5310012544255	78500	1227-R-330	..NUT,PLAIN,HEXAGON OUTER, 3 1/4- 12UN-2B.....	2
13	PAFZZ		78500	1229F4634S	..WASHER,LOCK BLANK INCLUDES WASHER W/HOLES & TANGED WASHER.....	2
14	PAFZZ	2520009177434	78500	1227W517	..NUT,WHEEL BEARING INNER, 3 1/4- 12UN-2B.....	2
15	PAFZZ	5305014664547	78500	10X1594	..SCREW,CAP,HEXAGON H 0.625-11UNC X 1.750.....	8
16	PAFZZ	5310010830104	19207	12267565	..WASHER,FLAT 1/2 IN USS ZINC PLATED.....	12
17	PAOZZ	5365011802369	78500	1250-E-473	..PLUG,MACHINE THREAD.....	1
18	PAFZZ		78500	10X1597	..SCREW,CAP,HEXAGON H 0.625-11UNC X 2.75.....	4

END OF FIGURE

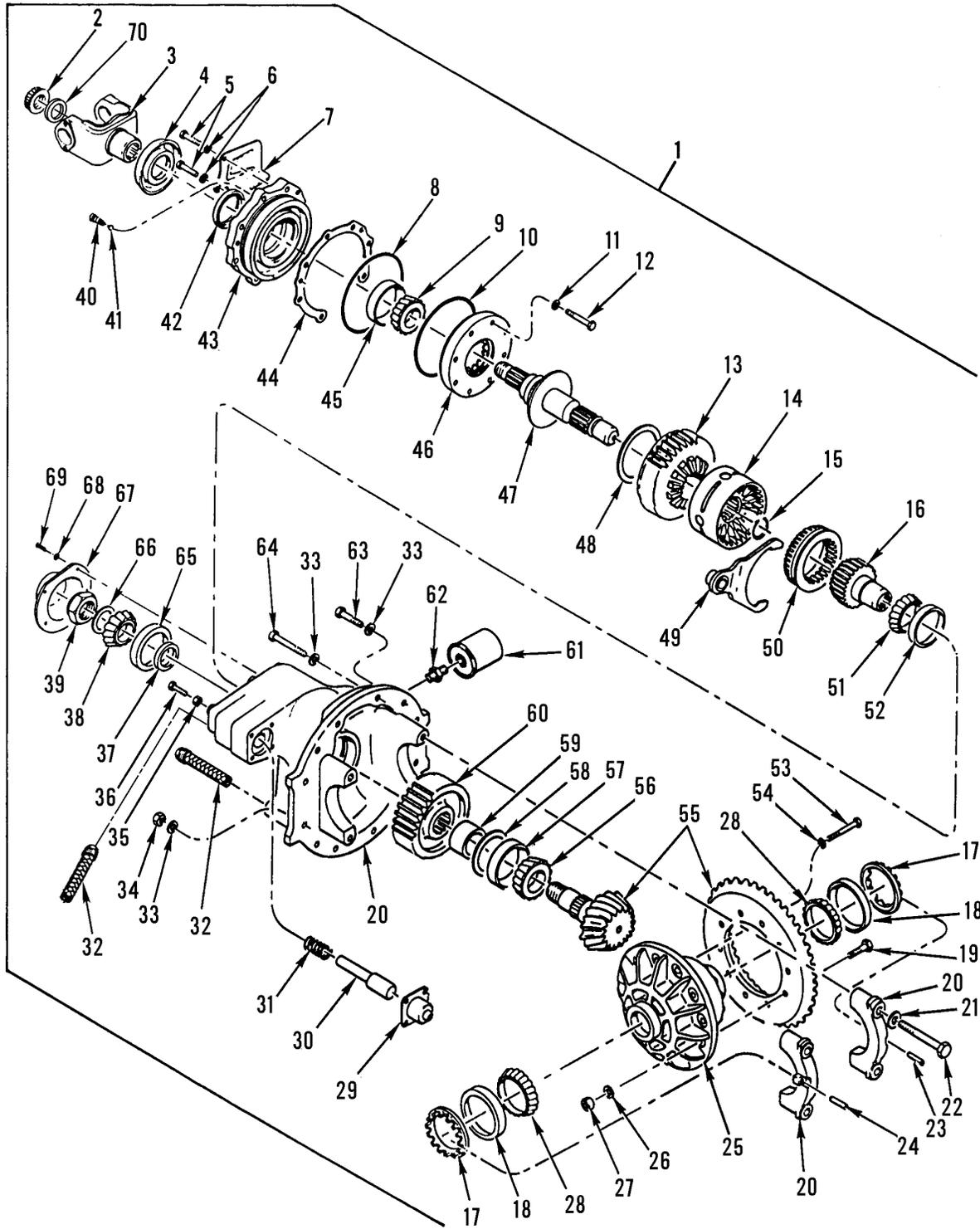

342-1472

Figure 142. Forward-Rear Axle Differential Carrier Assembly

SECTION II			TM9-2320-302-24P			
(1)	(2)	(3)	(4)	(5)	(6)	(7)
ITEM NO	SMR CODE	NSN	CAGEC	PART NUMBER	DESCRIPTION AND USABLE ON CODES(UOC)	QTY
GROUP 1102 DIFFERENTIAL						
FIG. 142 FORWARD-REAR AXLE DIFFERENTIAL CARRIER ASSEMBLY						
1	PGFHH		78500	A12-3200-H-1984-529M	DIFFERENTIAL, DRIVIN.....	1
2	PAHZZ	5310014661604	78500	40X-1233	.NUT, SELF-LOCKING, HE M45 X 1.5-6H..	2
3	PAOZZ	2520014813352	78500	A-3260-P-1264S	.YOKE, UNIVERSAL JOIN INPUT.....	1
4	PAOZZ	2520013308163	78500	DEFR567	.DEFLECTOR, DIRT AND.....	1
5	PAOZZ	5305012817811	81495	071 312 13	.SCREW, CAP, HEXAGON H M12 X 40 MM...	7
6	PAOZZ	5310008095997	96906	MS27183-17	.WASHER, FLAT .53 X .88 X .09.....	7
7	PFOZZ	5340013257332	78500	3280-Z-8398	.COVER, ACCESS.....	1
8	PAHZZ	5330013252615	78500	5X-1034	.SEAL, PLAIN.....	1
9	PAHZZ	3110001000380	81348	FFB187/01-TYPE A BMA 3920	.CUP, TAPERED ROLLER.....	1
10	PAHZZ	5330013252615	78500	5X-1034	.SEAL, PLAIN.....	1
11	PAHZZ	5310012009879	78500	1229-E-1669-C	.WASHER, FLAT.....	6
12	PAHZZ	5305013452449	78500	MS208045-1	.SCREW, CAP, HEXAGON H M8 X 1.25 X 45MM.....	6
13	PAHZZ	3020013256390	78500	3892-R-4932	.GEAR CLUSTER.....	1
14	PAHZZ	2520014813350	78500	A-3235-N-2380	.UNIVERSAL JOINT, GEA.....	1
15	PAHZZ	5325013257222	78500	2297-E-5335	.RING, RETAINING.....	1
16	PAHZZ	3020013300676	78500	2234-R-1188	.GEAR, BEVEL.....	1
17	PAHZZ	5365013302145	78500	2214-C-1095	.RING, EXTERNALLY THR.....	2
18	PAHZZ	3110001449455	60038	JM716610	.CUP, TAPERED ROLLER.....	2
19	PAHZZ	5305013293992	78500	41X-1216	.SCREW, CAP, HEXAGON H M16 X 1.5-10.0	12
20	XAHZZ		78500	A2-3200-H-1984	.CARRIER, DIFF & CAPS.....	1
21	PAHZZ	5310013257279	78500	42X-1021	.WASHER, FLAT METRIC PLAIN, 22 X 35 X 4 MM.....	4
22	PAHZZ	5305013255908	78500	MS220120-1	.SCREW, CAP, SOCKET HE.....	4
23	PAHZZ	5315013261864	78500	1246-P-1134	.PIN, STRAIGHT, HEADLE L/S.....	1
24	PAHZZ	5315008806027	78500	1199R2176	.PIN, COTTER.....	1
25	PAHZA	2520013338361	78500	A13-3235-W-1843	.SPIDER, DIFFERENTIAL.....	1
26	PAHZZ	5310010830104	19207	12267565	.WASHER, FLAT 1/2" USS CADMIUM PLATED.....	12
27	PAHZZ	5310013315832	78500	40X1182	.NUT, SELF-LOCKING, HE.....	12
28	PAHZZ	3110001449793	60038	JM716649	.CONE AND ROLLERS, TA R/S.....	1
29	PFHZZ	2530014701777	78500	A2-3261-Q-1057	.SHIFT, AIR ASSEMBLY SCREW-IN.....	1
30	PAHZZ	3040013300646	78500	2244-K-1025	.SHAFT, SHOULDERED.....	1
31	PAHZZ	5360004942165	78500	2258U411	.SPRING, HELICAL, COMP.....	1
32	XDHZZ		78500	A-2297-D-5334S	.SCREW, PLUG ASSY M26-1.5 X 154.0 MM X 20.0 MM.....	1
33	PAHZZ	5310010830104	19207	12267565	.WASHER, FLAT 1/2" USS CADMIUM PLATED.....	12
34	PAHZZ	5310002762698	78500	N110-1	.NUT, PLAIN, HEXAGON 5/8-18 UNF-2B...	2
35	PAHZZ	5310013262667	78500	MN-312-1	.NUT, PLAIN, HEXAGON M12 X 1.75MM...	1
36	PAHZZ	5305013255920	78500	41X-1208	.SCREW, CAP, HEXAGON H M12 X 1.75....	1
37	KFHZZ		78500	2203-D-9806	.SPACER 0.209 IN.....	2
37	KFHZZ		78500	2203-E-9807	.SPACER 0.210 IN PART OF KIT P/N 2396.....	2
37	KFHZZ		78500	2203-F-9808	.SPACER 0.211 IN.....	2

SECTION II		TM9-2320-302-24P			(6)	(7)
(1)	(2)	(3)	(4)	(5)		
ITEM	SMR			PART		
NO	CODE	NSN	CAGEC	NUMBER	DESCRIPTION AND USABLE ON CODES(UOC)	QTY
37	KFHZZ		78500	2203-G-9809	.SPACER 0.212 IN.....	2
37	KFHZZ		78500	2203-H-9810	.SPACER 0.213 IN.....	2
37	KFHZZ		78500	2203-J-9812	.SPACER 0.217 IN.....	2
37	KFHZZ		78500	2203-K-9813	.SPACER 0.220 IN.....	2
37	KFHZZ		78500	2203-L-9814	.SPACER 0.224 IN.....	2
37	KFHZZ		78500	2203-M-9815	.SPACER 0.228 IN.....	2
37	KFHZZ		78500	2203-N-9816	.SPACER 0.232 IN.....	2
37	KFHZZ		78500	2203-P-9818	.SPACER 0.236 IN.....	2
37	KFHZZ		78500	2203-Q-9819	.SPACER 0.240 IN.....	2
37	KFHZZ		78500	2203-R-9820	.SPACER 0.241 IN.....	2
37	KFHZZ		78500	2203-S-9821	.SPACER 0.242 IN.....	2
37	KFHZZ		78500	2203-T-9822	.SPACER 0.243 IN.....	2
37	KFHZZ		78500	2203-U-9823	.SPACER 0.244 IN.....	2
38	PAHZZ	3110009805621	60038	72212C	.CONE AND ROLLERS,TA.....	1
39	PAHZZ	5310014661604	78500	40X-1233	.NUT,SELF-LOCKING,HE M45 X 1.5-6H..	1
40	PAOZZ	5360013255795	78500	2258-Z-1118	.SPRING,HELICAL,COMP.....	1
41	PAOZZ	4820013254657	78500	2297-U-5273	.VALVE,SAFETY RELIEF.....	1
42	PAHZZ	5330014676287	78500	A1205R2592	.PARTS KIT,SEAL REPL.....	1
43	PFHZZ		78500	A-3226-D-1226	.PLATE,RETAINING,BEA.....	1
44	PAHZZ	5365013267524	78500	2203-K-9241	.SPACER,PLATE 0.003 IN.....	1
44	PAHZZ	5365013306369	78500	2203-L-9242	.SHIM 0.005 IN.....	1
44	PAHZZ	5365013306370	78500	2203-M-9243	.SHIM 0.010 IN.....	1
45	PAHZZ	3110001000380	60038	3920	.CUP,TAPERED ROLLER.....	1
46	PAHZZ	2815014064883	78500	A-3303-P-1030	.OIL PUMP ASSEMBLY,E.....	1
47	XDHZZ		78500	A-3297-T-1346S	.SHAFT,INPUT INPUT.....	1
48	PAHZZ	3120013252638	78500	1229-P-4072	.BEARING,WASHER,THRU.....	1
49	PAHZZ	2520013338359	78500	A-3296-A-1093	.SHIFTER FORK,VEHICU INTER AXLE....	1
50	PFHZZ	2520013636918	78500	3107-S-1059	.CLUTCH,SLIDING SLEE.....	1
51	PAHZZ	3110010990022	0LTL1	JLM710949	.CONE AND ROLLERS,TA.....	1
52	PAHZZ	3110010828752	78500	JLM-710910	.CUP,TAPERED ROLLER.....	1
53	XDHZZ	5305013468575	78500	41X-1327	.SCREW,CAP,HEXAGON H M12 X 2.0-12.9	16
54	PAHZZ	5310008095997	96906	MS27183-17	.WASHER,FLAT .53 X .88 X .09.....	16
55	PAHZZ		78500	B-41284-1	.GEAR,DRIVE,MOTION.....	1
56	PAHZZ	3110009697315	60038	H715334	.CONE AND ROLLERS,TA.....	1
57	PAHZZ	3110002273729	60038	H-715311	.CUP,TAPERED ROLLER.....	1
58	PAHZZ	5365010839531	78500	2203-F-2788	.SHIM 0.003 IN.....	1
58	PAHZZ	5365010839532	78500	2203-G-2789	.SHIM 0.127 IN.....	1
58	PAHZZ	5365010839533	78500	2203-H-2790	.SHIM 0.010 IN.....	1
59	PAHZZ	5365013302162	78500	1244-V-1764	.SPACER,SLEEVE.....	1
60	PAHZZ	3020013299942	78500	3892-N-4902	.GEAR,HELICAL.....	1
61	PAOZZ	2940005864792	78500	3280-V-8394	.FILTER ELEMENT,FLUI.....	1
62	PAOZZ	4730013253762	78500	2297-Z-5278	.ADAPTER,STRAIGHT,PI.....	1
63	PAFZZ	5305014664547	78500	10X1594	.SCREW,CAP,HEXAGON H 0.625-11UNC X	7
					1.750.....	
64	PAFZZ		78500	10X1597	.SCREW,CAP,HEXAGON H 0.625-11UNC X	3
					2.75.....	
65	PAHZZ	3110001000615	60038	72487	.CUP,TAPERED ROLLER.....	1
66	PAHZZ	5310013306362	78500	1229-G-4063	.WASHER,FLAT 52 X 87 X 6.35 MM.....	1
67	PFHZZ	5340013284438	78500	3266-C-1095	.COVER,ACCESS.....	1
68	PAHZZ	5310010839509	78500	1229-K-1597	.WASHER,FLAT 3/8 X .75 X .09.....	5
69	PAHZZ	5305013418825	78500	MS210020-1	.SCREW,CAP,HEXAGON H M10 X 1.5 X	5
					20MM.....	
70	PAHZZ		78500	1229-W-4521S	.WASHER,FLAT 82.5MM OD X 45.6MM ID	1
					X 8.5MM THK.....	

END OF FIGURE

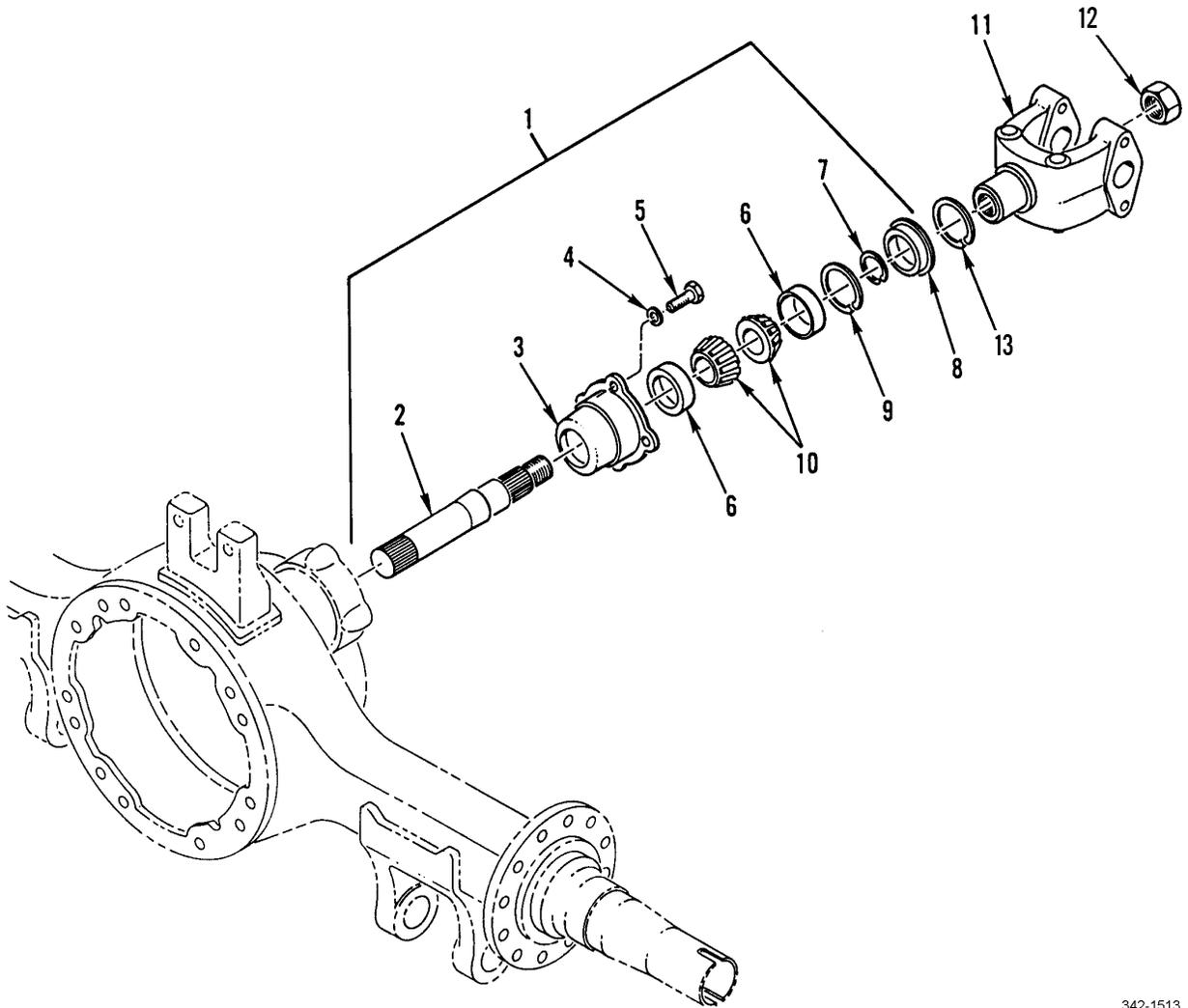

342-1513

Figure 143. Forward-Rear Axle Output Shaft Assembly

SECTION II			TM9-2320-302-24P			
(1)	(2)	(3)	(4)	(5)	(6)	(7)
ITEM	SMR			PART		
NO	CODE	NSN	CAGEC	NUMBER	DESCRIPTION AND USABLE ON CODES(UOC)	QTY
GROUP 1102 DIFFERENTIAL						
FIG. 143 FORWARD-REAR AXLE OUTPUT SHAFT ASSEMBLY						
1	PAFFF	3130013264524	78500	A1-3226-T-1112	HOUSING,BEARING UNI.....	1
2	XAFZZ		78500	3297-E-1019	.SHAFT,OUTPUT.....	1
3	PAFZZ	3130013252662	78500	A-3226-T-1112	.HOUSING,BEARING UNI.....	1
4	PAFZZ	5310010839509	78500	1229-K-1597	.WASHER,FLAT 3/8 X .75 X .09.....	4
5	XDFZZ	5305013255907	78500	15X-387	.SCREW,CAP,SOCKET HE 9/16 HD DIA X 1 3/8 LG.....	4
6	PAFZZ	3110001913923	60038	JLM104910	.CUP,TAPERED ROLLER.....	2
7	PAFZZ	5325013257221	78500	1229-W-4131	.RING,RETAINING.....	1
8	PAOZZ	5330013887501	62265	3915647	.SEAL,PLAIN ENCASED.....	1
9	PAFZZ	5365012891922	78500	1229-P-2590	.SPACER,RING 0.155 IN.....	1
10	PAFZZ	3110004008419	60038	LM104949	.CONE AND ROLLERS,TA.....	2
11	PAOZZ		95019	6-4-6371	YOKE,UNIVERSAL JOIN OUTPUT.....	1
12	PAOZZ	5310014661602	78500	40X1237	NUT,SELF-LOCKING,HE M39 X 1.5-6H...	1
13	PAOZZ	5310011850433	78500	1229T1736	WASHER,FLAT.....	1

END OF FIGURE

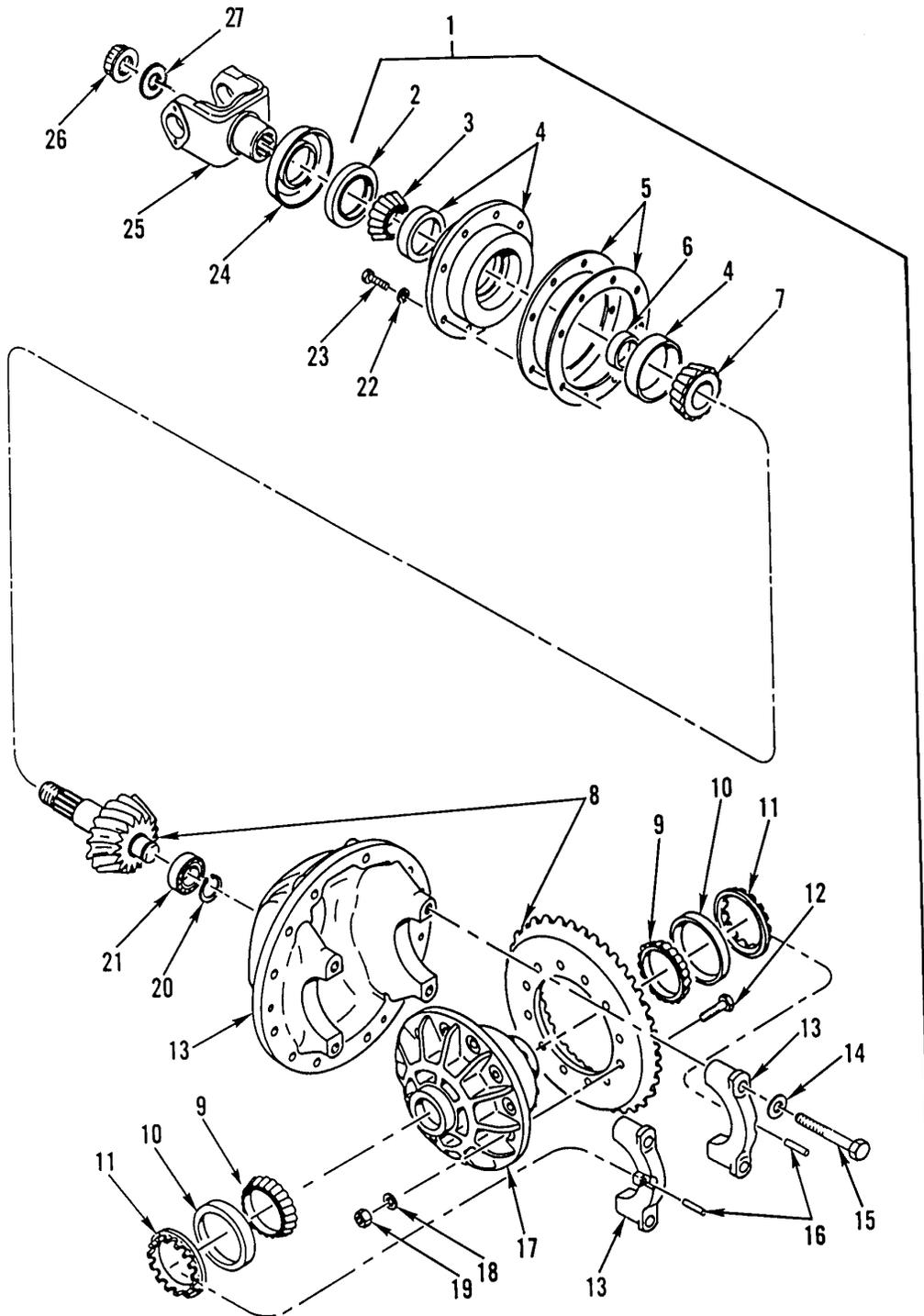

342-1518

Figure 144. Rear-Rear Axle Differential Carrier Assembly

SECTION II			TM9-2320-302-24P			
(1)	(2)	(3)	(4)	(5)	(6)	(7)
ITEM NO	SMR CODE	NSN	CAGEC	PART NUMBER	DESCRIPTION AND USABLE ON CODES(UOC)	QTY
GROUP 1102 DIFFERENTIAL						
FIG. 144 REAR-REAR AXLE DIFFERENTIAL CARRIER ASSEMBLY						
1	PAFHH		78500	C7-3200S1865-529 M	DIFFERENTIAL,DRIVEI.....	1
2	PAHZZ	5330012694327	78500	A1205-H-2426	.GASKET.....	1
3	PAHZZ	3110001003630	60038	55206	.CONE AND ROLLERS,TA.....	1
4	XDHZZ		78500	A-3226-N-1236	.HOUSING,BEARING UNI.....	1
5	KFHZZ		78500	2203-W-9175	.SHIM 0.003 IN. PART OF KIT P/N KIT 2313.....	1
5	KFHZZ		78500	2203-C-8115..	.SHIM PART OF KIT P/N KIT 1568.....	1
5	KFHZZ		78500	2203-X-9176	.SHIM 0.005 IN. PART OF KIT P/N KIT 2313.....	1
5	KFHZZ		78500	2203-D-8116..	.SHIM PART OF KIT P/N KIT 1568.....	1
5	KFHZZ		78500	2203-Y-9177	.SHIM 0.008 IN. PART OF KIT P/N KIT 2313.....	1
5	KFHZZ		78500	2203-E-8117..	.SHIM PART OF KIT P/N KIT 1568.....	1
5	KFHZZ		78500	2203-Z-9178	.SPACER 0.020 IN. PART OF KIT P/N KIT 1568.....	1
5	KFHZZ		78500	2203-B-9804	.SPACER PART OF KIT P/N KIT 1568....	1
6	KFHZZ		78500	2203-J-9474	.SPACER 0.345 IN. PART OF KIT P/N KIT 2322.....	2
6	KFHZZ		78500	2203-K-9475	.SPACER 0.346 IN. PART OF KIT P/N KIT 2322.....	2
6	KFHZZ		78500	2203-L-9476	.SPACER 0.347 IN. PART OF KIT P/N KIT 2322.....	2
6	KFHZZ		78500	2203-M-9477	.SPACER 0.348 IN. PART OF KIT P/N KIT 2322.....	2
6	KFHZZ		78500	2203-N-9478	.SPACER 0.349 IN. PART OF KIT P/N KIT 2322.....	2
6	KFHZZ		78500	2203-P-9480	.SPACER 0.354 IN. PART OF KIT P/N KIT 2322.....	2
6	KFHZZ		78500	2203-Q-9481	.SPACER 0.358 IN. PART OF KIT P/N KIT 2322.....	2
6	KFHZZ		78500	2203-R-9482	.SPACER 0.359 IN. PART OF KIT P/N KIT 2322.....	2
6	KFHZZ		78500	2203-S-9483	.SPACER 0.360 IN. PART OF KIT P/N KIT 2322.....	2
6	KFHZZ		78500	2203-T-9484	.SPACER 0.361 IN. PART OF KIT P/N KIT 2322.....	2
6	KFHZZ		78500	2203-U-9485	SPACER 0.362 IN. PART OF KIT P/N KIT 2322.....	2
7	PAHZZ	3110009805621	60038	72212C	.CONE AND ROLLERS,TA.....	1
8	PAHZZ		78500	B-41274-1	.DIFFERENTIAL,DRIVIN.....	1
9	PAHZZ	3110001449793	60038	JM716649	.CONE AND ROLLERS,TA L/H.....	2
10	PAHZZ	3110001449455	60038	JM716610	.CUP,TAPERED ROLLER L/H.....	2
11	PAHZZ	5365013302145	78500	2214-C-1095	.RING,EXTERNALLY THR.....	2
12	PAHZZ	5305013293992	78500	41X-1216	.SCREW,CAP,HEXAGON H M16 X 1.5-10.0	12
13	XAHZZ		78500	KIT 2756	.CARRIER,DIFF & CAPS.....	1
14	PAHZZ	5310013257279	78500	42X-1021	.WASHER,FLAT METRIC PLAIN,22 X 35	4

SECTION II			TM9-2320-302-24P			
(1)	(2)	(3)	(4)	(5)	(6)	(7)
ITEM	SMR			PART		
NO	CODE	NSN	CAGEC	NUMBER	DESCRIPTION AND USABLE ON CODES(UOC)	QTY
15	PAHZZ	5305013255908	78500	MS220120-1	X 4 MM.....	
					.SCREW,CAP,SOCKET HE M20 X 2.5 X	4
					120MM.....	
16	PAHZZ	5315008806027	78500	1199R2176	.PIN,COTTER 0.220 DIA X 1.40 LG....	1
17	PAHZZ		78500	A9-3235W1843	.HOUSING,MECHANICAL.....	1
18	PAHZZ	5310010830104	19207	12267565	.WASHER,FLAT 17.25 MM X 32.00 MM...	12
19	PAHZZ	5310013315832	78500	40X-1182	.NUT,SELF-LOCKING,HE.....	12
20	PAHZZ	5325007157391	78500	1229-A-1301	.RING,RETAINING.....	1
21	PAHZZ	3110010994888	14262	1228-F-552	.BEARING.....	1
22	PAHZZ	5310008095997	96906	MS27183-17	.WASHER,FLAT .53 X .88 X .09.....	8
23	PAHZZ	5305013560042	78500	MS212045-1	.SCREW,CAP,HEXAGON H M12 X 1.75 X	8
					45MM.....	
24	PAOZZ		78500	DEFR59 1	DEFLECTOR,DIRT AND.....	1
25	PAOZZ		95019	6-4-6371	YOKE,UNIVERSAL JOIN INPUT.....	1
26	PAOZZ	5310014661602	78500	40X1237	NUT,SELF-LOCKING,HE M39 X 1.5-6H...	1
27	PAOZZ	5310011850433	78500	1229T1736	WASHER,FLAT.....	1

END OF FIGURE

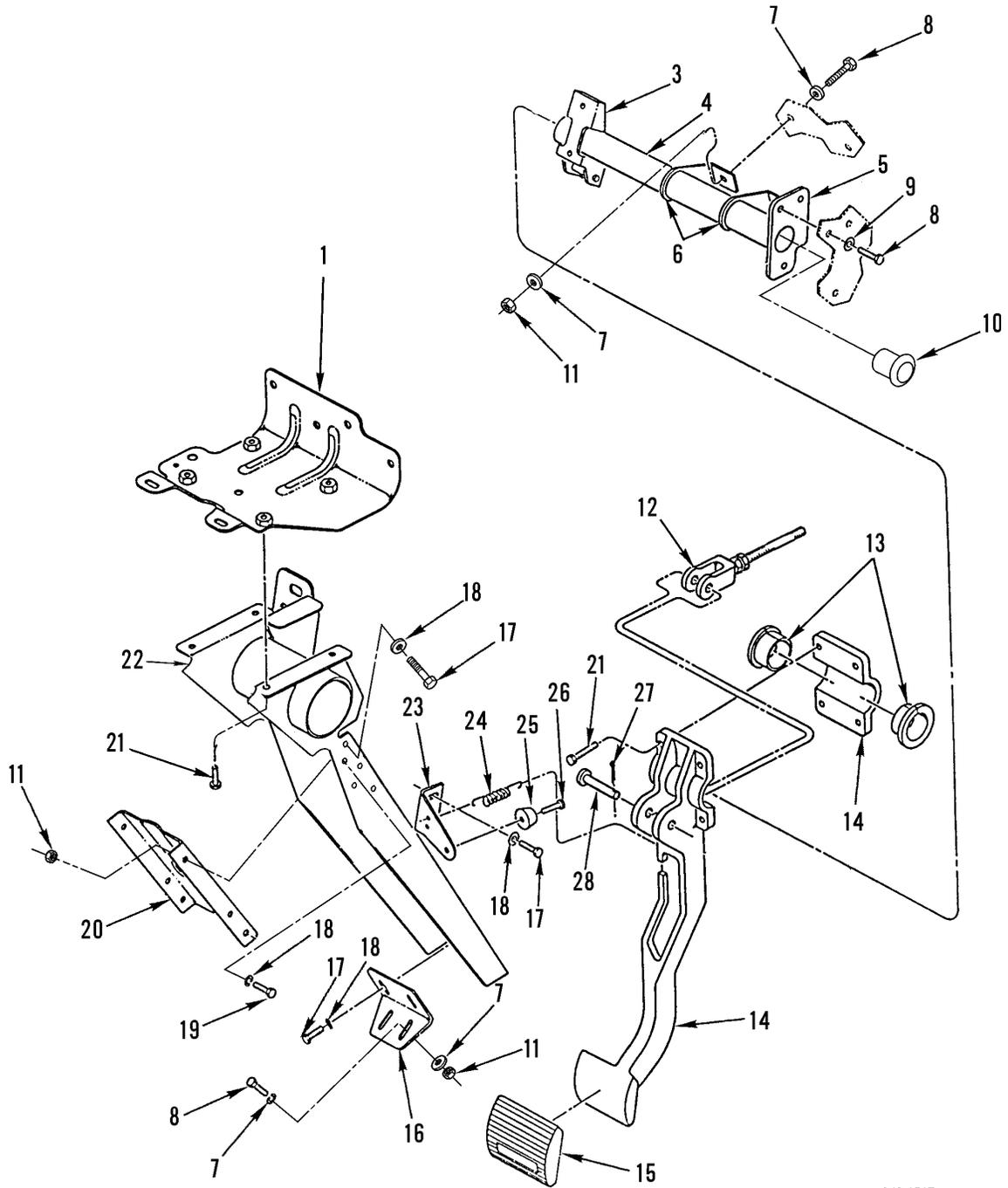
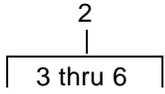

342-1517

Figure 145. Hanging Brake Assembly

SECTION II			TM9-2320-302-24P			
(1)	(2)	(3)	(4)	(5)	(6)	(7)
ITEM NO	SMR CODE	NSN	CAGEC	PART NUMBER	DESCRIPTION AND USABLE ON CODES(UOC)	QTY
GROUP 12 BRAKES						
GROUP 1202 SERVICE BRAKES						
FIG. 145 HANGING BRAKE ASSEMBLY						
1	XDOZZ		64678	A18-26290-000	BRACKET,ANGLE.....	1
2	XDOOO		64678	A02-12094-000	BRKT,ASSY BK SHAFT.....	1
3	XAOZZ		64678	02-09920-000	.BRACKET,HUB.....	1
4	XAOZZ		64678	02-12094-010	.TUBE.....	1
5	XAOZZ		64678	A02-12002-000	.FLANGE,HUB ASSY.....	1
6	XAOZZ		64678	12-12238-000	.RETAINER.....	2
7	PAOZZ	5310009843806	81349	M45913/1-5CG5C	NUT,SELF-LOCKING,HE 5/16 ID X .688 OD X .065 THK.....	8
8	PAOZZ	5306010758519	96906	MS90725-36	BOLT,MACHINE 5/16-18UNC X 1.250....	7
9	PAOZZ	5310009746623	96906	MS35338-140	WASHER,LOCK .318 MAX. ID X .586 MAX. OD.....	3
10	XDOZZ		64678	23-11688-022	PLUG,PROTECTIVE,DUS 1 1/16 X .10...	1
11	PAOZZ	5310009843806	81349	M45913/1-5CG5C	NUT,SELF-LOCKING,HE 5/16-18.....	4
12	PAOZZ	5315013284358	64678	12-12241-000	PIN,STRAIGHT,THREAD.....	1
13	PAOZZ	3120007029850	96881	24L24-F	BEARING,SLEEVE.....	2
14	XDOZZ		64678	A12-13828-000	BRAKE PEDAL ASSY.....	1
15	XDOZZ		64678	12-12336-000	PAD,PEDAL,BK.....	1
16	XDOZZ		64678	18-23794-000	BRKT STRG LOWER.....	1
17	XDOZZ		64678	23-10742-062	CAPSCREW 1/4-20 X .625 GR 5.....	5
18	PAOZZ	5310013570878	64678	23-09983-025	WASHER,LOCK 1/4 IN.....	5
19	PAOZZ	5306002264843	80204	B1821BH031C450N	BOLT,MACHINE 1/16-18 X 4.5 LONG....	2
20	XDOZZ		64678	A18-25208-000	BRKT-STRG COLUMN.....	1
21	PAOZZ	5305013284357	64678	23-12020-062	SCREW,CAP,SOCKET HE 1/4.....	4
22	XDOZZ		64678	A18-25672-003	SUPPORT,STEERING CO.....	1
23	XDOZZ		64678	12-13340-000	BKT,BK STOP.....	1
24	PAOZZ	5360013284126	64678	12-12280-000	SPRING,HELICAL,COMP.....	1
25	PFOZZ	5340002723560	70485	23W	BUMPER,NONMETALLIC.....	1
26	PAOZZ	5305014418719	64678	23-12022-075	SCREW,MACHINE 10-24 X .75.....	1
27	PAOZZ	5315008423044	02032	JHP42-113	PIN,COTTER.....	1
28	XDOZZ		64678	23-11377-028	PIN,STRAIGHT,HEADED 3/8 X 2.0".....	1

END OF FIGURE

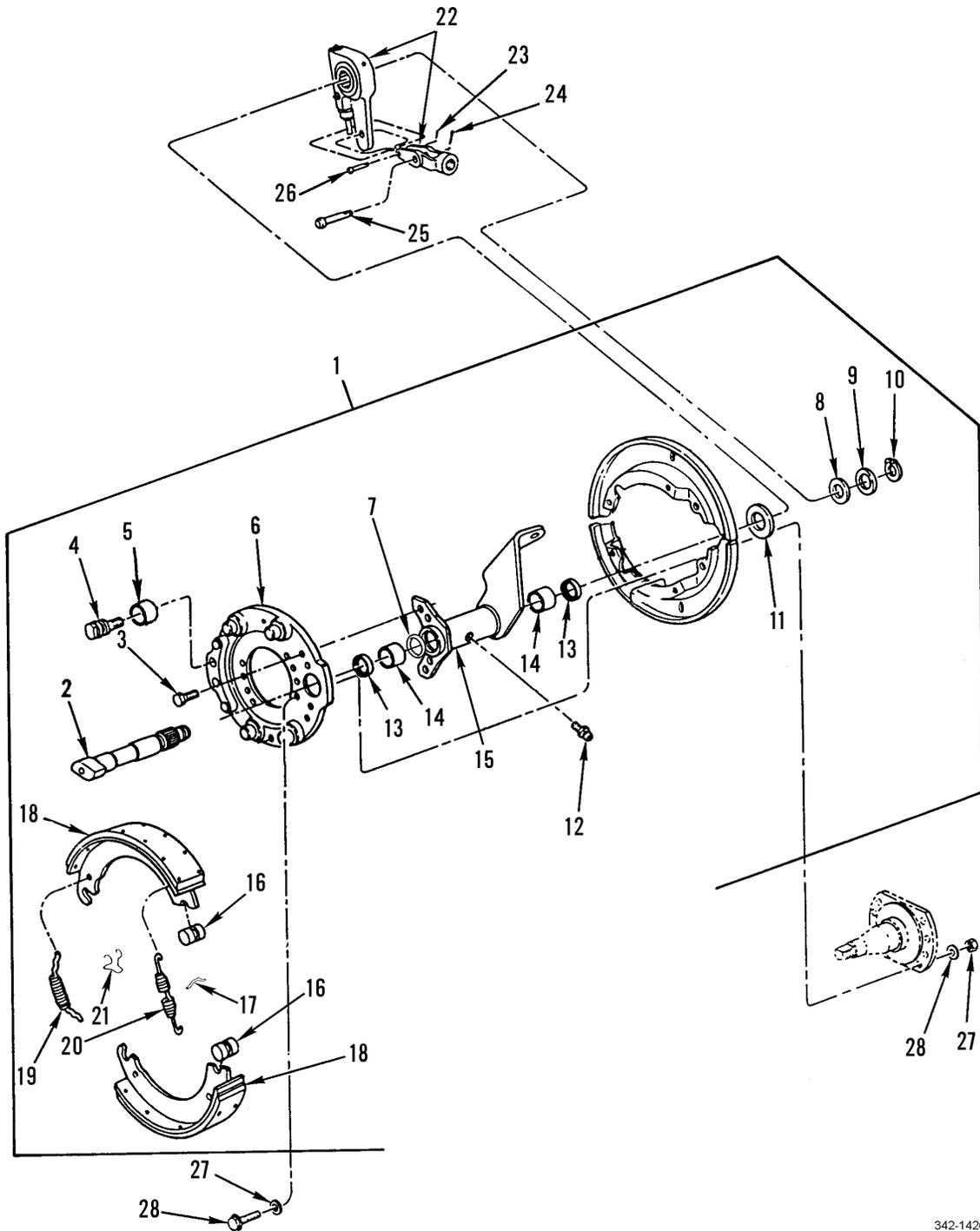

342-1426

Figure 146. Front Brake Assembly

SECTION II			TM9-2320-302-24P			
(1)	(2)	(3)	(4)	(5)	(6)	(7)
ITEM NO	SMR CODE	NSN	CAGEC	PART NUMBER	DESCRIPTION AND USABLE ON CODES(UOC)	QTY
GROUP 1202 SERVICE BRAKES						
FIG. 146 FRONT BRAKE ASSEMBLY						
1	PAOOO		78500	QP6 1540 1086	BRAKE,SHOE TYPE RIGHT.....	1
1	PAOOO		78500	QP6 1540 1085	BRAKE,SHOE TYPE LEFT.....	1
2	PFOZZ	2530014790541	78500	2210N7450	.CAMSHAFT,ACTUATING RIGHT.....	1
2	PFOZZ	2530014790545	78500	2210M7449	.CAMSHAFT,ACTUATING LEFT.....	1
3	PAOZZ	5305014476368	78500	S2810B	.SCREW,CAP,HEXAGON H.....	4
4	PAOZZ	5315011296898	78500	1259-N-274	.PIN,SHOULDER,HEADLE PART OF KIT P/N KSR301 4702QP.....	2
5	PAOZZ	3120002556042	78500	1225B496	.BUSHING,ANCHOR PIN PART OF KIT P/N KSR301 4702QP.....	2
6	XDOZZ		78500	A3211K5783	.PLATE,BACKING,BRAKE RIGHT, SPIDER..	1
6	XDOZZ		78500	A3211J5782	.PLATE,BACKING,BRAKE LEFT, SPICER..	1
7	PAOZZ	5331014785191	78500	1205G761	.O-RING.....	1
8	XDOZZ		78500	1229J3130	.WASHER,FLAT 1.250 ID X 1.875 OD...	1
9	PAOZZ	5365011269574	78500	1229-S-2697	.SPACER,RING.....	1
10	PAOZZ	5365012135069	78500	1229D2942	.RETAINER.....	1
11	PAOZZ	5310014459489	78500	1229-N-4590	.WASHER,FLAT.....	2
12	PAOZZ	4730000504208	96906	MS15003-1	.FITTING,LUBRICATION.....	1
13	PAOZZ	5330010841063	78500	A-1205-V-1556	.SEAL ASSEMBLY.....	2
14	PAOZZ		78500	1225L1208	.BUSHING,SLEEVE.....	2
15	XDOZZ		78500	A1 3299A6787	.BRACKET,MOUNTING RIGHT.....	1
15	XDOZZ		78500	A1 3299Z6786	.BRACKET,MOUNTING LEFT.....	1
16	KFOZZ		78500	2297T7222	.ROLLER PART OF KIT P/N KSR301 4702QP.....	1
17	PAOZZ	5315007840637	78500	1218G85	.PIN,RETURN SPRING PART OF KIT P/N KSR301 4702QP.....	1
18	KFOZZ		78500	A6 3222M2223	.SHOE & LINING ASSY INCLUDES ROLLER PART OF KIT P/N KSR301 4702QP.....	2
19	KFOZZ		78500	2258L1234	.SPRING,RETURN PART OF KIT P/N KSR301 4702QP.....	1
20	KFOZZ		78500	2258H1230	.SPRING,RETAINER PART OF KIT P/N KSR301 4702QP.....	2
21	PAOZZ	5340013284418	78500	3105-B-210	.CLIP,SPRING TENSION PART OF KIT P/N KSR301 4702QP.....	1
22	PAOOO		78500	R801079	ADJUSTER,SLACK,BRAK.....	2
23	PAOZZ	5315013643744	78500	2257C1173	.PIN,LOCK 0.055 0.53.....	2
24	PAOZZ	5315014787697	78500	2257D1174	.PIN.LOCK 0.072 1.26.....	2
25	XDOZZ		78500	19X1116	.PIN,STRAIGHT,HEADED 0.490 1.225..	2
26	PAOZZ	5315013153614	78500	19X127	PIN,STRAIGHT,HEADED.....	2
27	PAOZZ	5310008095997	96906	MS27183-17	WASHER,FLAT 0.69 X 0.94 X 0.117 THK	28
28	PAOZZ	5305007247222	80204	B1821BH063C200N	SCREW,CAP,HEXAGON H 5/8-11 X 2.00..	14

END OF FIGURE

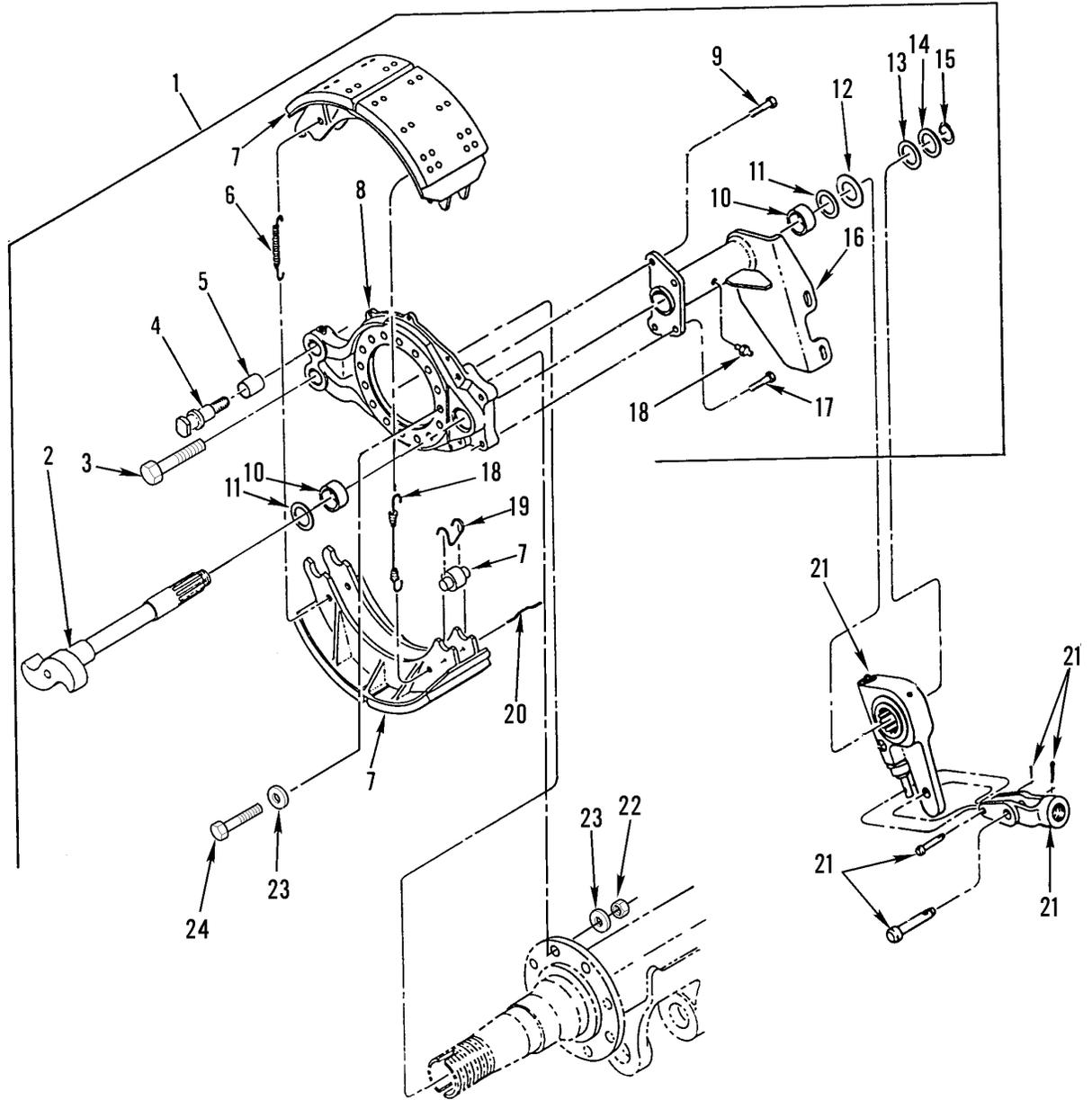

342-1425

Figure 147. Rear Brake Assembly

SECTION II			TM9-2320-302-24P			
(1)	(2)	(3)	(4)	(5)	(6)	(7)
ITEM NO	SMR CODE	NSN	CAGEC	PART NUMBER	DESCRIPTION AND USABLE ON CODES(UOC)	QTY
GROUP 1202 SERVICE BRAKES						
FIG. 147 REAR BRAKE ASSEMBLY						
1	PAOOO		78500	QPX 1657 7305	BRAKE,SHOE TYPE LH FWD REAR.....	1
1	PAOOO		78500	QPX 1657 7306	BRAKE,SHOE TYPE RH FWD REAR.....	1
1	PAOOO		78500	QPX 1657 7909	BRAKE,SHOE TYPE LH REAR-REAR.....	1
1	PAOOO		78500	QPX 1657 7910	BRAKE,SHOE TYPE RH REAR-REAR.....	1
2	PFOZZ	2530014790550	78500	2210-L-7604	.CAMSHAFT,ACTUATING, LH FWD REAR...	1
2	PFOZZ	2530014790826	78500	2210-K-7603	.CAMSHAFT,ACTUATING RH FWD REAR...	1
2	PFOZZ	2530014787622	78500	2210-A-7645	.CAMSHAFT,ACTUATING, LH REAR-REAR..	1
2	PFOZZ	2530014787619	78500	2210-Z-7644	.CAMSHAFT,ACTUATING, RH REAR-REAR..	1
3	PAOZZ	5305009413580	96906	MS35307-464	SCREW,CAP,HEXAGON H QTY = 1 EACH	2
					SIDE OF FWD-REAR.....	
4	PFOZZ	5315011296898	78500	1259-N-274	.PIN,SHOULDER,HEADLE PART OF KIT P/N	2
					KSR2024515Q.....	
5	PFOZZ	3120002556042	78500	1225-B-496	.BUSHING,ANCHOR PIN PART OF KIT P/N	2
					KSR2024515Q.....	
6	KFOZZ		78500	2258-H-1230	.SPRING,RETAINER PART OF KIT P/N	2
					2KSR2024707QP.....	
7	KFOZZ		78500	A3-3222-D-2006	.BRAKE SHOE ASSEMBLY INCLUDES	2
					ROLLERS PART OF KIT P/N	
					2KSR2024707QP.....	
8	XDOZZ		78500	A8-3211-P-3448	.PLATE,BACKING,BRAKE FWD REAR,	1
					SPIDER LH AND RH.....	
8	XDOZZ		78500	A3-3211-Q-4307	.PLATE,BACKING,BRAKE LH & RH REAR-	1
					REAR, SPIDER.....	
9	PAOZZ	5305014476368	78500	S2810B	.SCREW,CAP,HEXAGON H.....	4
10	PAOZZ	3120014788661	78500	1225-R-512	.BUSHING,SLEEVE.....	2
11	PFOZZ	5330013440636	78500	NA1205V1556	.SEAL,PLAIN.....	2
12	XDOZZ		78500	1229-H-4090	.WASHER,FLAT 1.53 X 2.38 X 0.104	1
					THK.....	
13	XDOZZ		78500	1229-J-3130	.WASHER,FLAT 1.25 X 1.875 X 0.031	2
					THK.....	
14	XDOZZ		78500	1229-W-3117	.WASHER,FLAT 1.26 X 1.88 X 0.12 THK	2
15	PAOZZ	5365012135069	78500	1229D2942	.RETAINER.....	1
16	XDOZZ		78500	B20-3299-E-6089	.BRACKET,MOUNTING LH FWD REAR.....	1
16	XDOZZ		78500	B20-3299-F-6090	.BRACKET,MOUNTING RH FWD REAR.....	1
16	XDOZZ		78500	D63-3299-V-5196	.BRACKET,MOUNTING LH REAR-REAR.....	1
16	XDOZZ		78500	D63-3299-U-5195	.BRACKET,MOUNTING RH REAR-REAR.....	1
17	PAOZZ	4730000504208	96906	MS15003-1	.FITTING,LUBRICATION.....	1
18	KFOZZ		78500	2258-W-803	.SPRING,RETURN PART OF KIT P/N	1
					2KSR2024707QP.....	
19	PAOZZ	5340013284418	78500	3105-B-210	.CLIP,SPRING TENSION.....	1
20	PAOZZ	5315007840637	78500	1218-G-85	.PIN,RETURN SPRING.....	1
21	PAOOO		73973	AS1040	ADJUSTER,SLACK,BRAK LH & RH SIDES	2
					OF FWD REAR AXLE.....	
21	PAOOO		73973	SA098 02	ADJUSTER,SLACK,BRAK LH & RH SIDES	2
					OF REAR-REAR AXLE.....	
22	PAOZZ	5310002694040	81349	M45913/1-10CG5C	NUT,SELF-LOCKING,HE QTY = 16 FOR	32
					FWD-REAR, AND REAR-REAR.....	
23	PAOZZ	5310008095997	96906	MS27183-17	WASHER,FLAT QTY = 30 ON FWD-REAR,	62
					AND QTY = 32 ON REAR-REAR.....	
24	PAOZZ	5305007247222	80204	B1821BH063C200N	SCREW,CAP,HEXAGON H QTY = 14 ON	30
					FWD-REAR, AND QTY = 16 ON REAR-REAR.	

END OF FIGURE

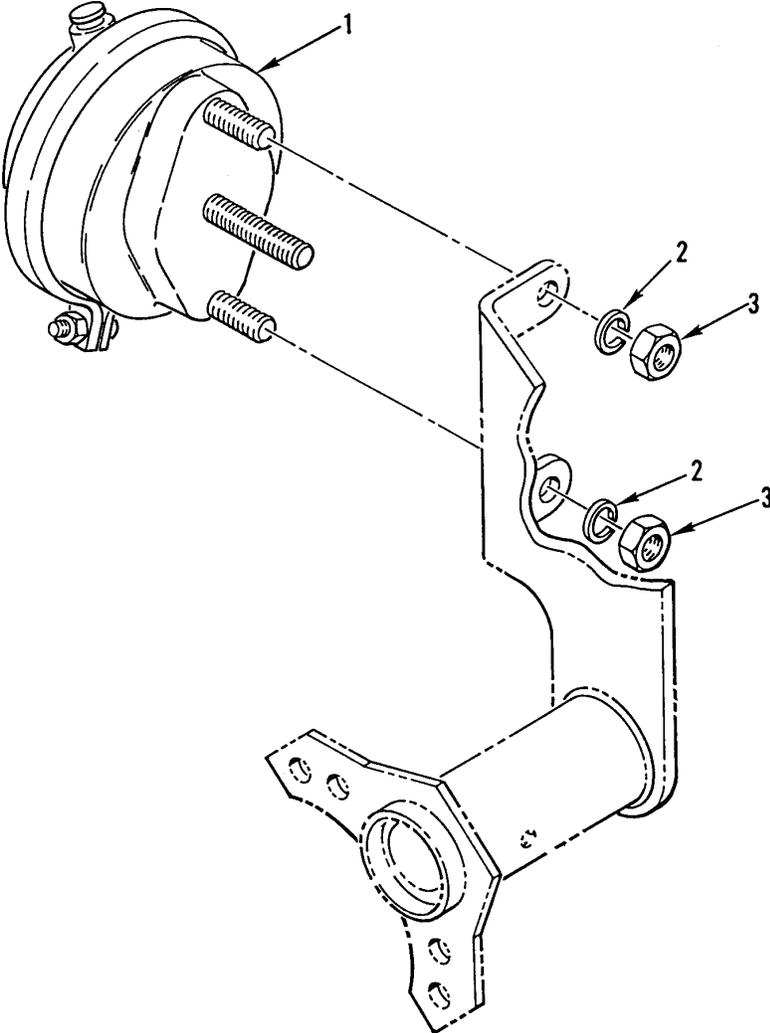

342-1299

Figure 148. Front Brake Chamber

SECTION II		TM9-2320-302-24P				
(1)	(2)	(3)	(4)	(5)	(6)	(7)
ITEM	SMR			PART		
NO	CODE	NSN	CAGEC	NUMBER	DESCRIPTION AND USABLE ON CODES(UOC)	QTY
GROUP 1202 SERVICE BRAKES						
FIG. 148 FRONT BRAKE CHAMBER						
1	PAOZZ	2530012787558	06721	MA36200	CHAMBER,AIR BRAKE.....	2
2	PAOZZ	5310010593609	78500	1229-N-1626	WASHER,FLAT 1.35 X .15.....	4
3	PAOZZ	5310007638920	96906	MS51967-20	NUT,PLAIN,HEXAGON .625-11UNC-2B....	4

END OF FIGURE

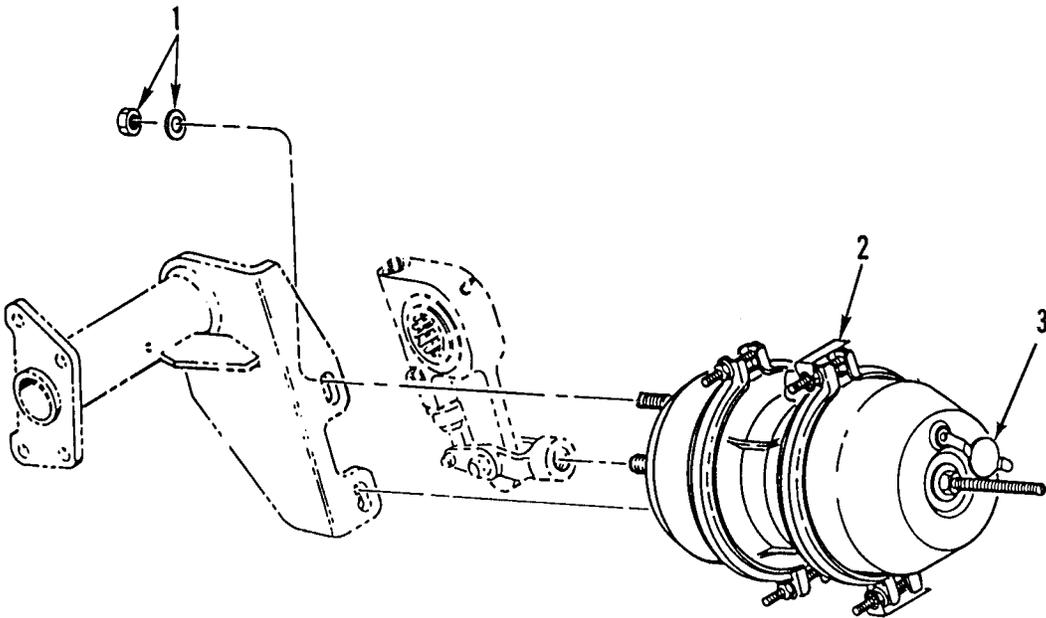

342-1336

Figure 149. Rear Brake Chamber

SECTION II			TM9-2320-302-24P			
(1)	(2)	(3)	(4)	(5)	(6)	(7)
ITEM	SMR			PART		
NO	CODE	NSN	CAGEC	NUMBER	DESCRIPTION AND USABLE ON CODES(UOC)	QTY
GROUP 1208 AIRBRAKE SYSTEM						
FIG. 149 REAR BRAKE CHAMBER						
1	PAOZZ	5310013165096	4B100	9002001	NUT AND WASHER KIT 5/8 IN. STEEL...	4
2	PAOZZ	2530013300002	64678	MGM/3430080	CHAMBER,AIR BRAKE LEFT FORWARD/ RIGHT REAR.....	2
2	PAOZZ	2530013312996	64678	MGM/3430081	CHAMBER,AIR BRAKE RIGHT FORWARD/ LEFT REAR.....	2
3	PAOZZ	5340013676668	4B100	9019005	PLUG,PROTECTIVE,DUS.....	1

END OF FIGURE

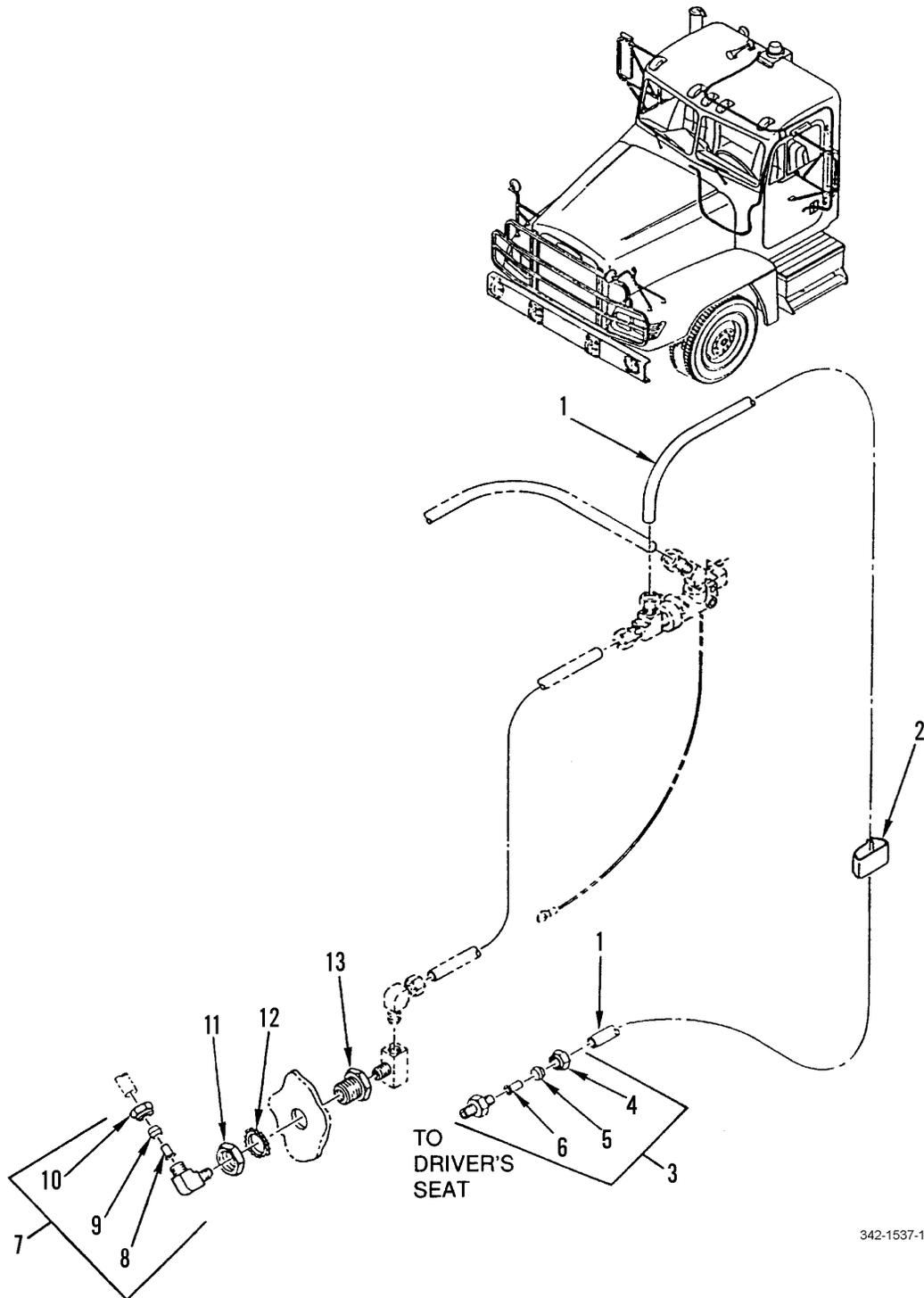

342-1537-1

Figure 150. Air System Valves, Tanks, Lines and Fittings, Part 1 (Sheet 1 of 3)

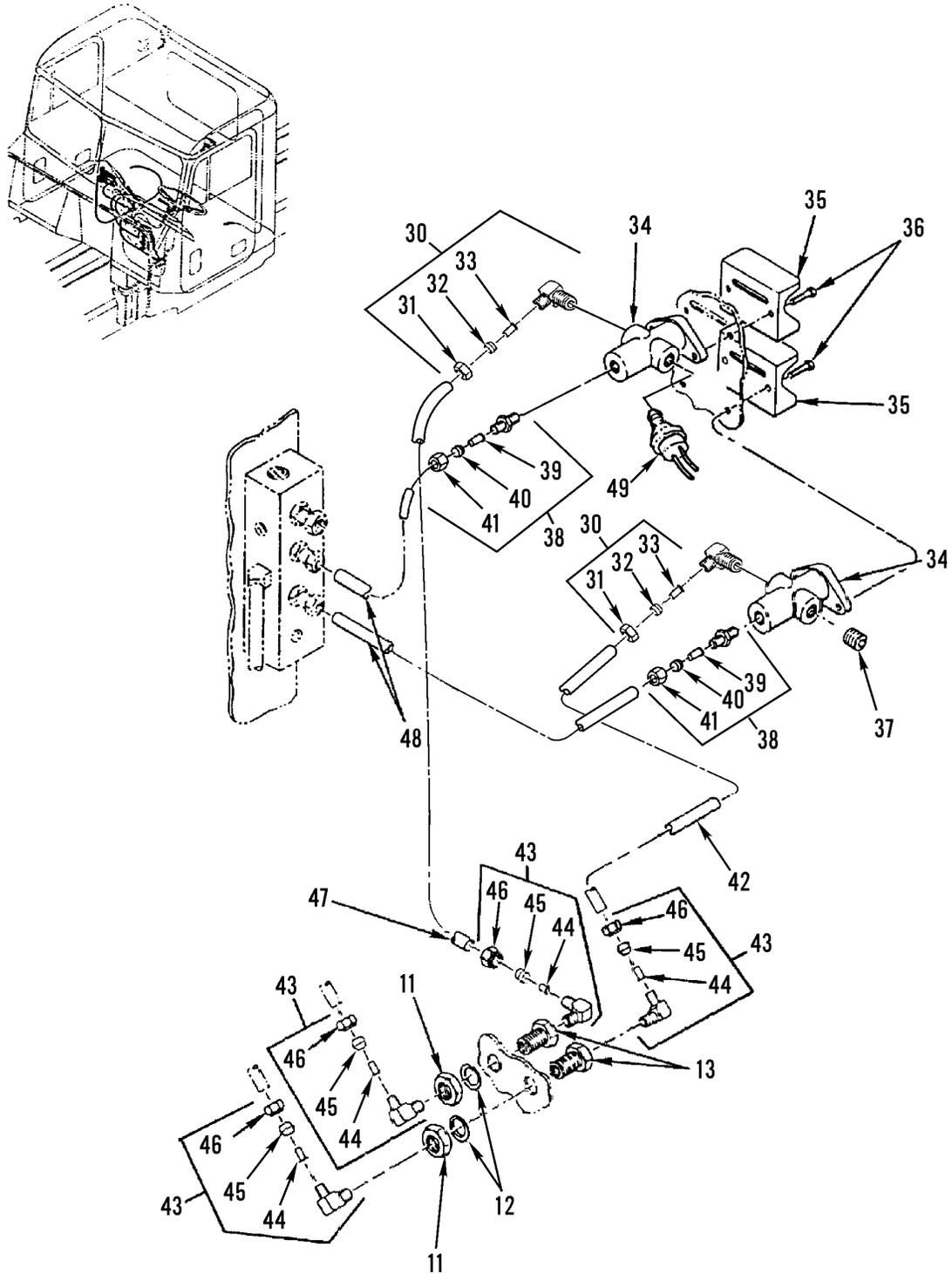

342-1537-3

Figure 150. Air System Valves, Tanks, Lines and Fittings, Part 1 (Sheet 3 of 3)

SECTION II			TM9-2320-302-24P			
(1)	(2)	(3)	(4)	(5)	(6)	(7)
ITEM NO	SMR CODE	NSN	CAGEC	PART NUMBER	DESCRIPTION AND USABLE ON CODES(UOC)	QTY
GROUP 1208 AIRBRAKE SYSTEM						
FIG. 150 AIR SYSTEM VALVES, TANKS LINES AND FITTINGS, PART 1						
1	MOOZZ		64678	12-13367-142	TUBE,NYLON 142" MAKE FROM CAGE 61424,PN PFT-4A BLACKX1300.....	1
2	PAOZZ	5975013335872	04963	805 1INLGGRAY	HANGER,CABLE.....	1
3	PAOZZ	4730010919212	93061	68NTA-4-4	ADAPTER,STRAIGHT,PI.....	2
4	PAOZZ	4730010486968	93061	61NTA-4	.NUT,TUBE COUPLING.....	1
5	PAOZZ	4730010486358	93061	60NTA-4	.SLEEVE,COMPRESSION,.....	1
6	PAOZZ	4730010577109	93061	63NTA-4	.INSERT,TUBE FITTING.....	1
7	PAOZZ	4730012443552	93061	VS269NTA-6-4	ELBOW,PIPE TO TUBE.....	2
8	PAOZZ	4730010564990	93061	63NTA-6	.INSERT,TUBE FITTING.....	1
9	PAOZA	4730010485260	93061	60NTA-6	.SLEEVE,COMPRESSION,.....	1
10	PAOZA	4730010487873	93061	61NTA-6	.NUT,TUBE COUPLING.....	1
11	XDOZZ		64678	23-09254-008	NUT,PALIN,HEXAGON JAM, 3/4-16UNC...	2
12	PAOZZ	5310009391060	96906	MS35333-81	WASHER,LOCK.....	2
13	PAOZZ	4730013325483	93061	2515-00155	ADAPTER BUSHING.....	2
14	PAOZZ	4730002779615	93061	2225P-4	TEE,PIPE.....	2
15	MOOZZ		64678	PFT-6B-BLK-100X3 4	TUBE,NYLON 34" MAKE FROM CAGE 85757,PN 3250-061.....	2
16	PAOZZ	5310008094058	96906	MS27183-10	WASHER,FLAT.....	4
17	PAOZZ	5305013644778	64678	23-10414-125	SCREW,MACHINE.....	4
18	PAOZZ	2530013328475	06853	065187	VALVE,RELAY,AIR PRE.....	1
19	PAOZZ	4730014163262	93061	28-8-4	ADAPTER,STRAIGHT,PI 1/4-18NPTF.....	1
20	XDOZZ		53421	SNP-7HSO	CLAMP,HOSE.....	1
21	PAOZZ	4710013656944	64678	680 429 00 03	TUBE,BENT,METALLIC.....	1
22	PAOZZ	4730013659072	93061	VS279NTA-6-4	ELBOW,PIPE TO TUBE.....	3
23	PAOZZ	4730010564990	93061	63NTA-6	.INSERT,TUBE FITTING.....	1
24	PAOZA	4730010485260	93061	60NTA-6	.SLEEVE,COMPRESSION,.....	1
25	PAOZA	4730010487873	93061	61NTA-6	.NUT,TUBE COUPLING.....	1
26	MOOZZ		64678	PFT-6B-BLK-100X2 5	TUBE,NYLON 25" MAKE FROM CAGE 85757,PN 3250-061.....	1
27	MOOZZ		64678	PFT-6B-BLK-100X3 4	TUBE,NYLON 34" MAKE FROM CAGE 85757, PN 3250-061.....	1
28	XDOZZ		93061	VS2224P-4	TEE,PIPE 1/4 X 1/4 X 1/4 IN.....	1
29	PAOZZ	4730001960930	96906	MS14315-1XA	BUSHING,PIPE 1/4 X 1/8NPT.....	1
30	PAOZZ	4730012440000	93061	VS269NTA-4-2	ELBOW,PIPE TO TUBE.....	2
31	PAOZZ	4730010486968	93061	61NTA-4	.NUT,TUBE COUPLING.....	1
32	PAOZZ	4730010486358	93061	60NTA-4	.SLEEVE,COMPRESSION,.....	1
33	PAOZZ	4730010577109	93061	63NTA-4	.INSERT,TUBE FITTING.....	1
34	PAOZZ	2530013325446	06721	N13440DL	VALVE,BRAKE PNEUMAT.....	2
35	PFOZZ	2590013575444	64678	681 429 12 47	COVER,VEHICULAR COM.....	2
36	PAOZZ	5305014419376	64678	23-12195-075	SCREW,MACHINE 10-24 X 0.75 TORX....	2
37	PAOZZ	4730014413513	93061	VS219P-8	PLUG,PIPE.....	1
38	PAOZZ	4730010554017	93061	VS68NTA-4-2	ADAPTER,STRAIGHT,PI.....	2
39	PAOZZ	4730010577109	93061	63NTA-4	.INSERT,TUBE FITTING.....	1
40	PAOZZ	4730010486358	93061	60NTA-4	.SLEEVE,COMPRESSION,.....	1
41	PAOZZ	4730010486968	93061	61NTA-4	.NUT,TUBE COUPLING.....	1
42	MOOZZ		64678	PFT-4A-BLK-100X4 6	TUBE,NYLON 46" MAKE FROM BULK PN PFT-4A BLACKX1300 (61424).....	1

SECTION II			TM9-2320-302-24P			
(1)	(2)	(3)	(4)	(5)	(6)	(7)
ITEM	SMR			PART		
NO	CODE	NSN	CAGEC	NUMBER	DESCRIPTION AND USABLE ON CODES(UOC)	QTY
43	PFOZZ	4730010864064	93061	269NTA-4-4	ELBOW,PIPE TO TUBE.....	4
44	PAOZZ	4730010577109	93061	63NTA-4	.INSERT,TUBE FITTING.....	1
45	PAOZZ	4730010486358	93061	60NTA-4	.SLEEVE,COMPRESSION,.....	1
46	PAOZZ	4730010486968	93061	61NTA-4	.NUT,TUBE COUPLING.....	1
47	MOOZZ		64678	PFT-4A-REDX60	TUBING,NONMETALLIC 60" MAKE FROM BULK P/N PFT-4A-RED (61424).....	2
48	MOOZZ		64678	PFT-4A-YELX24	TUBING,NONMETALLIC 24" MAKE FROM BULK P/N PFT-4A-YEL (61424).....	2
49	PAOZZ		87823	1749-1121	SWITCH,PRESSURE.....	1

END OF FIGURE

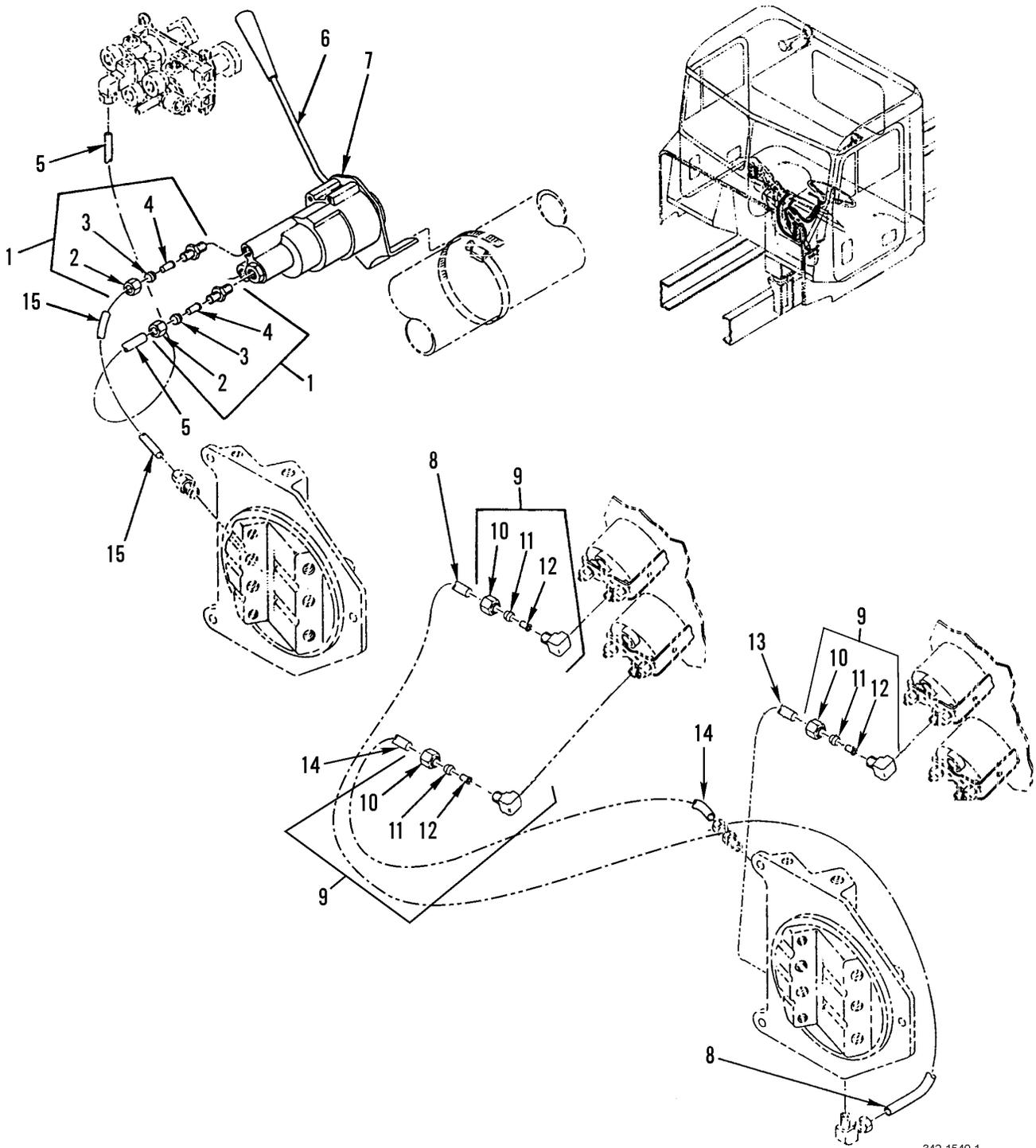

342-1540-1

Figure 151. Air System Valves, Tanks, Lines and Fittings, Part 2 (Sheet 1 of 3)

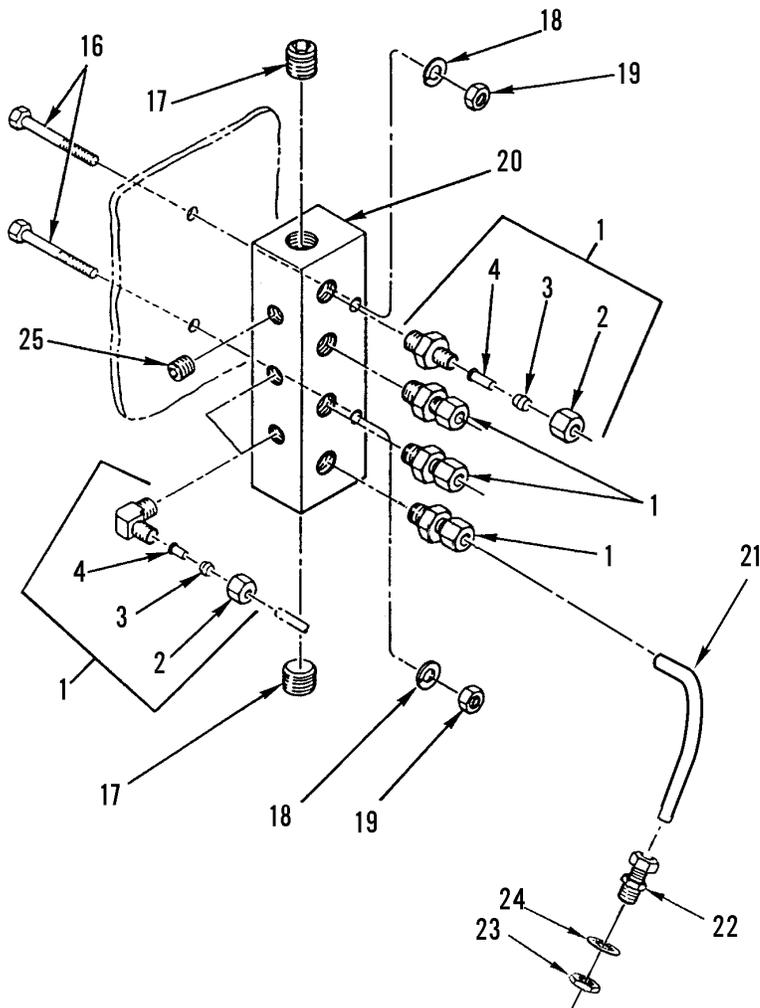
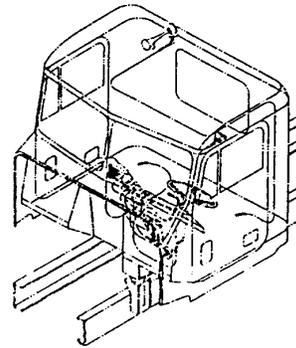

342-1540-2

Figure 151. Air System Valves, Tanks, Lines and Fittings, Part 2 (Sheet 2 of 3)

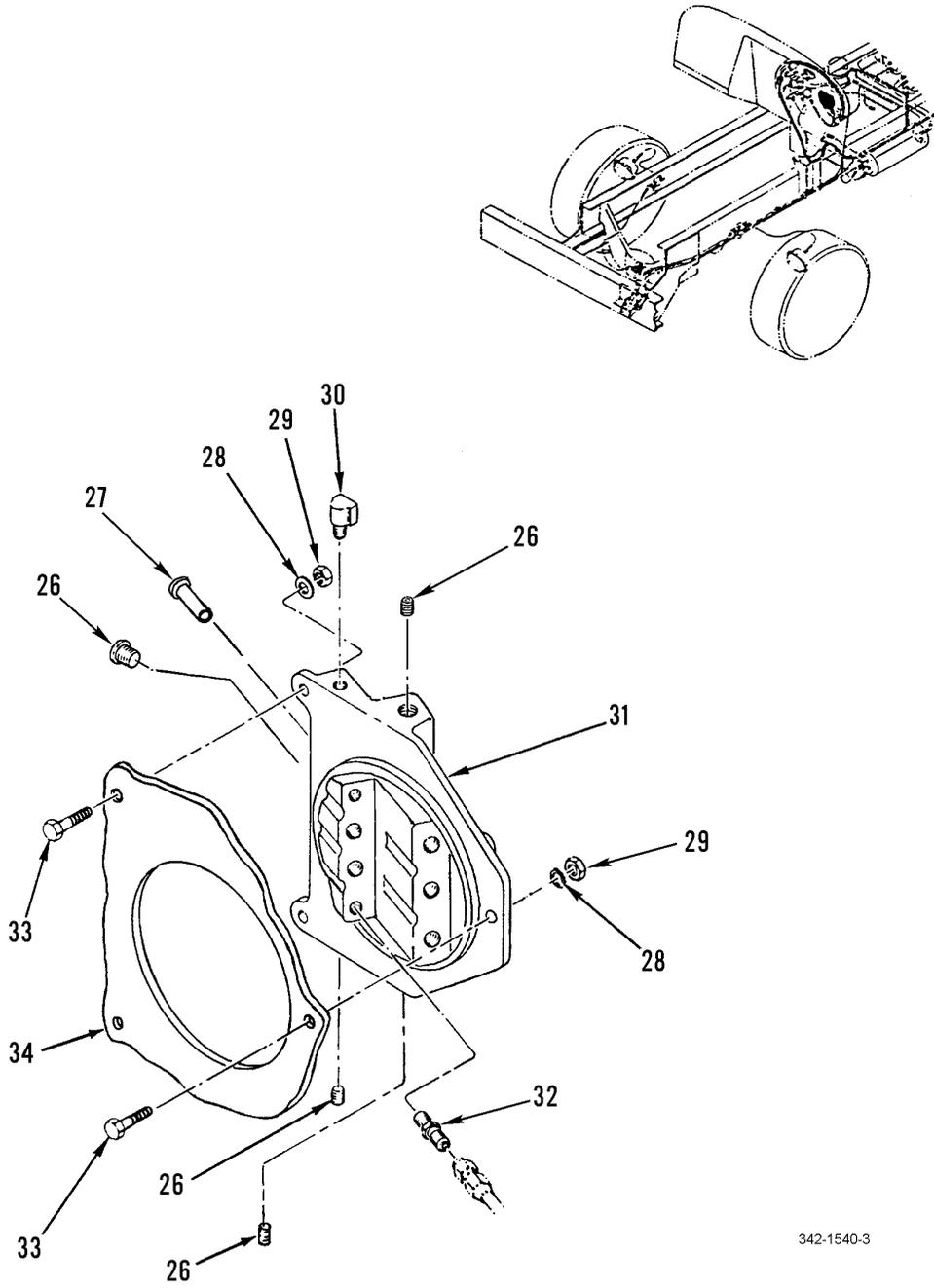

342-1540-3

Figure 151. Air System Valves, Tanks, Lines and Fittings, Part 2 (Sheet 3 of 3)

SECTION II			TM9-2320-302-24P			
(1)	(2)	(3)	(4)	(5)	(6)	(7)
ITEM	SMR			PART		
NO	CODE	NSN	CAGEC	NUMBER	DESCRIPTION AND USABLE ON CODES(UOC)	QTY
GROUP 1208 AIRBRAKE SYSTEM						
FIG. 151 AIR SYSTEM VALVES, TANKS, LINES AND FITTINGS, PART 2						
1	PAOZZ	4730010622570	93061	68NTA-6-4	ADAPTER, STRAIGHT, PI.....	8
2	PAOZA	4730010487873	93061	61NTA-6	.NUT, TUBE COUPLING.....	1
3	PAOZA	4730010485260	93061	60NTA-6	.SLEEVE, COMPRESSION,.....	1
4	PAOZZ	4730010564990	93061	63NTA-6	.INSERT, TUBE FITTING.....	1
5	MOOZZ		93061	PFT-6B-BLK100X54	TUBE, NYLON, BRAKE 54" MAKE FROM BULK P/N PFT-6B-BLK-100 (61424).....	1
6	PAOZZ	3040013156720	06721	102461-K	LEVER, MANUAL CONTRO.....	1
7	PAOZZ	2530013318709	06721	N30103BN	VALVE, BRAKE PNEUMAT.....	1
8	MOOZZ		64678	12-13371-037	TUBE, NYLON MAKE FROM CAGE 61424, PN PFT-4A BLACKX1300, 37 IN.....	1
9	PAOZZ	4730011131791	93061	270NTA-4-2	ELBOW, PIPE TO TUBE.....	3
10	PAOZZ	4730010486968	93061	61NTA-4	.NUT, TUBE COUPLING.....	1
11	PAOZZ	4730010486358	93061	60NTA-4	.SLEEVE, COMPRESSION,.....	1
12	PAOZZ	4730010577109	93061	63NTA-4	.INSERT, TUBE FITTING.....	1
13	MOOZZ		64678	PFT4A-BRNX064	TUBING, NONMETALLIC 64 IN. MAKE FROM CAGE 87373 P/N PFT-4A-BRN.....	1
14	MOOZZ		64678	12-13370-037	TUBE, NYLON MAKE FROM CAGE 61424, PN PFT-4A BLACKX1300, 37 IN.....	1
15	MOOZZ		93061	PFT-6B-BLK100X42	TUBE, NYLON, BRAKE 42" MAKE FROM BULK PN PFT-6B-BLK-100 (61424).....	1
16	PAOZZ	5305000712511	80204	B1821BH025C200N	SCREW, CAP, HEXAGON H 1/4-20UNC-2A X 2.000.....	2
17	PAOZZ	4730012441265	93061	VS219P-6	PLUG, PIPE.....	2
18	PAOZZ	5310005825965	96906	MS35338-44	WASHER, LOCK 1/4".....	2
19	PAOZZ	5310013336436	64678	23-10340-125	NUT, SELF-LOCKING, AS 1/4-20.....	4
20	PFOZZ	4730013322465	64678	12-10945-000	MANIFOLD, HYDRAULIC.....	1
21	MOOZZ		64678	PFT-6B-YELX60	TUBE, NYLON 60" MAKE FROM BULK P/N PFT-68-YEL (61424).....	1
22	PAOZZ	4730013325483	93061	2515-00155	ADAPTER BUSHING.....	1
23	XDOZZ		64678	23-09254-008	NUT, PALIN, HEXAGON 3/4"-16, UNF.....	1
24	PAOZZ	5310009391060	96906	MS35333-81	WASHER, LOCK 3/4".....	1
25	PAOZZ		93061	639PMT4	PLUG, LEAK PROOF SEA 1/4".....	3
26	PAOZZ	4730013326000	93061	VS219P-2	.PLUG, PIPE.....	4
27	PAOZZ		93061	639PM532	.PLUG, LEAK PROOF SEA.....	1
28	PAOZZ	5310005825965	96906	MS35338-44	WASHER, LOCK 1/4".....	3
29	PAOZZ	5310013336436	64678	23-10340-125	NUT, SELF-LOCKING, AS.....	3
30	PAOZZ	4730012849065	98441	VS2202P4-2	ELBOW, PIPE.....	1
31	XDOOO		64678	A12-17593-001	MANIFOLD, AIRLINE AIR/OIL BLOCK.....	1
32	PAOZZ	4730009003296	07295	100740	.ADAPTER, STRAIGHT, PI.....	1
33	PAOZZ	5305002253843	96906	MS90728=8	SCREW, CAP, HEXAGON H.....	3
34	PAOZA	5330014420443	64678	12-11596-000	GASKET.....	1

END OF FIGURE

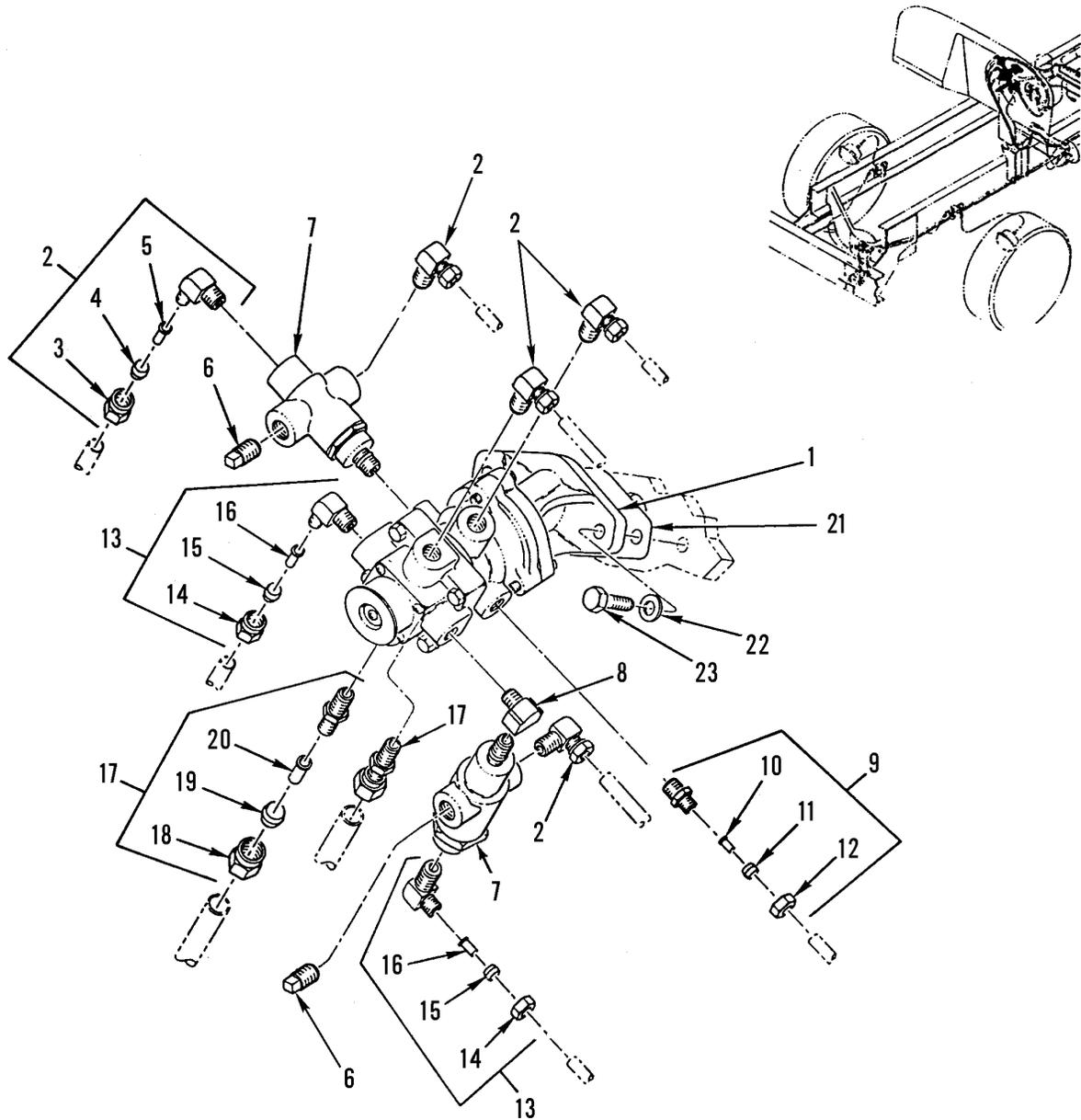
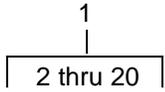

342-1541-1

Figure 152. Air System Valves, Tanks, Lines and Fittings, Part 3 (Sheet 1 of 2)

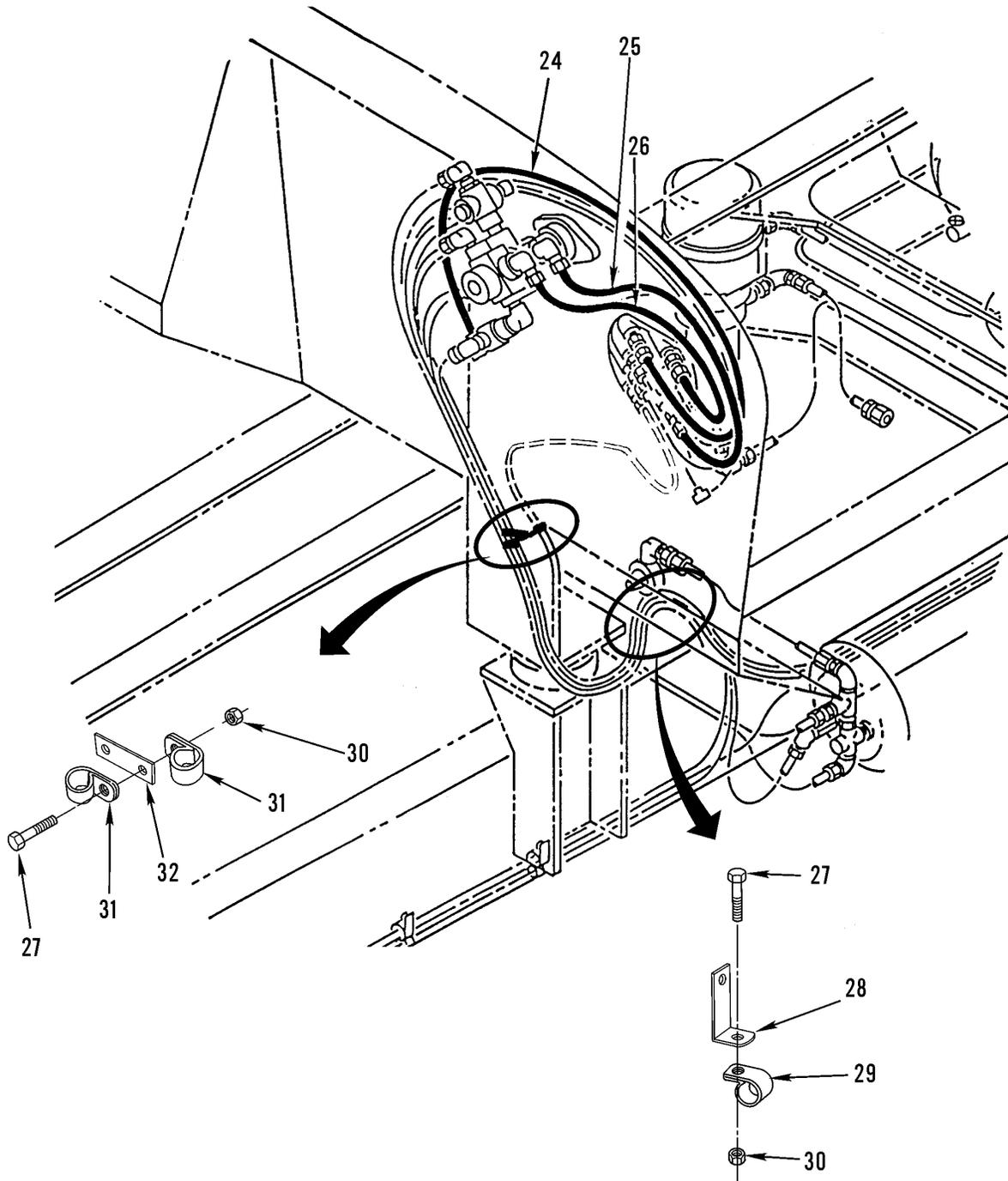

32-1541-2

Figure 152. Air System Valves, Tanks, Lines and Fittings, Part 3 (Sheet 2 of 2)

SECTION II			TM9-2320-302-24P			
(1)	(2)	(3)	(4)	(5)	(6)	(7)
ITEM	SMR			PART		
NO	CODE	NSN	CAGEC	NUMBER	DESCRIPTION AND USABLE ON CODES(UOC)	QTY
GROUP 1208 AIRBRAKE SYSTEM						
FIG. 152 AIR SYSTEM VALVES, TANKS, LINES AND FITTINGS, PART 3						
1	PAOFF	2530013321587	64678	A12-13004-000	VALVE,BRAKE PNEUMAT SEE FIGURE 159 FOR BREAKDOWN.....	1
2	PAOZZ	4730012441226	93061	VS269NTA-6-6	.ELBOW,PIPE TO TUBE.....	5
3	PAOZA	4730010487873	93061	61NTA-6	..NUT,TUBE COUPLING.....	1
4	PAOZA	4730010485260	93061	60NTA-6	..SLEEVE,COMPRESSION,.....	1
5	PAOZZ	4730010564990	93061	63NTA-6	..INSERT,TUBE FITTING.....	2
6	PAOZZ	4730013325999	93061	VS211P-6	.PLUG,PIPE.....	2
7	PAOZZ	2530013321586	06721	N20966R	.VALVE,BRAKE PNEUMAT.....	2
8	PAOZZ	4730002784822	93061	2202P-6-6	.ELBOW,PIPE.....	1
9	PAOZZ	4730010918032	93061	68NTA-8-6	.ADAPTER,STRAIGHT,PI.....	1
10	PAOZZ	4730010564990	93061	63NTA-6	..INSERT,TUBE FITTING.....	1
11	PAOZA	4730010485260	93061	60NTA-6	..SLEEVE,COMPRESSION,.....	1
12	PAOZA	4730010487873	93061	61NTA-6	..NUT,TUBE COUPLING.....	1
13	PAOZZ	4730012441227	93061	VS269NTA-8-6	.ELBOW,PIPE TO TUBE.....	2
14	PAOZZ	4730010487874	93061	61NTA-8	..NUT,TUBE COUPLING.....	1
15	PAOZZ	4730010491559	93061	60NTA-8	..SLEEVE,COMPRESSION,.....	1
16	PAOZA	4730010485261	93061	63NTA-8	..INSERT,TUBE FITTING.....	1
17	PAOZZ	4730010828799	93061	68NTA-10-6	.ADAPTER,STRAIGHT,PI.....	2
18	PAOZZ	4730013714370	93061	61NTA-10	..NUT,TUBE COUPLING.....	1
19	PAOZZ	4730004268180	93061	60NTA-10	..SLEEVE,COMPRESSION,.....	1
20	PAOZZ	4730013559204	93061	63NTA-10	..INSERT,TUBE FITTING.....	1
21	PAOZZ		64678	12-15695-000	GASKET.....	1
22	PAOZZ	5310000806004	96906	MS27183-14	WASHER,FLAT .406 ID X .812 OD X .065 THK.....	2
23	PAOZZ	5305000680511	80204	B1821BH038C125N	SCREW,CAP,HEXAGON H 3/8-16 1.25....	2
24	MOOZZ		64678	PFT-8B-REDX60	TUBE,NYLON REINF 60" MAKE FROM BULK P/N 48-00101-022 (61424).....	2
25	MOOZZ		93061	PFT-6B-REDX36	TUBE,NYLON 36" MAKE FROM BULK P/N PFT-6B-RED (61424).....	1
26	MOOZZ		64678	PFT-6B-GRNX36	TUBING,NONMETALLIC 36" MAKE FROM BULK P/N PFT-6B-GRN (61424).....	1
27	PAOZZ	5305000680509	80204	B1821BH025C125N	SCREW,CAP,HEXAGON H 1/4-20 X 1.25..	2
28	PAOZZ	5340013284371	64678	23-09130-002	BRACKET,ANGLE .281 X .281.....	1
29	PFOZZ		64678	23-09528-086	CLAMP,LOOP 1.750 ID.....	1
30	PAOZZ	5310013336436	64678	23-10340-125	NUT,SELF-LOCKING,AS 1/4-20.....	4
31	PAOZZ	5340013394266	64678	23-11358-024	CLAMP,LOOP 2 LINE, 7/8".....	2
32	PAOZZ	5365012458802	64678	23-09130-003	SPACER,PLATE .531 X .281.....	1

END OF FIGURE

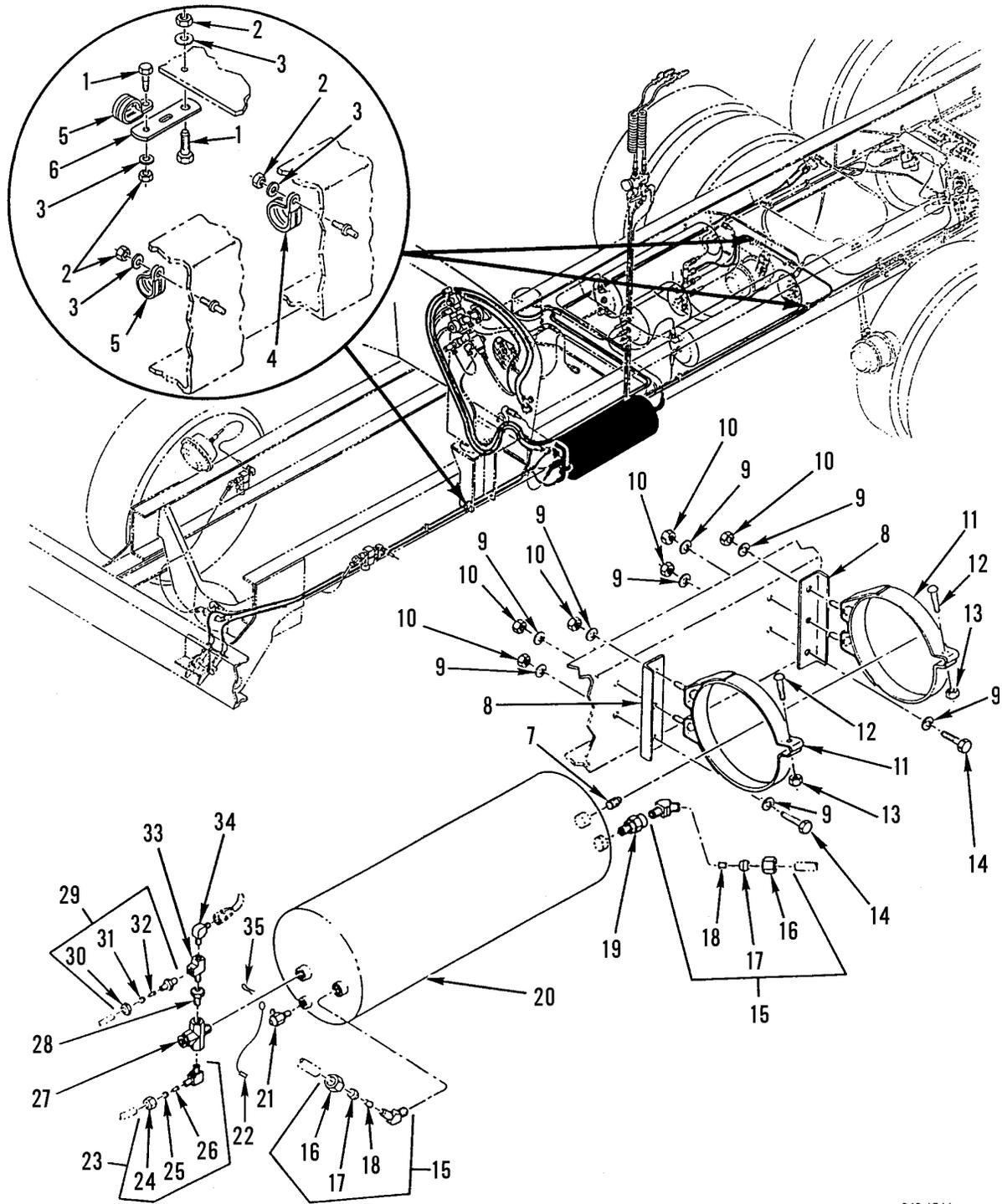

342-1544

Figure 153. Air System Valves, Tanks, Lines and Fittings, Part 4

SECTION II			TM9-2320-302-24P			
(1)	(2)	(3)	(4)	(5)	(6)	(7)
ITEM	SMR			PART		
NO	CODE	NSN	CAGEC	NUMBER	DESCRIPTION AND USABLE ON CODES(UOC)	QTY
GROUP 1208 AIRBRAKE SYSTEM						
FIG. 153 AIR SYSTEM VALVES, TANKS, LINES AND FITTINGS, PART 4						
1	PAOZZ	5305002253843	80204	B1821BH025C100N	SCREW,CAP,HEXAGON H.....	4
2	PAOZZ	5310000881251	81349	M45913/1-4CG5C	NUT,SELF LOCKING,HE.....	9
3	PAOZZ	5310008094058	96906	MS27183-10	WASHER,FLAT.....	10
4	PAOZZ	5340013327473	18076	S463-G23	CLAMP,LOOP.....	3
5	PAOZZ	5340013342880	18076	S630-G14	CLAMP,LOOP.....	3
6	PAOZZ	5340013284367	64678	23-09130-000	BRACKET,ANGLE 4 IN.....	1
7	PAOZZ	4730000113176	81343	8 130109AB	PLUG,PIPE.....	1
8	XDOZZ	5340013555412	64678	12-13299-000	BRACKET,ANGLE.....	2
9	PAOZZ	5310007737618	96906	MS15795-814	WASHER,FLAT.....	8
10	PAOZZ	5310000874652	96906	MS51922-17	NUT,SELF-LOCKING,HE 3/8-16UNC.....	6
11	PFOZZ	5340013338208	64678	A12-13688-000	CLAMP,LOOP.....	2
12	PAOZZ	5306008162441	96906	MS35751-71	.BOLT,SQUARE NECK.....	2
13	PAOZZ	5310000874652	96906	MS51922-17	.NUT,SELF-LOCKING,HE 3/8-16UNC.....	2
14	PAOZZ	5305007252317	80204	B1821BH038C150N	SCREW,CAP,HEXAGON H 3/8-16 X 1.5...	2
15	PAOZZ	4730010960574	81343	10-8-100302BA	ELBOW,PIPE TO TUBE.....	2
16	PAOZZ	4730013714370	93061	61NTA-10	.NUT,TUBE COUPLING.....	1
17	PAOZZ	4730004268180	93061	60NTA-10	.SLEEVE,COMPRESSION,.....	1
18	PAOZZ	4730013559204	93061	63NTA-10	.INSERT,TUBE FITTING.....	1
19	PAOZZ	4820007748299	06853	800372	VALVE,CHECK.....	1
20	PAOZZ	2530013330748	64678	A12-11924-001	TANK,PRESSURE.....	1
21	PAOZZ	4820013330095	64678	35000	COCK,DRAIN.....	1
22	XDOZZ		64678	A12-14544-024	CABLE ASSEMBLY.....	1
23	PAOZZ	4730013104665	93061	VS269NTA-8-8	ELBOW,PIPE TO TUBE.....	1
24	PAOZZ	4730010487874	93061	61NTA-8	.NUT,TUBE COUPLING.....	1
25	PAOZZ	4730010491559	93061	60NTA-8	.SLEEVE,COMPRESSION,.....	1
26	PAOZA	4730010485261	93061	63NTA-8	.INSERT,TUBE FITTING.....	1
27	PAOZZ	4820013330732	78528	223-455	VALVE,REGULATING,SY.....	1
28	PAOZZ	4730014590000	93061	209P-8-6	ADAPTER,STRAIGHT,TU.....	1
29	PAOZZ	4730010919212	93061	68NTA-4-4	ADAPTER,STRAIGHT,PI.....	2
30	PAOZZ	4730010486968	93061	61NTA-4	.NUT,TUBE COUPLING.....	1
31	PAOZZ	4730010486358	93061	60NTA-4	.SLEEVE,COMPRESSION,.....	1
32	PAOZZ	4730010577109	93061	63NTA-4	.INSERT,TUBE FITTING.....	1
33	PAOZZ	4730002779615	93061	2225P-4	TEE,PIPE.....	2
34	PAOZZ	4730013322432	93061	VS249F4-4	ELBOW,PIPE TO BOSS.....	1
35	PAOZZ	5315002341624	96906	MS24665-326	PIN,COTTER 3/32 DIA X 2.0 LG.....	1

END OF FIGURE

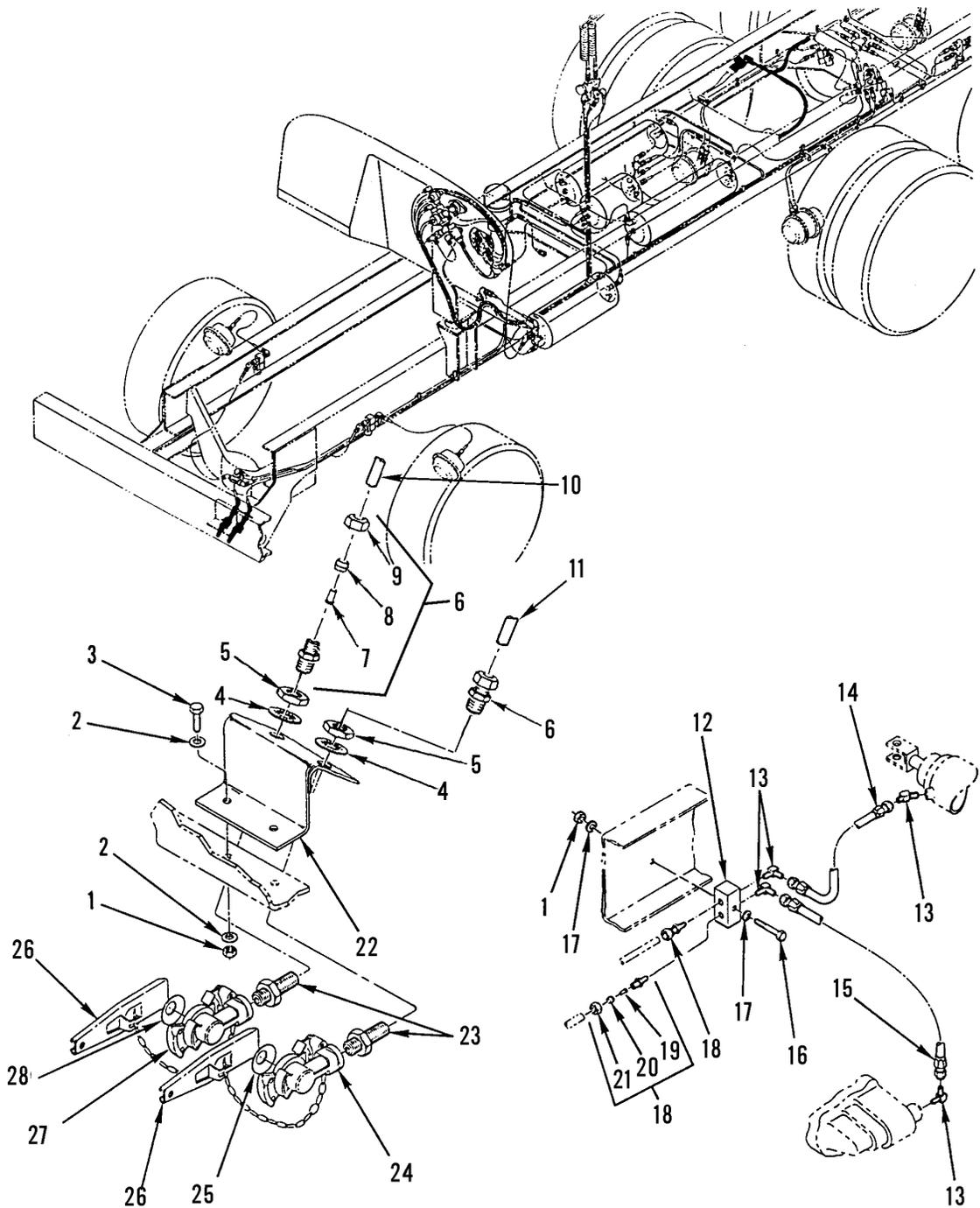

342-1548-1

Figure 154. Air System Valves, Tanks, Lines and Fittings, Part 5 (Sheet 1 of 2)

SECTION II			TM9-2320-302-24P			
(1)	(2)	(3)	(4)	(5)	(6)	(7)
ITEM NO	SMR CODE	NSN	CAGEC	PART NUMBER	DESCRIPTION AND USABLE ON CODES(UOC)	QTY
GROUP 1208 AIRBRAKE SYSTEM						
FIG. 154 AIR SYSTEM VALVES, TANKS, LINES AND FITTINGS, PART 5						
1	PAOZZ	5310000874652	81349	M45913/1-6CG5C	NUT,SELF-LOCKING,HE 3/8-16UNC.....	2
2	PAOZZ	5310000806004	96906	MS27183-14	WASHER,FLAT .406 ID X .812 OD X .065 THK.....	4
3	PAOZZ	5305002693211	96906	MS90725-60	SCREW,CAP,HEXAGON H 3/8-16 X 1.00..	2
4	PAOZZ	5310005826714	96906	MS35333-49	WASHER,LOCK 1.060 MAX. ID X 1.637 MAX. OD.....	2
5	PAOZZ	5310003251900	80205	NAS1021N17	NUT,SELF-LOCKING,HE 1-14NF.....	2
6	PAOZZ	4730010969128	93061	68NTA-6-6	ADAPTER,STRAIGHT,PI.....	2
7	PAOZZ	4730010564990	93061	63NTA-6	.INSERT,TUBE FITTING.....	1
8	PAOZZ	4730010485260	93061	60NTA-6	.SLEEVE,COMPRESSION.....	1
9	PAOZZ	4730010487873	93061	61NTA-6	.NUT,TUBE COUPLING.....	1
10	MOOZZ		64678	48-00101-010X144	HOSE 144" MAKE FROM BULK P/N PFT-6B-BLK-100 (61424).....	1
11	MOOZZ		64678	48-00101-015X96	TUBING,NONMETALLIC 96" MAKE FROM BULK P/N PFT-6B-BLK-100 (61424).....	1
12	PAOZZ	4730013326117	64678	12-9287-001	MANIFOLD,AIR LINE.....	1
13	PAOZZ	4730013322432	93061	VS249F4-4	ELBOW,PIPE TO BOSS.....	4
14	PAOZZ	4720013325963	98441	M2130808-4-4-4-2 9.00	HOSE ASSEMBLY,NONME.....	1
15	MOOZZ		64678	48-00100-019X102	TUBE,NONMETALLIC 102" MAKE FROM BULK P/N PFT-4A-BLACKX1300 (61424)..	2
16	PAOZZ	5305000712511	80204	B1821BH025C200N	SCREW,CAP,HEXAGON H 1/4-20 X 2.00..	1
17	PAOZZ	53100008094058	96906	MS27183-10	WASHER,FLAT.....	6
18	PAOZZ	4730010919212	93061	68NTA-4-4	ADAPTER,STRAIGHT,PI.....	2
19	PAOZZ	4730010577109	93061	63NTA-4	.INSERT,TUBE FITTING.....	1
20	PAOZZ	4730010486358	93061	60NTA-4	.SLEEVE,COMPRESSION.....	1
21	PAOZZ	4730010486968	93061	61NTA-4	.NUT,TUBE COUPLING.....	1
22	PFOZZ	5340013326590	64678	12-13608-000	BRACKET,DOUBLE ANGL.....	1
23	XDOZZ	2590007780324	58429	N11246	TRAILER COUPLING,TE.....	2
24	PAOOZ	5342013367391	64466	12-006	COUPLING,CLAMP,GROO.....	1
25	PAOZZ	5330000902128	06853	213630	.PACKING,PREFORMED.....	1
26	PAOZZ	2530001379235	14892	220635	DUMMY COUPLING,AUTO.....	2
27	PAOOZ	4730012445365	64466	12008	COUPLING HALF,QUICK.....	1
28	PAOZZ	5330000902128	06853	213630	.PACKING,PREFORMED.....	1
29	PAOZZ	5305000712507	80204	B1821BH025C044N	SCREW,CAP,HEXAGON H 1/4-20 X 0.50..	3
30	PAOZZ	5340014411668	64678	23-11358-039	CLAMP,LOOP 2 LINES.....	1
31	PAOZZ	5340013319466	64678	06-09782-000	BRACKET,ANGLE.....	1
32	PAOZZ	5340013327473	18076	S463-G23	CLAMP,LOOP.....	2
33	PAOZZ	5310000881251	81349	M45913/1-4CG5C	NUT,SELF LOCKING,HE.....	3
34	PAOZZ	5340013284367	64678	23-09130-000	BRACKET,ANGLE 4 IN.....	1
35	PAOZZ	5340013334614	18076	S463-G26	CLAMP,LOOP.....	1
36	PAOZZ		64678	A23-12346-064	HOSE ASSEMBLY,NONME.....	2
37	PAOZZ		64678	A23-12248-040	HOSE ASSEMBLY,NONME #6 CRIMP.....	2
38	MOOZZ		64678	48-00101-010X84	TUBE,NONMETALLIC 84" MAKE FROM BULK P/N PFT-6B-BLK-100 (61424).....	1
39	MOOZZ		64678	48-00101-010X180	HOSE 180" MAKE FROM BULK P/N PFT-6B-BLK-100 (61424).....	1

SECTION II			TM9-2320-302-24P			
(1)	(2)	(3)	(4)	(5)	(6)	(7)
ITEM	SMR			PART		
NO	CODE	NSN	CAGEC	NUMBER	DESCRIPTION AND USABLE ON CODES(UOC)	QTY
40	MOOZZ		64678	48-00101-015X180	TUBE,NYLON REINF 180" MAKE FROM BULK P/N PFT-6B-BLK-100 (61424).....	1
41	PAOZZ	4730012443552	93061	VS269NTA-6-4	ELBOW,PIPE TO TUBE.....	2
42	PAOZA	4730010487873	93061	61NTA-6	.NUT,TUBE COUPLING.....	1
43	PAOZA	4730010485260	93061	60NTA-6	.SLEEVE,COMPRESSION,.....	1
44	PAOZZ	4730010564990	93061	63NTA-6	.INSERT,TUBE FITTING.....	1
45	PAOZZ	4730011589201	93061	159F-6-6	ELBOW,PIPE TO TUBE.....	2
46	PAOZZ	4730004697797	93061	2225P6	TEE,PIPE.....	2
47	PAOZZ	4730004391722	79470	48X6X6	ADAPTER,STRAIGHT,PI.....	2
48	PAOZZ	4820010951697	06853	289714	VALVE,FLOW CONTROL 0-1 PSI.....	1
49	PAOZZ	5306002264827	80204	B1821BH031C100N	BOLT,MACHINE 16-18 X 1 GR8 PO.....	2
50	PFOZZ		64678	12-15604-000	HEAT SHIELD,EXHAUST.....	1

END OF FIGURE

14
|
15 thru 17

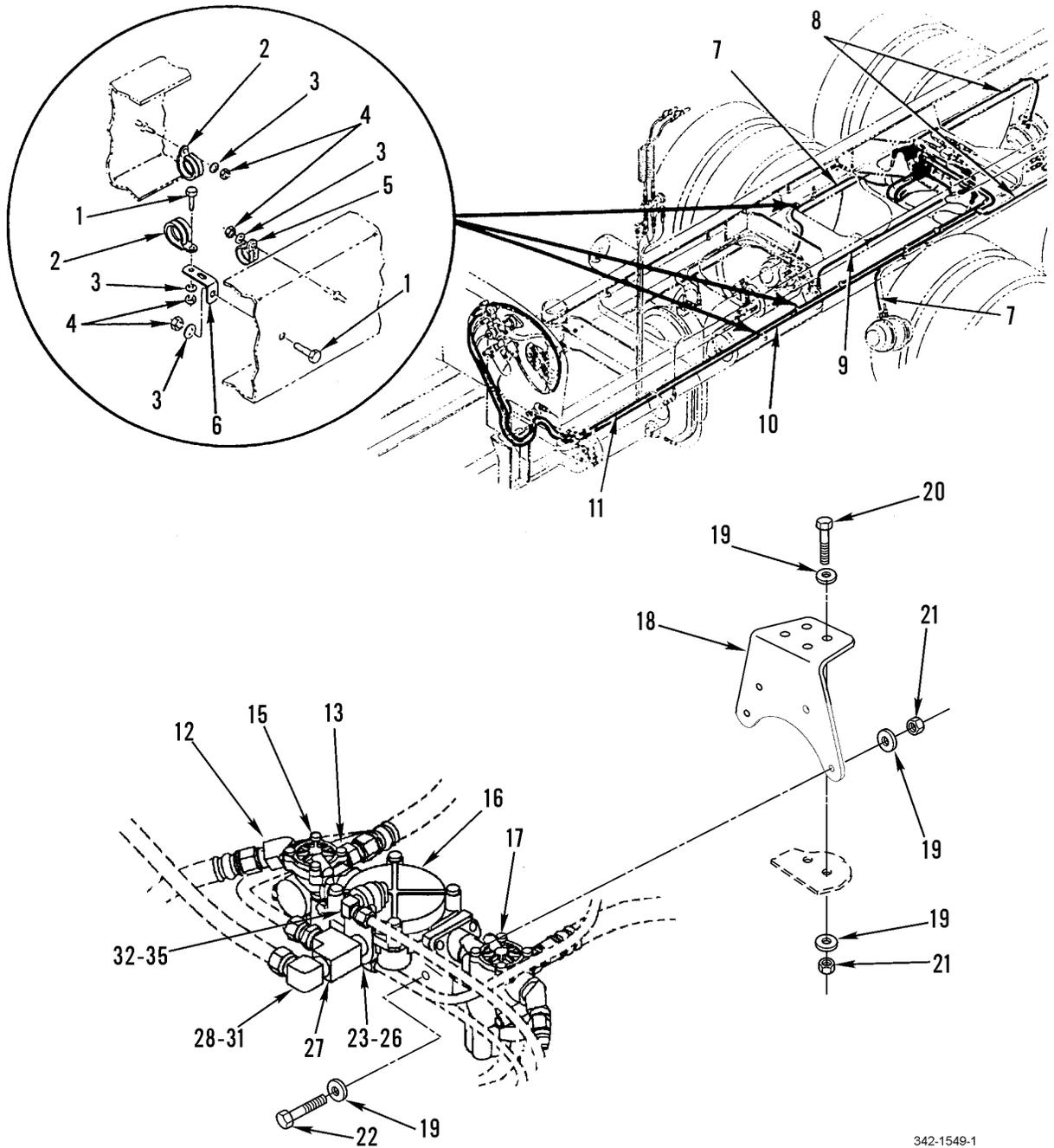

342-1549-1

Figure 155. Air System Valves, Tanks, Lines and Fittings, Part 6 (Sheet 1 of 2)

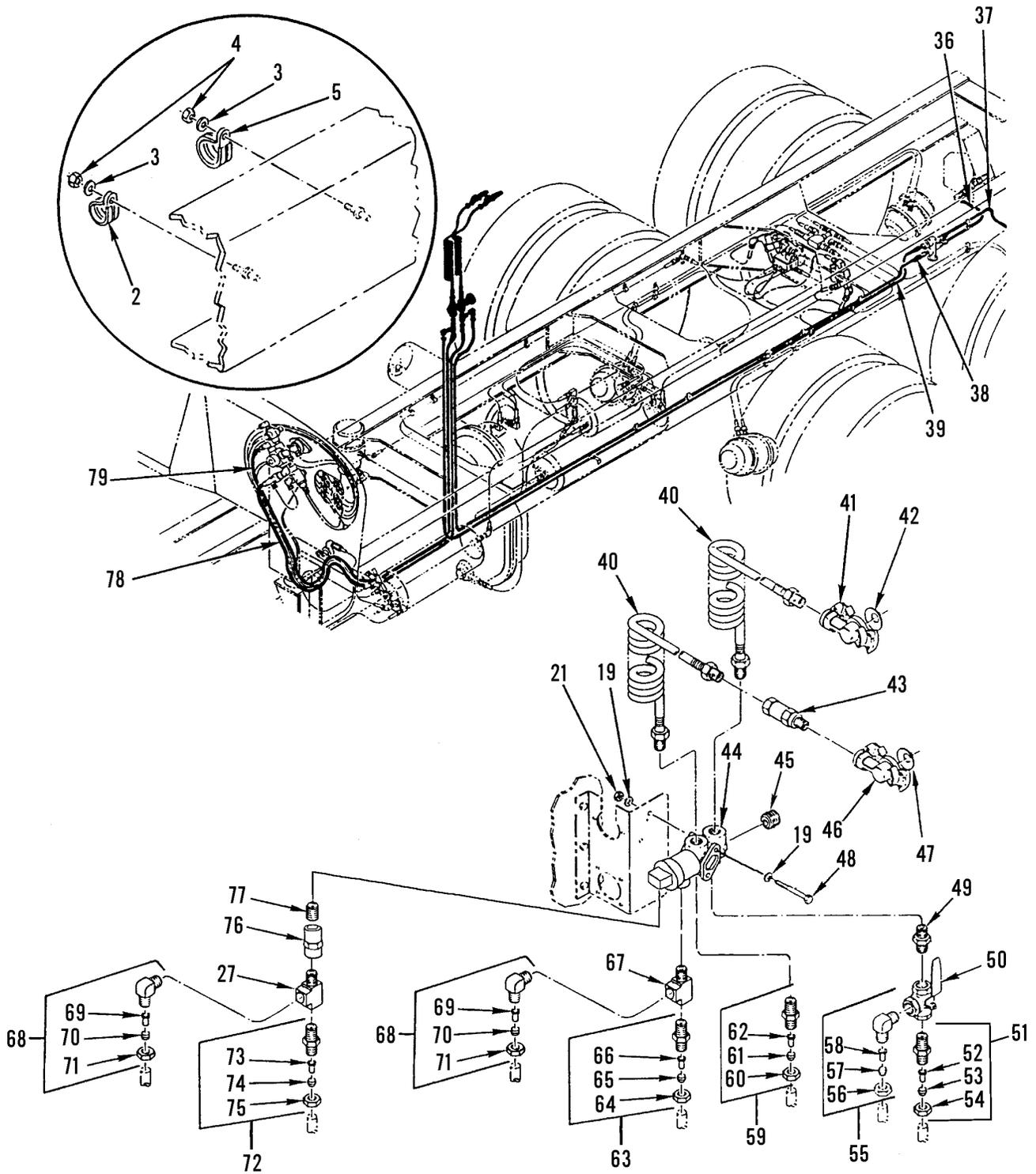

342-1549-2

Figure 155. Air System Valves, Tanks, Lines and Fittings, Part 6 (Sheet 2 of 2)

SECTION II			TM9-2320-302-24P			
(1)	(2)	(3)	(4)	(5)	(6)	(7)
ITEM	SMR			PART		
NO	CODE	NSN	CAGEC	NUMBER	DESCRIPTION AND USABLE ON CODES(UOC)	QTY
GROUP 1208 AIRBRAKE SYSTEM						
FIG. 155 AIR SYSTEM VALVES, TANKS, LINES AND FITTINGS, PART 6						
1	PAOZZ	5305002253843	80204	B1821BH025C100N	SCREW,CAP,HEXAGON H.....	2
2	PAOZZ	5340013327473	18076	S463-G23	CLAMP,LOOP.....	3
3	PAOZZ	5310008094058	96906	MS27183-10	WASHER,FLAT.....	14
4	PAOZZ	5310000881251	81349	M45913/1-4CG5C	NUT,SELF LOCKING,HE.....	10
5	PAOZZ	5340013342880	18076	S630-G14	CLAMP,LOOP.....	3
6	PAOZZ	5340013284367	64678	23-09130-000	BRACKET,ANGLE 4 IN.....	1
7	PAOZZ	4720014435051	64678	A23-02235-060	HOSE ASSEMBLY,NONME.....	1
8	PAOZZ	4720014435051	64678	A23-02235-060	HOSE ASSEMBLY,NONME WIRE BRAID, NO. 10.....	1
9	MOOZZ		64678	48-00101-035X180	TUBE,NYLON REINF 5/8 OD X 180 IN. MAKE FROM BULK PN 3250-1010, CAGE 85757.....	1
10	MOOZZ		64678	48-00101-015X180	TUBE,NYLON REINF 3/8 OD X 180 IN. MAKE FROM BULK PN PFT-6B-BLK-100, CAGE 61424.....	1
11	MOOZZ		64678	PFT-6B-BLK-100X1 59	TUBE,NYLON 159" MAKE FROM BULK PN 3250-061 (85757).....	1
12	PAOZA	4730010940941	93061	159F-10-8	ELBOW,PIPE TO TUBE.....	2
13	XDOZZ	4730013477337	93061	VS48F10-8	ADAPTER,STRAIGHT,PI.....	2
14	PAOZZ	4810014813229	78500	S4725004230	VALVE ASSEMBLY ABS COMBO.....	1
15	PFOZZ		78500	S4721950770	.VALVE,SOLENOID INCLUDES MOUNTING HARDWARE	1
16	PFOZZ		78500	973 011 022 0	.VALVE,RELAY,AIR PRE INCLUDES MOUNTING HARDWARE.....	1
17	PFOZZ		78500	S4721950760	.VALVE,SOLENOID INCLUDES MOUNTING HARDWARE.....	1
18	XDOZZ		64678	12-15218-001	BRACKET,ANGLE.....	1
19	PAOZZ	5310000814219	96906	MS27183-12	WASHER,FLAT 5/16 IN.....	8
20	PAOZZ	5306002264837	80204	B1821BH031C300N	BOLT,MACHINE 5/16-18 X 3.00.....	2
21	PAOZZ	5310009133366	96906	MS51922-11	NUT,SELF-LOCKING,HE.....	2
22	PAOZZ	5306011581154	80204	B1821BH031C275D	BOLT,MACHINE 5/16-12 UNC X 2.50....	2
23	PAOZZ	4730012441226	93061	VS269NTA-6-6	ELBOW,PIPE TO TUBE.....	1
24	PAOZZ	4730010564990	93061	63NTA-6	.INSERT,TUBE FITTING.....	1
25	PAOZA	4730010485260	93061	60NTA-6	.SLEEVE,COMPRESSION,.....	1
26	PAOZA	4730010487873	93061	61NTA-6	.NUT,TUBE COUPLING.....	1
27	PAOZZ	4730004697797	93061	2225P-6	TEE,PIPE.....	2
28	PAOZZ	4730011024123	93061	269NTA-10-8	ELBOW,PIPE TO TUBE.....	1
29	PAOZA	4730010487873	93061	61NTA-6	.NUT,TUBE COUPLING.....	1
30	PAOZA	4730010485260	93061	60NTA-6	.SLEEVE,COMPRESSION,.....	1
31	PAOZZ	4730010564990	93061	63NTA-6	.INSERT,TUBE FITTING.....	1
32	PAOZZ	4730012443552	93061	VS269NTA-6-4	ELBOW,PIPE TO TUBE.....	1
33	PAOZZ	4730010564990	93061	63NTA-6	.INSERT,TUBE FITTING.....	1
34	PAOZA	4730010485260	93061	60NTA-6	.SLEEVE,COMPRESSION,.....	1
35	PAOZA	4730010487873	93061	61NTA-6	.NUT,TUBE COUPLING.....	1
36	MOOZZ		64678	PFT-8B-BLXX120	TUBING,NONMETALLIC 120" MAKE FROM BULK P/N C608-100BLK (13174).....	1
37	MOOZZ		64678	PFT-6B-ORGX120	TUBING,NONMETALLIC 120" MAKE FROM	1

SECTION II			TM9-2320-302-24P			
(1)	(2)	(3)	(4)	(5)	(6)	(7)
ITEM NO	SMR CODE	NSN	CAGEC	PART NUMBER	DESCRIPTION AND USABLE ON CODES(UOC)	QTY
38	MOOZZ		64678	PFT-8B-BLK-100X100	BULK P/N PFTT-6B-ORG (98441)..... TUBE,NYLON MAKE FROM CAGE 13174,P/ N 3250-061, 51 IN.....	1
39	MOOZZ		87373	PFT10BGRN100X120	TUBE-NYLON REINFORC 5/8-120 IN. MAKE FROM BULK P/N C608-100BLK, (13174).....	12
40	PAOZZ	4720014786032	61424	731516	HOSE ASSEMBLY,NOME SET INCLUDES 1 RED AND 1 BLUE HOSE.....	1
41	PAOOZ	4730012445365	64466	12008	COUPLING HALF,QUICK.....	1
42	PAOZZ	5330000902128	06853	213630	.PACKING,PREFORMED.....	1
43	PAOZZ	4730013657023	78528	4000-9	COUPLING HALF,SELF.....	1
44	PFOZZ	2530014788502	06853	065706	VALVE,RELAY,AIR PRE.....	1
45	PAOZZ	4730012456995	93061	219P4	PLUG,PIPE.....	1
46	PAOOZ	5342013367391	64466	12-006	COUPLING,CLAMP,GROO.....	1
47	PAOZZ	5330000902128	06853	213630	.PACKING,PREFORMED.....	1
48	PAOZZ	5306011581154	80204	B1821BH031C275D	BOLT,MACHINE 5/16-12 UNC X 2.50....	2
49	PAOZZ	4730002890232	93061	216P-6-4	REDUCER,PIPE.....	1
50	PAOZZ	4820013321578	69444	KITZAKTN3/8	VALVE,BALL 3-WAY VALVE, SHUT OFF...	1
51	PAOZZ	4730010969128	93061	68NTA-6-6	ADAPTER,STRAIGHT,PI.....	1
52	PAOZZ	4730010564990	93061	63NTA-6	.INSERT,TUBE FITTING.....	1
53	PAOZA	4730010485260	93061	60NTA-6	.SLEEVE,COMPRESSION,.....	1
54	PAOZA	4730010487873	93061	61NTA-6	.NUT,TUBE COUPLING.....	1
55	PAOZZ	4730012441226	93061	VS269NTA-6-6	ELBOW,PIPE TO TUBE.....	1
56	PAOZA	4730010487873	93061	61NTA-6	.NUT,TUBE COUPLING.....	1
57	PAOZA	4730010485260	93061	60NTA-6	.SLEEVE,COMPRESSION,.....	1
58	PAOZZ	4730010564990	93061	63NTA-6	.INSERT,TUBE FITTING.....	1
59	PAOZZ	4730010622570	93061	68NTA-6-4	ADAPTER,STRAIGHT,PI.....	1
60	PAOZA	4730010487873	93061	61NTA-6	.NUT,TUBE COUPLING.....	1
61	PAOZA	4730010485260	93061	60NTA-6	.SLEEVE,COMPRESSION,.....	1
62	PAOZZ	4730010564990	93061	63NTA-6	.INSERT,TUBE FITTING.....	1
63	PAOZZ	4730010918032	93061	68NTA-8-6	ADAPTER,STRAIGHT,PI.....	1
64	PAOZZ	4730010487874	93061	61NTA-8	.NUT,TUBE COUPLING.....	1
65	PAOZZ	4730010491559	93061	60NTA-8	.SLEEVE,COMPRESSION,.....	1
66	PAOZA	4730010485261	93061	63NTA-8	.INSERT,TUBE FITTING.....	1
67	PAOZZ	4730014418605	93061	QP8020	TEE,PIPE.....	1
68	PAOZZ	4730012441227	93061	VS269NTA-8-6	ELBOW,PIPE TO TUBE.....	2
69	PAOZA	4730010485261	93061	63NTA-8	.INSERT,TUBE FITTING.....	1
70	PAOZZ	4730010491559	93061	60NTA-8	.SLEEVE,COMPRESSION,.....	1
71	PAOZZ	4730010487874	93061	61NTA-8	.NUT,TUBE COUPLING.....	1
72	PAOZZ	4730010918032	93061	68NTA-8-6	ADAPTER,STRAIGHT,PI.....	2
73	PAOZA	4730010485261	93061	63NTA-8	.INSERT,TUBE FITTING.....	1
74	PAOZZ	4730010491559	93061	60NTA-8	.SLEEVE,COMPRESSION,.....	1
75	PAOZZ	4730010487874	93061	61NTA-8	.NUT,TUBE COUPLING.....	1
76	PAOZZ	4730008811161	79470	3300X6	COUPLING,PIPE.....	1
77	PAOZZ	4730000713175	93061	215PNL-6-15	NIPPLE,PIPE.....	1
78	MOOZZ		64678	PFT-6B-BLK-100X150	TUBE,NYLON 150" MAKE FROM CAGE 85757,PN 3250-061.....	1
79	MOOZZ		64678	PFT-6B-BLK-100X149	TUBE,NYLON 149" MAKE FROM CAGE 85757,PN 3250-061.....	1

END OF FIGURE

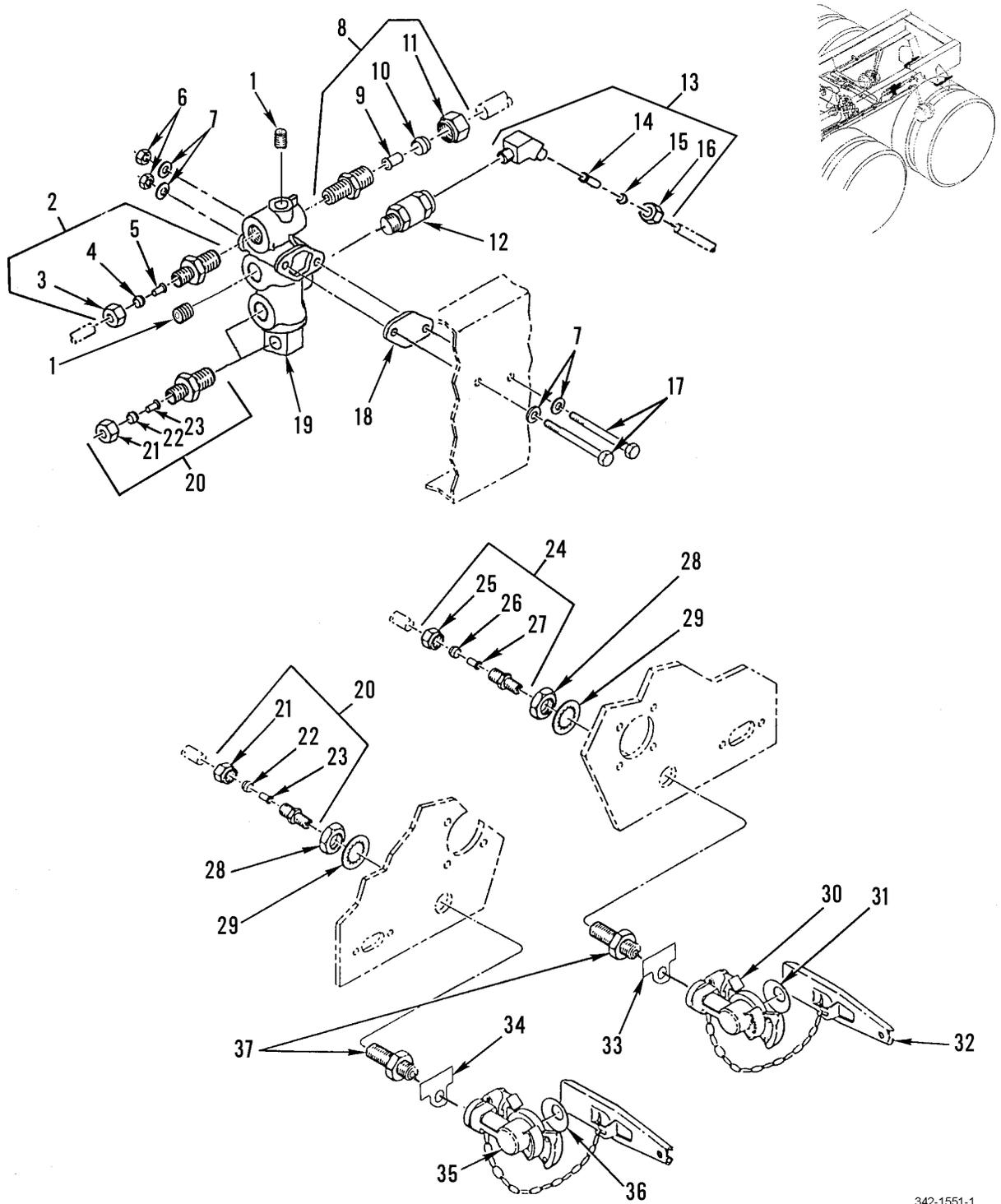
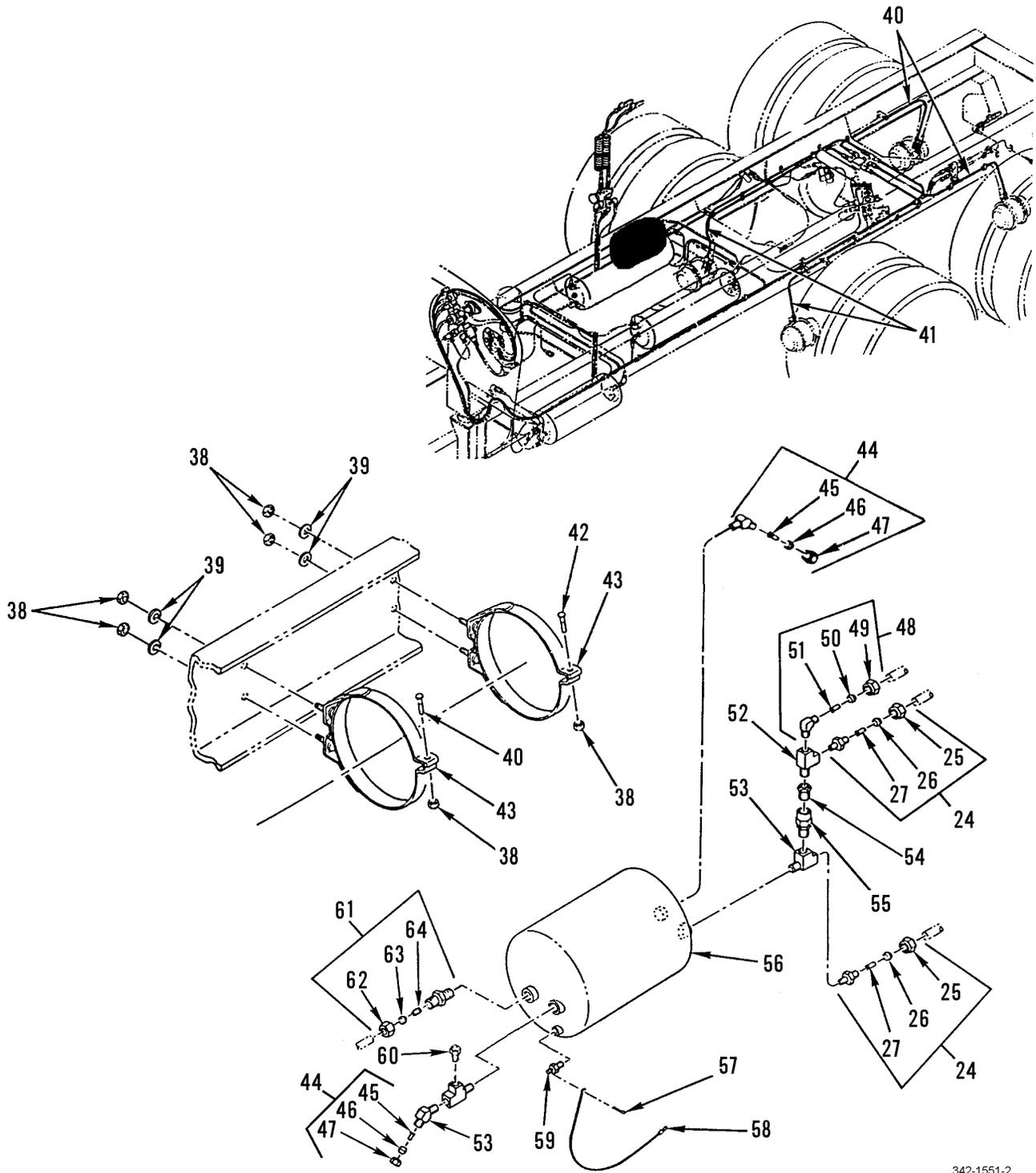

Figure 156. Air System Valves, Tanks, Lines and Fittings, Part 7 (Sheet 1 of 2)



342-1551-2

Figure 156. Air System Valves, Tanks, Lines and Fittings, Part 7 (Sheet 2 of 2)

SECTION II		TM9-2320-302-24P				
(1)	(2)	(3)	(4)	(5)	(6)	(7)
ITEM NO	SMR CODE	NSN	CAGEC	PART NUMBER	DESCRIPTION AND USABLE ON CODES(UOC)	QTY
GROUP 1208 AIRBRAKE SYSTEM						
FIG. 156 AIR SYSTEM VALVES, TANKS, LINES AND FITTINGS, PART 7						
1	PAOZZ	4730012456995	93061	219P-4	PLUG,PIPE 0.25 INCH.....	2
2	PAOZZ	4730010622570	93061	68NTA-6-4	ADAPTER,STRAIGHT,PI.....	1
3	PAOZA	4730010487873	93061	61NTA-6	.NUT,TUBE COUPLING.....	1
4	PAOZA	4730010485260	93061	60NTA-6	.SLEEVE,COMPRESSION,.....	1
5	PAOZZ	4730010564990	93061	63NTA-6	.INSERT,TUBE FITTING.....	1
6	PAOZZ	5310009133366	96906	MS51922-11	NUT,SELF-LOCKING,HE 5/6-18UNF-2B...	2
7	PAOZZ	5310000814219	96906	MS27183-12	WASHER,FLAT 5/16 IN.....	4
8	PAOZZ	4730010969127	93061	68NTA-6-8	ADAPTER,STRAIGHT,PI.....	1
9	PAOZZ	4730010564990	93061	63NTA-6	.INSERT,TUBE FITTING.....	1
10	PAOZA	4730010485260	93061	60NTA-6	.SLEEVE,COMPRESSION,.....	1
11	PAOZA	4730010487873	93061	61NTA-6	.NUT,TUBE COUPLING.....	1
12	PAOZZ	4820014787296	78528	4000-8D	VALVE,CHECK.....	1
13	PAOZZ	4730010793275	93061	279NTA-8-8	ELBOW,PIPE TO TUBE.....	1
14	PAOZZ	4730010485261	93061	63NTA-8	.INSERT,TUBE FITTING.....	1
15	PAOZZ	4730010491559	93061	60NTA-8	.SLEEVE,COMPRESSION.....	1
16	PAOZZ	4730010487874	93061	61NTA-8	.NUT,TUBE COUPLING.....	1
17	PAOZZ	5305013463694	64678	23-10744-350	SCREW,CAP,HEXAGON H 5/16-18UNC X 3.50.....	2
18	XDOZZ		64678	12-14109-000	SPACE,PLATE.....	1
19	PAOZZ	2530014788502	06853	065706	VALVE,RELAY,AIR PRE.....	1
20	PAOZZ	4730010918032	93061	68NTA-8-6	ADAPTER,STRAIGHT,PI.....	1
21	PAOZZ	4730010487874	93061	61NTA-8	.NUT,TUBE COUPLING.....	1
22	PAOZZ	4730010491559	93061	60NTA-8	.SLEEVE,COMPRESSION,.....	1
23	PAOZA	4730010485261	93061	63NTA-8	.INSERT,TUBE FITTING.....	1
24	PAOZZ	4730010969128	93061	68NTA-6-6	ADAPTER,STRAIGHT,PI.....	4
25	PAOZA	4730010487873	93061	61NTA-6	.NUT,TUBE COUPLING.....	1
26	PAOZA	4730010485260	93061	60NTA-6	.SLEEVE,COMPRESSION,.....	1
27	PAOZZ	4730010564990	93061	63NTA-6	.INSERT,TUBE FITTING.....	1
28	PAOZZ	5310003251900	80205	NAS1021N17	NUT,SELF-LOCKING,HE.....	2
29	PAOZZ	5310005826714	96906	MS35333-49	WASHER,LOCK 1.060 MAX. ID X 1.637 MAX. OD.....	2
30	PAOOZ	4730012445365	64466	12008	COUPLING HALF,QUICK.....	1
31	PAOZZ	5330000902128	06853	213630	.PACKING,PREFORMED.....	1
32	PAOZZ	2530001379235	14892	220635	DUMMY COUPLING,AUTO.....	2
33	PAOZZ	9905007744284	06853	201499	PLATE,INSTRUCTION.....	1
34	PAOZZ	9905007409721	97384	60244-90104	PLATE,INSTRUCTION.....	1
35	PAOOZ	5342013367391	64466	12-006	COUPLING,CLAMP,GROO.....	1
36	PAOZZ	5330000902128	06853	213630	.PACKING,PREFORMED.....	1
37	XDOZZ	2590007780324	58429	N11246	TRAILER COUPLING,TE.....	2
38	PAOZZ	5310000874652	96906	MS51922-17	NUT,SELF-LOCKING,HE 3/8-16UNC.....	6
39	PAOZZ	5310007737618	96906	MS15795-814	WASHER,FLAT.....	4
40	PAOZZ		64678	A23-12250-047	HOSE ASSEMBLY,NONME.....	2
41	PAOZZ		64678	A23-12348-055	HOSE ASSEMBLY,NONME #10 CRIMP.....	2
42	PAOZZ	5306008162441	80205	MS35751-71	BOLT,SQUARE NECK 3/8 X 1.50 INCH...	2
43	PAOZZ	5340013338208	64678	A12-13688-000	CLAMP,LOOP.....	2
44	PAOZZ	4730010960574	81343	10-8-100302BA	ELBOW,PIPE TO TUBE.....	2
45	PAOZZ	4730013559204	93061	63NTA-10	.INSERT,TUBE FITTING.....	1
46	PAOZZ	4730004268180	93061	60NTA-10	.SLEEVE,COMPRESSION,.....	1

SECTION II			TM9-2320-302-24P			
(1)	(2)	(3)	(4)	(5)	(6)	(7)
ITEM	SMR			PART		
NO	CODE	NSN	CAGEC	NUMBER	DESCRIPTION AND USABLE ON CODES(UOC)	QTY
47	PAOZZ	4730013714370	93061	61NTA-10	.NUT,TUBE COUPLING.....	1
48	PAOZZ	4730012441226	93061	VS269NTA-6-6	ELBOW,PIPE TO TUBE.....	1
49	PAOZA	4730010487873	93061	61NTA-6	.NUT,TUBE COUPLING.....	1
50	PAOZA	4730010485260	93061	60NTA-6	.SLEEVE,COMPRESSION,.....	1
51	PAOZZ	4730010564990	93061	63NTA-6	.INSERT,TUBE FITTING.....	1
52	PAOZZ	4730014418605	93061	QP8020	TEE,PIPE.....	1
53	PAOZZ	4730010952034	93061	2225P-8	TEE,PIPE.....	2
54	PAOZZ	4730008176578	96906	MS14315-4	BUSHING,PIPE 1/2 X 3/8NPT.....	1
55	PAOZZ	4820007748299	06853	800372	VALVE,CHECK.....	1
56	PAOZZ	2530013321393	64678	A12-11924-000	TANK,PRESSURE.....	1
57	PAOZZ	5315002341624	96906	MS24665-326	PIN,COTTER 3/32 DIA X 2.0 LG.....	1
58	XDOZZ		64678	A12-14544-024	CABLE ASSEMBLY.....	1
59	PAOZZ	4820013330095	64678	35000	COCK,DRAIN.....	1
60	PAOZA	4820010683477	06853	284143	VALVE,SAFETY RELIEF.....	1
61	PAOZZ	4730011967479	93061	68NTA-10-8	ADAPTER,STRAIGHT,PI.....	1
62	PAOZZ	4730013714370	93061	61NTA-10	.NUT,TUBE COUPLING.....	1
63	PAOZZ	4730004268180	93061	60NTA-10	.SLEEVE,COMPRESSION,.....	1
64	PAOZZ	4730013559204	93061	63NTA-10	.INSERT,TUBE FITTING.....	1

END OF FIGURE

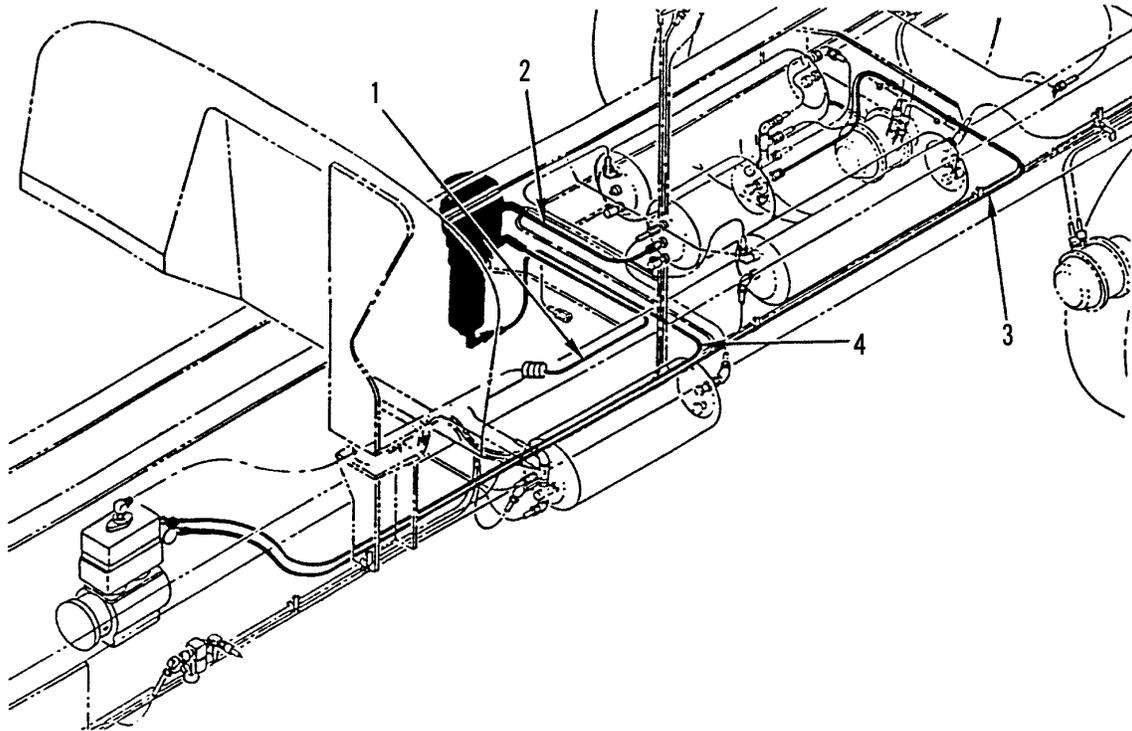

342-1553

Figure 157. Air System Valves, Tanks, Lines and Fittings, Part 8

SECTION II			TM9-2320-302-24P			
(1)	(2)	(3)	(4)	(5)	(6)	(7)
ITEM	SMR			PART		
NO	CODE	NSN	CAGEC	NUMBER	DESCRIPTION AND USABLE ON CODES(UOC)	QTY
					GROUP 1208 AIRBRAKE SYSTEM	
					FIG. 157 AIR SYSTEM VALVES, TANKS, LINES AND FITTINGS, PART 8	
1	PAOZZ		64678	A23-02235-090	HOSE ASSEMBLY, NONME.....	1
2	MOOZZ		64678	48-00101-030X180	TUBE, NYLON 180" MAKE FROM BULK PN 3250-1010 (85757).....	1
3	MOOZZ		64678	PFT-6B-BLK-100X1 15	TUBE, NYLON 115" MAKE FROM BULK PN 3250-061 (85757).....	1
4	MOOZZ		64678	48-00101-010X7	TUBE, NYLON 7.0 FT MAKE FROM BULK PN 3250-061 (85757).....	1

END OF FIGURE

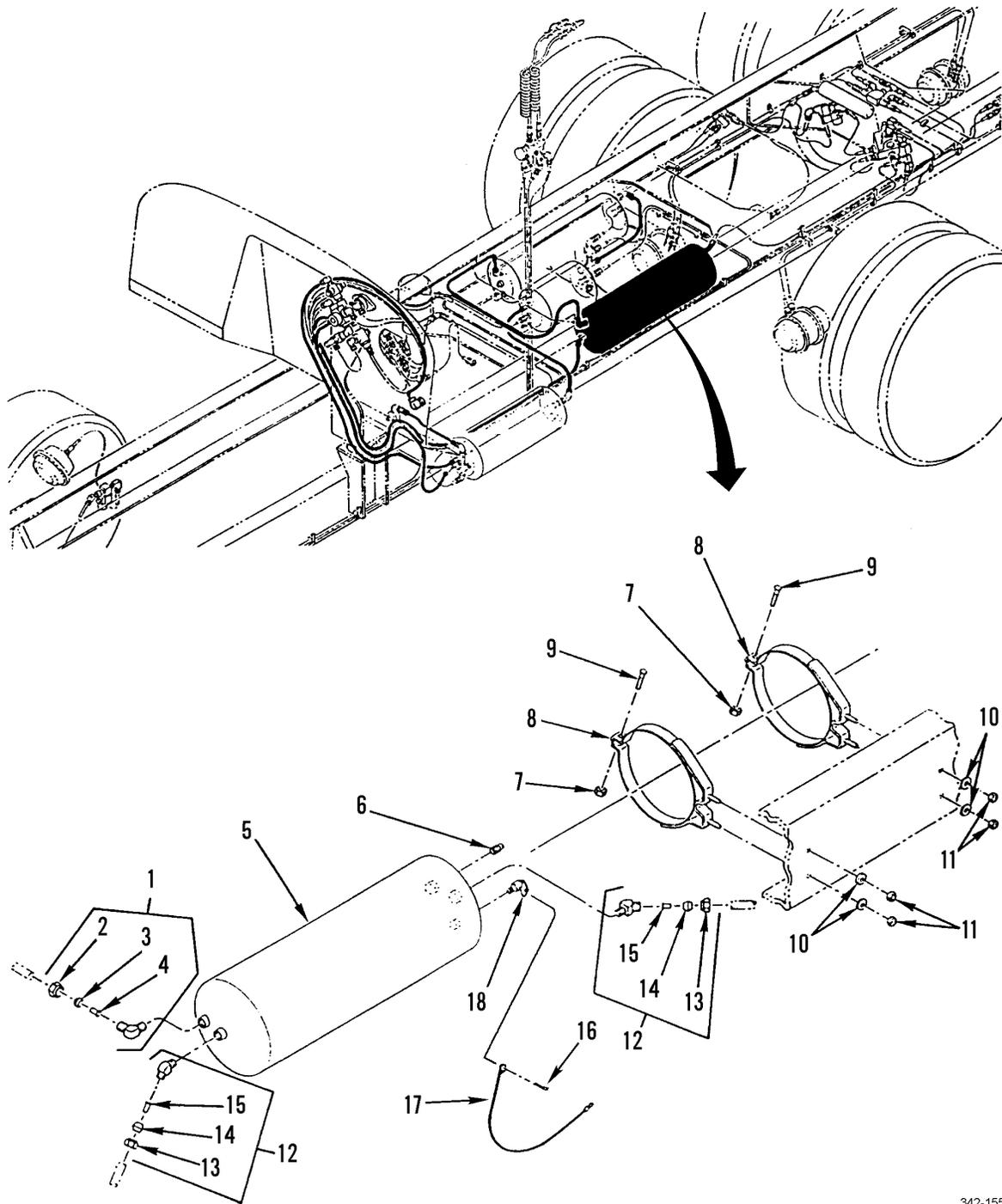

342-1558-1

Figure 158. Air System Valves, Tanks, Lines and Fittings, Part 9 (Sheet 1 of 2)

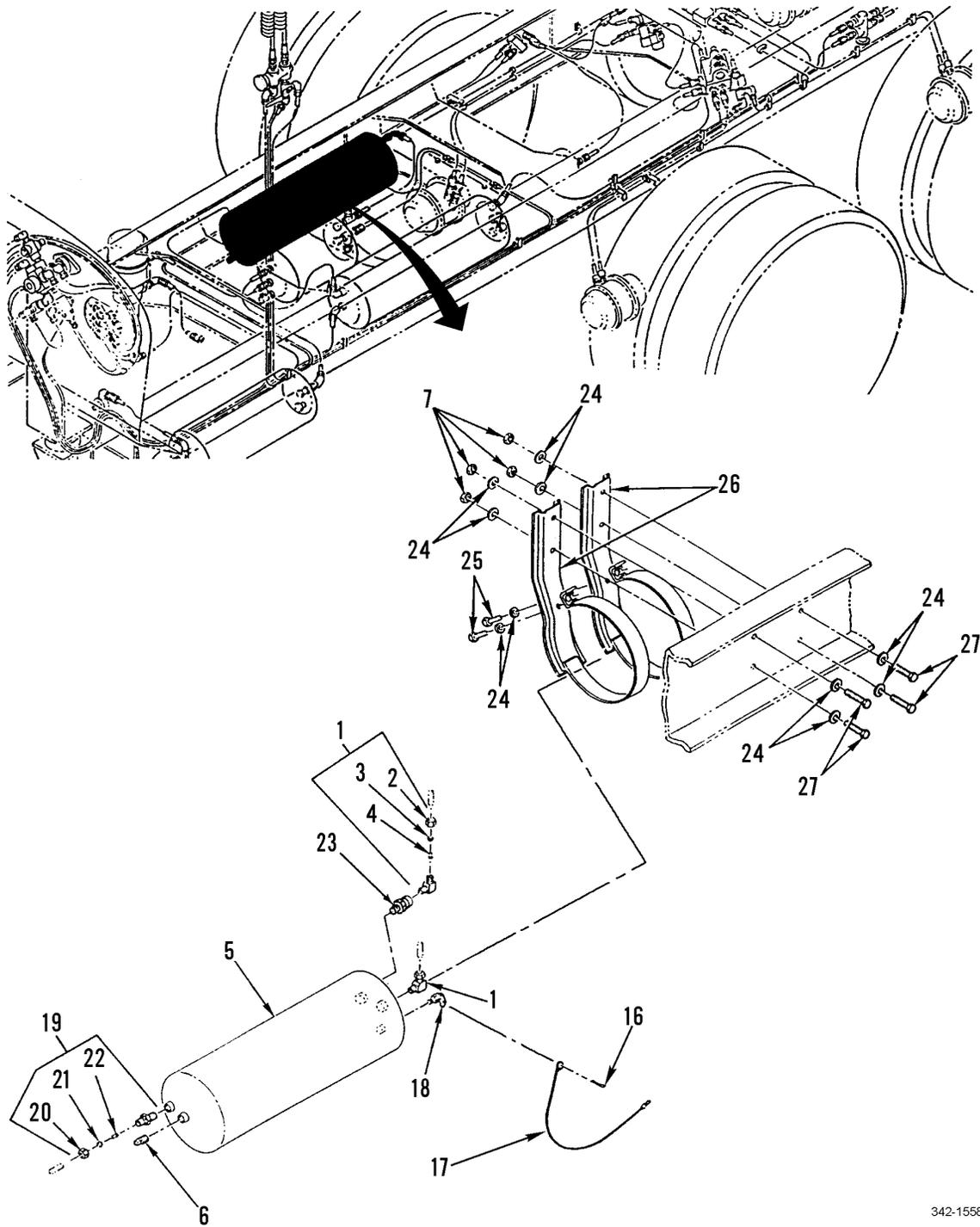

342-1558-2

Figure 158. Air System Valves, Tanks, Lines and Fittings, Part 9 (Sheet 2 of 2)

SECTION II			TM9-2320-302-24P			
(1)	(2)	(3)	(4)	(5)	(6)	(7)
ITEM	SMR			PART		
NO	CODE	NSN	CAGEC	NUMBER	DESCRIPTION AND USABLE ON CODES(UOC)	QTY
GROUP 1208 AIRBRAKE SYSTEM						
FIG. 158 AIR SYSTEM VALVES, TANKS, LINES AND FITTINGS, PART 9						
1	PAOZZ	4730011024123	93061	269NTA-10-8	ELBOW,PIPE TO TUBE.....	3
2	PAOZZ	4730013714370	93061	61NTA-10	.NUT,TUBE COUPLING.....	1
3	PAOZZ	4730004268180	93061	60NTA-10	.SLEEVE,COMPRESSION,.....	1
4	PAOZZ	4730013559204	93061	63NTA-10	.INSERT,TUBE FITTING.....	1
5	PAOZZ	2530013321394	64678	A12-11924-002	TANK,PRESSURE.....	2
6	PAOZZ	4730000113176	81343	8 130109AB	PLUG,PIPE.....	2
7	PAOZZ	5310000874652	96906	MS51922-17	NUT,SELF-LOCKING,HE 3/8-16UNC.....	8
8	PFOZZ	5340013338208	64678	A12-13688-000	CLAMP,LOOP.....	2
9	PAOZZ	5306008162441	96906	MS35751-71	BOLT,SQUARE NECK.....	2
10	PAOZZ	5310007737618	96906	MS15795-814	WASHER,FLAT.....	4
11	PAOZZ	5310000874652	96906	MS51922-17	NUT,SELF-LOCKING,HE.....	4
12	PAOZZ	4730010960574	81343	10-8-100302BA	ELBOW,PIPE TO TUBE.....	2
13	PAOZZ	4730013714370	93061	61NTA-10	.NUT,TUBE COUPLING.....	1
14	PAOZZ	4730004268180	93061	60NTA-10	.SLEEVE,COMPRESSION,.....	1
15	PAOZZ	4730013559204	93061	63NTA-10	.INSERT,TUBE FITTING.....	1
16	PAOZZ	5315002341624	96906	MS24665-326	PIN,COTTER 3/32 DIA X 2.0 LG.....	2
17	XDOZZ		64678	A12-14544-024	CABLE ASSEMBLY.....	2
18	PAOZZ	4820013330095	64678	35000	COCK,DRAIN.....	2
19	PAOZZ	4730011967479	93061	68NTA-10-8	ADAPTER,STRAIGHT,PI.....	1
20	PAOZZ	4730013714370	93061	61NTA-10	.NUT,TUBE COUPLING.....	1
21	PAOZZ	4730004268180	93061	60NTA-10	.SLEEVE,COMPRESSION,.....	1
22	PAOZZ	4730013559204	93061	63NTA-10	.INSERT,TUBE FITTING.....	1
23	PAOZZ	4820007748299	06853	800372	VALVE,CHECK.....	1
24	PAOZZ	5310000806004	96906	MS27183-14	WASHER,FLAT.....	10
25	PAOZZ	5305002693218	96906	MS90725-68	SCREW,CAP,HEXAGON H 3/8-16UNC X 2.50.....	2
26	PAOZZ	5340013326654	64678	A12-12035-000	BRACKET,MOUNTING.....	2
27	PAOZZ	5306004838833	15434	191772	BOLT,MACHINE 3/8-16 X 1.25.....	4

END OF FIGURE

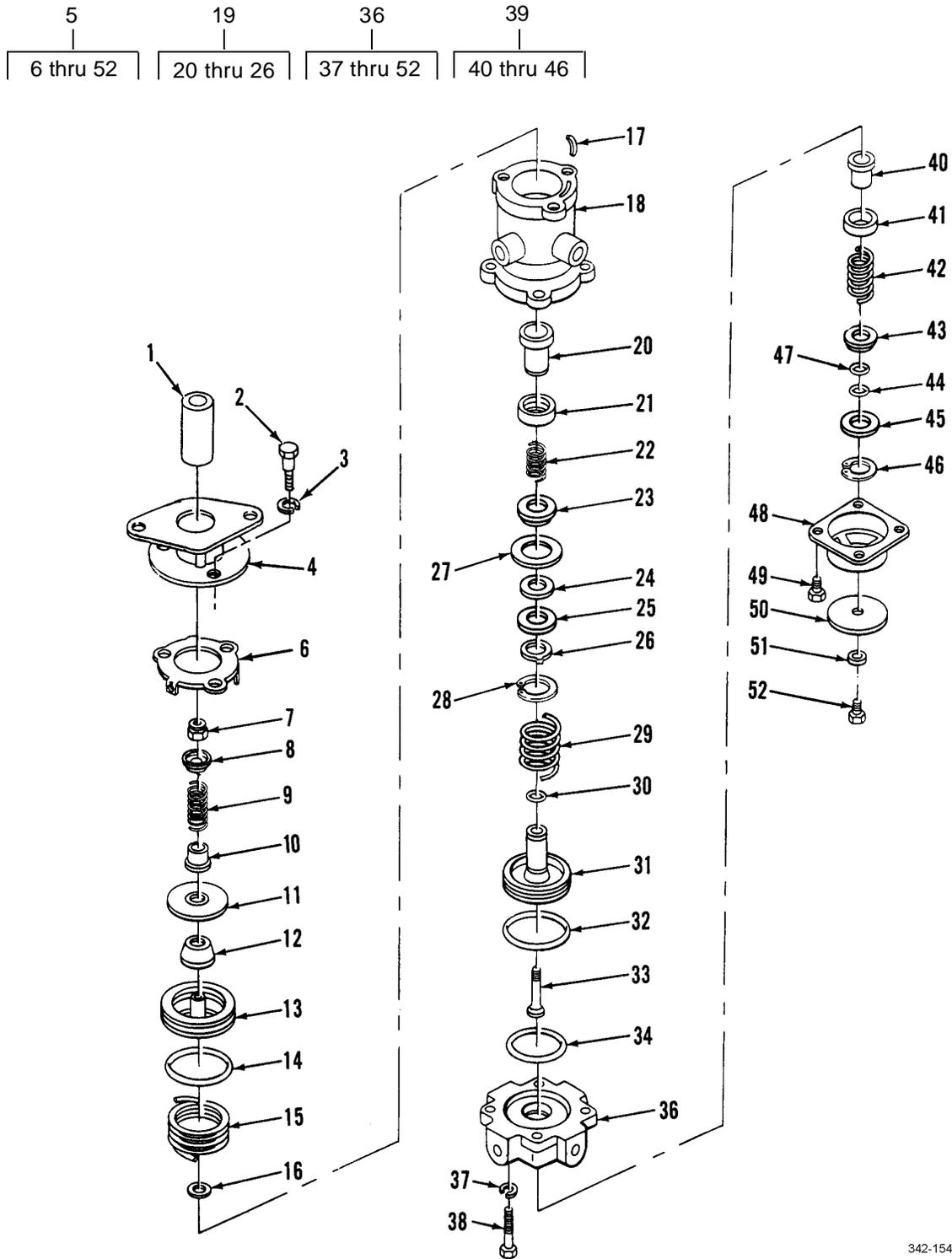

342-1542

Figure 159. Air System Valves, Tanks, Lines and Fittings, Part 10

SECTION II			TM9-2320-302-24P			
(1)	(2)	(3)	(4)	(5)	(6)	(7)
ITEM NO	SMR CODE	NSN	CAGEC	PART NUMBER	DESCRIPTION AND USABLE ON CODES(UOC)	QTY
GROUP 1208 AIRBRAKE SYSTEM						
FIG. 159 AIR SYSTEM VALVES, TANKS, LINES AND FITTINGS, PART 10						
1	XDFZZ		06853	298486	PLUNGER.....	1
2	PAFZZ	5306011241225	06853	293337	BOLT,ASSEMBLED WASH.....	3
3	PAFZZ	5310009594679	96906	MS35340-45	WASHER,LOCK 5/16.....	3
4	XDFZZ		64678	12-12277-000	ADPATER.....	1
5	PFFFF	2590011306720	06853	286171	VALUE THROTTLE.....	1
6	PAFZZ	2530009802384	06853	239668	.RETAINER,BRAKE VALV.....	1
7	PAFZZ	5310008775798	96906	MS21044D3	.NUT,SELF-LOCKING,HE PART OF KIT P/N 82TV196.....	1
8	PAFZZ	5340011354292	06853	290189	.RETAINER,HELICAL CO.....	1
9	PAFZZ	5360011251670	06853	290185	.SPRING,HELICAL,COMP.....	1
10	PAFZZ	5310011268834	06853	290188	.NUT,SLEEVE.....	1
11	PFFZZ	4820011320606	06853	290187	.SEAT,VALVE.....	1
12	PAFZZ	5342009314527	11083	5D768	.MOUNT,RESILIENT PART OF KIT P/N 82TV196.....	1
13	PAFZZ	2530011609652	06853	290184	.PISTON,HYDRAULIC BR.....	1
14	KFFZZ		45152	1PS100	.PACKING,PREFORMED PART OF KIT P/N 82TV196.....	1
15	PAFZZ	5360011251671	06853	247231	.SPRING,HELICAL,COMP PART OF KIT P/N 82TV196.....	1
16	KFFZZ		06853	292596	.WASHER,RUBBER PART OF KIT P/N 82TV196.....	1
17	XDFZZ	4330010557653	06853	245050	.FILTER,BRAKE VALVE PART OF KIT P/N 82TV196.....	1
18	XDFZZ		06853	290181	.BODY,VALVE.....	1
19	PAFFF	4820010836788	06853	279754	.GUIDE,VALVE STEM PART OF KIT P/N 82TV196.....	1
20	PAFZZ	2530010838102	06853	112442	.VALVE,INLET AND EXH PART OF KIT P/N 82TV196.....	1
21	PAFZZ	5340010836420	06853	244435	.SEAT,HELICAL COMPRE PART OF KIT P/N 82TV196.....	1
22	PAFZZ	5360010839766	06853	244437	.SPRING,HELICAL,COMP PART OF KIT P/N 82TV196.....	1
23	PAFZZ	2530010836343	06853	244439	.O-RING RETAINER,BRA.....	2
24	KFFZZ		45152	1PS66	.PACKING,PREFORMED PART OF KIT P/N 82TV196.....	1
25	PFFZZ		06853	244438	.WASHER,FLAT.....	1
26	PAFZZ	5325008042025	96906	MS16624-1087	.RING,RETAINING PART OF KIT P/N 82TV196.....	1
27	XAFZZ		45152	1PS47	.RETAINER,PACKING.....	1
28	PAFZZ	5340007387552	06853	240345	.CLIP,RETAINING.....	1
29	KFFZZ		06853	290190	.SPRING,RELAY PART OF KIT P/N 82TV196.....	1
30	PAFZZ	5331000445726	96906	MS9068-016	.O-RING PART OF KIT P/N 82TV196.....	1
31	PAFZZ	2530011229933	06853	290202	.PISTON,VALVE.....	1
32	PAFZZ	5331011261233	06853	247226	.O-RING PART OF KIT P/N 82TV196.....	1
33	PAFZZ	5305011250929	06853	290186	.SCREW,SHOULDER.....	1
34	KFFZZ		45152	1PS88	.PACKING,PREFORMED PART OF KIT P/N	1

SECTION II			TM9-2320-302-24P			
(1)	(2)	(3)	(4)	(5)	(6)	(7)
ITEM	SMR			PART		
NO	CODE	NSN	CAGEC	NUMBER	DESCRIPTION AND USABLE ON CODES(UOC)	QTY
35	XAFFF		06853	289108	82TV196.....	
36	PAFZZ	4820012424714	06853	290182	.LOWER BODY ASSY.....	1
37	PAFZZ	5310000870306	06853	202981	..BODY, VALVE.....	1
38	PAFZZ	5305004657854	06853	203198	..WASHER, LOCK.....	4
39	KFFFF		06853	286172	..SCREW, CAP, HEXAGON H.....	4
40	KFFZZ		06853	248536	..VALVE ASSY, INL/EXH PART OF KIT P/N	1
41	PAFZZ	2530011273971	06853	247216	82TV196.....	
42	PAFZZ	5360011246811	06853	247217	...VALVE, INLET/EXH PART OF KIT P/N	1
43	KFFZZ		06853	247219	82TV196.....	
44	KFFZZ		45152	1PS90	...RETAINER, HELICAL CO.....	1
45	PAFZZ	5310012960327	06853	290183	...SPRING, HELICAL, COMP.....	1
46	KFFZZ		06853	247220	...RETAINER, PACKING PART OF KIT P/N	1
47	KFFZZ		45152	1PS93	82TV196.....	
48	PAFZZ	4820011520193	89346	634419-C-1	...PACKING, PREFORMED PART OF KIT P/N	1
49	PAFZZ	5305010846065	06853	292275	82TV196.....	
50	PAFZZ	4820011520194	06853	249371	..CAP, VALVE.....	1
51	PAFZZ	5310001212803	06853	239943	..SCREW, MACHINE.....	4
52	KFFZZ		06853	103081	..DIAPHRAGM, VALVE, FLA PART OF KIT	1
					P/N 82TV196.....	
					..WASHER, SPRING TENSI PART OF KIT	1
					P/N 82TV196.....	
					..SCREW, FORMING PART OF KIT P/N	1
					82TV196.....	

END OF FIGURE

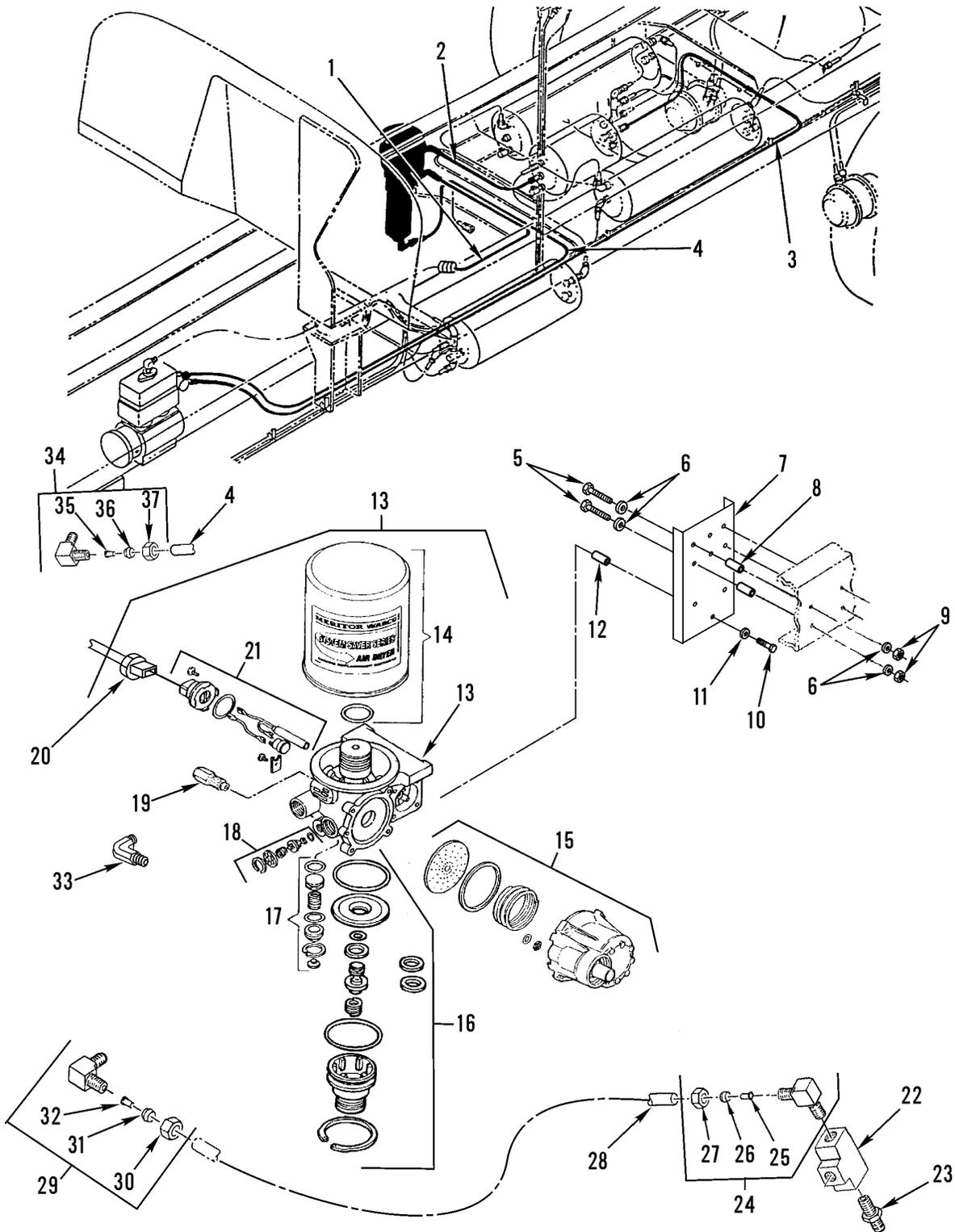
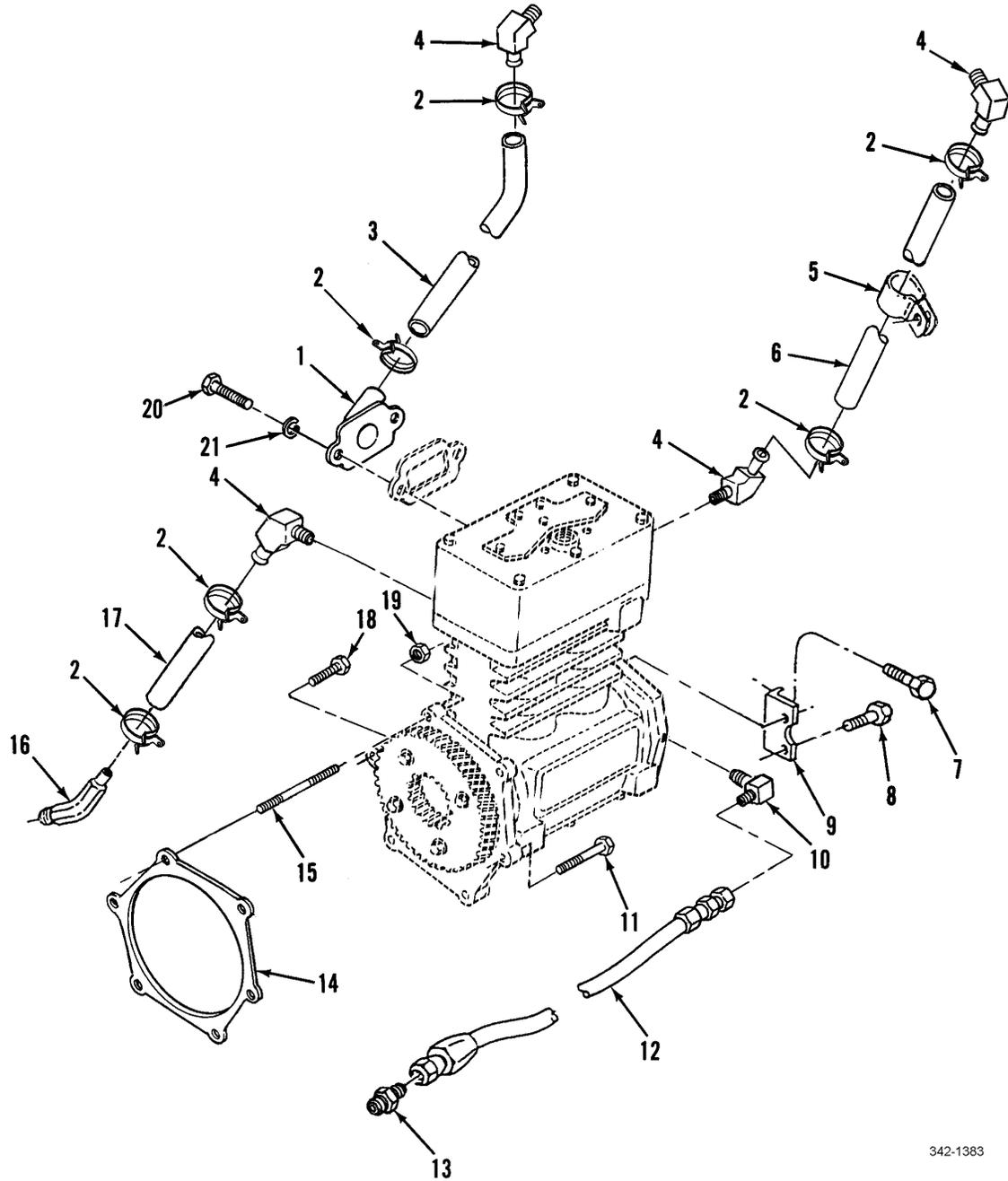

Figure 160. Air Dryer Assembly

SECTION II			TM9-2320-302-24P			
(1)	(2)	(3)	(4)	(5)	(6)	(7)
ITEM NO	SMR CODE	NSN	CAGEC	PART NUMBER	DESCRIPTION AND USABLE ON CODES(UOC)	QTY
GROUP 1208 AIRBRAKE SYSTEM						
FIG. 160 AIR DRYER ASSEMBLY						
1	PAOZZ		64678	A23-02235-090	HOSE ASSEMBLY, NONME WIRE BRAID, NO.10.....	1
2	MOOZZ		64678	48-00101-030X180	TUBE, NYLON 180" MAKE FROM BULK PN 3250-1010 (85757).....	1
3	MOOZZ		64678	PFT-6B-BLK-100X15	TUBE, NYLON 115" MAKE FROM BULK PN 3250-061 (85757).....	1
4	MOOZZ		64678	48-00101-010X7	TUBE, NYLON 7.0 FT. MAKE FROM BULK 3250-061 (85757).....	1
5	PAOZZ	5305007246847	80204	B1821BH063C600N	SCREW, CAP, HEXAGON H 1.1-11 X 6.00..	4
6	PAOZZ	5310007208819	96906	MS15795-821	WASHER, FLAT .69 ID X 1.31 OD X .177 THK.....	8
7	XDOZZ		64678	12-14496-004	BRACKET, DOUBLE ANGL.....	1
8	XDOZZ		64678	23-09291-388	SPACER, SLEEVE 0.6875 ID X 1.5 OD X 3.88" LG.....	4
9	PAOZZ	5310002694040	81349	M45913/1-10CG5C	NUT, SELF-LOCKING, HE 5/8-11UNC.....	4
10	PAOZZ	5305000712073	80204	B1821BH050C250N	SCREW, CAP, HEXAGON H 1/2-13 X 2.5...	3
11	PAOZZ	5310011091977	19207	11628332-2	WASHER, FLAT .53 ID X 1.06 OD X .177 THK.....	3
12	XDOZZ		64678	23-11709-100	SPACER, SLEEVE 0.50 X 1.06 OD X 1.0 LG.....	3
13	PFOOO		78500	R955205	DRIER, AIR-GAS, DISIC.....	1
14	PAOZZ	4440014439031	78500	R950011	.CARTRIDGE, DEHYDRATO.....	1
15	PAOZZ		78500	R950012	.PARTS KIT, VALVE INCLUDES DIAPHRAGM, CAP, SPRING, VALVE HOUSING W/O-RING & FILTER, (4) SCREWS.....	1
16	PAOZZ	4820014436639	78500	R950014	.PARTS KIT, VALVE INCLUDES O-RINGS, WASHER, PISTON SEAT, PISTON, SHIMS, VALVE, HEAD, RETAINER RING.....	1
17	PAOZZ		78500	R950013	.PARTS KIT, VALVE INCLUDES PLUG, RETAINING RING, COVER, O-RING, SPRING, SEAL.....	1
18	PAOZZ		78500	R950017	.PARTS KIT, VALVE INCLUDES O-RING, VALVE BODY, SPRING, WASHER, RETAINING RING.....	1
19	PAOZZ		78500	S2206-D-1226	.VALVE, VENT.....	1
20	PAOZZ		78500	SRWABC002	.WIRING HARNESS.....	1
21	PAOZZ	2990014442368	78500	R950015	.PARTS KIT, HEATER, CO INCLUDES SCREWS, WIRING CONNECTOR, O-RING, WIRE, HEATER, THERMOSTAT, RETAINER.....	1
22	PAOZZ		78500	S434 100 310 0	.VALVE, CHECK.....	1
23	PAOZZ	4730005953108	93061	216P8	NIPPLE, PIPE .50 NPTF X 1.812.....	1
24	PAOZZ	4730010960574	93061	VS279NTA-10-8	ELBOW, PIPE TO TUBE.....	1
25	PAOZZ	4730013559204	93061	63NTA-10	.INSERT, TUBE FITTING.....	1
26	PAOZZ	4730004268180	93061	60NTA-10	.SLEEVE, COMPRESSION,.....	1
27	PAOZZ	4730013714370	93061	61NTA-10	.NUT, TUBE COUPLING.....	1
28	MOOZZ		64678	48-00101-030X180	TUBE, NYLON 180" MAKE FROM BULK PN 3250-1010 (85757).....	1
29	PAOZZ	4730011024123	93061	269NTA-10-8	ELBOW, PIPE TO TUBE.....	1

SECTION II			TM9-2320-302-24P			
(1)	(2)	(3)	(4)	(5)	(6)	(7)
ITEM	SMR			PART		
NO	CODE	NSN	CAGEC	NUMBER	DESCRIPTION AND USABLE ON CODES(UOC)	QTY
30	PAOZZ	4730013714370	93061	61NTA-10	.NUT,TUBE COUPLING.....	1
31	PAOZZ	4730004268180	93061	60NTA-10	.SLEEVE,COMPRESSION,.....	1
32	PAOZZ	4730013559204	93061	63NTA-10	.INSERT,TUBE FITTING.....	1
33	PAOZZ	4730006139339	93061	249F-10-8	ELBOW,PIPE TO TUBE.....	1
34	PAOZZ	4730012443552	93061	VS269NTA-6-4	ELBOW,PIPE TO TUBE.....	1
35	PAOZZ	4730010564990	93061	63NTA-6	.INSERT,TUBE FITTING.....	1
36	PAOZA	4730010485260	93061	60NTA-6	.SLEEVE,COMPRESSION,.....	1
37	PAOZA	4730010487873	93061	61NTA-6	.NUT,TUBE COUPLING.....	1

END OF FIGURE



342-1383

Figure 161. Air Compressor Lines and Fittings

SECTION II			TM9-2320-302-24P			
(1)	(2)	(3)	(4)	(5)	(6)	(7)
ITEM	SMR			PART		
NO	CODE	NSN	CAGEC	NUMBER	DESCRIPTION AND USABLE ON CODES(UOC)	QTY
GROUP 1209 AIR COMPRESSOR ASSEMBLY						
FIG. 161 AIR COMPRESSOR LINES AND FITTINGS						
1	PAOZZ	5310013212419	72582	23506346	NUT,PLAIN,PLATE.....	1
2	PFOZZ	4730014409730	72582	23517093	CLAMP,HOSE.....	6
3	PAOZZ	4720014407809	72582	23517285	HOSE,NONMETALLIC.....	1
4	PAOZZ	4730013322389	72582	23505201	ELBOW,TUBE TO HOSE.....	4
5	PFOZZ	5340014404885	72582	5147753	CLAMP,LOOP.....	1
6	PAOZZ	4720014412384	72582	23519268	HOSE,NONMETALLIC.....	1
7	PAOZZ	5306011865367	11862	11503454	BOLT,MACHINE M10X1.50 X 20-6G G10.9	2
8	XDOZZ		72582	11509512	BOLT,MACHINE M8 X 1.25 X 25MM.....	2
9	XDOZZ		72582	23515369	BRACKET,SUPPORT.....	1
10	PFOZZ	4730013503589	72582	8924998	ELBOW,TUBE.....	1
11	PAOZZ	5305013380428	72582	23505050	SCREW,CAP,HEXAGON H M10 X 1.5 X 85-6G.....	4
12	PAOZZ		72582	BAHH0177	HOSE ASSEMBLY,NONME.....	1
13	PAOZZ	4730013193374	72582	8929833	ADAPTER,STRAIGHT.....	1
14	PAOZZ	5330013184569	72582	8929299	GASKET PART OF KIT P/N 23512691.....	1
15	XDOZZ		72582	23517130	STUD,SPECIAL.....	1
16	PFOZZ	4730013359621	72582	8929749	ELBOW,PIPE TO HOSE.....	1
17	PAOZZ	4720014411677	72582	23517094	HOSE,NONMETALLIC.....	1
18	PAOZZ	4720014407809	72582	23517285	HOSE,NONMETALLIC M10 X 1.5 X 30-6G,GR10.9.....	1
19	PAOZZ	5310012507679	72582	23521131	NUT M10 X 1.5.....	1
20	PAOZZ	5310004079566	96906	MS35338-45	WASHER,LOCK 5/6.....	2
21	PAOZZ	5306002264825	80204	B1821BH031C075N	BOLT,MACHINE 5/16-18UNC-2A X .750..	2

END OF FIGURE

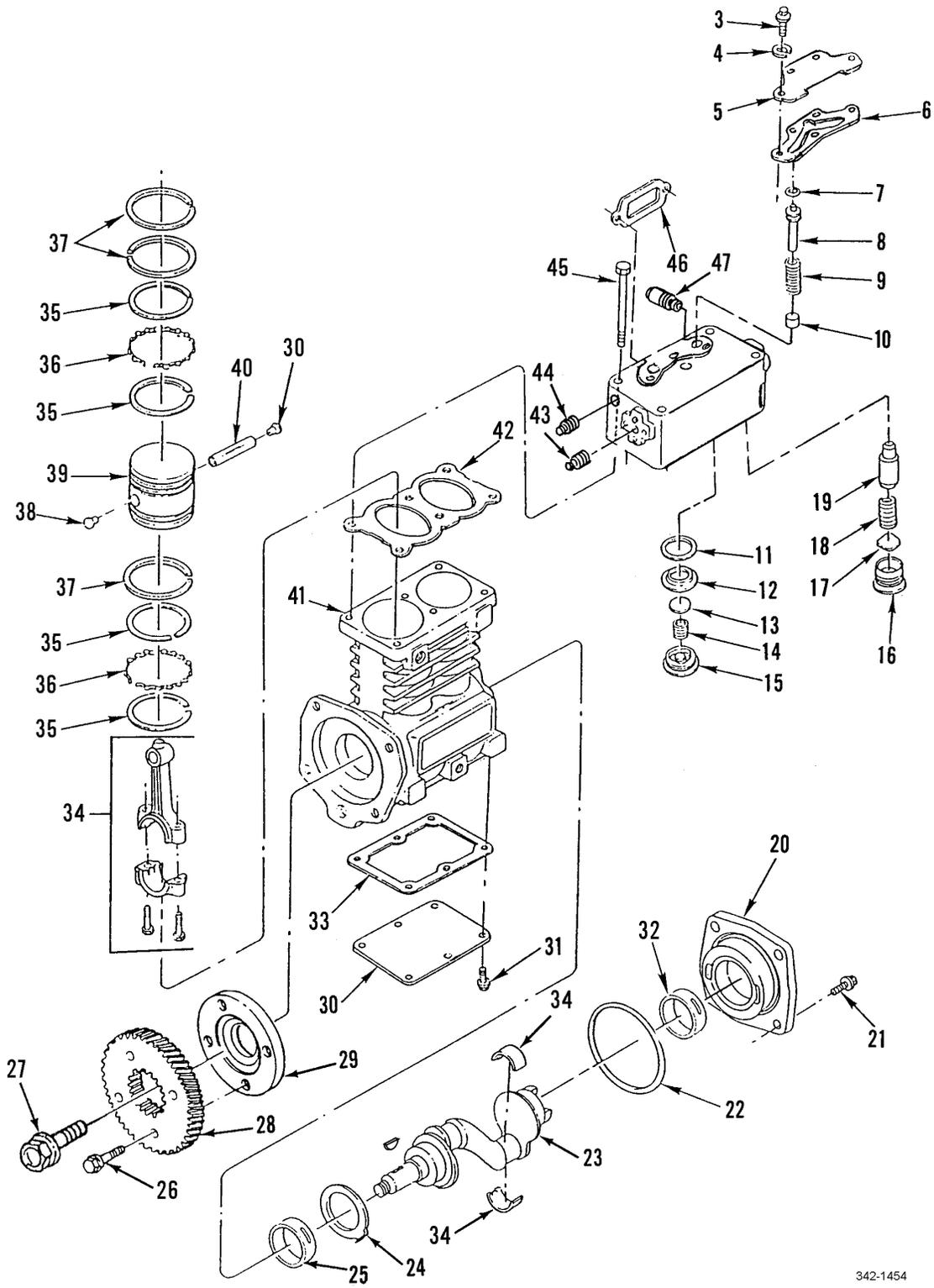

342-1454

Figure 162. Air Compressor Assembly

SECTION II			TM9-2320-302-24P			
(1)	(2)	(3)	(4)	(5)	(6)	(7)
ITEM	SMR			PART		
NO	CODE	NSN	CAGEC	NUMBER	DESCRIPTION AND USABLE ON CODES(UOC)	QTY
GROUP 1209 AIR COMPRESSOR ASSEMBLY						
FIG. 162 AIR COMPRESSOR ASSEMBLY						
1	PBOFF	2835014358024	06853	109426	COMPRESSOR,AIR.....	1
2	XAFFF		06853	107082	.CYLINDER HD CPL.....	1
3	PAFZZ	5306000825161	06853	237687	..BOLT,MACHINE 5/16 X 3/4.....	4
4	PAFZZ	5310004079566	96906	MS35338-45	..WASHER,LOCK 5/16".....	4
5	XAFZZ		06853	298722	..PLATE,COVER.....	1
6	KFFZZ		06853	298721	..GASKET PART OF KIT P/N 107516.....	1
7	KFFZZ		06853	294821	..PACKING,PREFORMED PART OF KIT P/N 107516.....	1
8	KFFZZ		06853	110911	..PISTON,UNLOADER PART OF KIT P/N 107516.....	1
9	KFFZZ		06853	298724	..SPRING HELICAL,COMP PART OF KIT P/N 107516.....	1
10	PFFZZ		06853	298719	..BUSHING.....	1
11	KFFZZ		06853	294569	..GASKET PART OF KIT P/N 107516.....	1
12	KFFZZ		06853	110910	..INLET VALVE SEAT PART OF KIT P/N 107516.....	1
13	KFFZZ		06853	296615	..VALVE,INLET PART OF KIT P/N 107516	1
14	KFFZZ		06853	111666	..SPRING,INLET VALVE PART OF KIT P/N 107516.....	1
15	KFFZZ		06853	110907	..INLET VALVE STOP PART OF KIT P/N 107516.....	1
16	PAFZZ	4820008933216	06853	294751	..SEAT,VALVE PART OF KIT P/N 107516.	1
17	PAFZZ	4820004268386	06853	230935	..SEAT,VALVE PART OF KIT P/N 107516.	1
18	PAFZZ	5360010818276	06853	292375	..SPRING,HELICAL,COMP PART OF KIT P/N 107516.....	1
19	PAFZA	4820010807439	06853	246432	..STOP,VALVE.....	1
20	XDFZZ		06853	109363	.COUPLING ADAPTER.....	1
21	PAFZZ	5306000825161	06853	237687	.BOLT,MACHINE.....	4
22	KFFZZ		06853	298730	.SEAL,RING PART OF KIT P/N 107969...	1
23	XDFZZ		06853	112531	.CRANKSHAFT.....	1
24	KFFZZ		06853	292304	.RING,RETAINING PART OF KIT P/N 107969.....	1
25	KFFZZ		06853	112547	.BEARING PART OF KIT P/N 107969.....	1
26	XDFZZ		06853	113189	.BOLT,MACHINE M10 X 5-6 X 30MM.....	1
27	XDFZZ		06853	112551	.BOLT,MACHINE M20 X 2.5-6 X 50MM...	1
28	XDFZZ		06853	113054	.GEAR,DRIVE.....	1
29	XDFZZ		06853	112550	.ADAPTER,GEAR.....	1
30	XDFZZ		06853	298725	.COVER,CRANKCASE.....	1
31	PAFZZ	5305014429868	06853	237688	.SCREW,CAP,HEXAGON H.....	1
32	KFFZZ	3120011640978	06853	249704	.BEARING,SLEEVE PART OF KIT P/N 107969.....	1
33	KFFZZ		06853	110447	.GASKET,BASE PART OF KIT P/N 107969 PART OF KIT P/N 108842.....	1
34	KFFZZ		06853	109884	.CONNECTING ROD ASSY PART OF KIT P/N 108842.....	1
35	KFFZZ		06853	298710	.RING,PISTON PART OF KIT P/N 107639	4
36	KFFZZ		06853	298714	PART OF KIT P/N 108842..... .RING,PISTON PART OF KIT P/N 107639	2

SECTION II			TM9-2320-302-24P			
(1)	(2)	(3)	(4)	(5)	(6)	(7)
ITEM	SMR			PART		
NO	CODE	NSN	CAGEC	NUMBER	DESCRIPTION AND USABLE ON CODES(UOC)	QTY
37	KFFZZ		06853	298706	PART OF KIT P/N 108842.....	
					.RING,PISTON PART OF KIT P/N 107639	3
38	PAFZZ	2530010813213	06853	292392	PART OF KIT P/N 108842.....	
					.PLUG,RETAINER PIN PART OF KIT P/N	2
					108842.....	
39	KFFZZ		06853	287696	.PISTON,STD PART OF KIT P/N 108842..	1
40	PAFZZ	4310011538352	06853	292530	.PIN,PISTON PART OF KIT P/N 108842..	2
41	XDFZZ		06853	112514	.CRANKCASE.....	1
42	KFFZZ		06853	298715	.GASKET,CYLINDER HD PART OF KIT P/N	1
					107516.....	
43	PAFZZ	4730006023707	25511	P49787	.PLUG,PIPE.....	1
44	PAFZZ	4730012169355	79470	C3169X1	.PLUG,PIPE.....	1
45	XDFZZ		06853	298749	.SCREW,CAP,HEXAGON.....	1
46	PAFZZ	5330002623272	06853	243430	.GASKET PART OF KIT P/N 107516.....	1
47	PAFZZ	4820014428339	06853	131081	.VALVE,SAFETY RELIEF.....	1

END OF FIGURE

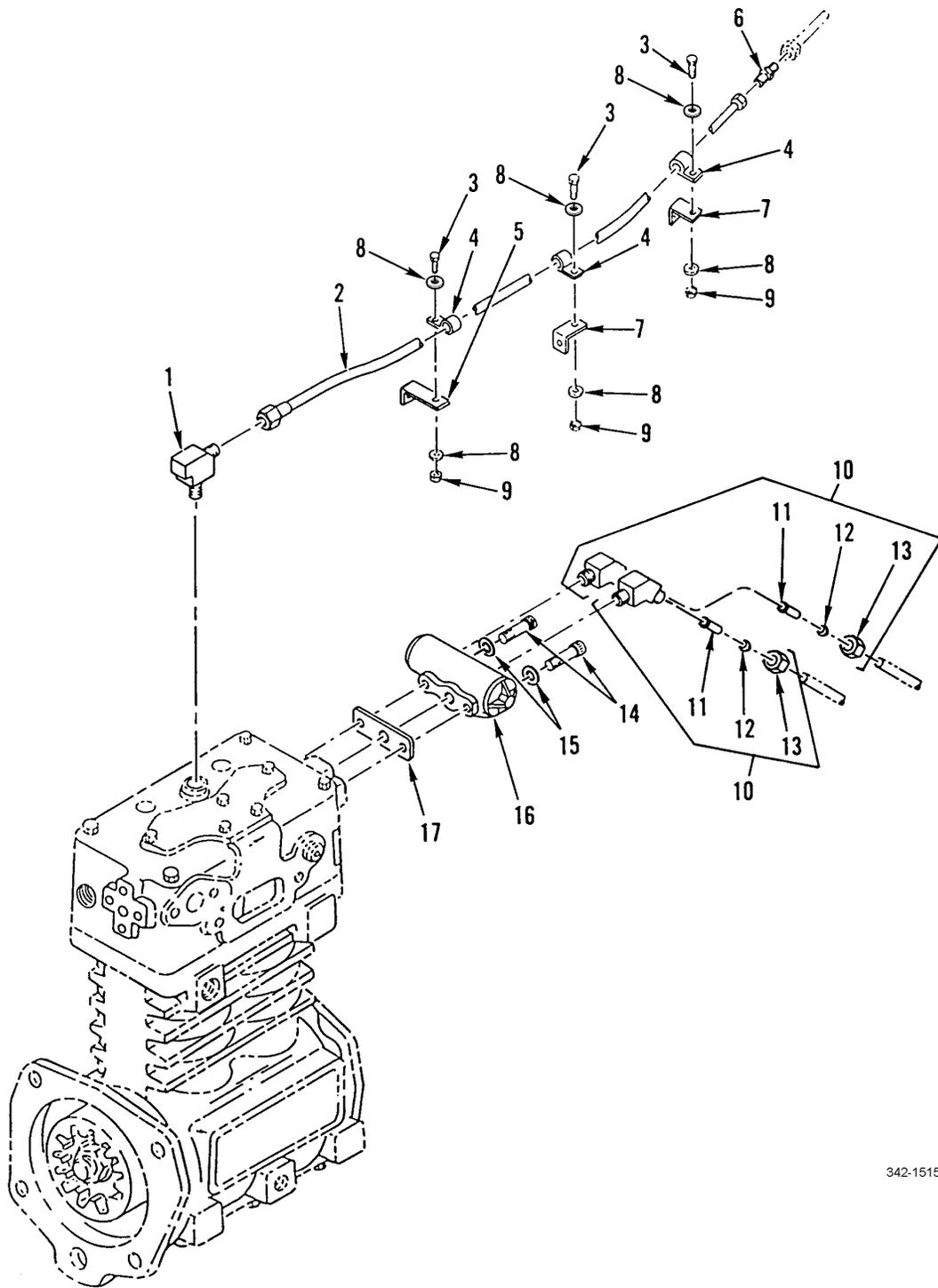

342-1515

Figure 163. Air Compressor Governor and Discharge

SECTION II			TM9-2320-302-24P			
(1)	(2)	(3)	(4)	(5)	(6)	(7)
ITEM	SMR			PART		
NO	CODE	NSN	CAGEC	NUMBER	DESCRIPTION AND USABLE ON CODES(UOC)	QTY
GROUP 1209 AIR COMPRESSOR ASSEMBLY						
FIG. 163 AIR COMPRESSOR GOVERNOR AND DISCHARGE						
1	PAOZZ	4730006139339	93061	249F-10-8	ELBOW,PIPE TO TUBE.....	1
2	PAOZZ	4720013321598	64678	A12-11593-054	HOSE ASSEMBLY,NONME.....	1
3	PAOZZ	5305002253843	80204	B1821BH025C100N	SCREW,CAP,HEXAGON H 1/4-20UNC X	3
					1.00.....	
4	PAOZZ	5340011453232	01276	900729-21	CLAMP,LOOP.....	3
5	PFOZZ	5340013284367	64678	23-09130-000	BRACKET,ANGLE 4 IN.....	1
6	PAOZZ	4730002773874	81343	10-10 010101B	NIPPLE,TUBE.....	1
7	PFOZZ	5340013284371	64678	23-09130-002	BRACKET,ANGLE 4 IN.....	2
8	PAOZZ	5310008094058	96906	MS27183-10	WASHER,FLAT .281 ID X .625 OD X	6
					.065 THK.....	
9	PAOZZ	5310000881251	81349	M45913/1-4CG5C	NUT,SELF LOCKING,HE 1/4-20UNC.....	3
10	PAOZZ	4730012275373	93061	279NTA-6-2	ELBOW,PIPE TO TUBE.....	2
11	PAOZA	4730010485260	93061	60NTA-6	.SLEEVE,COMPRESSION,.....	1
12	PAOZZ	4730010564990	93061	63NTA-6	.INSERT,TUBE FITTING.....	1
13	PAOZZ	4730010487873	93061	61NTA-6	.NUT,TUBE COUPLING.....	1
14	PAOZZ	5305013327226	64678	23-10574-275	SCREW,CAP,SOCKET HE 5/16-18.....	2
15	PAOZZ	5310001670721	96906	MS35333-41	WASHER,LOCK 5/16 NOM SIZE.....	2
16	PAOZZ	2530008275934	06853	275707	GOVERNOR ASSEMBLY,A.....	1
17	PAOZZ	5330005313197	06853	236577	GASKET.....	1

END OF FIGURE

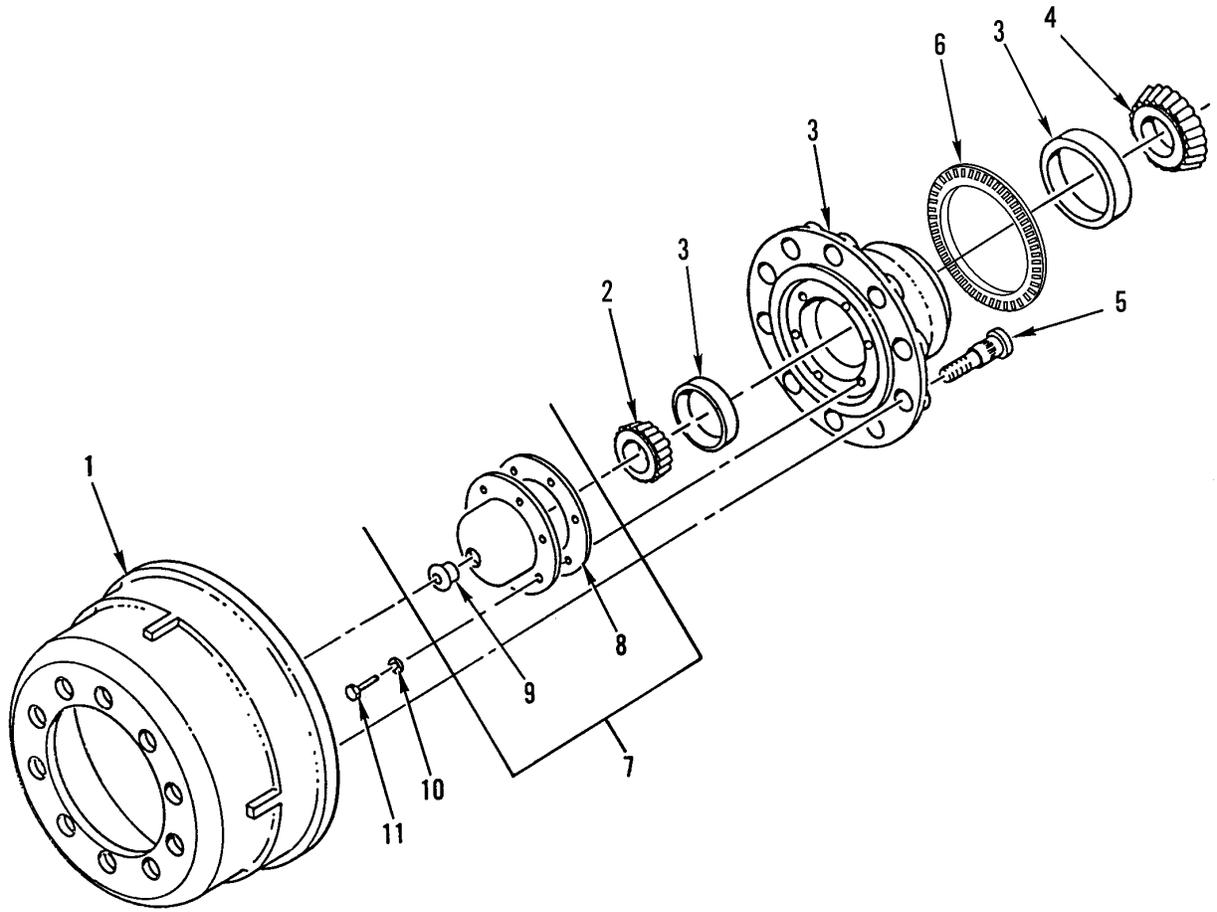

342-1516

Figure 164. Front Axle Hub Assembly

SECTION II			TM9-2320-302-24P			
(1)	(2)	(3)	(4)	(5)	(6)	(7)
ITEM	SMR			PART		
NO	CODE	NSN	CAGEC	NUMBER	DESCRIPTION AND USABLE ON CODES(UOC)	QTY
GROUP 13 WHEELS AND TRACKS						
GROUP 1311 WHEEL ASSEMBLY						
FIG. 164 FRONT AXLE HUB ASSEMBLY						
1	PAOZZ	2530014787545	73973	3800X	BRAKE DRUM FRONT LEFT AND RIGHT....	2
2	PAOZZ	3110001003104	60038	3782	CONE AND ROLLERS,TA.....	2
3	PFOZA	2530014789360	4N501	104221	HUB,WHEEL,VEHICULAR FRONT LEFT AND RIGHT.....	2
4	PAOZZ	3110002938998	60038	HM212049	CONE AND ROLLERS,TA.....	2
5	PAOZZ	5306014790176	4N501	103193	.BOLT,SHOULDER WHEEL STUD, USE 10 AT EACH WHEEL.....	10
6	PAOZA	2530014789345	4N501	103706	.SENSOR,ANTI-LOCK BR FRONT ONLY, TONE RING.....	1
7	PAOZZ	2530014240396	80201	1711	HUB CAP,WHEEL.....	2
8	PAOZZ	5330014759540	80201	450755	.GASKET.....	1
9	PAOZZ	5340012881244	80201	450434	.PLUG,PROTECTIVE,DUS.....	1
10	PAOZZ	5310009746623	96906	MS35338-140	WASHER,LOCK .318 MAX. ID X .586....	12
11	PAOZZ	5306002264825	80204	B1821BH031C075N	BOLT,MACHINE 5/16-18UNC-2A X .750..	12

END OF FIGURE

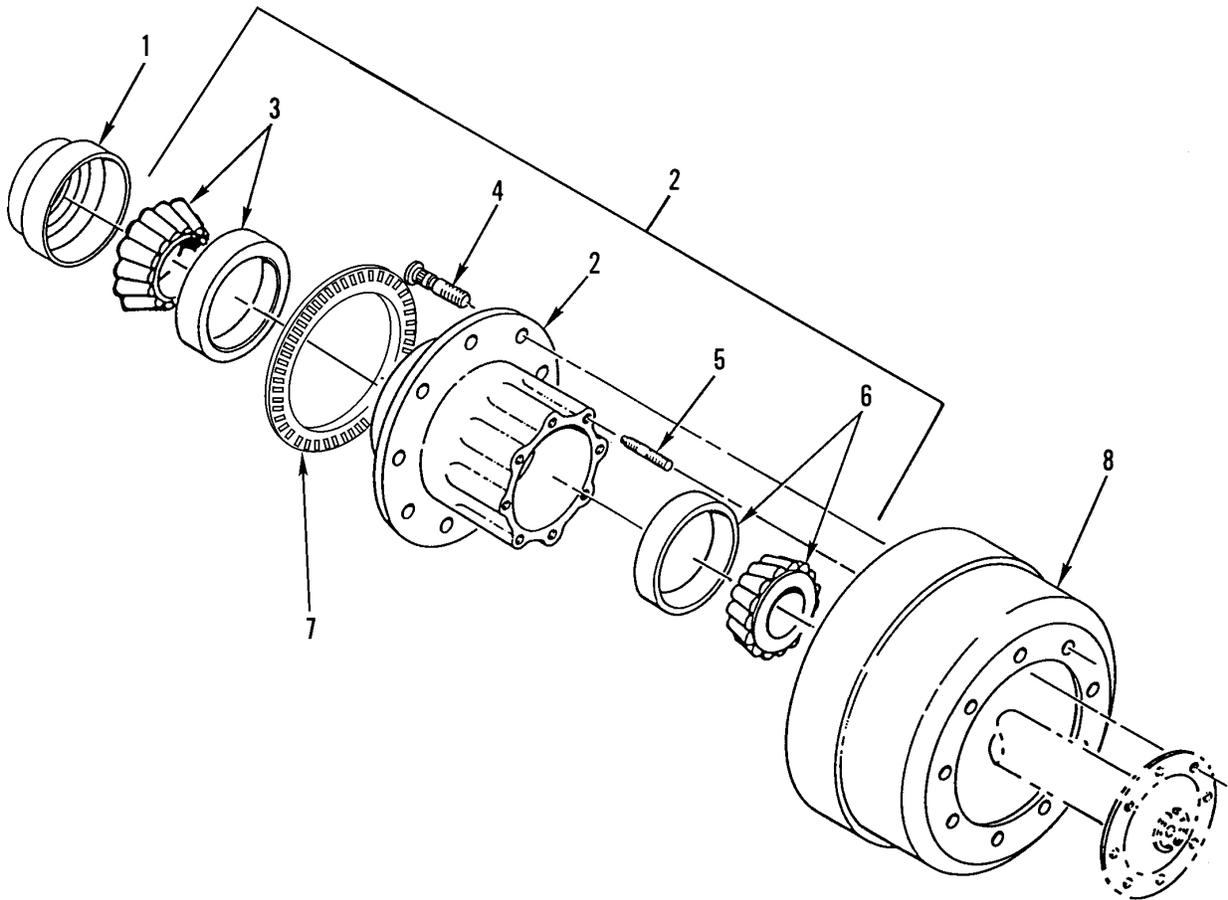

342-1521

Figure 165. Rear Axle Hub Assembly

SECTION II			TM9-2320-302-24P			
(1)	(2)	(3)	(4)	(5)	(6)	(7)
ITEM	SMR			PART		
NO	CODE	NSN	CAGEC	NUMBER	DESCRIPTION AND USABLE ON CODES(UOC)	QTY
GROUP 1311 WHEEL ASSEMBLY						
FIG. 165 REAR AXLE HUB ASSEMBLY						
1	PAOZZ	5330011171014	52304	1277701	SEAL,PLAIN ENCASED.....	4
2	PAOOO		4N501	104437	HUB,WHEEL,VEHICULAR REAR REAR,	2
					INCLUDES RACES ONLY.....	
2	PAOOF		4N501	104434	HUB,WHEEL,VEHICULAR FORWARD REAR,	2
					INCLUDES RACE ONLY.....	
3	PAOZZ	3110013311340	60038	594A-592A	.BEARING,ROLLER,TAPE.....	1
4	PAOZZ	5306014790111	4N501	102290	BOLT,SHOULDER WHEEL STUD, USE 10	10
					AT EACH WHEEL POSITION FOR FORWARD	
					AND REAR AXLES.....	
5	PAOZZ		4N501	103430	.STUD,PLAIN 8 USED AT EACH WHEEL	8
					POSITION FOR FORWARD AND REAR AXLES.	
6	PAOZZ	3110001004218	96906	MS19081-131	.BEARING,ROLLER,TAPE.....	1
7	PAOZA	2530014789211	4N501	103705	.SENSOR,ANTI-LOCK BR REAR-REAR	2
					ONLY, TONE RING.....	
8	PAOZZ	2530014411881	73972	3600AX	BRAKE DRUM.....	4

END OF FIGURE

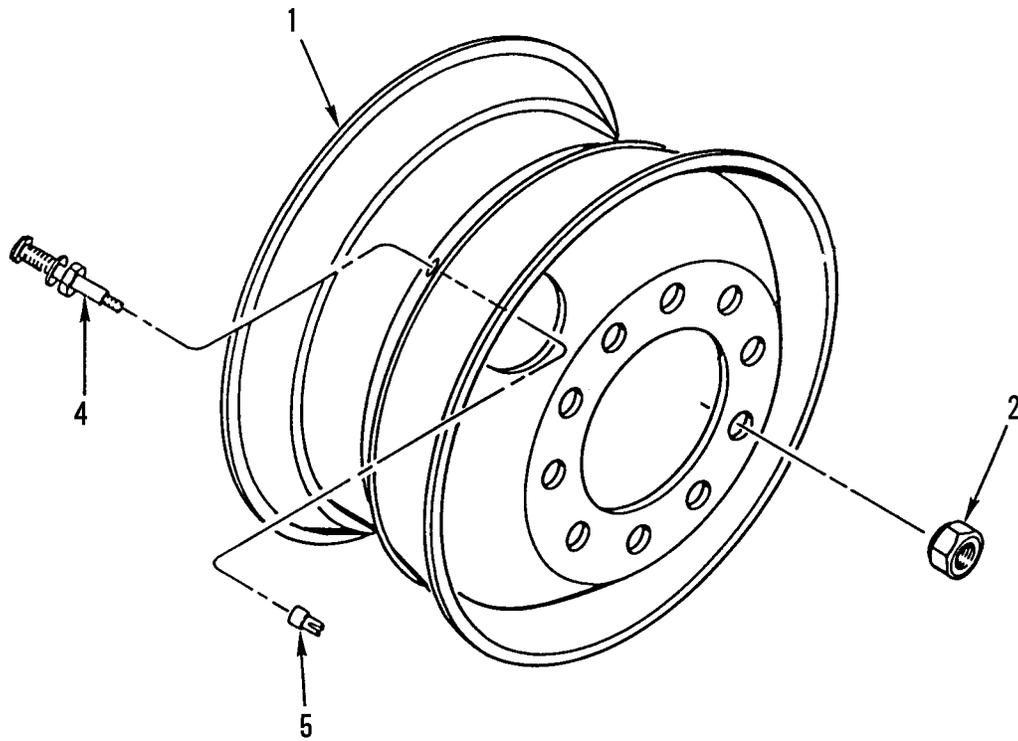
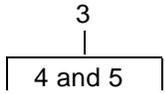

342-1522

Figure 166. Wheel Assembly

SECTION II			TM9-2320-302-24P			
(1)	(2)	(3)	(4)	(5)	(6)	(7)
ITEM	SMR			PART		
NO	CODE	NSN	CAGEC	NUMBER	DESCRIPTION AND USABLE ON CODES(UOC)	QTY
					GROUP 1311 WHEEL ASSEMBLY	
					FIG. 166 WHEEL ASSEMBLY	
1	PAOZZ	2530014787603	73195	28408PG	WHEEL,PNEUMATIC TIR.....	11
2	PAOZZ		OJRU8	333	NUT,PLAIN,ASSEMBLY WASHER M22-1.5	60
					X 33MM HEX HD, QTY 10 PER WHEEL.....	
3	PAOZZ	2640005552824	27783	TR573	VALVE,PNEUMATIC TIR.....	11
4	XDOZZ		27783	TR572-D12	.VALVE CORE.....	1
5	XDOZZ		27783	7572B	.CAP,PNEUMATIC VALVE.....	1

END OF FIGURE



342-1338

Figure 167. Tires

SECTION II			TM9-2320-302-24P			
(1)	(2)	(3)	(4)	(5)	(6)	(7)
ITEM	SMR			PART		
NO	CODE	NSN	CAGEC	NUMBER	DESCRIPTION AND USABLE ON CODES(UOC)	QTY
					GROUP 1313 TIRES, TUBES, TIRE CHAINS	
					FIG. 167 TIRES	
1	PCOHH		0A8K5	62165	TIRE,PNEUMATIC,VEHI.....	11
					END OF FIGURE	

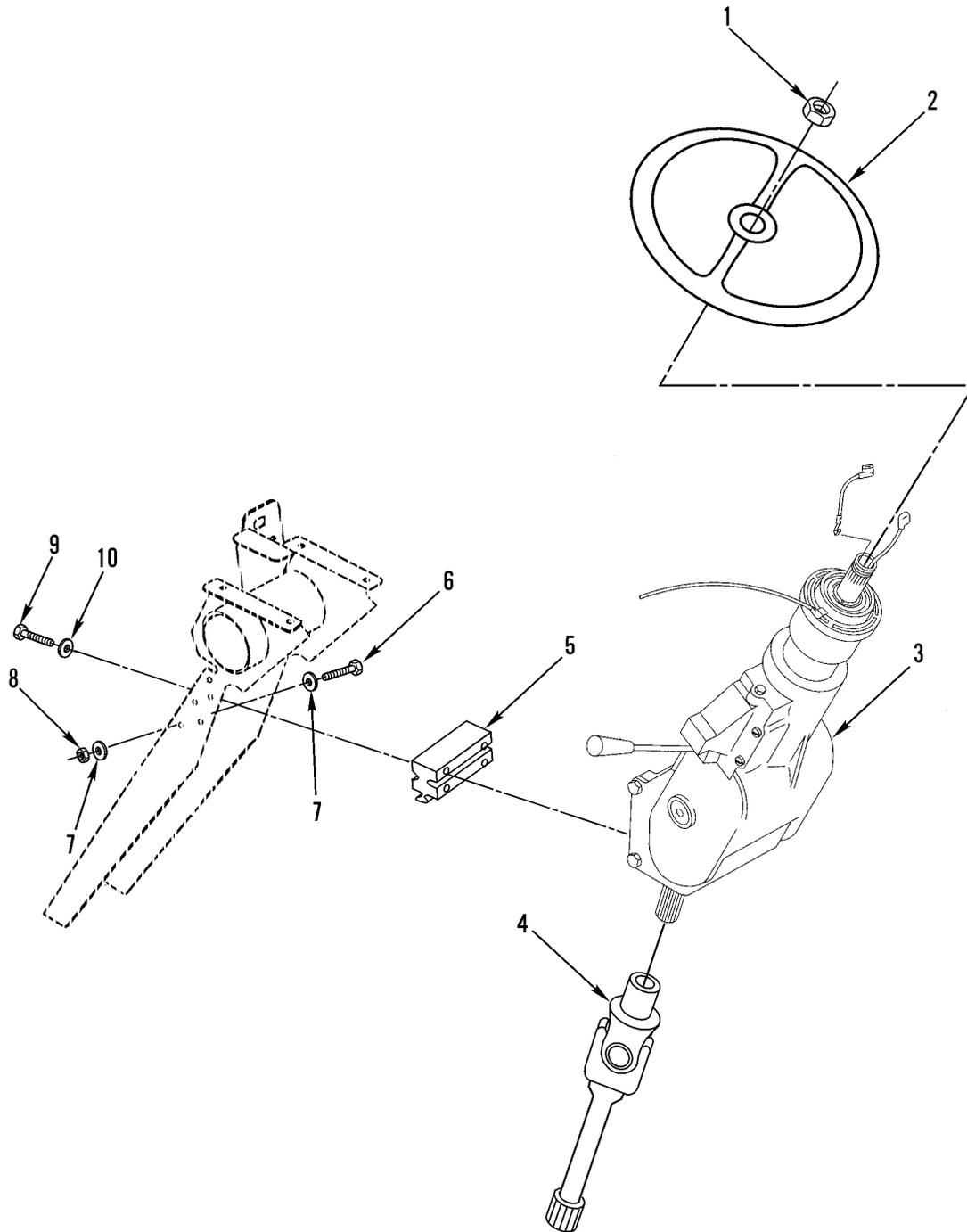

342-1519

Figure 168. Steering Column

SECTION II			TM9-2320-302-24P			
(1)	(2)	(3)	(4)	(5)	(6)	(7)
ITEM	SMR			PART		
NO	CODE	NSN	CAGEC	NUMBER	DESCRIPTION AND USABLE ON CODES(UOC)	QTY
					GROUP 14 STEERING GROUP 1401 MECHANICAL STEERING GEAR ASSEMBLY (TRACTORS, TANKS, ETC.)	
					FIG. 168 STEERING COLUMN	
1	PAOZZ	5310013319710	77640	026124	NUT, SELF-LOCKING, HE 7/8-20.....	1
2	PFOZZ	2530123522728	64678	318 464 00 01	STEERING WHEEL SEE FIG. 99 FOR HORN BUTTON.....	1
3	PAFZZ		77640	TC34055	SHAFT AND CONTROL, A.....	1
4	PAFZZ	2520014790533	77640	403851	YOKE, UNIVERSAL JOIN.....	1
5	XDFZZ		64678	18-26028-000	SPACER, SPECIAL SHAP.....	1
6	XDFZZ		64678	23-10744-450	SCREW, CAP, HEXAGON H 5/16-18 X 4.5 GR 5, ZINC.....	2
7	PAFZZ	5310008093078	96906	MS27183-11	WASHER, FLAT .312 ID X .734 OD X .065 THK.....	6
8	PAFZZ	5310009843806	81349	M45913/1-5CG5C	NUT, SELF-LOCKING, HE 5/16-18.....	2
9	PAFZZ	5305007829489	80204	B1821BH038C200N	SCREW, CAP, HEXAGON H 3/8-16 X 2.00 GR 8.....	4
10	XDFZZ		64678	23-09426-401	WASHER, FLAT, SPECIAL 3/4 OD X 3/8 ID X 0.50 THK.....	4

END OF FIGURE

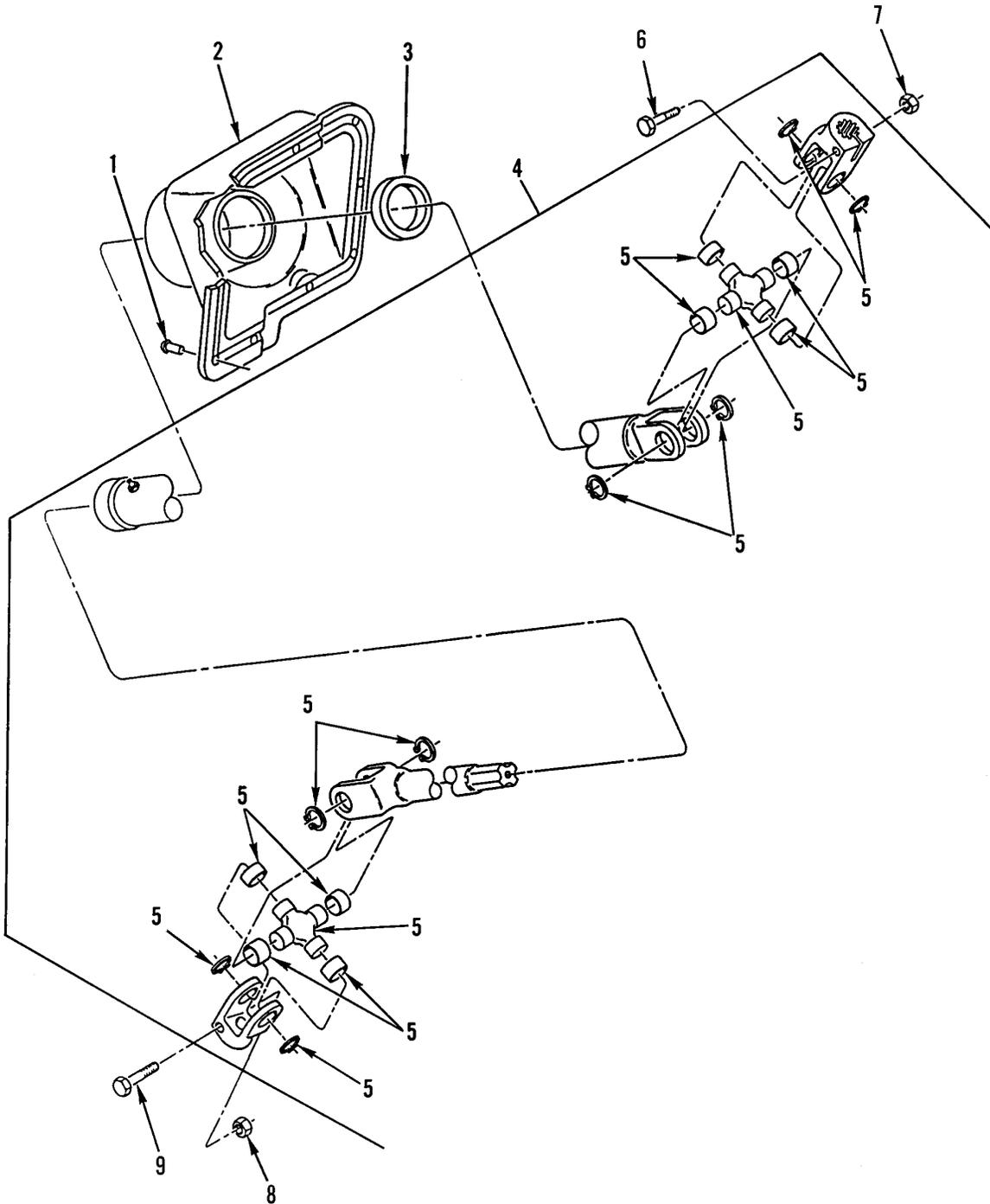

342-1300

Figure 169. Universal Shaft and Steering Boot

SECTION II			TM9-2320-302-24P			
(1)	(2)	(3)	(4)	(5)	(6)	(7)
ITEM	SMR			PART		
NO	CODE	NSN	CAGEC	NUMBER	DESCRIPTION AND USABLE ON CODES(UOC)	QTY
					GROUP 1401 MECHANICAL STEERING GEAR ASSEMBLY (TRACTORS, TANKS, ETC.)	
					FIG. 169 UNIVERSAL SHAFT AND STEERING BOOT	
1	PFOZZ	5320010562973	19738	1641-0631	RIVET,BLIND.....	10
2	PFOZZ	5340013284391	64678	14-12078-000	BOOT,DUST AND MOIST.....	1
3	PFOZZ	3120013284276	64678	14-09254-000	BUSHING,SLEEVE.....	1
4	PAOOO	2520013271298	95019	908213-24SX	PROPELLER SHAFT.....	1
5	PAOZZ	2520002946752	95019	5-170X	.SPIDER,UNIVERSAL JO.....	2
6	PAOZZ	5305013284430	64678	14-09683-000	SCREW,CLOSE TOLERAN PINCH 3/8- 16UNC X 2.....	1
7	PAOZZ	5310011511036	45152	115307A	NUT,SELF-LOCKING,EX 3/8-16.....	1
8	PAOZZ	5310013306354	1ET49	2C447622	NUT,SELF-LOCKING,HE 7/16-20 UNF, GRADE C.....	1
9	PAOZZ	5305013284388	8B911	LE871620134	SCREW,CAP,HEXAGON H 7/16-20 UNF-2A X 1.75, GR8.....	1

END OF FIGURE

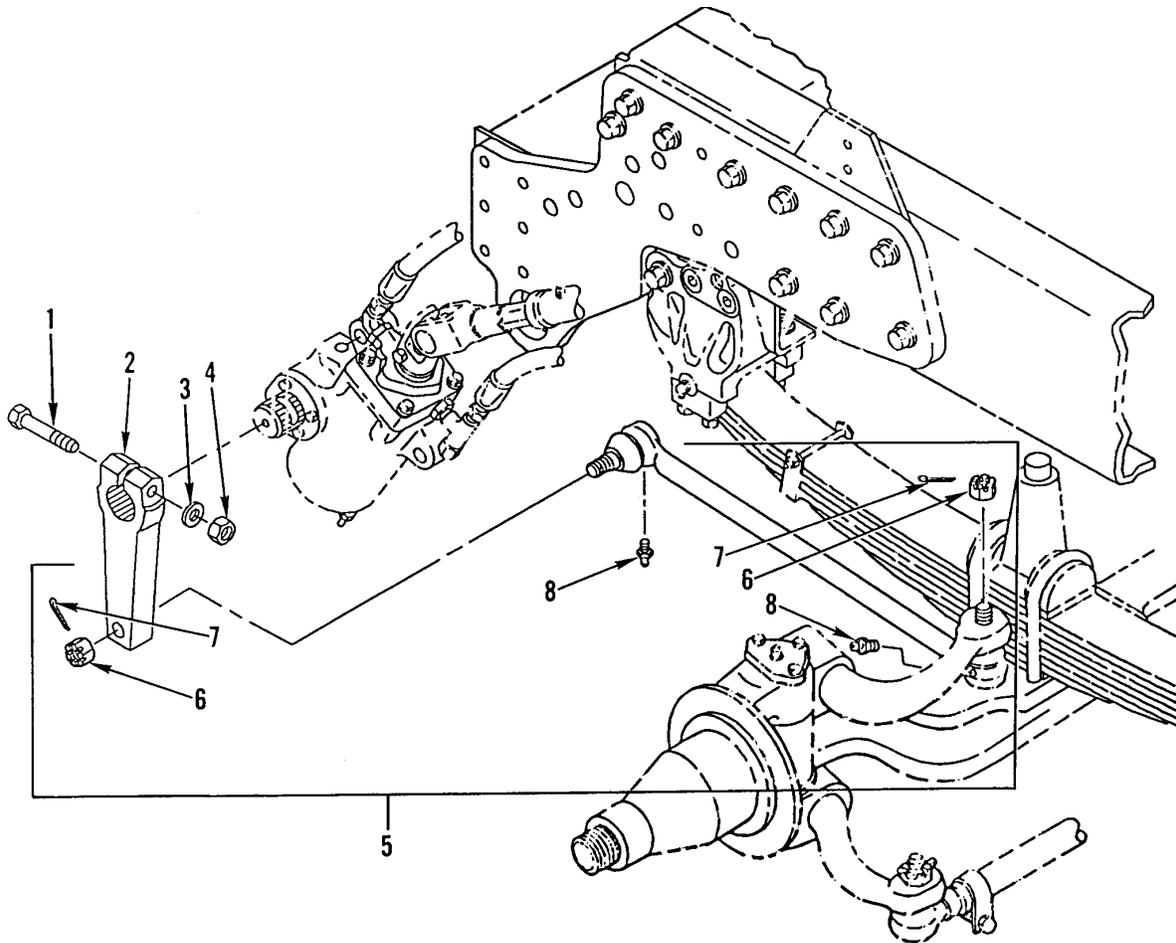

342-1301

Figure 170. Steering Linkage

SECTION II			TM9-2320-302-24P			
(1)	(2)	(3)	(4)	(5)	(6)	(7)
ITEM	SMR			PART		
NO	CODE	NSN	CAGEC	NUMBER	DESCRIPTION AND USABLE ON CODES(UOC)	QTY
					GROUP 1401 MECHANICAL STEERING GEAR ASSEMBLY (TRACTORS, TANKS, ETC.)	
					FIG. 170 STEERING LINKAGE	
1	PAOZZ	5305009037767	80204	B1821BH075F400N	SCREW,CAP,HEXAGON H 3/4-16UNC X 4.000.....	1
2	PAOZZ	2530013300030	64678	14-12007-000	PITMAN ARM,STEERING.....	1
3	PAOZZ	5310012751065	96906	MS51412-13	WASHER,FLAT.....	1
4	PAOZZ	5310008329719	96906	MS51922-61	NUT,SELF-LOCKING,HE 3/4-16UNF.....	1
5	PAOZZ	2530013300774	64678	14-10281-004	TIE ROD,STEERING INCLUDES ATTACHING HARDWARE.....	1
6	PAOZZ	5310011587840	77640	L14-MN-2	.NUT,PLAIN,SLOTTED,H 7/8-14UNF-2B THD,GR5,STL.....	2
7	PAOZZ	5315000137214	96906	MS24665-359	.PIN,COTTER 1/8 DIA X 1-3/4 LG.....	2
8	PAOZZ	4730012932939	95879	3038-B	.FITTING,LUBRICATION.....	2

END OF FIGURE

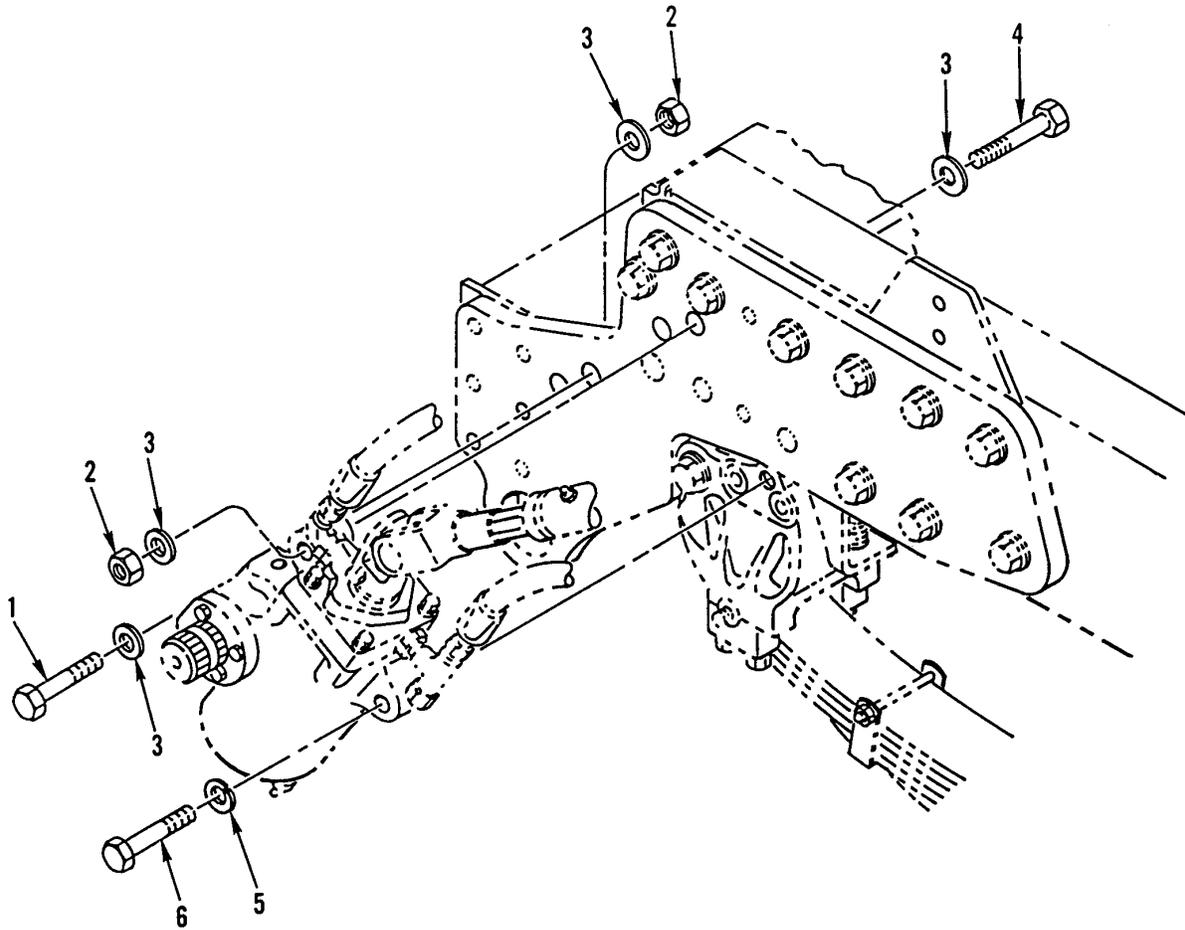

342-1302

Figure 171. Steering Gear Mounting Hardware

SECTION II			TM9-2320-302-24P			
(1)	(2)	(3)	(4)	(5)	(6)	(7)
ITEM	SMR			PART		
NO	CODE	NSN	CAGEC	NUMBER	DESCRIPTION AND USABLE ON CODES(UOC)	QTY
					GROUP 1401 MECHANICAL STEERING GEAR ASSEMBLY (TRACTORS, TANKS, ETC.)	
					FIG. 171 STEERING GEAR MOUNTING HARDWARE	
1	PAOZZ	5305012770451	80204	B1821BH088C475N	SCREW,CAP,HEXAGON H 7/8-9UNC-2A X 4.750.....	1
2	PAOZZ	5310013293700	64678	23-09901-114	NUT,PLAIN,HEXAGON THDLK,7/8-9UNC...	2
3	PAOZZ	5310008098540	96906	MS27183-25	WASHER,FLAT .938 ID X 1.75 OD X .18 THK.....	4
4	PAOZZ	5305009474350	80204	B1821BH088C550N	SCREW,CAP,HEXAGON H 7/8-9UNC-2A X 5.500.....	1
5	PAOZZ	5310009265871	96906	MS35338-147	WASHER,LOCK .890 MAX. ID X 1.464 MAX. OD.....	1
6	PAOZZ	5305011955050	80204	B1821BH088C500N	SCREW,CAP,HEXAGON H 7/8-9UNC-2A X 5.000.....	1

END OF FIGURE

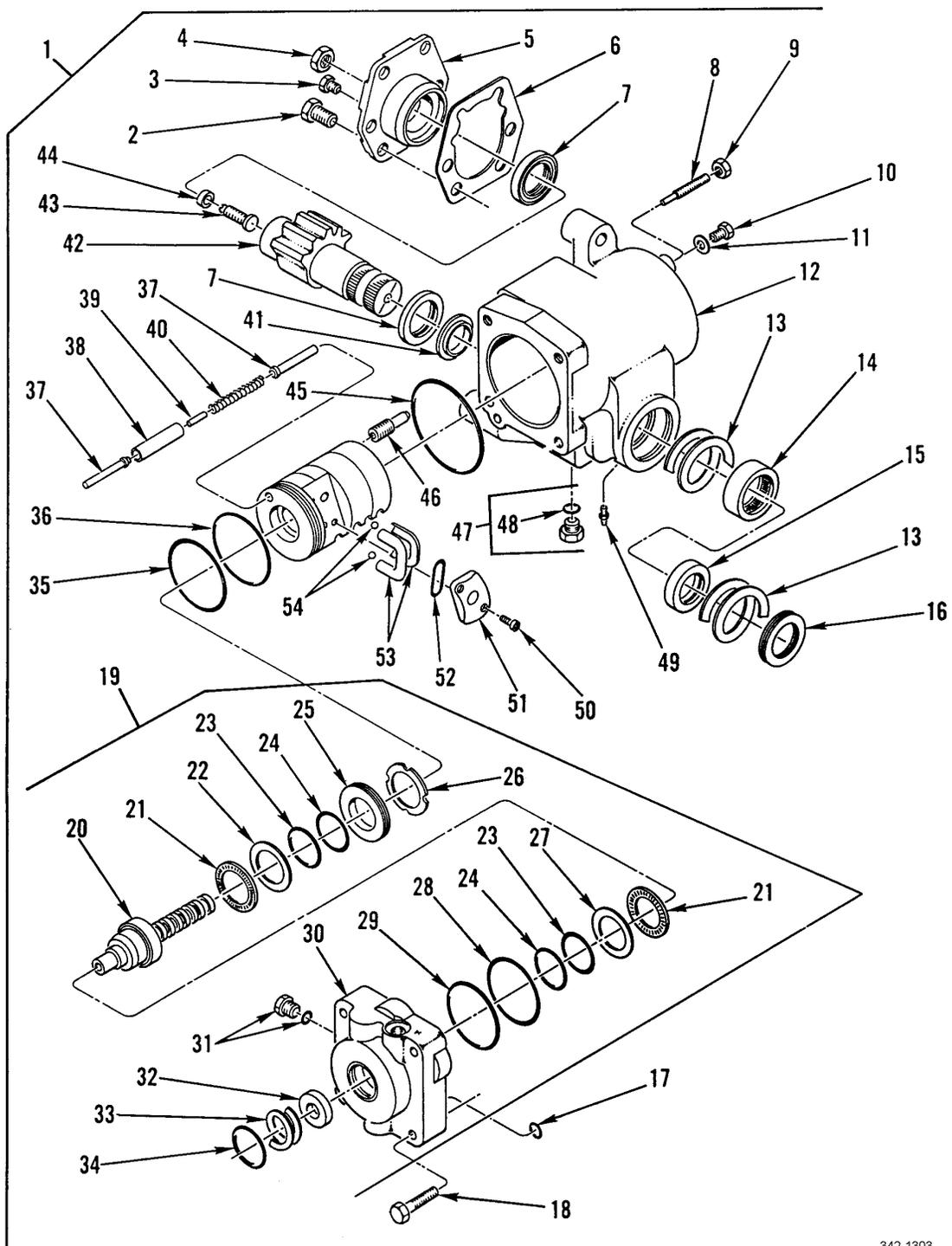

342-1303

Figure 172. Steering Gear Assembly

SECTION II			TM9-2320-302-24P			
(1)	(2)	(3)	(4)	(5)	(6)	(7)
ITEM	SMR			PART		
NO	CODE	NSN	CAGEC	NUMBER	DESCRIPTION AND USABLE ON CODES(UOC)	QTY
GROUP 1401 MECHANICAL STEERING GEAR ASSEMBLY (TRACTORS, TANKS, ETC.)						
FIG. 172 STEERING GEAR ASSEMBLY						
1	PAFFF	2530013271350	77640	TAS65004	STEERING GEAR.....	1
2	PAFZZ	5306011861052	77640	G223734	.BOLT 5/8-18 X 1.000.....	6
3	KFFZZ		77640	036201	.PLUG,VENT PART OF KIT P/N TAS650006	1
4	PAFZZ	5310005435858	77640	G9419666	.NUT,PLAIN,HEXAGON.....	1
5	PAFZZ	5340013313781	77640	TAS655002J1	.COVER,ACCESS INCLUDES SEAL AND GASKET.....	1
6	KFFZZ	5330011494415	77640	HFB649000	.GASKET PART OF KIT P/N TAS650006...	1
7	KFFZZ		77640	478040	.SEAL,OUTPUT PART OF KIT P/N TAS650006.....	2
8	KFFZZ		77640	021407	.SCREW,ADJUSTING PART OF KIT P/N 021407X1.....	1
9	KFFZZ		77640	025119	.NUT,JAM PART OF KIT P/N 021407X1...	1
10	PAFZZ	5305013284389	77640	G9426534	.SCREW,CAP,HEXAGON H.....	1
11	PAFZZ	5310013293925	77640	029119	.WASHER,FLAT.....	1
12	XAFZZ		77640	TAS652005J1	.HOUSING.....	1
13	PAFZZ	5325013317516	77640	401650	.RING,RETAINING.....	2
14	PAFZZ	3130013284447	77640	071020	.BEARING UNIT,ROLLER.....	1
15	KFFZZ		77640	478041	.SEAL PART OF KIT P/N TAS650006.....	1
16	KFFZZ		77640	478045	.SEAL PART OF KIT P/N TAS650006.....	1
17	KFFZZ		77640	032823	.O-RING PART OF KIT P/N TAS650006...	1
18	PAFZZ	5305011361619	77640	020251	.SCREW.....	4
19	XAFFF		77640	TAS653003B3	.WORM,VLV HSG.....	1
20	PAFZZ	3040013321670	77640	TAS653003S3	..WORM SHAFT INCLUDES SEALS.....	1
21	PAFZZ	3110007562022	21335	NTA2840	..RETAINER AND ROLLER.....	2
22	PAFZZ	3120013284296	77640	400144	..BEARING,WASHER,THRU.....	1
23	KFFZZ		77640	029124	..SEAL RING PART OF KIT P/N TAS650006.....	2
24	KFFZZ		77640	032200-158	..O-RING PART OF KIT P/N TAS650006..	2
25	PAFZZ	5365013294034	77640	400149	..SPACER,RING.....	1
26	KFFZZ		76640	027007	..ADJUSTER LOCKNUT SPANNER TYPE PART OF KIT P/N TAS650006.....	1
27	PAFZZ	3120013284295	77640	400143	..BEARING,WASHER,THRU.....	1
28	KFFZZ		77640	029116	..SEAL RING PART OF KIT P/N TAS650006.....	1
29	KFFZZ		77640	032200-152	..O-RING (VLV HSG) PART OF KIT P/N TAS650006.....	1
30	PFFZZ	4820013328542	77640	TAS656005A1	..BODY,VALVE INCLUDES O-RING AND SEAL.....	1
31	PAOZZ	5365011340522	07637	415437-A1	..PLUG WITH O-RING.....	1
32	KFFZZ		77640	478054	..SEAL PART OF KIT P/N TAS650006....	1
33	KFFZZ	5325000506271	77640	401637	..RING,RETAINING PART OF KIT P/N TAS650006.....	1
34	KFFZZ		77640	478044	..SEAL PART OF KIT P/N TAS650006....	1
35	PFFZZ	5331011354069	77640	032590	.O-RING PART OF KIT P/N TAS650006...	1
36	PCFZZ	5330011354068	77640	032615	.PACKING,PREFORMED PART OF KIT P/N TAS650006.....	1

SECTION II			TM9-2320-302-24P			
(1)	(2)	(3)	(4)	(5)	(6)	(7)
ITEM	SMR			PART		
NO	CODE	NSN	CAGEC	NUMBER	DESCRIPTION AND USABLE ON CODES(UOC)	QTY
37	PAFZZ	5315013284104	77640	040210	.PIN, STRAIGHT, HEADED.....	2
38	PAFZZ	5365013302164	77640	080154	.SPACER, SLEEVE.....	1
39	PAFZZ	5315013284112	77640	040209	.PIN, STRAIGHT, HEADLE.....	1
40	PAFZZ	5360013284127	77640	401662	.SPRING, HELICAL, COMP.....	1
41	PAFZZ	3110013284066	77640	028519	.BEARING, BALL, THRUST.....	1
42	PAFZZ	3040013325490	77640	HFB644100A10397	.GEARSHAFT, SECTOR, SP INCLUDES ADJUSTING SCREW AND RETAINER.....	1
43	PAFZZ	5305008992049	77640	021200	.SETSCREW 1.778 X 20UNF-2A.....	1
44	PAFZZ	2530002250680	77640	062005	.RETAINER, ADJUSTING.....	1
45	PFFZZ	5330011497229	77640	032616	.PACKING, PREFORMED PART OF KIT P/N TAS650006.....	1
46	PAFZZ	5365013306903	77640	409118A2	.SPACER, SLEEVE.....	1
47	PAOZZ	5365011340522	07637	415437-A1	.PLUG WITH O-RING.....	1
48	PCOZZ	5331011354807	77640	032229	..O-RING PART OF KIT P/N TAS650006..	2
49	PAOZZ	4730013291842	77640	037027	.FITTING, LUBRICATION.....	1
50	KFFZZ		77640	020228	.SCREW, TORX PART OF KIT P/N TAS650006.....	2
51	PAFZZ	3110013284074	77640	400161	.RETAINER, BALL, BEARI.....	1
52	KFFZZ		77640	478042	.SEAL PART OF KIT P/N TAS650006.....	1
53	KFFZZ		77640	400156	.GUIDE, BALL RETURN PART OF KIT P/N TAS650006.....	2
54	PAFZZ	3110001006152	77640	213684	.BALL, BEARING.....	32

END OF FIGURE

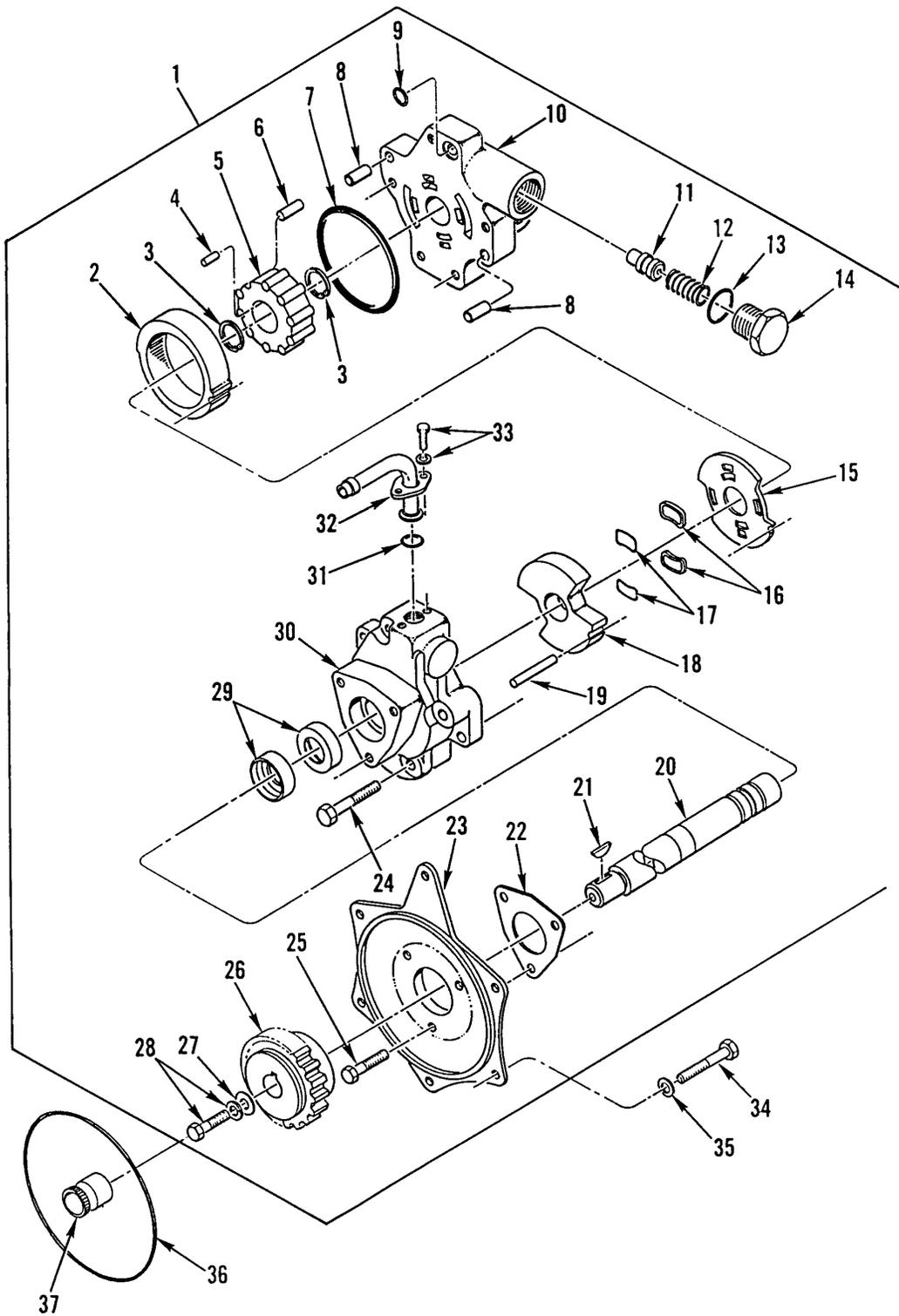

342-1304

Figure 173. Hydraulic Steering Pump

SECTION II			TM9-2320-302-24P			
(1)	(2)	(3)	(4)	(5)	(6)	(7)
ITEM	SMR			PART		
NO	CODE	NSN	CAGEC	NUMBER	DESCRIPTION AND USABLE ON CODES(UOC)	QTY
GROUP 1410 HYDRAULIC PUMP OR FLUID MOTOR ASSEMBLY						
FIG. 173 HYDRAULIC STEERING PUMP						
1	PAFFF	2530013377345	06721	N-50029-B	PUMP ASSEMBLY,POWER.....	1
2	KFFZZ		06721	ER-42485	.CAM PART OF KIT P/N ERS-28310.....	1
3	PAFZZ	5325012657251	47457	20510093-20Z	.RING,RETAINING.....	2
4	KFFZZ		06721	ER-92739-069	.PIN,DRIVE SQUARE END PART OF KIT P/N ERS-28310.....	1
5	KFFZZ		06721	ER-42549	.CARRIER PART OF KIT P/N ERS-28310..	1
6	KFFZZ		06721	ER-42185	.ROLLS PART OF KIT P/N ERS-28310....	10
7	KFFZZ		06721	ER-8913-041	.O-RING PART OF KIT P/N 20510093-25Z	1
8	PAFZZ	5315011753916	19954	ER-90101-075	.PIN,STRAIGHT,HEADLE SQUARE END....	2
9	KFFZZ		06721	ER-8913-015	.O-RING PART OF KIT P/N 20510093-25Z	1
10	XAFZZ		06721	ERS-28395.	.HOUSING,BEARING UNI.....	1
11	PAFZZ	4820013300547	19954	ER-27856-210	.VALVE,SAFETY RELIEF.....	1
12	PAFZZ	5360008111609	81118	ER7614	.SPRING,HELICAL,COMP.....	1
13	KFFZZ		06721	ER-8913-211	.O-RING PART OF KIT P/N 20510093-25Z	1
14	PAFZZ	4820002299917	19954	ER-7621	.CAP,VALVE.....	1
15	KFFZZ		06721	ER-99562	.PLATE,PORT PART OF KIT P/N ERS- 28310.....	1
16	KFFZZ		06721	ER-82143	.SEAL PART OF KIT P/N 20510093-25Z..	2
17	KFFZZ		06721	ER-8913-028	.O-RING PART OF KIT P/N 20510093-25Z	2
18	XDFZZ		06721	ERS-99563	.PLATE,END.....	1
19	KFFZZ		06721	ER-99620	.PIN,LOCATING PART OF KIT P/N ERS- 28310.....	1
20	PAFZZ	3040013299878	19954	ER-62793	.SHAFT,SHOULDERED.....	1
21	PAFZZ	5315011753907	19954	ER-9476	.KEY,WOODRUFF.....	1
22	PAFZZ	5330012719407	47457	20510093-4Z	.GASKET.....	1
23	PFFZZ	4320013295101	06721	ER-99969	.COVER,HYDRAULIC,PUM.....	1
24	PAFZZ	5305013284390	06721	ERS91381-250	.SCREW,CAP,HEXAGON H.....	5
25	PAFZZ	5306013293695	06721	ERS85120-088	.BOLT,MACHINE 3/8-16 UNC X 7/8.....	3
26	PAFZZ	3020013300034	64678	ER-42534	.SPROCKET WHEEL.....	1
27	PAFZZ	5310002310280	19207	11664241	.WASHER,FLAT.....	1
28	PAFZZ	5305011409118	80204	B1821BH038C088N	.SCREW,CAP,HEXAGON H 3/8-16UNC-2A X .875.....	1
29	KFFZZ		06721	ER-82349	.SEAL PART OF KIT P/N 20510093-25Z..	2
30	XAFZZ		06721	ERS-28598.	.HOUSING,LIQUID PUMP.....	1
32	PAFZZ	4710013291585	64678	HE1260034	.TUBE AND FITTINGS,M.....	1
33	PAFZZ	5306011742553	19954	ER-91153-088	.BOLT 5/16-18 UNC X 7/8.....	2
34	PAFZZ	5306012708909	15526	DIN933-M8-1.25X2 0-8.8-A4C	BOLT,MACHINE DIN933, M8X20, GR 808, DBL 8451.22.....	6
35	PAFZZ	5310013343646	64678	000127 008203	WASHER,LOCK DIN N12004, A8.....	6
36	PAFZZ	5330013347187	72582	8929318	SEAL,PLAIN.....	1
37	PAFZZ	3010009324813	72582	5143616	COUPLING,SHAFT,FLEX.....	1

END OF FIGURE

8	12	14
9	13	15

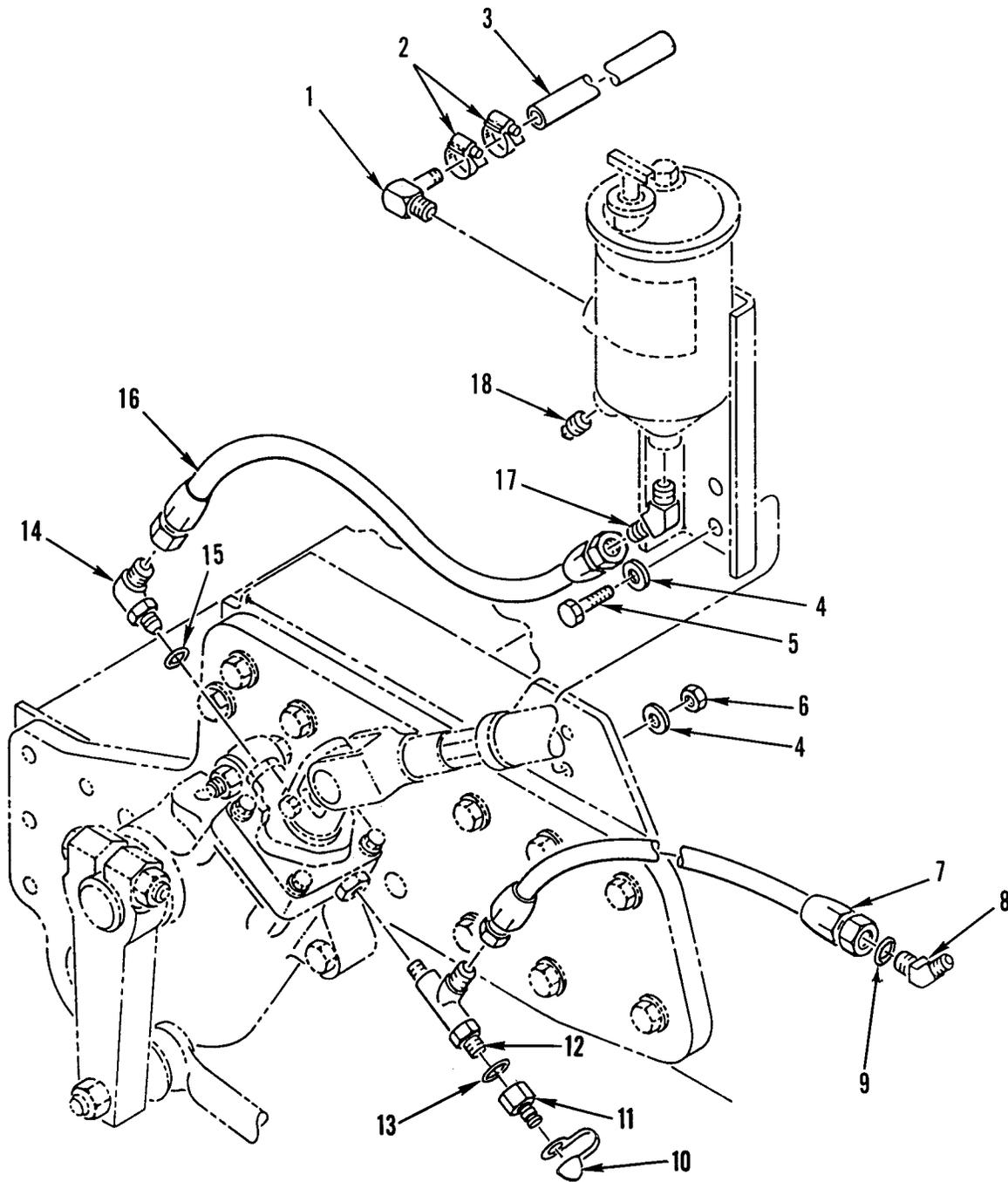

342-1305

Figure 174. Steering Lines and Fittings

SECTION II			TM9-2320-302-24P			
(1)	(2)	(3)	(4)	(5)	(6)	(7)
ITEM	SMR			PART		
NO	CODE	NSN	CAGEC	NUMBER	DESCRIPTION AND USABLE ON CODES(UOC)	QTY
GROUP 1411 HOSES, LINES, FITTINGS						
FIG. 174 STEERING LINES AND FITTINGS						
1	PAOZZ	4730013292139	64678	23-09340-001	ELBOW,PIPE TO HOSE 90 DEG 12MPT X 12 HOSE.....	1
2	PAOZZ	4730009083194	96906	MS35842-11	CLAMP,HOSE .688 TO 1.250 ID.....	2
3	MOOZZ		64678	48-02015-012X24	HOSE,RUBBER MAKE FROM CAGE 98441, PN 881-12,24 IN.....	2
4	PAOZZ	5310011091977	19207	11628332-2	WASHER,FLAT .531 ID X 1.062 OD X .18 THK.....	4
5	PAOZZ	5305000712071	80204	B1821BH050C200N	SCREW,CAP,HEXAGON H 1/2-13UNC-2A X 2.000.....	2
6	PAOZZ	5310002256993	96906	MS51922-33	NUT,SELF-LOCKING,HE 1/2-13UNC.....	2
7	PAOZZ	4720013291299	64678	A23-12005-021	HOSE ASSEMBLY,NONME MEDIUM PRESSURE, 37 JIC, SPCL.....	1
8	PAOZZ	4730012702477	30780	8V6X-S	ELBOW,TUBE.....	1
9	PAOZZ	5331009298171	02697	3-908N552-90	.O-RING.....	1
10	PAOZZ	5340012630821	57760	PD6	CAP,PROTECTIVE,DUST.....	1
11	PFOZZ	4220013300663	97111	PD38BTX	ADAPTER,QUICK CONNE PRESSURE TEST POINT.....	1
12	PAOZZ	5331013286016	30780	053T-8-8	O-RING TEE FITTING WITH O-RING.....	1
13	PAOZZ	5331009298171	02697	3-908N552-90	.O-RING.....	1
14	PAOZZ	4730010884453	01276	2062-8-10S	ELBOW,TUBE TO BOSS.....	1
15	PAOZZ	5331009298171	02697	3-908N552-90	.O-RING.....	1
16	PAOZZ	4720013291298	64678	A23-11771-016	HOSE ASSEMBLY,NONME NO. 10 JIC37 16 IN.....	1
17	PAOZZ	4730013292141	93601	VS3103-8-10	ELBOW,PIPE TO TUBE.....	1
18	PAOZZ	4730007026932	78500	P18	PLUG,PIPE.....	1

END OF FIGURE

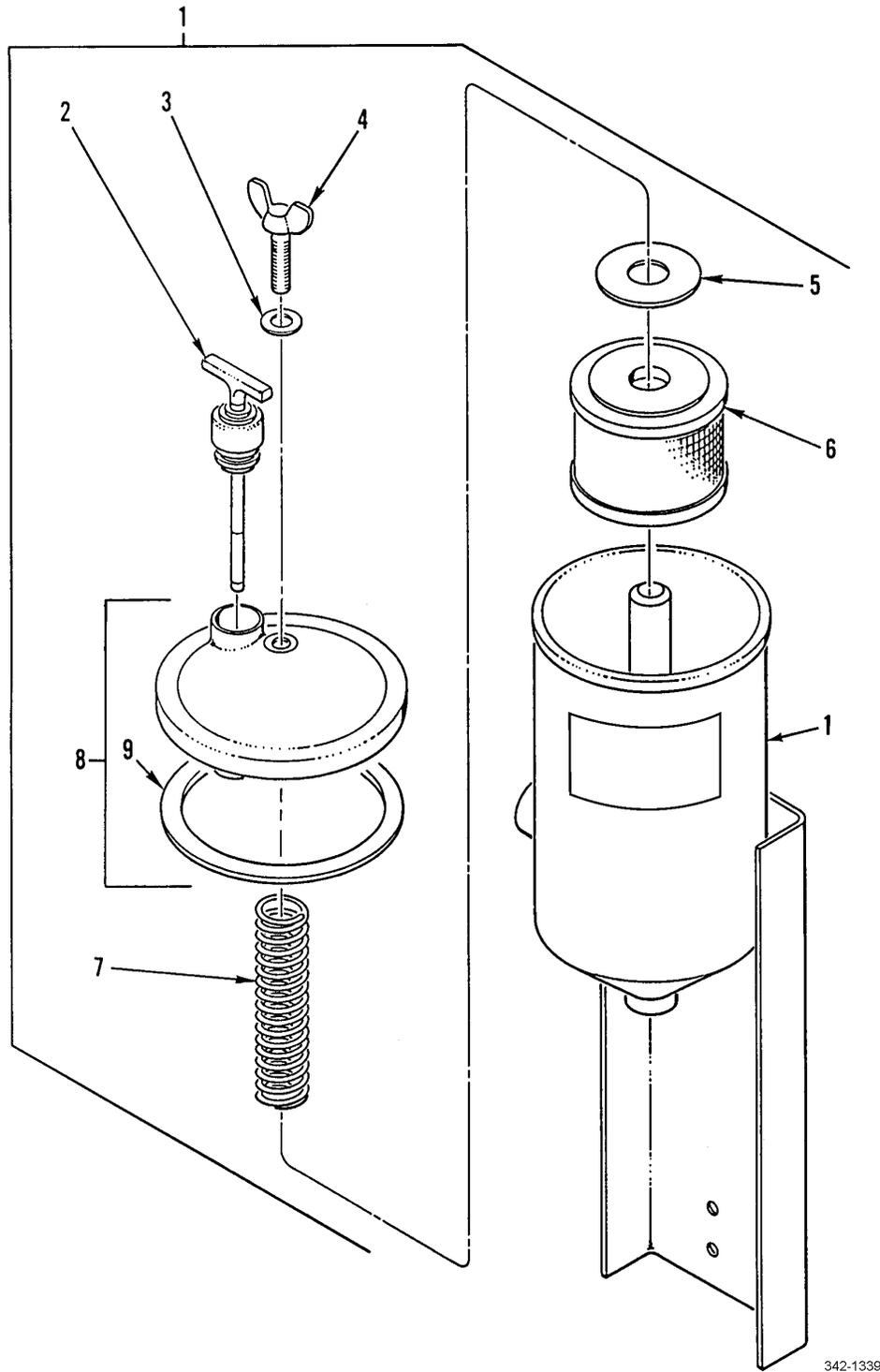

342-1339

Figure 175. Reservoir Assembly and Bracket

SECTION II			TM9-2320-302-24P			
(1)	(2)	(3)	(4)	(5)	(6)	(7)
ITEM	SMR			PART		
NO	CODE	NSN	CAGEC	NUMBER	DESCRIPTION AND USABLE ON CODES(UOC)	QTY
GROUP 1413 TANKS, RESERVOIRS						
FIG. 175 RESERVOIR ASSEMBLY AND BRACKET						
1	PAOOO	2530013277713	64678	A14-12093-000	RESERVOIR,PUMP ASSE.....	1
2	PAOZZ	6680013308259	0U276	42365	.GAGE ROD-CAP,LIQUID.....	1
3	PAOZZ	3120013296626	76700	Q66214	.BEARING,WASHER,THRU .394 ID X .757 OD X .125 THK.....	1
4	PAOZZ	5305013284246	76700	Q53670	.THUMBSCREW 3/8-16UNC X 1 1/2.....	1
5	PAOZZ	5310013391331	76700	Q66957	.WASHER,FLAT .828 ID X 2.25 OD X .134 THK.....	1
6	PAOZZ	4330013308203	76700	83213D	.FILTER ELEMENT,FLUI.....	1
7	PAOZZ	5360013284128	76700	Q63135	.SPRING,HELICAL,COMP.....	1
8	PFOZZ	4330013298821	76700	Q80381	.COVER,FLUID FILTER.....	1
9	PAOZZ	5330013581289	76700	Q-59278	..GASKET.....	1

END OF FIGURE

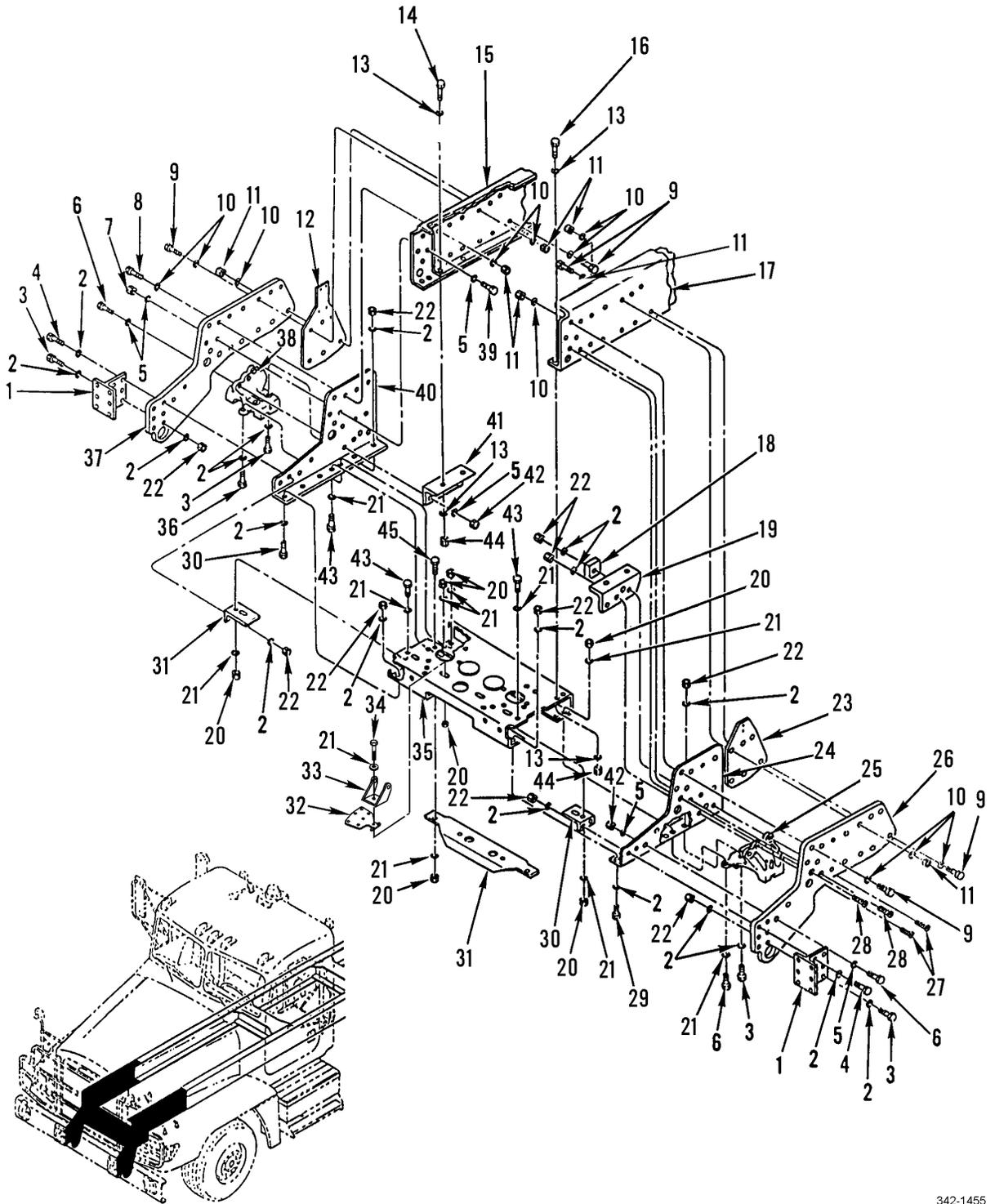

342-1455

Figure 176. Forward Frame Assembly

SECTION II			TM9-2320-302-24P			
(1)	(2)	(3)	(4)	(5)	(6)	(7)
ITEM	SMR			PART		
NO	CODE	NSN	CAGEC	NUMBER	DESCRIPTION AND USABLE ON CODES(UOC)	QTY
GROUP 15 FRAME, TOWING ATTACHMENTS, DRAWBARS, AND ARTICULATION SYSTEMS GROUP 1501 FRAME ASSEMBLY						
FIG. 176 FORWARD FRAME ASSEMBLY						
1	XDHZZ		64678	21-26182-010	BRACKET,VEHICULAR B INSIDE RH & LH.	2
1	XDHZZ		64678	21-26182-020	BRACKET,VEHICULAR B OUTSIDE RH & LH	2
2	PAHZZ	5310007208819	96906	MS15795-821	WASHER,FLAT 0.688 ID X 1.75 OD.....	42
3	PAHZZ	5305007247224	80204	B1821BH063C250N	SCREW,CAP,HEXAGON H 5/8-11UNC-2A X 2.50.....	12
4	PAHZZ	5305007247228	80204	B1821BH063C300N	SCREW,CAP,HEXAGON H 5/8-11UNC-2A X 3.00.....	6
5	PAHZZ	5310008098540	96906	MS27183-25	WASHER,FLAT 0.938 ID X 1.75 OD X 0.18 THK.....	12
6	PAHZZ	5305009640512	80204	B1821BH088C275N	SCREW,CAP,HEXAGON H 7/8-9UNC-2A X 2.75.....	5
7	PAHZZ	5310013293700	64678	23-09901-114	NUT,PLAIN,HEXAGON.....	1
8	PAHZZ	5305013088195	80205	MS24671-90	SCREW,CAP,SOCKET HE 5/8-11X2.75.....	1
9	PAHZZ	5305009908400	80204	B1821BH100C350N	SCREW,CAP,HEXAGON H 1.00-8UNC X 3.50.....	21
10	PAHZZ	5310013367579	64678	23-09114-008	WASHER,FLAT 1.0 2.0 0.18THK....	48
11	PAHZZ	5310013369850	64678	23-09901-116	NUT,SELF-LOCKING,HE 1.0-8UNC.....	25
12	XDHZZ		64678	15-15185-000	SPACER,PLATE.....	1
13	PAHZZ	5310011091977	19207	11628332-2	WASHER,FLAT 0.531 ID X 1.062 OD X 0.18 THK.....	16
14	PAHZZ	5305000712070	80204	B1821BH050C175N	SCREW,CAP,HEXAGON H 1/2-13UNC-2A X 1.75.....	8
15	XDHZZ		64678	15-12129-446	RAIL,FRAME,STEEL R.H. (WHEN ORDERING INCLUDE VEHICLE SERIAL NO.)	1
16	PAHZZ	5305000712070	80204	B1821BH050C175N	SCREW,CAP,HEXAGON H.....	4
17	XDHZZ		64678	15-12128-446	RAIL,FRAME,STEEL L.H. (WHEN ORDERING INCLUDE VEHICLE SERIAL NO.)	1
18	PFHZZ	5340013366665	64678	15-12186-000	PLATE,MOUNTING.....	1
19	PFHZZ	5340013365953	64678	15-12185-000	BRACKET,ANGLE.....	1
20	PAHZZ	5310002256993	96906	MS51922-33	NUT,SELF-LOCKING,HE 1/2-13UNC.....	14
21	PAHZZ	5310011091977	19207	11628332-2	WASHER,FLAT 0.531 ID X 1.062 OD X 0.18 THK.....	20
22	PAHZZ	5310002694040	96906	MS51922-49	NUT,SELF-LOCKING,HE 5/8-11UNC.....	22
23	PFHZZ	5365013370371	64678	15-13553-000	SPACER,PLATE.....	1
24	PFHZZ	5340013365954	64678	15-13541-000	BRACKET,ANGLE.....	1
25	PFHZZ	2590013370426	64678	15-12182-003	BRACKET,VEHICULAR C RIGHT.....	1
26	XDHZZ	2510013476082	64678	15-13538-000	FRAME SECTION,STRUC.....	1
27	PAHZZ	5305013387295	64678	23-09614-375	SCREW,CAP,SOCKET HE 5/8-11UNC X 3.75.....	1
28	PAHZZ	5305009572395	96906	MS16997-233	SCREW,CAP,SOCKET HE.....	2
29	PAHZZ	5305007247221	80204	B1821BH063C175N	SCREW,CAP,HEXAGON H 5/8-11UNC-2A X 1.75.....	2
30	PFHZZ	5340013365957	64678	15-12644-000	BRACKET,DOUBLE ANGL.....	1
31	PFHZZ	2510013384486	64678	15-12643-000	FRAME SECTION,STRUC.....	2
32	PAHZZ	5310013293928	64678	17-10133-000	WASHER,FLAT.....	2
33	PAHZZ	5340013293863	64678	17-10425-002	HINGE,STRAP.....	2

SECTION II			TM9-2320-302-24P			
(1)	(2)	(3)	(4)	(5)	(6)	(7)
ITEM	SMR			PART		
NO	CODE	NSN	CAGEC	NUMBER	DESCRIPTION AND USABLE ON CODES(UOC)	QTY
34	PAHZZ	5305000712071	80204	B1821BH050C200N	SCREW,CAP,HEXAGON H 1/2-13UNC-2A X 2.00.....	2
35	PFHZZ	5340013366976	64678	A15-13551-000	BRACKET,MOUNTING.....	1
36	PAHZZ	5305000712072	80204	B1821BH050C225N	SCREW,CAP,HEXAGON H 1/2-13UNC-2A X 2.25.....	2
37	XDHZZ		64678	15-13538-002	FRAME SECTION,STRUC.....	1
38	PFHZZ	2590013370425	64678	15-12182-000	BRACKET,VEHICULAR C LEFT.....	1
39	PAHZZ	5305011387735	80204	B1821BH088C350N	SCREW,CAP,HEXAGON H 7/8-9UNC X 3.50	1
40	PFHZZ	5340013371034	64678	15-13541-001	BRACKET,ANGLE.....	1
41	PFHZZ	5340013371033	64678	15-12185-001	BRACKET,ANGLE.....	1
42	PAHZZ	5310013293700	64678	23-09901-114	NUT,PLAIN,HEXAGON 7/8-9UNC.....	5
43	PAHZZ	5305000712069	80204	B1821BH050C150N	SCREW,CAP,HEXAGON H.....	6
44	PAHZZ	5310002256993	96906	MS51922-33	NUT,SELF-LOCKING,HE 1/2-13UNC.....	8
45	PAHZZ	5305013374267	64678	23-12008-125	SCREW,MACHINE 1/2-13UNC X 1.25.....	4

END OF FIGURE

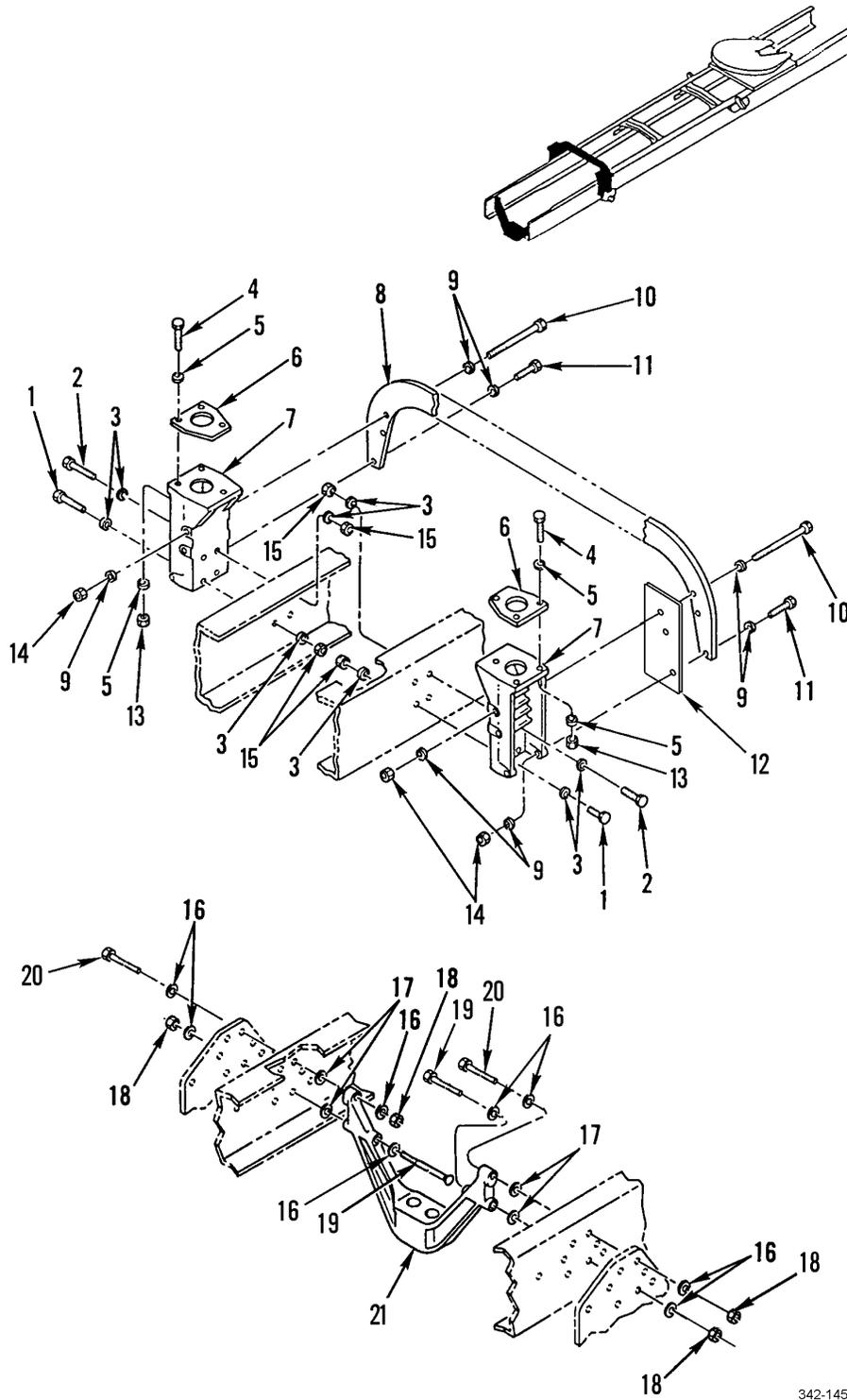

342-1456

Figure 177. Overslung Crossmember and Front Engine Mounting

SECTION II			TM9-2320-302-24P			
(1)	(2)	(3)	(4)	(5)	(6)	(7)
ITEM	SMR			PART		
NO	CODE	NSN	CAGEC	NUMBER	DESCRIPTION AND USABLE ON CODES(UOC)	QTY
GROUP 1501 FRAME ASSEMBLY						
FIG. 177 OVERSLUNG CROSSMEMBER AND FRONT ENGINE MOUNTING						
1	PAFZZ	5305007247223	80204	B1821BH063C225N	SCREW,CAP,HEXAGON H 5/8-11 X 2.25..	6
2	PAFZZ	5305007247228	80204	B1821BH063C300N	SCREW,CAP,HEXAGON H 5/8-11 X 3.00..	2
3	PAFZZ	5310007208819	96906	MS15795-821	WASHER,FLAT .688 ID X 1.75 OD.....	16
4	PAFZZ	5305008213869	80204	B1821BH038C175N	SCREW,CAP,HEXAGON H 3/8-16 X 1.75..	6
5	PAFZZ	5310007737618	96906	MS15795-814	WASHER,FLAT.....	12
6	PAFZZ	5340014066966	64678	A15-14555-000	PLATE,MOUNTING FRONT.....	4
7	PFFZZ	5340013367829	64678	15-12621-000	BRACKET,MOUNTING.....	2
8	PGFZZ		64678	15-13915-001	FRAME SECTION,STRUC.....	1
9	PAFZZ	5310011091977	19207	11628332-2	WASHER,FLAT .531 ID X 1.062 OD X .18 THK.....	12
10	PAFZZ	5305013366838	64678	23-09440-800	SCREW,CAP,HEXAGON H 1/2-13 X 8.00..	6
11	PAFZZ	5305000712073	80204	B1821BH050C250N	SCREW,CAP,HEXAGON H 1/2-13 X 2.50..	2
12	XDFZZ		64678	15-14661-000	SPACER,PLATE.....	2
13	PAFZZ	5310000874652	96906	MS51922-17	NUT,SELF-LOCKING,HE.....	6
14	PAFZZ	5310002256993	96906	MS51922-33	NUT,SELF-LOCKING,HE 1/2-13UNC.....	6
15	PAFZZ	5310002694040	96906	MS51922-49	NUT,SELF-LOCKING,HE 5/8-11UNC.....	8
16	PAHZZ	5310007208819	96906	MS15795-821	WASHER,FLAT .688 ID X 1.75 OD.....	8
17	PAHZZ	5310013370370	64678	23-11812-012	WASHER,FLAT 5/8 X .12 THK.....	4
18	PAHZZ	5310002694040	96906	MS51922-49	NUT,SELF-LOCKING,HE 5/8-11UNC.....	4
19	PAHZZ	5306013446714	45152	62411AX	BOLT,MACHINE 5/8-11 X 8.50.....	2
20	PAHZZ	5305007247266	80204	B1821BH063C500N	SCREW,CAP,HEXAGON H 5/8-11 X 5.00..	2
21	PFHZZ		64678	01-23292-000	BRACKET,ENGINE MOUN.....	1

END OF FIGURE

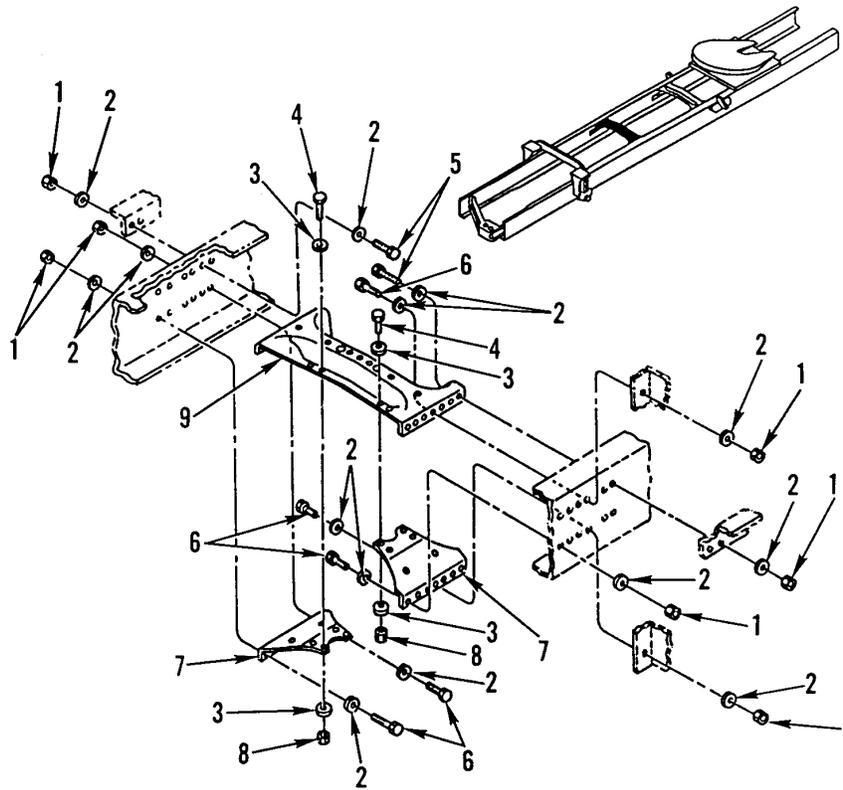

342-1457

Figure 178. Cab Alligator Crossmember

SECTION II			TM9-2320-302-24P			
(1)	(2)	(3)	(4)	(5)	(6)	(7)
ITEM	SMR			PART		
NO	CODE	NSN	CAGEC	NUMBER	DESCRIPTION AND USABLE ON CODES(UOC)	QTY
GROUP 1501 FRAME ASSEMBLY						
FIG. 178 CAB ALLIGATOR CROSSMEMBER						
1	PAHZZ	5310002694040	96906	MS51922-49	NUT, SELF-LOCKING, HE 5/8-11 X 0.55..	18
2	PAHZZ	5310007208819	96906	MS15795-821	WASHER, FLAT .69 X 1.31 X .177.....	36
3	PAHZZ	5310011091977	19207	11628332-2	WASHER, FLAT .531 ID X 1.062 OD X .18 THK.....	16
4	PAHZZ	5305007247220	80204	B1821BH063C150N	SCREW, CAP, HEXAGON H 5/8-11UNC X 1.50.....	8
5	PAHZZ	5305007247223	80204	B1821BH063C225N	SCREW, CAP, HEXAGON H 5/8-11 X 2.25..	4
6	PAHZZ	5305007247222	80204	B1821BH063C200N	SCREW, CAP, HEXAGON H 5/8-11UNC X 2.00.....	14
7	PGHZZ		64678	15-15636-001	FRAME SECTION, STRUC.....	2
8	PAHZZ	5310002256993	96906	MS51922-33	NUT, SELF-LOCKING, HE 1/2-13UNC.....	8
9	PAHZZ	5340013382907	64678	A15-12169-002	BRACKET, MOUNTING CAB.....	1

END OF FIGURE

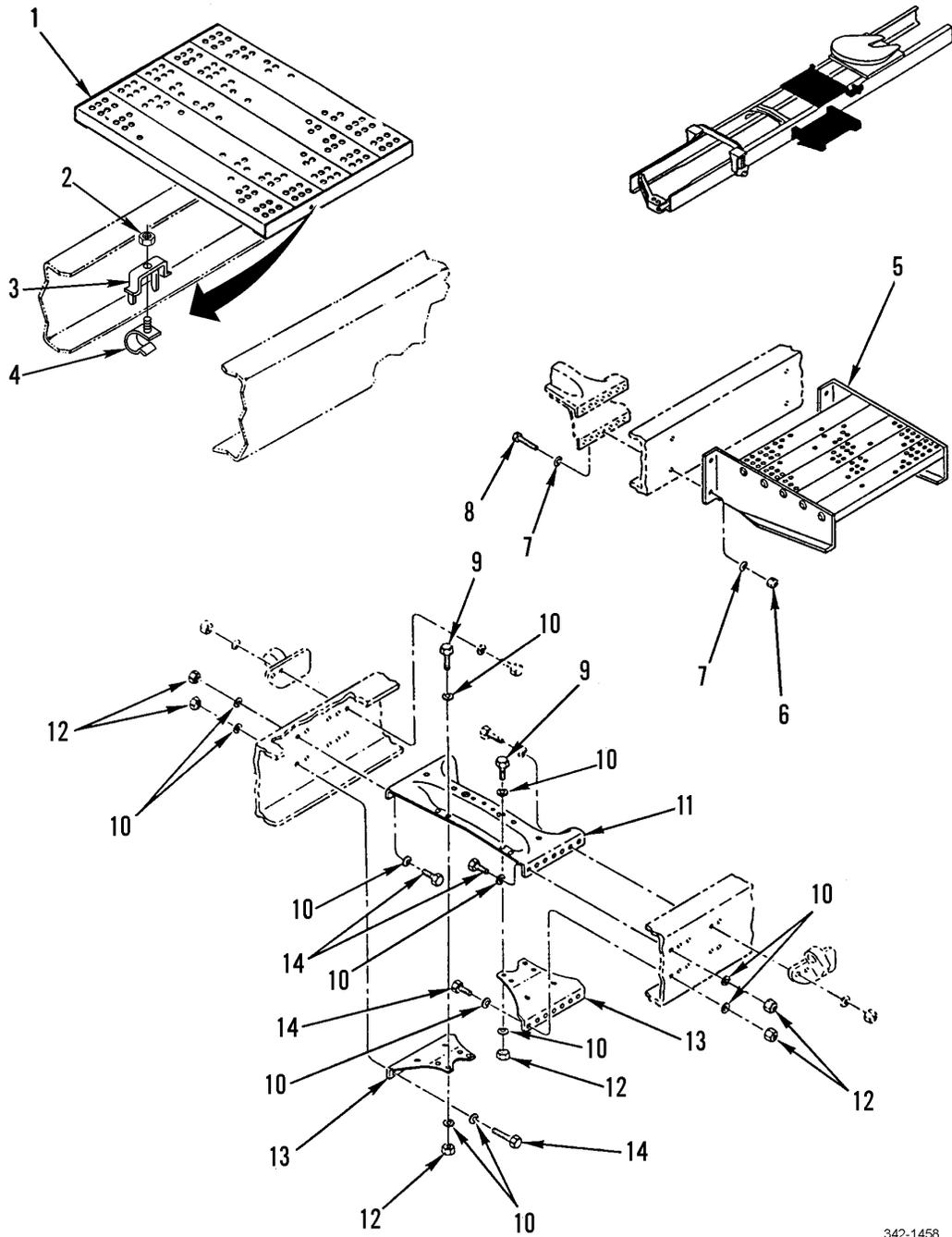

342-1458

Figure 179. Treadplate, L/S Platform, Midships and Alligator Crossmember

SECTION II			TM9-2320-302-24P			
(1)	(2)	(3)	(4)	(5)	(6)	(7)
ITEM	SMR			PART		
NO	CODE	NSN	CAGEC	NUMBER	DESCRIPTION AND USABLE ON CODES(UOC)	QTY
GROUP 1501 FRAME ASSEMBLY						
FIG. 179 TREADPLATE, L/S PLATFORM, MIDSHIPS AND ALLIGATOR CROSSMEMBER						
1	PFOZZ		64678	A22-35839-002	TREAD,METALLIC,NONS.....	1
2	XDOZZ		64678	23-11600-102	NUT,SELF-LOCKING,HE 5/16-18UNC, NYLON PATCH SST.....	4
3	XDOZZ		64678	22-43540-000	BRACKET,MOUNTING.....	4
4	XDOZZ		64678	A22-43203-000	CLIP,SPRING TENSION RIB BOLT 5/16- 18 X 1.00".....	4
5	PAOZZ	2510013370230	64678	A22-35376-000	TREAD,METALLIC,NONS.....	1
6	PAOZZ	5310002694040	96906	MS51922-49	NUT,SELF-LOCKING,HE 5/8-11UNC.....	4
7	PAOZZ	5310007208819	96906	MS15795-821	WASHER,FLAT .688 ID X 1.75 OD.....	8
8	PAOZZ	5305007247222	80204	B1821BH063C200N	SCREW,CAP,HEXAGON H 5/8-11 X 2.00..	4
9	PAHZZ	5305007247228	80204	B1821BH063C300N	SCREW,CAP,HEXAGON H.....	4
10	PAHZZ	5310007208819	96906	MS15795-821	WASHER,FLAT .688 ID X 1.75 OD.....	32
11	PAHZZ	5340013382908	64678	A15-12619-001	BRACKET,MOUNTING MIDSHIP.....	1
12	PAHZZ	5310002694040	96906	MS51922-49	NUT,SELF-LOCKING,HE 5/8-11UNC.....	16
13	PGHZZ		64678	15-15636-001	FRAME SECTION,STRUC.....	2
14	PAHZZ	5305007247223	80204	B1821BH063C225N	SCREW,CAP,HEXAGON H 5/8-11 X 2.25..	12

END OF FIGURE

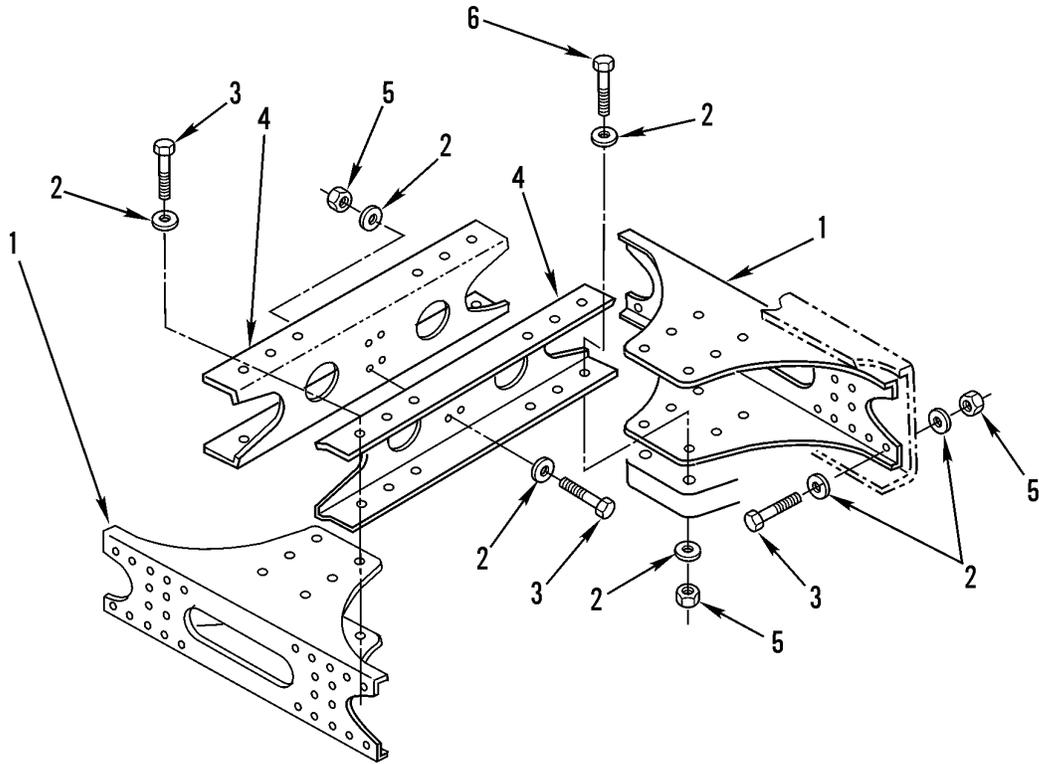

342-1459

Figure 180. Rear Suspension Crossmember

SECTION II			TM9-2320-302-24P			
(1)	(2)	(3)	(4)	(5)	(6)	(7)
ITEM	SMR			PART		
NO	CODE	NSN	CAGEC	NUMBER	DESCRIPTION AND USABLE ON CODES(UOC)	QTY
GROUP 1501 FRAME ASSEMBLY						
FIG. 180 REAR SUSPENSION CROSSMEMBER						
1	PGHZZ		64678	15-17534-003	FRAME SECTION,STRUC.....	2
2	PAHZZ	5310007208819	96906	MS15795-821	WASHER,FLAT .688 ID X 1.75 OD.....	80
3	PAHZZ	5305007247221	80204	B1821BH063C175N	SCREW,CAP,HEXAGON H 5/8-11UNC-2A X 1.750.....	36
4	PGHZZ		64678	15-17533-000	FRAME SECTION,STRUC REAR.....	2
5	PAHZZ	5310002694040	96906	MS51922-49	NUT,SELF-LOCKING,HE 5/8-11UNC.....	40
6	PAHZZ	5305007247236	80204	B1821BH063C325N	SCREW,CAP,HEXAGON H USED IN TWO BOTTOM HOLES, 5/8-11 X 3.25.....	4

END OF FIGURE

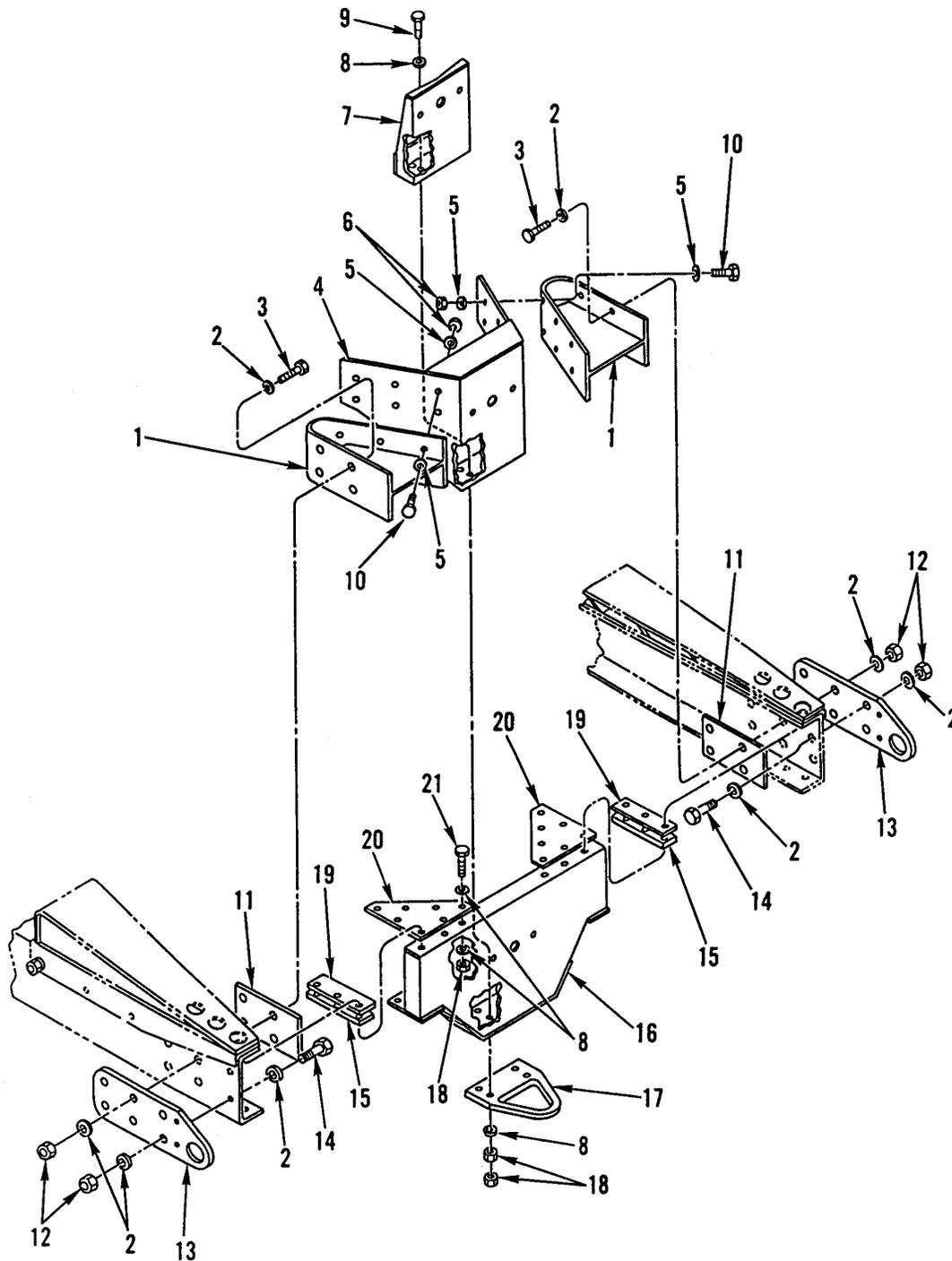

342-1306

Figure 181. Rear Crossmember and Tie Down

SECTION II			TM9-2320-302-24P			
(1)	(2)	(3)	(4)	(5)	(6)	(7)
ITEM	SMR			PART		
NO	CODE	NSN	CAGEC	NUMBER	DESCRIPTION AND USABLE ON CODES(UOC)	QTY
GROUP 1501 FRAME ASSEMBLY						
FIG. 181 REAR CROSSMEMBER AND TIE DOWN						
1	XDHZZ		64678	E15-11813-002	SUPPORT, A-FRAME.....	2
2	PAHZZ	5310013367579	64678	23-09114-008	WASHER, FLAT 1.0 X 2.0 X .18.....	24
3	PAHZZ	5305002765739	80204	B1821BH100C375N	SCREW, CAP, HEXAGON H 1-8UNC-2A X 3.750.....	8
4	XDHZZ		64678	A15-13339-000	PLATE, A-FRAME.....	1
5	PAHZZ	5310007208819	96906	MS15795-821	WASHER, FLAT .688 ID X 1.750 OD.....	24
6	PAHZZ	5310002694040	96906	MS51922-49	NUT, SELF-LOCKING, HE 5/8-11UNC.....	12
7	XDHZZ		64678	A15-10198-000	BOX, COUPLER.....	1
8	PAHZZ	5310011091977	19207	11628332-2	WASHER, FLAT.....	36
9	PAHZZ	5306013366829	64678	23-11011-350	BOLT, MACHINE 1/2-13.....	4
10	PAHZZ	5305007247221	80204	B1821BH063C175N	SCREW, CAP, HEXAGON H 5/8-11UNC-2A X 1.750.....	12
11	PFHZZ	5365013370372	64678	15-13565-000	SPACER, PLATE.....	2
12	PAHZZ	5310013369850	64678	23-09901-116	NUT, SELF-LOCKING, HE THDLK, 1-8UNC...	12
13	XDOZZ		64678	A22-44869-000	BRACKET, MOUNTING R.H.....	1
13	XDOZZ		64678	A22-44869-001	BRACKET, MOUNTING L.H.....	1
14	PAHZZ	5305009408068	80204	B1821BH100C300N	SCREW, CAP, HEXAGON H 1-8UNC-2A X 3.000.....	4
15	PAHZZ	5340013366909	64678	15-09170-050	PLATE, MENDING.....	2
16	XDHZZ		64678	A15-12507-000	CROSSMEMBER.....	1
17	PAHZZ	4010013365983	64678	15-13270-000	LINK, CHAIN, END.....	1
18	PFOZZ	5310002256993	96906	MS51922-33	NUT, SELF-LOCKING, HE 1/2-13UNC.....	22
19	PAHZZ	5340013363928	64678	15-09170-038	PLATE, MENDING.....	2
20	PGHZZ	2510013384491	64678	15-10279-000	FRAME SECTION, STRUC.....	2
21	PAOZZ	5305000712069	80204	B1821BH050C150N	SCREW, CAP, HEXAGON H 1/2-13UNC-2A X 1.500.....	8

END OF FIGURE

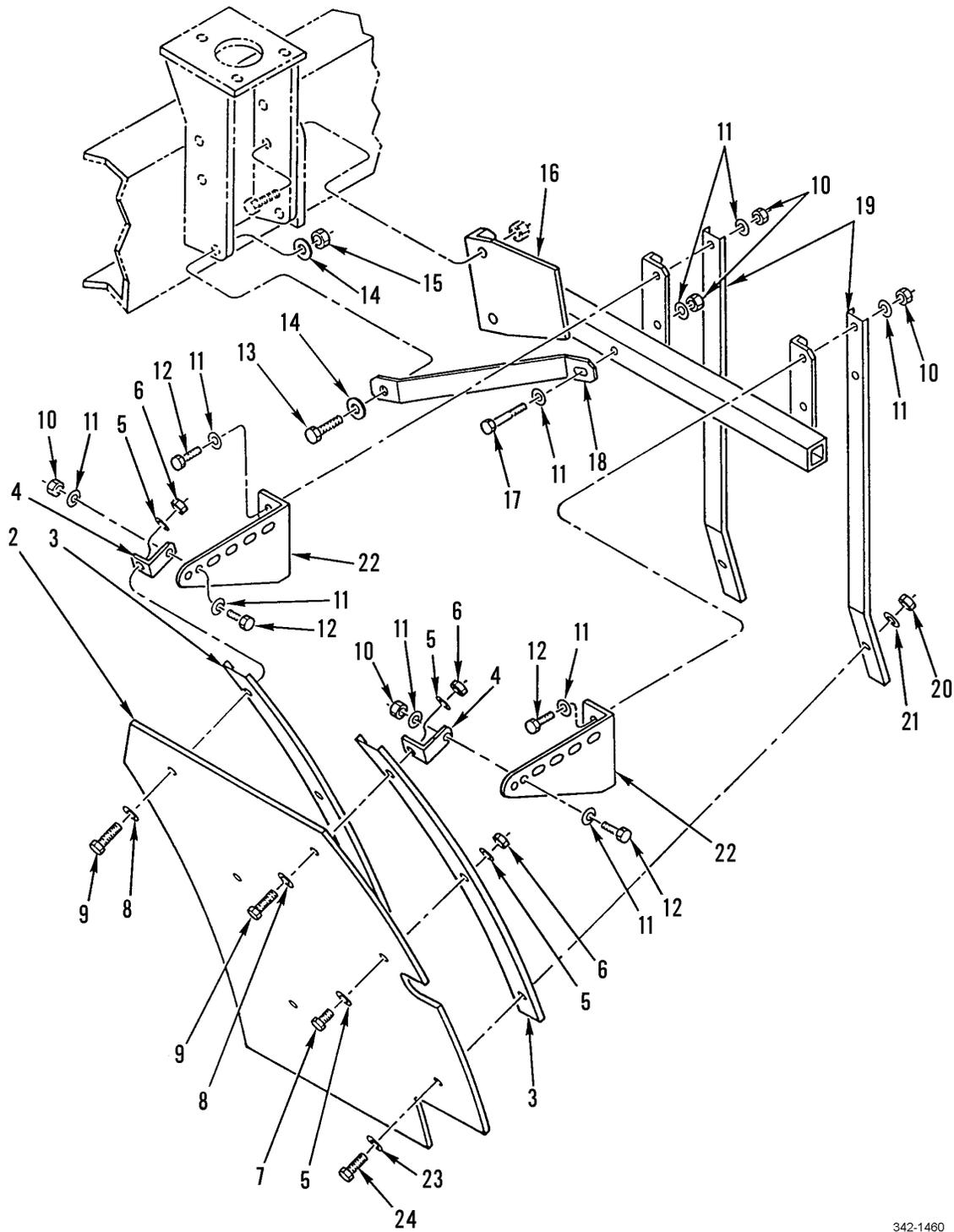
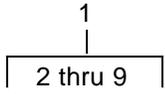

342-1460

Figure 182. Front Mudflaps

SECTION II			TM9-2320-302-24P			
(1)	(2)	(3)	(4)	(5)	(6)	(7)
ITEM	SMR			PART		
NO	CODE	NSN	CAGEC	NUMBER	DESCRIPTION AND USABLE ON CODES(UOC)	QTY
GROUP 1501 FRAME ASSEMBLY						
FIG. 182 FRONT MUDFLAPS						
1	XDOOO		64678	A22-39265-000	MUDFLAP ASSY,LH L.H.....	1
1	XDOOO		64678	A22-39265-001	MUDFLAP ASSY,RH R.H.....	1
2	PFOZZ	2540013390554	64678	22-32642-000	.GUARD,SPLASH,VEHICU.....	1
3	PFOZZ	5340013367992	64678	22-32640-000	.STRAP,RETAINING.....	2
4	PFOZZ	5340013370380	64678	22-32514-001	.BRACKET,ANGLE.....	2
5	PFOZZ	5310000806004	96906	MS27183-14	.WASHER,FLAT .406 ID X .812 OD X .065 THK.....	6
6	PFOZZ	5310007320558	96906	MS51967-8	.NUT,PLAIN,HEXAGON THDLK, 3/8-16UNC	4
7	PFOZZ	5305002693211	96906	MS90725-60	.SCREW,CAP,HEXAGON H.....	2
8	PAOZZ	5310010977691	98749	849257-2	.WASHER,FLAT 5/16 X 1-1/4.....	4
9	PFOZZ	5305008213869	80204	B1821BH038C175N	.SCREW,CAP,HEXAGON H 3/8-16UNC-2A X 1.750.....	2
10	PAOZZ	5310000874652	96906	MS51922-17	NUT,SELF-LOCKING,HE 3/8-16UNC.....	30
11	PAOZZ	5310000806004	96906	MS27183-14	WASHER,FLAT .406 ID X .812 OD X .065 THK.....	54
12	PAOZZ	5305000680511	80204	B1821BH038C125N	SCREW,CAP,HEXAGON H 3/8-16UNC X 1.250.....	16
13	PAOZZ	5305000712070	80204	B1821BH050C175N	SCREW,CAP,HEXAGON H 1/2-13UNC-2A X 1.750.....	2
14	PAOZZ	5310011091977	19207	11628332-2	WASHER,FLAT .531 ID X 1.062 OD X .18 THK.....	4
15	PAOZZ	5310002256993	96906	MS51922-33	NUT,SELF-LOCKING,HE 1/2-13UNC.....	2
16	PFOZZ	5340013366978	64678	A22-32550-000	BRACKET,MOUNTING LEFT.....	1
16	PFOZZ	5340013366549	64678	A22-32550-001	BRACKET,MOUNTING RIGHT.....	1
17	PAOZZ	5305008465703	80204	B1821BH038C300N	SCREW,CAP,HEXAGON H 3/-16UNC-2A X 3.00.....	4
18	PFOZZ	5340013382877	64678	22-32551-000	BRACKET,DOUBLE ANGL.....	2
19	PFOZZ	5340013366918	64678	22-32552-000	BRACKET,DOUBLE ANGL.....	4
20	PAOZZ	5310009843806	96906	MS51922-9	NUT,SELF-LOCKING,HE 5/16-18UNC.....	4
21	PAOZZ	5310000814219	96906	MS27183-12	WASHER,FLAT .344 ID X .688 OD X .065 THK.....	4
22	PFOZZ	5340013363936	64678	22-32515-000	BRACKET,ANGLE.....	4
23	PAOZZ	5310010977691	98749	849257-2	WASHER,FLAT 5/16 X 1-1/4.....	2
24	PAOZZ	5306002258503	96906	MS90725-39	BOLT,MACHINE 5/16-18UNC X 1.750....	4

END OF FIGURE

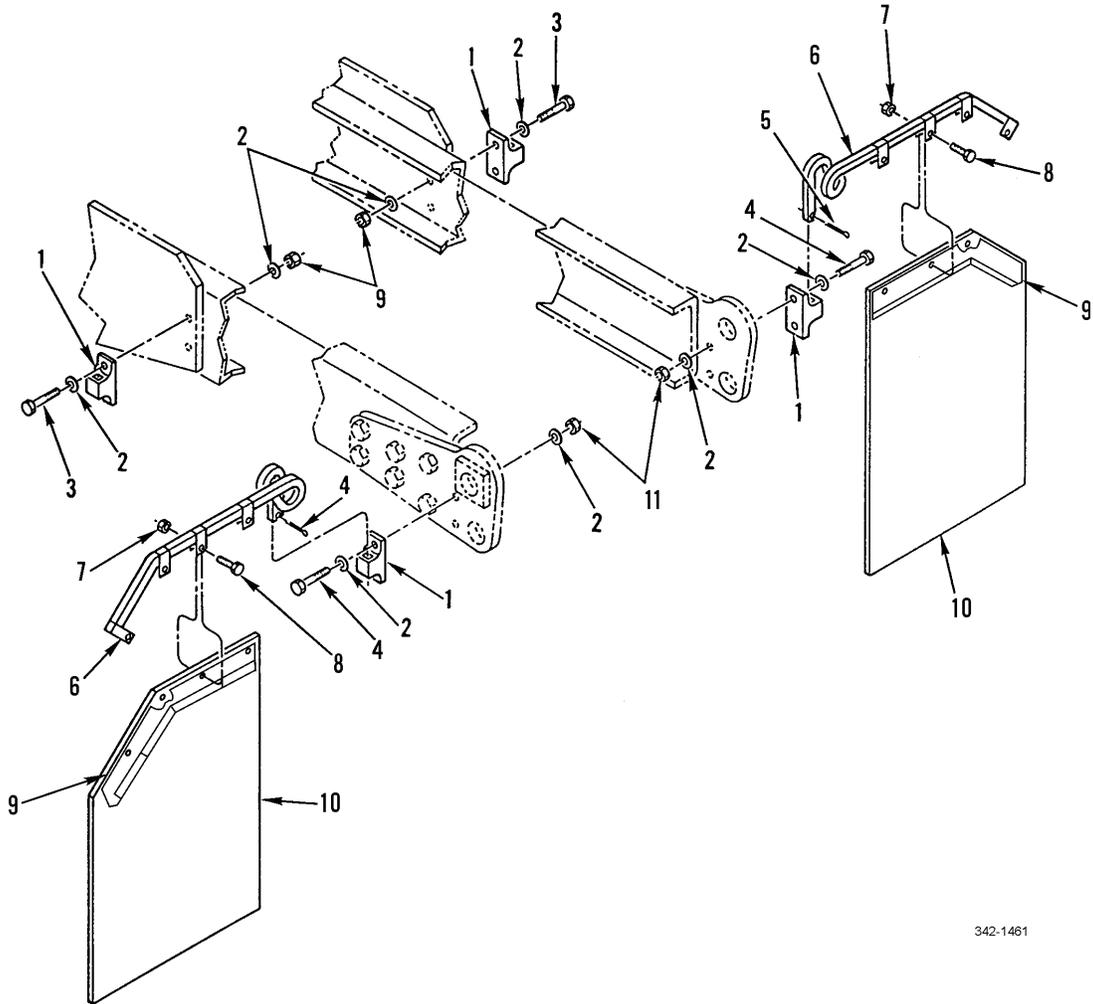

342-1461

Figure 183. Rear Mudflaps

SECTION II			TM9-2320-302-24P			
(1)	(2)	(3)	(4)	(5)	(6)	(7)
ITEM	SMR			PART		
NO	CODE	NSN	CAGEC	NUMBER	DESCRIPTION AND USABLE ON CODES(UOC)	QTY
GROUP 1501 FRAME ASSEMBLY						
FIG. 183 REAR MUDFLAPS						
1	PAOZZ	5340013366029	64678	B-850	BRACKET,MOUNTING LEFT.....	4
2	PAOZZ	5310011091977	19207	11628332-2	WASHER,FLAT .531 ID X 1.062 OD X .18 THK.....	16
3	PAOZZ	5305000712070	80204	B1821BH050C175N	SCREW,CAP,HEXAGON H 1/2-13UNC X 1.750.....	4
4	PAOZZ	5305000712072	80204	B1821BH050C225N	SCREW,CAP,HEXAGON H 1/2-13 X 2.25..	4
5	PAOZZ	5315001879572	80205	MS24665-621	PIN,COTTER 1/4 X 1.00.....	2
6	PAOZZ	2540013387727	85411	A-84-R	HOLDER,SPLASH GUARD RIGHT.....	1
7	PAOZZ	5310000874652	96906	MS51922-17	NUT,SELF-LOCKING,HE 3/8-16UNC.....	8
8	PAOZZ	5305000680511	80204	B1821BH038C125N	SCREW,CAP,HEXAGON H 3/8-16 X 1.25..	8
9	PAOZZ		64678	A22-47301-000	BRACKET,MOUNTING LH, INCLUDES REFLECTIVE TAPE.....	1
9	PAOZZ		64678	A22-47301-001	BRACKET,MOUNTING RH, INCLUDES REFLECTIVE TAPE.....	1
10	PAOZZ	2540013374416	64678	22-33178-010	GUARD,SPLASH,VEHICU LEFT.....	1
10	PAOZZ	2540013384621	64678	22-33178-011	GUARD,SPLASH,VEHICU RIGHT.....	1
11	PAOZZ	5310002256993	96906	MS51922-33	NUT,SELF-LOCKING,HE 1/2-13UNC.....	8

END OF FIGURE

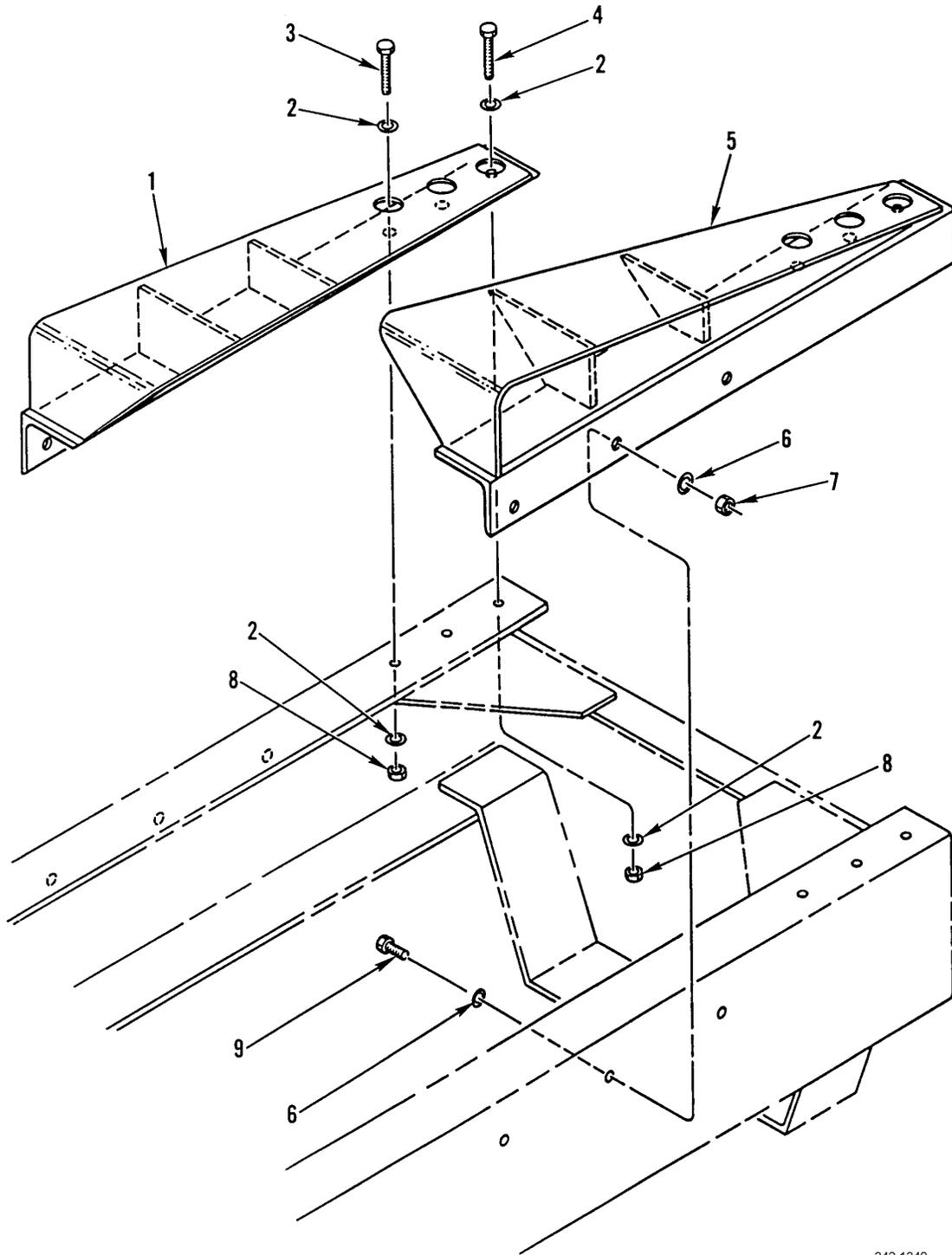

342-1340

Figure 184. Ramp Installation

SECTION II			TM9-2320-302-24P			
(1)	(2)	(3)	(4)	(5)	(6)	(7)
ITEM	SMR			PART		
NO	CODE	NSN	CAGEC	NUMBER	DESCRIPTION AND USABLE ON CODES(UOC)	QTY
GROUP 1501 FRAME ASSEMBLY						
FIG. 184 RAMP INSTALLATION						
1	PGFZZ	2510013299905	64678	A22-34757-001	FRAME SECTION,STRUC RIGHT RAMP.....	1
2	PAFZZ	5310011091977	19207	11628332-2	WASHER,FLAT.....	12
3	PAFZZ	5305000712075	80204	B1821BH050C300N	SCREW,CAP,HEXAGON H 1/2-13UNC-2A X 3.000.....	4
4	PAFZZ	5305001397071	96906	MS35307-420	SCREW,CAP,HEXAGON H 3.250 X 13UNC- 2A.....	2
5	PGFZZ	2510013299904	64678	A22-34757-000	FRAME SECTION,STRUC LEFT RAMP.....	1
6	PAFZZ	5310007208819	96906	MS15795-821	WASHER,FLAT .688 ID X 1.750 OD.....	12
7	PAFZZ	5310002694040	96906	MS51922-49	NUT,SELF-LOCKING,HE 5/8-11UNC.....	6
8	PAFZZ	5310002256993	96906	MS51922-33	NUT,SELF-LOCKING,HE.....	6
9	PAFZZ	5305007247222	80204	B1821BH063C200N	SCREW,CAP,HEXAGON H 5/8-11 2.00..	6

END OF FIGURE

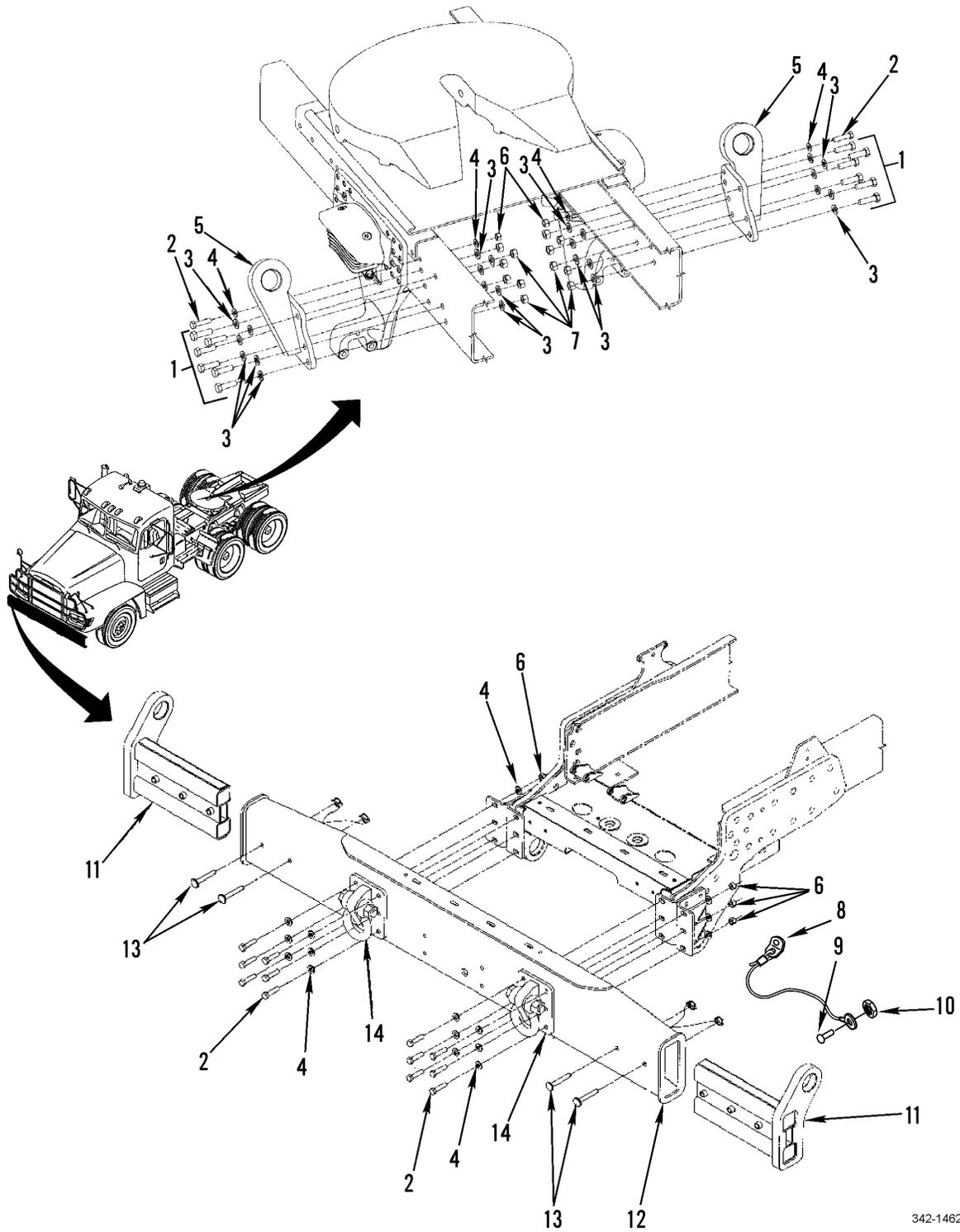

342-1462

Figure 185. Front Bumper, Tow Bracket and Sling Bracket

SECTION II			TM9-2320-302-24P			
(1)	(2)	(3)	(4)	(5)	(6)	(7)
ITEM	SMR			PART		
NO	CODE	NSN	CAGEC	NUMBER	DESCRIPTION AND USABLE ON CODES(UOC)	QTY
GROUP 1503 PINTLES AND TOWING ATTACHMENTS						
FIG. 185 FRONT BUMPER, TOW BRACKET AND SLING BRACKET						
1	PAOZZ	5305009227994	80204	B1821BH075C250N	SCREW,CAP,HEXAGON H 3/4-10 X 2.50..	12
2	PAOZZ	5305007247224	80204	B1821BH063C250N	SCREW,CAP,HEXAGON H 5/8-11UNC-2A X 2.50.....	14
3	XDOZZ		64678	23-09114-014	WASHER,FLAT 0.81 ID X 1.13 OD X .177 THK.....	24
4	PAOZZ	5310007208819	96906	MS15795-821	WASHER,FLAT .688 ID X 1.750 OD.....	28
5	XDOZZ		64678	A22-48592-001	BRACKET,VEHICULAR C R.H.....	1
5	XDOZZ		64678	A22-48592-000	BRACKET,VEHICULAR C L.H.....	1
6	PAOZZ	5310009154891	96906	MS51967-21	NUT,PLAIN,HEXAGON.....	14
7	XDOZZ		64678	23-09339-513	NUT,PLAIN,HEXAGON 3/4-10UNC.....	12
8	PFOZZ		64678	A21-26065-000	WIRE ROPE ASSEMBLY 7.87" INCLUDES CLICK PIN & MOUNTING RING.....	4
9	PAOZZ	5305012104595	97403	13222E0109	SCREW,ROLLER ASSEMB 3/8-16 X 1.00..	2
10	PAOZZ	5310011511036	45152	115307A	NUT,SELF-LOCKING,EX 3/8-16.....	2
11	XDOZZ		64678	A15-16879-001	BRACKET,VEHICULAR C RH.....	1
11	XDOZZ		64678	A15-16879-000	BRACKET,VEHICULAR C LH.....	1
12	XDOZZ		64678	A21-26181-000	BUMPER,VEHICULAR.....	1
13	PAOZZ		64678	23-12139-006	PIN,STRAIGHT,HEADED 0.625 DIA X 4.35 LG.....	4
14	PAOZZ	4030011870964	19207	12328579	SHACKLE.....	2

END OF FIGURE

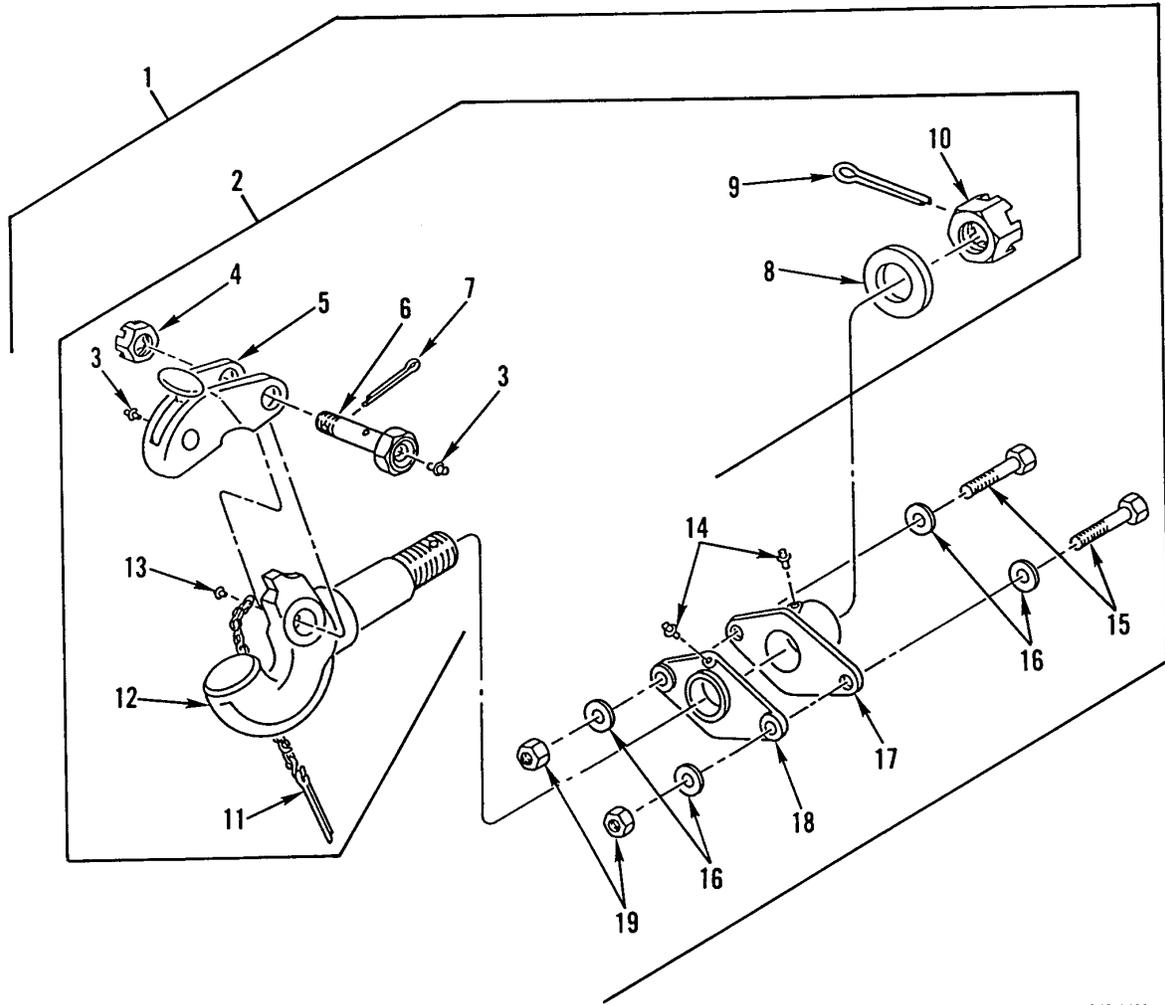

342-1463

Figure 186. Pintle Hook, Rear

SECTION II			TM9-2320-302-24P			
(1)	(2)	(3)	(4)	(5)	(6)	(7)
ITEM	SMR			PART		
NO	CODE	NSN	CAGEC	NUMBER	DESCRIPTION AND USABLE ON CODES(UOC)	QTY
GROUP 1503 PINTLES AND TOWING ATTACHMENTS						
FIG. 186 PINTLE HOOK, REAR						
1	PFOOO	2540013373725	74410	PH-760	PINTLE ASSEMBLY,TOW.....	1
2	PAOOO	2540007760103	74410	7760103	.PINTLE ASSEMBLY,TOW.....	1
3	PAOZZ	4730000504203	74410	XB-767	..FITTING,LUBRICATION.....	2
4	PAOZZ	5310004848816	74410	120-2	..NUT,PLAIN,SLOTTED,H 1-14.....	1
5	PAOZZ	2540011515703	74410	XA-764-A	..LATCH,PINTLE HOOK.....	1
6	PAOZZ	4730012936907	74410	XA-766-1	..BOLT,FLUID PASSAGE.....	1
7	PAOZZ	5315011531451	74410	119-1	..PIN,COTTER.....	1
8	PAOZZ	5310013366745	74410	XA-768	..WASHER,FLAT 1.53 ID X 2.75 OD X .375 THK.....	1
9	PAOZZ	5315002341848	74410	XB-773	..PIN,COTTER.....	1
10	PAOZZ	5310013366681	74410	XB-771-1	..NUT,PLAIN,CASTELLAT 1 1/2-12UNC..	1
11	PAOZZ	4010012931710	74410	XA-199	..CHAIN ASSEMBLY,SING.....	1
12	PFOZZ	2540012893947	74410	XA-761	..HOOK,PINTLE.....	1
13	PAOZZ	5305004865292	74410	XB-128	..SCREW NO. 10 X 1/2.....	1
14	PAOZZ	4730000504203	74410	XB-767	.FITTING,LUBRICATION.....	2
15	PAOZZ	5305013374796	74410	XB-772	.SCREW,CAP,HEXAGON H 3/4-16 X 3.00.	2
16	PAOZZ	5310012751065	96906	MS51412-13	.WASHER,FLAT.....	4
17	XDOZZ		74410	XA-763	.PINTLE,BRACKET.....	1
18	PAOZZ	2540013379004	74410	XA-763-A	.BRACKET,PINTLE HOOK.....	1
19	PFOZZ	5310011508599	74410	XB-769	.NUT,SELF-LOCKING,HE 3/4-16.....	2

END OF FIGURE

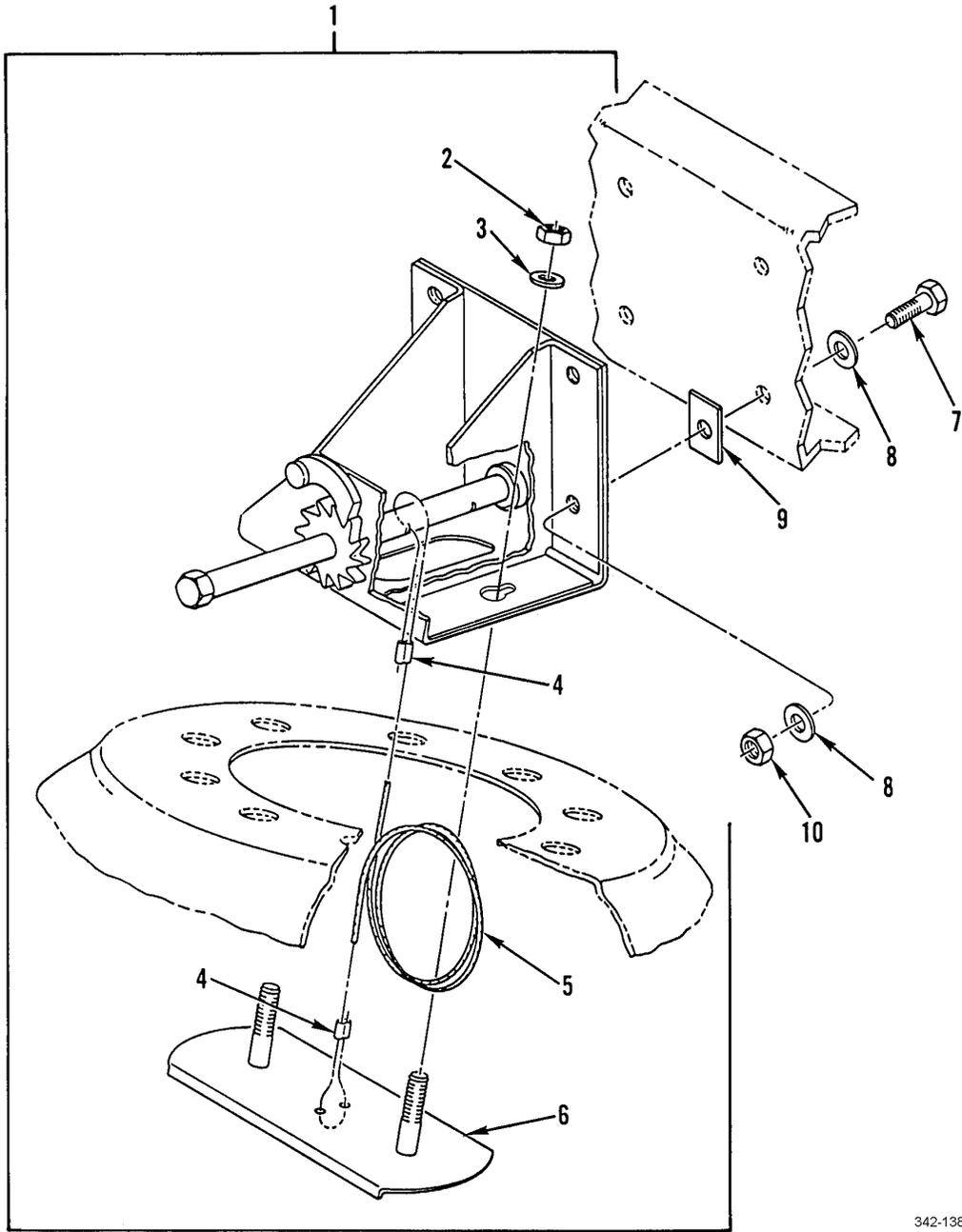

342-1382

Figure 187. Spare Tire Carrier

SECTION II			TM9-2320-302-24P			
(1)	(2)	(3)	(4)	(5)	(6)	(7)
ITEM	SMR			PART		
NO	CODE	NSN	CAGEC	NUMBER	DESCRIPTION AND USABLE ON CODES(UOC)	QTY
					GROUP 1504 SPARE WHEEL CARRIER AND TIRE LOCK	
					FIG. 187 SPARE TIRE CARRIER	
1	XDOOO		64678	A22-52996-000	BRACKET,VEHICULAR C.....	1
2	PAOZZ	5310009154891	96906	MS51967-21	.NUT,PLAIN,HEXAGON 5/8-11UNC.....	2
3	PAOZZ	5310013370905	64678	BMK-F1TC-01	.WASHER,LOCK 5/8.....	2
4	PAOZZ	4030012454168	96906	MS51844-65	.SWAGING SLEEVE,WIRE.....	2
5	MOOZZ		64678	FITC-02	.CABLE,SPECIAL PURPO 144" MAKE FROM BULK PN M83420/1-005 (81349)...	1
6	PAOZZ	5340013366446	64678	FITC-05	.BRACKET,DOUBLE ANGL.....	1
7	PAOZZ	5305007247223	80204	B1821BH063C225N	SCREW,CAP,HEXAGON H 5/8-11UNC X 2.25.....	4
8	PAOZZ	5310013334538	64678	23-09114-007	WASHER,FLAT 5/8 ID X 1.22 OD X .18 THK.....	8
9	PAOZZ	5365013560083	64678	E22-25841-008	SPACER,PLATE.....	2
10	PAOZZ	5310002694040	96906	MS51922-49	NUT,SELF-LOCKING,HE 5/8-11UNC.....	4

END OF FIGURE

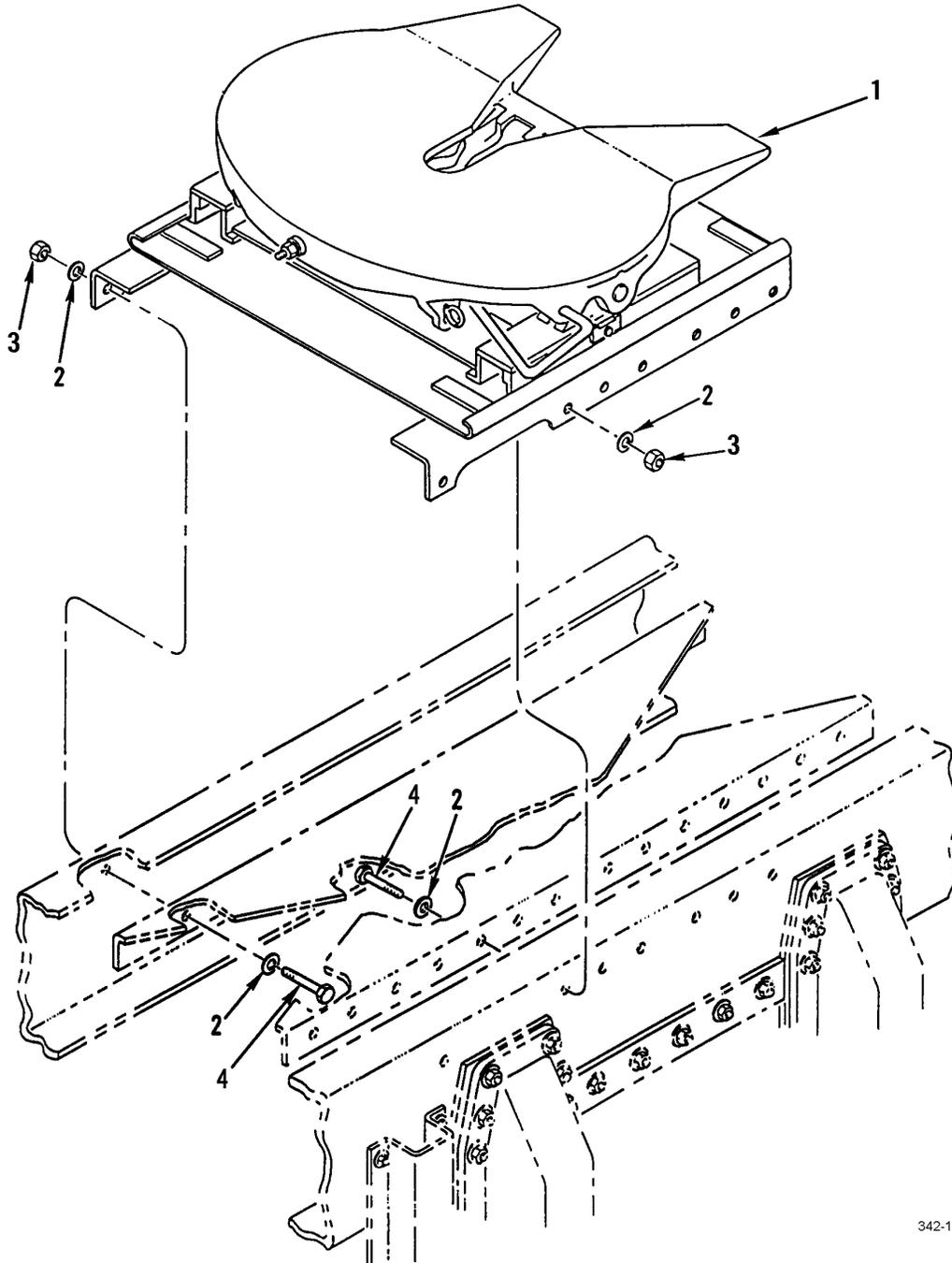

342-1341

Figure 188. Fifth Wheel Assembly

SECTION II			TM9-2320-302-24P			
(1)	(2)	(3)	(4)	(5)	(6)	(7)
ITEM	SMR			PART		
NO	CODE	NSN	CAGEC	NUMBER	DESCRIPTION AND USABLE ON CODES(UOC)	QTY
GROUP 1506 FIFTH WHEEL						
FIG. 188 FIFTH WHEEL ASSEMBLY						
1	PAFFF	2510014791632	64678	A22-48497-001	FIFTH WHEEL ASSEMBL TEFLON PLATE	1
2	PAFZZ	5310007208819	96906	MS15795-821	TYPE.....	28
3	PAFZZ	5310002694040	96906	MS51922-49	WASHER, FLAT.....	14
4	PAFZZ	5305007247223	80204	B1821BH063C225N	NUT, SELF-LOCKING, HE.....	14
					SCREW, CAP, HEXAGON H.....	14

END OF FIGURE

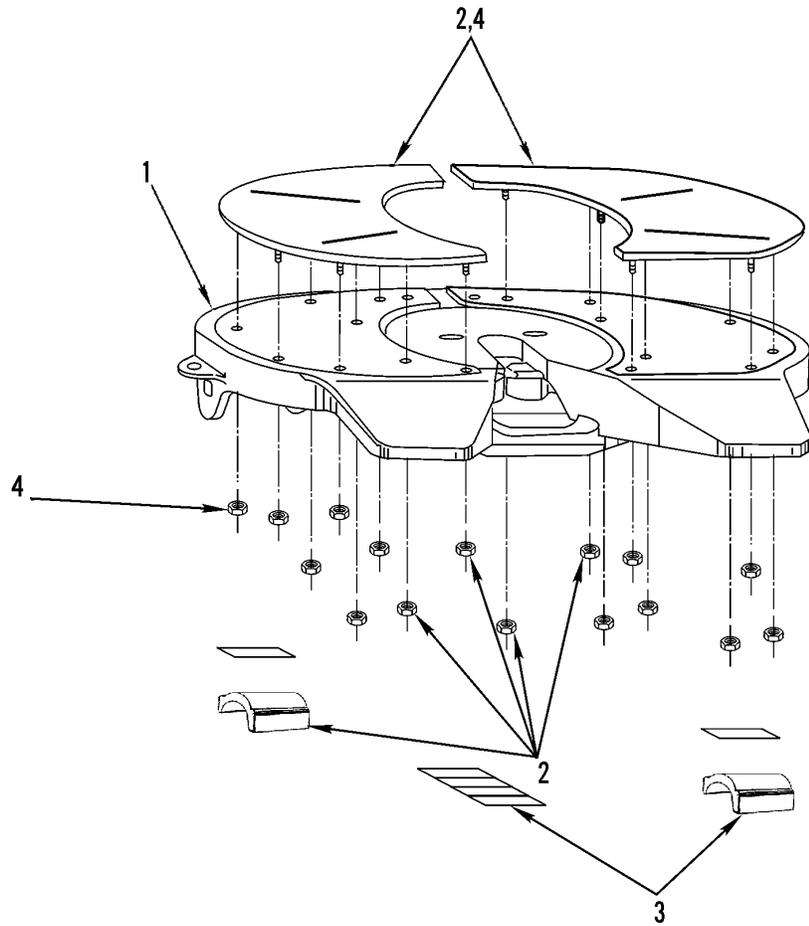
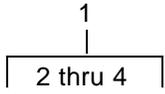

342-1427

Figure 189. Fifth Wheel Components

SECTION II			TM9-2320-302-24P			
(1)	(2)	(3)	(4)	(5)	(6)	(7)
ITEM	SMR			PART		
NO	CODE	NSN	CAGEC	NUMBER	DESCRIPTION AND USABLE ON CODES(UOC)	QTY
					GROUP 1506 FIFTH WHEEL	
					FIG. 189 FIFTH WHEEL COMPONENTS	
1	PAFZA	2510014790985	74410	FW33S04716	.PLATE,FIFTH WHEEL A.....	1
2	PAFZA	2510014790990	74410	RK-331-3	.PARTS KIT,FIFTH WHE TEFLON PLATES, NUTS, POCKET INSERTS.....	1
3	PAFZA	2510014790989	74410	RK-331-2	.PARTS KIT,FIFTH WHE POCKET INSERTS	1
4	PAFZA	2510014790997	74410	RK-331-1	.PARTS KIT,FIFTH WHE TEFLON PLATES AND NUTS.....	1

END OF FIGURE

13	21
14 thru 17	22 thru 26

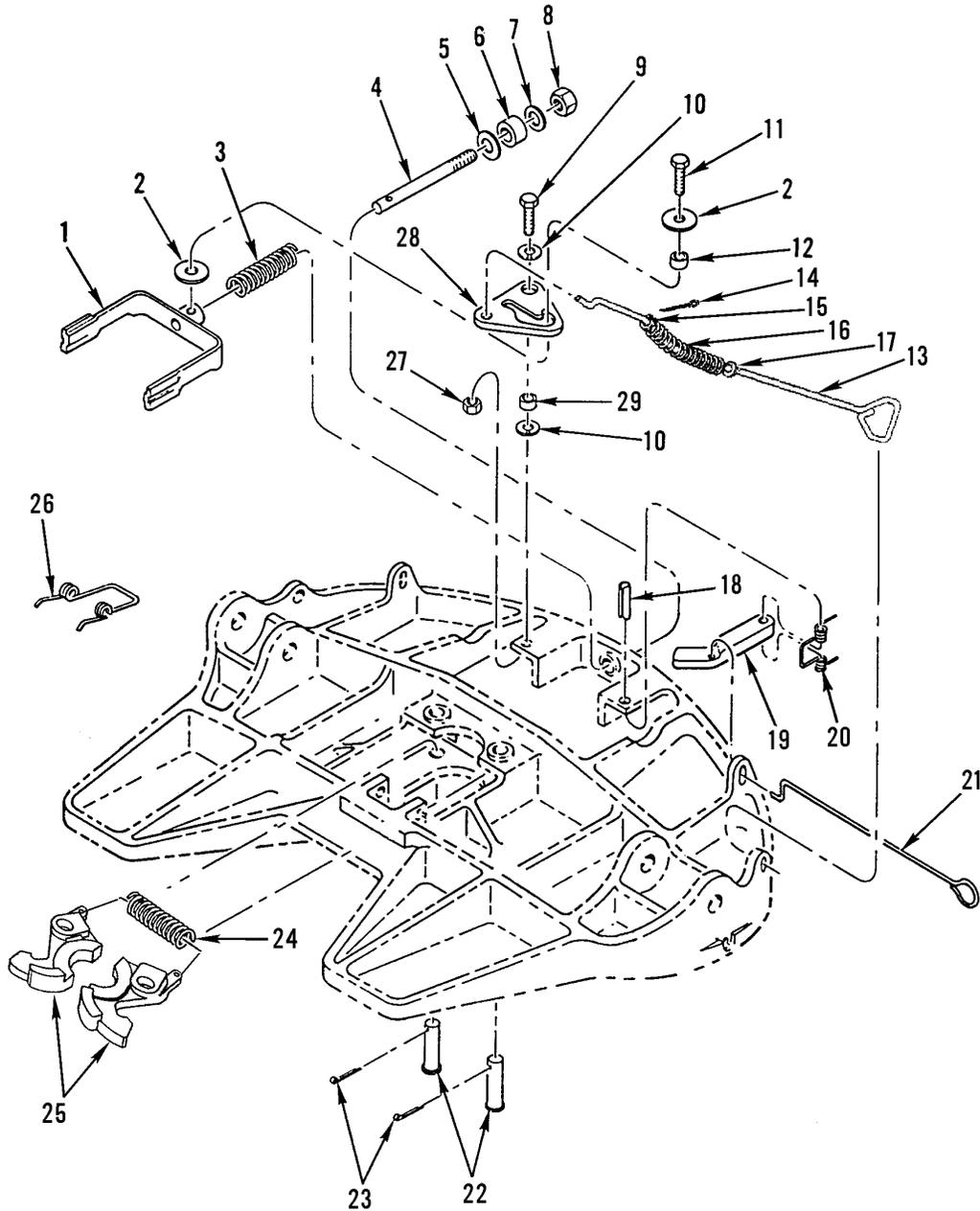

342-1428

Figure 190. Wheel Plate Assembly

SECTION II			TM9-2320-302-24P			
(1)	(2)	(3)	(4)	(5)	(6)	(7)
ITEM	SMR			PART		
NO	CODE	NSN	CAGEC	NUMBER	DESCRIPTION AND USABLE ON CODES(UOC)	QTY
GROUP 1506 FIFTH WHEEL						
FIG. 190 WHEEL PLATE ASSEMBLY						
1	PAFZZ	2510014397490	74410	XA-07295	.YOKE,FIFTH WHEEL PART OF KIT P/N RK-351-A-02-L.....	1
2	PAFZZ	5310014394256	74410	XB-07431	.WASHER,FLAT 2 5/8 X 2 1/32 PART OF KIT P/N RK-351-A-02-L.....	2
3	PFFZZ	5360011652290	74410	XB-1505	SPRING,HELICAL,COMP PART OF KIT P/N RK-351-A-02-L.....	1
4	PFFZZ	5307011600471	74410	XA-1706	STUD PART OF KIT P/N RK-351-A-02-L..	1
5	KFFZZ		74410	XB-02312	TAG,LOCK ADJ PART OF KIT P/N RK-351-A-02-L.....	1
6	PFFZZ	5365011624787	74410	XB-1127	SPACER,SLEEVE PART OF KIT P/N RK-351-A-02-L.....	1
7	PFFZZ	5310011609956	74410	XB-PW-1316-112	WASHER,FLAT 1/4 IN PART OF KIT P/N RK-351-A-02-L.....	1
8	PFFZZ	5310011624753	74410	XB-HNH-34-F	NUT,SELF-LOCKING,HE 3/4-16,GRADE C PART OF KIT P/N RK-351-A-02-L.....	1
9	PFFZZ	5305011610019	74410	XB-2083	SCREW,CAP,HEXAGON H 1/2-20 X1.75 IN,GR5 PART OF KIT P/N RK-351-A-02-L.....	1
10	KFFZZ		74410	XB-08559	.WASHER,FLAT 1 3/4 OD X 9/16 ID PART OF KIT P/N RK-351-A-02-L.....	2
11	PFFZZ	5305011610017	74410	XB-CX-58-F-134	SCREW,CAP,HEXAGON H 5/8-18 X 1 3/4, GR8 PART OF KIT P/N RK-351-A-02-L...	1
12	PFFZZ	3120011689204	74410	XA-1507	ROLLER,LINEAR-ROTAR PART OF KIT P/N RK-351-A-02-L.....	1
13	KFFZZ		74410	XA-07151-1	.HANDLE,MANUAL CONTR PART OF KIT P/N RK-351-A-02-L.....	1
14	KFFZZ		74410	XB-07508	.PIN,COTTER 1/8 X 1.25 PART OF KIT P/N RK-351-A-02-L.....	1
15	KFFZZ		74410	XB-PW-1732-1-116	.WASHER,FLAT 1 1/16 OD X 5/8 ID PART OF KIT P/N RK-351-A-02-L.....	1
16	PAFZZ	5360014392291	74410	XB-07291	.SPRING,HELICAL,EXTE PART OF KIT P/N RK-351-A-02-L.....	1
17	PAFZZ	5310011999467	74410	XB-T-49	.WASHER,FLAT .562 ID X 1.375 OD PART OF KIT P/N RK-351-A-02-L.....	1
18	PFFZZ	5315011670207	74410	XB-21-S-500-2750	PIN,STRAIGHT,HEADLE 1/2 X 2.75 PART OF KIT P/N RK-351-A-02-L.....	1
19	PFFZZ	3040011649277	74410	XA-3528	CONNECTING LINK,RIG PART OF KIT P/N RK-351-A-02-L.....	1
20	PFFZZ	5360011652301	74410	XB-2149	SPRING,HELICAL,TORS PART OF KIT P/N RK-351-A-02-L.....	1
21	PAFZZ	2510011980857	74410	XA-3542-M	HANDLE,LOCK,SECOND PART OF KIT P/N RK-351-A-02-L.....	1
22	PAFZZ	5315014401440	74410	XA-07292-T	.PIN,STRAIGHT,HEADED PART OF KIT P/N RK-351-A-02-L.....	2
23	PFFZZ	5315008499854	74410	XB-5	PIN,COTTER .31 X 3.00 PART OF KIT P/N RK-351-A-02-L.....	2
24	PAFZZ	5360014392295	74410	XB-07628	.SPRING,HELICAL,EXTE PART OF KIT P/N RK-351-A-02-L.....	1
25	PAFZZ	2510014395341	74410	XA-07296	.PLATE,FIFTH WHEEL A PART OF KIT P/N	1

SECTION II			TM9-2320-302-24P			
(1)	(2)	(3)	(4)	(5)	(6)	(7)
ITEM	SMR			PART		
NO	CODE	NSN	CAGEC	NUMBER	DESCRIPTION AND USABLE ON CODES(UOC)	QTY
26	PAFZZ	5360011652301	74410	XB-2149	RK-351-A-02-L..... .SPRING,HELICAL,TORS PART OF KIT P/N	1
27	PFFZZ	5310011652274	74410	XB-T-69-A	RK-351-A-02-L..... NUT,SELF-LOCKING,HE 1/2-20,GRADE B	1
28	PAFZZ	3040014401841	74410	XA-07150-L	PART OF KIT P/N RK-351-A-02-L..... .CAM,CONTROL PART OF KIT P/N RK-351-	1
29	PFFZZ	3110011689203	74410	XA-1029	A-02-L..... ROLLER,LINEAR-ROTAR PART OF KIT P/N	1
					RK-351-A-02-L.....	

END OF FIGURE

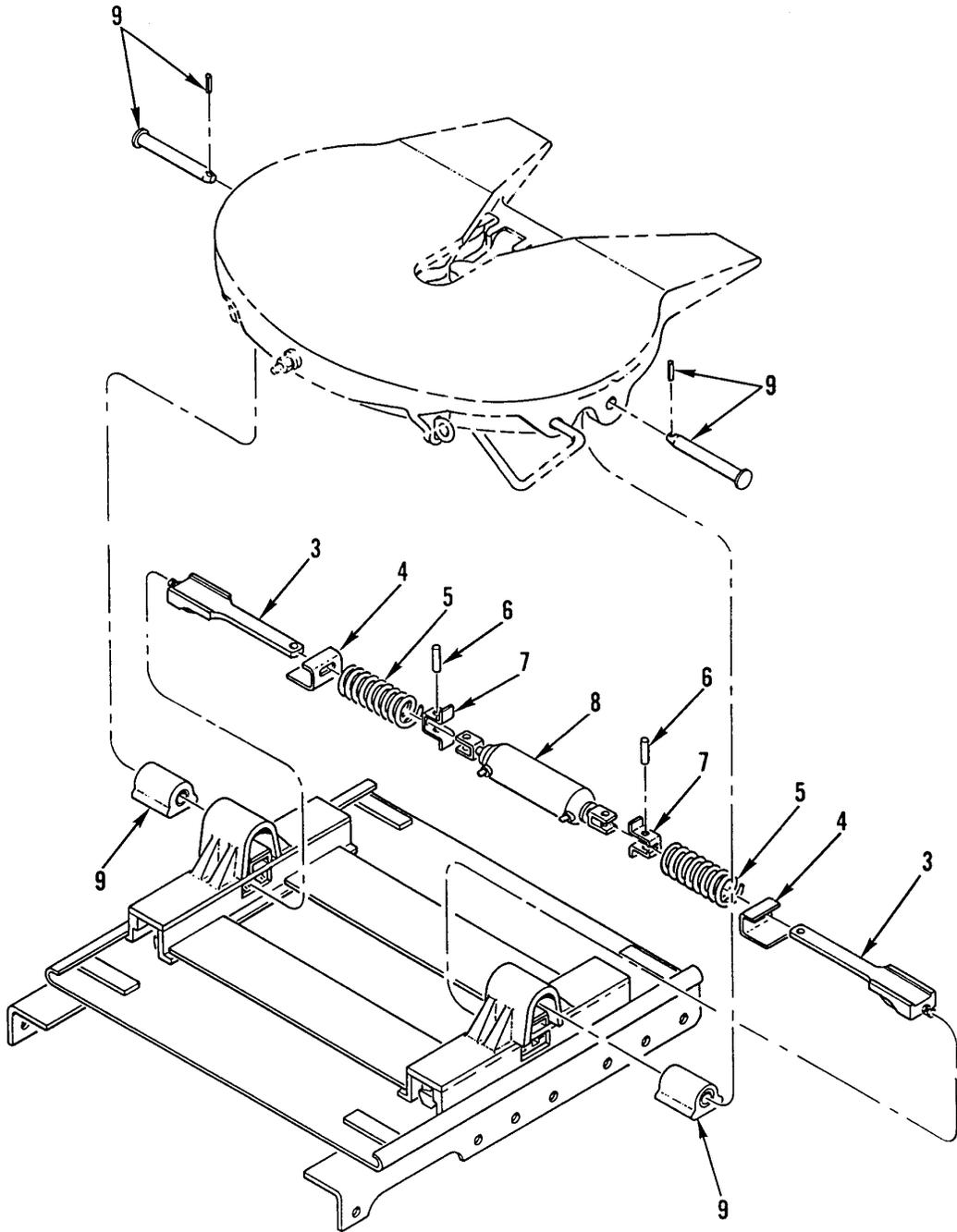

342-1307

Figure 191. Slider Bracket and Plate

SECTION II			TM9-2320-302-24P			
(1)	(2)	(3)	(4)	(5)	(6)	(7)
ITEM	SMR			PART		
NO	CODE	NSN	CAGEC	NUMBER	DESCRIPTION AND USABLE ON CODES(UOC)	QTY
GROUP 1506 FIFTH WHEEL						
FIG. 191 SLIDER BRACKET AND PLATE						
1	PAFFF	5340013277708	64678	A22-36918-000	.BRACKET,MOUNTING.....	1
2	PFFFF	2510011555796	74410	XA-7001	..BRACKET,SLIDE ASSEM.....	1
3	PAFZZ	5340013284513	74410	XA-0372-A	...PLUNGER,DETENT INCLUDES PLUNGER.	2
4	PAFZZ	5315013284106	74410	XA-01586	...PIN,SPRING.....	2
5	PAFZZ	5360011596485	74410	XB-2502	...SPRING,HELICAL,COMP.....	2
6	PAFZZ	5315011591263	74410	XA-2503	...PIN,STRAIGHT,HEADLE .44 X 1.13..	2
7	PAFZZ	5340011596484	74410	XA-2501	...RETAINER,HELICAL CO.....	2
8	PAFZZ	2590011555873	74410	XA-2524-R	...CYLINDER ASSEMBLY,A.....	1
9	PAFZZ	2510013330199	74410	RK-04413	..PARTS KIT,FIFTH WHE.....	1

END OF FIGURE

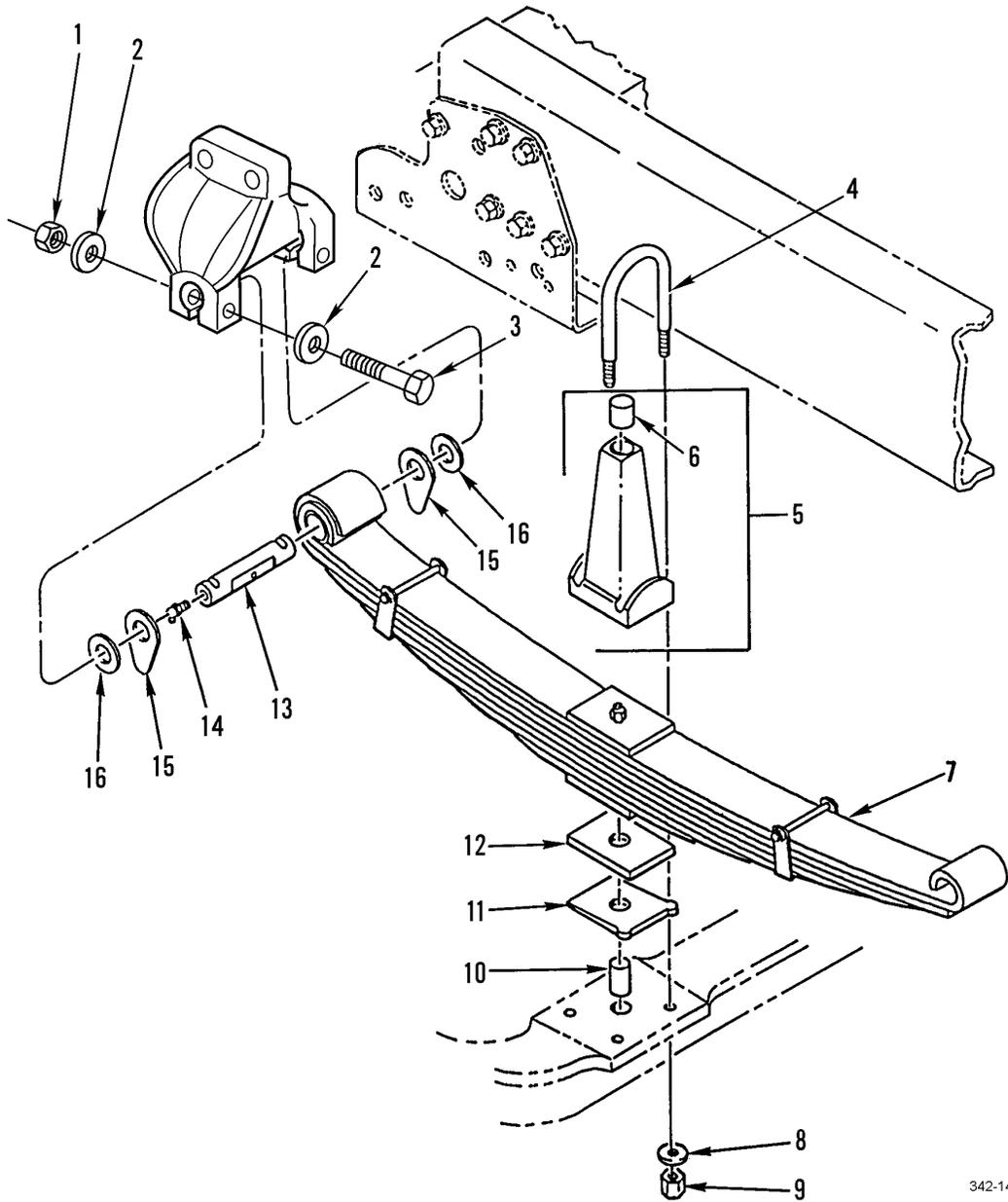

342-1467-1

Figure 192. Front Springs (Sheet 1 of 2)

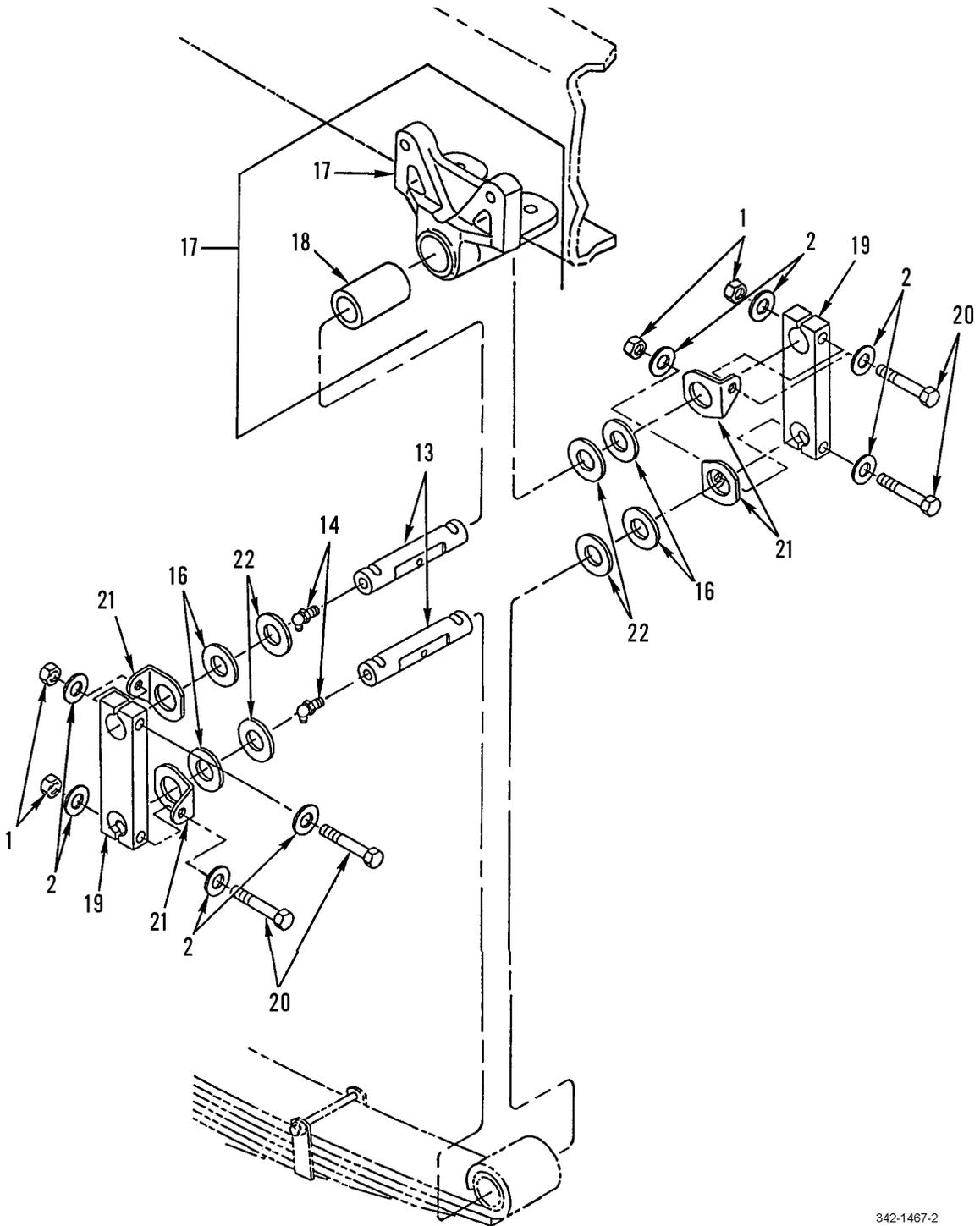

342-1467-2

Figure 192. Front Springs (Sheet 2 of 2)

SECTION II			TM9-2320-302-24P			
(1)	(2)	(3)	(4)	(5)	(6)	(7)
ITEM	SMR			PART		
NO	CODE	NSN	CAGEC	NUMBER	DESCRIPTION AND USABLE ON CODES(UOC)	QTY
GROUP 16 SPRINGS AND SHOCK ABSORBERS						
GROUP 1601 SPRINGS						
FIG. 192 FRONT SPRINGS						
1	PAFZZ	5310002256993	96906	MS51922-33	NUT, SELF-LOCKING, HE 1/2-13UNC.....	8
2	PAFZZ	5310002256993	96906	MS15795-818	WASHER, FLAT .531 ID X 1.062 OD.....	16
3	PAFZZ	5305000712079	80204	B1821BH050C400N	SCREW, CAP, HEXAGON H 1/2-13UNC X 4.00.....	4
4	PAFZZ		64678	11-09624-105	BOLT, U LEFT SIDE 7/8-14 X 4.94 X 10.50.....	2
4	PAFZZ	5306013275536	64678	11-09624-100	BOLT, U RIGHT SIDE 7/8-14 X 4.94 X 10.00.....	2
5	PFFZZ		64678	A16-14038-001	BRACKET, MOUNTING.....	2
6	PAFZZ		64678	11-17450-000	.BUMPER, NONMETALLIC.....	1
7	PAFZZ	2510014813358	64678	A16-13412-001	SPRING ASSEMBLY, LEA.....	2
8	PAFZZ	5310005847796	96906	MS15795-824	WASHER, FLAT .938 ID X 1.75 OD.....	8
9	PAFZZ	5310013431030	64678	23-00461-007	NUT, PLAIN, HEXAGON 7/8-14UNC.....	8
10	PAFZZ		64678	23-09271-238	BUSHING, SLEEVE RIGHT WHEEL, .75 OD X 2.38 LG.....	1
10	PAFZZ	3120014813166	64678	23-09271-262	BUSHING, SLEEVE LEFT WHEEL, .75 OD X 2.62 LG.....	1
11	PFFZZ	5365013568950	64678	16-13363-001	SHIM 0.151".....	V
11	PFFZZ	5365013568951	64678	16-13363-011	SHIM 0.457".....	V
11	PFFZZ		64678	16-13363-005	SHIM .273".....	V
11	PFFZZ		64678	16-13363-007	SHIM .334".....	V
11	PFFZZ		64678	16-13363-013	SHIM .518".....	V
11	PFFZZ		64678	16-13363-015	SHIM .577".....	V
11	PFFZZ		64678	16-13363-003	SHIM .212".....	V
11	PFFZZ		64678	16-13363-017	SHIM .639".....	V
12	PFFZZ	5365013291141	64678	16-10386-003	SPACER, PLATE.....	1
12	PFFZZ		64678	16-10386-002	SPACER, STRAIGHT.....	1
13	PAFZZ	3040013270143	64678	16-13470-000	SHAFT, STRAIGHT.....	4
14	PAOZZ	4730001720034	96906	MS15003-6	FITTING, LUBRICATION 1/8NPTF, 8/32 BASE.....	4
15	PAFZZ	5365013279084	64678	16-12265-000	SPACER, PLATE.....	4
16	PAFZZ	5310013306364	72741	730-012	WASHER, FLAT.....	V
17	PGFFF		64678	A16-12355-003	HANGER, SPRING, VEHIC.....	2
18	PAFZZ	2510014813360	28158	37992	.PIN, VEHICULAR LEAF.....	1
19	PAFZZ	2510013277773	64678	16-11890-000	SHACKLE, LEAF SPRING.....	4
20	PAFZZ	5305001397071	96906	MS35307-420	SCREW, CAP, HEXAGON H 3.250 X 13UNC..	8
21	PFFZZ	2510013269147	64678	16-09040-002	PLATE, WEAR, LEAF SPR.....	8
22	PAFZZ	5310013297043	64678	23-09114-009	WASHER, FLAT 1.12 X 2.25 X .18.....	8

END OF FIGURE

20
21 thru 27

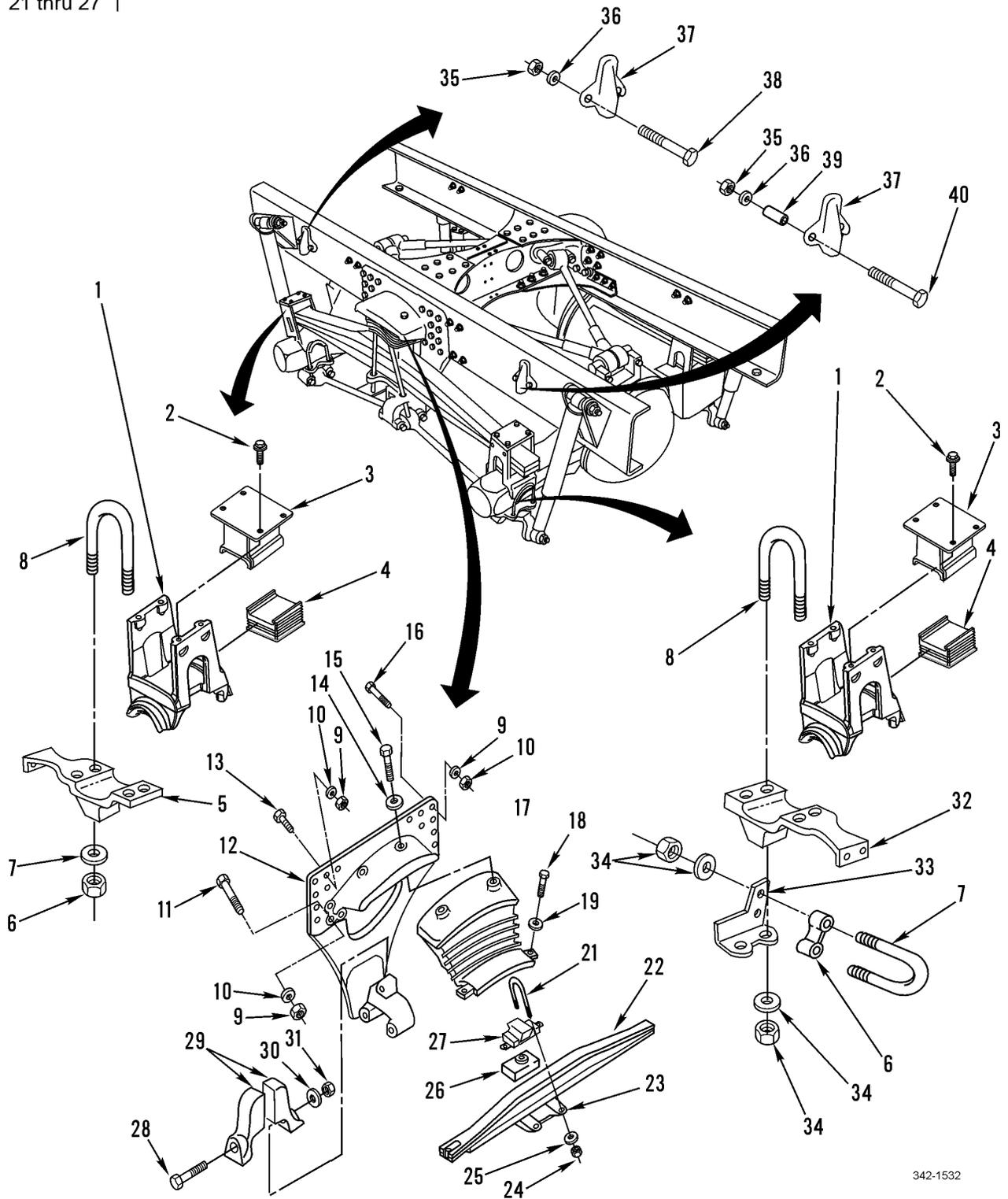

342-1532

Figure 193. Rear Spring Assembly

SECTION II		TM9-2320-302-24P				
(1)	(2)	(3)	(4)	(5)	(6)	(7)
ITEM NO	SMR CODE	NSN	CAGEC	PART NUMBER	DESCRIPTION AND USABLE ON CODES(UOC)	QTY
GROUP 1601 SPRINGS						
FIG. 193 REAR SPRING ASSEMBLY						
1	XDFZZ		64678	11-22804-000	CLAMP, AXLE.....	4
2	PAOZZ	5306014788505	64678	23-11007-125	BOLT, SHOULDER 3/8-16 X 1.25.....	16
3	XDFZZ		64678	11-20808-000	PAD, SPRING TIP.....	4
4	XDFZZ		64678	11-20807-000	PAD, SPRING TIP.....	4
5	XDFZZ		64678	11-22814-000	SPRING HANGER FORWARD.....	2
6	PAFZZ	5310014788953	64678	23-00461-005	NUT, PLAIN, HEXAGON 5/8-18 .844 HT...	16
7	PAFZZ	5310007208819	96906	MS15795-821	WASHER, FLAT 0.69 X 1.31 X .177.....	16
8	PAFZZ	5306014790376	64678	11-19895-000	BOLT, U.....	8
9	PAFZZ	5310002694040	81349	M45913/1-10CG5C	NUT, SELF-LOCKING, HE 5/8-11UNC.....	40
10	PAFZZ	5310007208819	96906	MS15795-821	WASHER, FLAT 0.69 X 1.31 X .177.....	80
11	PAFZZ	5305007247265	80204	B1821BH063C475N	SCREW, CAP, HEXAGON H.....	12
12	XDFZZ		64678	16-15066-004	BRACKET, MOUNTING.....	2
13	PAFZZ	5305007247263	80204	B1821BH063C425N	SCREW, CAP, HEXAGON H.....	12
14	PAFZZ	5310014788675	64678	23-09114-017	WASHER, FLAT.....	4
15	PAFZZ	5305014790499	64678	23-12567-100	SCREW, CAP, HEXAGON H 1 2-13 1.00, NYLON PATCH.....	4
16	PAFZZ	5305009432094	96906	MS35307-470	SCREW, CAP, HEXAGON H.....	16
17	PAFZZ		64678	16-15010-000	BEARING, CENTER.....	2
18	PAFZZ	5305014790308	64678	23-12576-125	SCREW, CAP, HEXOGON H.....	4
19	PAFZZ	5310014788671	64678	23-09114-013	WASHER, FLAT.....	4
20	AF FFF		64678	A16-15023-005	SPRING ASSEMBLY, LEA.....	2
21	PAFZZ	5306014790577	64678	16-14511-003	.BOLT, U 3/4-16.....	2
22	PAFZZ	5360014787764	64678	16-15724-002	.SPRING, LEAF.....	1
23	XDFZZ		64678	16-15103-000	.RETAINER, U BOLT.....	1
24	PAFZZ	5310014788946	64678	23-00461-006	.NUT, PLAIN, HEXAGON 3/4-16 X 1.0 HT.	4
25	PAFZZ	5310005847799	96906	MS15795-822	.WASHER, FLAT 0.81 X 1.47 X .177.....	4
26	XDFZZ		64678	A16-15074-000	.SPACER ASSY.....	1
27	XDFZZ		64678	16-15011-000	.SEAT, MTG, BEARING.....	1
28	PAFZZ	5305000712078	80204	B1821BH050C375N	SCREW, CAP, HEXAGON H 1/2-13 X 3.75..	2
29	XDFZZ		64678	16-15067-001	STOP.....	4
30	PAFZZ	5310011091977	19207	11628332-2	WASHER, FLAT 1/2 X 1.06 X .14.....	4
31	PAFZZ		81439	M45913/1-8CG5C	NUT, SELF-LOCKING, HE 1/2-13.....	2
32	XDFZZ		64678	11-22815-000	SPRING HANGER REAR.....	2
33	XDFZZ		64678	11-20810-000	BRACKET, SUPPORT FOR REAR-REAR AXLE.	2
34	PAFZZ	5340012151558	72741	656212	CLAMP, LOOP.....	2
35	PAFZZ	5310014789028	64678	23-09901-110	NUT, SELF-LOCKING, HE 5/8-11UNC.....	8
36	PAFZZ	5310013052539	64678	23-09114-000	WASHER, FLAT .69 X 1.31 X .177.....	16
37	XDFZZ		64678	16-15073-000	STOP, AXLE.....	4
38	PAFZZ	5305007247225	80204	B1821BH063C275N	SCREW, CAP, HEXAGON H USED TO SECURE FORWARD AXLE STOPS.....	4
39	XDFZZ		64678	23-11710-040	SPACER USED ON REAR STOP ONLY, .688 X 1.312 OD X 0.40.....	4
40	PAFZZ	5305007247236	80204	B1821BH063C325N	SCREW, CAP, HEXAGON H USED TO SECURE REAR-REAR AXLE STOPS.....	4

END OF FIGURE

SECTION II			TM9-2320-302-24P			
(1)	(2)	(3)	(4)	(5)	(6)	(7)
ITEM	SMR			PART		
NO	CODE	NSN	CAGEC	NUMBER	DESCRIPTION AND USABLE ON CODES(UOC)	QTY
GROUP 1604 SHOCK ABSORBER EQUIPMENT						
FIG. 194 FRONT SHOCK ABSORBER						
1	PAOZZ	5310014789022	64678	23-09337-113	NUT,SELF LOCKING 3/4-16 NYLON	4
					INSERT.....	
2	XDOZZ		64678	23-00600-075	WASHER 25/32 THK X 0.75 ID X 2.0 OD	4
3	PFOZZ		27387	60593-5	BUSHING,NONMETALLIC.....	8
4	XDOZZ		64678	10-12233-000	BRACKET,MOUNTING UPPER.....	2
5	PAOZZ		81439	M45913/1-8CG5C	NUT,SELF-LOCKING,HE 1/2-13.....	4
6	PAOZZ	5310007679425	96906	MS15795-818	WASHER,FLAT.....	8
7	PAOZZ	5305000712070	80204	B1821BH050C175N	SCREW,CAP,HEXAGON H 1/2-13UNC X	4
					1.750.....	
8	XDOZZ		64678	A10-09972-001	BRACKET,MOUNTING L.H.....	1
8	XDOZZ		64678	A10-09972-002	BRACKET,MOUNTING R.H.....	1
9	PAOZA	2510014791515	64678	10-12032-002	SHOCK ABSORBER,DIRE.....	2

END OF FIGURE

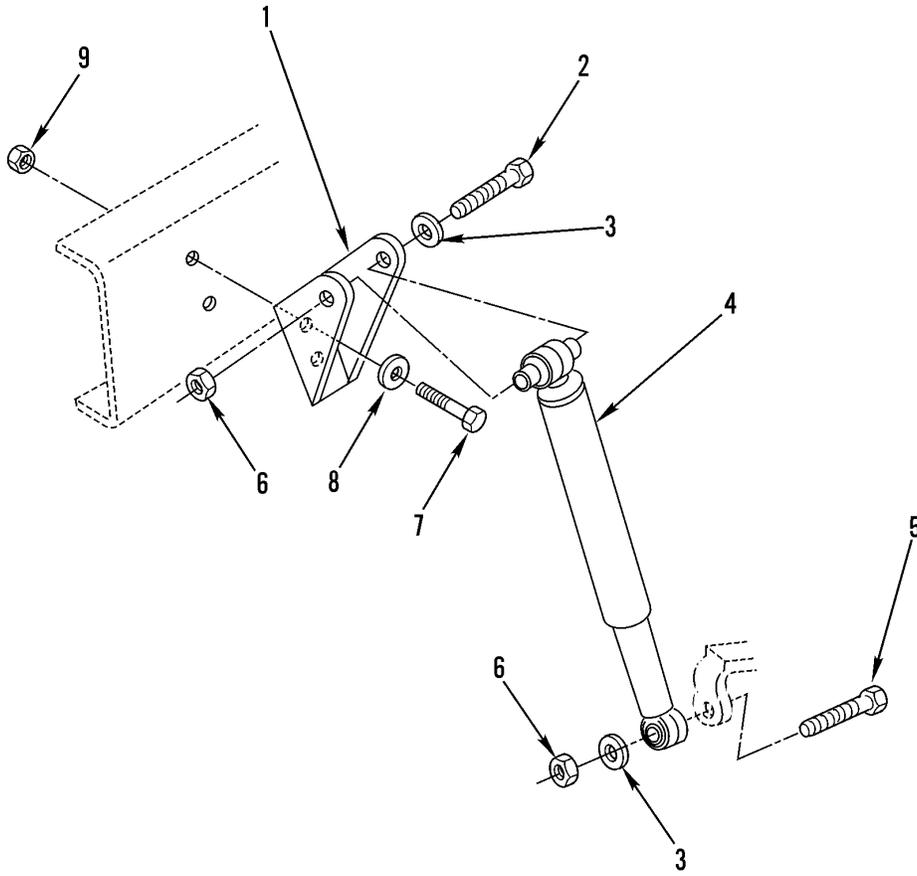

342-1430

Figure 195. Rear Shock Absorber

SECTION II			TM9-2320-302-24P			
(1)	(2)	(3)	(4)	(5)	(6)	(7)
ITEM	SMR			PART		
NO	CODE	NSN	CAGEC	NUMBER	DESCRIPTION AND USABLE ON CODES(UOC)	QTY

GROUP 1604 SHOCK ABSORBER EQUIPMENT

FIG. 195 REAR SHOCK ABSORBER

1	XDOZZ		64678	16-14044-000	BRACKET,SHOCK ABSBR.....	4
2	PAOZZ	5305009474364	80204	B1821BH075C600N	SCREW,CAP,HEXAGON H 3/4-10 X 6.....	4
3	PAOZZ	5310012751065	96906	MS51412-13	WASHER,FLAT 0.81 X 1.47 X .177.....	16
4	PAOZA	2510014792207	64678	16-15450-000	SHOCK ABSORBER,DIRE.....	4
5	PAOZZ	5305009474359	80204	B1821BH075C425N	SCREW,CAP,HEXAGON H 3/4-10 X 4.25..	4
6	PAOZZ	5310000676356	81349	M45913/2-12CG5C	NUT,SELF-LOCKING,HE 3/4-10 UNC.....	8
7	PAOZZ	5305007247222	80204	B1821BH063C200N	SCREW,CAP,HEXAGON H 5/8-11 X 2.00..	8
8	PAOZZ	5310013052539	64678	23-09114-000	WASHER,FLAT .69 X 1.31 X .177.....	16
9	PAOZZ	5310014789028	64678	23-09901-110	NUT,SELF-LOCKING,HE 5/8-11 UNC.....	8

END OF FIGURE

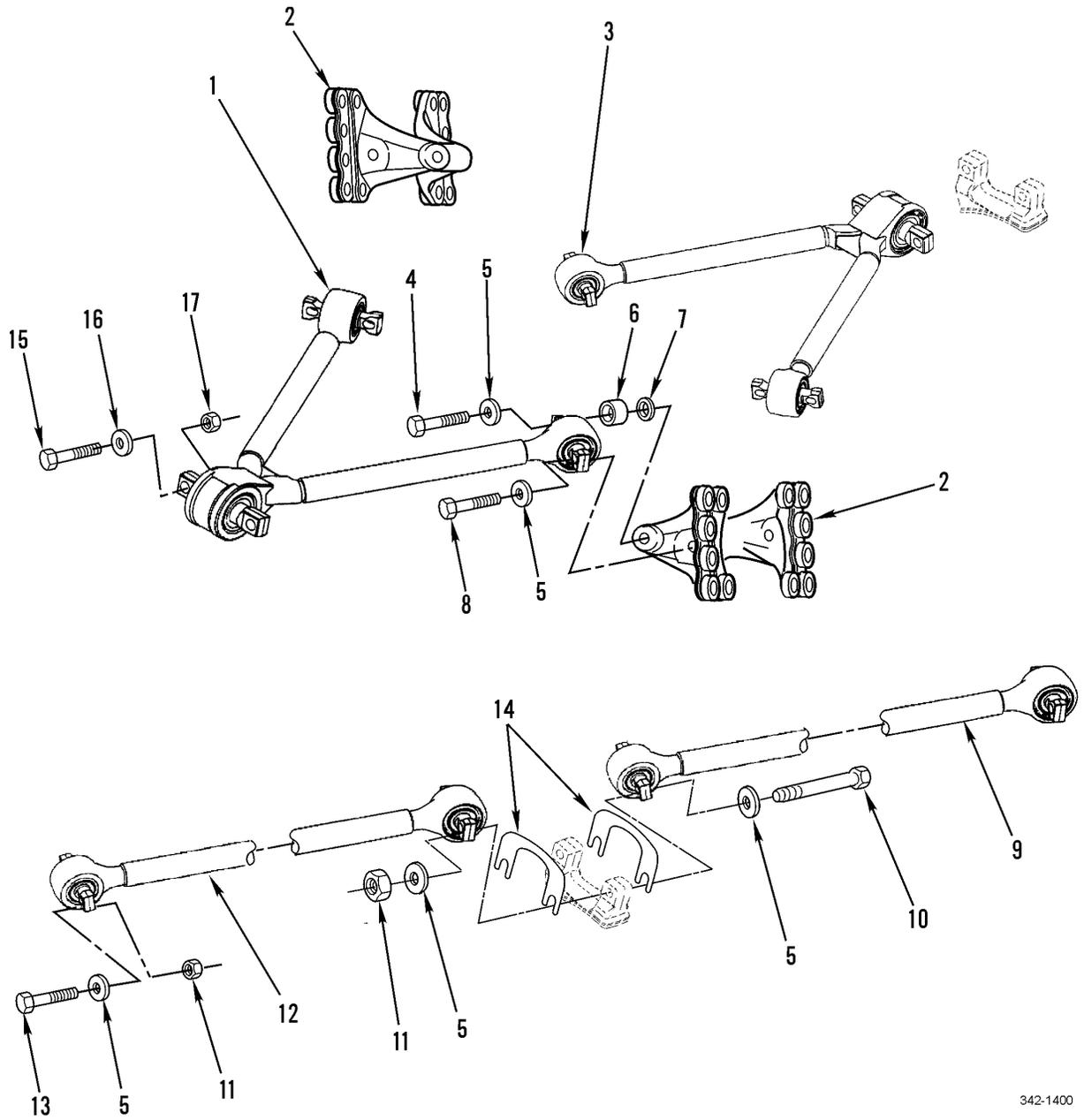

342-1400

Figure 196. Rear Suspension Torque Rods and Attaching Hardware

SECTION II			TM9-2320-302-24P			
(1)	(2)	(3)	(4)	(5)	(6)	(7)
ITEM	SMR			PART		
NO	CODE	NSN	CAGEC	NUMBER	DESCRIPTION AND USABLE ON CODES(UOC)	QTY
					GROUP 1605 TORQUE, RADIUS, AND STABILIZER RODS	
					FIG. 196 REAR SUSPENSION TORQUE RODS AND ATTACHING HARDWARE	
1	PAFZA	2530014791066	64678	16-15001-000	TORQUE ROD,TANDEM A UPPER FORWARD- REAR.....	1
2	XDFZZ		64678	16-15071-001	BRACKET,TORQUE ROD.....	2
3	PFFZA	2530014791172	64678	16-15001-001	TORQUE ROD,TANDEM A UPPER REAR-REAR	1
4	PAFZZ	5305007247263	80204	B1821BH063C425N	SCREW,CAP,HEXAGON H 5/8-11 X 4.25..	4
5	PAFZZ	5310013052539	64678	23-09114-000	WASHER,FLAT 0.69 X 1.31 X .177.....	36
6	XDFZZ		64678	23-11710-150	SPACER .688 X 1.312 OD X 150.....	8
7	XDFZZ		64678	23-11710-038	SPACER .688 X 1.312 OD X 0.38 T....	8
8	PAFZZ	5305009432092	96906	MS35307-468	SCREW,CAP,HEXAGON H 5/8-11 C 3.00..	4
9	PAFZA	2530014791053	64678	16-15002-001	TORQUE ROD,TANDEM LOWER REAR.....	2
10	PAFZZ	5305014790553	64678	23-09444-675	SCREW,CAP,HEXAGON H 5/8-11 X 6.75..	4
11	PAFZZ	5310014789028	64678	23-09901-110	NUT,SELF-LOCKING,HE 5/8-11 UNC.....	12
12	PAFZA	2530014791184	64678	16-15002-000	TORQUE ROD,TANDEM LOWER FORWARD....	2
13	PAFZZ	5305007247236	80204	B1821BH063C325N	SCREW,CAP,HEXAGON H 5/8-11 X 3.25..	8
14	XDFZZ		64678	16-15076-000	SPACER.....	4
15	PAFZZ	5305009265517	96906	MS90727-219	SCREW,CAP,HEXAGON H 7/8-14 X 4.5...	4
16	PAFZZ	5310005847796	96906	MS15795-824	WASHER,FLAT 0.94 X 1.75 X .177.....	8
17	PAFZZ		64678	23-09901-214	NUT,SELF-LOCKING 7/8-14 UNF.....	4

END OF FIGURE

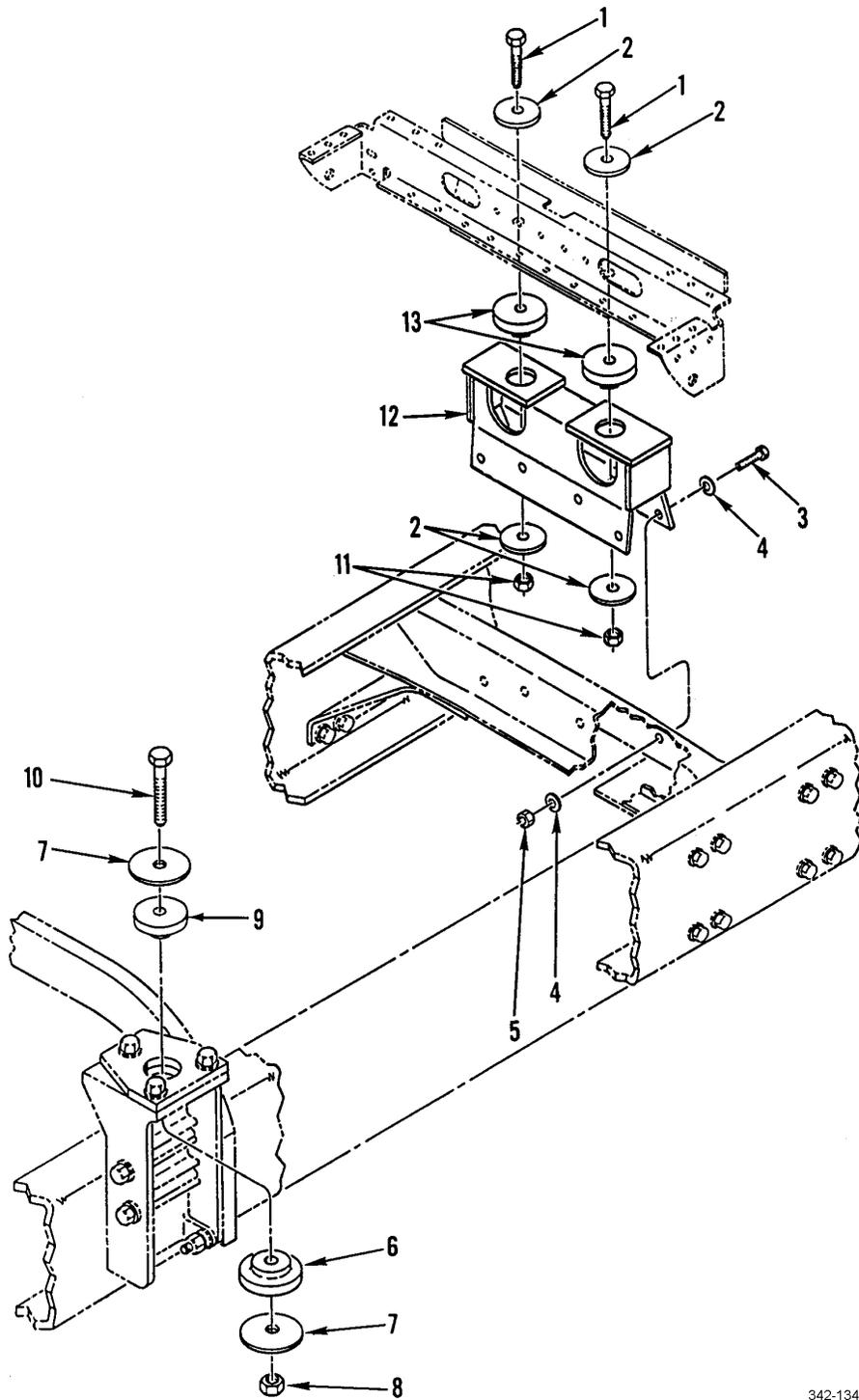

342-1342

Figure 197. Cab Mounting Hardware

SECTION II			TM9-2320-302-24P			
(1)	(2)	(3)	(4)	(5)	(6)	(7)
ITEM	SMR			PART		
NO	CODE	NSN	CAGEC	NUMBER	DESCRIPTION AND USABLE ON CODES(UOC)	QTY
					GROUP 18 BODY, CAB, HOOD, AND RAIL GROUP 1801 BODY, CAB, HOOD, AND HULL ASSEMBLIES	
					FIG. 197 CAB MOUNTING HARDWARE	
1	PAFZZ	5305007247254	80204	B1821BH063C400N	SCREW,CAP,HEXAGON H 5/8-11 -2	2
					4.00.....	
2	PAFZZ	5310013267480	64678	18-15174-008	WASHER,FLAT.....	4
3	PAFZZ	5305000680511	80204	B1821BH038C125N	SCREW,CAP,HEXAGON H 3/8-16UNC X	8
					1.25.....	
4	PAFZZ	5310000806004	96906	MS27183-14	WASHER,FLAT 0.406 ID X 0.812 OD X	16
					0.065 THK.....	
5	PAFZZ	5310000874652	96906	MS51922-17	NUT,SELF-LOCKING,HE 3/8-16UNC.....	8
6	PAFZZ	5342013367037	4R901	660570	MOUNT,RESILIENT FRONT LOWER.....	2
7	PAFZZ	5310013366861	64678	681 317 04 76	WASHER,FLAT 3.50 X 0.25.....	4
8	PAFZZ	5310000676356	96906	MS51922-57	NUT,SELF-LOCKING,HE 3/4-10UNC.....	2
9	PAFZZ	3120014087869	4R901	811320	BUSHING,SLEEVE CAB MOUNT, UPPER FRONT.....	2
10	PAFZZ	5305009474360	80204	B1821BH075C450N	SCREW,CAP,HEXAGON H 3/4-10UNC-2A X	2
					4.50.....	
11	PAFZZ	5310002694040	96906	MS51922-49	NUT,SELF-LOCKING,HE 5/8-11UNC.....	2
12	PAFZZ	2590013387391	64678	A18-24201-000	BRACKET,VEHICULAR C.....	1
13	PAFZZ	5342013364250	76005	J-2610-46	MOUNT,RESILIENT.....	2

END OF FIGURE

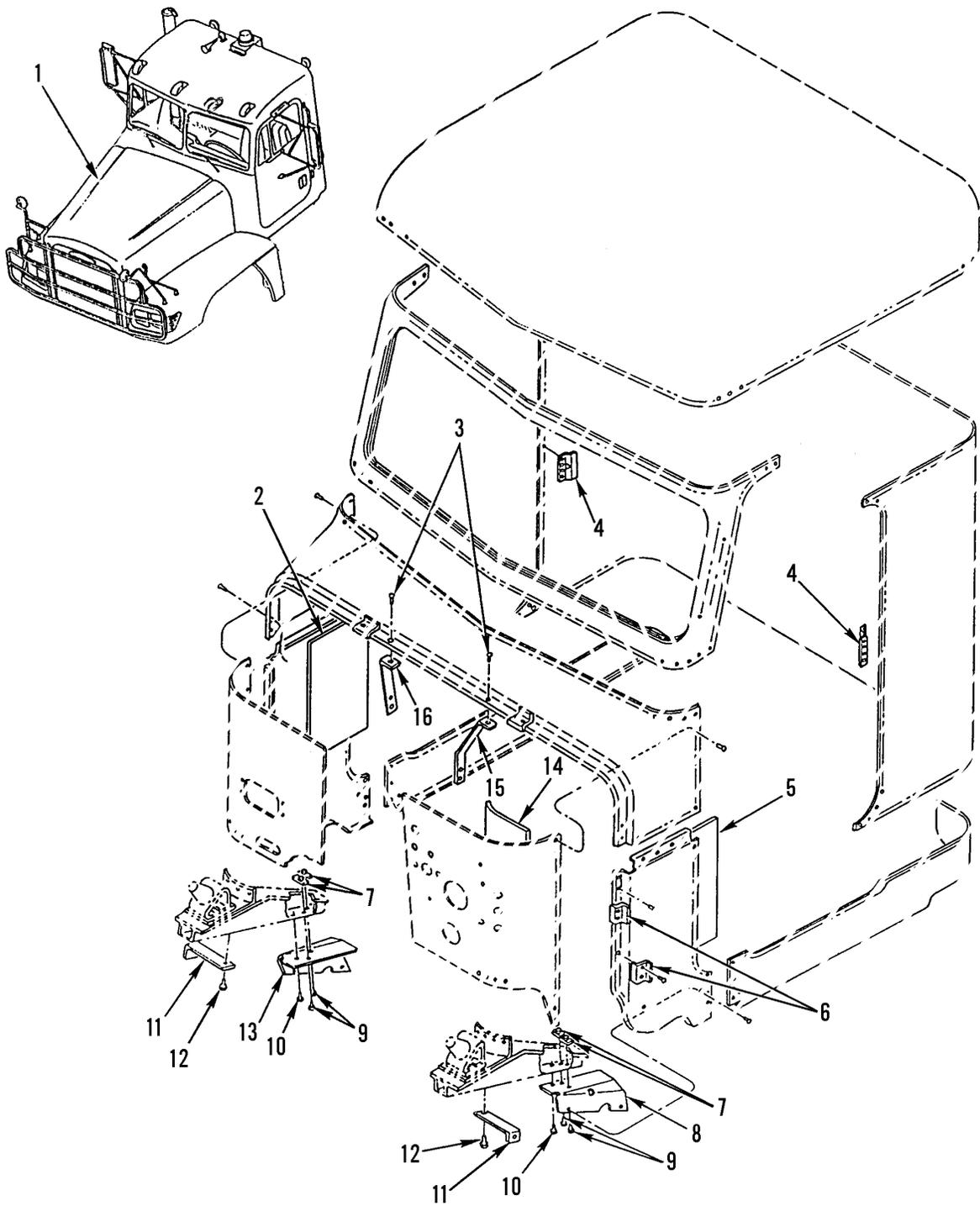

342-1474

Figure 198. Cab Frame Components

SECTION II			TM9-2320-302-24P			
(1)	(2)	(3)	(4)	(5)	(6)	(7)
ITEM	SMR			PART		
NO	CODE	NSN	CAGEC	NUMBER	DESCRIPTION AND USABLE ON CODES(UOC)	QTY
GROUP 1801 BODY, CAB, HOOD, AND HULL ASSEMBLIES						
FIG. 198 CAB FRAME COMPONENTS						
1	PBHHH	2510014802400	64678	FTL/M915A3CAB	CAB ASSEMBLY COMPLETE CAB ASSEMBLY.	1
2	PAHZZ	5640013495289	64678	18-25657-000	INSULATION FELT,THE.....	1
3	PAHZZ	5320012702952	19738	2771-0617	RIVET,BLIND.....	6
4	XDHZZ		64678	18-17951-000	REINFORCEMENT.....	2
5	PFHZZ	2510013374143	64678	18-25627-000	INSULATION PANEL,VE.....	1
6	PFHZZ	2540013381710	64678	18-25509-000	GUIDE,HOOD VEHICULA.....	6
7	PAHZZ	3120012987357	19738	1981-0800	BUSHING,SLEEVE 1/4 INCH.....	4
8	XDHZZ		64678	18-25612-000	REINFORCEMENT LEFT.....	1
9	PAHZZ	5305012987333	19738	1901-0810	SCREW,TAPPING 1/4 INCH X 5/8.....	4
10	PAHZZ	5320011570908	19738	2771-0817	RIVET,BLIND.....	2
11	XDHZZ		64678	18-25178-000	BRACE,COWL.....	2
12	PAHZZ	5305011373938	96906	MS51871-3	SCREW,TAPPING.....	2
13	XDHZZ		64678	18-25612-001	REINFORCEMENT.....	1
14	PFHZZ	2510013374144	64678	18-25628-000	INSULATION PANEL,VE.....	1
15	XDHZZ		64678	18-25653-000	BRACE,COWL TOP LH.....	1
16	XDHZZ		64678	18-25652-000	BRACE,COWL TOP RH.....	1

END OF FIGURE

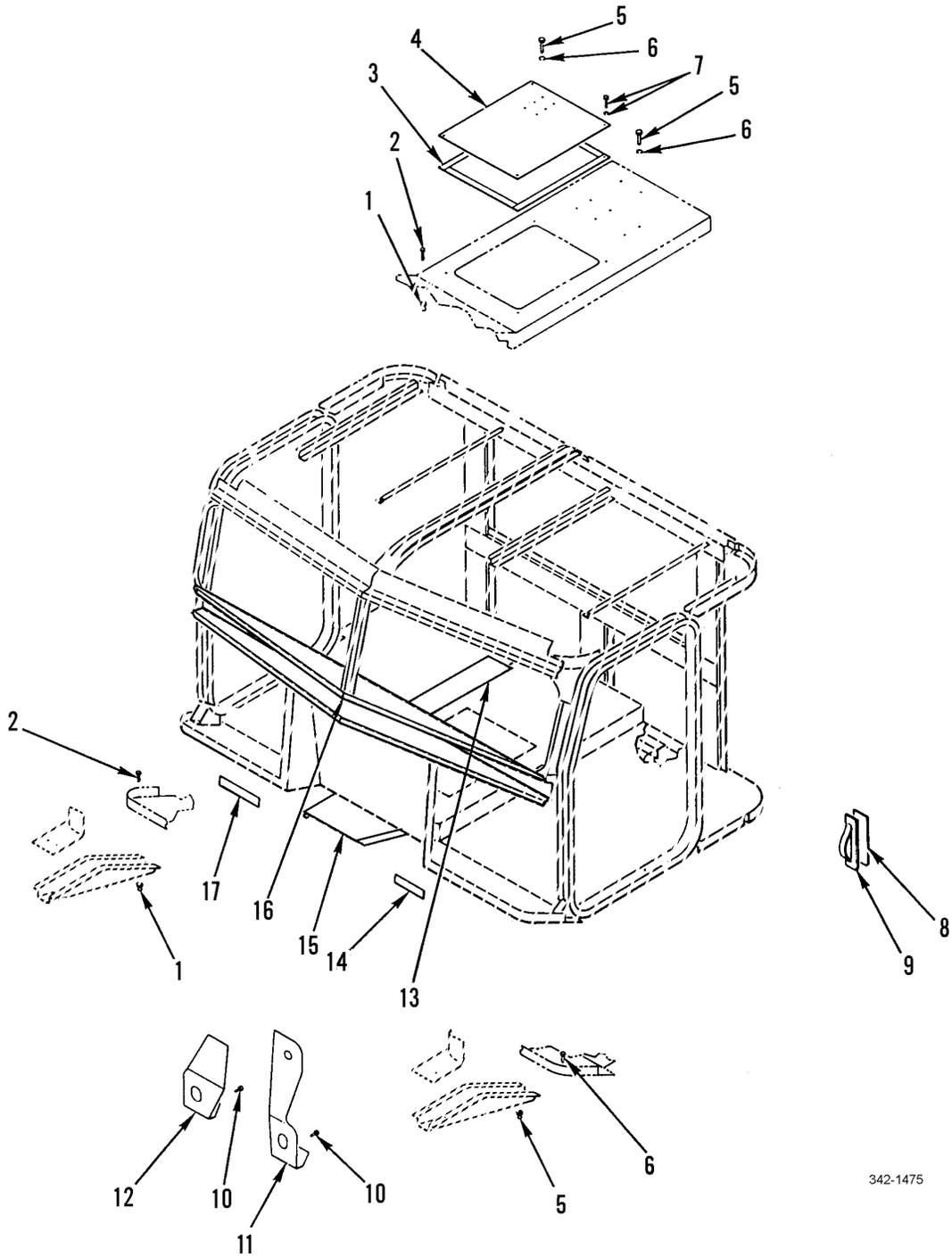

342-1475

Figure 199. Cab Components

SECTION II			TM9-2320-302-24P			
(1)	(2)	(3)	(4)	(5)	(6)	(7)
ITEM	SMR			PART		
NO	CODE	NSN	CAGEC	NUMBER	DESCRIPTION AND USABLE ON CODES(UOC)	QTY
GROUP 1801 BODY, CAB, HOOD, AND HULL ASSEMBLIES						
FIG. 199 CAB COMPONENTS						
1	PFHZZ	3120012987357	19738	1981-0800	BUSHING,SLEEVE 1/4 INCH.....	189
2	PFHZZ	5305012987333	19738	1901-0810	SCREW,TAPPING 1/4 INCH X 5/8.....	189
3	MHHZZ		64678	48-00050-206X6	TAPE,FOAM MAKE FROM CAGE 12624 , PN V532X3/4INX200FT, 6 FT.....	1
4	XDHZZ		64678	A18-29448-003	COVER,ACCESS.....	1
5	PAHZZ	5305002253842	80204	B1821BH025C113N	SCREW,CAP,HEXAGON H 1/4-20UNC-2A X 1.125.....	6
6	PAHZZ	5310005825965	96906	MS35338-44	WASHER,LOCK 1/4 NOM SIZE.....	6
7	PAHZZ	5305013373804	64678	23-10891-075	SCREW,SELF-DRILLING.....	12
8	MHHZZ		64678	48-02454-206X12	TAPE,URETH FOAM MAKE FROM CAGE 12624, PN V4062,12 FT.....	1
9	XDHZZ		64678	18-17733-000	BRACKET,SEAL,FLG.....	2
10	PAHZZ	5306013412895	9K475	C120LB-R12-4	BOLT,SHOULDER 3/8 X .625GR.....	12
11	XDHZZ		64678	A18-23836-001	PLATE,FRONT CAB MTG.....	1
12	XDHZZ		64678	18-23837-003	MOUNT,CAB,RH.....	1
13	XDHZZ		64678	22-46220-000	DUCT,HEATER/AC.....	1
14	XDHZZ		64678	18-24095-000	SHIM,CAB MT,CONV.....	1
15	XDHZZ		64678	18-28345-000	HEAT SHIELD,EXH.....	1
16	PFHZZ	5340013364022	64678	18-23534-001	BRACKET,MOUNTING.....	1
17	XDHZZ		64678	18-24095-001	SHIM,CAB MT,CONV.....	1

END OF FIGURE

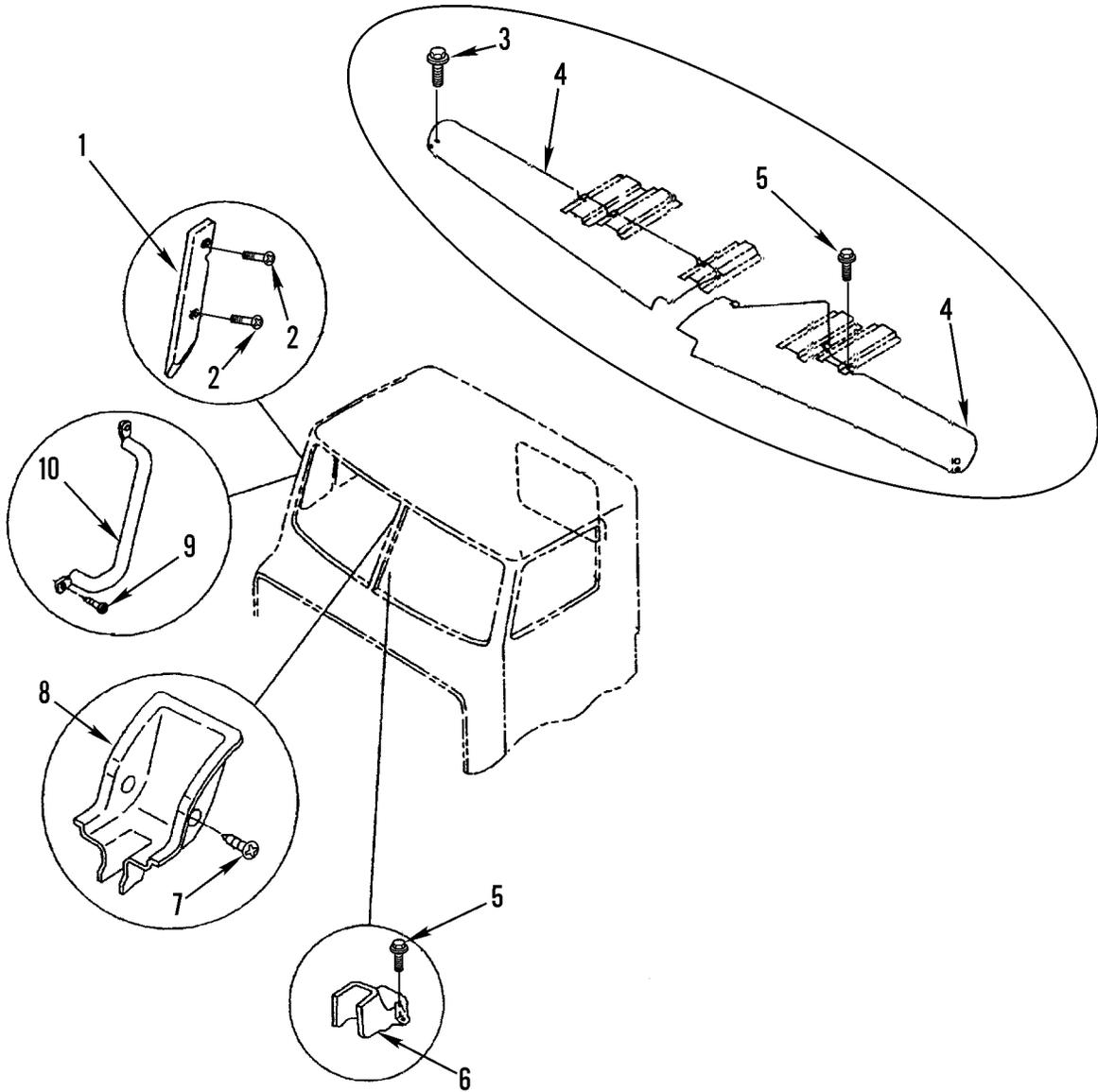

342-1476

Figure 200. Cab Interior Trim Components

SECTION II			TM9-2320-302-24P			
(1)	(2)	(3)	(4)	(5)	(6)	(7)
ITEM	SMR			PART		
NO	CODE	NSN	CAGEC	NUMBER	DESCRIPTION AND USABLE ON CODES(UOC)	QTY
					GROUP 1801 BODY, CAB, HOOD, AND HULL ASSEMBLIES	
					FIG. 200 CAB INTERIOR TRIM COMPONENTS	
1	XDOZZ		64678	18-28020-000	MOLDING, PLASTIC L.H.....	1
1	XDOZZ		64678	18-28020-001	MOLDING, PLASTIC R.H.....	1
2	PAOZZ		64678	23-12114-000	FASTENER, TRIM, RIBBE.....	4
3	PAOZZ	5305013369466	64678	23-11657-305	SCREW, TAPPING 8-18 X 5/8.....	2
4	XDOZZ		64678	18-21756-000	MOLDING, PLASTIC.....	1
5	PFOZZ	5305009846193	96906	MS35206-245	SCREW, MACHINE 8-32 X 1/2, PAN HEAD, CROSS RECESS.....	3
6	XDOZZ		64678	18-27692-000	COVER, CTR POST, LWR.....	1
7	PAOZZ		31033	PC47607VN208	FASTENER, TRIM, RIBBE.....	2
8	XDOZZ		64678	18-27690-000	MOLDING, PLASTIC.....	1
9	PAOZZ	5305011373938	96906	MS51871-3	SCREW, TAPPING.....	2
10	PAOZZ	5340013387068	64678	A18-19194-000	HANDLE, BOW.....	1

END OF FIGURE

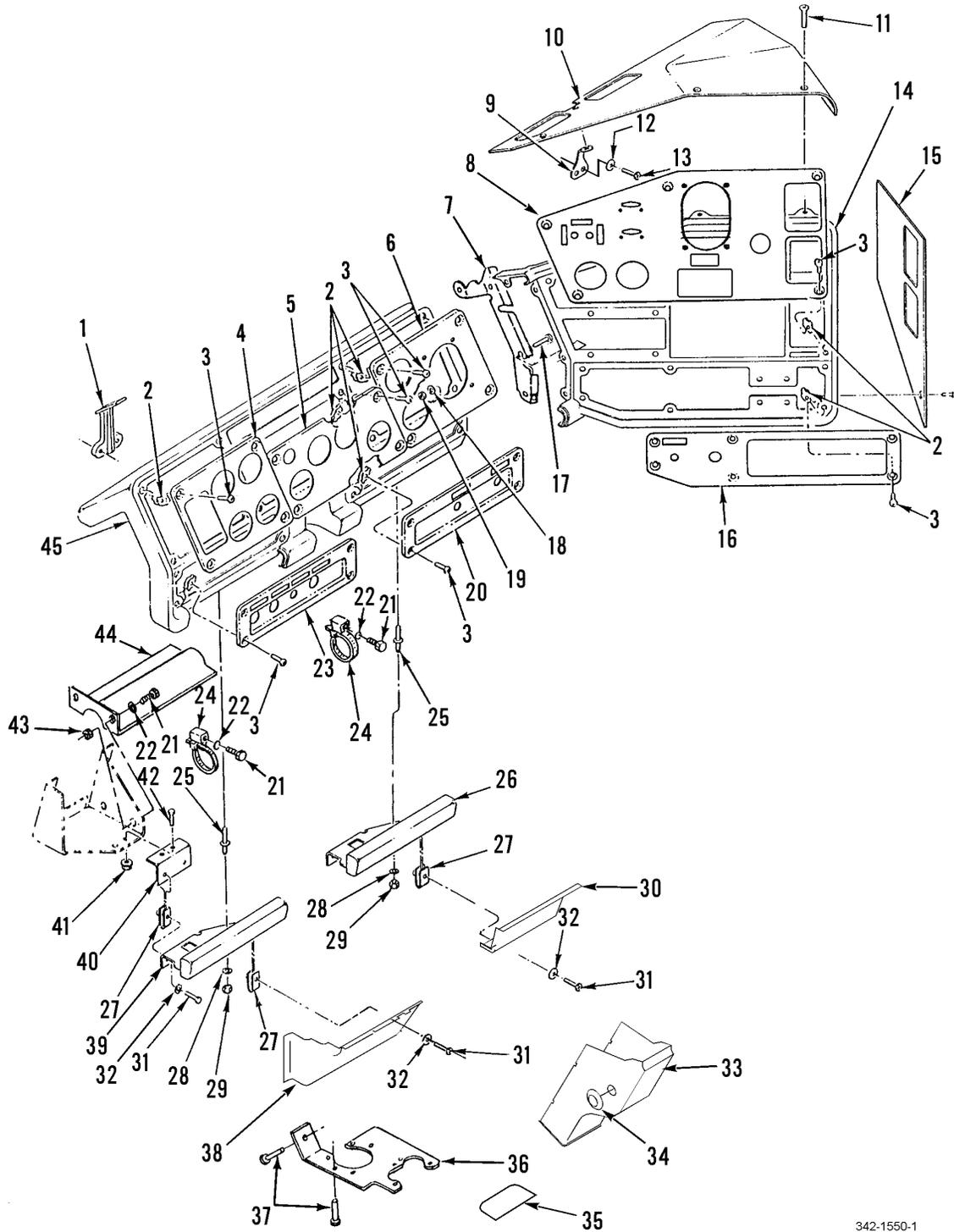

342-1550-1

Figure 201. Dashboard Assembly (Sheet 1 of 2)

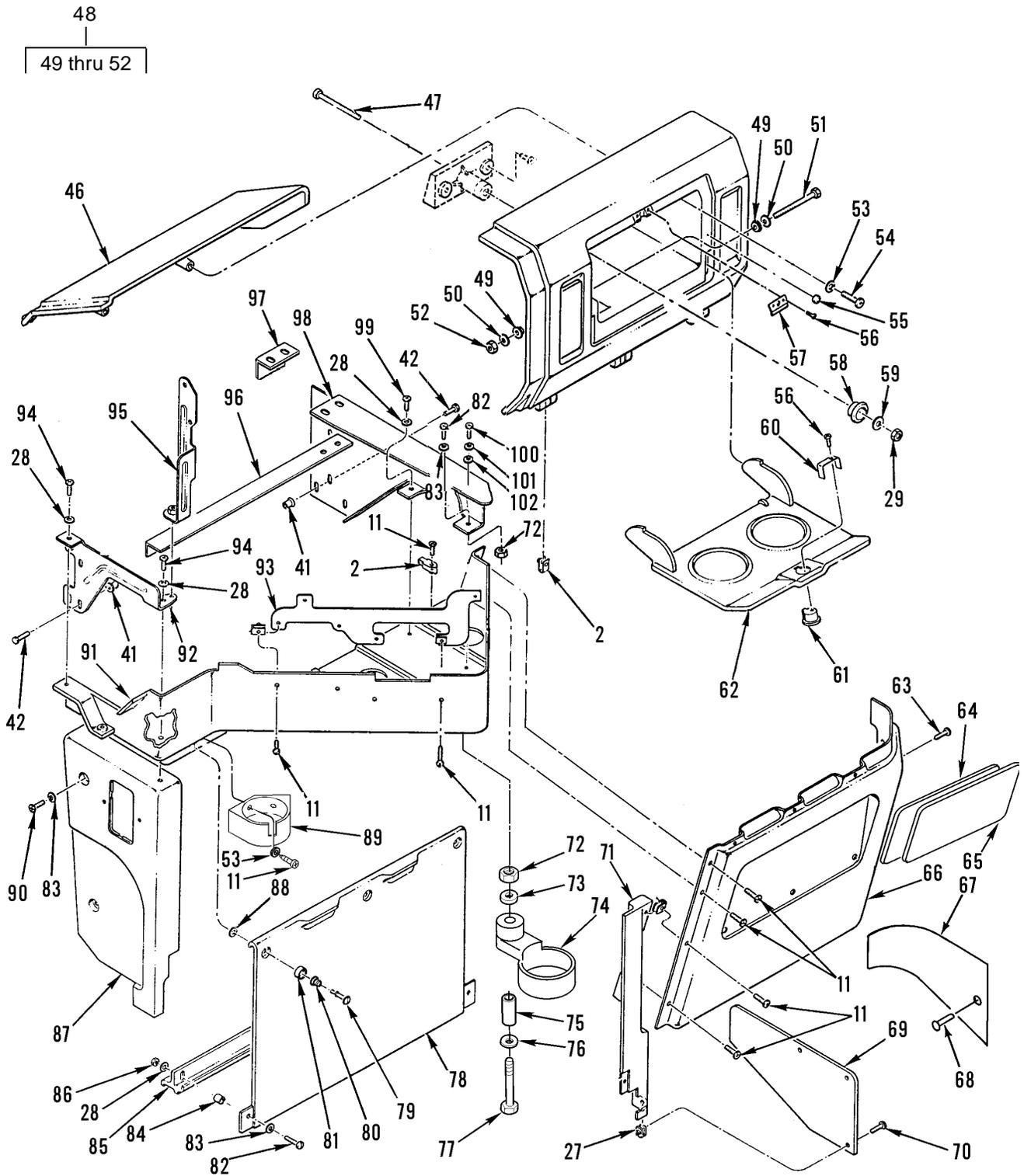

342-1550-2

Figure 201. Dashboard Assembly (Sheet 2 of 2)

SECTION II			TM9-2320-302-24P			
(1)	(2)	(3)	(4)	(5)	(6)	(7)
ITEM	SMR			PART		
NO	CODE	NSN	CAGEC	NUMBER	DESCRIPTION AND USABLE ON CODES(UOC)	QTY
GROUP 1801 BODY, CAB, HOOD, AND HULL ASSEMBLIES						
FIG. 201 DASHBOARD ASSEMBLY						
1	PFOZZ	5340013366809	64678	18-17268-000	BRACKET,MOUNTING.....	3
2	PFOZZ	5310013384116	64678	23-11668-000	NUT,CLIP-ON 10-16 N.S. THREAD.....	16
3	PAOZZ	5305013650343	64678	23-11344-088	SETSCREW 10-16 X 7/8, OVAL HEAD, CROSS RECESS.....	31
4	PFOZZ	2510014429289	64678	22-34806-001	PANEL,VEHICULAR OPE.....	1
5	XDOZZ		64678	22-43373-007	PANEL,VEHICULAR,OPE CENTER, W/ SPEEDO & TECH.....	1
6	PFOZZ	2510014425470	64678	22-34805-001	PANEL,VEHICULAR OPE.....	1
7	PFOZZ	5340014106637	64678	18-25631-002	BRACKET,MOUNTING.....	1
8	XDOZZ		64678	22-49591-002	PANEL,VEHICULAR OPE.....	1
9	PFOZZ	5340013367827	64678	18-22457-001	BRACKET,MOUNTING.....	1
10	PFOZZ	2590013448439	64678	A18-19569-003	PAD,CUSHIONING.....	1
11	PAOZZ	5305013366830	64678	23-11345-710	SETSCREW.....	11
12	XDOZZ		64678	23-09426-203	WASHER 1/4 ID X 1.0 OD.....	2
13	XDOZZ		64678	23-11164-710	SCREW,MACHINE 1/4-20 X 1.00 TORX HEAD.....	1
14	PFHZZ		64678	18-22127-006	PANEL,VEHICULAR,OPE.....	1
15	PFOZZ	5340013367696	64678	A18-19555-003	COVER,ACCESS.....	1
16	XDOZZ		64678	22-34916-001	PANEL,VEHICULAR OPE.....	1
17	PAOZZ	5305013366595	64678	23-10410-712	SCREW,MACHINE .281 ID X .625 OD X .065 THK.....	3
18	PAOZZ	5310005568420	94223	1183	WASHER,FLAT 3/16 ID X 3/4 OD X .05 THK.....	6
19	PAOZZ	5310013294045	64678	23-09336-005	NUT,SELF-LOCKING,CL 1/4-20UNC.....	3
20	PFOZZ	2510013657135	64678	22-35018-000	PANEL,VEHICULAR OPE.....	1
21	PAOZZ	5305000680508	80204	B1821BH025C075N	SCREW,CAP,HEXAGON H 1/4-20 X 0.75..	2
22	PAOZZ	5310008094058	96906	MS27183-10	WASHER,FLAT .281 ID X .625 OD X .065 THK.....	4
23	XDOZZ		64678	22-35017-001	PANEL,VEHICULAR OPE LEFT SIDE SWITCHS.....	1
24	PAOZZ	5975013507083	53421	T120MR	STRAP,TIEDOWN,ELECT.....	2
25	PFOZZ	5307013367673	64678	23-11632-000	STUD,SHOULDERED.....	1
26	PFOZZ	5340013366030	64678	A18-26081-000	BRACKET,MOUNTING R.H.....	1
27	PFOZZ	5310013372353	64678	23-11865-000	NUT,CLIP-ON 10-16.....	21
28	PAOZZ	5310008094058	96906	MS27183-10	WASHER,FLAT .281 ID X .625 OD X .065 THK.....	19
29	PAOZZ	5310000881251	81349	M45913/1-4CG5C	NUT,SELF LOCKING,HE.....	1
30	PFOZZ		64678	18-26759-000	PANEL,VEHICULAR,OPE R.H.....	1
31	XDOZZ		64678	23-11160-706	SCREW,MACHINE 10-24 X .75 TORX HEAD	2
32	PAOZZ	5310006877697	70210	S8157N100-063	WASHER,FLAT.....	7
33	PFOZZ		64678	18-24027-009	HOUSING,STEERING,CO.....	1
34	XDOZZ		64678	23-11689-008	PLUG,PROTECTIVE,DUS 1.00 X .08.....	2
35	XDOZZ		64678	18-2133-000	COVER,DIAGNOSTIC PL.....	1
36	XDOZZ		64678	18-30008-000	BRACKET,DATA PLUG.....	1
37	PAOZZ		64678	23-11345-707	SCREW,MACHINE 10B,DOG PT,BLK.....	3
38	PFOZZ		64678	18-26758-006	PANEL,VEHICULAR,OPE L.H.....	1
39	PFOZZ		64678	A18-26081-001	BRACKET,VEHICULAR,C.....	1

SECTION II		TM9-2320-302-24P				
(1)	(2)	(3)	(4)	(5)	(6)	(7)
ITEM	SMR			PART		
NO	CODE	NSN	CAGEC	NUMBER	DESCRIPTION AND USABLE ON CODES(UOC)	QTY
40	PFOZZ	5340013365955	64678	18-26082-000	BRACKET,ANGLE.....	1
41	PFOZZ	3120012987357	19738	1981-0800	BUSHING,SLEEVE 1/4 INCH.....	20
42	PAOZZ	5305012987333	19738	1901-0810	SCREW,TAPPING 1/4 INCH X 5/8.....	20
43	PAOZZ	5310000881251	81349	M45913/1-4CG5C	NUT,SELF LOCKING,HE 1/4-20UNC.....	2
44	XDOZZ		64678	06-13076-000	SHIELD,ELECT-WIRING.....	1
45	XDOZZ		64678	A18-22178-017	PANEL,VEHICULAR OPE.....	1
46	PFOZZ	2510013382317	64678	A18-18585-003	PANEL,BODY,VEHICULA.....	1
47	PAOZZ	5305000712510	80204	B1821BH025C175N	SCREW,CAP,HEXAGON H NO. 10-24.....	3
48	PFOOO	2540013378846	64678	A18-26517-000	DOOR,GLOVE COMPARTM.....	1
49	PAOZZ	5310008094058	96906	MS27183-10	.WASHER,FLAT .281 ID X .625 OD X .065 THK.....	2
50	PAOZZ	5310013369731	76211	2575	WASHER,FLAT 1/2 ID X 1/2 OD X 1/16 THK, FIBER.....	2
51	PAOZZ	5305000712517	80204	B1821BH025C350N	.SCREW,CAP,HEXAGON H 1/4-20UNC-2A X 3.500.....	1
52	PAOZZ	5310000881251	81349	M45913/1-4CG5C	.NUT,SELF LOCKING,HE 1/4-20UNC.....	2
53	PAOZZ	5310000145850	96906	MS27183-42	WASHER,FLAT.....	2
54	PAOZZ	5305013366596	64678	23-11160-088	SCREW,MACHINE NO. 10-24.....	2
55	PFOZZ	5340013364251	0H6Y7	6065	BUMPER,NONMETALLIC.....	2
56	PAOZZ	5305013462284	64678	23-10406-025	SCREW,MACHINE 6-32, ZINK/CD.....	3
57	PFOZZ	5340013475917	64678	18-18955-0	STRIKE,CATCH.....	1
58	PFOZZ	5365013366449	64678	18-18372-000	SPACER,SLEEVE.....	3
59	PFOZZ	5310013366864	86928	A367-276-2	WASHER,SPRING TENSIL.....	3
60	PFOZZ	5340013455534	64678	18-18954-000	BRACKET,DOUBLE ANGL.....	1
61	KFOZZ		08645	592727AA1-H680	LOCK,GLOVE BOX PART OF KIT P/N 608148AA1-H680.....	1
62	PFOZZ	2540013378845	64678	18-18586-003	DOOR,GLOVE COMPARTM.....	1
63	PAOZZ	5305011331052	96906	MS24630-15	SCREW,TAPPING 3/4 X 40.....	2
64	PFOZZ		64678	18-27366-000	PAD,CUSHIONING KNEE.....	1
65	PFOZZ		64678	18-26054-000	COVER,VEHICULAR,COM R.H. SIDE.....	1
66	PFOZZ	5340013367697	64678	18-23408-003	COVER,ACCESS.....	1
67	XDOZZ		64678	18-26875-000	COVER,ACCESS.....	1
68	XDOZZ		64678	23-10899-706	SCREW,TAPPING 10-16 X 3/4.....	1
69	PFOZZ	5340013365971	64678	18-26068-001	COVER,ACCESS.....	1
70	XDOZZ		64678	23-11164-710	SCREW,MACHINE 1/4-20 X 1.00 TORX HEAD.....	8
71	PFOZZ	5340013379995	64678	18-24267-003	ITEM,SPECIAL.....	1
72	PAOZZ	5310000881251	82458	CLF1420S	NUT,SELF-LOCKING,HE 1/4-20.....	1
73	PAOZZ	5310013323254	31223	17W12580	WASHER,FLAT 1/4 X 1-1/4.....	1
74	PFOZZ		64678	A22-34381-000	HOLDER,CUP PASSENGER L.H.....	1
75	PAOZZ	5365013366450	64678	18-17849-000	SPACER,SLEEVE.....	1
76	XDOZZ		64678	23-09427-025	WASHER,PLATED STEEL 1/4" ID X 0.734 OD.....	1
77	XDOZZ		64678	23-09462-225	BOLT,MACHINE 1/4-20 X 2.50, GR5....	1
78	PFOZZ	5340013365970	64678	18-24266-003	COVER,ACCESS.....	1
79	PFOZZ	5325013367688	94222	85-11-540-52	STUD,TURNLOCK FASTE.....	3
80	PFOZZ	5360011286186	94222	14-18-150-24	SPRING.....	3
81	PFOZZ	5310011286503	94222	85-46-101-41	WASHER,RECESSED.....	3
82	PAOZZ	5305013366597	64678	23-11164-125	SCREW,MACHINE 1/4-20.....	3
83	XDOZZ		86928	5702-107-060BO	WASHER,FLAT .281 ID X .625 OD X .060 THK.....	5
85	XDOZZ		64678	18-26331-000	RACEWAY,METALLIC.....	1

SECTION II			TM9-2320-302-24P			
(1)	(2)	(3)	(4)	(5)	(6)	(7)
ITEM	SMR			PART		
NO	CODE	NSN	CAGEC	NUMBER	DESCRIPTION AND USABLE ON CODES(UOC)	QTY
86	PAOZZ	5310013570854	64678	23-09900-104	NUT, SELF-LOCKING, HE THDLK, 1/4-20 UNC.....	2
87	PFOZZ	5340013379020	64678	18-24268-001	ITEM, SPECIAL.....	1
88	PFOZZ	5310011029221	94222	85-34-201-20	RETAINER.....	3
89	PFOZZ		64678	18-27525-000	HOLDER, CUP DRIVER, R.H.....	1
90	XDOZZ		64678	23-11164-704	SCREW, MACHINE 1/4-20 X .50 TORX HEAD.....	2
91	PFOZZ	5340013367410	64678	A18-26258-000	COVER, ACCESS.....	1
92	PFOZZ	5340013363938	64678	A18-23456-000	BRACKET, DOUBLE ANGL.....	1
93	PFOZZ	5340013366547	64678	18-24578-000	BRACKET, MOUNTING.....	1
94	PAOZZ	5305009881728	96906	MS35206-287	SCREW, MACHINE 2.00 X 20UNC-2A.....	2
95	PFOZZ	5340013363932	64678	A18-24695-000	BRACKET, ANGLE.....	1
96	PFOZZ	5340013366442	64678	18-24502-000	BRACKET, ANGLE.....	1
97	PFOZZ		64678	18-27307-000	BRACKET, ANGLE.....	1
98	PFOZZ	5340013364024	64678	A18-23406-001	BRACKET, MOUNTING.....	1
99	PFOZZ		64678	23-11164-724	SCREW, MACHINE 1/4-20 X 2.5 TORX HEAD.....	1
100	PAOZZ	5305002253843	80204	B1821BH025C100N	SCREW, CAP, HEXAGON H 1/4-20 X 1.00, GR5 ZNW.....	1
101	PAOZZ	5310013369856	64678	SS05702-138-060	WASHER, FLAT.....	1
102	PAOZA	5310010977691	98749	849257-2	WASHER, FLAT 5/16 X 1-1/4".....	1

END OF FIGURE

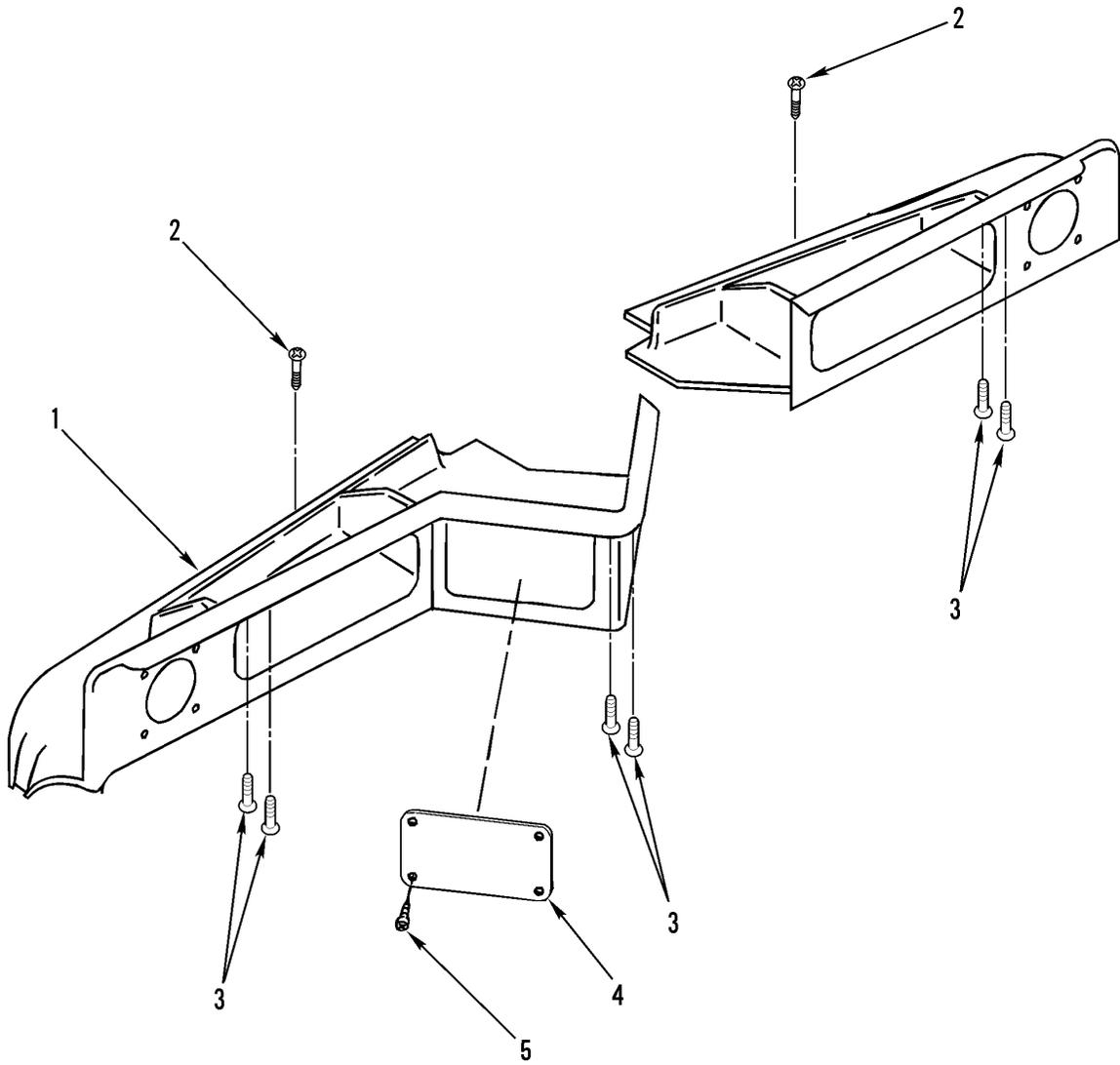

342-1538

Figure 202. Cab Overhead Storage Components

SECTION II			TM9-2320-302-24P			
(1)	(2)	(3)	(4)	(5)	(6)	(7)
ITEM	SMR			PART		
NO	CODE	NSN	CAGEC	NUMBER	DESCRIPTION AND USABLE ON CODES(UOC)	QTY
					GROUP 1801 BODY, CAB, HOOD, AND HULL ASSEMBLIES	
					FIG. 202 CAB OVERHEAD STORAGE COMPONENTS	
1	XDOZZ		64678	A18-28702-000	BOX, ACCESSORIES, STO OVERHEAD.....	1
2	PAOZZ	5305013369467	64678	23-11657-306	SCREW, TAPPING.....	6
2	PAOZZ	5305013387313	64678	23-11657-308	SCREW, SELF-DRILLING.....	1
4	XDOZZ		64678	22-20981-004	PANEL, VEHICULAR COM.....	1
5	XDOZZ		64678	23-11226-706	SCREW, TAPPING.....	4

END OF FIGURE

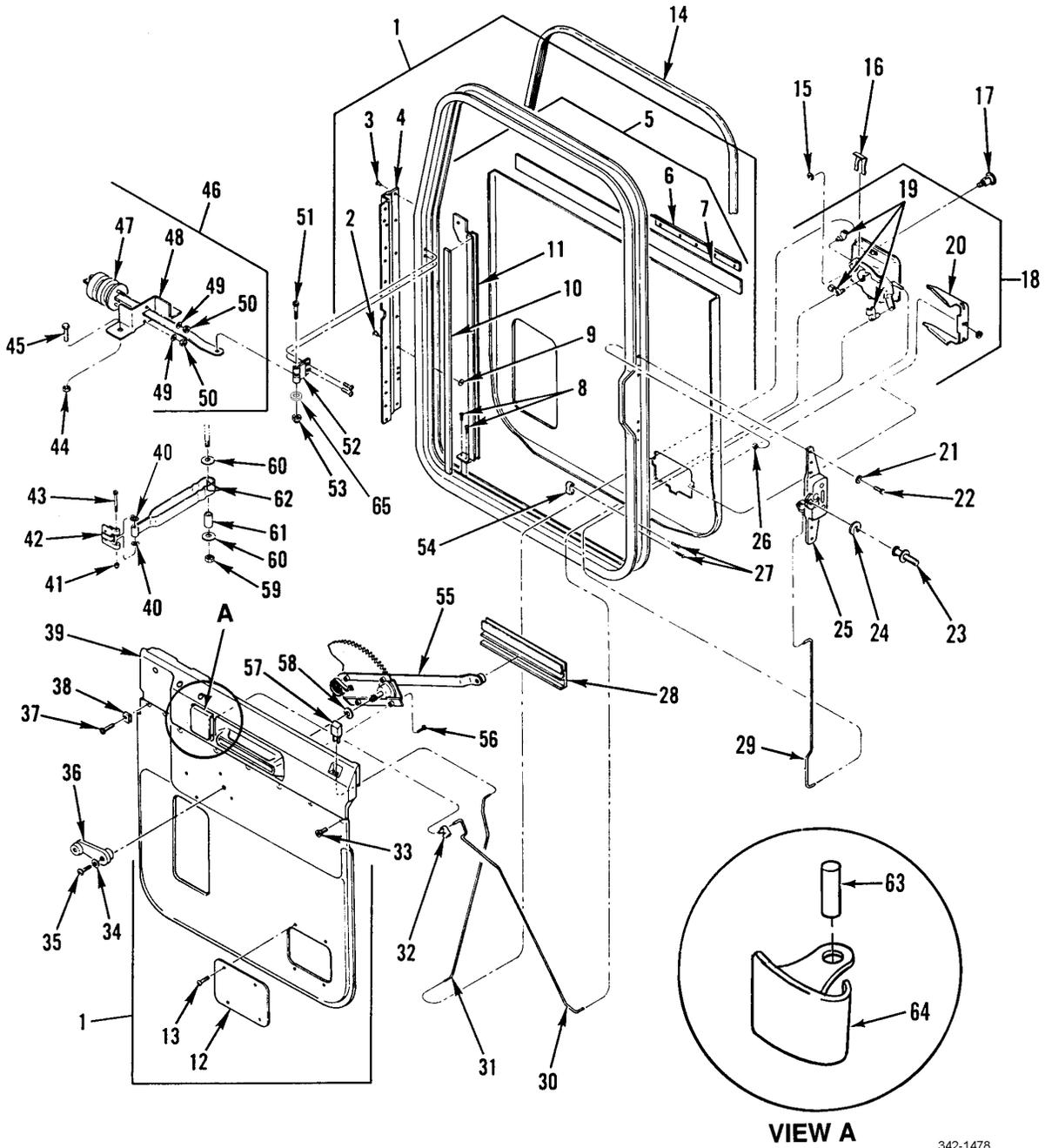

342-1478

Figure 203. Door Assembly

SECTION II		TM9-2320-302-24P				
(1)	(2)	(3)	(4)	(5)	(6)	(7)
ITEM NO	SMR CODE	NSN	CAGEC	PART NUMBER	DESCRIPTION AND USABLE ON CODES(UOC)	QTY
GROUP 1801 BODY, CAB, HOOD, AND HULL ASSEMBLIES						
FIG. 203 DOOR ASSEMBLY						
1	PFFFF	2510013562309	64678	A18-28001-000	DOOR,VEHICULAR L.H.....	1
1	PFFFF	2510013562310	64678	A18-28001-001	DOOR,VEHICULAR R.H.....	1
2	PAFZZ	5305012987333	19738	1901-0810	.SCREW,TAPPING 1/4" X 5/8".....	8
3	PAFZZ	5305002253843	80204	B1821BH025C100N	.SCREW,CAP,HEXAGON H 1/4-20UNC X 1.00".....	1
4	PFFZZ	2510013658975	64678	18-27217-000	.HINGE,DOOR VEHICULA.....	1
5	PAFZZ	2590013463243	64678	A18-27781-000	.MOLDING,METAL LEFT SIDE.....	1
5	XDFZZ		64678	A18-27781-001	.MOLDING,METAL RIGHT SIDE.....	1
6	PAFZZ	2540013665254	64678	18-27780-000	..REFILL BLADE,WIPER LEFT.....	1
6	PAFZZ	2590013683478	64678	18-27780-001	..WIPER,DOOR GLASS RIGHT.....	1
7	PAFZZ	2540013665112	64678	18-27779-000	..BLADE,WINDSHIELD WI LEFT.....	1
7	PAFZZ	2590013677601	64678	18-27779-001	..MOLDING,METAL RIGHT.....	1
8	PAFZZ	5305013456545	64678	23-10570-050	.SCREW,CAP,SOCKET HE 10-24.....	2
9	PFFZZ	3120012987357	19738	1981-0800	.BUSHING,SLEEVE 1/4".....	8
10	MFFZZ		64678	48-02454-106X27	.MSC TAPE URETH FOAM 27", MAKE FROM BULK PN 4516 5/8, (52152).....	1
11	PAFZZ	2540013657155	64678	18-27742-000	.CHANNEL,LIFT,VEHICL L.H.....	1
11	PAFZZ	2540013657156	64678	18-27742-001	.CHANNEL,LIFT,VEHICL R.H.....	1
12	PFFZZ	5340013456569	64678	18-19557-0	.COVER,ACCESS.....	1
13	XDFZZ		64678	23-10891-794	.SCREW,ASSEMBLED WAS 8-32 X 1/2, PAN HEAD, CROSS RECESS.....	4
14	PAOZZ	5330014062130	64678	22-25294-005	SEAL,PLAIN USED ON BOTH L.H. & R.H. DOORS.....	1
15	PAFZZ	5325007217680	96906	MS16633-1025	RING,RETAINING 0.25 SHAFT DIA.....	2
16	PAFZZ	5360013455143	64678	18-14569-001	SPRING,FLAT.....	2
17	KFFZZ		08645	591909AA1-H680	LOCK,DOOR LEFT & RIGHT PART OF KIT P/N 608148AA1-H680.....	1
18	PFFZZ	2540013455746	70523	43971	LATCH,DOOR,VEHICULA L.H.....	1
18	PFFZZ	2540013461813	70523	43970	LATCH,DOOR,VEHICULA R.H.....	1
19	PAFZZ	5325013507068	70523	27801	.LOCKSPRING,TURNLOCK L.H.....	1
19	PAFZZ	5325013507069	70523	27800	.GROMMET,NONMETALLIC R.H.....	1
20	PAFZZ	5365013454056	70523	28986	.SPACER,SPECIAL SHAP LEFT & RIGHT..	1
21	PAFZZ	5310008094058	96906	MS27183-10	WASHER,FLAT .281 ID X .625 OD X .065 THK.....	8
22	PAFZZ	5305002253843	80204	B1821BH025C100N	SCREW,CAP,HEXAGON H 1/4-20UNC-2A X 1.000.....	12
23	PFFZZ	5340014749581	64678	681 721 02 K0	STUD,FRICITION CATCH L.H. & R.H.....	2
24	PFFZZ	5365013482443	64678	18-25956-000	.SPACER,PLATE.....	1
25	PAFZZ	2540013469852	64678	A18-27783-000	LATCH,DOOR,VEHICULA L.H.....	1
25	PAFZZ	2540013469853	64678	A18-27783-001	LATCH,DOOR,VEHICULA R.H.....	1
26	PAFZZ	5310000881251	81349	M45913/1-4CG5C	NUT,SELF LOCKING,HE 1/4-20UNC.....	8
27	PAFZZ	5305013332822	93907	224-60610	SCREW,TAPPING 10-3/4".....	4
28	PFFZZ	2540013455966	64678	18-17963-000	CHANNEL,LIFT,VEHICL.....	2
29	PFFZZ	3040013463239	64678	18-17999-000	CONNECTING LINK,RIG.....	2
30	PAFZZ	3040013463237	64678	18-17997-002	LEVER,REMOTE CONTRO LEFT.....	1
30	PAFZZ	3040013463240	64678	18-17997-003	CONNECTING LINK,RIG RIGHT.....	1
31	PFFZZ	3040013463238	64678	18-23504-000	CONNECTING LINK,RIG LEFT.....	1

SECTION II		TM9-2320-302-24P				
(1)	(2)	(3)	(4)	(5)	(6)	(7)
ITEM	SMR			PART		
NO	CODE	NSN	CAGEC	NUMBER	DESCRIPTION AND USABLE ON CODES(UOC)	QTY
31	PAFZZ	5305013644803	64678	23-10899-125	CONNECTING LINK,RIG RIGHT.....	1
32	PAFZZ	5325013507068	70523	27801	LOCKSPRING,TURNLOCK LEFT & RIGHT...	2
33	PAFZZ	5305013644803	64678	23-10899-125	SCREW,TAPPING 10-16 X 1.25, PAN HEAD, CROSS RECESS.....	1
34	PAOZZ	5310005765752	96906	MS35333-39	WASHER,LOCK NO. 10.....	2
35	PAOZZ	5305013456545	64678	23-10570-050	SCREW,CAP,SOCKET HE 10-24 X 1/2"...	2
36	PAOZZ	2540013455736	64678	A18-18557-002	HANDLE,WINDOW REGUL.....	2
37	PAFZZ	5305013373805	64678	23-10899-075	SCREW,TAPPING NO. 10 X 3/4".....	7
38	PAFZZ	5310013384116	64678	23-11668-000	NUT,CLIP-ON 10-16 N.S. THREAD.....	7
39	PAFZZ	2510013655318	64678	A18-24195-000	WINDOW,VEHICULAR LEFT.....	1
39	PAFZZ	2510013665035	64678	A18-24195-001	WINDOW,VEHICULAR RIGHT.....	1
40	PAFZZ	5310008238804	96906	MS27183-9	WASHER,FLAT.....	2
41	PAFZZ	5310013461594	64678	23-11860-000	NUT,SELF-LOCKING,CA LOW,LKG, 12- 24UNC.....	1
42	PAFZZ	5340013459873	64678	A18-25689-000	LEAF,BUTT HINGE L.H.....	1
43	XDFZZ		64678	18-24417-001	SCREW,CAP,SOCKET HD 12-24 X 2.531 WITH 1/4 HEX SOCKET HD.....	1
44	PAFZZ	5310013570854	64678	23-09900-104	NUT,SELF-LOCKING,HE 1/4-20UNC, THKLN.....	2
45	PAFZZ	5305002253843	80204	B1821BH025C100N	SCREW,CAP,HEXAGON H 1/4-20 X 1.00".	2
46	PAFZZ	5340013485016	64678	A18-24221-000	CLOSER,DOOR.....	1
47	XDFZZ	5340013507072	64678	681 720 00 16	.STRIKE,CATCH.....	1
48	PAFZZ	5340013455533	64678	18-24220-000	.BRACKET,DOUBLE ANGL.....	1
49	PAFZZ	5310011712356	64678	912004 006102	.WASHER,SPRING TENSI DIN N12004, A6	2
50	PAFZZ	5310011714689	S3465	4536226-786	.NUT,PLAIN,HEXAGON DIN934, M6, GR 8, DBL 8451.22.....	2
51	XDFZZ		64678	18-24417-001	SCREW,CAP,SOCKET HD 12-24 X 2.531, WITH 1/4 HEX SOCKET HD.....	1
52	PAFZZ	5340013459874	64678	A18-25719-000	LEAF,BUTT HINGE R.H.....	1
53	PAFZZ	5310013461594	64678	23-11860-000	NUT,SELF-LOCKING,CA LOW, LKG, 12- 24UNC.....	1
54	PAFZZ	5365013452513	64678	18-18239-000	SPACER,PLATE.....	2
55	PAFZZ	2540013460736	64678	A18-16142-002	REGULATOR,VEHICLE W L.H.....	1
55	PAFZZ	2540013486129	64678	A18-16142-003	REGULATOR,VEHICLE W R.H.....	1
56	PAFZZ	5305013456582	64678	23-10330-704	SCREW,MACHINE 12-24UNC X 1/2".....	8
57	PAFZZ	2540013469851	64678	18-17409-000	LATCH,DOOR,VEHICULA.....	1
58	PAFZZ	5310013650234	64678	18-28199-000	WASHER,FLAT.....	2
59	PAFZZ	5310009133366	96906	MS51922-11	NUT,SELF-LOCKING,HE 5/16-18UNF.....	1
60	PAFZA	5310010977691	98749	849257-2	WASHER,FLAT PLTD STL, 5/16 X 1-1/4"	2
61	PAFZA	5365004806974	64678	18-27330-000	SPACER,SLEEVE.....	1
62	PAFZZ	5340013507062	64678	18-26136-000	CLOSER,DOOR L.H.....	1
63	PAFZZ	5315014224331	64678	18-19193-000	PIN,STRAIGHT,HEADLE.....	2
64	PAFZZ	2540014227773	64678	18-17247-001	HANDLE,DOOR,VEHICUL RIGHT.....	1
64	PAFZZ	2540014227763	64678	18-17247-000	HANDLE,DOOR,VEHICUL LEFT.....	1
65	PAFZZ	5310008238804	96906	MS27183-9	WASHER,FLAT NO. 12.....	1

END OF FIGURE

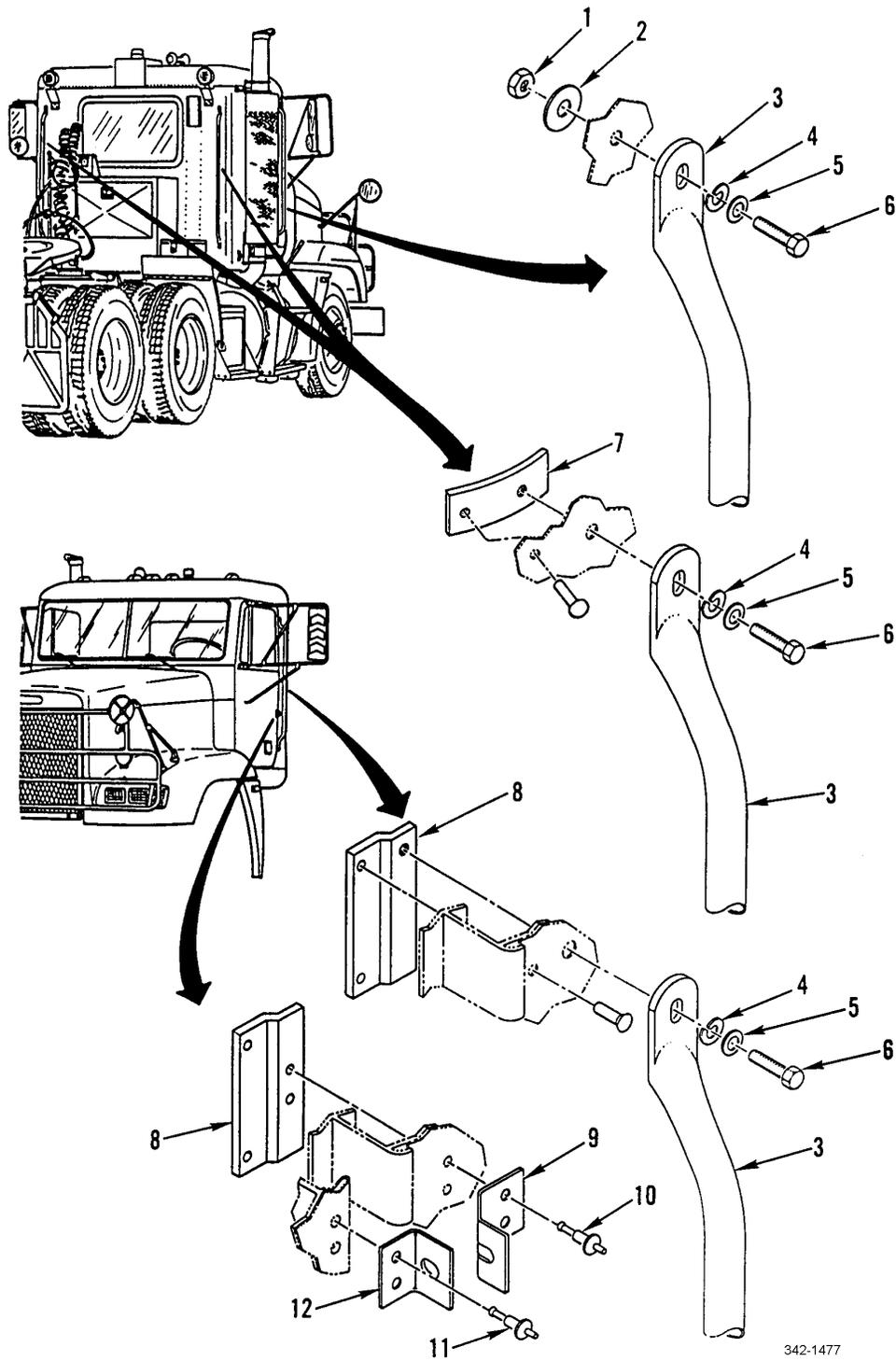

342-1477

Figure 204. Exterior Grab Handles

SECTION II			TM9-2320-302-24P			
(1)	(2)	(3)	(4)	(5)	(6)	(7)
ITEM	SMR			PART		
NO	CODE	NSN	CAGEC	NUMBER	DESCRIPTION AND USABLE ON CODES(UOC)	QTY
					GROUP 1801 BODY, CAB, HOOD, AND HULL ASSEMBLIES	
					FIG. 204 EXTERIOR GRAB HANDLES	
1	PAOZZ	5310000874652	96906	MS51922-17	NUT, SELF-LOCKING, HE 3/8-16UNC.....	2
2	PAOZZ	5310013370369	70655	3553	WASHER, FLAT 3/8 ID X 1 1/4 OD X .05 THK.....	2
3	PAOZZ	5340013370399	64678	18-26135-000	HANDLE, BOW.....	4
4	PAOZZ	5310009847042	96906	MS35338-141	WASHER, LOCK 3/8".....	8
5	PAOZZ	5310008094061	96906	MS27183-15	WASHER, FLAT 3/8".....	8
6	PAOZZ	5305002693211	96906	MS90725-60	SCREW, CAP, HEXAGON H 3/8-16 X 1.00..	8
7	XDHZZ		64678	18-26181-000	PLATE, TAP.....	4
8	XDHZZ		64678	18-09723-000	PLATE, TAP, GRAB HDL.....	4
9	PFOZZ	5340013369041	64678	22-35633-000	BRACKET, DOUBLE ANGL.....	2
10	PFOZZ	5320012432947	19738	2771-0824	RIVET, BLIND.....	4
11	PFOZZ	5320011570908	19738	2771-0817	RIVET, BLIND.....	4
12	PFOZZ	5340013366911	64678	22-35632-000	BRACKET, ANGLE.....	2

END OF FIGURE

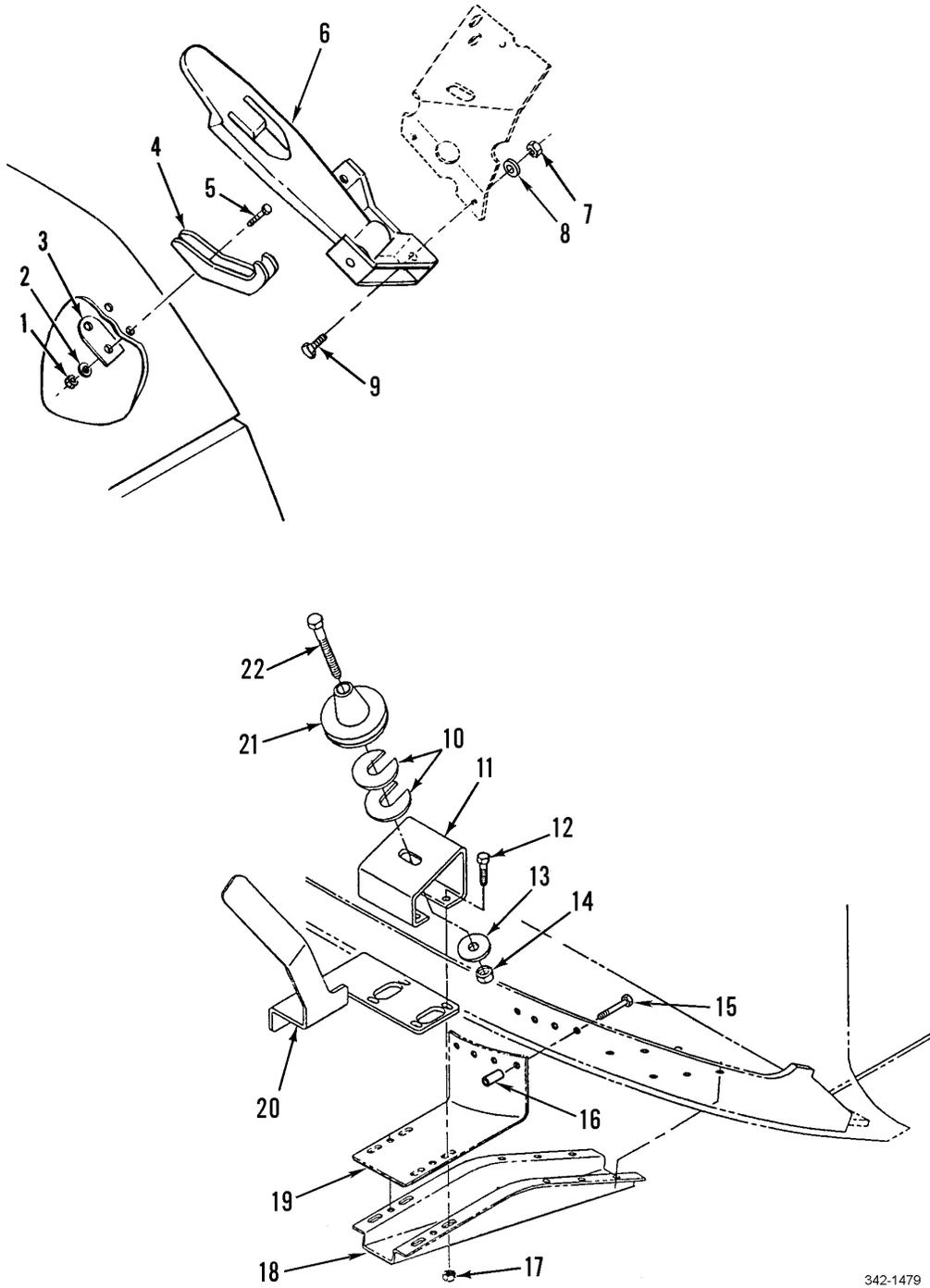

342-1479

Figure 205. Latch and Hood Mount

SECTION II			TM9-2320-302-24P			
(1)	(2)	(3)	(4)	(5)	(6)	(7)
ITEM NO	SMR CODE	NSN	CAGEC	PART NUMBER	DESCRIPTION AND USABLE ON CODES(UOC)	QTY
GROUP 1801 BODY, CAB, HOOD, AND HULL ASSEMBLIES						
FIG. 205 LATCH AND HOOD MOUNT						
1	PAOZZ	5310013294045	64678	23-09336-005	NUT,SELF-LOCKING,CL CLR LOCK, 10-24	4
2	PAOZZ	5310000145850	96906	MS27183-42	WASHER,FLAT .219 ID X .500 OD X .049 THK.....	4
3	PFOZZ	3460013322798	64678	17-12076-000	PLATE,LAPPING.....	2
4	PAOZZ	2590014282988	64678	17-12434-000	BRACKET,VEHICULAR C.....	2
5	PAOZZ	5305009846212	96906	MS35206-265	SCREW,MACHINE 10-24 .750.....	4
6	PAOZZ	2540014282983	64678	17-12435-000	LATCH,HOOD,VEHICULA L.H.....	1
6	PAOZZ	2540014282985	64678	17-12435-001	LATCH,HOOD,VEHICULA R.H.....	1
7	PAOZZ	5310000881251	81349	M45913/1-4CG5C	NUT,SELF LOCKING,HE 1/4-20UNC.....	4
8	PAOZZ	5310008094058	96906	MS27183-10	WASHER,FLAT .281 ID X .625 OD X .065 THK.....	4
9	PAOZZ	5305002253843	80204	B1821BH025C100N	SCREW,CAP,HEXAGON H 1/4-20UNC X 1.00.....	4
10	PFOZZ	5365013294041	64678	17-10320-001	SPACER,PLATE.....	V
11	PFOZZ	2510013321356	64678	17-12053-000	HINGE,HOOD,VEHICULA.....	2
12	PAOZZ	5305013294004	64678	23-11005-125	SCREW,CAP,HEXAGON H 5/16-18UNC.....	8
13	PAOZZ	5310010925011	61649	219353	WASHER,FLAT 0.516 ID.....	2
14	PAOZZ	5310002256993	96906	MS51922-33	NUT,SELF-LOCKING,HE 1/2-13UNC.....	2
15	PAOZZ	5305012987333	19738	1901-0810	SCREW,TAPPING 1/4 INCH X 5/8.....	24
16	PFOZZ	3120012987357	19738	1981-0800	BUSHING,SLEEVE 1/4 INCH.....	24
17	PAOZZ	5310009843806	96906	MS51922-9	NUT,SELF-LOCKING,HE 5/16-18UNC.....	8
18	XDOZZ		64678	17-10417-002	BRACKET,MULTIPLE AN.....	2
19	PAOZZ	5340013366758	64678	17-10407-000	BRACKET,ANGLE L.H.....	1
19	PAOZZ	5340013366759	64678	17-10407-001	BRACKET,ANGLE R.H.....	1
20	PFOZZ	5340013293984	64678	18-25731-002	BRACKET,ANGLE LEFT.....	1
20	PFOZZ	5340013284372	64678	18-25731-003	BRACKET,ANGLE RIGHT.....	1
21	PAOZZ	5340013317290	64678	A17-10464-001	BUMPER,NONMETALLIC.....	2
22	PAOZZ	5305000712081	80204	B1821BH050C450N	SCREW,CAP,HEXAGON H 1/2-13UNC X 4.50.....	2

END OF FIGURE

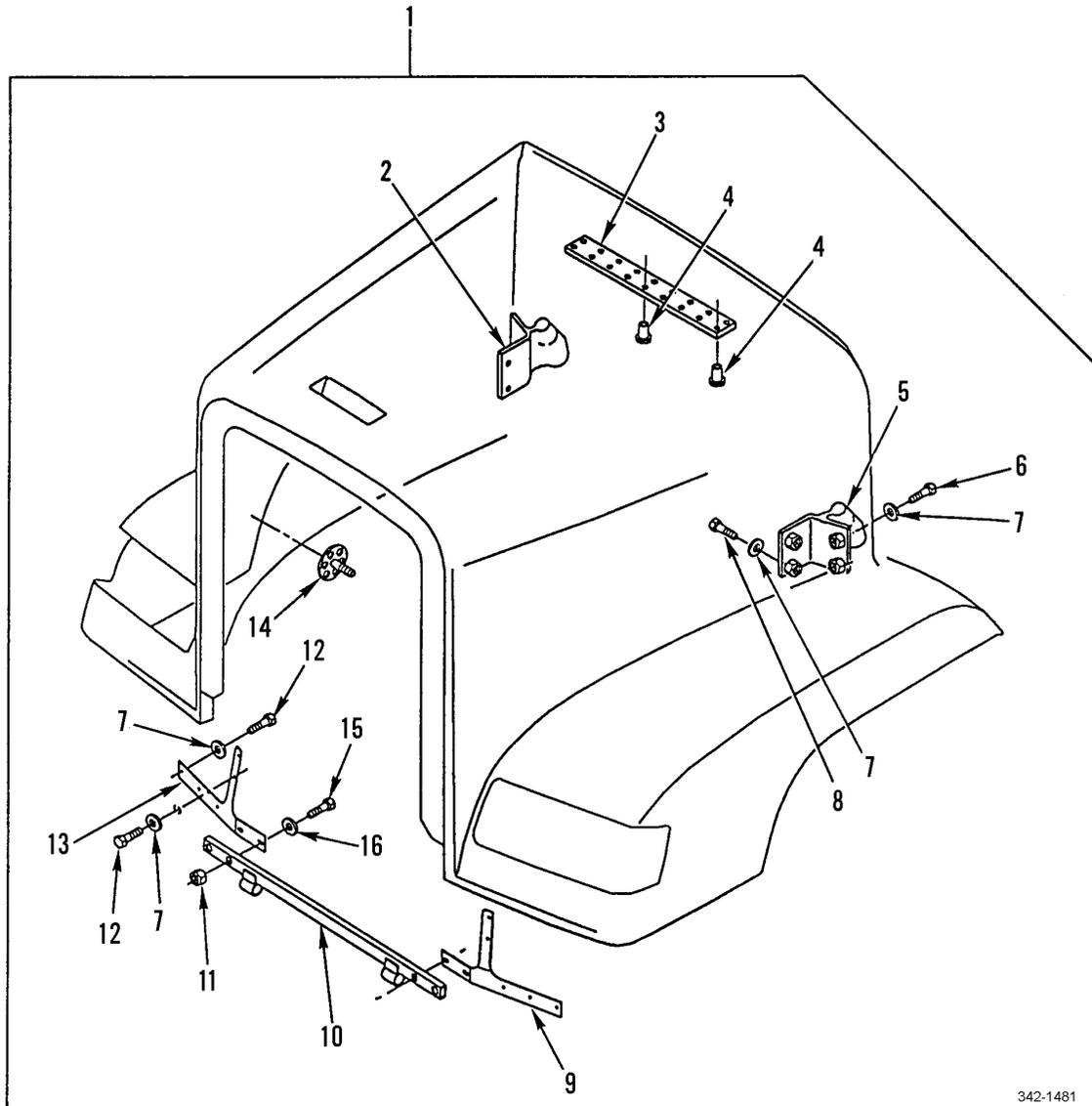

342-1481

Figure 206. Hood Assembly

SECTION II			TM9-2320-302-24P			
(1)	(2)	(3)	(4)	(5)	(6)	(7)
ITEM	SMR			PART		
NO	CODE	NSN	CAGEC	NUMBER	DESCRIPTION AND USABLE ON CODES(UOC)	QTY
GROUP 1801 BODY, CAB, HOOD, AND HULL ASSEMBLIES						
FIG. 206 HOOD ASSEMBLY						
1	PFOFF	2510013277717	64678	A17-12443-000	HOOD,ENGINE COMPART.....	1
2	PFOZZ	5340013294096	64678	17-10465-001	.BRACKET,MOUNTING RIGHT.....	1
3	PFOZZ	5340013293891	64678	17-12062-000	.PLATE,MENDING.....	1
4	XDOZZ		64678	23-12501-000	.RIVET,COMPRESSION 1/4" DIA.....	16
5	PFOZZ	5340013294095	64678	17-10465-000	.BRACKET,MOUNTING LEFT.....	1
6	PAOZZ	5305002693211	96906	MS90725-60	.SCREW,CAP,HEXAGON H 3/8-16 X 1.00.	4
7	PAOZZ	5310000806004	96906	MS27183-14	.WASHER,FLAT .406 ID X .812 OD X .065 THK.....	18
8	PAOZZ	5305008213869	80204	B1821BH038C175N	.SCREW,CAP,HEXAGON H 3/8-16UNC X 1.75.....	4
9	PFOZZ	5340013293980	64678	17-10401-000	.BRACKET,ANGLE LEFT.....	1
10	PFOZZ	5340013294093	64678	A17-10375-001	.BRACKET,MOUNTING.....	1
11	PAOZZ	5310002256993	96906	MS51922-33	.NUT,SELF-LOCKING,HE 1/2-13UNC.....	4
12	PAOZZ	5305000680511	80204	B1821BH038C125N	.SCREW,CAP,HEXAGON H 3/8-16UNC X 1.25.....	12
13	PFOZZ	5340013294094	64678	17-10401-001	.BRACKET,MOUNTING RIGHT.....	1
14	PAOZZ	5970013297358	64678	681 990 11 05	.INSULATOR,DISK.....	16
15	PAOZZ	5305000712067	80204	B1821BH050C125N	.SCREW,CAP,HEXAGON H 1/2-13UNC X 1.25.....	4
16	PAOZZ	5310011091977	19207	11628332-2	.WASHER,FLAT .531 ID X 1.062 OD X .18 THK.....	8

END OF FIGURE

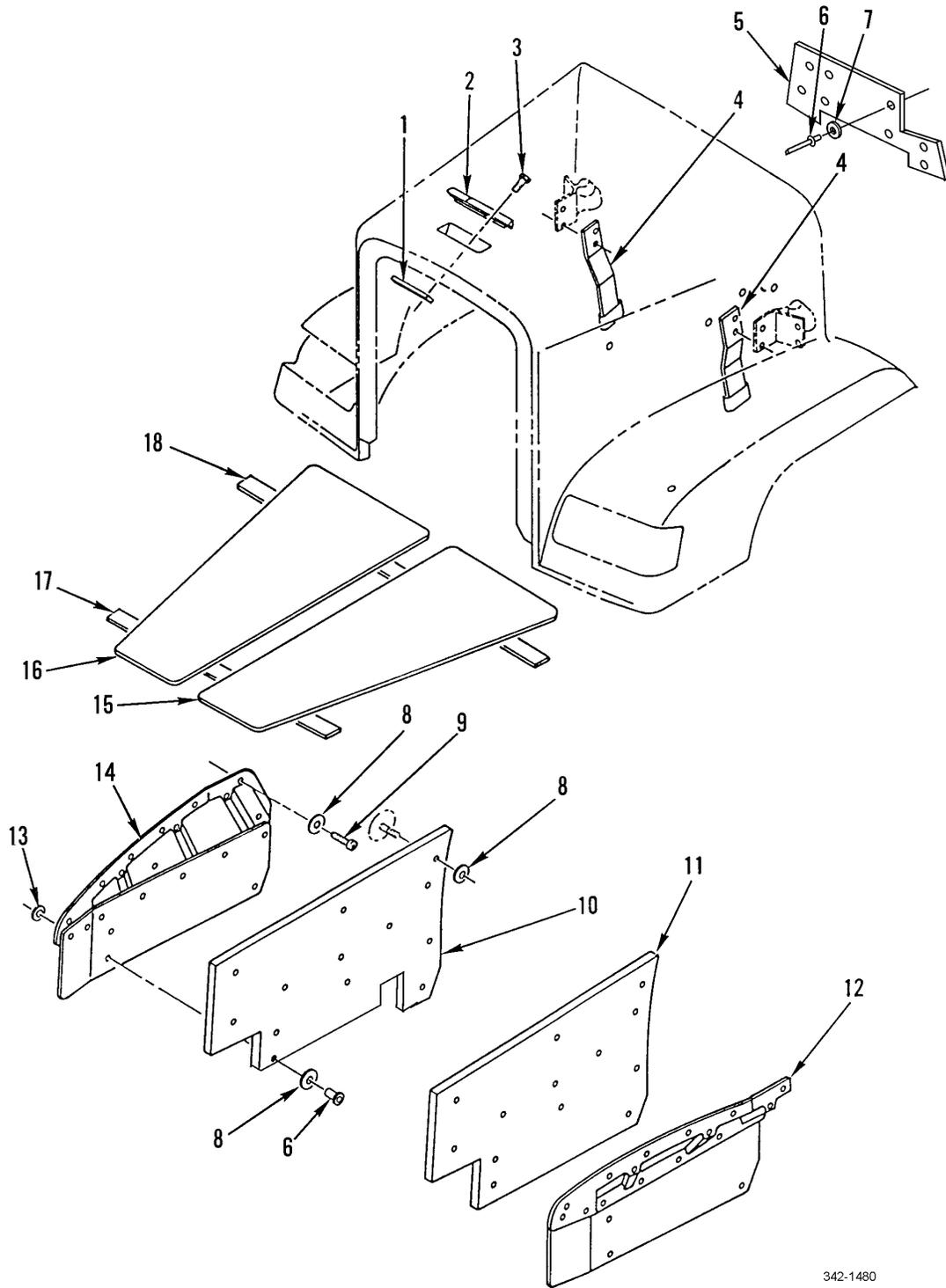

342-1480

Figure 207. Hood Liner, Insulation

SECTION II			TM9-2320-302-24P			
(1)	(2)	(3)	(4)	(5)	(6)	(7)
ITEM NO	SMR CODE	NSN	CAGEC	PART NUMBER	DESCRIPTION AND USABLE ON CODES(UOC)	QTY
GROUP 1801 BODY, CAB, HOOD, AND HULL ASSEMBLIES						
FIG. 207 HOOD LINER, INSULATION						
1	PFOZZ	5340013293892	64678	17-12002-000	PLATE,MENDING.....	1
2	PFOZZ	5340013294009	64678	17-10460-000	HANDLE,BOW.....	1
3	PAOZZ	5305013293857	64678	23-11685-050	SCREW,MACHINE 10-24 X .50 SST.....	2
4	PFOZZ	5340013293982	64678	17-12036-000	BRACKET,ANGLE LEFT.....	1
4	PFOZZ	5340013293983	64678	17-12036-001	BRACKET,ANGLE RIGHT.....	1
5	PAOZZ	2510014813359	64678	A18-26381-000	INSULATION PANEL,VE CENTER FIREWALL	1
6	PFOZZ	5320010562973	19738	1641-0631	RIVET,BLIND.....	20
7	PAOZZ	5310005568420	94223	1183	WASHER,FLAT 3/16 X 3/4.....	8
8	PAOZZ	5310013323254	31223	17W12580	WASHER,FLAT 1/4 ID X 1 1/4 OD X .05 THK.....	30
9	PAOZZ	5305013293969	64678	23-11829-075	SCREW,CAP,SOCKET HE PLASTITE NO. 10	18
10	PAOZZ	5640013489746	64678	17-12134-001	SOUND CONTROLLING F.....	1
11	PAOZZ	5640013489745	64678	17-12134-000	SOUND CONTROLLING F.....	1
12	PAOZZ	2510013295035	64678	A17-12669-000	LINER,VEHICULAR FEN LEFT.....	1
13	PAOZZ	5310013293929	64678	18-20141-000	WASHER,FLAT.....	12
14	PFOZZ	2510013295036	64678	A17-12039-001	LINER,VEHICULAR FEN RIGHT.....	1
15	PFOZZ	5970013318972	64678	A17-12137-000	INSULATOR,PLATE.....	1
16	PFOZZ	5970013331156	64678	A17-12137-001	INSULATOR,PLATE.....	1
17	PFOZZ	5340013306876	64678	17-12136-000	STRAP,RETAINING.....	1
18	PFOZZ	5340013321538	64678	17-12135-000	STRAP,RETAINING.....	2

END OF FIGURE

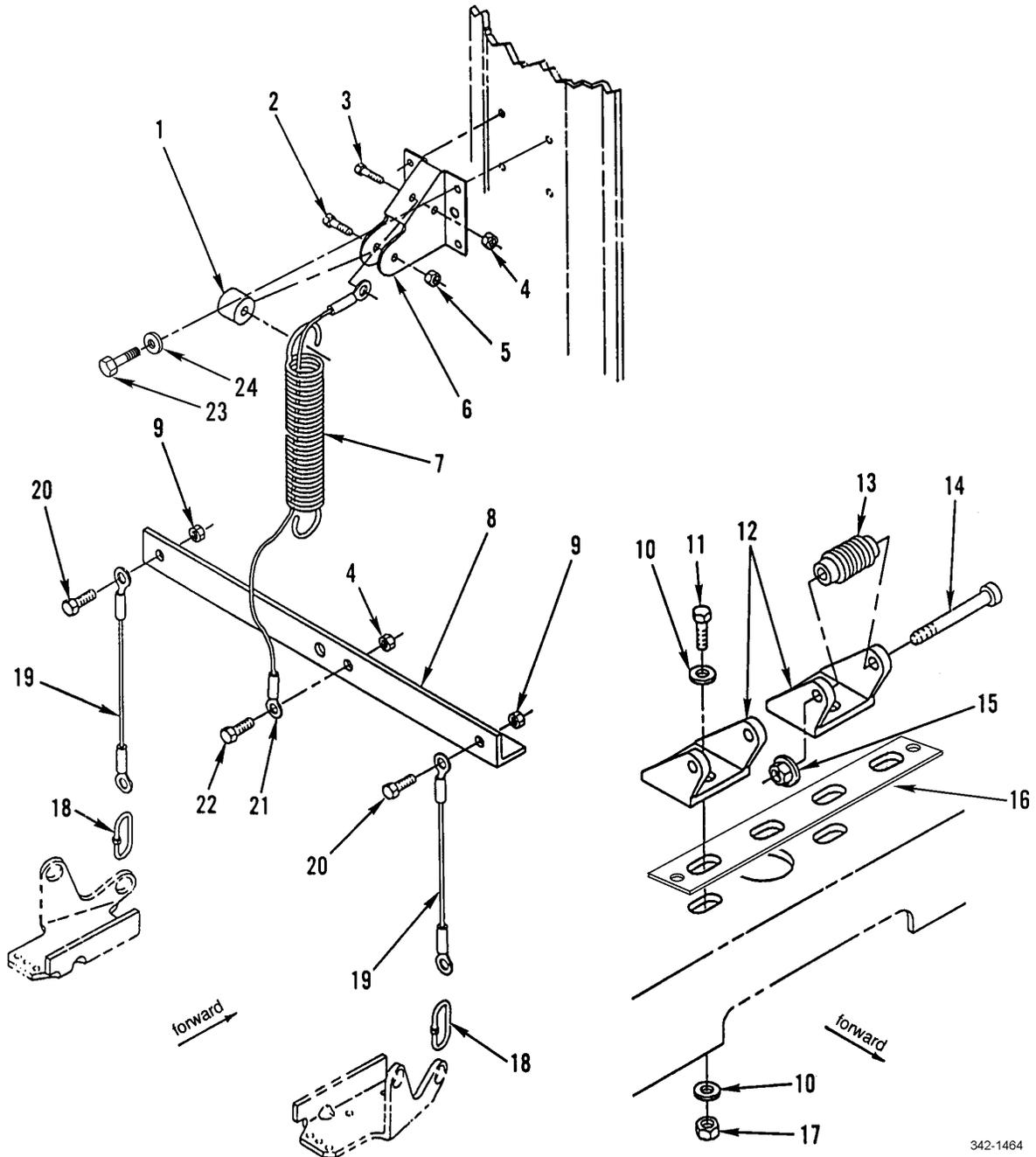

342-1464

Figure 208. Tilt Assist and Hinges (Sheet 1 of 2)

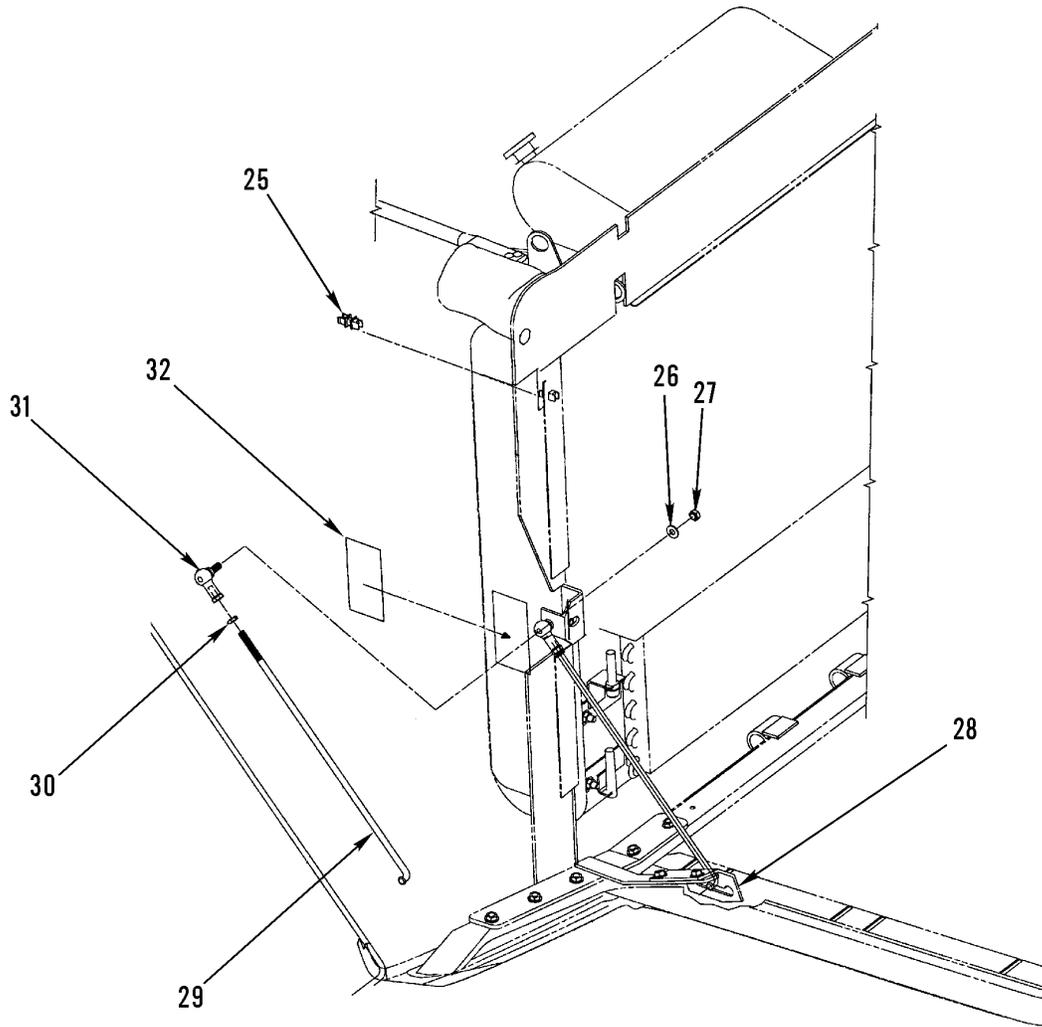

342-1464-2

Figure 208. Tilt Assist and Hinges (Sheet 2 of 2)

SECTION II			TM9-2320-302-24P			
(1)	(2)	(3)	(4)	(5)	(6)	(7)
ITEM	SMR			PART		
NO	CODE	NSN	CAGEC	NUMBER	DESCRIPTION AND USABLE ON CODES(UOC)	QTY
GROUP 1801 BODY, CAB, HOOD, AND HULL ASSEMBLIES						
FIG. 208 TILT ASSIST AND HINGES						
1	PAOZZ	5365013321521	64678	23-09330-171	SPACER,SLEEVE 0.40" ID X 1.5" OD...	1
2	PAOZZ	5305002693218	96906	MS90725-68	SCREW,CAP,HEXAGON H 3/8-16UNC X 2.50.....	1
3	PAOZZ	5306002264835	80204	B1821BH031C250N	BOLT,MACHINE 5/16-18UNC-2A X 2.500.	1
4	PAOZZ	5310009843806	96906	MS51922-9	NUT,SELF-LOCKING,HE 5/16-18UNC.....	2
5	PAOZZ	5310009308214	96906	MS51988-7	NUT,SELF-LOCKING,EX 3/8-16UNC.....	1
6	PFOZZ	5340013340466	64678	17-12006-000	BRACKET,DOUBLE ANGL.....	1
7	PAOZZ	5360013293756	64678	17-12069-000	SPRING,HELICAL,EXTE.....	1
8	PFOZZ	5340013293981	64678	17-12080-000	BRACKET,ANGLE.....	1
9	PAOZZ	5310002256993	96906	MS51922-33	NUT,SELF-LOCKING,HE 1/2-13UNC.....	2
10	PAOZZ	5310007679425	96906	MS15795-818	WASHER,FLAT 0.53 X 1.06 X .177 ZN..	12
11	PAOZZ	5305000712075	80204	B1821BH050C300N	SCREW,CAP,HEXAGON H 1/2-13UNC-2A X 3.000.....	6
12	PAHZZ	5340013293863	64678	17-10425-002	HINGE,STRAP.....	2
13	PAOZZ	5365013294102	76005	J-17700-5	BUSHING,NONMETALLIC.....	2
14	PAOZZ	5306013293835	64678	23-11352-428	BOLT,SHOULDER 1/2 DIA. X 3.50 LENGTH.....	2
15	PAOZZ	5310000874652	96906	MS51922-17	NUT,SELF-LOCKING,HE 3/8-16UNC.....	2
16	XDOZZ		64678	21-26184-000	SPACER,PLATE.....	1
17	PAOZZ	5310002256993	96906	MS51922-33	NUT,SELF-LOCKING,HE 1/2-13UNC.....	6
18	PAOZZ	4010013291837	57648	85524	LINK,CHAIN,DETACHAB.....	2
19	PAOZZ	5995013288997	64678	A17-12081-000	LEAD,ELECTRICAL.....	2
20	PAOZZ	5305000712067	80204	B1821BH050C125N	SCREW,CAP,HEXAGON H 1/2-13UNC-2A X 1.25.....	2
21	PAOZZ	5995013288998	64678	A17-12082-000	LEAD,ELECTRICAL.....	1
22	PAOZZ	5306002264825	80204	B1821BH031C075N	BOLT,MACHINE 5/16-18UNC-2A X .750..	1
23	PAOZZ	5305000680502	96906	MS90725-6	SCREW,CAP,HEXAGON H 1/4-20 X 0.75..	4
24	PAOZZ	5310008094058	96906	MS27183-10	WASHER,FLAT 1/4".....	4
25	PAOZZ		64678	23-12661-000	CLIP,SPRING TENSION.....	1
26	XDOZZ		64678	23-09114-002	WASHER,FLAT .41 ID X .81 OD X .81 THK.....	1
27	XDOZZ		64678	23-09901-206	NUT,SELF-LOCKING 3/8-24UNF.....	1
28	XDOZZ		64678	17-13019-000	BRACKET,ANGLE.....	1
29	PAOZZ		64678	17-13020-000	ROD,HOOD,VEHICULAR.....	1
30	XDOZZ		64678	23-09254-003	NUT,PLAIN,HEXAGON 3/8-24.....	1
31	PAOZZ		64678	SPF6S055	ROD END,THREADED.....	1
32	XDOZZ		64678	24-00743-000	DECAL,HOOD PROP ROD.....	1

END OF FIGURE

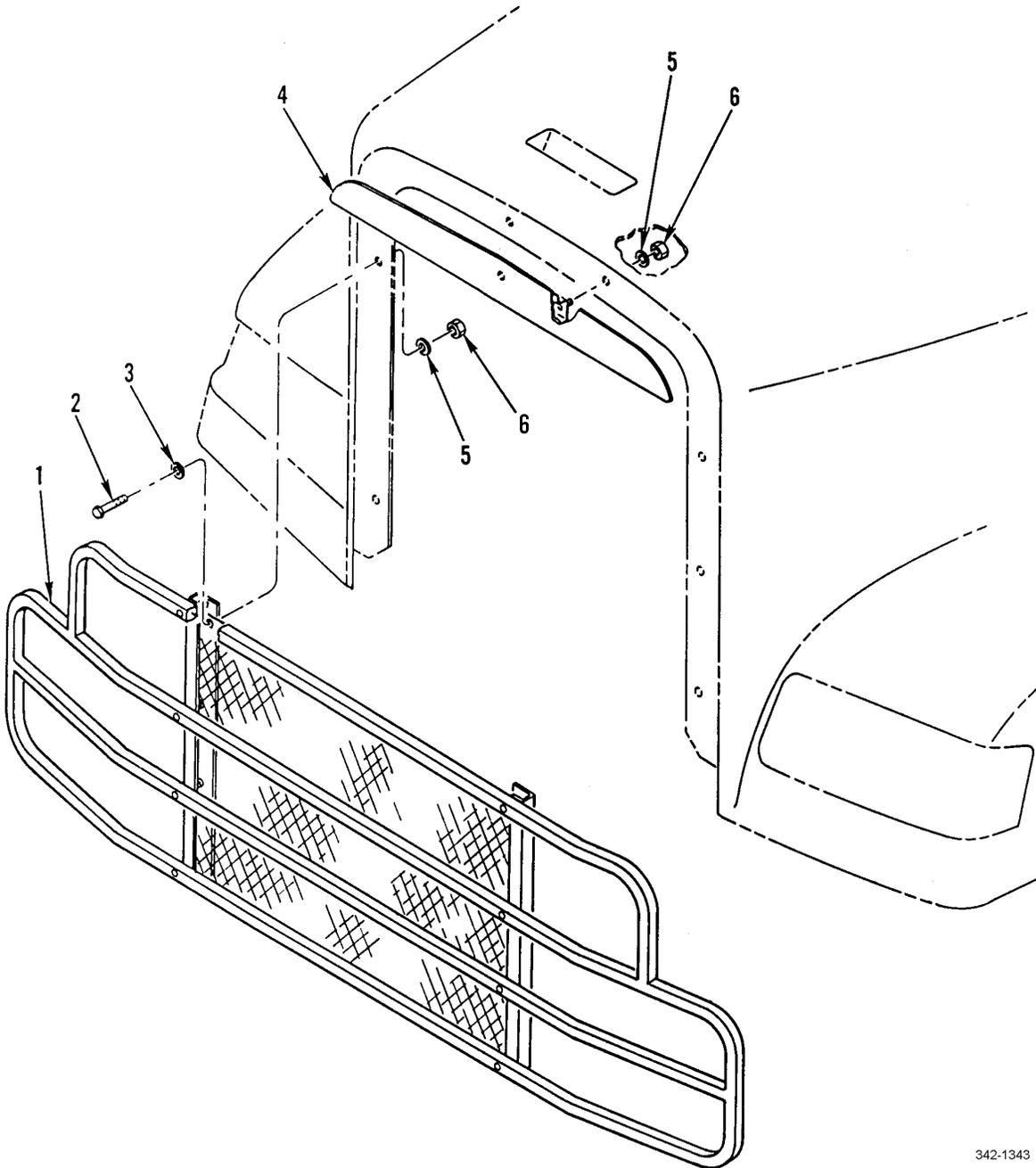

342-1343

Figure 209. Brush Guard

SECTION II			TM9-2320-302-24P			
(1)	(2)	(3)	(4)	(5)	(6)	(7)
ITEM	SMR			PART		
NO	CODE	NSN	CAGEC	NUMBER	DESCRIPTION AND USABLE ON CODES(UOC)	QTY
					GROUP 1801 BODY, CAB, HOOD, AND HULL ASSEMBLIES	
					FIG. 209 BRUSH GUARD	
1	PFOZZ	2540013321403	64678	A17-12104-000	BUMPER,VEHICULAR.....	1
2	PAOZZ	5306002264825	80204	B1821BH031C075N	BOLT,MACHINE 5/16-18UNC-2A X 0.75..	6
3	PAOZZ	5310000814219	96906	MS27183-12	WASHER,FLAT 0.344 ID X 0.688 OD X 0.065 THK.....	6
4	PFOZZ	5430013321374	64678	A17-12108-000	TANK SECTION,FLUID.....	1
5	PAOZZ	5310007814762	77272	VS15305-5039-20	WASHER,FLAT 5/16 ID X 1 1/4 OD X 0.05 THK.....	8
6	PAOZZ	5310009133366	96906	MS51922-11	NUT,SELF-LOCKING,HE 5/16-18UNF-2B..	8

END OF FIGURE

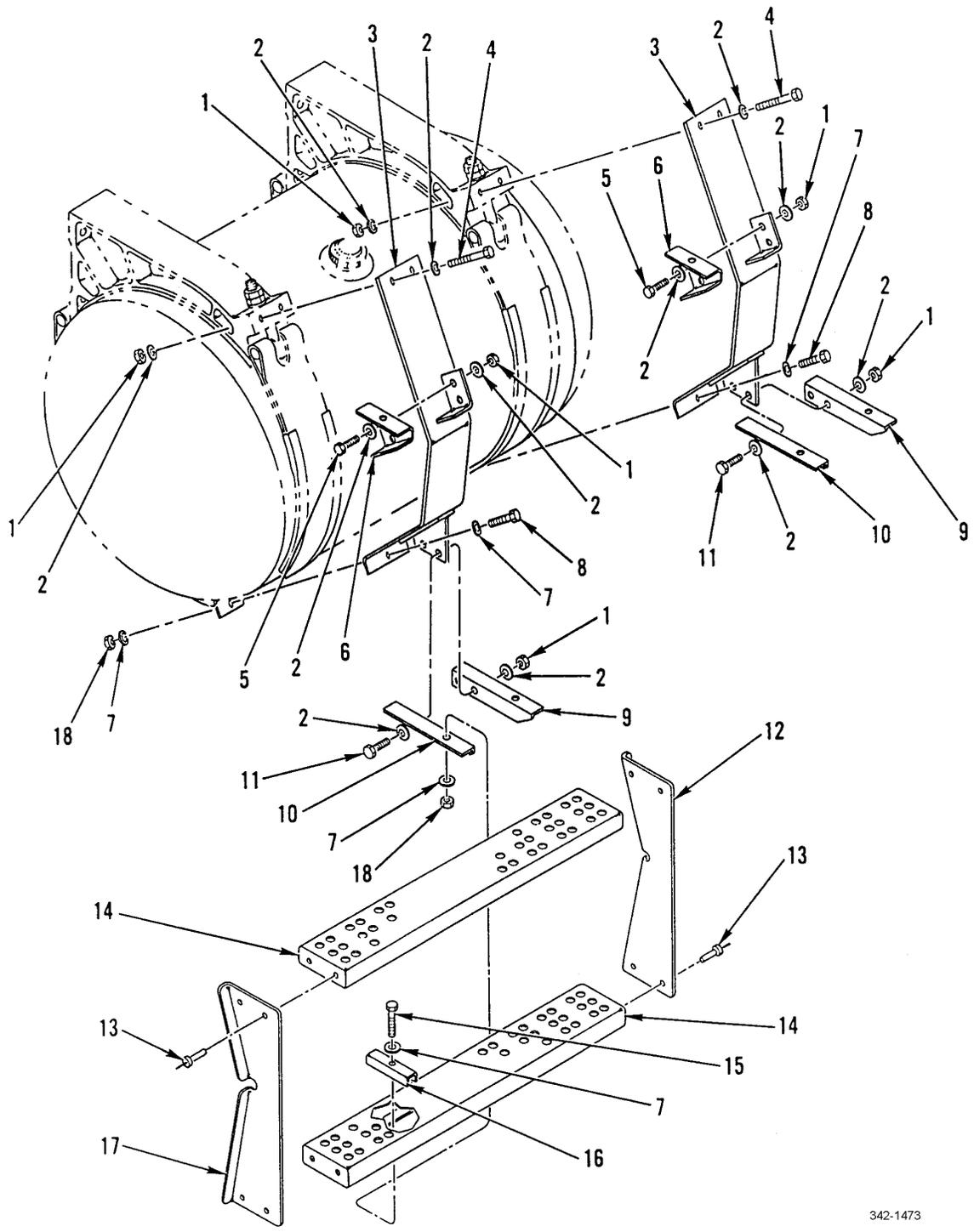

342-1473

Figure 210. Step Assembly R/S

SECTION II			TM9-2320-302-24P			
(1)	(2)	(3)	(4)	(5)	(6)	(7)
ITEM	SMR			PART		
NO	CODE	NSN	CAGEC	NUMBER	DESCRIPTION AND USABLE ON CODES(UOC)	QTY
GROUP 1802 FENDERS, RUNNING BOARDS WITH MOUNTING AND ATTACHING PARTS, OUTRIGGERS, WINDSHIELD, GLASS, ETC.						
FIG. 210 STEP ASSEMBLY R/S						
1	PAOZZ	5310000874652	96906	MS51922-17	NUT, SELF-LOCKING, HE 3/8-16UNC.....	12
2	PAOZZ	5310000806004	96906	MS27183-14	WASHER, FLAT .406 ID X .812 OD X .065 THK.....	24
3	PFOZZ	5340013326653	64678	A22-35921-000	BRACKET, MOUNTING.....	2
4	PAOZZ	5305008465703	80204	B1821BH038C300N	SCREW, CAP, HEXAGON H 3/8-16UNC X 3.00.....	4
5	PAOZZ	5305000680511	80204	B1821BH038C125N	SCREW, CAP, HEXAGON H 3/8-16UNC X 1.25.....	4
6	PFOZZ	5340013326588	64678	22-32394-000	BRACKET, DOUBLE ANGL.....	2
7	PAOZZ	5310000814219	96906	MS27183-12	WASHER, FLAT .344 ID X .688 OD X .065 THK.....	16
8	PAOZZ	5306002264833	80204	B1821BH031C200N	BOLT, MACHINE 5/16-18UNC X 2.00.....	2
9	PFOZZ	5340013326584	64678	22-35920-000	BRACKET, ANGLE.....	2
10	PFOZZ	5340013341362	64678	22-35920-001	BRACKET, ANGLE.....	2
11	PAOZZ	5305007252317	80204	B1821BH038C150N	SCREW, CAP, HEXAGON H 3/8-16UNC X 1.50.....	4
12	PFOZZ	5340013360120	64678	22-35299-000	BRACKET, MOUNTING.....	1
13	PFOZZ	5320011570908	19738	2771-0817	RIVET, BLIND.....	8
14	PFOZZ	2590013321628	64678	A22-35310-001	RUNNING BOARD, VEHIC.....	2
15	PAOZZ	5305002264831	80204	B1821BH031C150N	SCREW, CAP, HEXAGON H 5/16-18UNC X 1.50.....	6
16	PFOZZ	5340013326696	64678	681 883 00 32	STRAP, RETAINING.....	6
17	PFOZZ	5340013326585	64678	22-35299-001	BRACKET, ANGLE.....	1
18	PAOZZ	5310009843806	96906	MS51922-9	NUT, SELF-LOCKING, HE 5/16-18UNC.....	8

END OF FIGURE

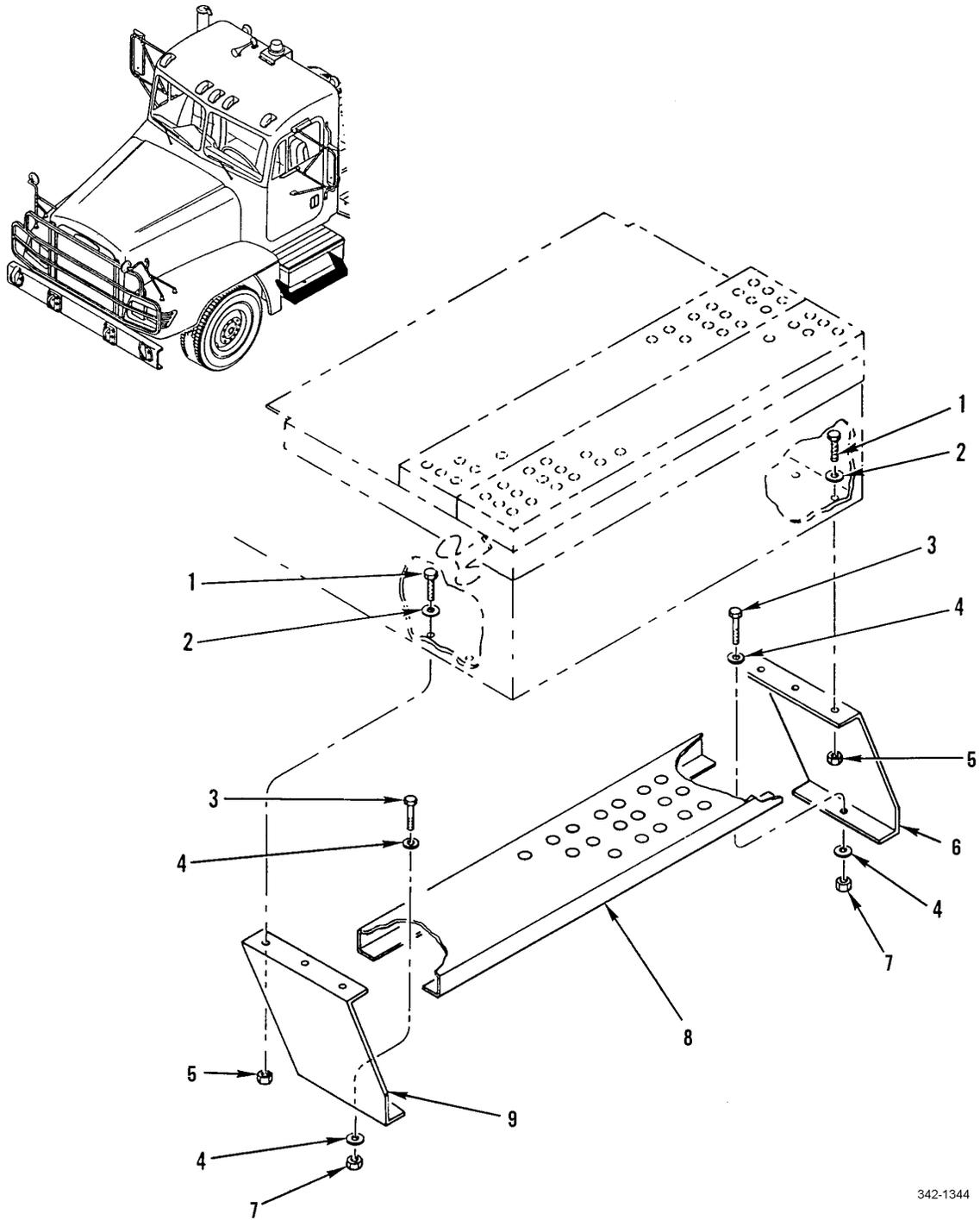

342-1344

Figure 211. Left Step Assembly

SECTION II			TM9-2320-302-24P			
(1)	(2)	(3)	(4)	(5)	(6)	(7)
ITEM	SMR			PART		
NO	CODE	NSN	CAGEC	NUMBER	DESCRIPTION AND USABLE ON CODES(UOC)	QTY
					GROUP 1802 FENDERS, RUNNING BOARDS WITH MOUNTING AND ATTACHING PARTS, OUTRIGGERS, WINDSHIELD, GLASS, ETC.	
					FIG. 211 LEFT STEP ASSEMBLY	
1	PAOZZ	5305000680511	80204	B1821BH038C125N	SCREW,CAP,HEXAGON H 3/8-16UNC X 1.250.....	6
2	PAOZZ	5310000806004	96906	MS27183-14	WASHER,FLAT .406 ID X .812 OD X .065 THK.....	6
3	PAOZZ	5305002264831	80204	B1821BH031C150N	SCREW,CAP,HEXAGON H 5/16-18UNC-2A X 1.500.....	2
4	PAOZZ	5310000814219	96906	MS27183-12	WASHER,FLAT .344 ID X .688 OD X .065 THK.....	4
5	PFOZZ	5310008512682	96906	MS35691-17	NUT,PLAIN,HEXAGON.....	6
6	XDOZZ		64678	06-17964-001	PLATE,STEP,MTG RIGHT.....	1
7	PAOZZ	5310009133366	96906	MS51922-11	NUT,SELF-LOCKING,HE 5/16 X 18UNF-2B	2
8	PAOZZ	2510013389982	64678	06-17156-006	TREAD,METALLIC,NONS.....	1
9	XDOZZ		64678	06-17964-000	PLATE,STEP,MTG.....	1

END OF FIGURE

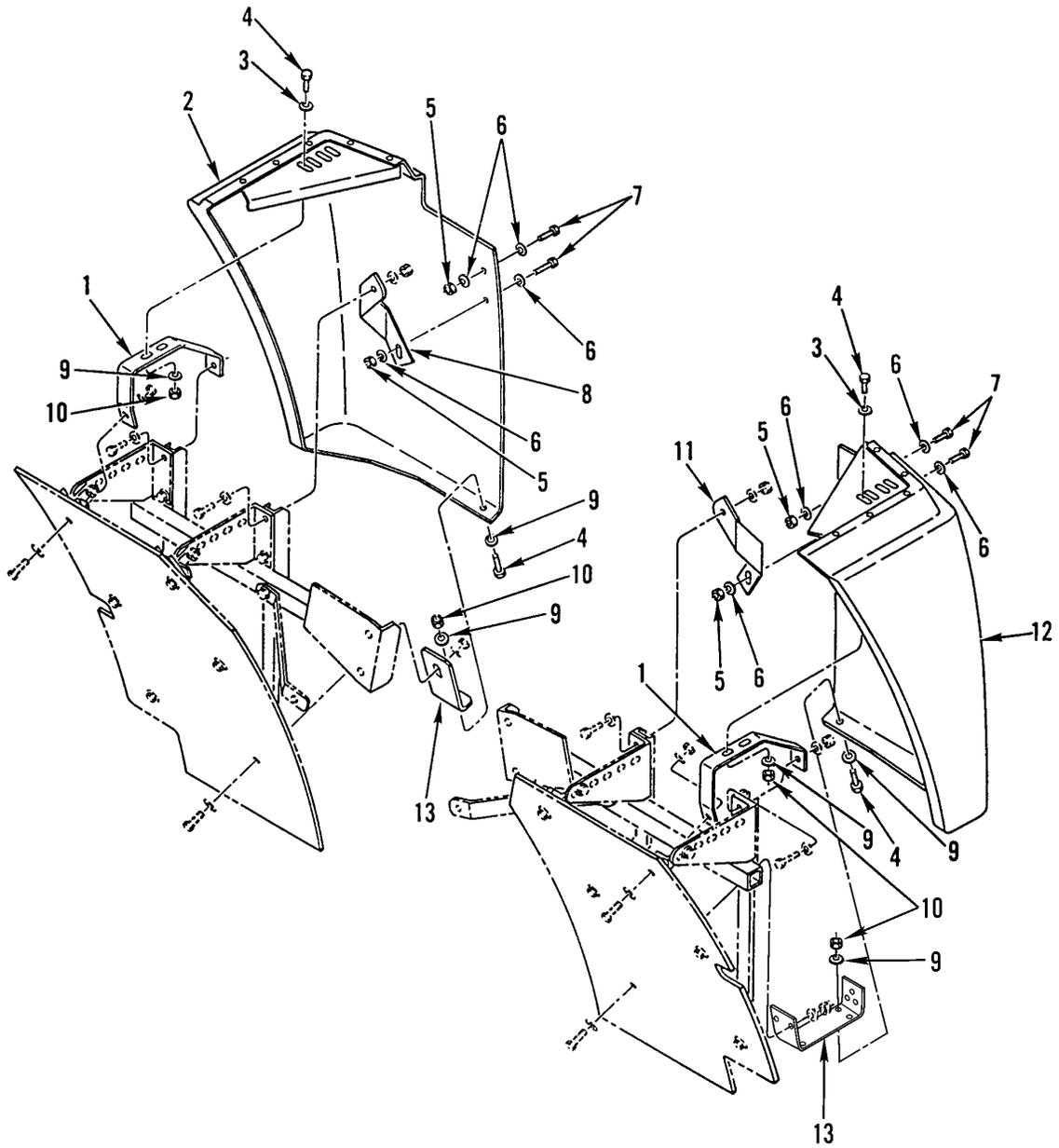

342-1465

Figure 212. Front Quarterfender Installation

SECTION II			TM9-2320-302-24P			
(1)	(2)	(3)	(4)	(5)	(6)	(7)
ITEM	SMR			PART		
NO	CODE	NSN	CAGEC	NUMBER	DESCRIPTION AND USABLE ON CODES(UOC)	QTY
					GROUP 1802 FENDERS, RUNNING BOARDS WITH MOUNTING AND ATTACHING PARTS, OUTRIGGERS, WINDSHIELD, GLASS, ETC.	
					FIG. 212 FRONT QUARTERFENDER INSTALLATION	
1	PFOZZ	5340013394331	64678	22-33267-000	BRACKET,MOUNTING.....	2
2	PFOZZ	2510013378841	64678	A22-32896-001	FRAME,STRUCTURAL,VE RIGHT.....	1
3	PAOZZ	5310010977691	98749	849257-2	WASHER,FLAT 5/16 X 1-1/4 STL.....	4
4	PAOZZ	5306002258503	96906	MS90725-39	BOLT,MACHINE 5/16-18 X 1.75.....	4
5	PAOZZ	5310000874652	96906	MS51922-17	NUT,SELF-LOCKING,HE 3/8-16UNC.....	4
6	PAOZZ	5310000806004	96906	MS27183-14	WASHER,FLAT .406 ID X .812 OD X .065 THK.....	8
7	PAOZZ	5305000680511	80204	B1821BH038C125N	SCREW,CAP,HEXAGON H 3/8-16UNC X 1.250.....	4
8	PFOZZ	2510013374122	64678	22-33726-001	BRACE,FENDER RIGHT.....	1
9	PAOZZ	5310000814219	96906	MS27183-12	WASHER,FLAT .344 ID X .688 OD X .065 THK.....	8
10	PAOZZ	5310009843806	96906	MS51922-9	NUT,SELF-LOCKING,HE 5/16-18UNC.....	6
11	PFOZZ	2510013374121	64678	22-33726-000	BRACE,FENDER LEFT.....	1
12	PFOZZ	2510013374130	64678	A22-32896-000	FRAME SECTION,STRUC LEFT.....	1
13	PFOZZ	5340013363934	64678	22-32516-000	BRACKET,ANGLE.....	2

END OF FIGURE

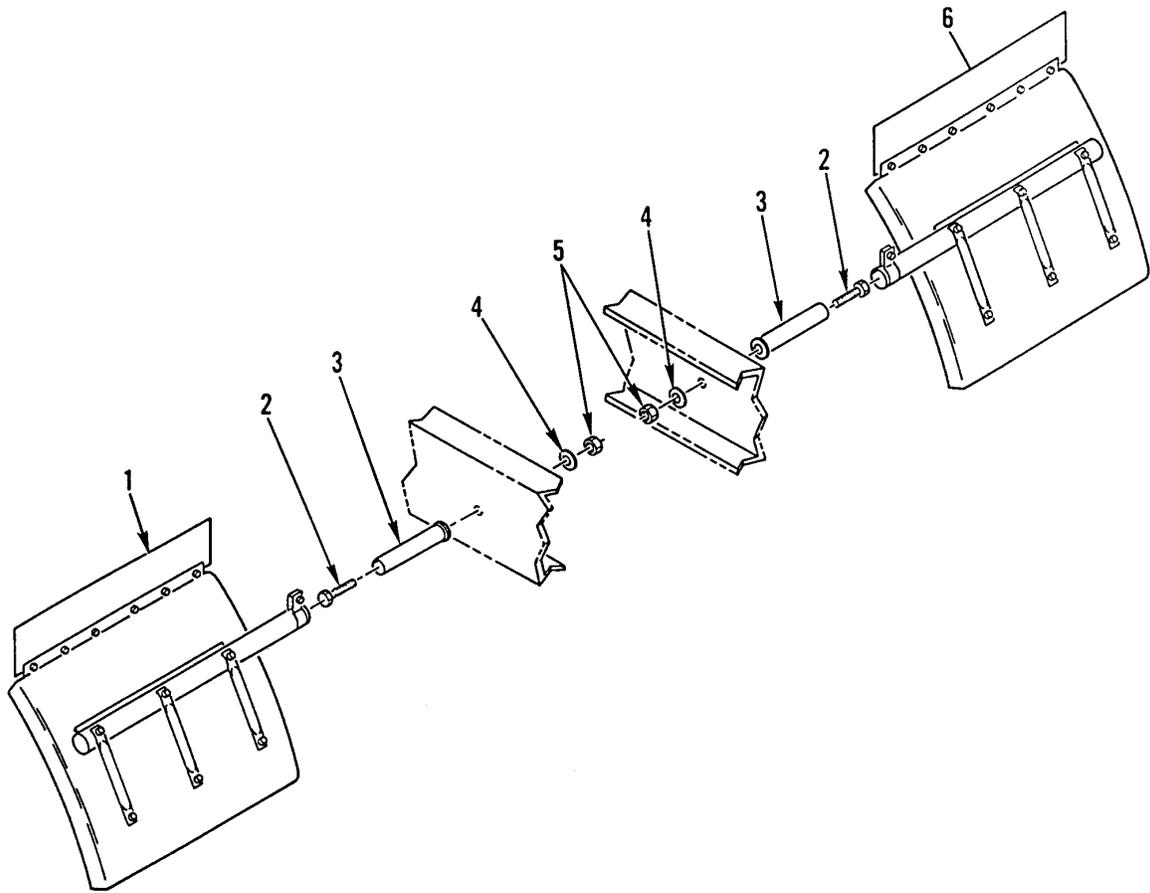

342-1466

Figure 213. Rear Quarterfender Installation

SECTION II			TM9-2320-302-24P			
(1)	(2)	(3)	(4)	(5)	(6)	(7)
ITEM	SMR			PART		
NO	CODE	NSN	CAGEC	NUMBER	DESCRIPTION AND USABLE ON CODES(UOC)	QTY
					GROUP 1802 FENDERS, RUNNING BOARDS WITH MOUNTING AND ATTACHING PARTS, OUTRIGGERS, WINDSHIELD, GLASS, ETC.	
					FIG. 213 REAR QUARTERFENDER INSTALLATION	
1	PFOZZ	2510013374125	64678	A22-35146-001	PANEL,BODY,VEHICULA RIGHT.....	1
2	PAOZZ	5305007247228	80204	B1821BH063C300N	SCREW,CAP,HEXAGON H 5/8-11UNC X 3.00.....	2
3	PFOZZ	5365013367658	64678	FLT/1600-15MT	SPACER,SLEEVE.....	2
4	PAOZZ	5310007208819	96906	MS15795-821	WASHER,FLAT .688 ID X 1.75 OD.....	2
5	PAOZZ	5310002694040	96906	MS51922-49	NUT,SELF-LOCKING,HE 5/8-11UNC.....	2
6	PFOZZ	2510013378843	64678	A22-35146-000	PANEL,BODY,VEHICULA LEFT.....	1

END OF FIGURE

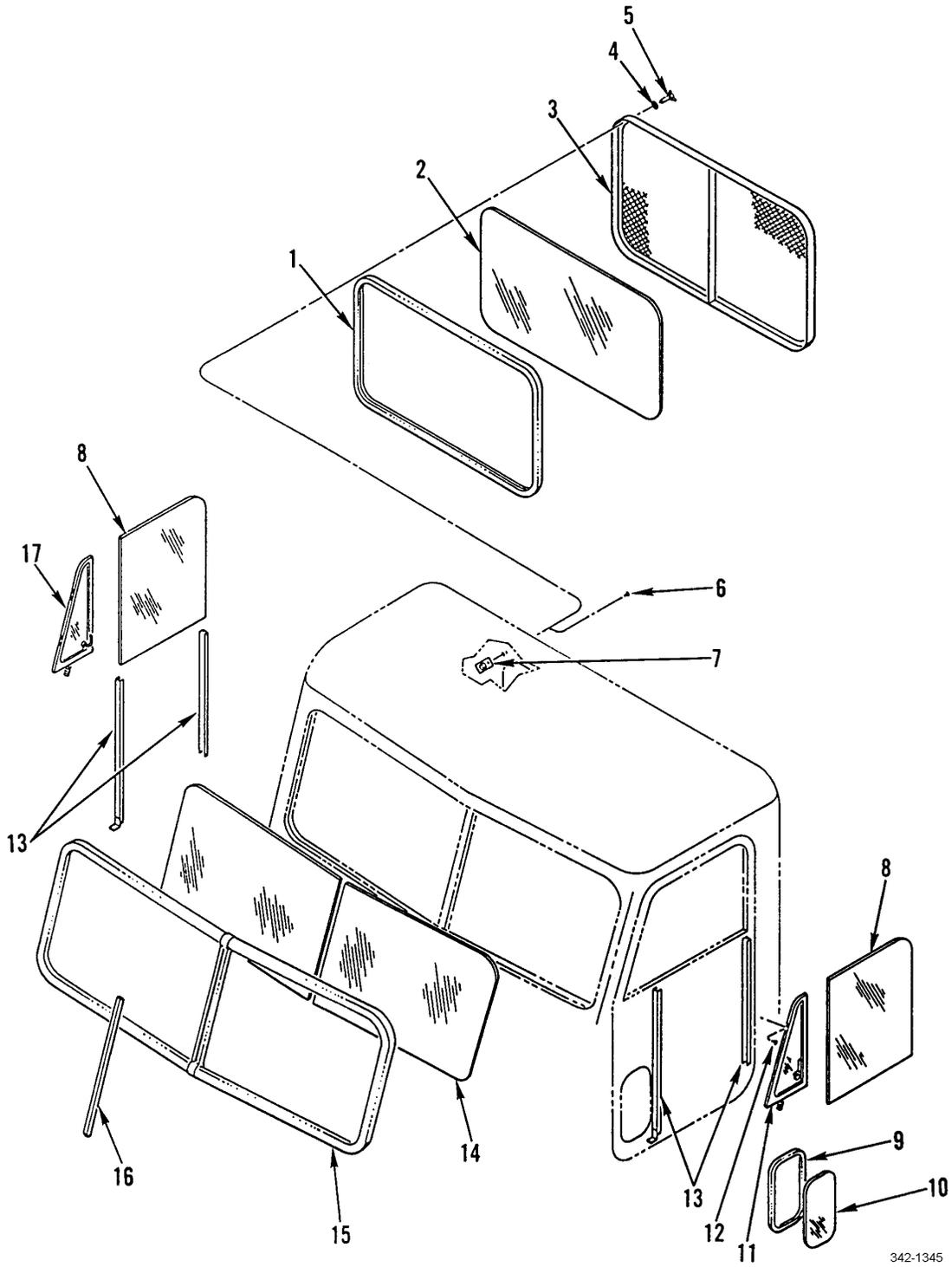

342-1345

Figure 214. Windshield and Windows

SECTION II			TM9-2320-302-24P			
(1)	(2)	(3)	(4)	(5)	(6)	(7)
ITEM	SMR			PART		
NO	CODE	NSN	CAGEC	NUMBER	DESCRIPTION AND USABLE ON CODES(UOC)	QTY
					GROUP 1802 FENDERS, RUNNING BOARDS WITH MOUNTING AND ATTACHING PARTS, OUTRIGGERS, WINDSHIELD, GLASS, ETC.	
					FIG. 214 WINDSHIELD AND WINDOWS	
1	PFFZZ	9390013385873	64678	48-02470-000	NONMETALLIC SPECIAL.....	1
2	PFFZZ	2510013372116	64678	22-28696-000	WINDOW,VEHICULAR.....	1
3	PFOZZ	2510013370233	64678	A22-33408-000	GRILLE,METAL.....	1
4	PAOZZ	5310000814219	96906	MS27183-12	WASHER,FLAT 0.344 ID X 0.688 OD X 0.065 THK.....	4
5	PFOZZ	5305013367543	64678	23-12036-012	THUMBSCREW 5/16-18,B1,LKG.....	4
6	PBOZZ	5320012702951	19738	2771-0613	RIVET,BLIND.....	8
7	XDOZZ		64678	A22-34726-000	PLATE ASSY,MTG-WDO.....	4
8	PAOZZ	2510013372115	64678	18-17450-001	WINDOW,VEHICULAR.....	2
9	PAOZZ		64678	18-29297-000	SEAL,NONMETALLIC RO R.H.....	1
9	PAOZZ	5330013366893	5F845	75000681	SEAL,NONMETALLIC SP L.H.....	1
10	PAOZZ		64678	18-25772-000	WINDOW,VEHICULAR R.H.....	1
10	PAOZZ	2510013370246	64678	22-28974-000	WINDOW,VEHICULAR L.H.....	1
11	PAFZZ	2510013377592	64678	A18-17428-002	VENT WING ASSEMBLY, LEFT.....	1
12	PAFZZ	5305013366730	64678	A23-11466-101	SCREW,ASSEMBLED WAS BONDED WSHR, PAN HEAD, INTERNAL TORX, 10-32UNF X 5/8.....	6
13	PAFZZ	5330011112281	82654	AS-1340	RUBBER SEAL.....	2
14	PAFZZ	2510013372114	64678	18-23529-003	WINDOW,VEHICULAR.....	2
15	PAFZZ	9390013385872	64678	18-23530-001	NONMETALLIC SPECIAL.....	1
16	PAFZZ	5342013443727	64678	18-23531-000	MOUNT,RESILIENT LOCKING STRIP.....	1
17	PAFZZ	2510013370247	64678	A18-17428-003	VENT WING ASSEMBLY, RIGHT.....	1

END OF FIGURE

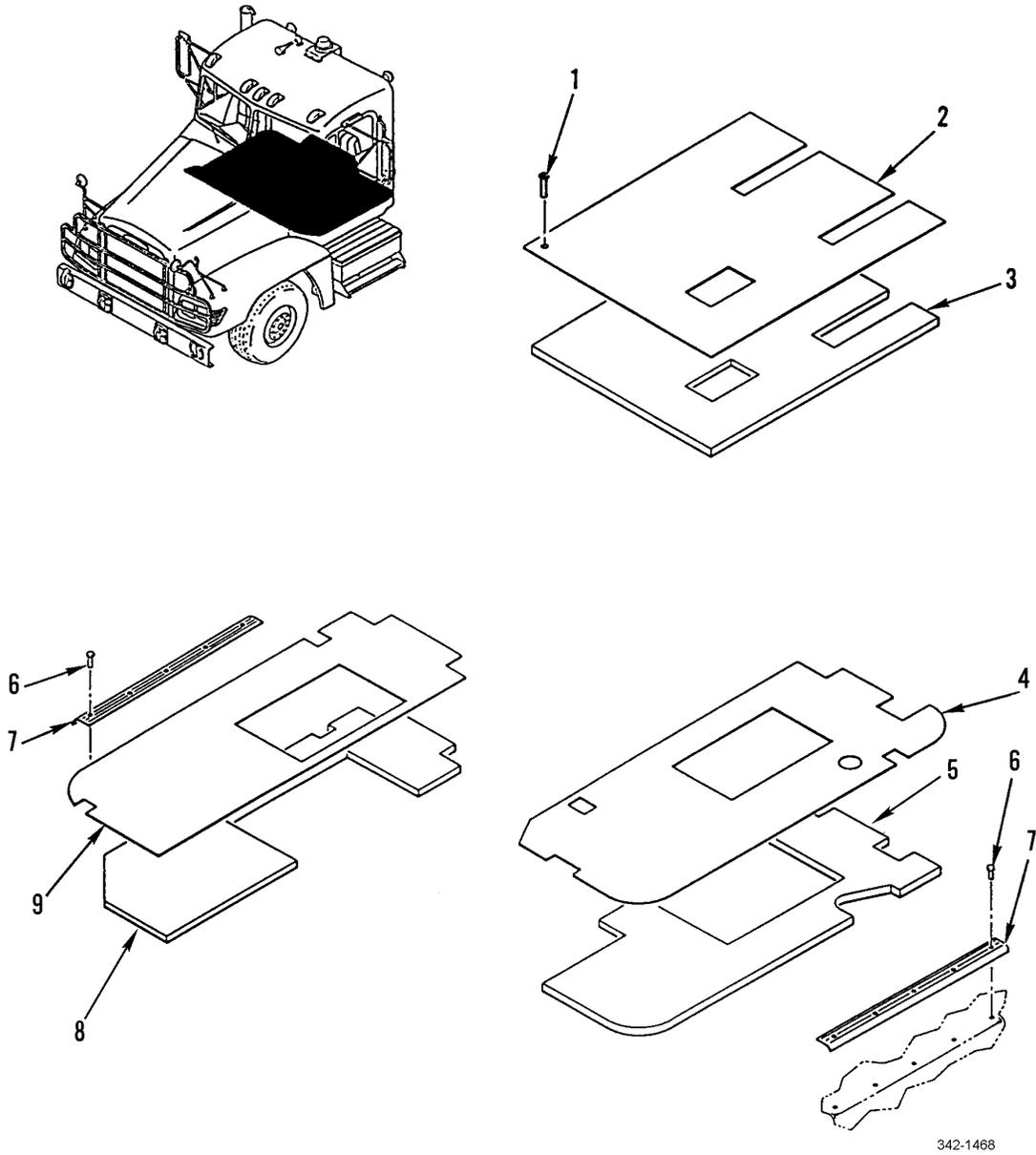
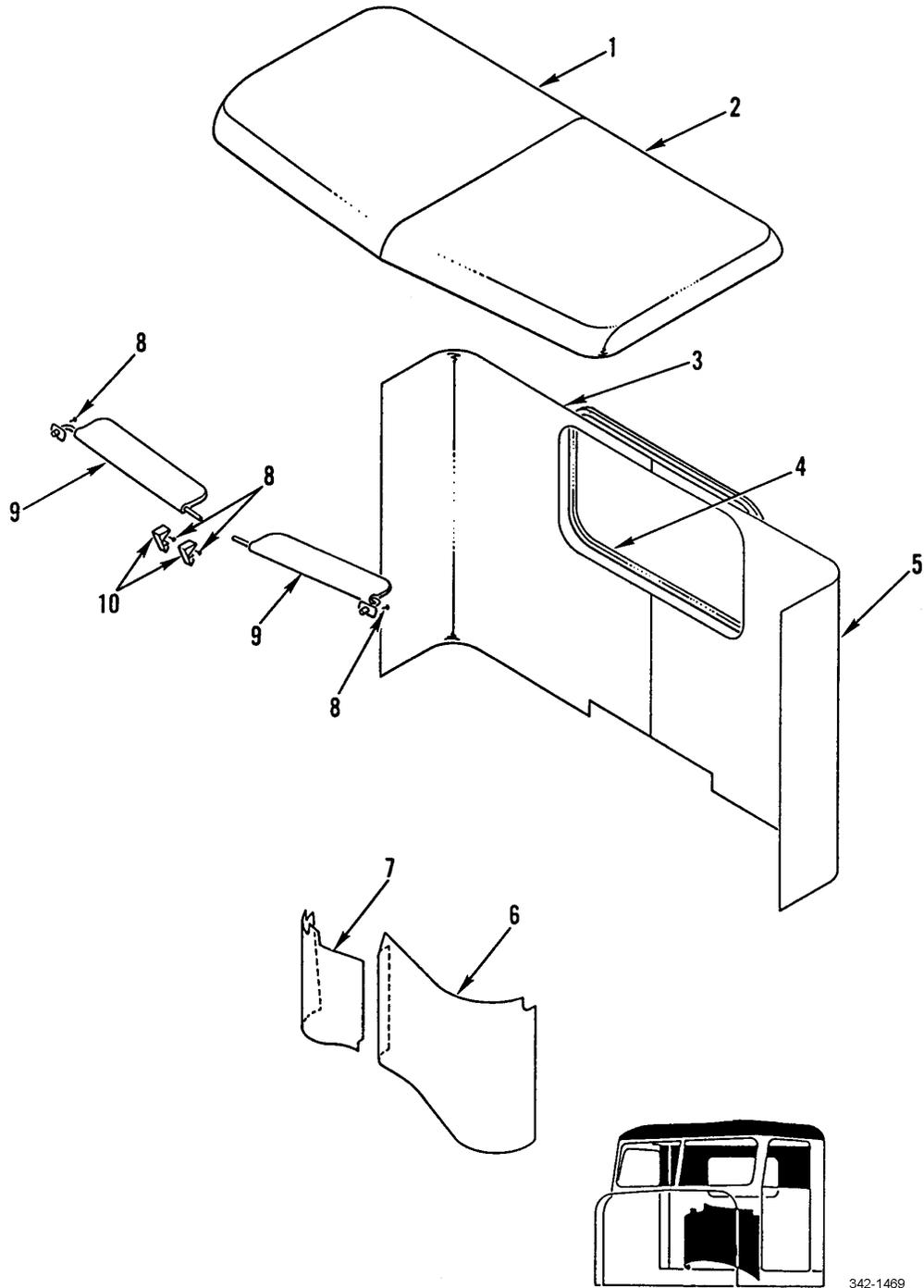

Figure 215. Floor Covering

SECTION II			TM9-2320-302-24P			
(1)	(2)	(3)	(4)	(5)	(6)	(7)
ITEM	SMR			PART		
NO	CODE	NSN	CAGEC	NUMBER	DESCRIPTION AND USABLE ON CODES(UOC)	QTY
GROUP 1805 FLOORS, SUBFLOORS, AND RELATED COMPONENTS						
FIG. 215 FLOOR COVERING						
1	PAOZZ	5305013369466	64678	23-11657-305	SCREW,TAPPING TYPE 2.....	8
2	PFOZZ		64678	18-25662-000	MAT,FLOOR TUNNEL.....	1
3	PFOZZ		64678	18-25656-000	INSULATION PANEL,VE TUNNEL.....	1
4	PFOZZ		64678	A18-27085-000	MAT,FLOOR LH.....	1
5	PFOZZ		64678	18-27087-001	INSULATION PANEL,VE LH.....	1
6	PAOZZ	5305013367550	64678	23-10035-100	SCREW,TAPPING 8-18,CD.....	10
7	XDOZZ		64678	18-19790-000	PLATE,TRD,DR SILL.....	2
8	PFOZZ		64678	18-27088-001	INSULATION PANEL,VE RH.....	1
9	PFOZZ		64678	A18-27086-000	MAT,FLOOR RH.....	1

END OF FIGURE



342-1469

Figure 216. Interior Cab Panels

SECTION II			TM9-2320-302-24P			
(1)	(2)	(3)	(4)	(5)	(6)	(7)
ITEM	SMR			PART		
NO	CODE	NSN	CAGEC	NUMBER	DESCRIPTION AND USABLE ON CODES(UOC)	QTY
					GROUP 1806 UPHOLSTERY, SEATS, AND CARPETS	
					FIG. 216 INTERIOR CAB PANELS	
1	PFHZZ		64678	A18-41021-001	PAD,CUSHIONING RIGHT.....	1
2	PFHZZ		64678	A18-41021-000	PAD,CUSHIONING LEFT.....	1
3	PFHZZ	2590013378936	64678	A18-26205-001	PAD,CUSHIONING RIGHT.....	1
4	MOOZZ		64678	18-11197-001X10	TRIM,EDGING,BLK 10 FT, MAKE FROM BULK PN 48-02188-001 (64678).....	1
5	PFOZZ	2590013370211	64678	A18-26205-000	PAD,CUSHIONING LEFT.....	1
6	PFOZZ	5340013365449	64678	A18-26207-000	COVER,ACCESS.....	1
7	PAOZZ	5340013363962	64678	A18-26208-000	COVER,ACCESS.....	1
8	PAOZZ	5305013367550	64678	23-10035-100	SCREW,TAPPING 8-18,CD.....	8
9	PAOZZ	2540013379332	64678	A22-32401-401	VISOR,SUN,VEHICLE.....	2
10	PAOZZ	5340013364248	64678	22-24648-000	CLIP,SPRING TENSION.....	2

END OF FIGURE

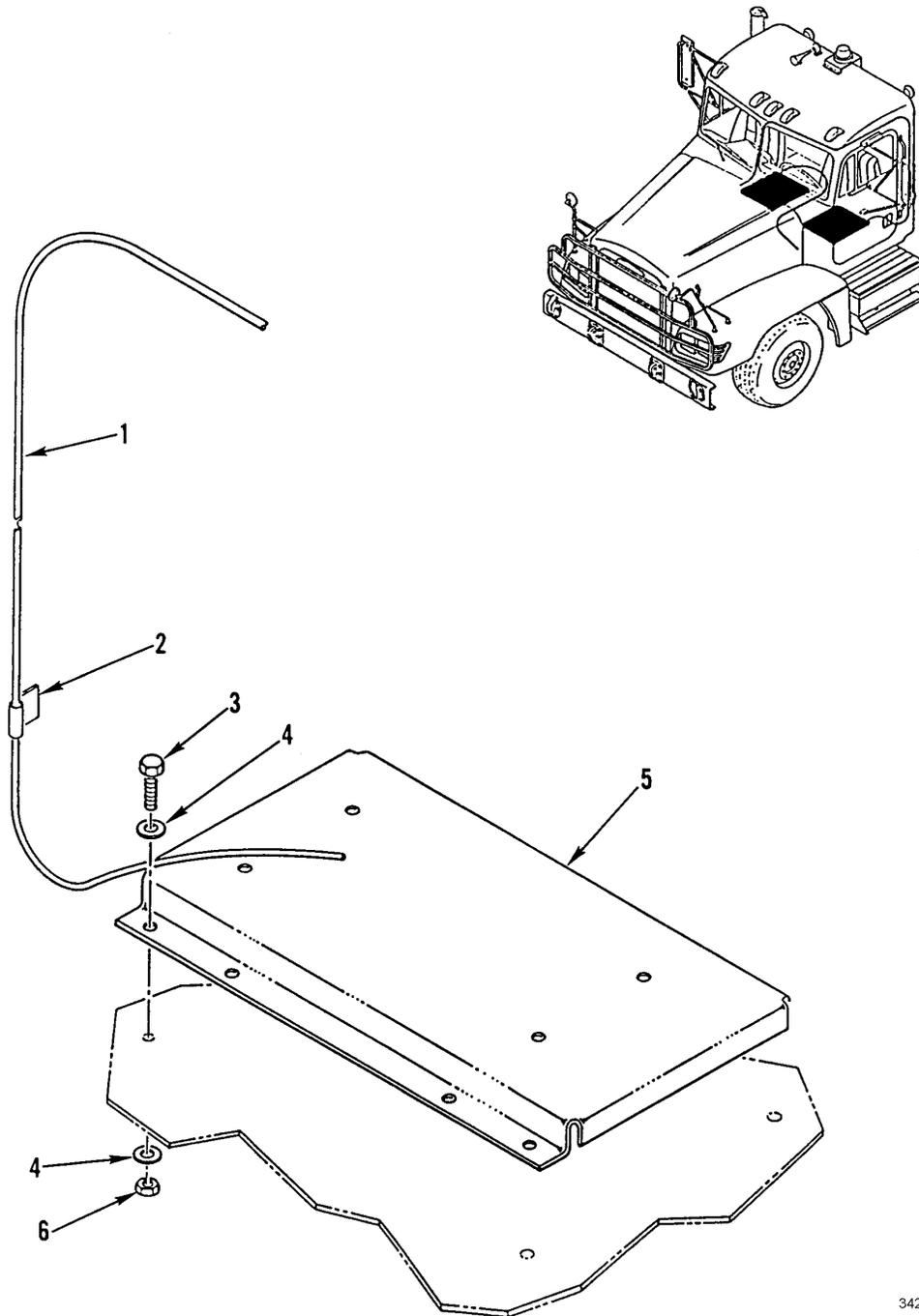

342-1346

Figure 217. Seat Mounting Bracket

SECTION II			TM9-2320-302-24P			
(1)	(2)	(3)	(4)	(5)	(6)	(7)
ITEM	SMR			PART		
NO	CODE	NSN	CAGEC	NUMBER	DESCRIPTION AND USABLE ON CODES(UOC)	QTY
					GROUP 1806 UPHOLSTERY, SEATS, AND CARPETS	
					FIG. 217 SEAT MOUNTING BRACKET	
1	MOOZZ		64678	12-13367-142	TUBE,NYLON MAKE FROM CAGE 85757,PN 3250-061,142 IN.....	2
2	PAOZZ	9330014793259	64678	23-12301-000	PLASTIC STRIP,ADHES.....	2
3	PAOZZ	5305002693211	96906	MS90725-60	SCREW,CAP,HEXAGON H.....	8
4	PAOZZ	5310007737618	96906	MS15795-814	WASHER,FLAT .406 ID X .812 OD.....	8
5	PFOZZ	5340013366920	64678	A22-24864-002	BRACKET,MULTIPLE AN.....	2
6	PAOZZ	5365013367659	17446	3LC120-2R12	SPACER,SLEEVE.....	8

END OF FIGURE

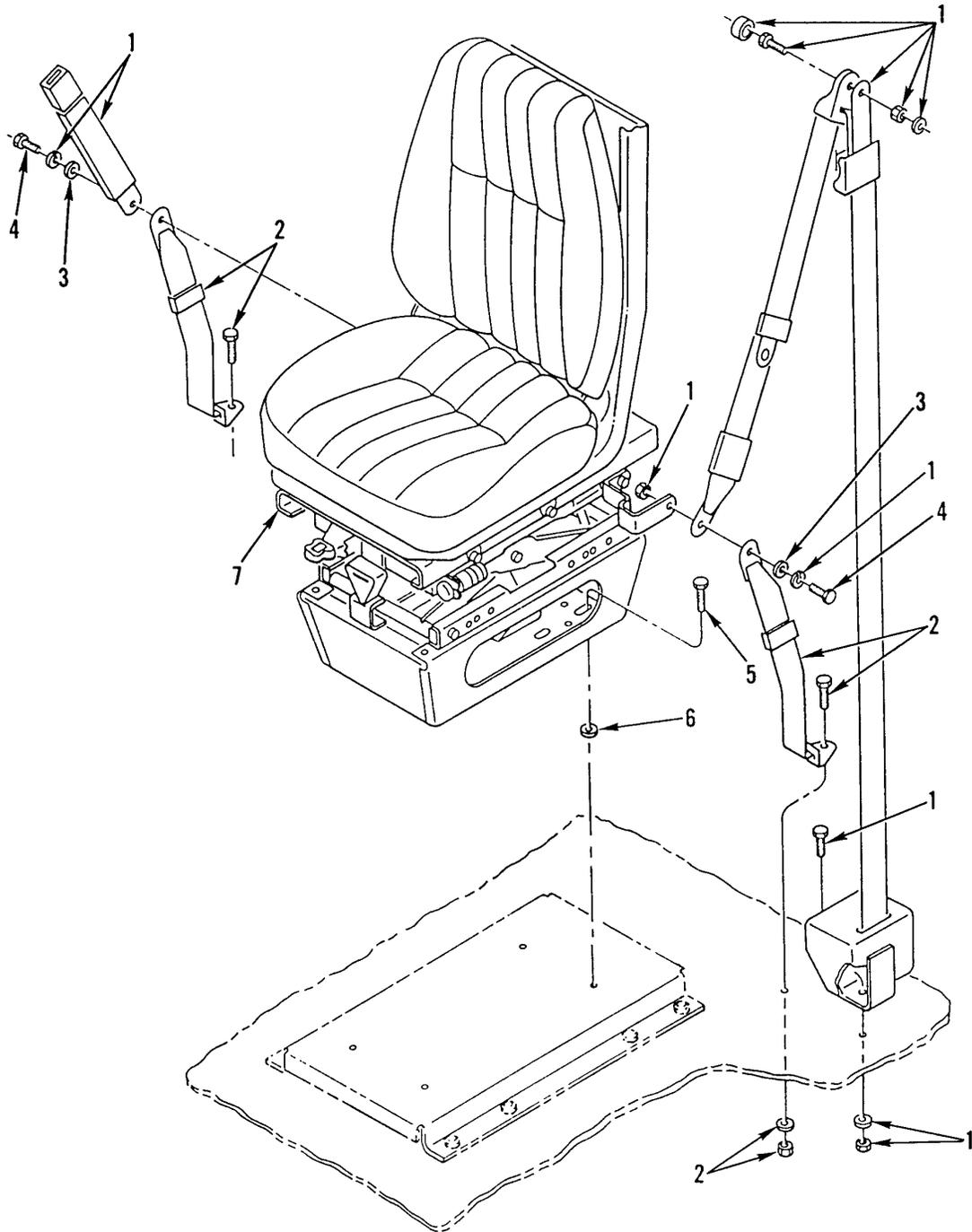

342-1347

Figure 218. Seat Mounting Hardware and Seatbelts

SECTION II			TM9-2320-302-24P			
(1)	(2)	(3)	(4)	(5)	(6)	(7)
ITEM NO	SMR CODE	NSN	CAGEC	PART NUMBER	DESCRIPTION AND USABLE ON CODES(UOC)	QTY
					GROUP 1806 UPHOLSTERY, SEATS, AND CARPETS	
					FIG. 218 SEAT MOUNTING HARDWARE AND SEATBELTS	
1	PAOZZ	2540014425480	29944	F10582	BELT,VEHICULAR SAFE.....	2
2	PAOZZ	2540014425560	29944	F10581	BELT,VEHICULAR SAFE.....	2
3	PAOZZ	5310008094061	96906	MS27183-15	WASHER,FLAT.....	4
4	PAOZZ	5305007872177	96906	MS35308-387	SCREW,CAP,HEXAGON H.....	4
5	PAOZZ	5305012104595	97403	13222E0109	SCREW,ROLLER ASSEMB 3/8-16 UNC X 1.00, GR5, ZINC AND WAX.....	4
6	PAOZZ	5310007737618	96906	MS15795-814	WASHER,FLAT.....	4
7	PFOOO	2540014426101	3B481	1239101-002	SEAT,VEHICULAR.....	2

END OF FIGURE

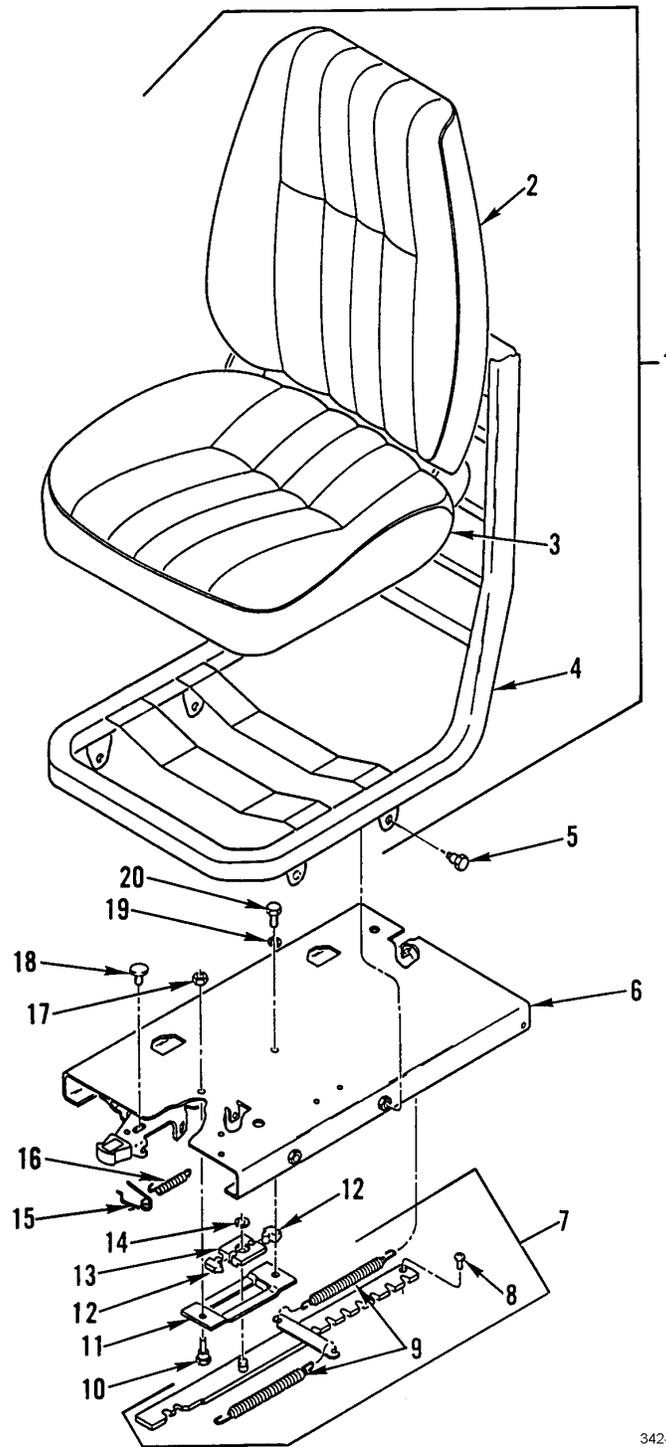

342-1535

Figure 219. Seat Assembly

SECTION II			TM9-2320-302-24P			
(1)	(2)	(3)	(4)	(5)	(6)	(7)
ITEM	SMR			PART		
NO	CODE	NSN	CAGEC	NUMBER	DESCRIPTION AND USABLE ON CODES(UOC)	QTY
GROUP 1806 UPHOLSTERY, SEATS, AND CARPETS						
FIG. 219 SEAT ASSEMBLY						
1	XAOOO		3B481	1111134-002	SEAT,PAD AND FRAME.....	1
2	PFOFF	2540013291682	3B481	1106537-364	.CUSHION,SEAT BACK,V.....	1
3	PFOFF	2540013298654	3B481	1107585-600	.CUSHION,SEAT,VEHICU.....	1
4	XAOZZ		3B481	1107485-032	.FRAME ASSY,SEAT.....	1
5	PAOZZ	5306013342813	3B481	106079-002	BOLT,SHOULDER M8 X 1.25 X 22.50MM..	4
6	XAOZZ		3B481	1106529-002	CHANNEL ASSY.....	1
7	XAOOO		3B481	1106004-002	LATCH BAR ASSY.....	1
8	PAOZZ	5305013327560	3B481	106713-001	.SCREW,MACHINE 5/16-18 X .25 PHILLIPS.....	1
9	KFOZZ		3B481	1105957-002	.SPRING,ISOLATOR PART OF KIT P/N 6107838-001.....	2
10	XDOZZ		3B481	1106051-002	BOLT,SHOULDER M8 X 1.25 X 24MM.....	1
11	PAOZZ	5340013326591	3B481	1106001-002	BRACKET,MULTIPLE AN.....	1
12	XDOZZ		3B481	1105995-002	BUMPER,NONMETALLIC.....	2
13	XDOZZ		3B481	1105999-002	SPACER,PLATE.....	1
14	PAOZZ	5340013326692	3B481	6222091-001	RING,RETAINING.....	1
15	KFOZZ		3B481	1106214-002	SPRING,LATCH PART OF KIT P/N 6107838 -001.....	1
16	KFOZZ		3B481	1106065-002	SPRING,TORSION PART OF KIT P/N 6107838-001.....	1
17	PAOZZ	5310013327253	3B481	1349236-002	NUT,SELF-LOCKING,HE M8 X 1.25.....	1
18	XDOZZ		3B481	1106049-002	PIN,GROOVED,HEADED.....	1
19	PAOZZ	5310013334542	3B481	1104385-002	WASHER,LOCK.....	1
20	PAOZZ	5305013507067	3B481	1102769-001	SCREW,CAP,HEXAGON H M8 X 1.25 X 12.0 MM.....	1

END OF FIGURE

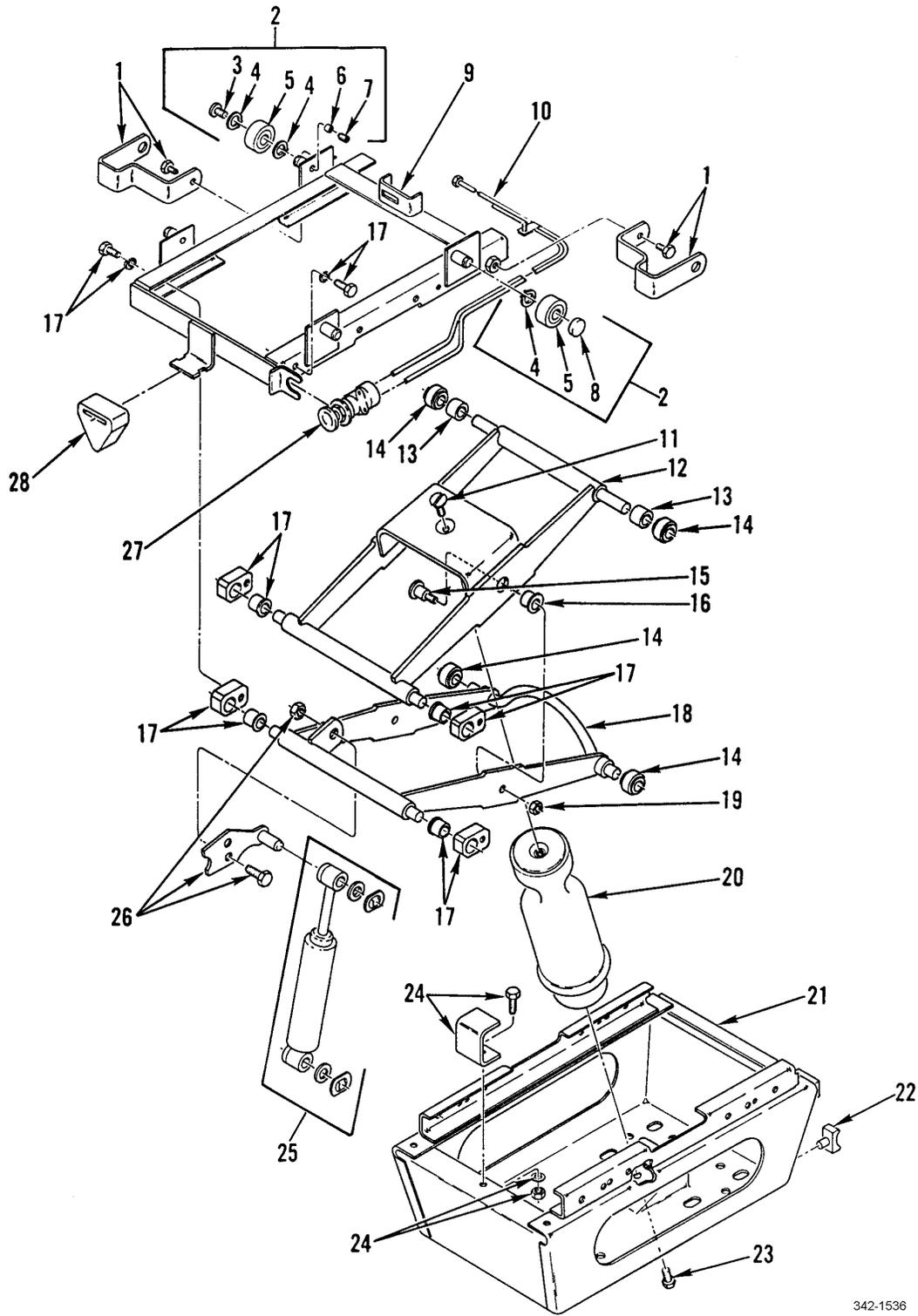

342-1536

Figure 220. Seat Base Assembly

SECTION II			TM9-2320-302-24P			
(1)	(2)	(3)	(4)	(5)	(6)	(7)
ITEM	SMR			PART		
NO	CODE	NSN	CAGEC	NUMBER	DESCRIPTION AND USABLE ON CODES(UOC)	QTY
GROUP 1806 UPHOLSTERY, SEATS, AND CARPETS						
FIG. 220 SEAT BASE ASSEMBLY						
1	PFOZZ	5342013319612	3B481	1102812-001	BRACKET,VEHICULAR S INCLUDES ATTACHING PARTS.....	4
2	PAOZZ	3990013339342	86845	1106729-001	ROLLER UNIT,RAIL TY.....	1
3	KFOZZ		3B481	1104926-002	.PAD,THRUST DELRIN PART OF KIT P/N 6107838-001.....	2
4	KFOZZ		3B481	1105712-002	.RING,RETAINING PART OF KIT P/N 6107838-001.....	6
5	KFOZZ		3B481	1200025-001	.BEARING,RDL BALL PART OF KIT P/N 6107838-001.....	4
6	KFOZZ		3B481	1104984-002	.TUBE,RUBBER PART OF KIT P/N 6107838-001.....	2
7	KFOZZ		3B481	1106834-002	.SETSCREW PART OF KIT P/N 6107838-001.....	2
8	KFOZZ		3B481	1064790-002	.CAP,END PART OF KIT P/N 6107838-001	2
9	XAOZZ		3B481	1106039-002	UPPER PLATE ASSY.....	1
10	PAOZZ	4720013321604	3B481	1107352-002	TUBING ASSEMBLY,NON INCLUDES ATTACHING PARTS.....	1
11	PAOZZ	5305013327219	3B481	107913-001	SCREW,CAP,SOCKET HE FLT HD M8 X 1.25 X 25 MM.....	1
12	XAOZZ		3B481	1106025-002	LEVER ASSY,INNER.....	1
13	XDOZZ		3B481	1063016-002	SPACER,SLEEVE.....	2
14	KFOZZ		3B481	1100642-001	ROLLER ASSY PART OF KIT P/N 6107838-001.....	4
15	KFOZZ		3B481	1106617-002	BOLT,SHOULDER PART OF KIT P/N 6107838-001.....	2
16	KFOZZ		3B481	1063248-801	BEARING,MULTILUBE PART OF KIT P/N 6107838-001.....	6
17	PAOZZ	3120013327172	3B481	1106748-001	PARTS KIT,BEARING R INCLUDES ATTACHING PARTS.....	1
18	XAOZZ		3B481	1106026-002	LEVER ASSY,OUTER.....	1
19	PAOZZ	5310013327253	3B481	1349236-002	NUT,SELF-LOCKING,HE M8 X 1.25 PART OF KIT P/N 6107838-001.....	2
20	PAOZZ	2510013326037	3B481	6222086-001	AIR SPRING,VEHICULA.....	1
21	XAOZZ		3B481	1106019-004	RISER ASSY.....	1
22	KFOZZ		3B481	1104950-001	UP STOP PART OF KIT P/N 6107838-001.	2
23	PAOZZ	5305013334516	3B481	107226-001	SCREW,CAP,HEXAGON H M8 X 1.25 X 30 MM.....	1
24	KFOZZ		3B481	1106335-004.	BRACKET,DOUBLE ANGL INCLUDES ATTACHING PARTS PART OF KIT P/N 6107838-001.....	1
25	PAOZZ	2530013330722	3B481	6222080-001	VALVE,BLEEDER,HYDRA.....	1
26	PAOZZ	5340013336624	3B481	1106021-002	LEVER,MANUAL CONTRO.....	2
27	PAOZZ	2530013330721	3B481	6222077-001	VALVE,BRAKE,PROPORT.....	1
28	PAOZZ	5340013326705	3B481	1102770-001	BUMPER,NONMETALLIC.....	1

END OF FIGURE

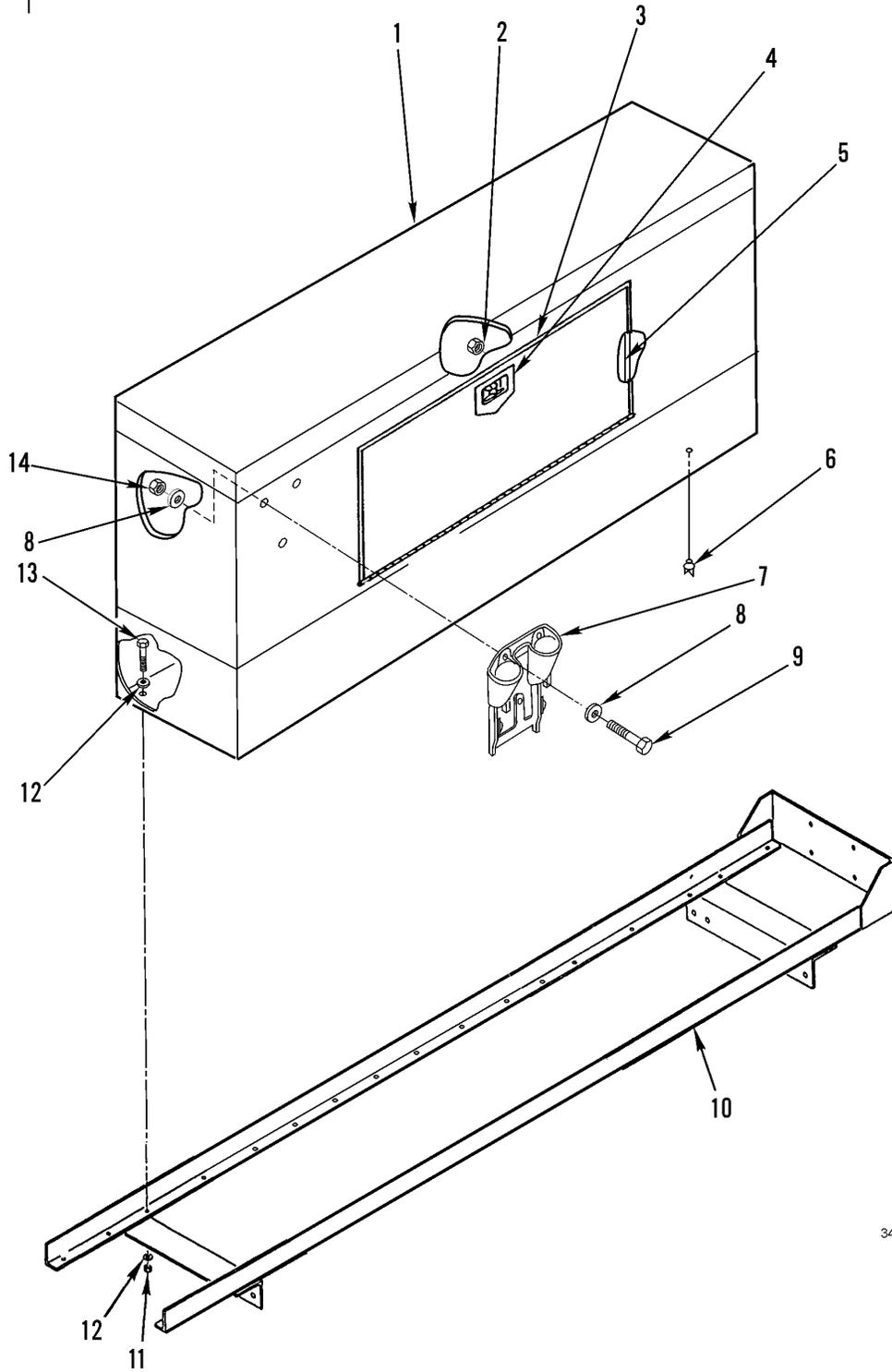
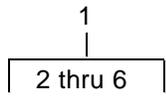

342-1470

Figure 221. Personnel and Tire Chain Boxes

SECTION II			TM9-2320-302-24P			
(1)	(2)	(3)	(4)	(5)	(6)	(7)
ITEM	SMR		PART			
NO	CODE	NSN	CAGEC	NUMBER	DESCRIPTION AND USABLE ON CODES(UOC)	QTY
					GROUP 1808 STOWAGE RACKS, BOXES, STRAPS, CARRYING CASES, CABLE REELS, HOSE REELS, ETC.	
					FIG. 221 PERSONNEL AND TIRE CHAIN BOXES	
1	PGOOO		64678	A22-35193-003	CABINET, STORAGE.....	1
2	PAOZZ	5310000881251	81349	M45913/1-4CG5C	.NUT, SELF LOCKING, HE 1/4-20UNC.....	4
3	XAOZZ		64678	A22-38715-000	.DOOR, EQPT BOX.....	1
4	PAOZZ	2540013575687	64678	SIE/481STUDS	.LATCH, DOOR, VEHICULA.....	1
5	MOOZZ		64678	48-02471-001X8	.SEAL, DOOR 8 FT, MAKE FROM BULK PN 22-25294-001 (64678).....	1
6	PFOZZ		18265	P533226	.VALVE, DRAIN.....	1
7	PFOZZ		64678	12-17042-000	DUMMY COUPLING, AUTO.....	1
8	XDOZZ		64678	681 990 16 40	WASHER, FLAT .343 X .625 X .62, SS..	6
9	XDOZZ		64678	23-12096-125	SCREW, MACHINE 5/16-18 TORX HEAD, SST.....	3
10	XDOZZ		64678	A22-49798-000	BRACKET, MOUNTING.....	1
11	PAOZZ	5310000874652	96906	MS51922-17	NUT, SELF-LOCKING, HE 3/8-16UNC.....	10
12	PAOZZ	5310000806004	96906	MS27183-14	WASHER, FLAT 3/8".....	20
13	PAOZZ	5305012460609	64678	23-09436-125	SCREW, CAP, HEXAGON H 3/8-16 X 1.25..	10
14	XDOZZ		64678	23-09982-031	NUT, PLAIN HEXAGON 5/16-16 UNC X .195 HGT, SS.....	3

END OF FIGURE

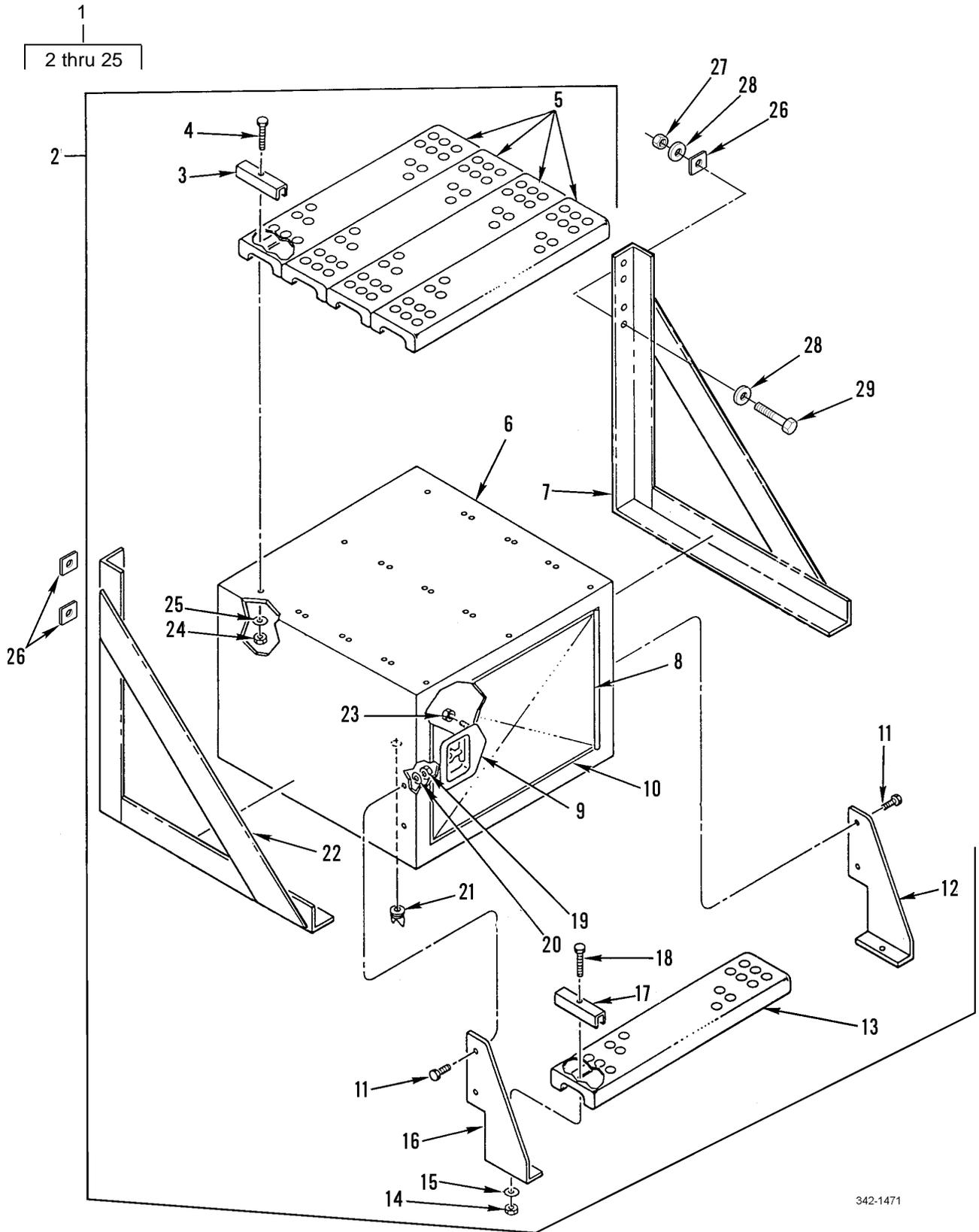

342-1471

Figure 222. Tractor Equipment Box

SECTION II			TM9-2320-302-24P			
(1)	(2)	(3)	(4)	(5)	(6)	(7)
ITEM NO	SMR CODE	NSN	CAGEC	PART NUMBER	DESCRIPTION AND USABLE ON CODES(UOC)	QTY
					GROUP 1808 STOWAGE RACKS, BOXES, STRAPS, CARRYING CASES, CABLE REELS, HOSE REELS, ETC.	
					FIG. 222 TRACTOR EQUIPMENT BOX	
1	XDOOO		64678	A22-35190-001	BOX,ACCESSORIES STO.....	1
2	PFOZZ	2540013387454	64678	A22-35189-001	.BOX,ACCESSORIES STO.....	1
3	PAOZZ	5340013379231	64678	22-35842-000	.CLAMP,BRIDGE.....	8
4	PAOZZ	5306010758519	96906	MS90725-36	.BOLT,MACHINE.....	8
5	PFOZZ	2510013370231	64678	A06-17158-000	.TREAD,METALLIC,NONS.....	4
6	XAOZZ		64678	A22-38640-001	.BOX.....	1
7	XDOZZ		64678	A22-35197-003	.BRACKET,SUPPORT LH.....	1
8	MOOZZ		64678	48-02471-001X55	.SEAL 5.5 FT. MAKE FROM BULK PN 22-25294-001 (64678).....	1
9	PAOZZ	2540013575687	64678	SIE/481STUDS	.LATCH,DOOR,VEHICULA.....	1
10	XAOZZ		64678	A22-38643-000	.DOOR.....	1
11	PAOZZ	5305000712067	80204	B1821BH050C125N	.SCREW,CAP,HEXAGON H 1/2-13UNC X 1.25.....	4
12	PAOZZ	5340013383189	64678	22-35222-001	.BRACKET,ANGLE RH.....	1
13	PFOZZ	2510013392317	64678	681 883 24 01	.TREAD,METALLIC,NONS.....	1
14	PAOZZ	5310009133366	96906	MS51922-11	.NUT,SELF-LOCKING,HE 5/16-18UNC....	2
15	PAOZZ	5310000814219	96906	MS27183-12	.WASHER,FLAT .344 ID X .688 OD X .065 THK.....	2
16	PAOZZ	5340013366914	64678	22-35222-000	.BRACKET,ANGLE LH.....	1
17	PAOZZ	5340013326696	64678	681 883 00 32	.STRAP,RETAINING.....	2
18	PAOZZ	5305002264831	80204	B1821BH031C150N	.SCREW,CAP,HEXAGON H 5/16-18UNC X 1.50.....	2
19	PAOZZ	5310002256993	96906	MS51922-33	.NUT,SELF-LOCKING,HE 1/2-13UNC.....	4
20	PAOZZ	5310008095998	96906	MS27183-18	.WASHER,FLAT .531 ID X 1.062 OD X .095 THK.....	4
21	PFOZZ		18265	P533226	.VALVE,DRAIN.....	1
22	XDOZZ		64678	A22-35197-002	.BRACKET,SUPPORT RH.....	1
23	PAOZZ	5310000881251	81349	M45913/1-4CG5C	.NUT,SELF LOCKING,HE 1/4-20UNC.....	4
24	PAOZZ	5310009133366	96906	MS51922-11	.NUT,SELF-LOCKING,HE.....	8
25	PAOZZ	5310000814219	96906	MS27183-12	.WASHER,FLAT.....	16
26	PAOZZ	5365013560083	64678	E22-25841-008	SPACER,PLATE.....	3
27	PAOZZ	5310002694040	96906	MS51922-49	NUT,SELF-LOCKING,HE.....	4
28	PAOZZ	5310013334538	64678	23-09114-007	WASHER,FLAT.....	8
29	PAOZZ	5305007247223	80204	B1821BH063C225N	SCREW,CAP,HEXAGON H 5/8-11UNC X 2.25.....	4

END OF FIGURE

SECTION II			TM9-2320-302-24P			
(1)	(2)	(3)	(4)	(5)	(6)	(7)
ITEM	SMR			PART		
NO	CODE	NSN	CAGEC	NUMBER	DESCRIPTION AND USABLE ON CODES(UOC)	QTY
					GROUP 1808 STOWAGE RACKS, BOXES, STRAPS, CARRYING CASES, CABLE REELS, HOSE REELS, ETC.	
					FIG. 223 JACK HOLDDOWN COMPONENTS	
1	PAOZZ	5310013570854	64678	23-09900-104	NUT, SELF-LOCKING, HE 1/4-20UNC.....	3
2	PAOZZ	5310008094058	96906	MS27183-10	WASHER, FLAT 1/4".....	3
3	PAOZZ	5306002264829	80204	B1821BH031C125N	BOLT, MACHINE 1/4-20 X 1.25.....	3
4	XDOZZ		64678	A22-35598-000	BRACKET, VEHICULAR C.....	1
5	PAOZZ		64678	681 541 00 K0	STRAP, ELASTIC.....	1

END OF FIGURE

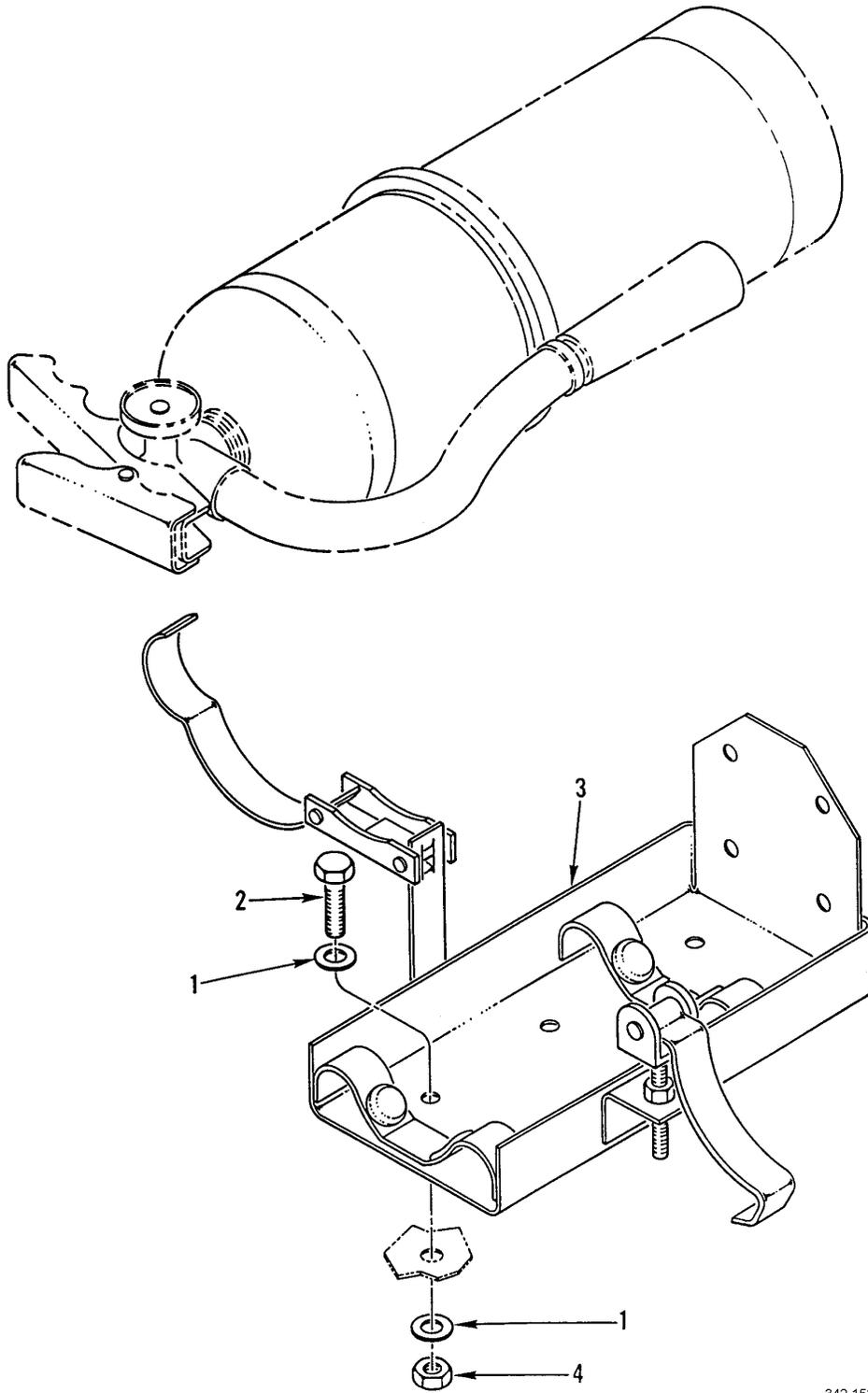

342-1539

Figure 224. Fire Extinguisher Bracket

SECTION II			TM9-2320-302-24P			
(1)	(2)	(3)	(4)	(5)	(6)	(7)
ITEM	SMR			PART		
NO	CODE	NSN	CAGEC	NUMBER	DESCRIPTION AND USABLE ON CODES(UOC)	QTY
					GROUP 1808 STOWAGE RACKS, BOXES, STRAPS, CARRYING CASES, CABLE REELS, HOSE REELS, ETC.	
					FIG. 224 FIRE EXTINGUISHER BRACKET	
1	PAOZZ	5310008094058	96906	MS27183-10	WASHER,FLAT .281 ID X .625 OD X .065 THK.....	8
2	PAOZZ	5305013367014	64678	23-10414-150	SCREW,MACHINE 1/4-20,ZINK.....	4
3	PAOZZ	4210012821789	54905	809	BRACKET,FIRE EXTING.....	1
4	PAOZZ	5310000881251	81349	M45913/1-4CG5C	NUT,SELF LOCKING,HE 1/4-20UNC.....	4

END OF FIGURE

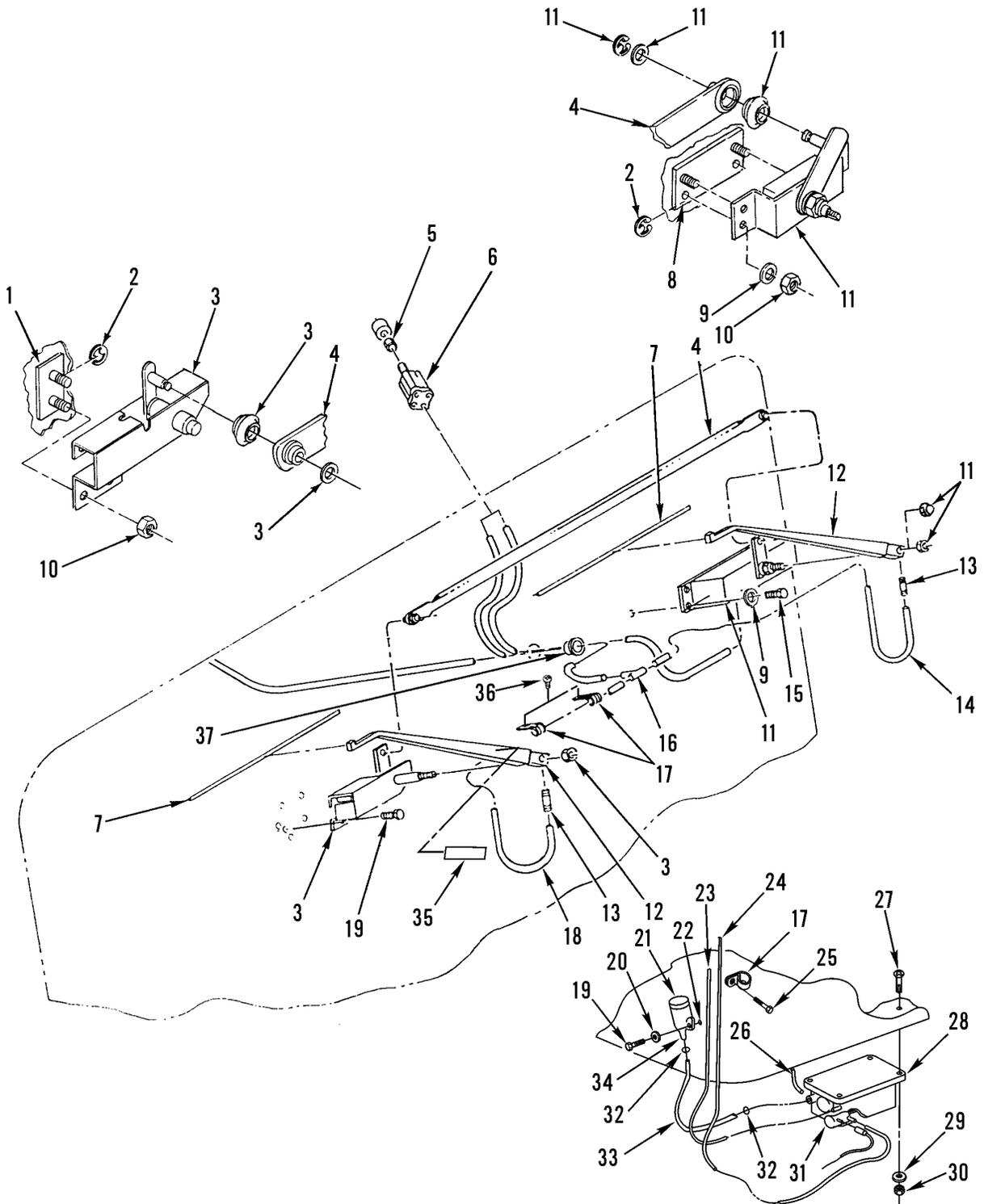
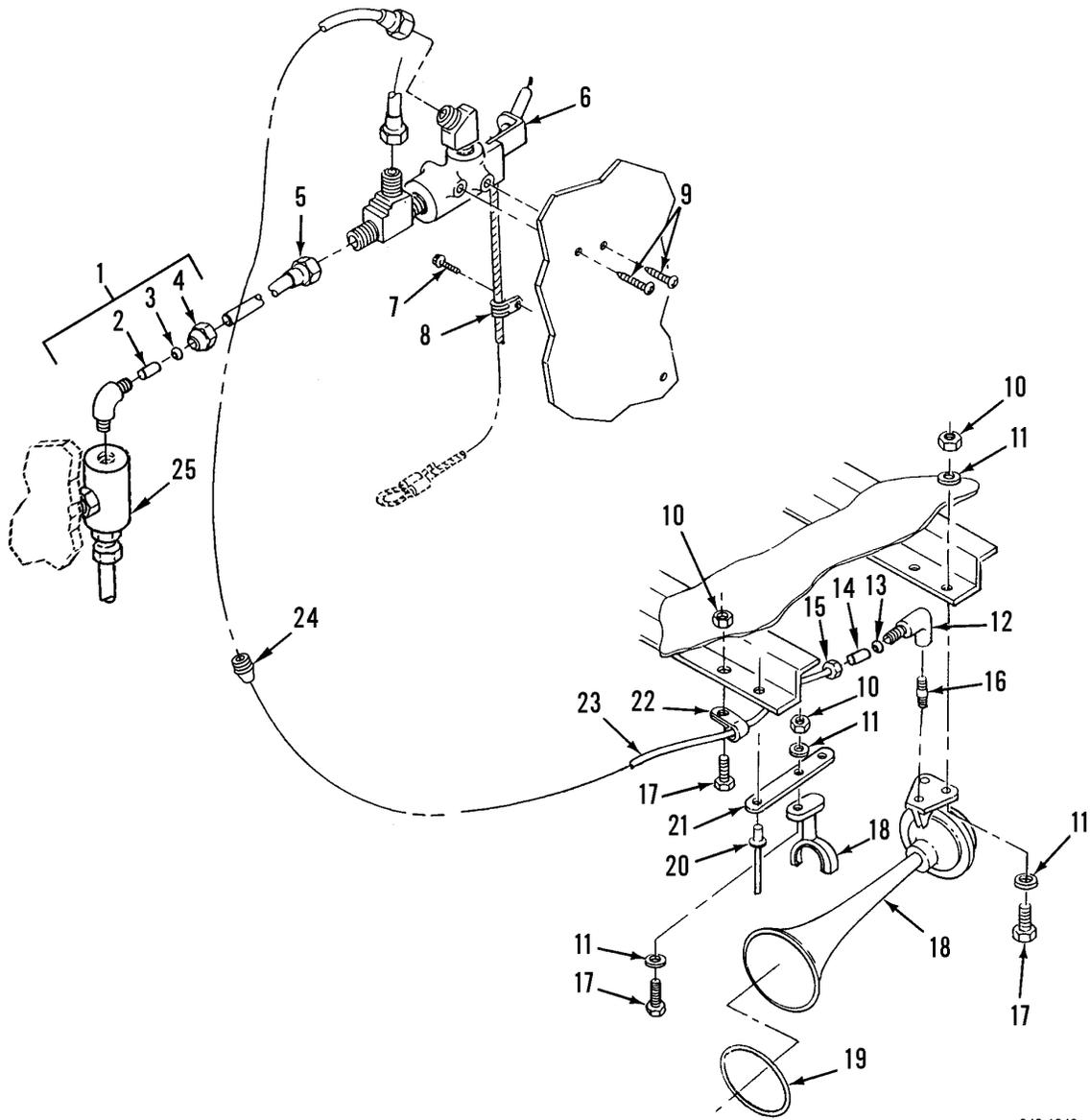
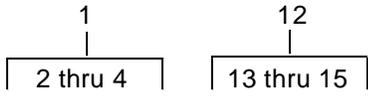

Figure 225. Windshield Wipers, Motor and Washer Bottle

SECTION II			TM9-2320-302-24P			
(1)	(2)	(3)	(4)	(5)	(6)	(7)
ITEM NO	SMR CODE	NSN	CAGEC	PART NUMBER	DESCRIPTION AND USABLE ON CODES(UOC)	QTY
GROUP 22 BODY, CHASSIS, AND HULL ACCESSORY ITEMS GROUP 2202 ACCESSORY ITEMS						
FIG. 225 WINDSHIELD WIPERS, MOTOR AND WASHER BOTTLE						
1	XDOZZ		64678	A06-19799-000	PLATE,MOUNTING.....	1
2	PAOZZ	5340013315739	70655	8868	CLIP,SPRING TENSION.....	3
3	XDOZZ		64678	A22-45533-000	BRKT/PIVOT ASSY.....	1
4	PAOZZ	3040014787794	64678	A22-41519-000	CONNECTING LINK,RIG.....	1
5	XDOZZ		64678	22-23372-001	KNOB.....	1
6	PAOZZ	5930014786816	64678	A22-30822-000	SWITCH,ROTARY DOES NOT INCLUDE KNOB	1
7	PAOZZ	2540010981865	70412	51-15	BLADE,WINDSHIELD WI.....	2
8	XDOZZ		64678	A22-21041-001	PLATE ASSY PIECE PART WELDED.....	1
9	PAOZZ	5310008094058	96906	MS27183-10	WASHER,FLAT.....	4
10	PAOZZ	5310013570854	64678	23-09900-104	NUT,SELF-LOCKING,HE.....	6
11	PAOZZ	2540014791522	64678	A22-45492-000	MOTOR,WINDSHIELD WI WIPER MOTOR....	1
12	PAOZZ	2540014429346	82484	4188 30BWS	ARM,WINDSHIELD WIPE.....	2
13	PAOZZ	4730013374479	64678	N220-2	MENDER,HOSE.....	2
14	MOOZZ		64678	48-02017-100X18	HOSE,NONMETALLIC LH 18 IN. MAKE FROM BULK PN 35055 (98933).....	1
15	PAOZZ	5305000712519	80204	B1821BH025C400N	SCREW,CAP,HEXAGON H 1/4-20 X 4.00..	2
16	PAOZZ	4730012838173	82464	W-58-1	.TEE,HOSE.....	1
17	PAOZZ	5340007645231	01276	900729-4	CLAMP,LOOP.....	3
18	MOOZZ		64678	48-02017-100X30	HOSE,NONMETALLIC RH 30 IN. MAKE FROM BULK PN 35055 (98933).....	1
19	PAOZZ	5305011373938	96906	MS51871-3	SCREW,TAPPING 1/4-20 X 0.75.....	4
20	PAOZZ	5310008094058	96906	MS27183-10	WASHER,FLAT 1/4 INCH.....	2
21	PAOZZ		19986	063350	.CAP,FILLER,OPENING VENTED.....	1
22	XDOZZ		64678	23-09277-049	RIVNUT,ALUMINUM 1/4-20 UNC-38.....	2
23	MOOZZ		64678	48-02017-156X048	HOSE,NONMETALLIC 48 IN. CUT TO FIT, MAKE FROM BULK PN: 35055 (98933)...	1
24	MOOZZ		64678	48-02017-156X72	HOSE,NONMETALLIC 72 IN. MAKE FROM BULK PN: 35055 (98933).....	1
25	PAOZZ	5305013369466	64678	23-11657-305	SCREW,TAPPING.....	3
26	MOOZZ		64678	3744936X006	.TUBING,NONMETALLIC 3/16 X 6 IN. MAKE FROM BULK PN 3744936 (12204)...	1
27	XDOZZ		64678	23-11033-100	BOLT,CARRIAGE 1/4-20 X 1.0.....	4
28	PAOOO		19986	062659	RESERVOIR,WINDSHIEL.....	1
29	XDOZZ		64678	23-10900-025	WASHER,FLAT 1/4 INCH SS.....	4
30	PAOZZ	5310008512674	96906	MS35691-1	NUT,PLAIN,HEXAGON.....	4
31	PAOZZ	2540013615146	19986	066011	.PUMP,WINDSHIELD WAS.....	1
32	PAOZZ	5975013389190	64678	23-09796-309	STRAP,TIEDOWN,ELECT.....	2
33	MOOZZ		64678	468105X42	TUBING,NONMETALLIC CLEAR 5/8 X 42 IN. MAKE FROM BULK PN 468105 (19986) .FILLER NECK.....	1
34	PAOZZ	2590013612388	19986	066023	LABEL,CAUTION.....	2
35	XDOZZ		64678	24-00401-000	SCREW,TAPPING.....	2
36	PAOZZ	5305011373938	96906	MS51871-3	GROMMET,NONMETALLIC.....	1
37	PAOZZ	5325014062124	64678	12-14621-000		

END OF FIGURE



342-1348

Figure 226. Air Horn Assembly and Mounting Hardware

SECTION II			TM9-2320-302-24P			
(1)	(2)	(3)	(4)	(5)	(6)	(7)
ITEM NO	SMR CODE	NSN	CAGEC	PART NUMBER	DESCRIPTION AND USABLE ON CODES(UOC)	QTY
GROUP 2202 ACCESSORY ITEMS						
FIG. 226 AIR HORN ASSEMBLY AND MOUNTING HARDWARE						
1	PFOZZ	4730010864064	93061	269NTA-4-4	ELBOW,PIPE TO TUBE.....	1
2	PAOZZ	4730010577109	93061	63NTA-4	.INSERT,TUBE FITTING.....	1
3	PAOZZ	4730010486358	93061	60NTA-4	.SLEEVE,COMPRESSION,.....	1
4	PAOZZ	4730010486968	93061	61NTA-4	.NUT,TUBE COUPLING.....	1
5	MOOZZ		87373	PFT4A BLK100X48	TUBING,NONMETALLIC 48 IN. MAKE FROM BULK PN: 3250-061 (85757).....	1
6	PAOZZ	4820013327647	64678	A22-25627-002	VALVE,ANGLE.....	1
7	PAOZZ	5305013409857	64678	23-10891-704	SCREW,SELF-DRILLING.....	1
8	PAOZZ	5340012991813	5G881	W4NY-125NA	CLAMP,LOOP.....	1
9	PAOZZ	5305013332822	93907	224-60610	SCREW,TAPPING 10-14 X 3/4.....	2
10	PAOZZ	5310000881251	81349	M45913/1-4CG5C	NUT,SELF LOCKING,HE 1/4-20.....	4
11	PAOZZ	5310008094058	96906	MS27183-10	WASHER,FLAT 1/4 IN.....	6
12	PAOZZ	4730011131791	93061	270NTA-4-2	ELBOW,PIPE TO TUBE.....	1
13	PAOZZ	4730010577109	93061	63NTA-4	.INSERT,TUBE FITTING.....	1
14	PAOZZ	4730010486358	93061	60NTA-4	.SLEEVE,COMPRESSION,.....	1
15	PAOZZ	4730010486968	93061	61NTA-4	.NUT,TUBE COUPLING.....	1
16	PAOZZ	4730002301996	96906	MS51846-1	NIPPLE,PIPE .405 OD X 1/8,NPT.....	1
17	PAOZZ	5305002253843	80204	B1821BH025C100N	SCREW,CAP,HEXAGON H 1/4-20 X 1.00..	4
18	PAOZZ	2590012464298	26501	1725	HORN,PNEUMATIC.....	1
19	PGOZZ	2530014479838	26501	1697	COVER,HORN BUTTON.....	1
20	PAOZZ	5320011570908	19738	2771-0817	RIVET,BLIND.....	1
21	PFOZZ	5365012458802	64678	23-09130-003	SPACER,PLATE.....	1
22	PAOZZ	5340013502444	18076	S463-G4	CLAMP,LOOP.....	1
23	MOOZZ		87373	PFT4A BLK100X105	TUBING,NONMETALLIC 105 IN. MAKE FROM BULK PN: 3250-061 (85757).....	1
24	XDOZZ		64678	681 997 05 81	GROMMET.....	1
25	PAOZZ	4730000888666	79470	C3609X4	TEE,PIPE.....	1

END OF FIGURE

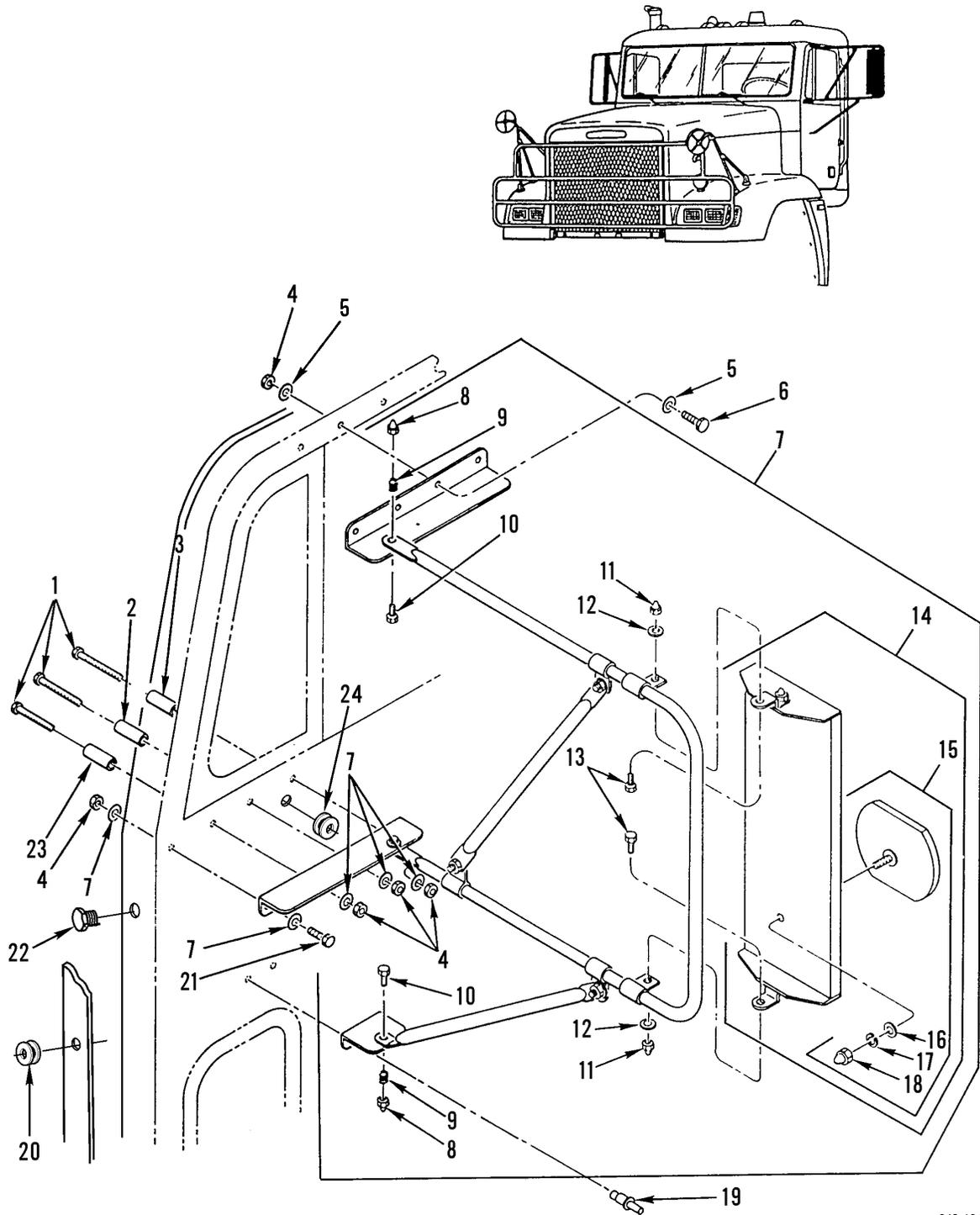

342-1349

Figure 227. Rear View Mirror and Attaching Hardware

SECTION II			TM9-2320-302-24P			
(1)	(2)	(3)	(4)	(5)	(6)	(7)
ITEM NO	SMR CODE	NSN	CAGEC	PART NUMBER	DESCRIPTION AND USABLE ON CODES(UOC)	QTY
GROUP 2202 ACCESSORY ITEMS						
FIG. 227 REAR VIEW MIRROR AND ATTACHING HARDWARE						
1	PAOZZ		64678	23-11529-275	SCREW,CAP, SOCKET HD 1/4-20 X 2.75, ALLEN HEAD .188.....	6
2	PAOZZ	5365013366451	64678	18-17849-002	SPACER, SLEEVE.....	2
3	PAOZZ	5365013367657	64678	18-17849-001	SPACER, SLEEVE.....	2
4	PAOZZ	5310000881251	81349	M45913/1-4CG5C	NUT, SELF LOCKING, HE 1/4-20UNC.....	16
5	PAOZZ	5310008094058	96906	MS27183-10	WASHER, FLAT .281 ID X .625 OD X .065 THK.....	26
6	PAOZZ	5305002253843	80204	B1821BH025C100N	SCREW,CAP, HEXAGON H 1/4-20UND-2A X 1.000.....	8
7	PAOOO		30226	158HFRGVV2L	MIRROR ASSEMBLY, REA.....	1
7	PAOOO		30226	158HFRGVV2R	MIRROR ASSEMBLY, REA.....	1
8	PAOZZ	5310013570819	64678	23-11553-138	.NUT, PLAIN, CAP 3/8 INCH, LOW CROWN, SST.....	2
9	PAOZZ	5360013570838	64678	23-09033-000	.SPRING, HELICAL, COMP.....	2
10	PFOZZ	5305013373258	96906	MS51107-64	.SCREW, CAP, HEXAGON H .0375-16UNC X 2.00.....	2
11	PAOZZ	5310013570820	64678	23-11553-225	.NUT, PLAIN, CAP 1/4 INCH, LOW CROWN, SST.....	6
12	PAOZZ	5310013570878	64678	23-09983-025	.WASHER, LOCK 1/4 IN.....	6
13	PAOZZ	5306000680513	18876	PMS90727001-06	.BOLT, MACHINE.....	6
14	PAOZZ		30226	S158KDV1H	.MIRROR HEAD, VEHICUL.....	1
15	PAOZZ	2540013549260	30226	951	.MIRROR HEAD, VEHICUL.....	1
16	PAOZZ	5310008892528	96906	MS45904-68	...WASHER, LOCK.....	1
17	PAOZZ	5310013570878	64678	23-09983-025	...WASHER, LOCK 1/4 IN.....	1
18	PAOZZ	5310013570820	64678	23-11553-225	...NUT, PLAIN, CAP 1/4 INCH, LOW CROWN, SST.....	1
19	XDOZZ		64678	23-11052-101	RIVET, BLIND 1/4.....	1
20	PAOZZ	5325013344808	64678	23-11185-000	GROMMET, NONMETALLIC.....	4
21	PAOZZ	5305000680509	80204	B1821BH025C125N	SCREW, CAP, HEXAGON H 1/4-20UNC-2A X 1.250.....	2
22	XDOZZ		64678	23-11689-005	PLUG, HOLE.....	2
23	PAOZZ	5365013366450	64678	18-17849-000	SPACER, SLEEVE.....	2
24	PAOZZ	5325013366929	70485	5436	GROMMET, NONMETALLIC.....	2

END OF FIGURE

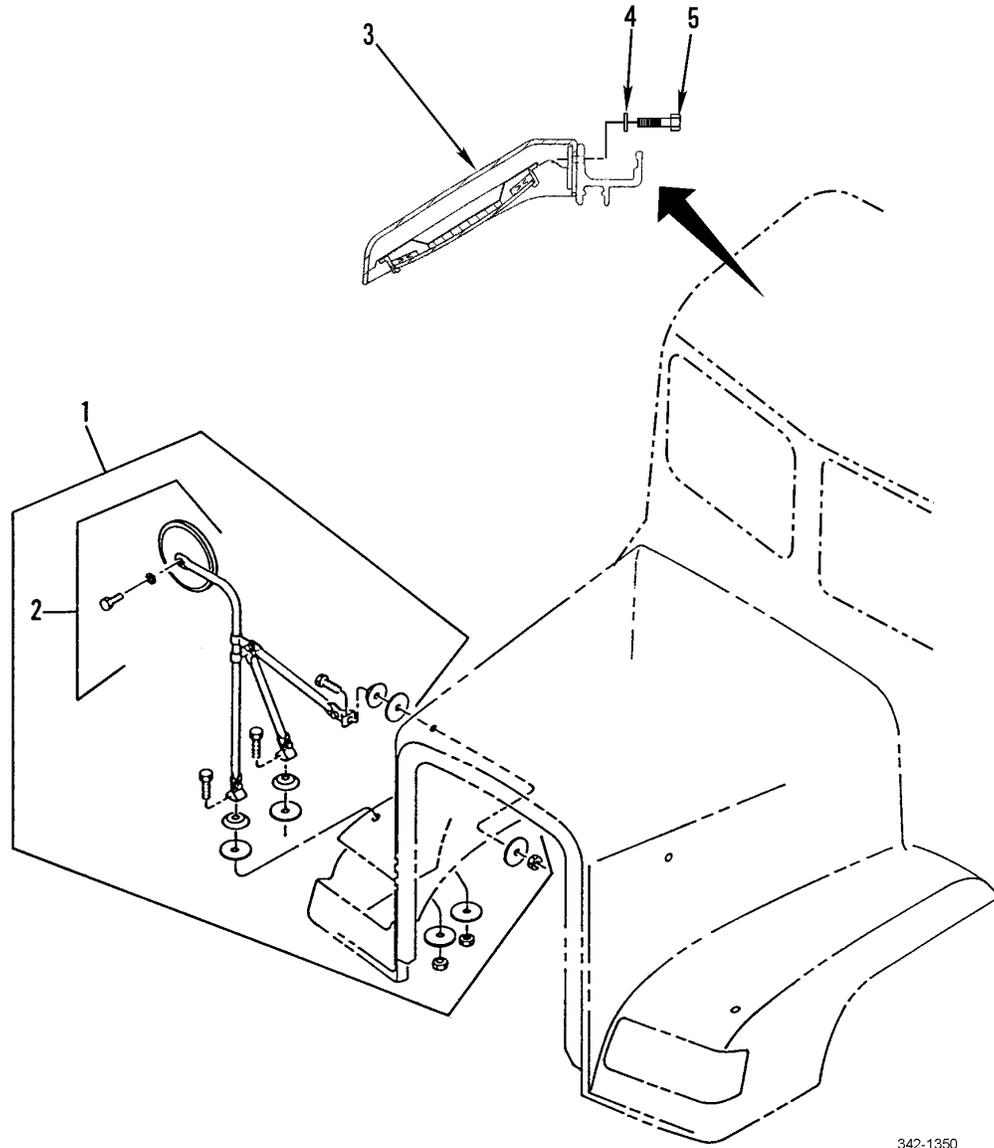

342-1350

Figure 228. Rear View Mirror (Spotter) and Lookdown Mirror

SECTION II			TM9-2320-302-24P			
(1)	(2)	(3)	(4)	(5)	(6)	(7)
ITEM	SMR			PART		
NO	CODE	NSN	CAGEC	NUMBER	DESCRIPTION AND USABLE ON CODES(UOC)	QTY
GROUP 2202 ACCESSORY ITEMS						
FIG. 228 REAR VIEW MIRROR (SPOTTER) AND LOOKDOWN MIRROR						
1	PAOOO	2540013284750	64678	SPN/1761	MIRROR ASSEMBLY, REA.....	2
2	PAOZZ	2540013302621	64678	SPN/1760	.MIRROR HEAD, VEHICUL INCLUDES	1
3	PAOZA	2540014791528	64678	A22-30931-000	MIRROR HEAD & ATTACHING HARDWARE....	1
4	XDOZZ		64678	23-11599-002	MIRROR ASSEMBLY, REA USED ON RIGHT HAND DOOR.....	1
5	XDOZZ		64678	23-11681-075	WASHER, FLAT, SPECIAL .265 ID X .5 OD, 16 GA SST.....	2
					SCREW, CAP, HEXAGON H 1/4-20C X.75 SST.....	2

END OF FIGURE

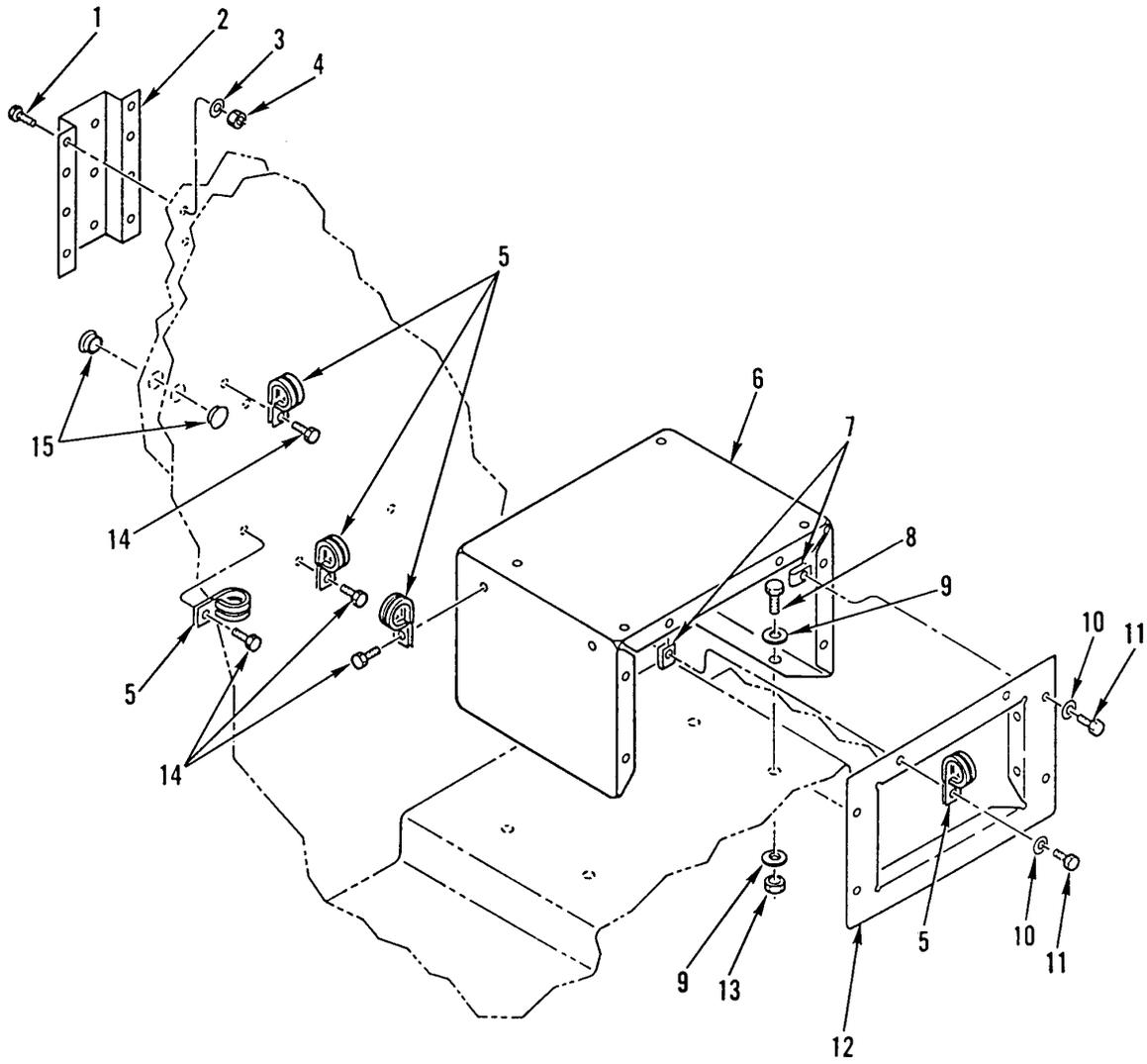

342-1431

Figure 229. Radio Antenna Mounting

SECTION II			TM9-2320-302-24P			
(1)	(2)	(3)	(4)	(5)	(6)	(7)
ITEM	SMR			PART		
NO	CODE	NSN	CAGEC	NUMBER	DESCRIPTION AND USABLE ON CODES(UOC)	QTY
GROUP 2202 ACCESSORY ITEMS						
FIG. 229 RADIO ANTENNA MOUNTING						
1	PAOZZ	5305002253843	80204	B1821BH025C100N	SCREW,CAP,HEXAGON H 1/4-20UNC-2A X 1.000.....	8
2	PAOZZ	5340013367647	64678	A22-35430-000	BRACKET,MULTIPLE AN.....	1
3	PAOZZ	5310008094058	96906	MS27183-10	WASHER,FLAT .281 ID X .625 OD X .065 THK.....	8
4	PAOZZ	5310000881251	81349	M45913/1-4CG5C	NUT,SELF LOCKING,HE 1/4-20UNC.....	8
5	PAOZZ	5340011453232	01276	900729-21	CLAMP,LOOP.....	9
6	PFOZZ	5340013376577	64678	22-34781-000	PLATE,MOUNTING.....	1
7	PBOZZ	5310013365345	86928	A-703-1	NUT,CLIP-ON 1/4-20.....	6
8	XDOZZ		64678	23-11683-150	BOLT,MACHINE 3/8-16 X 1.5, SS.....	4
9	PAOZZ	5310007737618	96906	MS15795-814	WASHER,FLAT 3/8", SS.....	8
10	PAOZZ	5310008094058	96906	MS27183-10	WASHER,FLAT .281 ID X .625 OD X .065 THK.....	6
11	PAOZZ	5305002253843	80204	B1821BH025C100N	SCREW,CAP,HEXAGON H 1/4-20UNC-2A X 1.000.....	6
12	PFOZZ		64678	22-38270-000	FRAME,STRUCTURAL,VE.....	1
13	PAOZZ	5310000874652	96906	MS51922-17	NUT,SELF-LOCKING,HE 3/8-16UNC.....	4
14	PAOZZ	5305013367551	64678	23-10673-075	SCREW,TAPPING 1/4-14.....	7
15	XDOZZ		28520	DP-875 2703	PLUG.....	2

END OF FIGURE

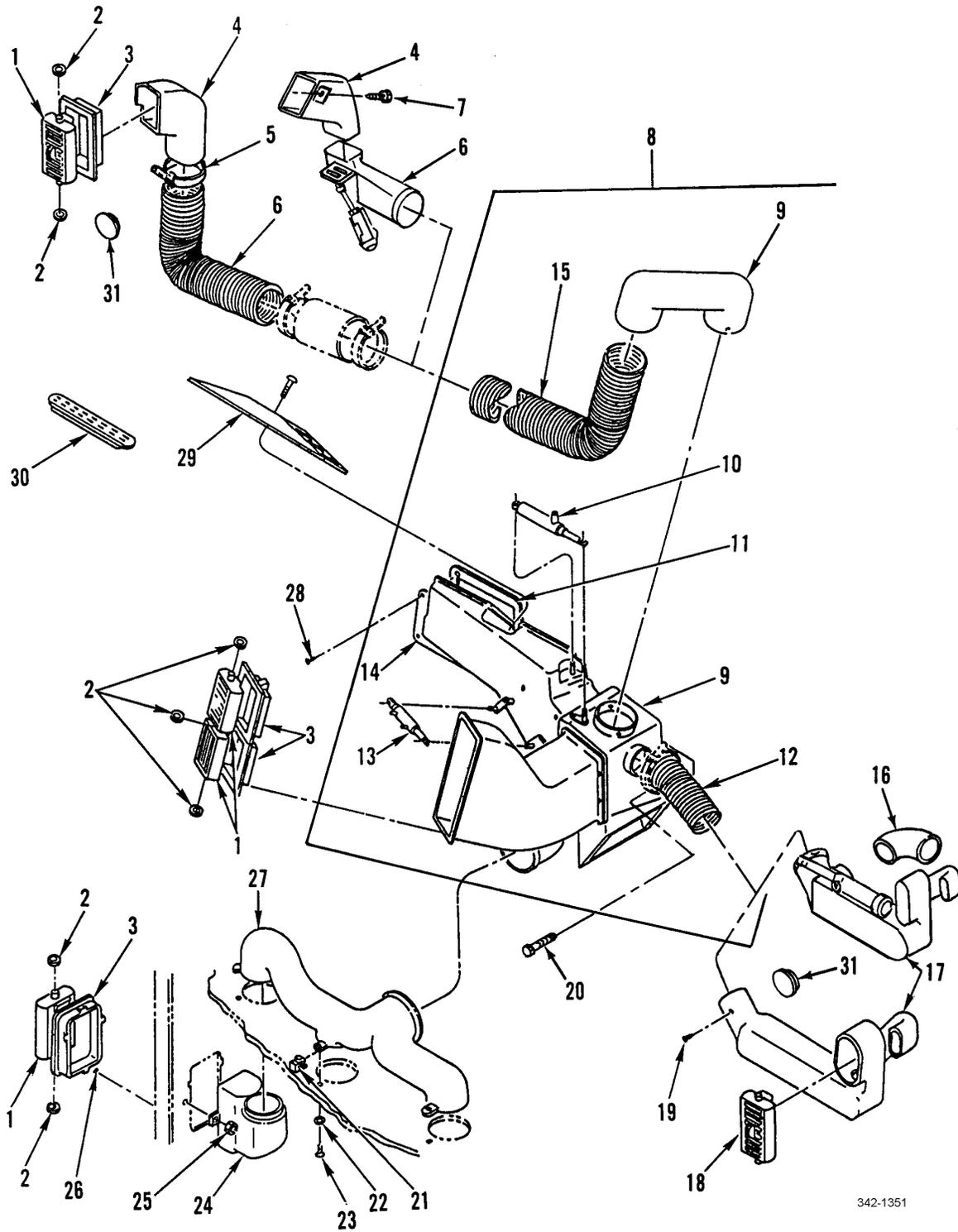

342-1351

Figure 230. Vehicle Heater Duct Assembly

SECTION II			TM9-2320-302-24P			
(1)	(2)	(3)	(4)	(5)	(6)	(7)
ITEM NO	SMR CODE	NSN	CAGEC	PART NUMBER	DESCRIPTION AND USABLE ON CODES(UOC)	QTY
GROUP 2202 ACCESSORY ITEMS						
FIG. 230 VEHICLE HEATER DUCT ASSEMBLY						
1	PFOZZ	2540013374097	64678	721	VENTILATOR,AIR CIRC.....	6
2	PFOZZ	5310014066332	86928	5613-37-062	WASHER,FLAT .265ID X .505OD X .062.	14
3	XDOZZ		64678	22-20576-001	BEZEL,A/C,LH.....	6
4	XDOZZ		64678	8512030400	DUCT,OUTLET SECTION.....	1
5	PFOZZ	5975001563253	96906	MS3367-2-9	STRAP,TIEDOWN,ELECT.....	3
6	XDOZZ		64678	8512030300	DUCT ASSY,LH,SECT.....	1
7	PFOZZ	5305014413307	64678	23-10094-038	SCREW,TAPPING NO. 6X3/8 IN.....	2
8	PAOOO	4710013377366	64678	A22-30599-001	DUCT,MICROCLIMATIC.....	1
9	PAOZZ	4710013377367	64678	85.031.30.809	.DUCT,MICROCLIMATIC.....	1
10	PAOZZ	3040013377428	64678	80.618.00.009	.CYLINDER ASSEMBLY,A.....	1
11	PAOZZ	5330013365360	64678	22-28965-00	.GASKET.....	1
12	PAOZZ	4720013378833	64678	80.349.00.109	.HOSE,AIR DUCT.....	1
13	PAOZZ	3040013382410	64678	80.618.00.019	.CYLINDER ASSEMBLY,A.....	1
14	PFOZZ	5340013364025	64678	22-28966-000	.BRACKET,MOUNTING.....	1
15	XDOZZ		64678	80.233.00.069	.HOSE,AIR DUCT.....	1
16	XDOZZ		64678	684038.00	DUCT-HEAT,FLOOR,RH RH.....	1
17	XDOZZ		64678	8512630200	DUCT-RS OUTLET.....	1
18	PFOZZ	2540013374098	64678	22-33741-000	VENTILATOR,AIR CIRC.....	1
19	PAOZZ	5305013369466	64678	23-11657-305	SCREW,TAPPING 8-18 X 5/8.....	3
20	PFOZZ	5305014418719	64678	23-12022-075	SCREW,MACHINE.....	1
21	PAOZZ	5310013372353	64678	23-11865-000	NUT,CLIP-ON 10-16.....	3
22	PAOZZ	5310004420908	28839	10-51354	WASHER,FLAT .195 ID X .750 OD X .060 THK.....	3
23	PAOZZ	5305013366830	64678	23-11345-710	SETSCREW 10B,DOG PT,BLK.....	5
24	PFOZZ	4720013369719	64678	22-30549-000	HOSE,AIR DUCT.....	1
25	PAOZZ	5310013384116	64678	23-11668-000	NUT,CLIP-ON.....	2
26	PFOZZ	5305013367551	64678	23-10673-075	SCREW,TAPPING 1/4-14.....	3
27	PFOZZ	4520013370207	64678	22-34443-000	LATERAL,AIR CONDITI.....	1
28	PAOZZ		64678	23-10056-704	SCREW,MACHINE.....	1
29	PFOZZ	2540013374096	64678	A22-20252-000	VENTILATOR,AIR CIRC.....	1
30	PAOZZ	2510013370232	64678	18-19420-000	GRILLE,METAL.....	4
31	XDOZZ		99017	BP-2 1/2	PLUG,DASH.....	2

END OF FIGURE

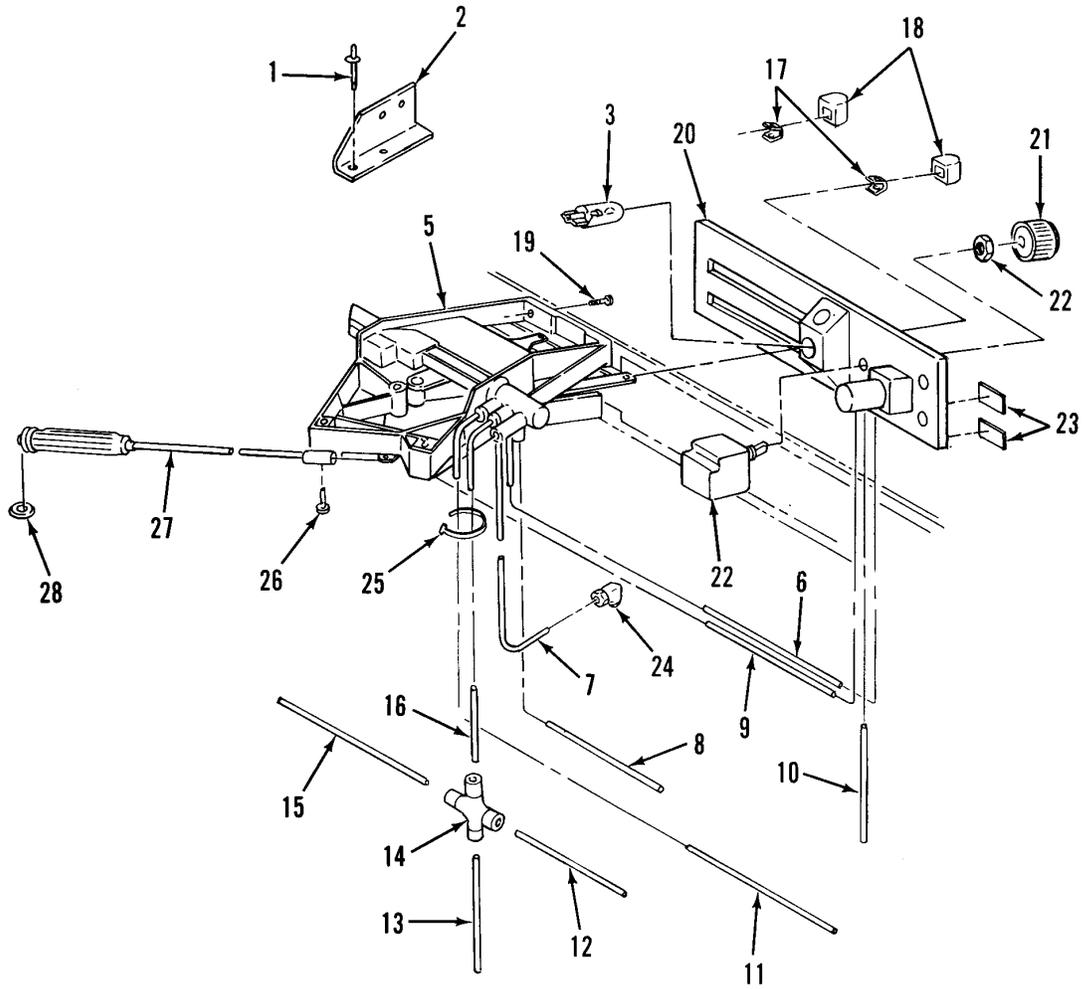
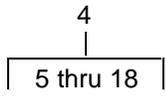

342-1352

Figure 231. Heater/AC Control Assembly

SECTION II			TM9-2320-302-24P			
(1)	(2)	(3)	(4)	(5)	(6)	(7)
ITEM	SMR			PART		
NO	CODE	NSN	CAGEC	NUMBER	DESCRIPTION AND USABLE ON CODES(UOC)	QTY
GROUP 2202 ACCESSORY ITEMS						
FIG. 231 HEATER A/C CONTROL ASSEMBLY						
1	PAOZZ	5320012432947	19738	2771-0824	RIVET,BLIND.....	2
2	PFOZZ	5340013363933	64678	A22-30548-000	BRACKET,ANGLE.....	1
3	PAOZZ	6240009441264	58451	PL194	LAMP,INCANDESCENT.....	1
4	XDOOO		64678	A22-36278-001	CONTROL ASSY,AC/HTR INCLUDES 2 KNOBS, 2 CLIPS.....	1
5	PFOZZ	2540014417689	64678	ARS805-0001-000	.HOUSING AND LEVER A INCLUDES 2 KNOBS, 2 CLIPS.....	1
6	MOOZZ		64678	48-00100-816X6	.TUBING,NYLON 6 IN. MAKE FROM BULK C602 (30327).....	1
7	MOOZZ		64678	48-00100-814X16	.TUBING,NYLON 16 IN. MAKE FROM BULK C602 (30327).....	1
8	MOOZZ		64678	48-00100-816X48	.TUBING,NYLON 48 IN. MAKE FROM BULK C602 (30327).....	1
9	MOOZZ		64678	48-00100-829X12	.TUBING,NYLON 12 IN. MAKE FROM BULK C602 (30327).....	1
10	MOOZZ		64678	48-00100-812X18	.TUBING,NYLON 18 IN. MAKE FROM BULK C602 (30327).....	1
11	MOOZZ		64678	48-00100-815X15	.TUBING,NYLON 15 IN. MAKE FROM BULK C602 (30327).....	1
12	MOOZZ		64678	48-00100-816X18	.TUBING,NYLON 18 IN. MAKE FROM BULK C602 (30327).....	1
13	MOOZZ		64678	48-00100-816X48	.TUBING,NYLON 48 IN. MAKE FROM BULK C602 (30327).....	1
14	PFOZZ	4730014416491	0HXS2	017-0007-001	.CROSS,BOSS.....	1
15	MOOZZ		64678	48-00100-829X56	.TUBING,NYLON 56 IN. MAKE FROM BULK C602 (30327).....	1
16	MOOZZ		64678	48-00100-812X15	.TUBING,NYLON 15 IN. MAKE FROM BULK C602 (30327).....	1
17	PAOZZ	5340013398805	64678	ARS 651B	.CLIP,RETAINING.....	2
18	PAOZZ	5355013389457	64678	BCH14P1	.KNOB.....	2
19	PAOZZ	5305014419376	64678	23-12195-075	SCREW,MACHINE 10-24UNC X 0.75 TORX HD, DOG POINT.....	4
20	XDOZZ		64678	A22-45655-000	BEZEL ASSY,CONTROL INCLUDES RECIRC VALVE WITH FITTINGS.....	1
21	PAOZZ	5355014788725	64678	22-23372-001	KNOB.....	1
22	PAOZZ	5930013365442	64678	A06-14889-001	SWITCH,ROTARY.....	1
23	XDOZZ		64678	24-00665-003	LABEL.....	1
24	PAOZZ	4730008035665	30327	269-P 1/8 X 1/8	ELBOW,PIPE TO TUBE.....	1
25	PAOZZ	5975013389190	16956	08-402	STRAP,TIEDOWN,ELECT.....	2
26	PAOZZ	5305013366598	64678	23-10410-062	SCREW,MACHINE.....	1
27	PFOZZ	2590014425038	64678	22-40896-000	CABLE ASSEMBLY,CONT.....	1
28	PAOZZ	5325014439525	64678	23-09457-005	RING,RETAINING.....	1

END OF FIGURE

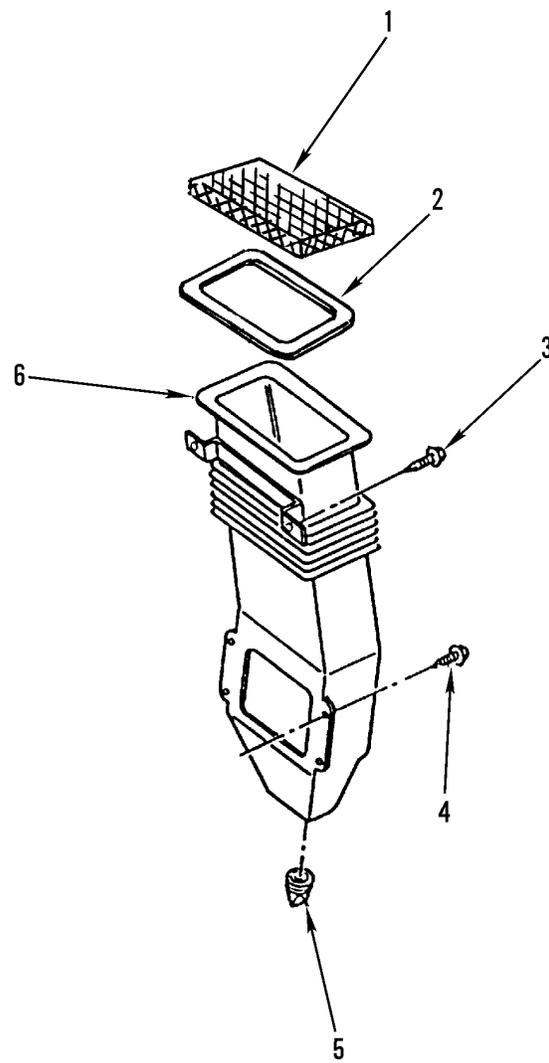

342-1432

Figure 232. Vehicle Heater Air Intake

SECTION II			TM9-2320-302-24P			
(1)	(2)	(3)	(4)	(5)	(6)	(7)
ITEM	SMR			PART		
NO	CODE	NSN	CAGEC	NUMBER	DESCRIPTION AND USABLE ON CODES(UOC)	QTY
GROUP 2202 ACCESSORY ITEMS						
FIG. 232 VEHICLE HEATER AIR INTAKE						
1	XDOZZ		64678	22-30530-000	SCREEN,INTAKE.....	1
2	XDOZZ		64678	22-29913-000	GASKET,INLET,UPPER.....	1
3	PAFZZ	5305013367551	64678	23-10673-075	SCREW,TAPPING 1/4-14.....	2
4	PAFZZ	5306001218232	32195	308742	BOLT,MACHINE 1/4-20 UNC X 3/4.....	4
5	PAFZZ	4820011971880	18265	P14-9099	VALVE,VACUUM BREAKI.....	2
6	PAFZZ	2540013575696	64678	A22-32031-000	HOUSING,AIR INTAKE,.....	1

END OF FIGURE

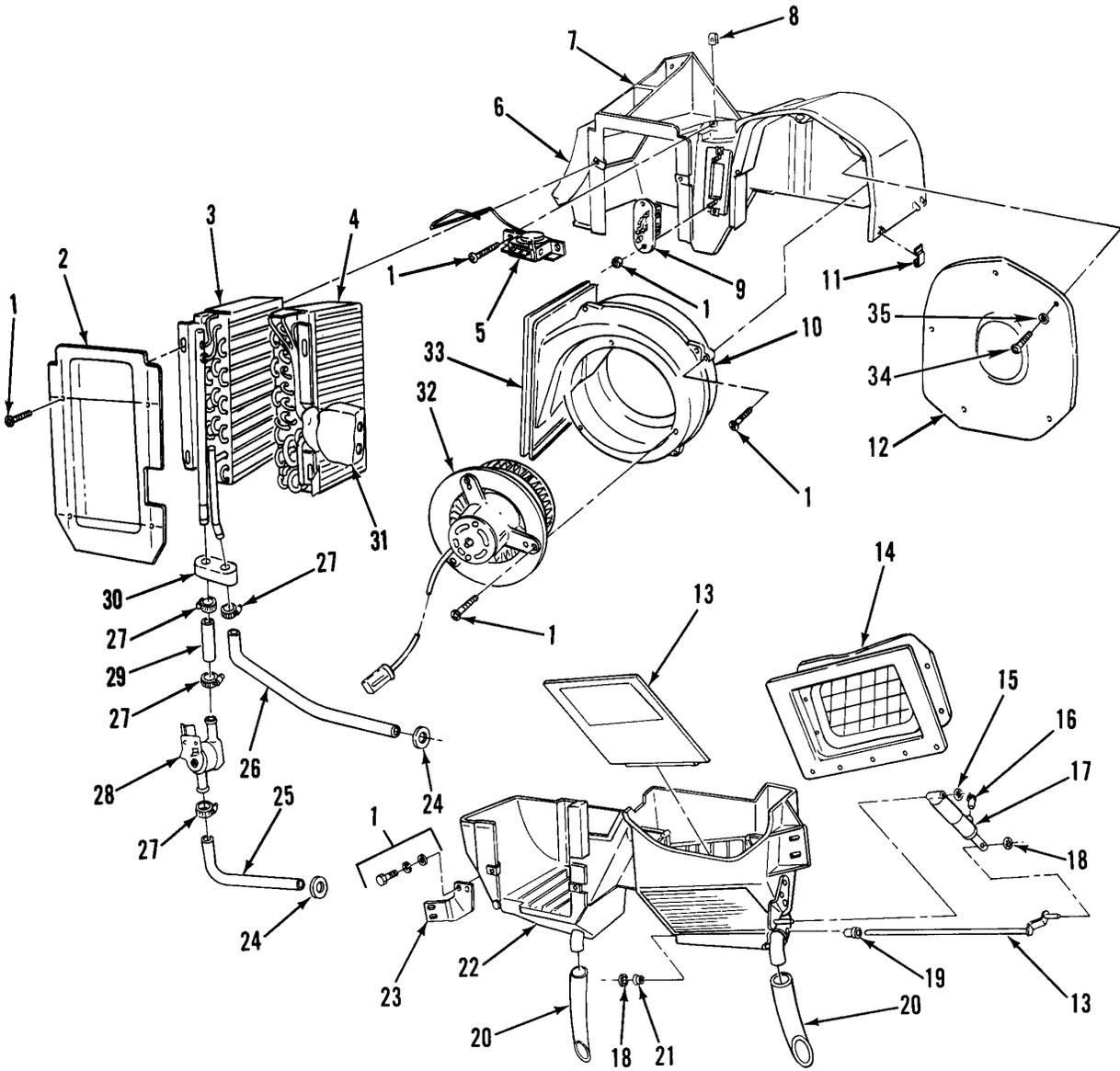
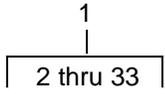

342-1353

Figure 233. Heater/AC Assembly

SECTION II			TM9-2320-302-24P			
(1)	(2)	(3)	(4)	(5)	(6)	(7)
ITEM	SMR			PART		
NO	CODE	NSN	CAGEC	NUMBER	DESCRIPTION AND USABLE ON CODES(UOC)	QTY
GROUP 2202 ACCESSORY ITEMS						
FIG. 233 HEATER A/C ASSEMBLY						
1	XDOFF		64678	A22-49952-000	HEATER/AC ASSY.....	1
2	XDOZZ		64678	BOA 750045 05	.CORE COVER ASSY.....	1
3	PAOZZ	2930013373765	64678	80.373.00.109	.CORE,RADIATOR.....	1
4	PAFZZ	4130014433814	64678	BOA 730004 07	.EVAPORATOR COIL,REF.....	1
5	PAOZZ	6685014428552	64678	BOA 630014 00	.THERMOSTAT,FLOW CON.....	1
6	XDOZZ		64678	BOA 782094 00	.SEAL,MODULE DISCHG.....	1
7	XDOZZ		64678	BOA 750033 09	.HOUSING,CASE, TOP AS.....	1
8	XDOZZ		64678	BOA 702013 00	.NUT,TYPE-U,SHEET ME.....	6
9	PAOZZ	5905013383434	64678	80.926.00.079	.RESISTOR,FIXED,FILM.....	1
10	XDOZZ		64678	BOA 750049 03	.SCROLL ASSY.....	1
11	XDOZZ		64678	BOA 90 703 06 76	.CLIP,CASE.....	9
				8		
12	XDOZZ		64678	80 412 04 139	.COVER,MOTOR ACCESS.....	1
13	XDOZZ		64678	BOA 180156 03	.DOOR,AIR INLET.....	1
14	PFOZZ	5340013363911	64678	815 00 899	.BOOT,DUST AND MOIST.....	1
15	XDOZZ		64678	BOA 702011 00	.NUT,PUSH PAL 1/4 DIA.....	1
16	XDOZZ		64678	BOA 640019 00	.BUTTON,PLASTIC.....	1
17	PFOZZ	3040013377428	64678	80.618.00.009	.CYLINDER ASSEMBLY,A.....	1
18	XDOZZ		64678	BOA 707014 00	.NUT,PUSH CLIP.....	2
19	PFOZZ	5365014412679	64678	BOA 708003 00	.BUSHING,NONMETALLIC.....	1
20	XDOZZ		64678	BOA 680018 01	.TUBING,DRAIN.....	2
21	PFOZZ	5365014412674	64678	BOA 70 112 04 12	.BUSHING,MACHINE THR.....	1
				3		
22	XDOZZ		64678	BOA 750034 08	.HOUSING,HVAC,BOTTOM.....	1
23	XDOZZ		64678	BOA 180168 03	.BRACKET,MTG,HVAC,LH.....	1
24	PFOZZ	5325014450252	64678	BOA 782039 00	.GROMMET,NONMETALLIC.....	1
25	MOOZZ		64678	48-25122-062X63	.HOSE,NONMETALLIC 5/8 IDX 63 IN. MAKE FROM BULK PN: 48-25122-062 (64678).....	1
26	MOOZZ		64678	48-25122-075X37	.HOSE,NONMETALLIC 3/4 ID X 37 IN. MAKE FROM BULK PN: 48-25122-075 (64678).....	1
27	XDOZZ		64678	BOA 707004 00	.CLAMP,HOSE.....	3
28	PAOZZ	2540014424550	75418	173119	.VALVE,HEATER CONTRO.....	1
29	MOOZZ		64678	48-25122-075X3	.HOSE,HEATER 3/4 ID X 3 IN. MAKE FROM BULK PN: 48-25122-075 (64678)..	1
30	XDOZZ		64678	BOA 782017 02	.SEAL,TUBE HEATER.....	1
31	PFFZZ	4820014421673	64678	A22-45432-000	.VALVE,EXPANSION.....	1
32	PFOZZ	5342014432557	64678	BOA 85 031 52 00	.MOUNT,RESILIENT BLOWER MOTOR.....	1
				2		
33	XDOZZ		64678	BOA 78211501	.SEAL,DISCHG,BLOWER.....	1
34	PAOZZ	5306001218232	32195	308742	BOLT,MACHINE 1/4-20 X 0.75.....	5
35	XDOZZ		64678	23-09426-203	WASHER 1/4 1.0 OD.....	5

END OF FIGURE

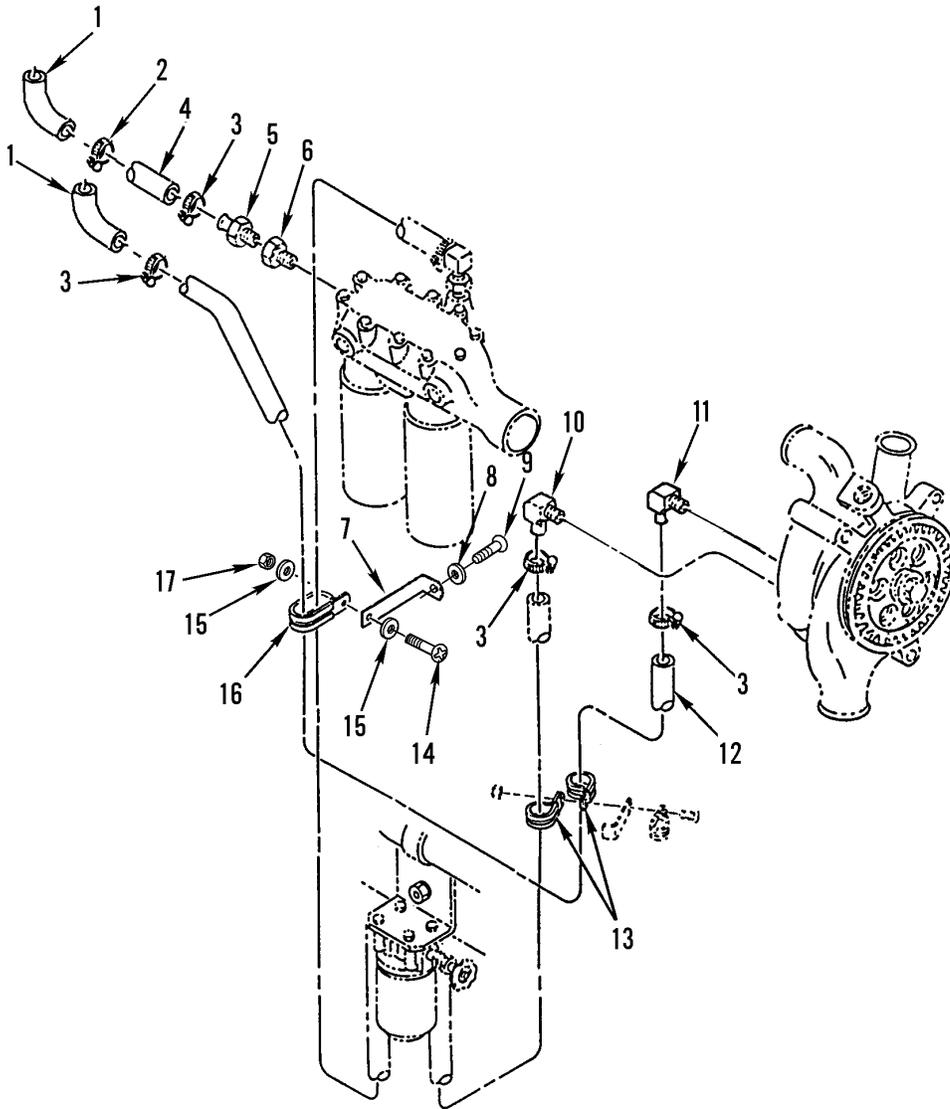

342-1354

Figure 234. Heater Hoses

SECTION II			TM9-2320-302-24P			
(1)	(2)	(3)	(4)	(5)	(6)	(7)
ITEM	SMR			PART		
NO	CODE	NSN	CAGEC	NUMBER	DESCRIPTION AND USABLE ON CODES(UOC)	QTY
GROUP 2202 ACCESSORY ITEMS						
FIG. 234 HEATER HOSES						
1	XDOZZ		62534	RD4366-0	ELBOW,HEATER,90 DEG 0.625" ID HOSE.	1
2	PAOZZ	4730011223338	7Z588	30010H	CLAMP,HOSE.....	2
3	PAOZZ	4730009083194	96906	MS35842-11	CLAMP,HOSE .69-1.25.....	4
4	MOOZZ		64678	22-28607-018	HOSE,HEATER MAKE FROM PN 350357, CAGE 24161,18 IN.....	1
5	PAOZZ	4730011059466	93061	68HB-10-8	ADAPTER,STRAIGHT,PI.....	1
6	PAOZZ	4730001930875	81348	WW-P-471BDQBUE	BUSHING,PIPE 3/4 IN NPT X 1/2 IN FPT IP.....	1
7	PAOZZ	5340013319466	64678	06-09782-000	BRACKET,ANGLE.....	2
8	PAOZZ	5310008094085	96906	MS27183-16	WASHER,FLAT 7/16 INCH.....	1
9	PAOZZ	5306012867169	64678	000933 010128	BOLT,MACHINE.....	1
10	XDOZZ		62534	RD5-4471-0	ELBOW,HEATER,90 DEG 0.75" ID HOSE..	1
11	XDOZZ		64678	23-09340-003	ELBOW-90 DEG,BRASS 3/4-14 PIPE THD TO 1" ID HOSE.....	1
12	MOOZZ		64678	22-21952-063	HOSE,HEATER MAKE FROM PN 4230-0002, CAGE 24161,63 IN.....	1
13	PAOZZ	5340013342880	18076	S630-G14	CLAMP,LOOP.....	2
14	PAOZZ	5305002253843	80204	B1821BH025C100N	SCREW,CAP,HEXAGON H.....	2
15	PAOZZ	5310008094058	96906	MS27183-10	WASHER,FLAT 1/4 INCH.....	4
16	PAOZZ	5340012530128	01276	900729-24	CLAMP,LOOP.....	2
17	PAOZZ	5310000881251	81349	M45913/1-4CG5C	NUT,SELF-LOCKING,HE 1/4-20.....	2

END OF FIGURE

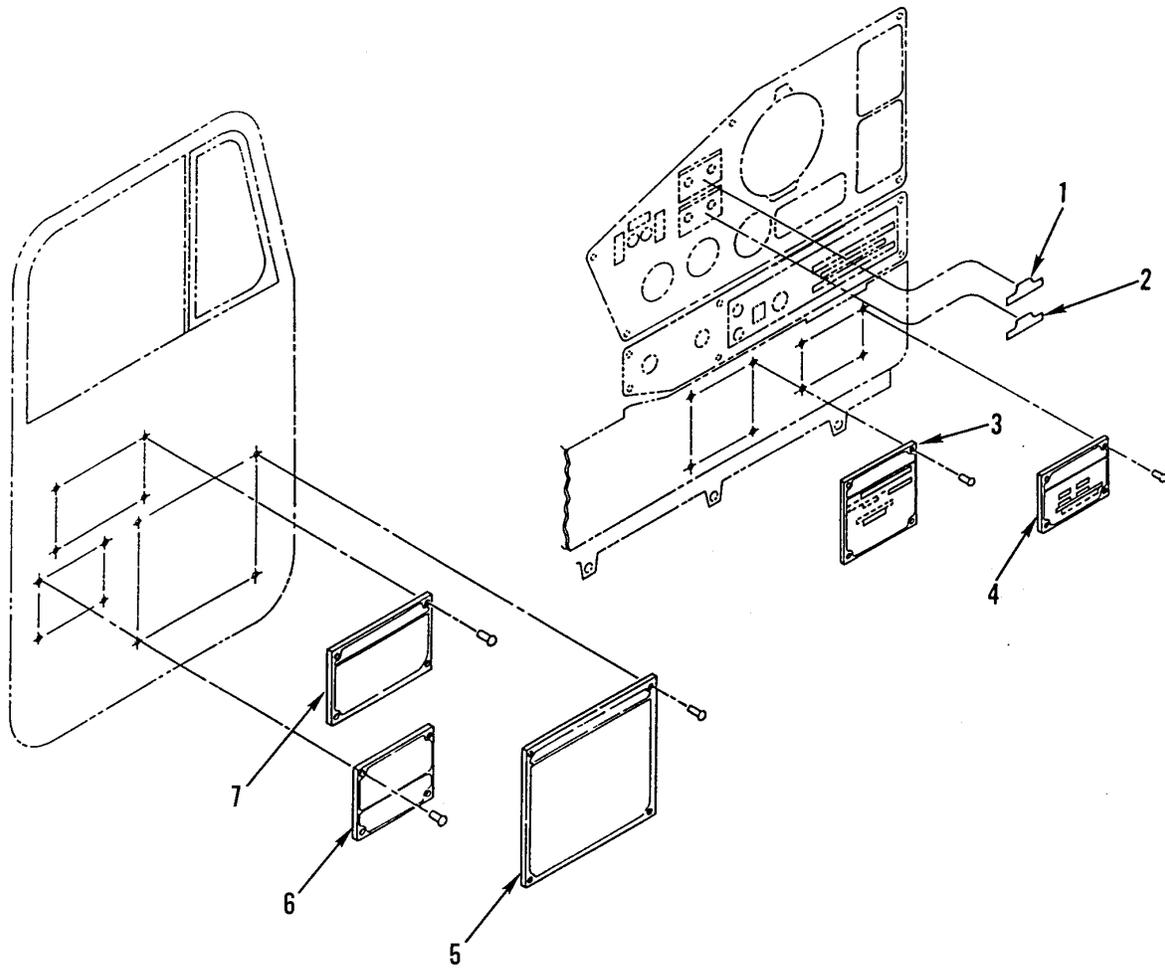

342-1546

Figure 235. Data Plates

SECTION II			TM9-2320-302-24P			
(1)	(2)	(3)	(4)	(5)	(6)	(7)
ITEM	SMR			PART		
NO	CODE	NSN	CAGEC	NUMBER	DESCRIPTION AND USABLE ON CODES(UOC)	QTY
					GROUP 2210 DATA PLATES AND INSTRUCTION HOLDERS	
					FIG. 235 DATA PLATES	
1	XDOZZ		64678	681 584 14 38	LABEL 5TH WHEEL.....	1
2	XDOZZ		64678	681 584 13 38	LABEL.....	1
3	XDOZZ		64678	24-00646-006	PLATE,REGISTRATION.....	3
4	XDOZZ		64678	24-00655-006	PLATE,WARRANTY CONTACT FTL (64678) WARRANTY DEPT. FOR REPLACEMENT.....	1
5	XDOZZ		64678	24-00658-001	PLATE,DATA,LUBE.....	1
6	XDOZZ		64678	24-01076-000	PLATE,DATA.....	1
7	XDOZZ		64678	24-00647-006	PLATE,DATA COMPONEN.....	1

END OF FIGURE

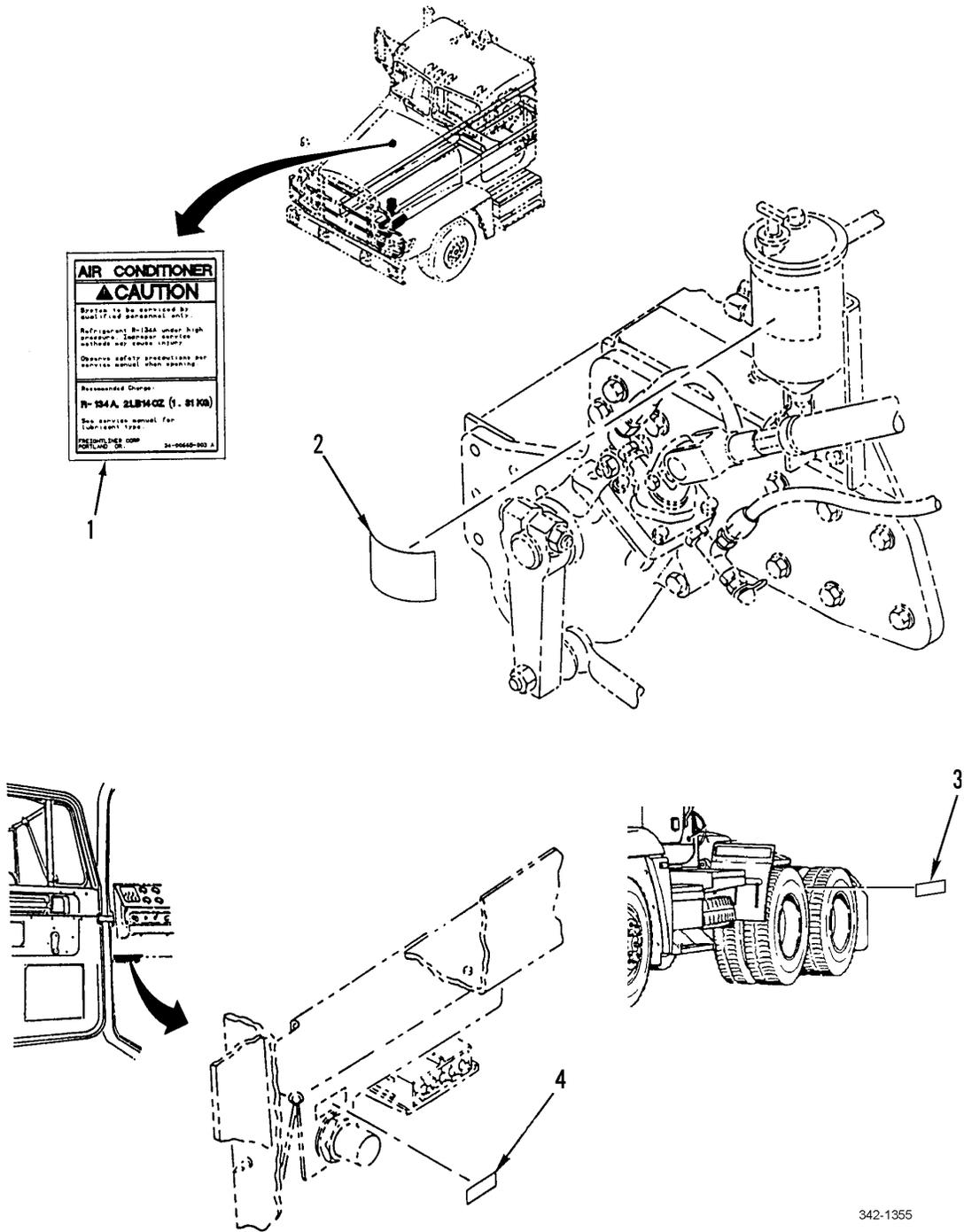

342-1355

Figure 236. Data Plates

SECTION II			TM9-2320-302-24P			
(1)	(2)	(3)	(4)	(5)	(6)	(7)
ITEM	SMR			PART		
NO	CODE	NSN	CAGEC	NUMBER	DESCRIPTION AND USABLE ON CODES(UOC)	QTY
					GROUP 2210 DATA PLATES AND INSTRUCTION HOLDERS	
					FIG. 236 DATA PLATES	
1	XDOZZ		64678	24-00665-003	LABEL.....	1
2	XDOZZ		64678	24-00666-000	DECAL POWER STEERING RESERVOIR.....	1
3	XDOZZ		64678	24-00667-000	LABEL,TORQUE VALUE TORQUE PATTERN	2
					WHEEL NUTS.....	
4	XDOZZ		64678	E24-00049-045	LABEL,ENGINE CHECK.....	1

END OF FIGURE

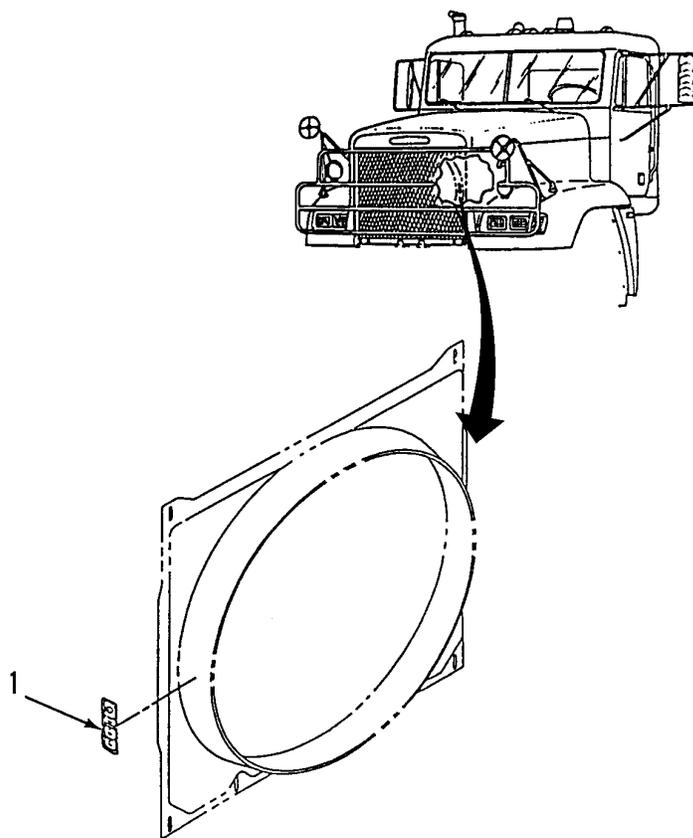

342-1356

Figure 237. Fan Decals

SECTION II			TM9-2320-302-24P			
(1)	(2)	(3)	(4)	(5)	(6)	(7)
ITEM	SMR			PART		
NO	CODE	NSN	CAGEC	NUMBER	DESCRIPTION AND USABLE ON CODES(UOC)	QTY
					GROUP 2210 DATA PLATES AND INSTRUCTION HOLDERS	
					FIG. 237 FAN DECALS	
1	XDOZZ		64678	24-00662-000	DECAL,FAN.....	2

END OF FIGURE

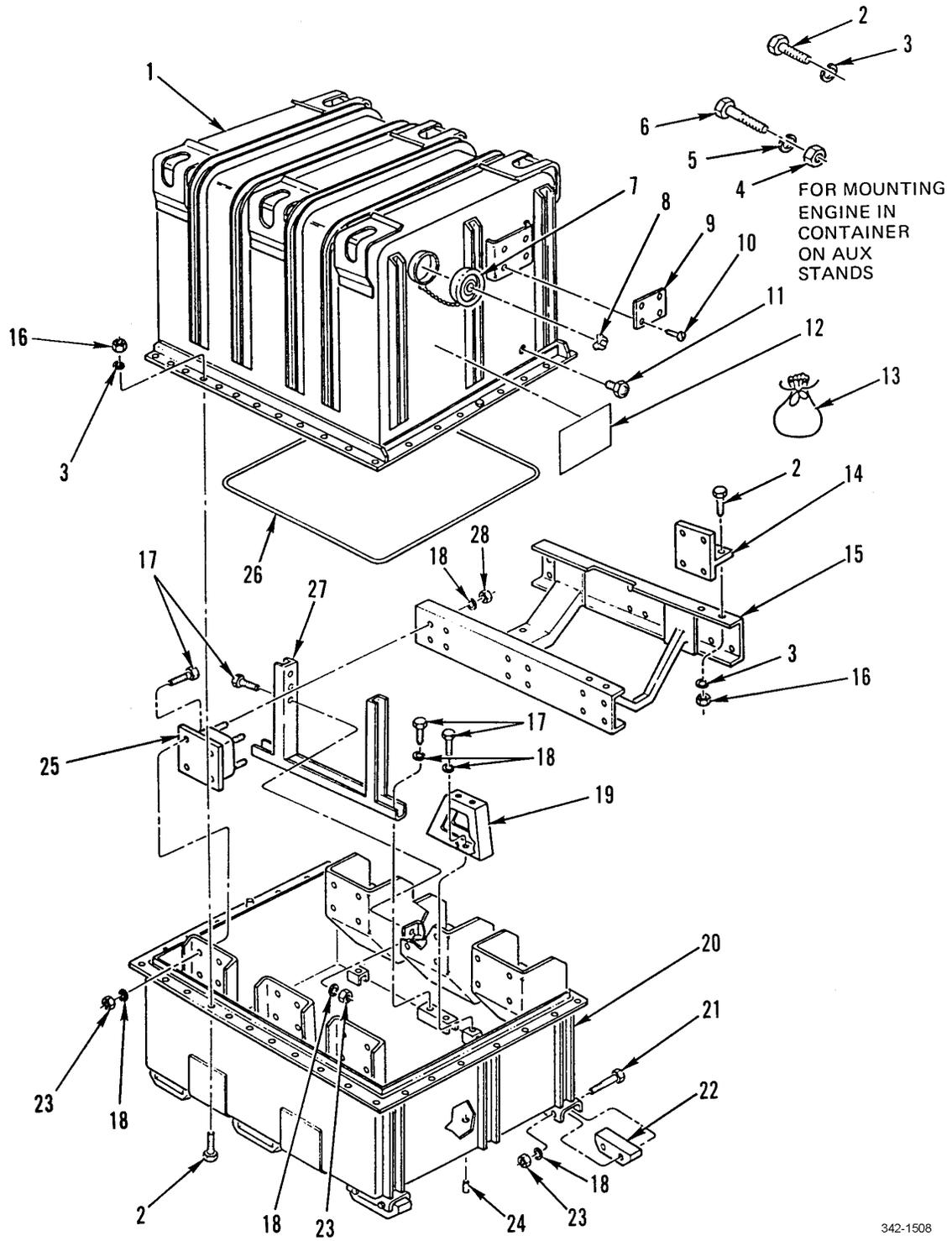
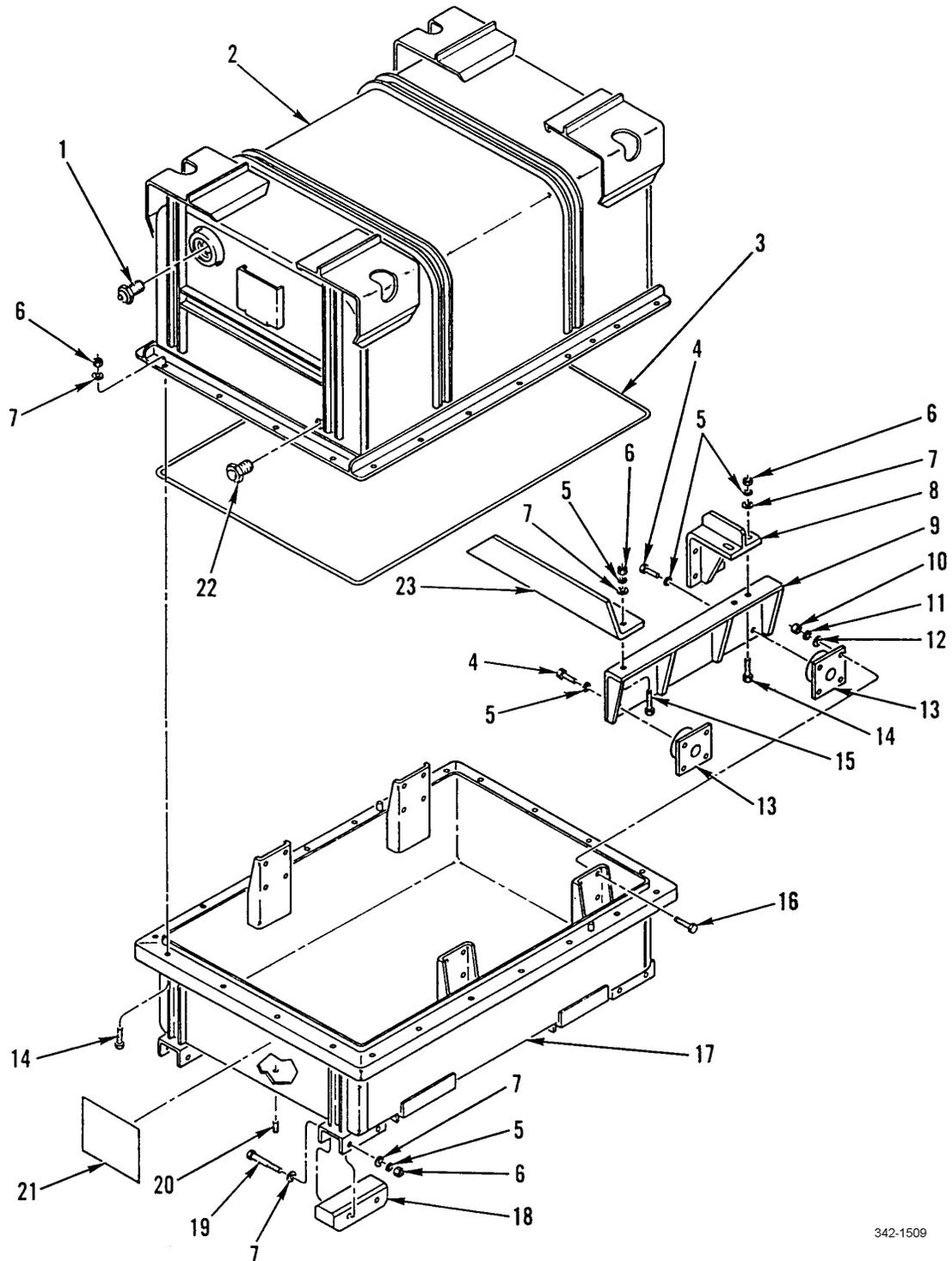

Figure 238. Engine Container

SECTION II			TM9-2320-302-24P			
(1)	(2)	(3)	(4)	(5)	(6)	(7)
ITEM	SMR			PART		
NO	CODE	NSN	CAGEC	NUMBER	DESCRIPTION AND USABLE ON CODES(UOC)	QTY
GROUP 33 SPECIAL PURPOSE KITS						
GROUP 3301 REUSABLE SHIPPING						
CONTAINERS						
FIG. 238 ENGINE CONTAINER						
1	PAFZZ	8145013641131	19207	12389943	SHIPPING AND STORAG.....	1
2	PAFZZ	5305007247222	80204	B1821BH063C200N	SCREW,CAP,HEXAGON H.....	51
3	PAFZZ	5310008206653	15434	S627	WASHER,LOCK.....	54
4	PAFZZ	5310007638921	96906	MS51967-23	NUT,PLAIN,HEXAGON.....	4
5	PAFZZ	5310005847888	96906	MS35338-51	WASHER,LOCK.....	4
6	PAFZZ	5305009399204	96906	MS90725-187	SCREW,CAP,HEXAGON H.....	4
7	PAFZZ	5340010227474	10001	2856628	COVER,ACCESS.....	1
8	PAFZZ	4820010052994	01347	330-10-10-R	VALVE,PRESSURE EQUA.....	1
9	PAFZZ	9905009012942	19207	7973326	PLATE,IDENTIFICATIO.....	1
10	PAFZZ	5305002535627	96906	MS21318-48	SCREW,DRIVE.....	4
11	PAFZZ	6685006181822	19207	10906697	INDICATOR,HUMIDITY,.....	1
12	PAFZZ	7690013659128	19207	12389969	MARKER,IDENTIFICATI.....	1
13	PAFZZ	8105004773716	19207	10890481	BAG,MAIL.....	2
14	XDFZZ		19207	12389945	BRACKET,ANGLE.....	2
15	PAFZZ	2510013648287	19207	12389950	FRAME SECTION,STRUC.....	1
16	PAFZZ	5310007638920	96906	MS51967-20	NUT,PLAIN,HEXAGON.....	42
17	PAFZZ	5305000712067	80204	B1821BH050C125N	SCREW,CAP,HEXAGON H.....	29
18	PAFZZ	5310005845272	14351	X296	WASHER,LOCK.....	65
19	PAFZZ	3990013678803	19207	12389948	SKID,SHIPPING AND S.....	1
20	PAFZZ	8145013641126	19207	12389944	SHIPPING AND STORAG.....	1
21	PAFZZ	5305000712083	80204	B1821BH050C500N	SCREW,CAP,HEXAGON H.....	12
22	PAFZZ	3990013674625	19207	12389946	SKID,PLATFORM.....	6
23	PAFZZ	5310007680318	96906	MS51967-14	NUT,PLAIN,HEXAGON.....	37
24	PAFZZ	4730002212140	96906	MS20913-6S	PLUG,PIPE.....	1
25	PAFZZ	5342013716339	19207	12389955	MOUNT,RESILIENT.....	6
26	PAFZZ	5330013725690	19207	12389951	GASKET.....	1
27	PAFZZ	3990013687040	19207	12389949	SKID,SHIPPING AND S.....	1
28	PAFZZ	5310007320560	96906	MS51968-14	NUT,PLAIN,HEXAGON.....	24

END OF FIGURE



342-1509

Figure 239. Transmission Container

SECTION II			TM9-2320-302-24P			
(1)	(2)	(3)	(4)	(5)	(6)	(7)
ITEM	SMR			PART		
NO	CODE	NSN	CAGEC	NUMBER	DESCRIPTION AND USABLE ON CODES(UOC)	QTY
GROUP 3301 REUSABLE SHIPPING CONTAINERS						
FIG. 239 TRANSMISSION CONTAINER						
1	PAFZZ	4820010052994	01347	330-10-10-R	VALVE,PRESSURE EQUA.....	1
2	PAFZZ	8145012452099	33873	51178-1-003	CONTAINER,UPPER SEC.....	1
3	PAFZZ	5330012487817	33873	51178-1-100	SEAL,NONMETALLIC RO.....	1
4	PAFZZ	5305009900695	80205	B1821BH050F088N	SCREW,CAP,HEXAGON H.....	4
5	PPFZZ	5310005845272	96906	MS35338-48	WASHER,LOCK.....	18
6	PAFZZ	5310007680318	96906	MS51967-14	NUT,PLAIN,HEXAGON.....	36
7	PAFZZ	5310008095998	96906	MS27183-18	WASHER,FLAT.....	44
8	PPFZZ	8140012455694	33873	51178-1-008	SUPPORT,SHIPPING AN.....	1
9	PPFZZ	8140012454323	33873	51178-1-006	SUPPORT,SHIPPING AN.....	1
9	XDFZZ		33873	51178-005	SUPPORT,SHIPPING.....	1
10	PAFZZ	5310008807744	96906	MS51967-5	NUT,PLAIN,HEXAGON.....	16
11	PAFZZ	5310004079566	96906	MS35338-45	WASHER,LOCK.....	16
12	PAFZZ	5310000814219	96906	MS27183-12	WASHER,FLAT.....	16
13	PAFZZ	8140012454321	33873	51178-1-105	SUPPORT,SHIPPING AN.....	4
14	PAFZZ	5305000712069	80204	B1821BH050C150N	SCREW,CAP,HEXAGON H.....	26
15	PAFZZ	5305000712070	24446	N22P29028C11	SCREW,CAP,HEXAGON H.....	2
16	PAFZZ	5306002258499	96906	MS90725-34	BOLT,MACHINE.....	16
17	PPFZZ	8145012452092	33873	51178-1-002	CONTAINER,LOWER SEC.....	1
18	PPFZZ	3990012473625	33873	51178-1-101	SKID,PLATFORM.....	4
19	PAFZZ	5305000712083	80204	B1821BH050C500N	SCREW,CAP,HEXAGON H.....	8
20	PAFZZ	4730002212140	96906	MS20913-6S	PLUG,PIPE.....	1
21	PAFZZ	7690012454316	33873	51178-1-104	MARKER,IDENTIFICATI.....	1
22	PAFZZ	6685006181822	19207	10906697	INDICATOR,HUMIDITY,.....	1
23	PPFZZ	8140012454325	33873	M-1492-5	SUPPORT,SHIPPING AN.....	1

END OF FIGURE

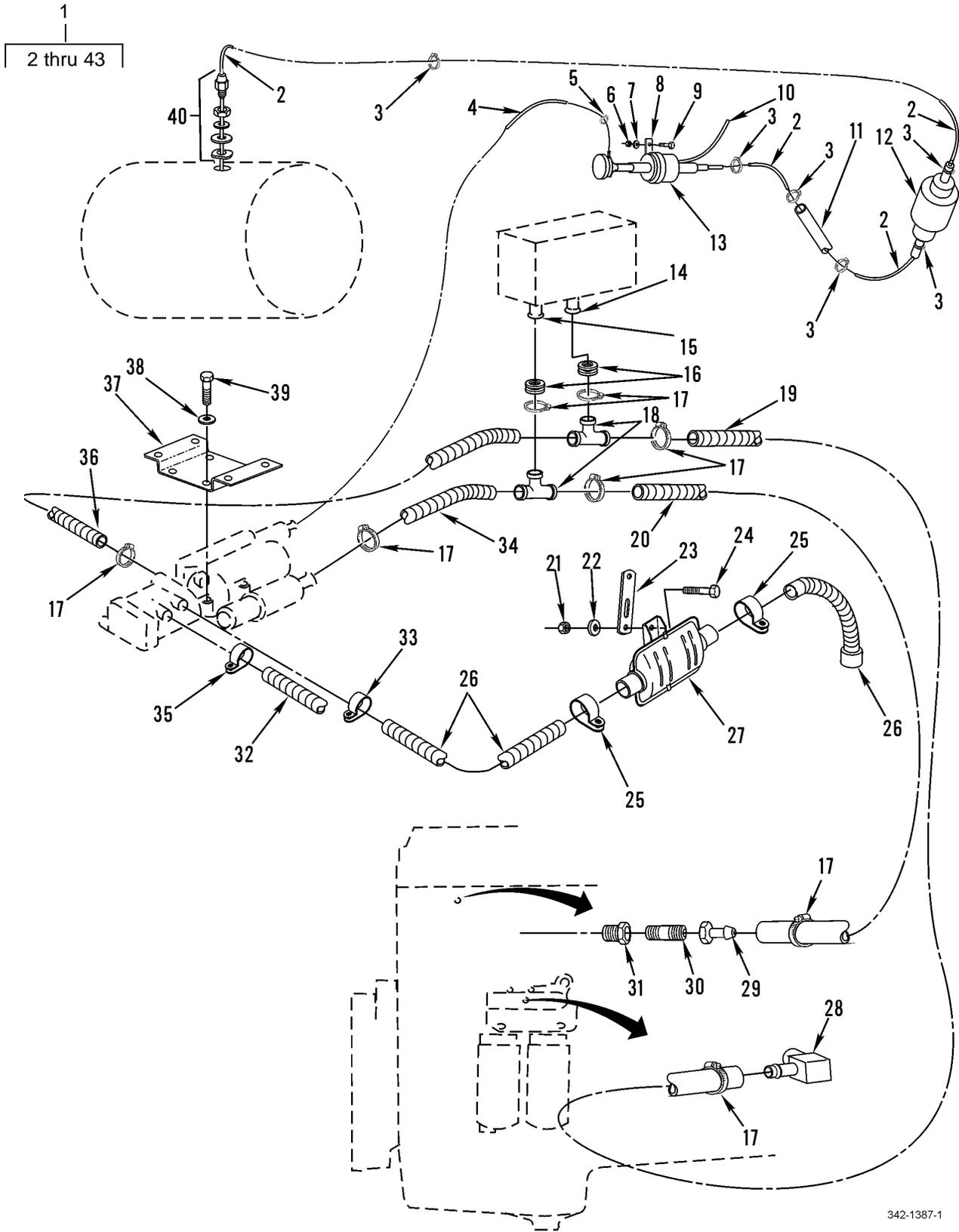

342-1387-1

Figure 240. Personnel Arctic Heater Lines, Fittings and Hardware (Sheet 1 of 2)

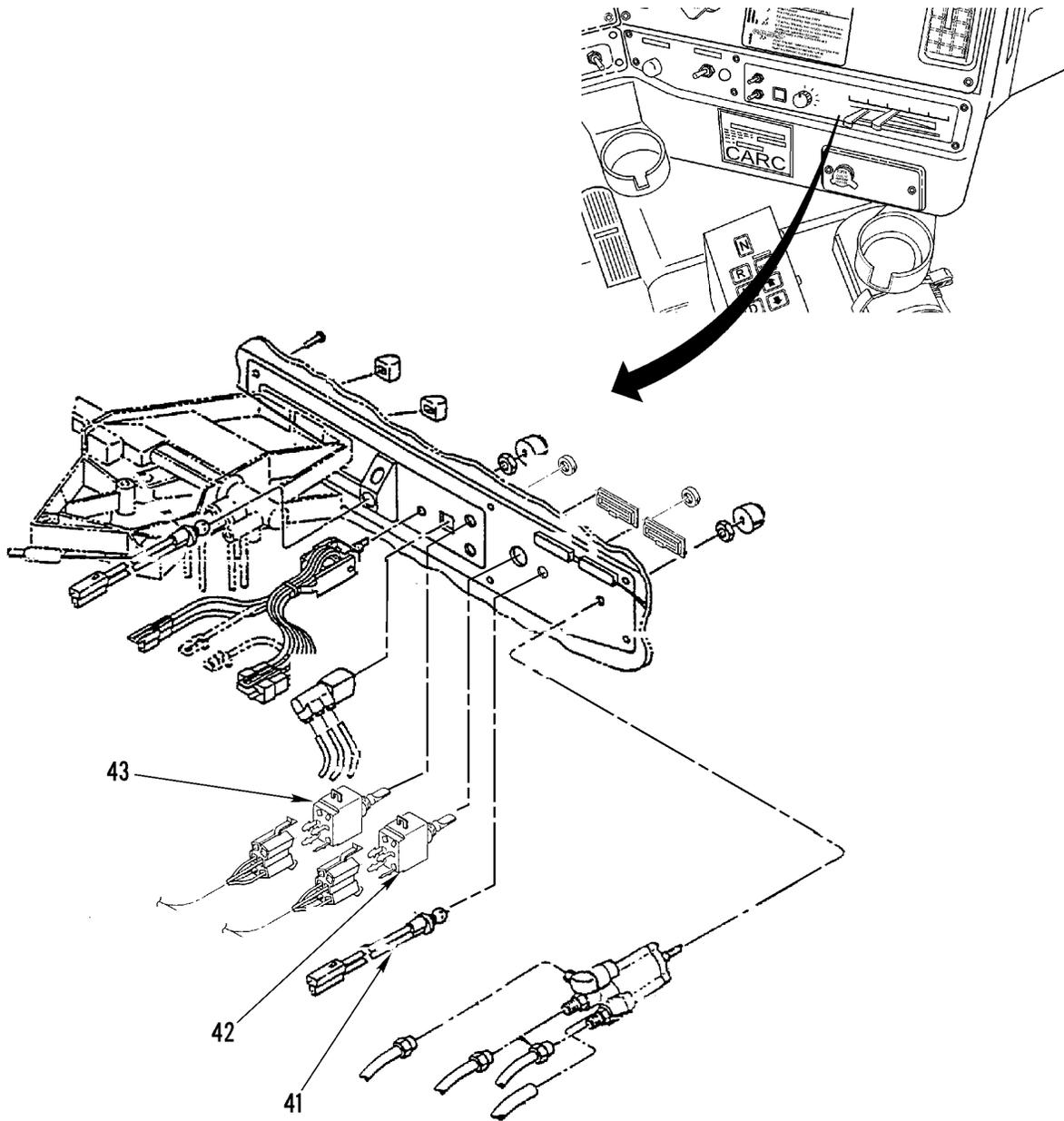

342-1387-2

Figure 240. Personnel Arctic Heater Lines, Fittings and Hardware (Sheet 2 of 2)

SECTION II			TM9-2320-302-24P				
(1)	(2)	(3)	(4)	(5)	(6)	(7)	
ITEM NO	SMR CODE	NSN	CAGEC	PART NUMBER	DESCRIPTION AND USABLE ON CODES(UOC)	QTY	
GROUP 3303 WINTERIZATION KITS							
FIG. 240 PERSONNEL ARCTIC HEATER LINES, FITTINGS, AND HARDWARE							
1	PAOFF	2540014792467	64678	681 830 10 K2	HEATER,VEHICULAR,CO KIT,ARCTIC PERSONNEL HEATER.....	1	
2	XDOZZ		62380	484032	.HOSE,NONMETALLIC 4.5MM X 10MM X 47.5MM.....	4	
3	PAOZZ	4730013948139	62380	330.027	.CLAMP,HOSE.....	8	
4	MOOZZ		62380	483931X50	.HOSE,NONMETALLIC 50" MAKE FROM BULK PN 7-543-001790 (12361).....	1	
5	PAOZZ	5340014753164	62380	367400	.CLAMP,LOOP.....	3	
6	XDOZZ		64678	23-09901-104	.NUT,SELF-LOCKING 1/4-20 UNC.....	1	
7	PAOZZ	5310008094058	96906	MS27183-10	.WASHER,FLAT 1/4 IN.....	2	
8	PAOZZ	5340013284371	64678	23-09130-002	.BRACKET,ANGLE .531 X .28.....	1	
9	PAOZZ	5305002253843	80204	B1821BH025C100N	.SCREW,CAP,HEXAGON H 1/4-20 X 1....	1	
10	XDOZZ		62380	905794	.HARNES,FUEL PUMP.....	1	
11	MOOZZ		62380	483931X42	.HOSE,NONMETALLIC 42" MAKE FROM BULK PN 7-543-001790 (12361).....	1	
12	XDOZZ		62380	487171	.FILTER,FUEL.....	1	
13	XDOZZ		62380	47901A	.PUMP,FUEL.....	1	
14	MOOZZ		62380	901100X23	.HOSE,NONMETALLIC 23" MAKE FROM BULK PN 4230NX-3/4 (24161).....	2	
15	MOOZZ		62380	901100X19	.HOSE,NONMETALLIC 19" MAKE FROM BULK PN 4230NX-3/4 (24161).....	1	
16	XDOZZ		62380	901118	.GROMMET 1-1/2" HOLE.....	2	
17	PAOZZ	4730009083194	96906	MS35842-11	.CLAMP,HOSE 1.25 IN.....	10	
18	XDOZZ		62380	901129	.CONNECTOR,TEE.....	2	
19	MOOZZ		62380	901100X90	.HOSE,NONMETALLIC 90" MAKE FROM BULK PN 4230NX-3/4 (24161).....	1	
20	MOOZZ		62380	901100X86	.HOSE,NONMETALLIC 86" MAKE FROM BULK PN 4230NX-3/4 (24161).....	1	
21	XDOZZ		64678	23-09901-105	.NUT,SELF-LOCKING 5/16-18 UNC.....	1	
22	XDOZZ		62380	902712	.WASHER,LOCK 5/16 IN., GALVANIZED FOR MUFFER MOUNTING.....	4	
23	PAOZZ	5340013284367	64678	23-09130-000	.BRACKET,ANGLE.....	1	
24	XDOZZ		62380	901199	.BOLT,HEXAGON HEAD 5/16-18 X 1, GALVANIZED.....	4	
25	XDOZZ		62380	126830	.CLAMP 42MM.....	1	
26	XDOZZ		62380	15527A	.PIPE,EXHAUST 38 X 1MM, CUT TO FIT.	1	
27	PFOZZ	2990014753969	62380	19562C	.MUFFLER,EXHAUST.....	1	
28	PFOZZ	4730013359621	81343	12-8 430260B	.ELBOW,PIPE TO HOSE 3/4 IN. BRASS..	1	
29	PAOZZ	4730012306584	97403	13217E7108-15	.ADAPTER,STRAIGHT,PI 1/2" PIPE TO 3/4" ID HOSE.....	1	
30	PFOZZ	4730001388121	96906	MS51953-132	.NIPPLE,PIPE 1/2 IN. NPT, X 6 IN...	1	
31	PAOZZ	4730002783167	93061	209P-12-8	.BUSHING,PIPE 3/4" NPT X 1/2" NPT..	2	
32	PFOZZ	4720014752616	62380	29842A	.HOSE,METALLIC.....	1	
33	PAOZZ	5340012855558	62380	100.424	.CLAMP,LOOP.....	1	
34	MOOZZ		62380	901100X20	.HOSE,NONMETALLIC 20" MAKE FROM BULK PN 4230NX-3/4 (24161).....	1	
35	PAOZZ	5340012871979	62380	499.021	.CLAMP,LOOP.....	1	

SECTION II			TM9-2320-302-24P			
(1)	(2)	(3)	(4)	(5)	(6)	(7)
ITEM	SMR			PART		
NO	CODE	NSN	CAGEC	NUMBER	DESCRIPTION AND USABLE ON CODES(UOC)	QTY
36	MOOZZ		62380	901100X29	.HOSE, NONMETALLIC 29" MAKE FROM BULK PN 4230NX-3/4 (24161).....	1
37	XDOZZ		62380	901016A	.BRACKET.....	1
38	XDOZZ		62380	601025	.WASHER 8MM.....	3
39	XDOZZ		62380	902888	.SCREW, HEXAGON M8 X 16.....	3
40	XDOZZ		62380	905483A	.STANDPIPE ASSY INSTL'D IN RIGHT HAND FUEL TANK, CANNOT PURCHASE PIECE PARTS.....	1
41	XDOZZ		62380	906304A	.LIGHT, INDICATOR.....	1
42	XDOZZ		62380	901108	.SWITCH, TOGGLE 24V ON/OFF.....	1
43	XDOZZ		62380	901114	.SWITCH, TOGGLE 24V HI/LOW.....	1

END OF FIGURE

1	12	19
2 thru 23	13 and 14	20 and 21

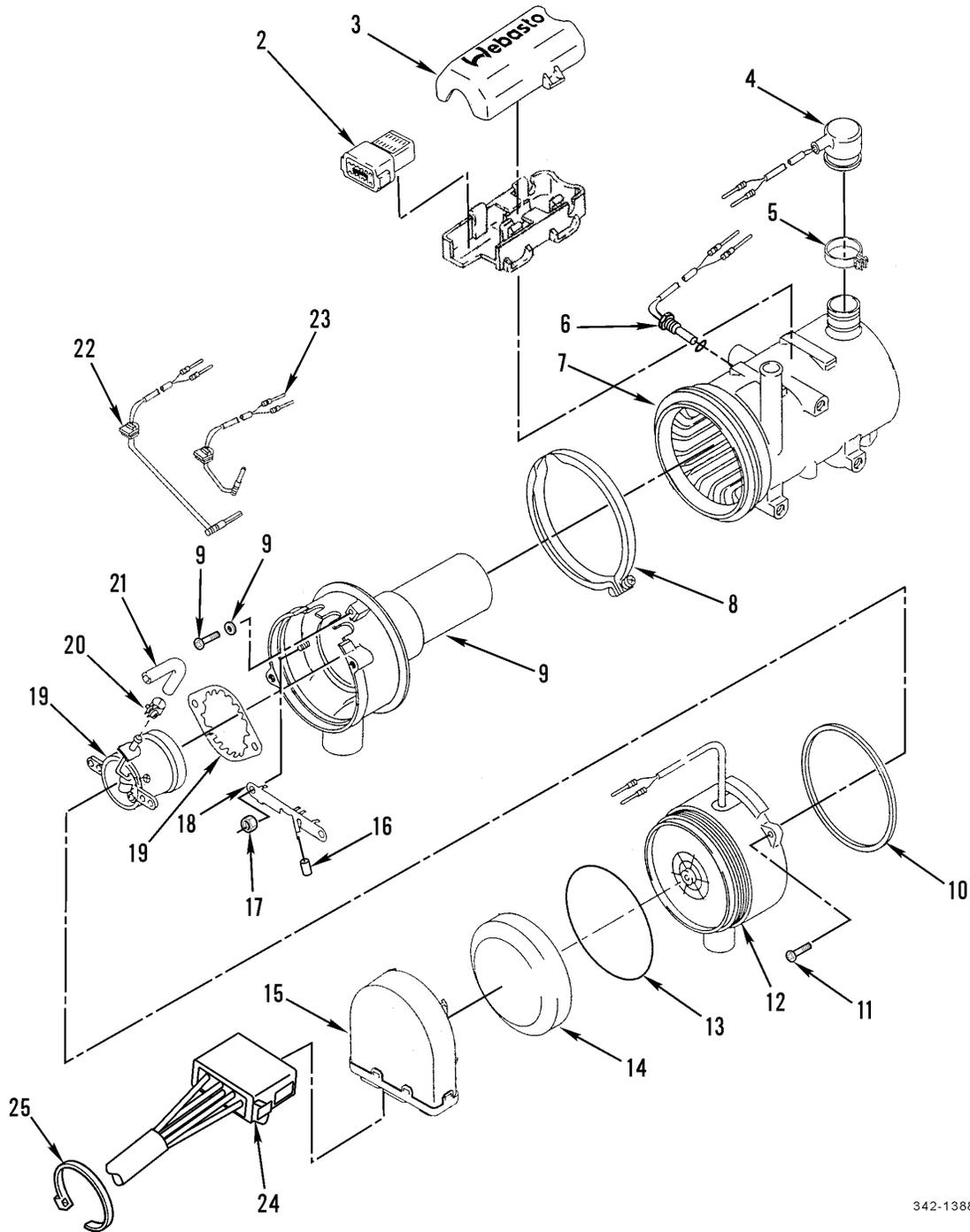

342-1388

Figure 241. Arctic Heater Assembly

SECTION II			TM9-2320-302-24P			
(1)	(2)	(3)	(4)	(5)	(6)	(7)
ITEM	SMR			PART		
NO	CODE	NSN	CAGEC	NUMBER	DESCRIPTION AND USABLE ON CODES(UOC)	QTY
GROUP 3303 WINTERIZATION KITS						
FIG. 241 ARCTIC HEATER ASSEMBLY						
1	XDOFF		62380	92209A	HEATER, VEHICULAR, CO.....	1
2	XDFZZ		62380	85042A	.CONNECTOR.....	1
3	XDFZZ		62380	386-41C	.TOP COVER.....	1
4	XDFZZ		62380	379-55C	.LIMITER, TEMPERATURE.....	1
5	XDFZZ		62380	820 96A	.CLAMP, HOSE.....	1
6	XDFZZ		62380	412-44D	.SENSOR, TEMPERATURE.....	1
7	XDFZZ		62380	862-44A	.HEAT EXCHANGER.....	1
8	PFFZZ	5340014753622	62380	21295A	.CLAMP, LOOP.....	1
9	XDFZZ		62380	824-15A	.CHAMBER, COMBUSTION.....	1
10	XDFZZ		62380	835 15B	.GASKET RING.....	1
11	XDFZZ		62380	342 95A	.SCREW, SELF TAPPING M5 X 20.....	2
12	XDFZZ		62380	824-06A	.FAN, COMBUSTION.....	1
13	XDFZZ		62380	348 88A	..GASKET RING.....	1
14	XDFZZ		62380	38652C	..END COVER.....	1
15	XDFZZ		62380	902-50A	.CONTROL UNIT.....	1
16	XDFZZ		62380	199 37B	.HOSE, INSULATING.....	1
17	XDFZZ		62380	371 009	.NUT, HEXAGON.....	2
18	XDFZZ		62380	208 17B	.SUPPORT.....	1
19	XDFZZ		62380	824-13A	.BURNER UNIT.....	1
20	PAFZZ	4730013948139	62380	330.027	..CLAMP, HOSE.....	1
21	XDFZZ		62380	348 59A	..HOSE, FUEL.....	1
22	XDFZZ		62380	824-07A	.DETECTOR, FLAME.....	1
23	XDFZZ		62380	824-10A	.GLOW STICK.....	1
24	PFOOO	5999014750215	62380	90223A	HARNES, ELECTRICAL.....	1
25	PAOZZ	5975005709598	96906	MS3367-7-9	STRAP, TIEDOWN, ELECT 11.5 IN. FOR SECURING HARNESSSES TO FRAME RAIL....	10

END OF FIGURE

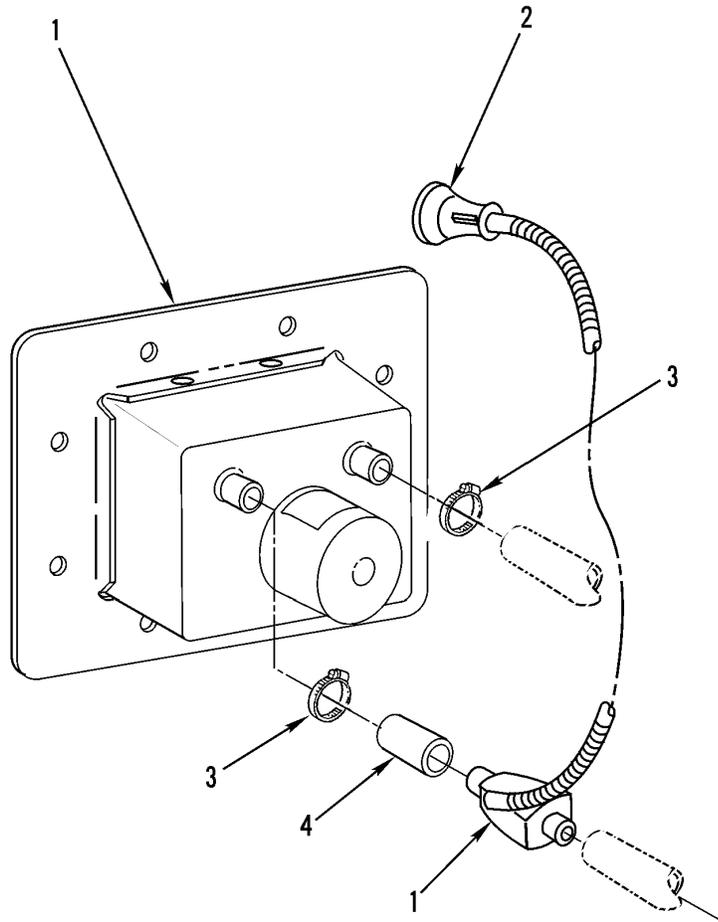

342-1389

Figure 242. Personnel Auxiliary Heater and Components

SECTION II			TM9-2320-302-24P			
(1)	(2)	(3)	(4)	(5)	(6)	(7)
ITEM	SMR			PART		
NO	CODE	NSN	CAGEC	NUMBER	DESCRIPTION AND USABLE ON CODES(UOC)	QTY
GROUP 3303 WINTERIZATION KITS						
FIG. 242 PERSONNEL AUXILIARY HEATER LINES AND CABLES						
1	XDOOO		62380	906029	HEAT EXCHANGER KIT.....	1
2	XDOZZ		62380	901106	CABLE,CONTROL 38 IN.....	1
3	PAOZZ	4730009083194	96906	MS35842-11	CLAMP,HOSE.....	2
4	MOOZZ		62380	901100X4	HOSE,NONMETALLIC 4" MAKE FROM BULK PN 4230NX-3/4 (24161).....	1

END OF FIGURE

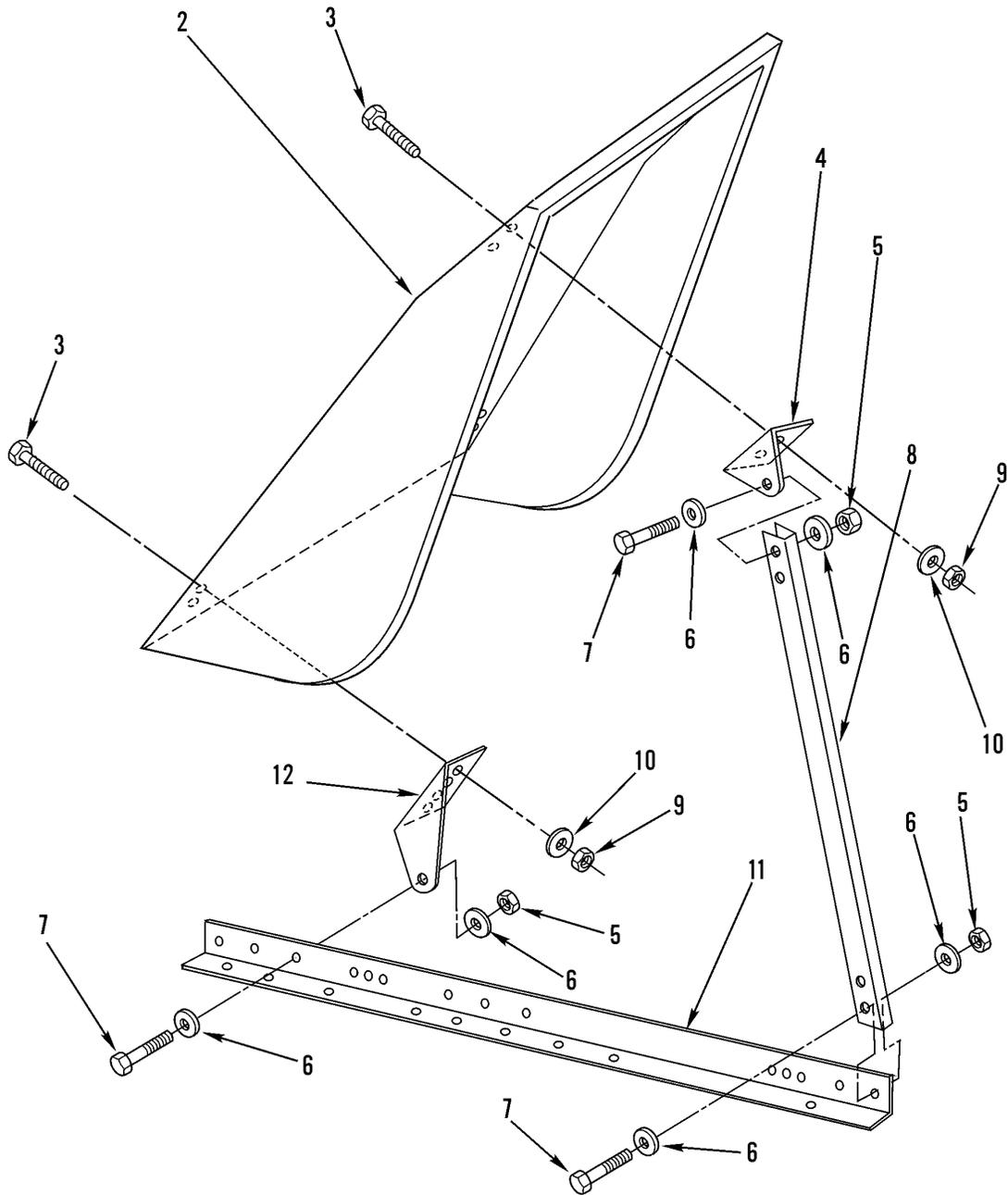
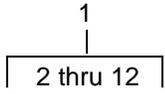

342-1543

Figure 243. Air Deflector Kit

SECTION II			TM9-2320-302-24P			
(1)	(2)	(3)	(4)	(5)	(6)	(7)
ITEM NO	SMR CODE	NSN	CAGEC	PART NUMBER	DESCRIPTION AND USABLE ON CODES(UOC)	QTY
GROUP 3307 SPECIAL PURPOSE KITS						
FIG. 243 AIR DEFLECTOR KIT						
1	PAOOO	2530014794198	64678	681 790 02 K0	PARTS KIT,AIR FLOW.....	1
2	PAOZZ	2590014791562	64678	RUD/AA727	.DEFLECTOR ASSEMBLY,.....	1
3	PAOZZ	5305014790269	64678	RUD/KP300	.SCREW,ASSEMBLED WAS 3/8-16 X 1.75	8
					TORX HEAD.....	
4	XDOZZ		64678	RUD/AP306	.BRACKET,ANGLE.....	2
5	PAOZZ	5310014789035	64678	RUD/AP691	.NUT,SELF-LOCKING,HE 3/8-16.....	2
6	XDOZZ		64678	RUD/AP690	.WASHER,FLAT 3/8.....	12
7	PAOZZ	5306014790281	64678	RUD/AP694	.BOLT,MACHINE 3/8-16 X 1.0.....	6
8	XDOZZ		64678	RUD/AP376	.BRACKET,ANGLE.....	2
9	PAOZZ	5310014788939	64678	RUD/AP695	.NUT,PLAIN,HEXAGON 3/8-16.....	8
10	PAOZZ	5310014788683	64678	RUD/AP696	.WASHER,LOCK 3/8.....	8
11	XDOZZ		64678	22-24618-001	.BRACKET,ANGLE.....	22
12	XDOZZ		64678	RUD/AP003-3	.BRACKET,ANGLE L.H.....	1
12	XDOZZ		64678	RUD/AP004-3	.BRACKET,ANGLE R.H.....	1

END OF FIGURE

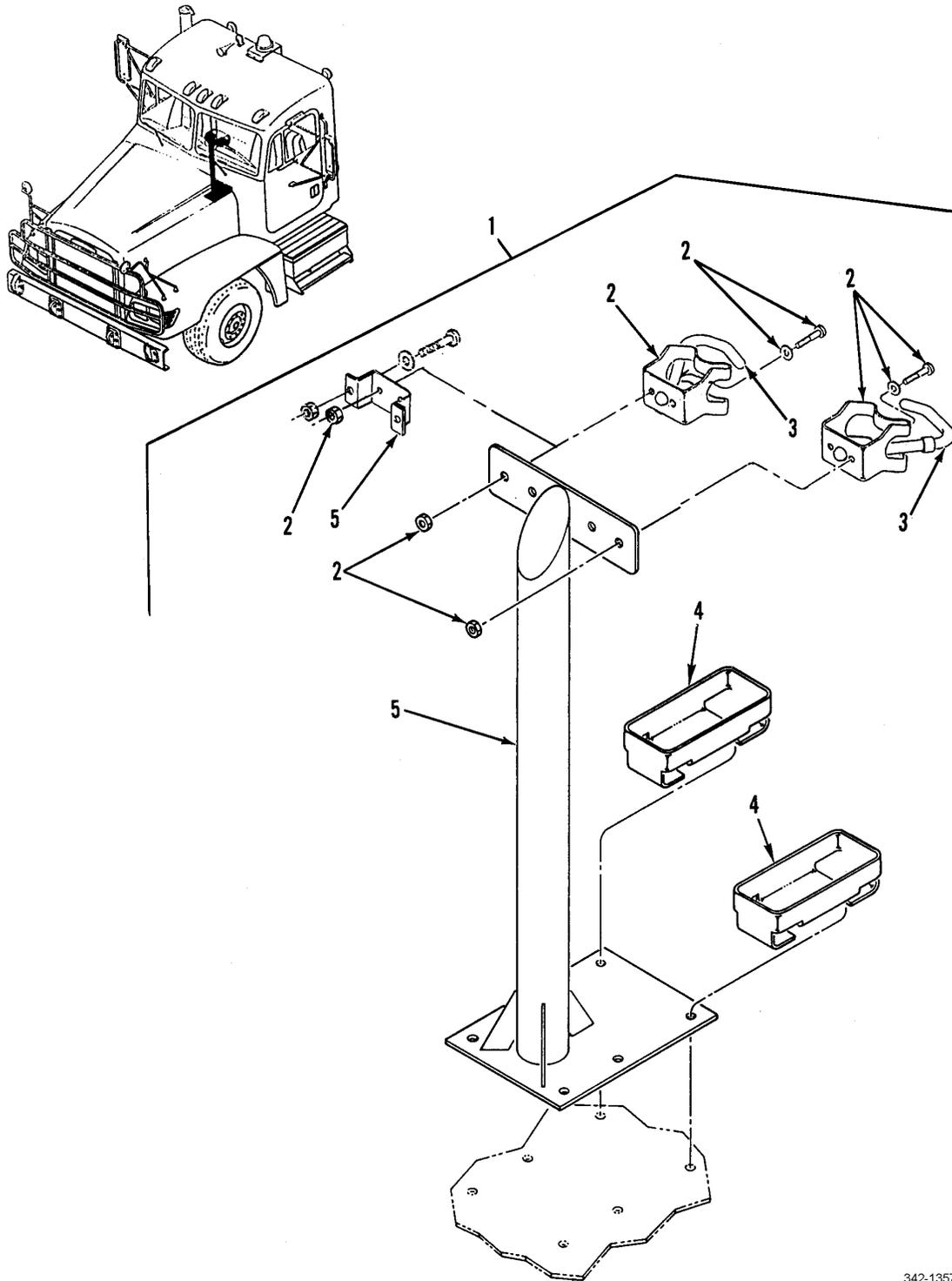

342-1357

Figure 244. Rifle Mounting Kit

SECTION II			TM9-2320-302-24P			
(1)	(2)	(3)	(4)	(5)	(6)	(7)
ITEM	SMR			PART		
NO	CODE	NSN	CAGEC	NUMBER	DESCRIPTION AND USABLE ON CODES(UOC)	QTY
					GROUP 34 ARMAMENT AND SIGHTING AND FIRE CONTROL (ELECTRIC/ELECTRONIC) MATERIEL GROUP 3401 PRIMARY ARMAMENT	
					FIG. 244 RIFLE MOUNTING KIT	
1	PAOOO	1005014399229	64678	681 816 00 K2	MOUNT,RIFLE.....	2
2	PFOZZ	5342004555899	11862	14074437	.BRACKET,MOUNTING,CA.....	2
3	PFOZZ	1095007637348	19207	11630529	.RACK,STORAGE,SMALL.....	2
4	PFOZZ	2590002648828	19207	11630594	.SUPPORT,RIFLE MOUNT.....	2
5	PAOZZ	5340013454692	64678	A22-35350-000	.BRACKET,MOUNTING.....	1

END OF FIGURE

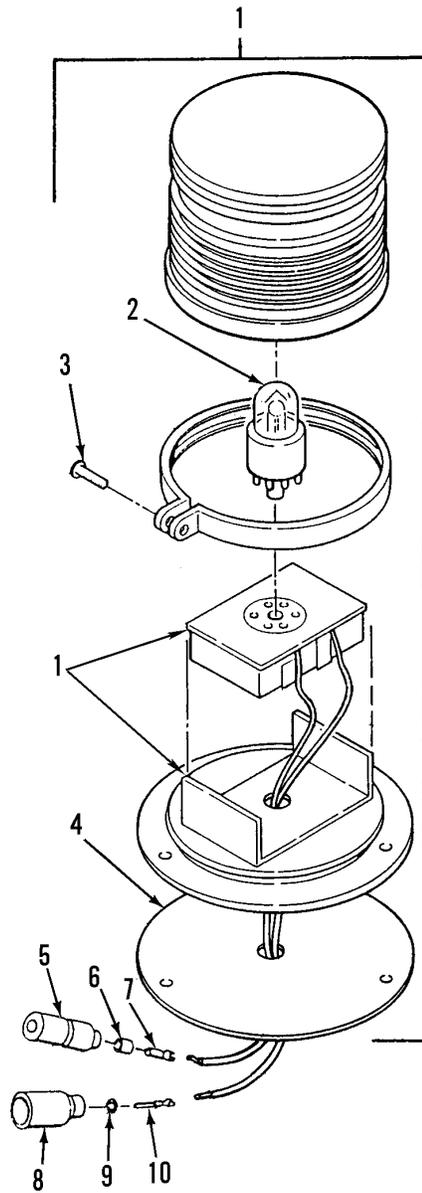

342-1358

Figure 245. Beacon Warning Light Kit

SECTION II			TM9-2320-302-24P			
(1)	(2)	(3)	(4)	(5)	(6)	(7)
ITEM	SMR			PART		
NO	CODE	NSN	CAGEC	NUMBER	DESCRIPTION AND USABLE ON CODES(UOC)	QTY
					GROUP 42 ELECTRICAL EQUIPMENT	
					GROUP 4209 SIGNALING DEVICES	
					FIG. 245 BEACON WARNING LIGHT KIT	
1	PAOOO	6220012184968	10402	01-0681853LASC	LIGHT,WARNING.....	1
2	PAOZZ	6240010852319	10402	36-0240409-00	.LAMP,FLASHTUBE.....	1
3	PAOZZ	5305000509231	10402	14-104216-120	.SCREW,MACHINE.....	1
4	PAOZZ	5330012213166	10402	38-0240201-00	.GASKET.....	1
5	PAOZZ	5975012304370	5A910	8338566	.CABLE NIPPLE,ELECTR.....	1
7	PAOZZ	5999000572929	19204	572929	.CONTACT,ELECTRICAL.....	1
8	PAOZZ	5935008338561	19207	8338561	.SHELL,ELECTRICAL CO.....	1
9	PAOZZ	5310008338567	19207	8338567	.WASHER,SLOTTED.....	1
10	PAOZZ	5940003996676	19207	8338564	.TERMINAL SET,QUICK.....	1

END OF FIGURE

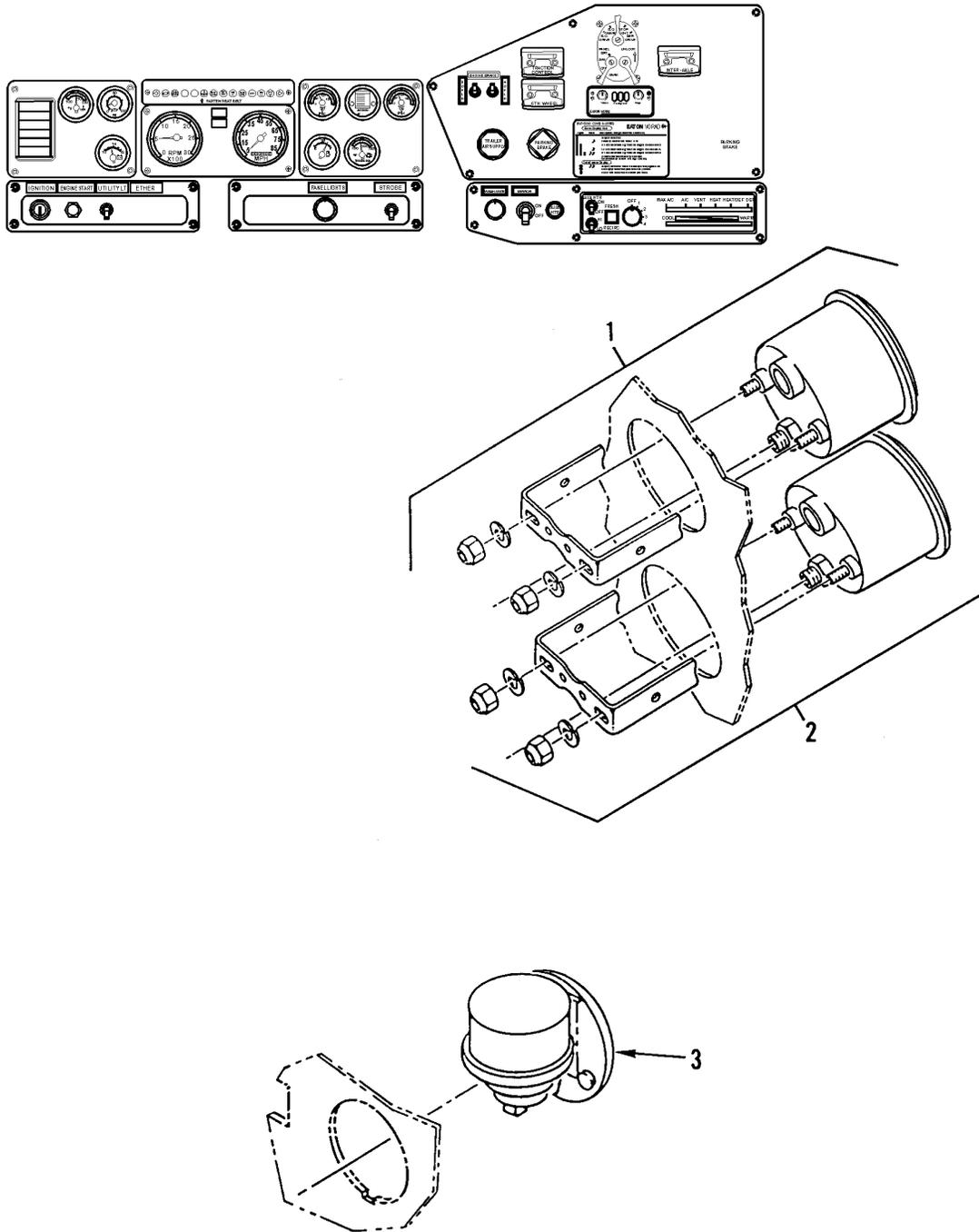

342-1359

Figure 246. Air Pressure Gages and Air Restriction Gage

SECTION II			TM9-2320-302-24P			
(1)	(2)	(3)	(4)	(5)	(6)	(7)
ITEM	SMR			PART		
NO	CODE	NSN	CAGEC	NUMBER	DESCRIPTION AND USABLE ON CODES(UOC)	QTY
					GROUP 47 GAGES (NONELECTRICAL), WEIGHING AND MEASURING DEVICES GROUP 4702 GAGES, MOUNTINGS, LINES, AND FITTINGS	
					FIG. 246 AIR PRESSURE GAGES AND AIR RESTRICTION GAGE	
1	PAOZZ	6685013354471	57733	490-ZY	GAGE,PRESSURE,DIAL.....	1
2	PAOZZ	5220013489747	64678	AMA/162316	GAGE,COMPARATOR,AIR.....	1
3	PAOZZ	6680014750101	59150	168501-00225	GAUGE,COMPARATOR,AI.....	1

END OF FIGURE

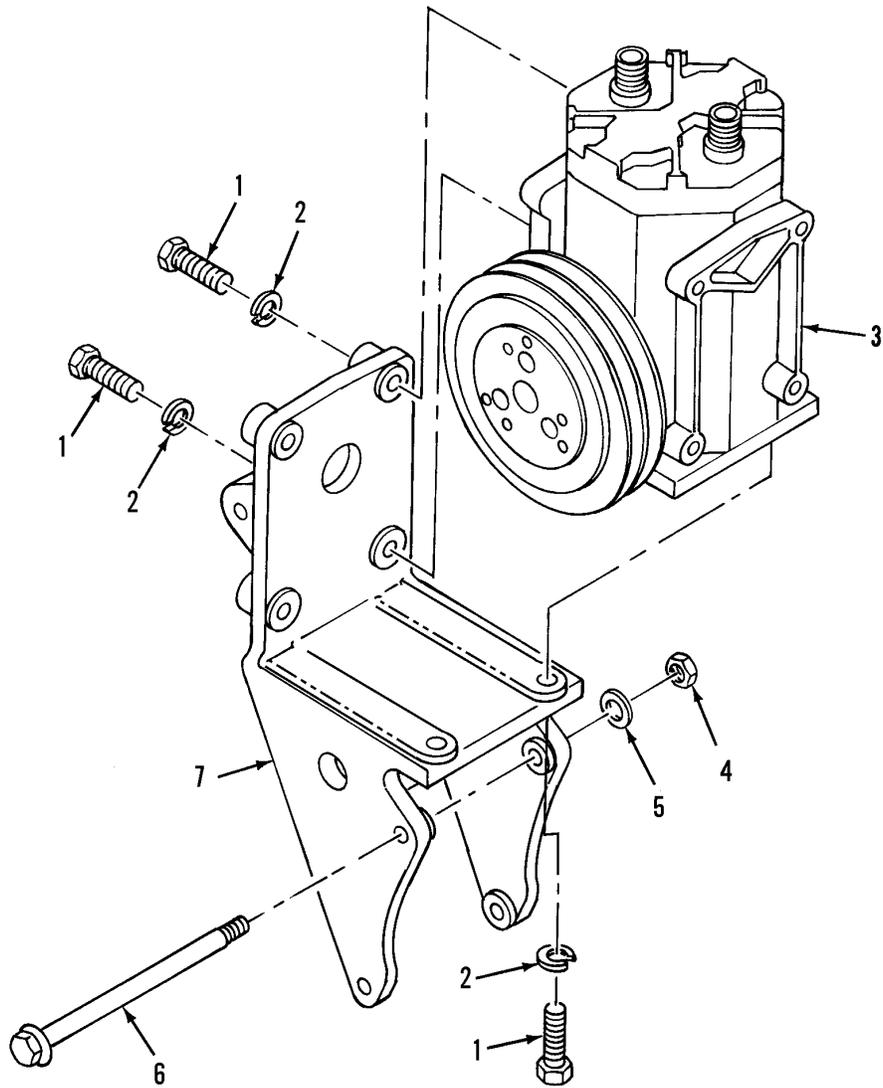

342-1360

Figure 247. A/C Compressor and Mounting Hardware

SECTION II			TM9-2320-302-24P			
(1)	(2)	(3)	(4)	(5)	(6)	(7)
ITEM	SMR			PART		
NO	CODE	NSN	CAGEC	NUMBER	DESCRIPTION AND USABLE ON CODES(UOC)	QTY
					GROUP 52 REFRIGERATION, AIR CONDITIONER/HEATER, AND AIR CONDITIONING COMPONENTS GROUP 5200 AIR CONDITIONER/HEATER ASSEMBLY AND GAS COMPRESSOR ASSEMBLY	
					FIG. 247 A/C COMPRESSOR AND MOUNTING HARDWARE	
1	PAOZZ	5305008213869	80204	B1821BH038C175N	SCREW,CAP,HEXAGON H 3/8-16 X 1.75 GR 8.....	6
2	PAOZZ	5310011086232	88044	AN935-616	WASHER,LOCK 3/8 INCH.....	6
3	PAFFF	4130014392870	0W4A6	ET210L-25073C	COMPRESSOR,REFRIGER.....	1
4	PAOZZ	5310008808189	96906	MS51967-11	NUT,PLAIN,HEXAGON 7/16-14 UNC,0.38.	2
5	PAOZZ	5310014382370	64678	23-09114-001	WASHER,FLAT.....	4
6	PAOZZ		80204	B1821BH038C175N	SCREW,CAP,HEXAGON H 3/8-16 X 1.75 GR8.....	2
7	PAOZZ	5342014392534	72582	23516961	BRACKET,ENGINE ACCE.....	1

END OF FIGURE

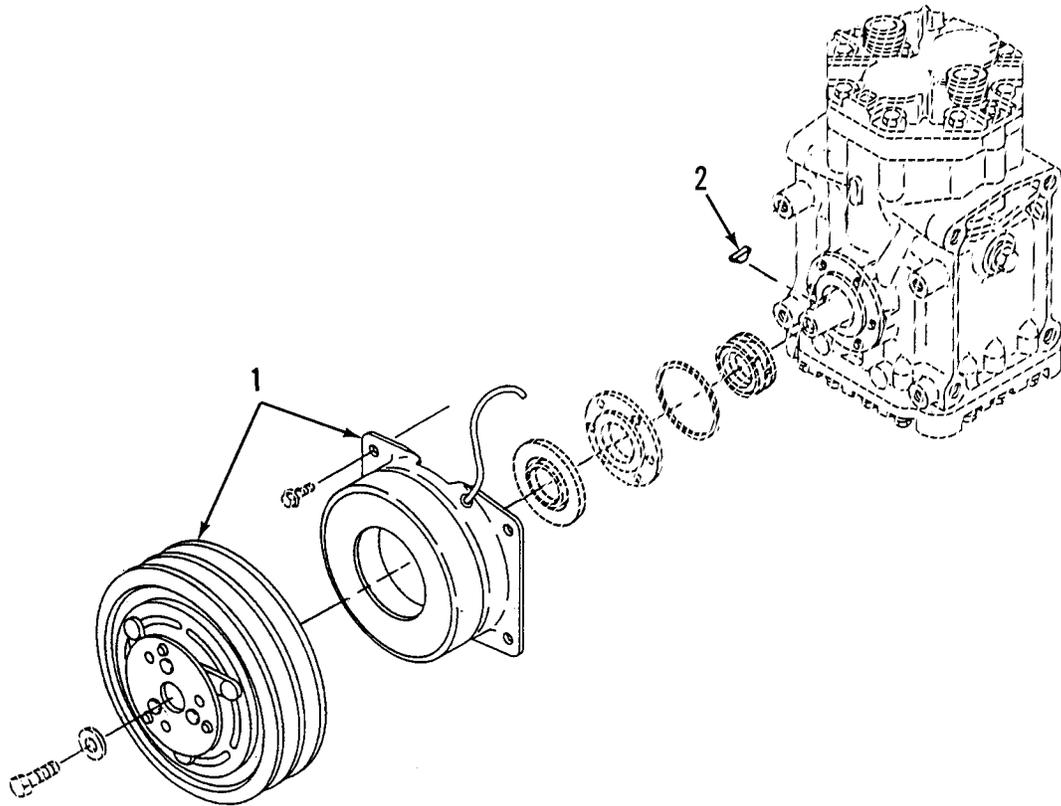

342-1547

Figure 248. Clutch Assembly, A/C Compressor

SECTION II			TM9-2320-302-24P			
(1)	(2)	(3)	(4)	(5)	(6)	(7)
ITEM	SMR			PART		
NO	CODE	NSN	CAGEC	NUMBER	DESCRIPTION AND USABLE ON CODES(UOC)	QTY
					GROUP 5203 COMPRESSOR DRIVE, PEDESTAL, BASE	
					FIG. 248 CLUTCH ASSEMBLY, A/C COMPRESSOR	
1	PFOZZ	2520014489159	0W4A6	024-21590	CLUTCH,MAGNETIC,VEH.....	1
2	PFOZZ	5315014400441	0W4A6	029-09888	KEY,WOODRUFF.....	1

END OF FIGURE

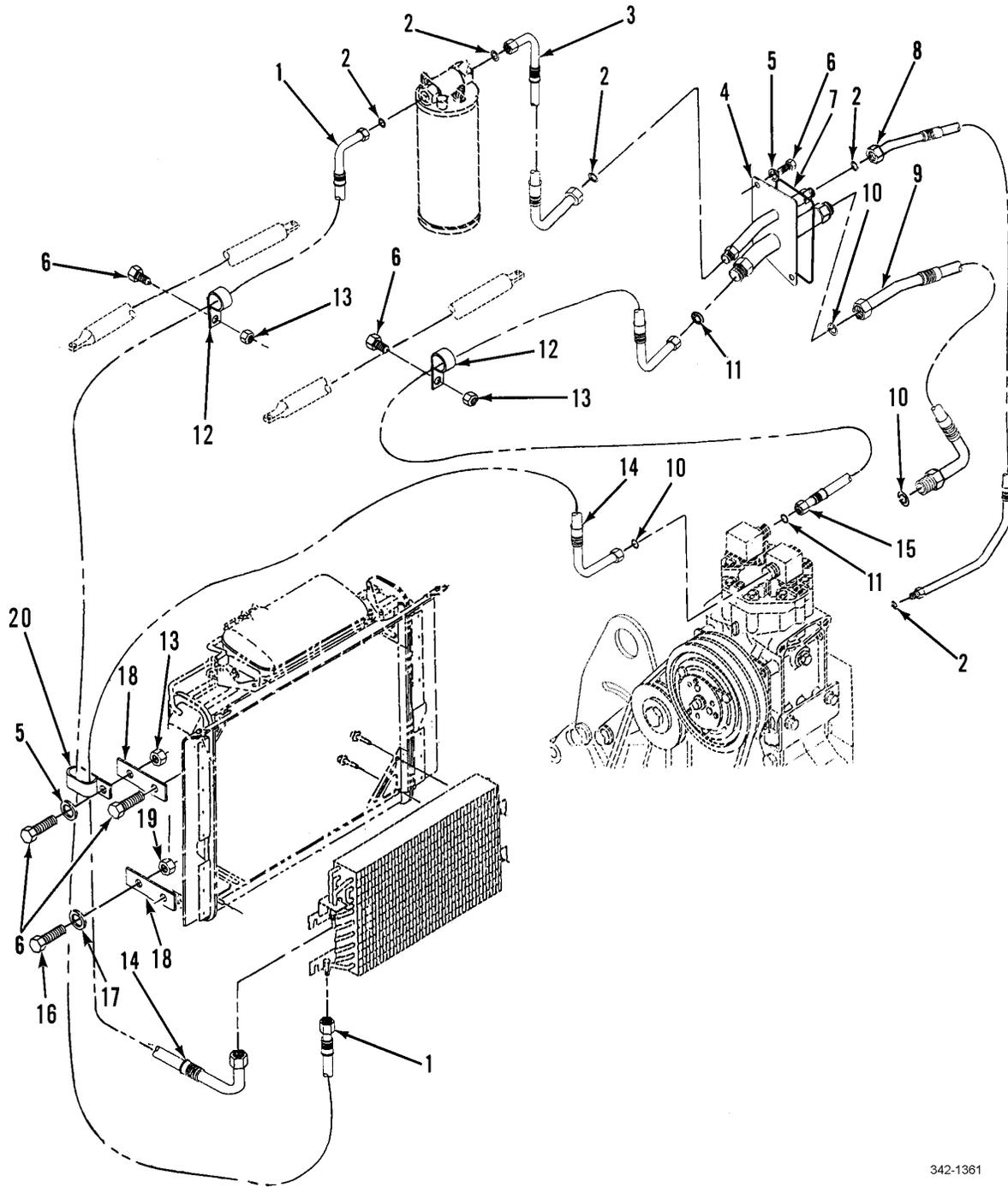

342-1361

Figure 249. A/C Hoses and Brackets

SECTION II			TM9-2320-302-24P			
(1)	(2)	(3)	(4)	(5)	(6)	(7)
ITEM	SMR			PART		
NO	CODE	NSN	CAGEC	NUMBER	DESCRIPTION AND USABLE ON CODES(UOC)	QTY
GROUP 5217 REFRIGERANT PIPING						
FIG. 249 A/C HOSES AND BRACKETS						
1	PAFZZ	4720014422306	64678	A22-32945-094	HOSE ASSEMBLY, NONME 5/8 X 94 IN. A/C COMPRESSOR TO RECEIVER.....	1
2	PAFZZ	5331009166639	99657	J200AR11	O-RING #6.....	6
3	PAFZZ	4720014422305	64678	A22-41330-002	HOSE ASSEMBLY, NONME 5/8 X 18.5 IN. DRYER TO DECK.....	1
4	PAFZZ	4710014425074	64678	A22-38941-000	TUBE ASSEMBLY, METAL.....	1
5	PAFZZ	5310008094058	96906	MS27183-10	WASHER, FLAT 0.281 ID X 0.625 OD X 0.065 THK.....	8
6	PAFZZ	5305000680508	80204	B1821BH025C075N	SCREW, CAP, HEXAGON H 1/4-20X0.75....	6
7	XDFZZ		64678	22-46774-000	GASKET, NONMETALLIC INSTALL BETWEEN SPLICER PLATE & NOSE SKIN (FIREWALL)	1
8	PAFZZ	4720014422371	64678	A22-38763-000	HOSE ASSEMBLY, NONME 5/16.....	1
9	PAFZZ	4720014422732	64678	A22-38762-000	HOSE ASSEMBLY, NONME 5/8.....	1
10	PAFZZ	5331003520327	02697	2-013C557-70	O-RING.....	2
11	PAFZZ	5330012358331	02697	2-015C873-70	PACKING, PREFORMED.....	2
12	PFOZZ	5340013317277	18076	S464-G12	CLAMP, LOOP 0.75 ID.....	2
13	PAOZZ	5310000881251	81349	M45913/1-4CG5C	NUT, SELF LOCKING, HE 1/4-20UNC.....	4
14	PAFZZ	4720014422730	64678	A22-41331-014	HOSE ASSEMBLY, NONME COMPRESSOR TO CONDENSER.....	1
15	PAFZZ	4720014425077	64678	A22-41332-017	HOSE ASSEMBLY, NONME 7/8 X 48 IN. COMPRESSOR TO DECK.....	1
16	PAOZZ	5305014440594	64678	23-11177-075	SCREW, CAP, HEXAGON H 3/8-16 X 3/4...	2
17	PAOZZ	5310000814219	96906	MS27183-12	WASHER, FLAT 5/16 X 0.688 X 0.065...	2
18	XDOZZ		64678	23-09130-015	BRACKET.....	2
19	PAOZZ	5310009133366	81349	M45913/1-5CBB	NUT, SELF-LOCKING, HE.....	2
20	PFOZZ	5340013394266	64678	23-11358-024	CLAMP, LOOP 7/8 IN, 2 TUBES.....	4

END OF FIGURE

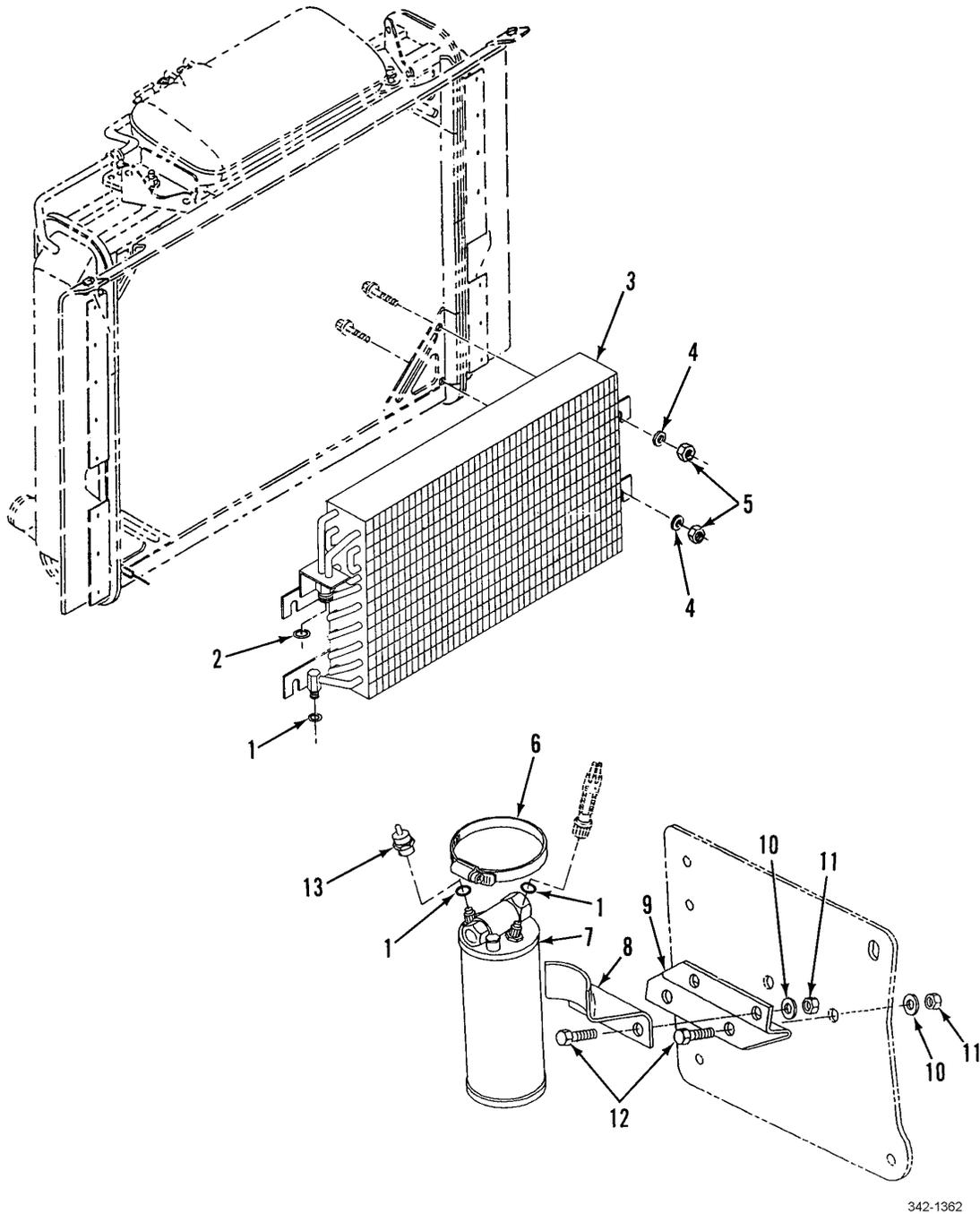

342-1362

Figure 250. A/C Condenser and Rec/Dryer

SECTION II			TM9-2320-302-24P			
(1)	(2)	(3)	(4)	(5)	(6)	(7)
ITEM	SMR			PART		
NO	CODE	NSN	CAGEC	NUMBER	DESCRIPTION AND USABLE ON CODES(UOC)	QTY
GROUP 5230 CONDENSOR						
FIG. 250 A/C CONDENSOR AND REC/DRYER						
1	PAFZZ	5331009166639	99657	J200AR11	O-RING NO. 6.....	2
2	PAFZZ	5330012358331	02697	2-015C873-70	PACKING,PREFORMED #10/12.....	2
3	PAFZZ	4130014419145	64678	22-32466-001	CONDENSING UNIT,REF.....	1
4	PAOZZ	5310000814219	96906	MS27183-12	WASHER,FLAT.....	4
5	PAOZZ	5310009133366	96906	MS51922-11	NUT,SELF-LOCKING,HE 5/16 X 18UNF-2B	4
6	PFOZZ	4730013262939	81646	5748	CLAMP,HOSE 2.56-3.50 IN.....	1
7	PAFZZ		30756	088335-00	CARTRIDGE,DEHYDRA W/O PRESSURE RELIEF VALVE.....	1
8	XDOZZ		64678	22-32610-000	BRACKET.....	1
9	XDOZZ		64678	22-44545-000	BRACKET.....	1
10	PAOZZ	5310000806004	96906	MS27183-14	WASHER,FLAT 0.406 ID X 0.812 OD X 0.065 THK.....	4
11	PAOZZ	5310007320558	96906	MS51967-8	NUT,PLAIN,HEXAGON 3/8-16UNC.....	4
12	PAOZZ	5305000680510	80204	B1821BH038C100N	SCREW,CAP,HEXAGON H 3/8-16X1.00....	4
13	PAFZZ	5930014443672	02UG1	SP-4097	SWITCH,PRESSURE.....	1

END OF FIGURE

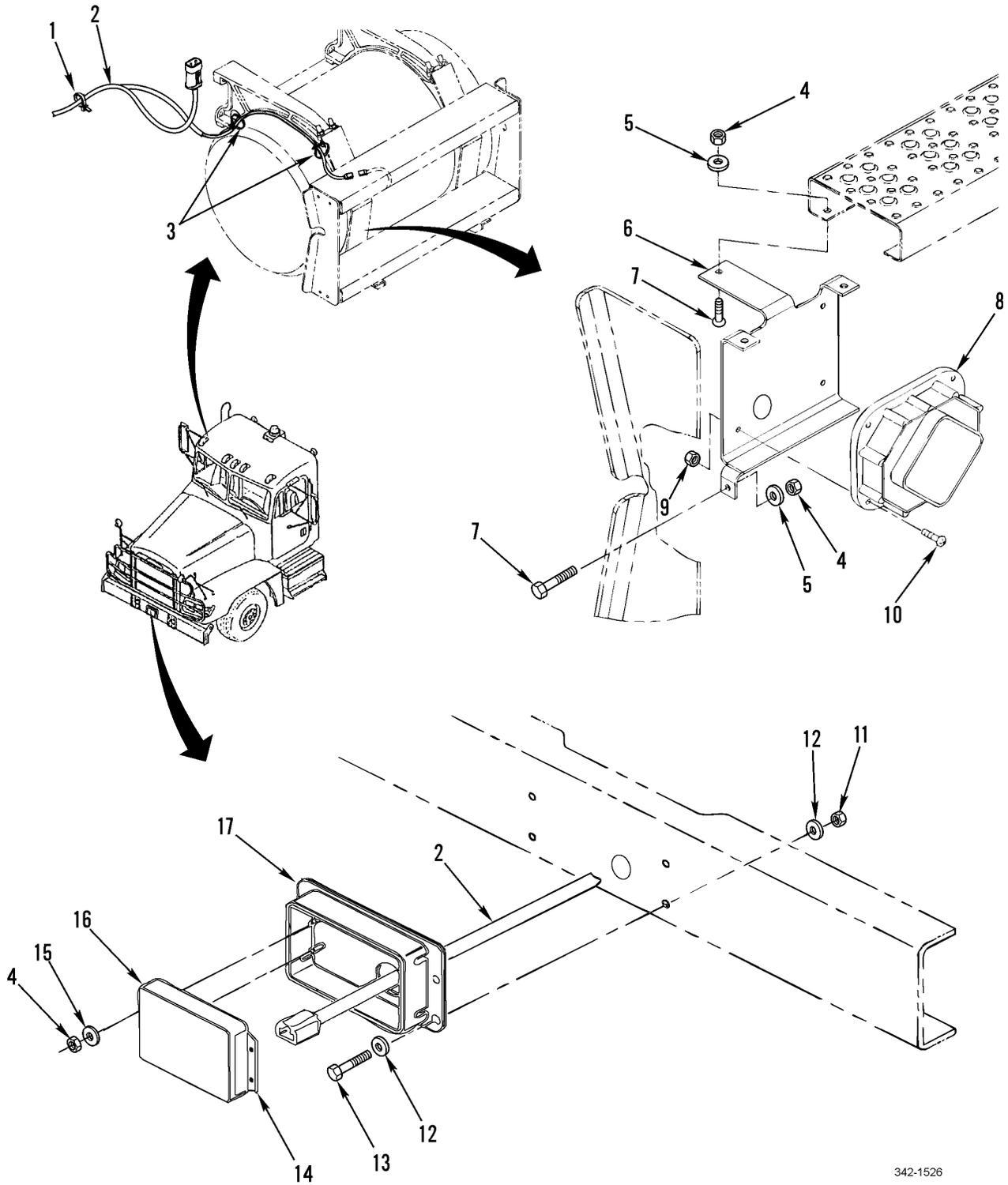

342-1526

Figure 251. VORAD External Components

SECTION II			TM9-2320-302-24P			
(1)	(2)	(3)	(4)	(5)	(6)	(7)
ITEM NO	SMR CODE	NSN	CAGEC	PART NUMBER	DESCRIPTION AND USABLE ON CODES(UOC)	QTY
GROUP 68 WARNING, SCANNING, AND SIGNALING DEVICES, AND NAVIGATIONAL INSTRUMENTS						
GROUP 6806 RADAR SYSTEM						
FIG. 251 VORAD EXTERNAL COMPONENTS						
1	PAOZZ	5975009441499	96906	MS3368-1-9A	STRAP,TIEDOWN,ELECT 1-3/4 X 8.....	8
2	PFOOO		64678	A06-31714-000	WIRING HARNESS,BRAN.....	1
3	PAOZZ		64678	23-09796-409	STRAP,TIEDOWN,ELECT 3 X 11.....	4
4	PAOZZ	5310000881251	81349	M45913/1-4CG5C	NUT,SELF-LOCKING,HE 1/4-20.....	8
5	XDOZZ		64678	23-10900-025	WASHER,FLAT 1/4" SST.....	4
6	XDOZZ		64678	06-35870-000	BRACKET,SIDE SENSOR.....	1
7	XDOZZ		64678	23-11613-710	SCREW,MACHINE 1/4-20 X 1.0", TORX HEAD.....	4
8	PBOZZ		19954	83200-100	ANTENNA-RECEIVER,RA RIGHT SIDE.....	1
9	PAOZZ	5310000881251	81349	M45913/1-4CG5C	NUT,SELF-LOCKING,HE 1/4-20.....	4
10	XDOZZ		64678	23-11613-706	SCREW,MACHINE 1/4-20 X .75" TORX HEAD.....	4
11	PAOZZ	5310002256993	81349	M45913/1-8CG5C	NUT,SELF-LOCKING,HE 1/2-13.....	4
12	PAOZZ	5310007679425	96906	MS15795-818	WASHER,FLAT .53 X 1.06 X .177.....	8
13	PAOZZ	5305000712067	80204	B1821BH050C125N	SCREW,CAP,HEXAGON H 1/2-13 X 1.25..	4
14	PFOZZ		64678	06-32349-000	BRACKET,ANGLE.....	2
15	PAOZZ	5310008094058	96906	MS27183-10	WASHER,FLAT 1/4".....	4
16	PBOZZ		19954	83124-100	ANTENNA-RECEIVER,RA FRONT.....	1
17	XDOZZ		64678	A06-33143-000	HOUSING,ELECTRONIC.....	1

END OF FIGURE

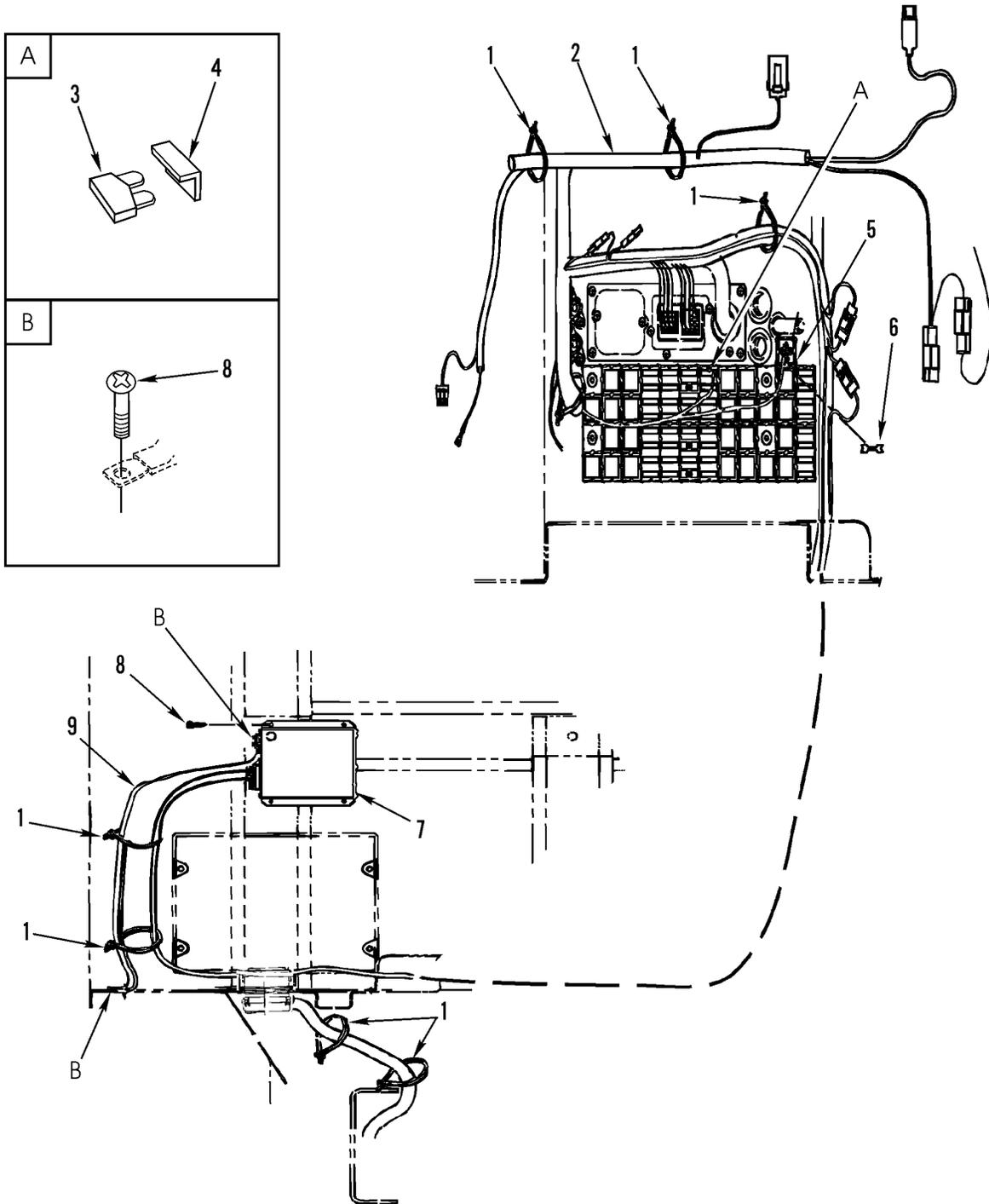

342-1527

Figure 252. VORAD Cab Wiring

SECTION II			TM9-2320-302-24P			
(1)	(2)	(3)	(4)	(5)	(6)	(7)
ITEM	SMR			PART		
NO	CODE	NSN	CAGEC	NUMBER	DESCRIPTION AND USABLE ON CODES(UOC)	QTY
GROUP 6806 RADAR SYSTEM						
FIG. 252 VORAD CAB WIRING						
1	PAOZZ	5975009441499	96906	MS3368-1-9A	STRAP,TIEDOWN,ELECT 1-3/4 X 8.....	8
2	PFOOO		64678	A06-31483-000	WIRING HARNESS,BRAN.....	1
3	PAOZZ	5920011235212	58536	AA55569/01-005	FUSE,INCLOSED LINK.....	1
4	PAOZZ	5340013760542	2E480	59099	CLIP,RETAINING.....	1
5	PAOZZ		77342	VF4-15F11-C01	RELAY,ELECTROMAGNET.....	1
6	PAOZZ	2590013504238	2E480	59011	LOCKING WEDGE.....	1
7	PFOZZ		19954	80626-740	CONTROL,COMPUTER PR.....	1
8	XDOZZ		64678	23-12099-306	SCREW,WASHER HEAD 10-16 X 3/4 IN...	4
9	XDOZZ		64678	A06-09664-002	HARNESS,GROUND.....	1

END OF FIGURE

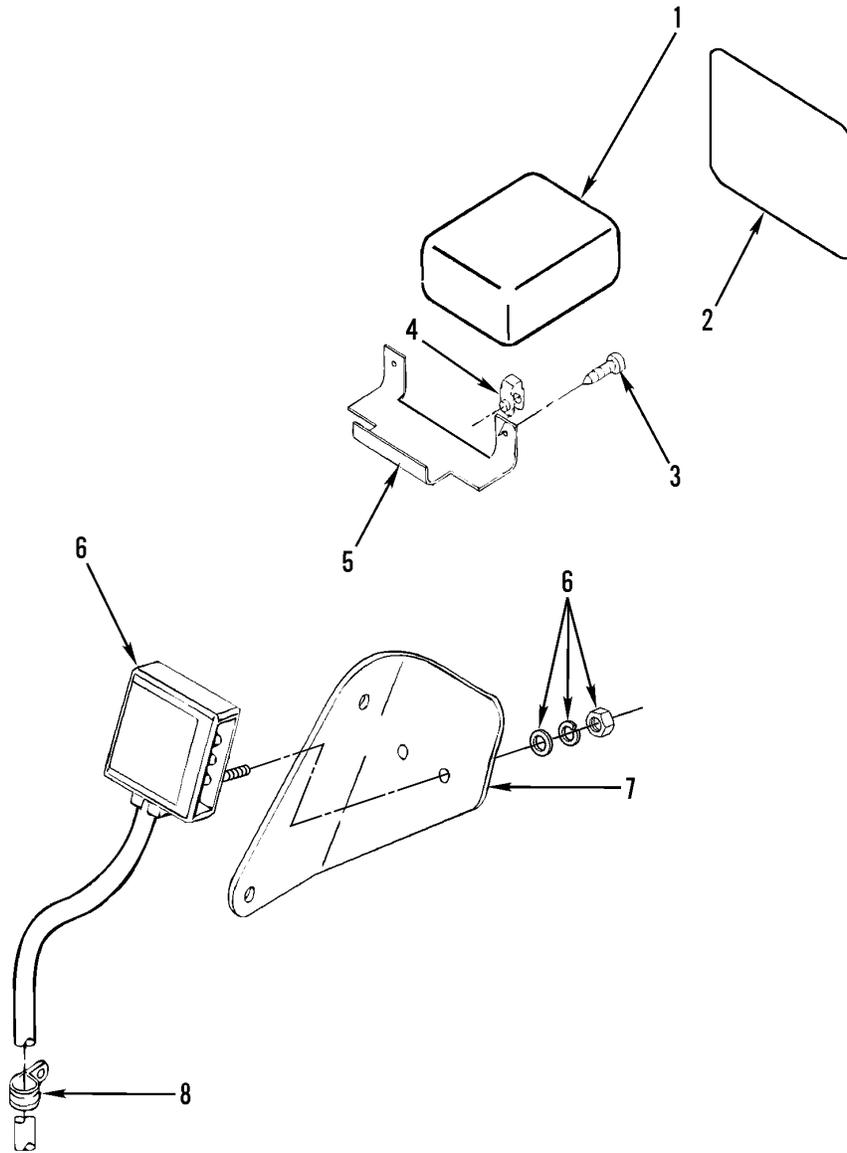

342-1528

Figure 253. VORAD Internal Cab Components

SECTION II			TM9-2320-302-24P			
(1)	(2)	(3)	(4)	(5)	(6)	(7)
ITEM	SMR			PART		
NO	CODE	NSN	CAGEC	NUMBER	DESCRIPTION AND USABLE ON CODES(UOC)	QTY
GROUP 6806 RADAR SYSTEM						
FIG. 253 VORAD INTERNAL CAB COMPONENTS						
1	PBOZZ		19954	81082-102	DISPLAY UNIT.....	1
2	XDOZZ		19954	80026-001	LABEL,SYSTEM WARNIN.....	1
3	PAOZZ		64678	23-11345-707	SCREW,MACHINE 7/8", 10B, DOG PT, BLK.....	2
4	PFOZZ	5310013372353	64678	23-11865-000	NUT,CLIP-ON 10-16, .024-.5 PNL.....	2
5	PFOZZ		64678	18-38936-000	BRACKET,MOUNTING.....	1
6	PAOZZ		19954	80893-102	DISPLAY,UNIT.....	1
7	XDOZZ		64678	18-34573-000	BRACKET,SIDE DISPLA.....	1
8	PAOZZ	5340013366531	18076	S630G-6	CLAMP,LOOP .375 ID.....	1

END OF FIGURE

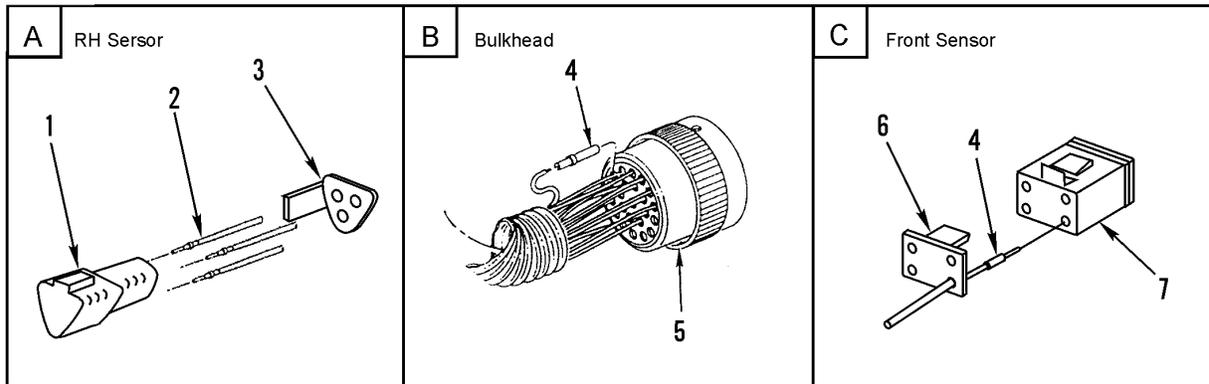
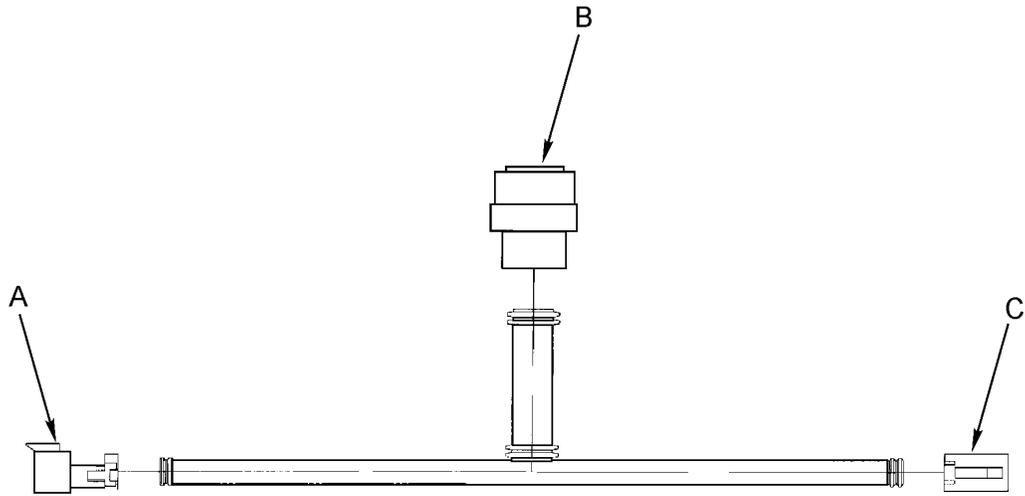

Figure 254. VORAD Chassis Harness Components

SECTION II			TM9-2320-302-24P			
(1)	(2)	(3)	(4)	(5)	(6)	(7)
ITEM	SMR			PART		
NO	CODE	NSN	CAGEC	NUMBER	DESCRIPTION AND USABLE ON CODES(UOC)	QTY
GROUP 6806 RADAR SYSTEM						
FIG. 254 VORAD CHASSIS HARNESS COMPONENTS						
1	XDOZZ		11139	DT04-3P	CONNECTOR, PLUG ELEC.....	1
2	PAOZZ	5999012163648	11139	0460-202-16141	CONTACT, ELECTRICAL 16-18, GA.....	3
3	PAOZZ	5935014708337	11139	W3P	POLARIZING KEY, ELEC.....	1
4	PAOZZ	5999012036687	11139	0462-201-16141	CONTACT, ELECTRICAL.....	11
5	PAOZZ	5935013643646	11139	HD36-18-14SN	CONNECTOR BODY, PLUG.....	1
6	XDOZZ		11139	W4S	LOCK, WEDGE.....	1
7	XDOZZ		11139	DT06-4S	CONNECTOR.....	1

END OF FIGURE

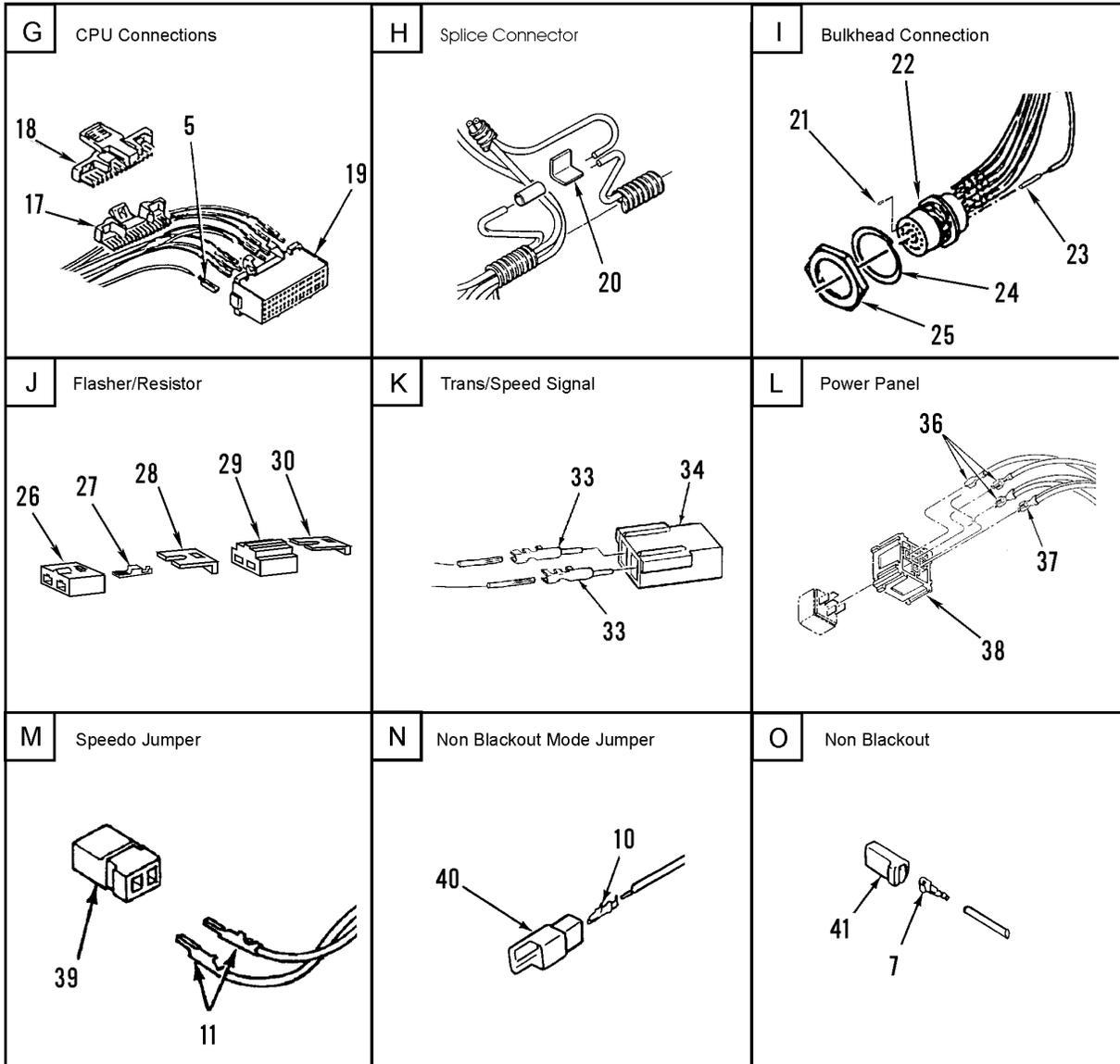
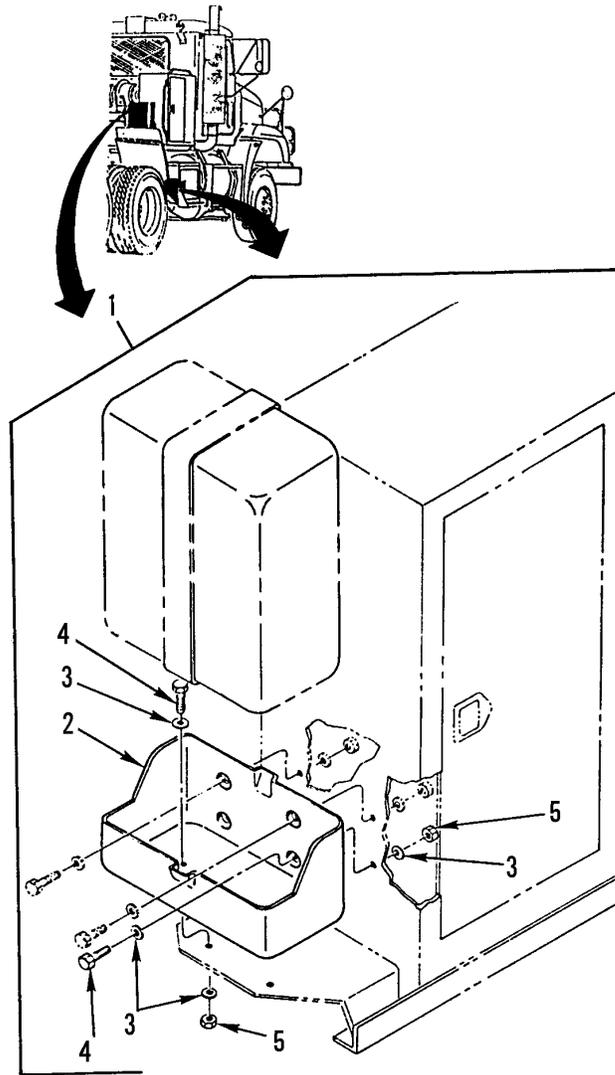

Figure 255. VORAD Cab Harness Components (Sheet 2 of 2)

SECTION II			TM9-2320-302-24P			
(1)	(2)	(3)	(4)	(5)	(6)	(7)
ITEM	SMR			PART		
NO	CODE	NSN	CAGEC	NUMBER	DESCRIPTION AND USABLE ON CODES(UOC)	QTY
GROUP 6806 RADAR SYSTEM						
FIG. 255 VORAD CAB HARNESS COMPONENTS						
1	XDOZZ		77060	12162188	CONNECTOR, SEALED.....	1
2	XDOZZ		77060	12124075	TERMINAL.....	4
4	XDOZZ		77060	12059160	LOCK.....	1
5	XDOZZ		77060	12146448	CONNECTOR, PLUG, ELEC.....	23
6	XDOZZ		77060	12059162	CONNECTOR.....	1
7	PAOZZ		77060	12124520	TERMINAL, QUICK DISC.....	3
8	PAOZZ	5935011618087	77060	2973781	CONNECTOR BODY, PLUG.....	1
9	PAOZZ	5935012963521	77060	2984883	CONNECTOR BODY, PLUG.....	1
10	PAOZZ	5940013476143	77060	2965439	TERMINAL, QUICK DISC 18/20.....	3
11	PAOZZ	5940013476142	77060	12066214	TERMINAL, QUICK DISC.....	3
12	PAOZZ	5940013570069	77060	12034046	SPLICE SET, QUICK DI.....	2
13	XDOZZ		77060	12015344	CONNECTOR, PLUG, ELEC.....	1
14	PAOZZ	5940013366322	00779	62691-2	TERMINAL, LUG.....	1
15	PAOZZ	5940013919982	77060	12034047	TERMINAL, LUG.....	4
16	XDOZZ		77060	12015345	CONNECTOR, PLUG, ELEC.....	1
17	PAOZZ	5935013366410	77060	12045889	CONNECTOR BODY, PLUG.....	1
18	PAOZZ	5935013363693	77060	12045890	CONNECTOR BODY, PLUG.....	1
19	XDOZZ		77060	12045537	CONNECTOR.....	1
20	PAOZZ	5940008425353	77060	1839906	SPLICE, CONDUCTOR 2.3-6.45 MM2.....	4
21	PAOZZ	5935011741235	11139	114017	PLUG, END SEAL, ELECT.....	7
22	PAOZZ	5935013647773	11139	HD34-18-14PN	CONNECTOR BODY, RECE.....	1
23	PAOZZ	5999012163648	11139	0460-202-16141	CONTACT, ELECTRICAL.....	7
24	PAOZZ	5310010810798	11139	114021	WASHER, LOCK.....	1
25	PAOZZ	5310010867725	11139	114020-90	NUT, PLAIN, HEXAGON.....	1
26	XDOZZ		77060	12064749	CONNECTOR.....	1
27	PAOZZ	5940013421640	77060	12020120	TERMINAL, QUICK DISC.....	1
28	XDOZZ		77060	12059860	LOCK, SECONDARY.....	1
29	XDOZZ		77060	12064750	CONNECTOR.....	1
30	XDOZZ		77060	12064751	LOCK, SECONDARY.....	1
31	PAOZZ	5905004267095	81349	RNC60K1002FS	RESISTOR, FIXED, FILM.....	1
32	PAOZZ	5940013431262	77060	12124304	TERMINAL, QUICK DISC.....	1
33	PAOZZ	5940014195877	77060	12084586	TERMINAL, QUICK DISC.....	1
34	PAOZZ	5935013371028	77060	12015271	CONNECTOR BODY, PLUG.....	1
35	PAOZZ	5940014000618	77060	12020321	TERMINAL, QUICK DISC.....	1
36	XDOZZ		77060	12015869	TERMINAL, FEMALE #18.....	3
37	XDOZZ		77060	12020035	TERMINAL, FEMALE #18.....	1
38	PAOZZ	5935013472657	2E480	059022	CONNECTOR, PLUG, ELEC.....	1
39	XDOZZ		77060	12015199	PLUG, CONNECTOR, ELEC.....	1
40	PAOZZ	5940012347954	77060	2984528	TERMINAL BODY, QUICK.....	1
41	PAOZZ	5935010657984	77060	2977253	CONNECTOR, PLUG, ELEC.....	1
42	PAOZZ	5940007881586	77060	2965142	TERMINAL, QUICK DISC.....	1

END OF FIGURE



342-1363

Figure 256. M13 Decontamination Mounting Kit

SECTION II			TM9-2320-302-24P			
(1)	(2)	(3)	(4)	(5)	(6)	(7)
ITEM	SMR			PART		
NO	CODE	NSN	CAGEC	NUMBER	DESCRIPTION AND USABLE ON CODES(UOC)	QTY
					GROUP 91 CHEMICAL, BIOLOGICAL, AND RADIOLOGICAL (CBR) EQUIPMENT GROUP 9120 DECONTAMINATION EQUIPMENT	
					FIG. 256 M13 DECONTAMINATION MOUNTING KIT	
1	XDOZZ		64678	681 899 02 K0	BRACKET,DOUBLE ANGL KIT,M13 DECONTAMINATION.....	1
2	PFOZZ	2590004736331	19207	6566675	.BRACKET,VEHICULAR C.....	1
3	PAOZZ	5310000814219	96906	MS27183-12	.WASHER,FLAT .344 ID X .688 OD X .065 THK.....	12
4	PAOZZ	5306002264825	80204	B1821BH031C075N	.BOLT,MACHINE 5/16-18UNC-2A X .750.	6
5	PAOZZ	5310009133366	96906	MS51922-11	.NUT,SELF-LOCKING,HE 5/16 X 18UNF-2B.....	6

END OF FIGURE

SECTION II			TM9-2320-302-24P			
(1)	(2)	(3)	(4)	(5)	(6)	(7)
ITEM	SMR			PART		
NO	CODE	NSN	CAGEC	NUMBER	DESCRIPTION AND USABLE ON CODES(UOC)	QTY
					GROUP 94 REPAIR KITS EQUIPMENT	
					GROUP 9401 REPAIR KITS	
					FIG. KITS	
PAFZZ	4320013295022	06721	ERS-28310		PARTS KIT,ROTARY PU.....	1
					CAM (1) 173-2	
					CARRIER (1) 173-5	
					PIN,DRIVE (1) 173-4	
					PIN,LOCATING (1) 173-19	
					PLATE,PORT (1) 173-15	
					ROLLS (10) 173-6	
PAHZZ	5330010911107	78500	KIT 1568		GASKET AND SHIM SET.....	1
					SHIM (1) 144-5	
					SHIM (1) 144-5	
					SHIM (1) 144-5	
					SPACER (1) 144-5	
PAHZZ	5365013309716	78500	KIT 2322		SHIM ASSORTMENT.....	1
					SPACER (2) 144-6	
					SPACER (2) 144-6	
					SPACER (2) 144-6	
					SPACER (2) 144-6	
					SPACER (2) 144-6	
					SPACER (2) 144-6	
					SPACER (2) 144-6	
					SPACER (2) 144-6	
					SPACER (2) 144-6	
					SPACER (2) 144-6	
PAOZZ	2530014791357	78500	KSR301 4702QP		PARTS KIT,SHOE BRAK.....	1
					BUSHING,ANCHOR PIN (2) 146-5	
					CLIP,SPRING TENSION(1) 146-21	
					PIN,RETURN SPRING (1) 146-17	
					PIN,SHOULDER,HEADLE(2) 146-4	
					ROLLER (1) 146-16	
					SHOE & LINING ASSY (2) 146-18	
					SPRING,RETURN (1) 146-19	
					SPRING,RETAINER (2) 146-20	
PAFZA	2510014790934	74410	RK-351-A-02-L		PARTS KIT,FIFTH WHE REBUILD KIT....	1
					CAM,CONTROL (1) 190-28	
					CONNECTING LINK,RIG(1) 190-19	
					HANDLE,LOCK,SECOND (1) 190-21	
					HANDLE,MANUAL CONTR(1) 190-13	
					NUT,SELF-LOCKING,HE(1) 190-8	
					NUT,SELF-LOCKING,HE(1) 190-27	
					PIN,COTTER (2) 190-23	
					PIN,COTTER (1) 190-14	
					PIN,STRAIGHT,HEADLE(1) 190-18	
					PIN,STRAIGHT,HEADED(2) 190-22	
					PLATE,FIFTH WHEEL A(1) 190-25	
					ROLLER,LINEAR-ROTAR(1) 190-29	
					ROLLER,LINEAR-ROTAR(1) 190-12	

SECTION II			TM9-2320-302-24P			
(1)	(2)	(3)	(4)	(5)	(6)	(7)
ITEM	SMR			PART		
NO	CODE	NSN	CAGEC	NUMBER	DESCRIPTION AND USABLE ON CODES(UOC)	QTY
					SCREW,CAP,HEXAGON H(1) 190-9
					SCREW,CAP,HEXAGON H(1) 190-11
					SPACER,SLEEVE	(1) 190-6
					SPRING,HELICAL,COMP(1) 190-3
					SPRING,HELICAL,TORS(1) 190-20
					SPRING,HELICAL,EXTE(1) 190-24
					SPRING,HELICAL,TORS(1) 190-26
					SPRING,HELICAL,EXTE(1) 190-16
					STUD	(1) 190-4
					TAG,LOCK ADJ	(1) 190-5
					WASHER,FLAT	(1) 190-7
					WASHER,FLAT	(2) 190-2
					WASHER,FLAT	(2) 190-10
					WASHER,FLAT	(1) 190-15
					WASHER,FLAT	(1) 190-17
					YOKE,FIFTH WHEEL	(1) 190-1
PAFZZ	5330013286054		77640	TAS650006	PARTS KIT,SEAL REPL.....	1
					ADJUSTER LOCKNUT	(1) 172-26
					GASKET	(1) 172-6
					GUIDE,BALL RETURN	(2) 172-53
					O-RING	(1) 172-17
					O-RING	(2) 172-24
					O-RING	(2) 172-48
					O-RING	(1) 172-35
					O-RING (VLV HSG)	(1) 172-29
					PACKING,PREFORMED	(1) 172-36
					PACKING,PREFORMED	(1) 172-45
					PLUG,VENT	(1) 172-3
					RING,RETAINING	(1) 172-33
					SEAL	(1) 172-15
					SEAL	(1) 172-52
					SEAL	(1) 172-34
					SEAL	(1) 172-16
					SEAL	(1) 172-32
					SEAL RING	(1) 172-28
					SEAL RING	(2) 172-23
					SEAL,OUTPUT	(2) 172-7
PAFZZ	5305013284245		77640	021407X1	THUMBSCREW.....	1
					NUT,JAM	(1) 172-9
					SCREW,ADJUSTING	(1) 172-8
PAOZZ	2520014411704		75418	1033-05435-03	PARTS KIT,CLUTCH DI.....	1
					COUPLING	(1) 54-18
					NUT,CYLINDER	(1) 54-3
					O-RING	(1) 54-5
					O-RING	(1) 54-6
					O-RING	(1) 54-17
					O-RING	(1) 54-15
					SCREW	(6) 54-25
					SEAL,PLAIN	(1) 54-9
					SPRING,HELICAL,COMP(1) 54-11
PAOZZ	2930014411726		75418	1033-07781-01	PARTS KIT,FAN RADIA.....	1
					BEARING	(1) 54-30

SECTION II			TM9-2320-302-24P			
(1)	(2)	(3)	(4)	(5)	(6)	(7)
ITEM	SMR			PART		
NO	CODE	NSN	CAGEC	NUMBER	DESCRIPTION AND USABLE ON CODES(UOC)	QTY
					BEARING (1) 54-32	
					COUPLING (1) 54-18	
					O-RING (1) 54-17	
					SNAP RING,INTERNAL (1) 54-31	
					SNAP RING,INTERNAL (1) 54-33	
PAOZZ	2520014411736	75418	1033-08250-01		PARTS KIT, FRICTION.....	1
					LINING,PIECE,1 (1) 54-23	
					SCREW (6) 54-25	
PAFZZ	2815013348096	06853	107516		PARTS KIT,CYLINDER TU-FLO 750.....	1
					GASKET (1) 162-11	
					GASKET (1) 162-6	
					GASKET (1) 162-46	
					GASKET,CYLINDER HD (1) 162-42	
					INLET VALVE STOP (1) 162-15	
					INLET VALVE SEAT (1) 162-12	
					PACKING,PREFORMED (1) 162-7	
					PISTON,UNLOADER (1) 162-8	
					SEAT,VALVE (1) 162-17	
					SEAT,VALVE (1) 162-16	
					SPRING HELICAL,COMP(1) 162-9	
					SPRING,HELICAL,COMP(1) 162-18	
					SPRING,INLET VALVE (1) 162-14	
					VALVE,INLET (1) 162-13	
PAFZZ	4310013348636	06853	107639		RING SET,PISTON TU-FLO 750.....	1
					RING,PISTON (3) 162-37	
					RING,PISTON (4) 162-35	
					RING,PISTON (2) 162-36	
PAFZZ	3120013342740	06853	107969		BEARING,SLEEVE TU-FLO 750.....	1
					BEARING (1) 162-25	
					BEARING,SLEEVE (1) 162-32	
					GASKET,BASE (1) 162-33	
					RING,RETAINING (1) 162-24	
					SEAL,RING (1) 162-22	
PAFZZ	2530014524670	06853	108842		PARTS KIT,PISTON AS.....	1
					CONNECTING ROD ASSY(1) 162-34	
					GASKET,BASE (1) 162-33	
					PIN,PISTON (2) 162-40	
					PISTON,STD (1) 162-39	
					PLUG,RETAINER PIN (2) 162-38	
					RING,PISTON (3) 162-37	
					RING,PISTON (4) 162-35	
					RING,PISTON (2) 162-36	
PAOZZ			78500	2KSR2024707QP	PARTS KIT,BRAKE SHO.....	1
					BRAKE SHOE ASSEMBLY(2) 147-7	
					SPRING,RETAINER (2) 147-6	
					SPRING,RETURN (1) 147-18	
PAFZZ	5330012719544	47457	20510093-25Z		GASKET SET.....	1
					O-RING (1) 173-13	
					O-RING (1) 173-9	
					O-RING (1) 173-7	
					O-RING (2) 173-17	
					SEAL (2) 173-16	

SECTION II			TM9-2320-302-24P			
(1)	(2)	(3)	(4)	(5)	(6)	(7)
ITEM	SMR			PART		
NO	CODE	NSN	CAGEC	NUMBER	DESCRIPTION AND USABLE ON CODES(UOC)	QTY
PAHZZ	5340013677087	78500	2317		SEAL (2) 173-29	
PAFZZ	5330013181949	72582	23501572		BOLT AND SPACER KIT.....	2
					GASKET AND PREFORME.....	V
					GASKET (1) 27-19	
					GASKET (3) 23-6	
					GASKET (1) 34-26	
					GASKET (1) 6-26	
					GASKET (1) 11-5	
					GASKET (1) 34-20	
					GASKET AND PREFORME(1) 7-21	
					O-RING (2) 6-2	
					PACKING, PREFORMED (1) 6-27	
					SEAL (1) 6-21	
					SEAL, PLAIN ENCASED (2) 50-7	
PAFZZ	5330013205071	72582	23509105		PARTS KIT, SEAL REPL.....	V
					BEARING, ASM W/CONE(1) 51-22	
					GASKET (1) 51-9	
					RING, SNAP ROUND (1) 51-21	
					SEAL, OIL WAT PUMP (1) 51-24	
PAFZZ		72582	23509128		PARTS KIT, ENGINE PU.....	V
					BEARING, ASM W/CONE(1) 51-22	
					GASKET (1) 51-9	
					RING, SNAP ROUND (1) 51-21	
					SEAL, OIL WAT PUMP (1) 51-24	
					SEAL, PLAIN (1) 51-13	
					SEAL, WATER PUMP (1) 51-15	
PFFZZ	5330013182324	72582	23512691		GASKET AND PREFORME.....	V
					GASKET (1) 18-13	
					GASKET (1) 27-19	
					GASKET (3) 23-6	
					GASKET (1) 29-1	
					GASKET (1) 34-26	
					GASKET (3) 23-1	
					GASKET (1) 27-6	
					GASKET (1) 161-14	
					GASKET (1) 6-26	
					GASKET (1) 11-5	
					GASKET (1) 16-1	
					GASKET (1) 34-20	
					GASKET AND PREFORME(1) 7-21	
					O-RING (1) 18-5	
					O-RING (2) 6-2	
					PACKING, PREFORMED (1) 6-27	
					RING, SEAL (1) 24-7	
					SEAL (1) 6-21	
					SEAL, PLAIN (1) 11-4	
					SEAL, PLAIN (1) 25-12	
					SEAL, PLAIN ENCASED (2) 50-7	
PAFZZ		72582	23520013		SCREW, ADJUSTING, VAL.....	V
					BUTTON, VALVE (30) 13-8	
					SCREW, VALVE ADJUST (6) 13-9	
					SCREW, VALVE ADJUST (18) 13-10	

SECTION II			TM9-2320-302-24P			
(1)	(2)	(3)	(4)	(5)	(6)	(7)
ITEM	SMR			PART		
NO	CODE	NSN	CAGEC	NUMBER	DESCRIPTION AND USABLE ON CODES(UOC)	QTY
PAFZZ			72582	23520014	SCREW, ADJUSTING, VAL.....	V
					BUTTON, VALVE (30) 13-8	
					SCREW, VALVE ADJUST (12) 13-7	
PAFZZ			72582	23521330	INSERT KIT.....	V
					BUSHING, INSERT (3) 16-3	
					NUT, HEXAGON (3) 16-5	
					PACKING, PREFORMED (3) 16-4	
PFFZZ			72582	23521436	PARTS KIT, HOSE ASSE INCLUDES 24"	V
					HOSE, CLAMPS, CLIP, SCREW.....	
					CLAMP, LOOP (2) 34-4	
					CLIP, HOSE (1) 34-7	
					HOSE, NONMETALLIC (1) 34-5	
					SCREW, MACHINE (1) 34-6	
PAHZZ	5365013307318		78500	2396	SPACER SET, RING.....	1
					SPACER (2) 142-37	
PAFZZ	2910013229191		72582	5236116	PARTS KIT, ENGINE QU.....	1
					SCREW, HEX HEAD (4) 28-2	
					SEAL, SPACER (2) 28-3	
PAOZZ	5340013711658		08645	608148AA1-H680	LOCK SET, RIM.....	1
					LOCK, DOOR (1) 203-17	
					LOCK, GLOVE BOX (1) 201-61	
PAOZZ	2540013327679		3B481	6107838-001	PARTS KIT, SEAT, VEHI.....	1
					BEARING, RDL BALL (4) 220-5	
					BEARING, MULTILUBE (6) 220-16	
					BOLT, SHOULDER (2) 220-15	
					CAP, END (2) 220-8	
					NUT, SELF-LOCKING, HE(2) 220-19	
					PAD, THRUST DELRIN (2) 220-3	
					RING, RETAINING (6) 220-4	
					ROLLER ASSY (4) 220-14	
					SETSCREW (2) 220-7	
					SPRING, ISOLATOR (2) 219-9	
					SPRING, LATCH (1) 219-15	
					SPRING, TORSION (1) 219-16	
					TUBE, RUBBER (2) 220-6	
					UP STOP (2) 220-22	
PAOZZ	5340013365923		81834	79-9007-06	HARDWARE KIT, MECHAN.....	1
					COVER, SIDE (1) 80-13	
					LOCKWASHER (3) 80-15	
					LOCKWASHER (4) 80-11	
					NUT, HEX (4) 80-12	
					NUT, HEX (3) 80-14	
					SCREW, TAPPING (4) 80-9	
PAFZZ	4820010341287		45152	82TV196	PARTS KIT, LINEAR DI.....	1
					DIAPHRAGM, VALVE, FLA(1) 159-50	
					FILTER, BRAKE VALVE (1) 159-17	
					GUIDE, VALVE STEM (1) 159-19	
					MOUNT, RESILIENT (1) 159-12	
					NUT, SELF-LOCKING, HE(1) 159-7	
					O-RING (1) 159-30	
					O-RING (1) 159-32	
					PACKING, PREFORMED (1) 159-14	

SECTION II			TM9-2320-302-24P			
(1)	(2)	(3)	(4)	(5)	(6)	(7)
ITEM	SMR			PART		
NO	CODE	NSN	CAGEC	NUMBER	DESCRIPTION AND USABLE ON CODES(UOC)	QTY
					PACKING, PREFORMED	(1) 159-24
					PACKING, PREFORMED	(1) 159-34
					PACKING, PREFORMED	(1) 159-47
					RING, RETAINING	(1) 159-26
					SCREW, FORMING	(1) 159-52
					SEAT, HELICAL COMPRE	(1) 159-21
					SPRING, HELICAL, COMP	(1) 159-15
					SPRING, HELICAL, COMP	(1) 159-22
					SPRING, RELAY	(1) 159-29
					VALVE ASSY, INL/EXH	(1) 159-39
					VALVE, INLET AND EXH	(1) 159-20
					WASHER, RUBBER	(1) 159-16
					WASHER, SPRING TENSI	(1) 159-51

END OF FIGURE

SECTION II			TM9-2320-302-24P			
(1)	(2)	(3)	(4)	(5)	(6)	(7)
ITEM NO	SMR CODE	NSN	CAGEC	PART NUMBER	DESCRIPTION AND USABLE ON CODES(UOC)	QTY
GROUP 95 GENERAL USE STANDARDIZED PARTS						
GROUP 9501 HARDWARE SUPPLIES AND BULK MATERIEL, COMMON						
FIG. BULK						
1	PAFZZ	5975011355919	77060	68237R	CONDUIT.....	V
2	PAOZZ	5975011355917	77060	68240R	CONDUIT.....	V
3	PAFZZ	5975011355941	77060	68236R	CONDUIT 0.413 ID.....	V
4	PAFZZ	5975012439900	77060	64498R	CONDUIT, NONMETALLIC.....	V
5	PAOZZ	5975013431290	64678	48-02217-100	CONDUIT, NONMETALLIC.....	V
6	PAOZZ	5975014790207	77060	48-25360-019	CONDUIT, NON METALLI RED.....	V
7	PAOZZ		24161	4175-3	HOSE 3 IN ID X 3 FT.....	V
8	PAOZZ	4720013553104	64678	48-00101-022	HOSE, METALLIC 1/2".....	V
9	PAOZZ	4720013325973	24161	350357	HOSE, NONMETALLIC.....	V
10	PAOZZ	4720004211279	24161	24224	HOSE, NONMETALLIC.....	V
11	PAOZZ	4720005414243	24161	28430	HOSE, NONMETALLIC.....	V
12	PAOZZ	4720012939313	24161	24240	HOSE, NONMETALLIC SUPPLIED IN 3 FT LENGTHS.....	V
13	PAOZZ	4720013644437	24161	4251-0125	HOSE, NONMETALLIC.....	V
14	PAOZA	4720006827920	98441	881-12	HOSE, NONMETALLIC ROLL OF 25 FT.....	V
15	PAOZZ	4720014786010	24161	4230T-3/8ID	HOSE, NONMETALLIC.....	V
16	PAOZZ	4720012020248	81343	J30R6-TYPE1-3/16 ID	HOSE, NONMETALLIC 3/16 ID.....	1
17	PAOZZ		64678	48-25122-062	HOSE, NONMETALLIC 5/8 ID.....	1
18	PAOZZ		64678	48-25122-075	HOSE, NONMETALLIC 3/4 ID.....	1
19	PAOZZ	4720012841668	12361	7-543-001790	HOSE, NONMETALLIC 2MM ID X 5MM OD... V	
20	PAOZZ	4720012931827	61424	PTF-6B-YEL	HOSE, NONMETALLIC 3/8" O.D.....	1
21	PAOZZ	4720012879313	61424	PFT-6B-RED	HOSE, NONMETALLIC 3/8" RED.....	1
22	PAOZZ	4720013368154	98933	35055	HOSE, NONMETALLIC.....	V
23	PAFZZ	4720013373960	24161	4230NX-5/8	HOSE, NONMETALLIC 3/4" ID.....	V
24	PAFZZ	4720013373961	24161	4230NX-3/4	HOSE, NONMETALLIC.....	V
25	PAOZZ	4720013317810	24161	4230-0174	HOSE, NONMETALLIC.....	V
26	PAOZZ	4720013328491	24161	4230-0002	HOSE, NONMETALLIC.....	V
27	PAOZZ	4720010099058	85757	3250-1010	HOSE, NONMETALLIC.....	V
28	PAOZZ	4720010144915	85757	3250-061	HOSE, NONMETALLIC.....	V
29	PAOZZ	4720010036706	13174	C608-100BLK	HOSE, NONMETALLIC.....	V
30	PAOZZ	4720008481038	24161	24032	HOSE, PREFORMED.....	V
31	PFOZZ	9330012565345	64678	48-02188-001	MOLDING, PLASTIC.....	V
32	PAOZZ	4010002853705	81349	M83420/1-005	ROPE, WIRE.....	1
33	PAOZA	5330002376140	12624	V532X3/4IN, X200FT	SEAL, NONMETALLIC SP.....	V
34	PAOZZ	5330013565086	64678	22-25294-001	SEAL, NONMETALLIC SP.....	V
35	PAOZZ	7510000797604	52152	4516 5/8 IN.	TAPE, PRESSURE SENSI.....	V
36	PAOZZ	4720014786013	19986	468105	TUBING ASSEMBLY, NON 5/8 ID.....	1
37	PAOZZ	4720012675991	61424	PFT-4A BLACKX1300	TUBING, NONMETALLIC 1/4" OD.....	V
38	PAOZZ	4720014470911	29500	4246-02277	TUBING, NONMETALLIC 1/8" COLOR NAT. MILKY.....	V
39	PAOZZ	4720011925261	30327	C602	TUBING, NONMETALLIC 1/8 IN.....	V
40	PAOZZ	4720014786407	87373	PFT-4A-BRN	TUBING, NONMETALLIC 1/4 IN.....	V

SECTION II			TM9-2320-302-24P			
(1)	(2)	(3)	(4)	(5)	(6)	(7)
ITEM	SMR			PART		
NO	CODE	NSN	CAGEC	NUMBER	DESCRIPTION AND USABLE ON CODES(UOC)	QTY
41	PAOZZ	4720012936177	61424	PFT-4A-YEL	TUBING, NONMETALLIC 1/4" OD.....	V
42	PAOZZ	4720012947228	61424	PFT-4A-RED	TUBING, NONMETALLIC 1/4" OD.....	V
43	PAOZZ	4720013491970	61424	PFT-6B-GRN	TUBING, NONMETALLIC 3/8".....	1
44	PAOZZ	4720013643392	98441	PFT-6B-ORG	TUBING, NONMETALLIC 3/8" OD.....	V
45	PAOZZ	4720011829067	61424	PFT-6B-BLK-100	TUBING, NONMETALLIC 3/8 OD.....	V

END OF FIGURE

1
Fig 257 thru Fig 259

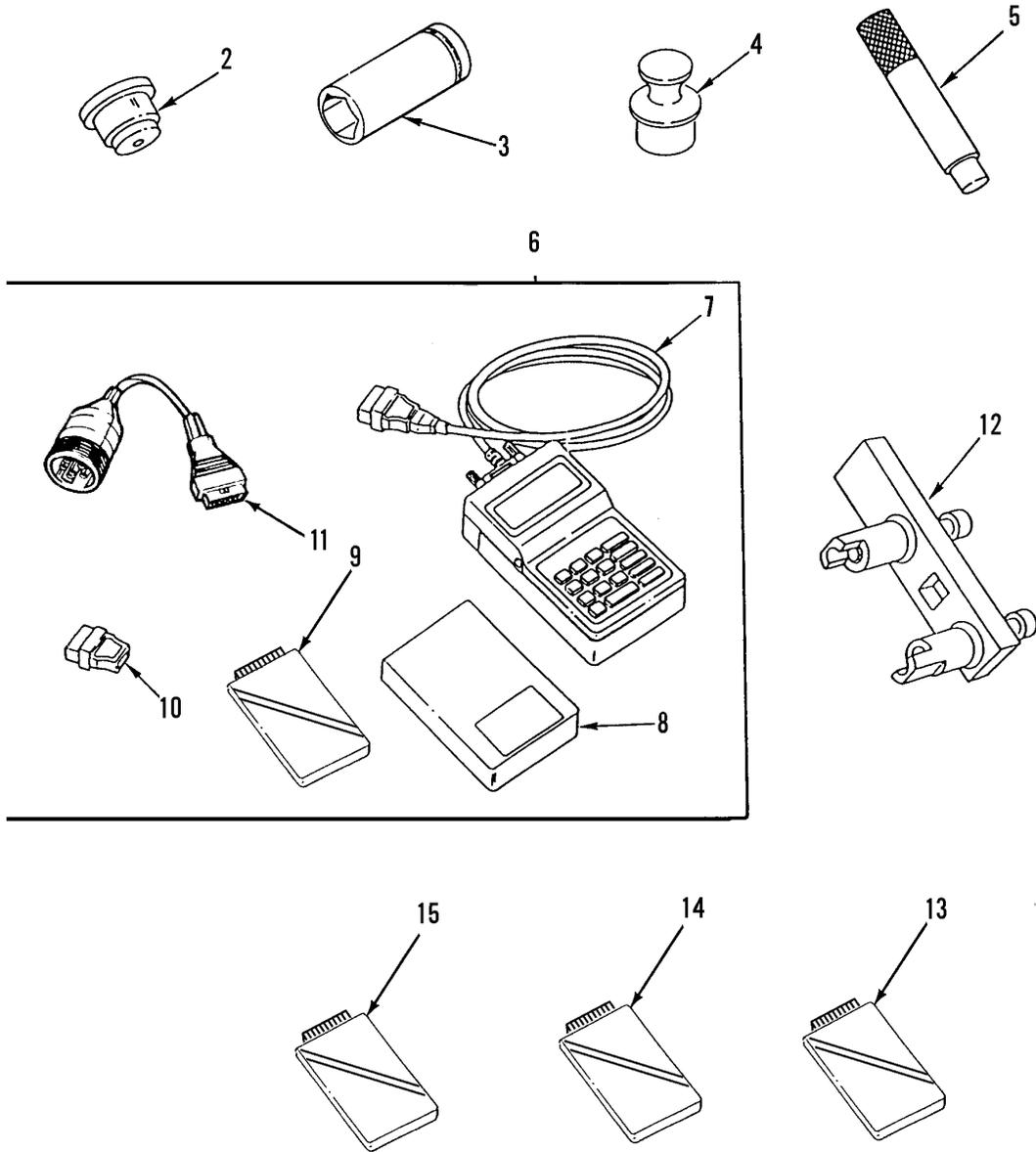

342-1552

Figure 257. Unit Special Tools

SECTION III			TM9-2320-302-24P			
(1)	(2)	(3)	(4)	(5)	(6)	(7)
ITEM NO	SMR CODE	NSN	CAGEC	PART NUMBER	DESCRIPTION AND USABLE ON CODES(UOC)	QTY
GROUP 26 TOOLS AND TEST EQUIPMENT						
GROUP 2604 SPECIAL TOOLS						
FIG. 257 UNIT SPECIAL TOOLS						
1	PEOOO	5180014791630	19207	57K4212	TOOL KIT,GENERAL ME ORGANIZATIONAL TOOL KIT, M915A3 ONLY.....	
2	PEOZZ	5120009775579	33287	J8550	.INSTALLER,SEAL.....	
3	PEOZZ	5130013898450	55719	BWD482	.SOCKET,SOCKET WRENC.....	
4	PEOZZ	5220013574913	74410	TF-0237	.GAGE,PROFILE.....	
5	PEOZZ	5120009775578	33287	J7079-2	.HANDLE,DRIVER.....	
6	PEODD		33287	J 38500-H	.TESTER,INTERNAL COM USE WITH DDEC III OR IV ENGINES.....	
7	PEODD		33287	J-38500-1A	..TESTER,INTERNAL COM INCLUDES READER, CABLE P/N J 38500-2 & STORAGE BOX P/N J38500-25....	
8	PEOZZ		33287	J38500-1500C	..PC CARD ADAPTER PRO-LINK PC CARD ADAPTER.....	
9	PEOZZ		33287	J 38500-2300D	..CARD,SOFTWARE PRO-LINK ENGINE PC CARD FOR DDEC III & IV.....	
10	PEOZZ	5935013532532	33287	J 34812-1	..ADAPTER,ELECTRICAL.....	
11	PEOZZ	5935014777230	45225	J-38500-60A	.ADAPTER,CONNECTOR.....	
12	PEOZZ	5120013222358	33287	J35687	.TESTER,IMPELLER AND.....	
13	PEOOO		33287	J-38500-4100	CARD,SOFTWARE PRO-LINK PC CARD FOR ABS.....	
14	PEOZZ		33287	J-38500-1300E	CARD,SOFTWARE PRO-LINK PC CARD FOR CTIS & VORAD.....	
15	PEOZZ		33287	J38500-1800	CARD,SOFTWARE PRO-LINK TRANSMISSION PC CARD.....	

END OF FIGURE

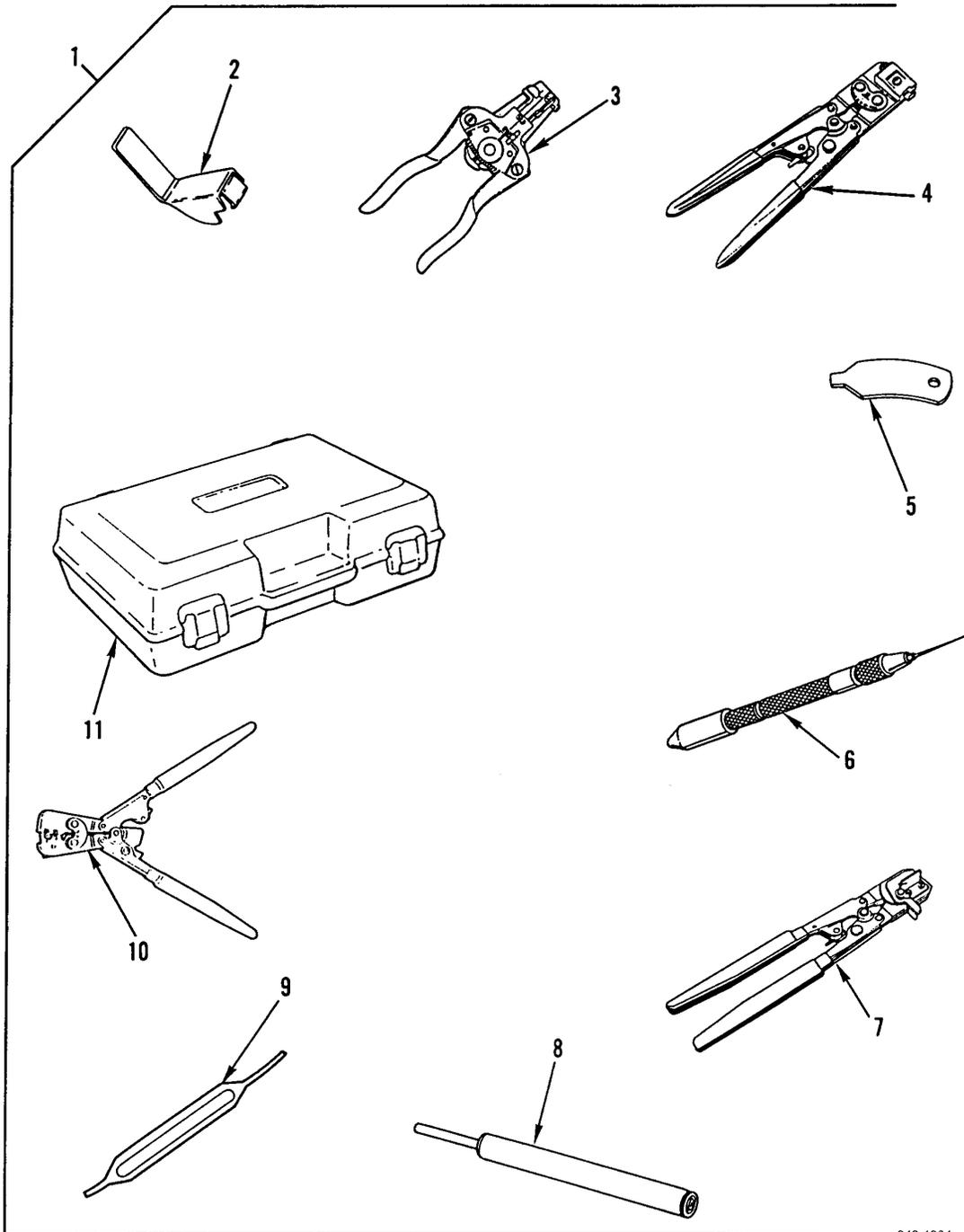

342-1364

Figure 258. Unit Special Tools

SECTION III			TM9-2320-302-24P		(6)	(7)
(1)	(2)	(3)	(4)	(5)		
ITEM	SMR			PART		
NO	CODE	NSN	CAGEC	NUMBER	DESCRIPTION AND USABLE ON CODES(UOC)	QTY
GROUP 2604 SPECIAL TOOLS						
FIG. 258 UNIT SPECIAL TOOLS						
1	PEOZZ	5180013585231	33287	J 35888-60	.TOOL KIT,INTERNAL C.....	
2	PEOZZ	5120013553011	33287	J 35889-A	..REMOVER,PROM.....	
3	PEOZZ	5110013550848	33287	J 35615	..STRIPPER,WIRE,HAND.....	
4	PEOZZ	5120013550844	33287	J 35123	..CRIMPING TOOL,TERMI.....	
5	PEOZZ	5120013553012	33287	J 38384	..REMOVER,CONNECTOR.....	
6	PEOZZ	5120013572937	33287	J 35689-A	..REMOVER,ELECTRICAL.....	
7	PEOZZ	5120013550845	33287	J 35688	..CRIMPING TOOL,TERMI.....	
8	PEOZZ	5180013532518	33287	J 28742-A	..TOOL,TERMINAL REMOV.....	
9	PEOZZ	5120013532534	33287	J 33095	..REMOVER,ELECTRICAL.....	
10	PEOZZ	5120013554178	33287	J 35606	..CRIMPING TOOL,TERMI.....	
11	PEOZZ	5140013553013	33287	J 35547	..CASE,TOOL AND ACCES.....	

END OF FIGURE

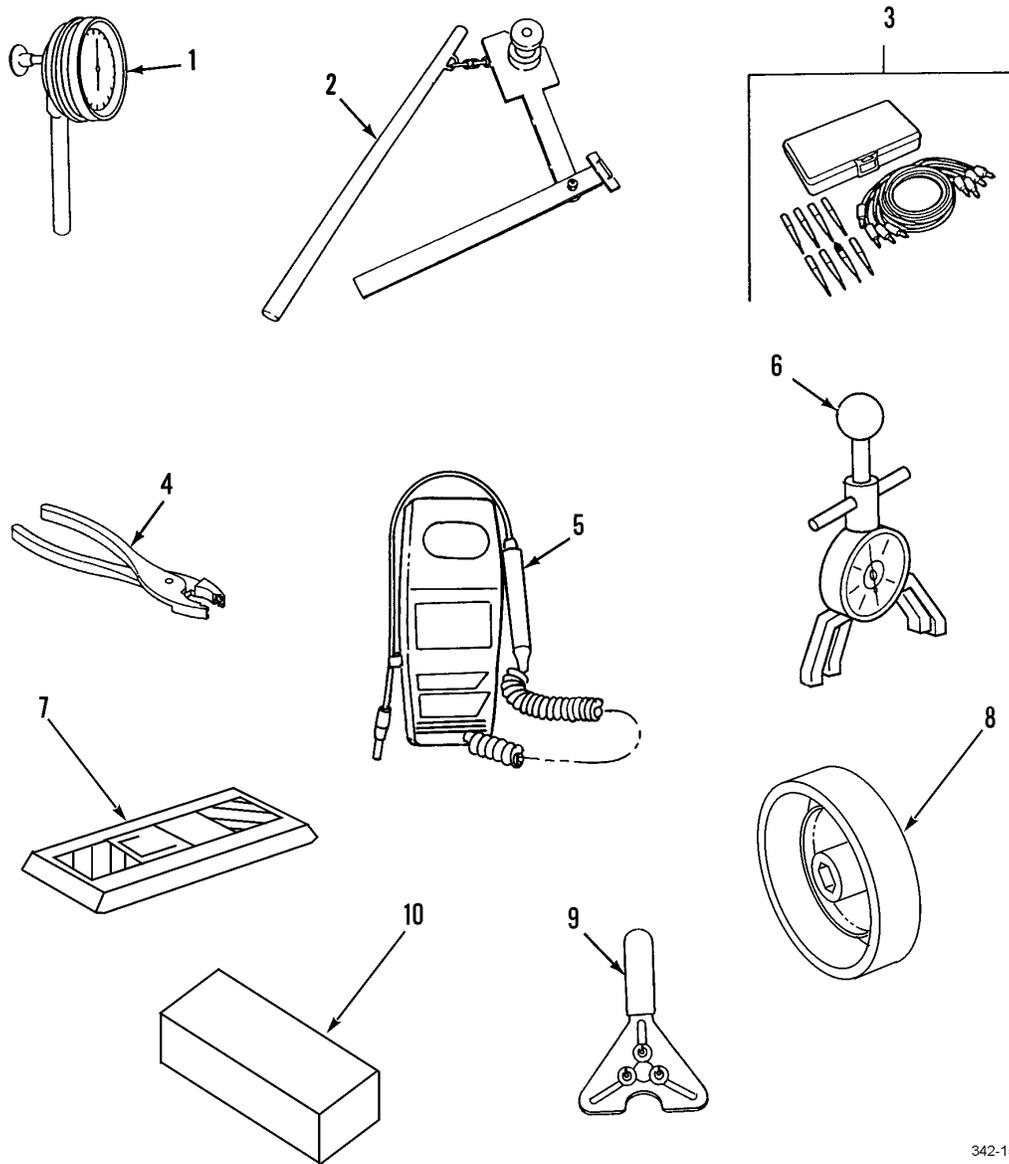

342-1554

Figure 259. Unit Special Tools

SECTION III			TM9-2320-302-24P			
(1)	(2)	(3)	(4)	(5)	(6)	(7)
ITEM	SMR			PART		
NO	CODE	NSN	CAGEC	NUMBER	DESCRIPTION AND USABLE ON CODES(UOC) QTY	
GROUP 2604 SPECIAL TOOLS						
FIG. 259 UNIT SPECIAL TOOLS						
1	PEOZZ	5210004029619	33287	J7872		.INDICATOR,DIAL.....
2	PEOZZ	4910011573571	74410	TFTLN-1000		.TESTER,KINGPIN LOCK.....
3	PEOZZ	6150013542604	33287	J 35751		.WIRING HARNESS.....
4	PEOZZ	5120005373375	55719	HCP48A		.PLIERS,SLIP JOINT.....
5	PEOZZ	4940013870948	07295	16500		.LEAK DETECTOR,REFRI.....
6	PEOZZ	6635010933710	33287	BT-33-73F		.TENSIO METER,DIAL IN.....
7	PEOZZ		33287	J38460-A		.LEVEL,ELECTRONIC.....
8	PEOZZ	5120014794986	4N501	107119		.INSERTER,RING,ABS ABS TONE RINGS..
9	PEOZZ	5120014390305	07BE6	99-499		.HOLDER,CLUTCH.....
10	PEOZZ		72582	J-42431-ECD		DDEC DIAGNOSTIC SET.....
11	PEOZZ		72582	J-42431-ECD		.DDEC DIAGNOSTIC SET.....
11	XDOZZ		72582	J-39877-3		..DDEC DIAGNOSTIC CD.....
12	XDOZZ		72582	J-38351-25		..PC ADAPTER.....
13	XDOZZ		72528	J-42375-6		..PC CABLE.....
14	XDOZZ		72582	J-38351-30		..DDEC IV GENDER CHAR.....
15	XDOZZ		72582	J-42375-5		..PC INTERFACE ADAPTE.....
16	XDOZZ		72582	J-38500-96-A		..DDEC IV TRUCK ADAPT.....
17	XDOZZ		72582	J-38351-15		..DDEC IV PC ADAPTER.....

END OF FIGURE

1
Fig 260 thru Fig 265

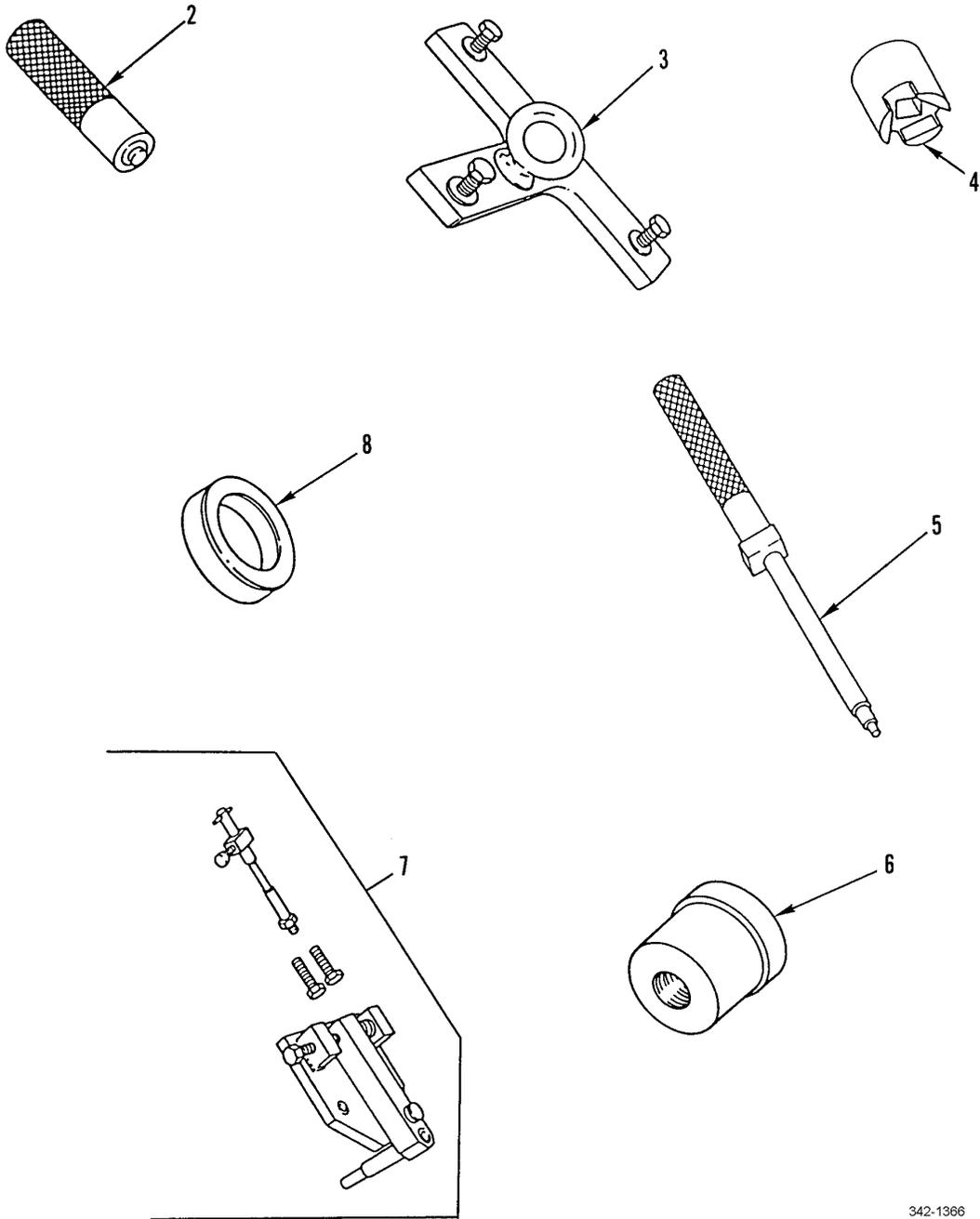

342-1366

Figure 260. Direct Support Special Tools

SECTION III			TM9-2320-302-24P			
(1)	(2)	(3)	(4)	(5)	(6)	(7)
ITEM	SMR			PART		
NO	CODE	NSN	CAGEC	NUMBER	DESCRIPTION AND USABLE ON CODES(UOC)	QTY

GROUP 2604 SPECIAL TOOLS

FIG. 260 DIRECT SUPPORT SPECIAL TOOLS

1	PEFFF	5180014791631	19207	57K4213	TOOL KIT,GENERAL ME DS TOOL KIT, M915A3 ONLY.....	
2	PEFZZ	5120013334744	33287	J36326	.INSTALLER,CUP PLUG.....	
3	PEFZZ	3940013244713	33287	J35641	.CLAMP,MATERIAL LIFT.....	
4	PEFZZ	5120013387182	33287	J25447-B	.INSERTER AND REMOVE.....	
5	PEFZZ	5220013196604	33287	J35637	.GAGE,PROFILE.....	
6	PEFZZ	5120013532521	33287	PT 4365-1	.DRIVER,BUSHING.....	
7	PEFZZ	5120013228885	33287	J35596	.ADJUSTER,LASH,CAM-I.....	
8	PEFZZ	5120013221132	33287	J35949	.INSERTER,GEAR.....	

END OF FIGURE

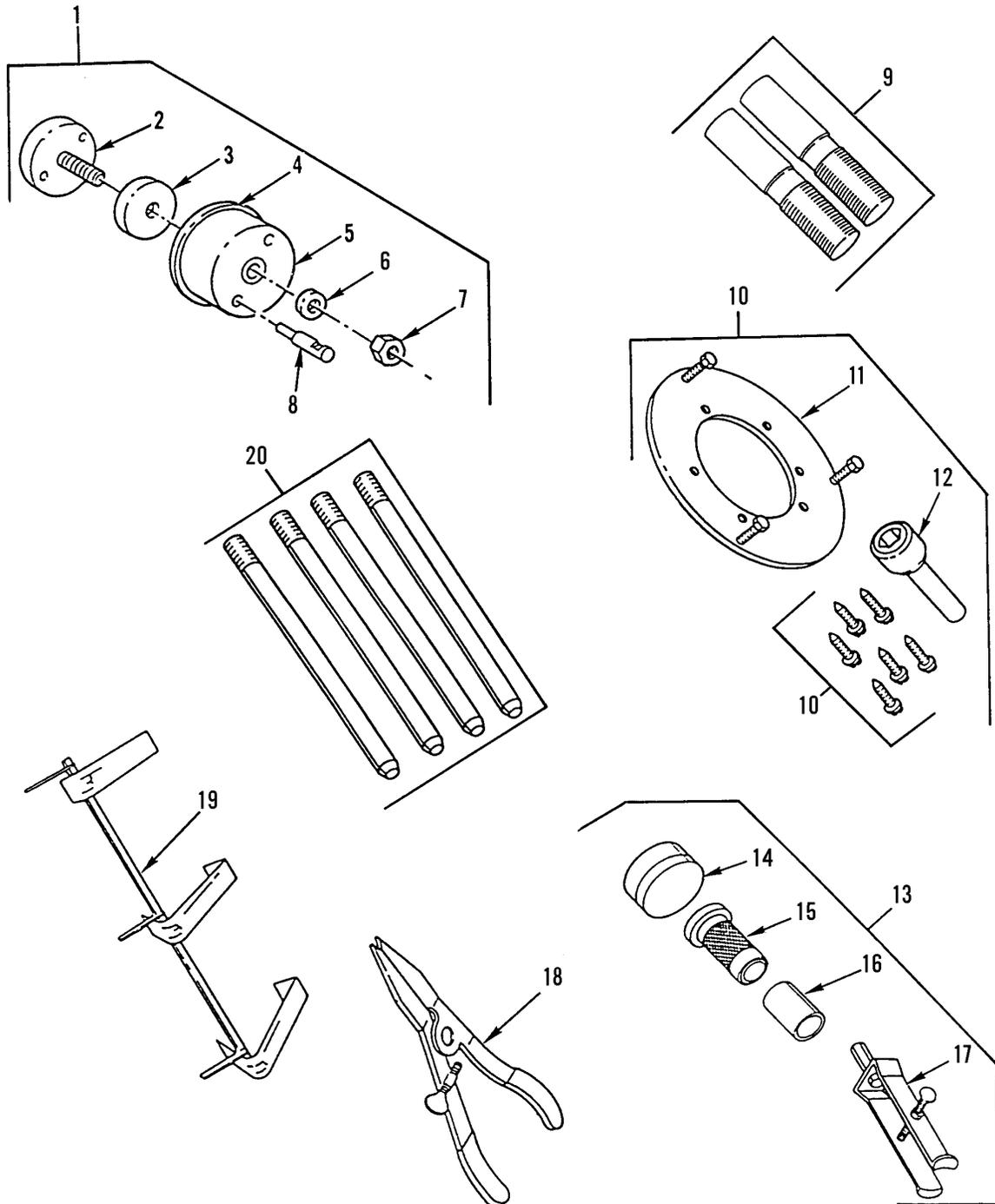

342-1555

Figure 261. Direct Support Special Tools

SECTION III			TM9-2320-302-24P			
(1)	(2)	(3)	(4)	(5)	(6)	(7)
ITEM	SMR			PART		
NO	CODE	NSN	CAGEC	NUMBER	DESCRIPTION AND USABLE ON CODES(UOC) QTY	
GROUP 2604 SPECIAL TOOLS						
FIG. 261 DIRECT SUPPORT SPECIAL TOOLS						
1	PEFZZ	5120013221129	33287	J35686		.INSERTER,SEAL.....
2	PEFZZ	5120013538568	33287	J-35686-1		..INSERTER,SEAL.....
3	PEFZZ	5120013545674	33287	J-35686-6		..INSERTER,SEAL 0.670 THK.....
3	PEFZZ	5365014752572	33287	J35686-11		..SPACER,STRAIGHT 0.375 THK.....
4	PEFZZ	5310014748888	33287	J35686-10		..WASHER,SEAL 6.050 ID.....
4	PEFZZ	5310014748891	33287	J35686-20		..WASHER,SEAL 5.858 ID.....
5	PEFZZ	5120013538569	33287	J-35686-4		..INSERTER AND REMOVE.....
6	PEFZZ	3110001204464	21760	CS791		..BEARING,BALL,THRUST.....
7	PEFZZ	5310013574594	33287	J-35686-3		..NUT,PLAIN,HEXAGON.....
8	PEFZZ	5120013542944	33287	J-35686-2		..INSERTER,STUD.....
9	PEFZZ	5315013332771	33287	J36235		..PIN,SHOULDER,HEADLE.....
10	PEFZZ	5120013221131	33287	J35993		..REMOVER,SEAL.....
11	PEFZZ	5120013591234	33287	J-35993-1		..PULLER PLATE,SEAL R.....
12	PEFZZ	5120013542770	33287	J-35993-5		..NUT,DRIVER.....
13	PEFZZ	5120013226222	33287	J36310		..INSERTER AND REMOVE.....
14	PEFZZ	5120013540470	33287	J 36310-2		..INSTALLATION TOOL,S.....
15	PEFZZ	5120013537060	33287	J 36310-1		..INSTALLATION TOOL,B.....
16	PEFZZ	5120013545673	33287	J-36310-9		..INSERTER,BEARING AN.....
17	PEFZZ	4910011796364	25341	J26941		..PULLER,DRIVE SPROCK.....
18	PEFZZ	5120013226888	33287	J36347		..PLIERS,RETAINING RI.....
19	PEFZZ	5120013226116	33287	J35996		..LIFTER,ROCKER ARM.....
20	PEFZZ	5120013223505	33287	J36107		..GUIDE STUD SET.....

END OF FIGURE

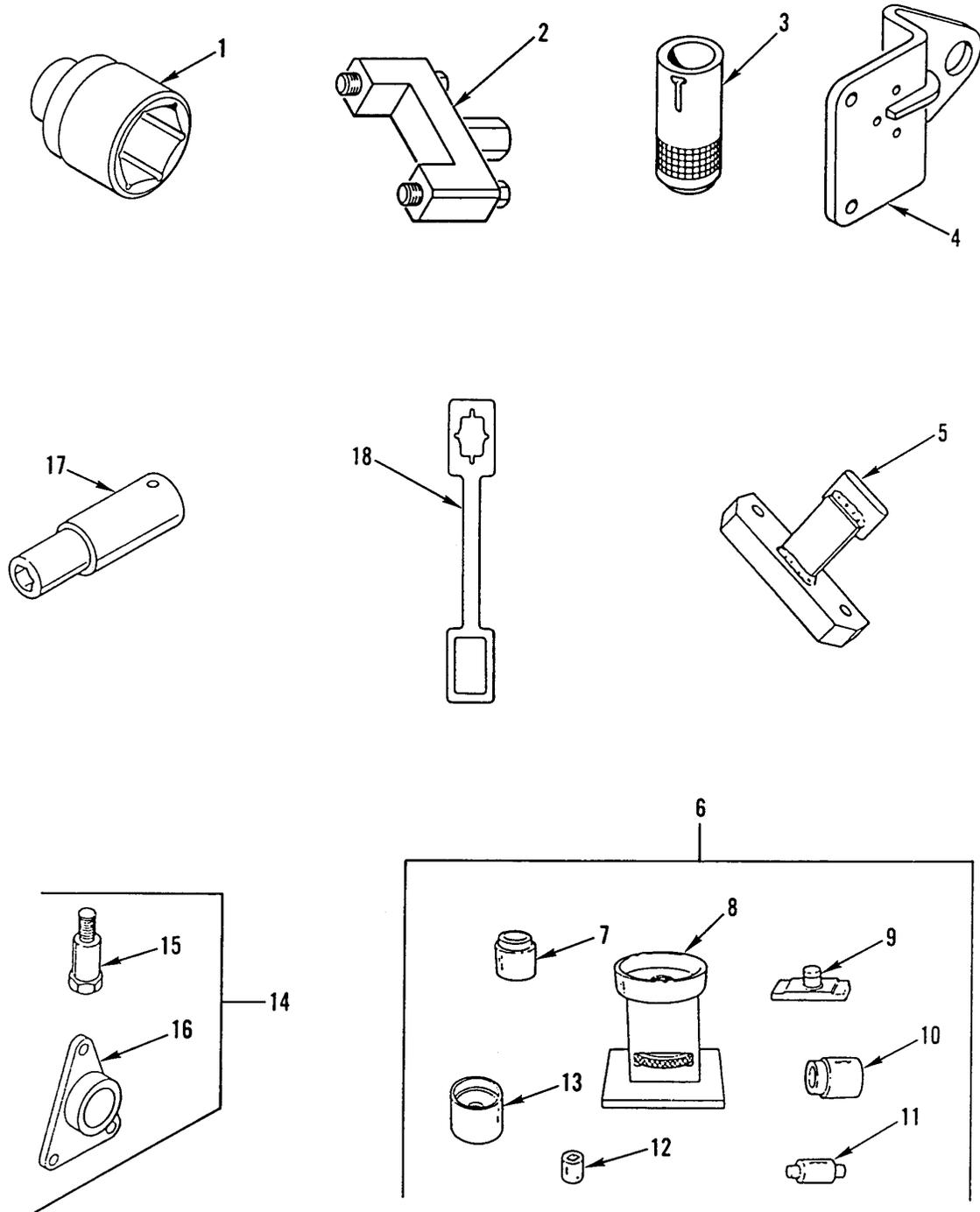

342-1367

Figure 262. Direct Support Special Tools

SECTION III			TM9-2320-302-24P			
(1)	(2)	(3)	(4)	(5)	(6)	(7)
ITEM	SMR			PART		
NO	CODE	NSN	CAGEC	NUMBER	DESCRIPTION AND USABLE ON CODES(UOC) QTY	
GROUP 2604 SPECIAL TOOLS						
FIG. 262 DIRECT SUPPORT SPECIAL TOOLS						
1	PEFZZ	5120014371725	55719	L883		. SOCKET, SOCKET WRENC.....
2	PEFZZ	5120013223498	33287	J36237		. BARRING TOOL, ENGINE.....
3	PEFZZ	5120010544048	33287	J24202-4		. HANDLE, DRIVER.....
4	PEFZZ	5120011166049	33287	J-24365		. LIFTING BRACKET, FLY.....
5	PEFZZ	3040013190848	33287	J35652		. PLATE, RETAINING, SHA.....
6	PEFZZ	5120013226115	33287	J35988-B		. SERVICE KIT, WATER P.....
7	PEFZZ	5120013542769	33287	J-35998-18		. .SUPPORT, DR SHAFT.....
8	PEFZZ	5120013538514	33287	J 35988-2		. .FIXTURE, HOLDING.....
9	PEFZZ	5120013542771	33287	J-35988-14		. .IMPELLER, INSTALLER.....
10	PEFZZ	5120013537059	33287	J 35988-1		. .INSTALLATION TOOL, B.....
11	PEFZZ	5120013542768	33287	J-35988-3A		. .EXTENSION, SHAFT.....
12	PEFZZ	5120013542772	33287	J-35988-15		. .HOLDER, SHAFT SOCKET.....
13	PEFZZ	5120013540469	33287	J 35517-1		. .INSTALLATION TOOL, S.....
14	PEFZZ	5120013223508	33287	J35906		. PILOT, CAM GEAR.....
15	PEFZZ	5120013662545	33287	J-35906-4		. .CAM GEAR PILOT THRUST REMOVAL TOOL.....
16	XAFZZ		33287	J-35906-1.		. .PLATE, CAM PILOT.....
17	PEFZZ	5120013221123	33287	J36003		. SOCKET, SOCKET WRENC.....
18	PEFZZ	5120014550436	33287	J 3453-1		. HOLDING BAR, PINION.....

END OF FIGURE

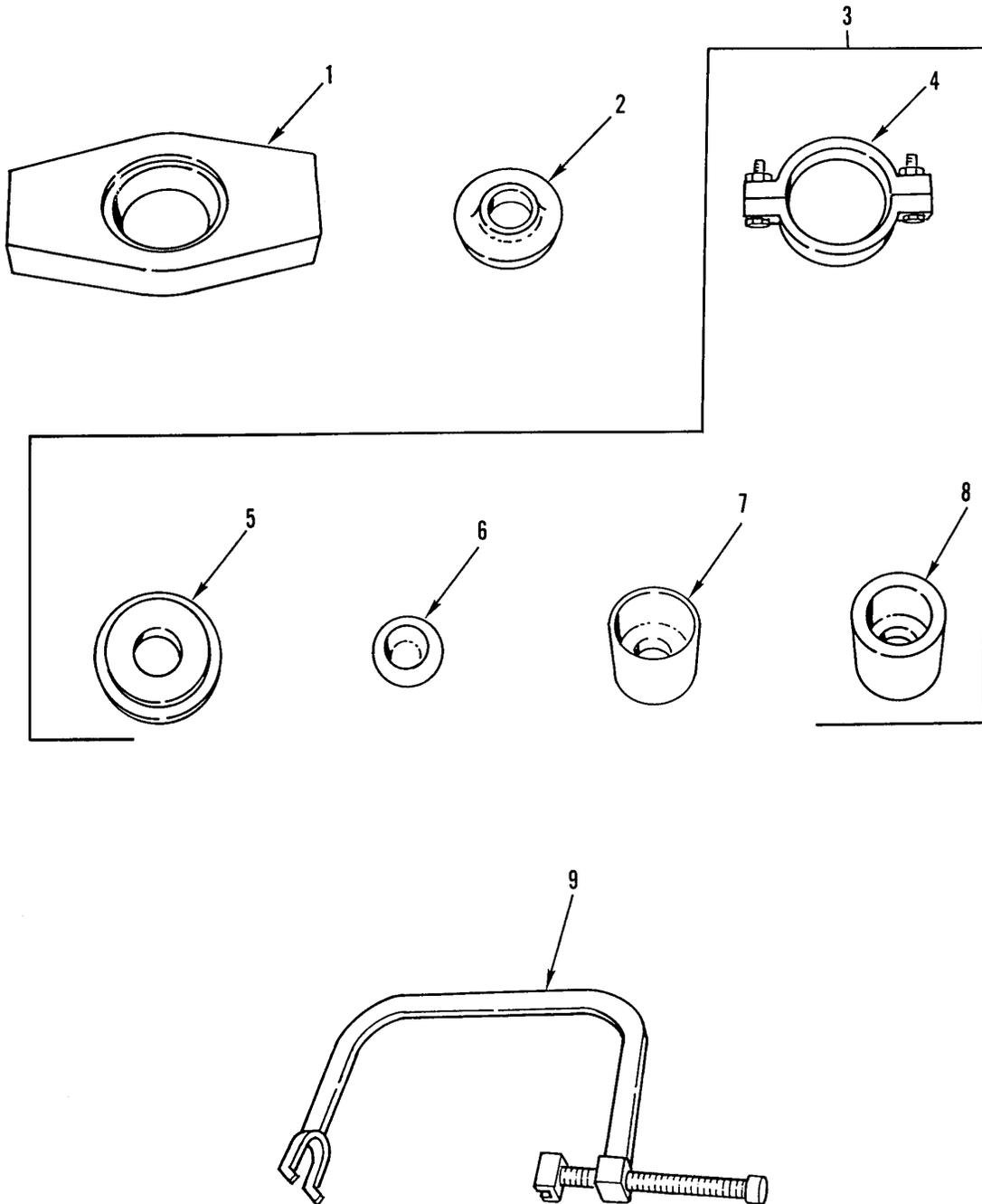

342-1368

Figure 263. Direct Support Special Tools

SECTION III			TM9-2320-302-24P			
(1)	(2)	(3)	(4)	(5)	(6)	(7)
ITEM	SMR			PART		
NO	CODE	NSN	CAGEC	NUMBER	DESCRIPTION AND USABLE ON CODES(UOC) QTY	
GROUP 2604 SPECIAL TOOLS						
FIG. 263 DIRECT SUPPORT SPECIAL TOOLS						
1	PEFZZ	5120013570743	45225	51100		.PRESS PLATE,BUSHING.....
2	PEFZZ	5120013568911	45225	302030		.REMOVING ADAPTER,BU.....
3	PEFZZ	4940013866108	45225	1764		.TOOL SET,BUSHING BE.....
4	PEFZZ	5342010844459	45225	42052		..CLAMP.....
5	PEFZZ	5120013570741	45225	206459		..CLAMP PLATE,BUSHING.....
6	PEFZZ	5120013570740	45225	206457		..PRESS ADAPTER,BUSHI.....
7	PEFZZ	5120013570742	45225	302027		..REMOVING ADAPTER,BU.....
8	PEFZZ	5120013592857	45225	302026		..INSERTER,BEARING AN.....
9	PEFZZ	4910011656015	74410	TFTLN-2500		.SLIDER,SPRING COMPR.....

END OF FIGURE

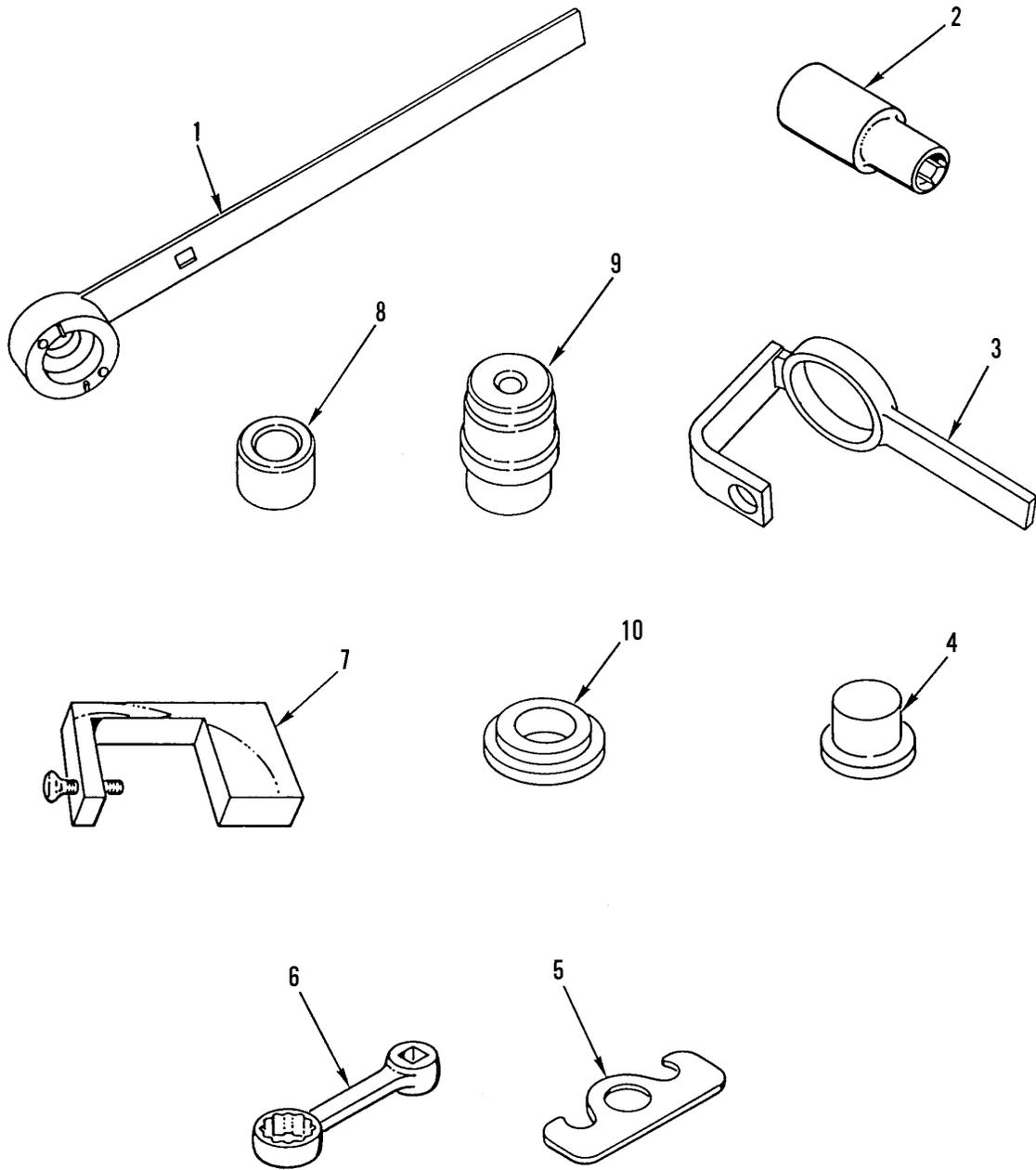

Figure 264. Direct Support Special Tools

SECTION III			TM9-2320-302-24P			
(1)	(2)	(3)	(4)	(5)	(6)	(7)
ITEM	SMR			PART		
NO	CODE	NSN	CAGEC	NUMBER	DESCRIPTION AND USABLE ON CODES(UOC)	QTY
GROUP 2604 SPECIAL TOOLS						
FIG. 264 DIRECT SUPPORT SPECIAL TOOLS						
1	PEFZZ	5120013717369	33287	J 37070	.ADJUSTING TOOL,WORM.....	
2	PEFZZ	5120013554791	76377	XE-16	.SOCKET, SOCKET WRENC.....	
3	PEFZZ	5120013538490	33287	J 37464	.SPANNER ATTACHMENT,.....	
4	PEFZZ	5120013571599	45225	38095	.REMOVING ADAPTER,BU.....	
5	PEFZZ	3940013549446	45225	38841	.SPREADER, SLING.....	
6	PEFZZ	5120002158200	26848	BX15-16	.ADAPTER, TORQUE WREN.....	
7	PEFZZ	5120013532520	33287	J 38662	.CHECKER, GEAR LASH.....	
8	PEFZZ	5120013540468	33287	J 37073	.INSTALLATION TOOL, S.....	
9	PEFZZ	5120013542943	33287	J 37071	.INSERTER, BEARING AN.....	
10	PEFZZ	5120013574583	45225	204266	.INSERTER, BEARING AN.....	

END OF FIGURE

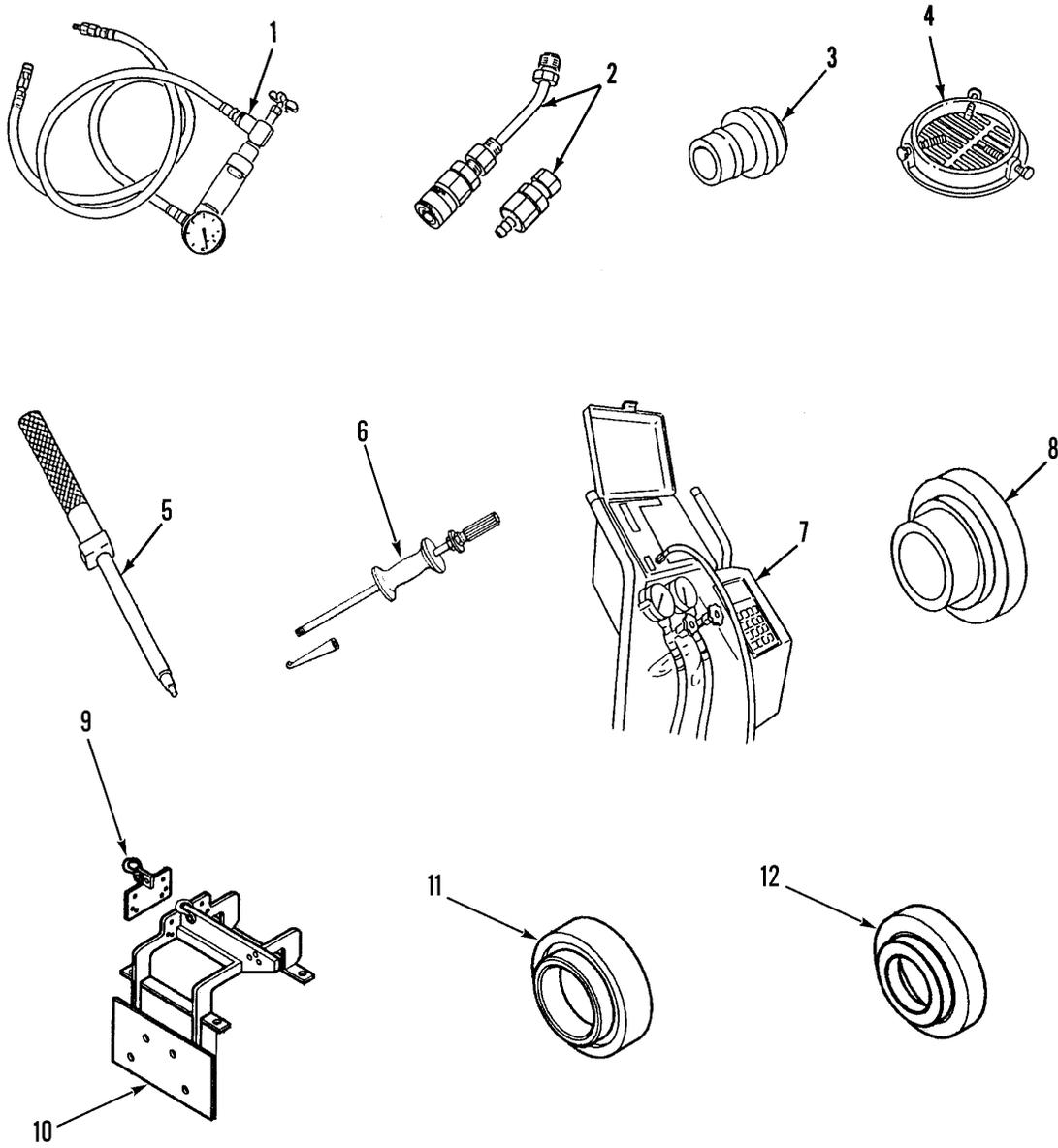
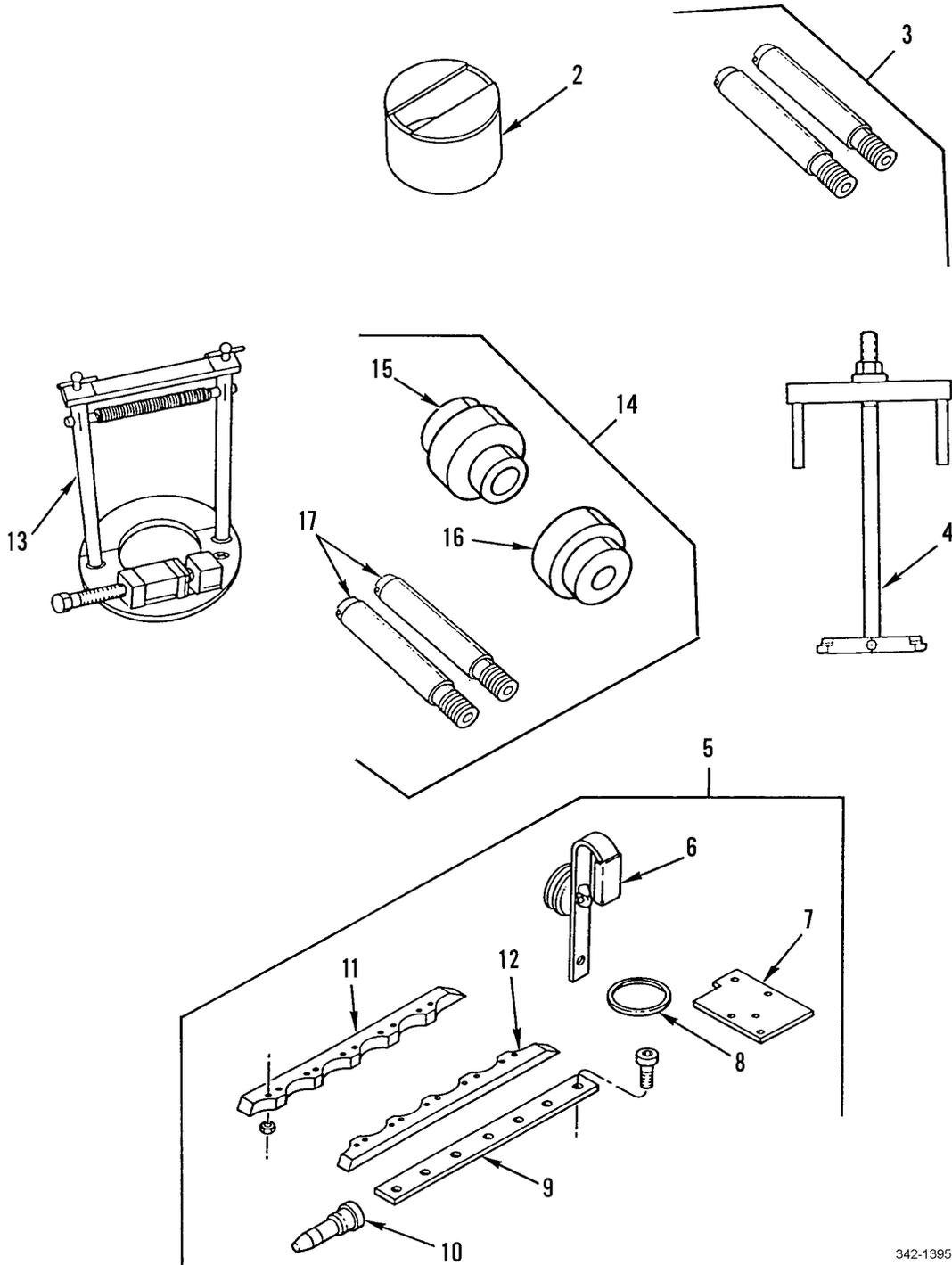

Figure 265. Direct Support Special Tools

SECTION III			TM9-2320-302-24P			
(1)	(2)	(3)	(4)	(5)	(6)	(7)
ITEM	SMR			PART		
NO	CODE	NSN	CAGEC	NUMBER	DESCRIPTION AND USABLE ON CODES(UOC)	QTY
GROUP 2604 SPECIAL TOOLS						
FIG. 265 DIRECT SUPPORT SPECIAL TOOLS						
1	PEFZZ	4910011603618	33287	J-26487-B	.TESTER,POWER STEERI.....	
2	PEFZZ	4940013537038	33287	J 28593	.ADAPTER KIT,MECHANI.....	
3	PEFZZ	5120010544042	33287	J-24202-1A	.INSERTER,SEAL.....	
4	PEFZZ	4910011277959	33287	J26554-A	.SHIELD,TURBO PROTEC.....	
5	PEFZZ	5220014400686	33287	J39697	.GAGE,PROFILE.....	
6	PEFZZ	5180010482153	33287	J24171A	.PULLER KIT,UNIVERSA.....	
7	PEFZZ	6685014385088	33287	J38509	.TEST SET SUBASSEMBL.....	
8	PEFZZ	5120014526036	33287	J 43172	.INSERTER,SEAL.....	
9	PEFZZ	5340014753497	33287	J41445	.BRACKET,MOUNTING.....	
10	PEFZZ	2590014757886	33287	J35926-A	.BRACKET,VEHICULAR C.....	
11	PEFZZ		33287	J37032	.INSERTER,SEAL.....	
12	PEFZZ		33287	J37031	.INSERTER,SEAL.....	

END OF FIGURE

1
Fig 266 thru Fig 271



342-1395

Figure 266. General Support Special Tools

SECTION III			TM9-2320-302-24P			
(1)	(2)	(3)	(4)	(5)	(6)	(7)
ITEM	SMR			PART		
NO	CODE	NSN	CAGEC	NUMBER	DESCRIPTION AND USABLE ON CODES(UOC)	QTY
GROUP 2604 SPECIAL TOOLS						
FIG. 266 GENERAL SUPPORT SPECIAL TOOLS						
1	PEHHH	5180014791626	19207	57K4214	TOOL KIT,GENERAL ME GS TOOL KIT, M915A3 ONLY.....	
2	PEHZZ	2815013219248	33287	J35994	.PROTECTOR,CRANKSHAF.....	
3	PEHZZ	5120013223503	33287	J35785	.ALIGNMENT STUD SET.....	
4	PEHZZ	5120013221128	33287	J35791	.PULLER,MECHANICAL.....	
5	PEHZZ	4910013196990	33287	J36223-D.	.TESTER,CYLINDER COM.....	
6	PEHZZ	5180013532523	33287	J 36223-7	..TEST SET,HEAD.....	
7	PEHZZ	5340013538466	33287	J 35984-2	..COVER,ACCESS.....	
8	PEHZZ	5180013537041	33287	J 36223-4	..HOLDER,LINER.....	
9	PEHZZ	5180013537042	33287	J 36223-1	..BARS,LINEAR HOLDING.....	
10	PEHZZ	5340013538575	33287	J 35984-1	..PLUG,PROTECTIVE,DUS.....	
11	PEHZZ	5340013538467	33287	J 36223-3A	..COVER,ACCESS.....	
12	PEHZZ	5180013538516	33287	J 36223-2	..PLATE,WATER COVER.....	
13	PEHZZ	4910011583996	33287	J 26598-A	.REMOVER,SNAPRING.....	
14	PEHZZ	5120013222359	33287	J35653	.INSTALLER SET,CUP P.....	
15	PEHZZ	5120013542773	33287	J-35653-1	..PLUG,INSTALLER.....	
16	PEHZZ	5120013542774	33287	J-35653-2	..PLUG,INSTALLER.....	
17	PEHZZ	5315014755229	33287	J43431	..PIN,STRAIGHT,THREAD.....	

END OF FIGURE

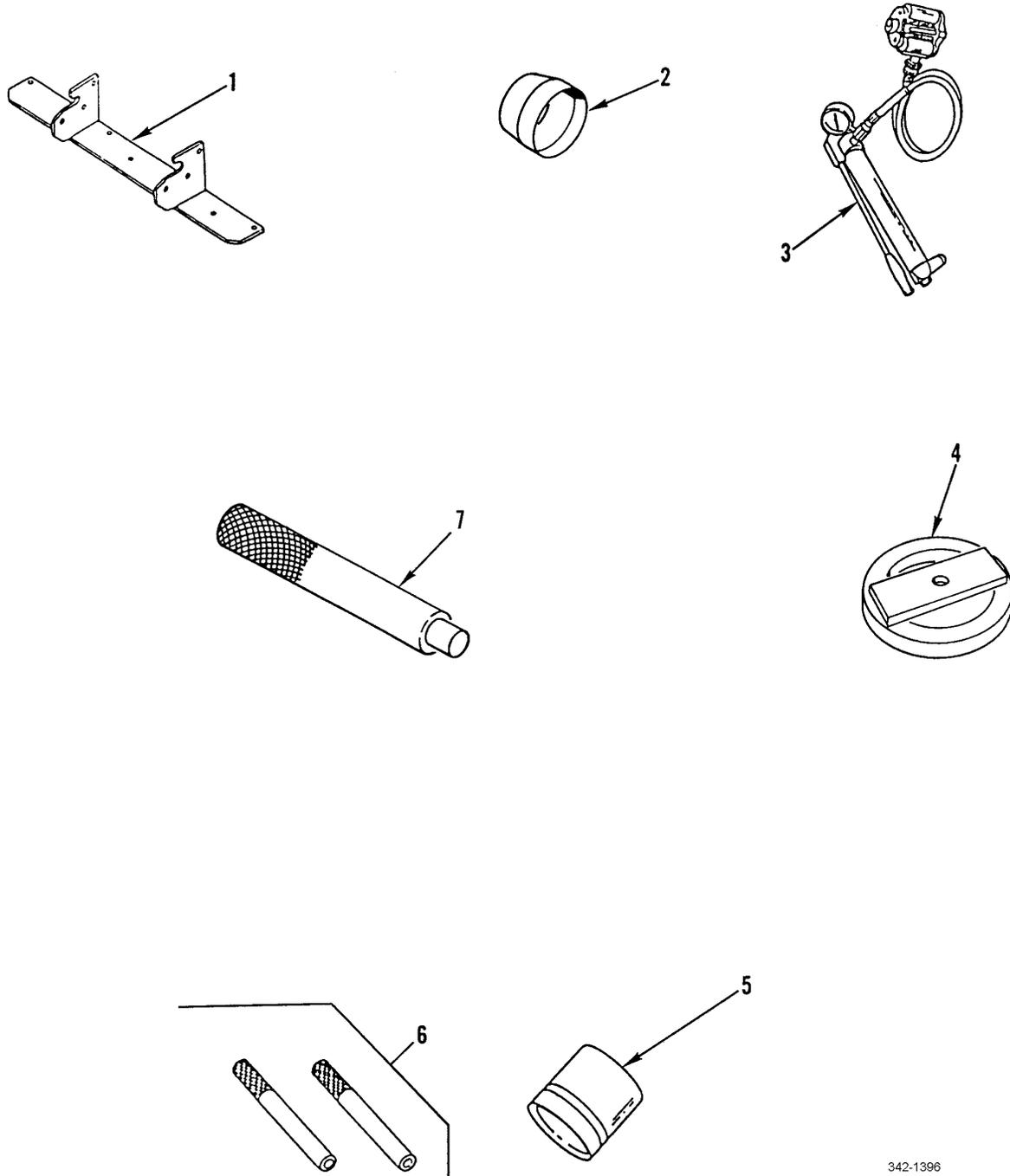

342-1396

Figure 267. General Support Special Tools

SECTION III			TM9-2320-302-24P			
(1)	(2)	(3)	(4)	(5)	(6)	(7)
ITEM	SMR			PART		
NO	CODE	NSN	CAGEC	NUMBER	DESCRIPTION AND USABLE ON CODES(UOC)	QTY
GROUP 2604 SPECIAL TOOLS						
FIG. 267 GENERAL SUPPORT SPECIAL TOOLS						
1	PAHZZ	2510013208905	33287	J35636	.BRACKET,ENGINE MOUN.....	
2	PEHZZ	5120010482156	33287	J24210	.PROTECTOR,SEAL.....	
3	PEHZZ	4320013204618	33287	J35951-175	.PUMP,HYDRAULIC RAM,.....	
4	PEHZZ	5120010482159	33287	J24204-3	.COMPRESSOR,CLUTCH S.....	
5	PEHZZ	5120013538567	33287	J 35598	.COMPRESSOR,PISTON R.....	
6	PEHZZ	5120013538515	33287	J 35945	.GUIDES,CONNECT ROD.....	
7	PEHZZ	5120006772259	33287	J8092	.HANDLE,DRIVE.....	

END OF FIGURE

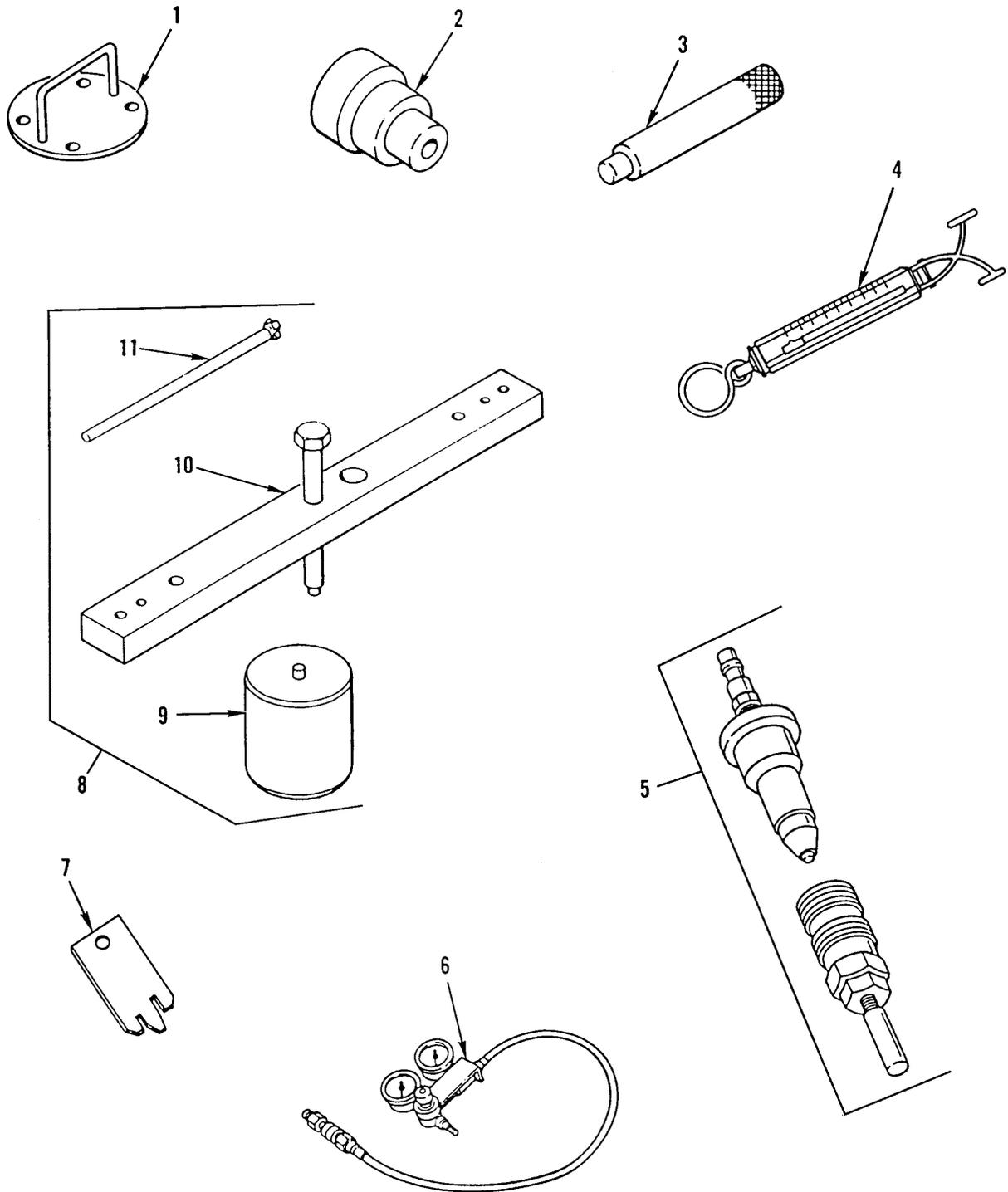

342-1397

Figure 268. General Support Special Tools

SECTION III			TM9-2320-302-24P			
(1)	(2)	(3)	(4)	(5)	(6)	(7)
ITEM	SMR			PART		
NO	CODE	NSN	CAGEC	NUMBER	DESCRIPTION AND USABLE ON CODES(UOC) QTY	

GROUP 2604 SPECIAL TOOLS

FIG. 268 GENERAL SUPPORT SPECIAL TOOLS

1	PEHZZ	3460013195533	33287	J35651		.PLATE,INDEXING FIXT.....
2	PEHZZ	5120011151160	33287	J-24197		.INSERTER,BEARING AN.....
3	PEHZZ	5120011151161	33287	J-26282		.INSERTER,SEAL.....
4	PEHZZ	4910007796832	33287	J8129		.SCALE,TENSION.....
5	PEHZZ	4910013196971	33287	J38768-A		.ADAPTER,CYLINDER CO.....
6	PEHZZ	4910013204638	33287	J29006-5		.TESTER,CYLINDER COM.....
7	PEHZZ	5220013374412	33287	J38609		.GAGE,PROFILE.....
8	PEHZZ	5120011165016	33287	J-24208-D		.FIXTURE,SNAP RING A.....
9	PEHZZ	4310012477126	33287	J24208-2		..CYLINDER SLEEVE.....
10	PEHZZ	4910011583972	33287	J24208-3		..PLATE,PRESSURE,COMP.....
11	PEHZZ	5220011583999	33287	J24208-13		..GAGE,SNAPRING.....

END OF FIGURE

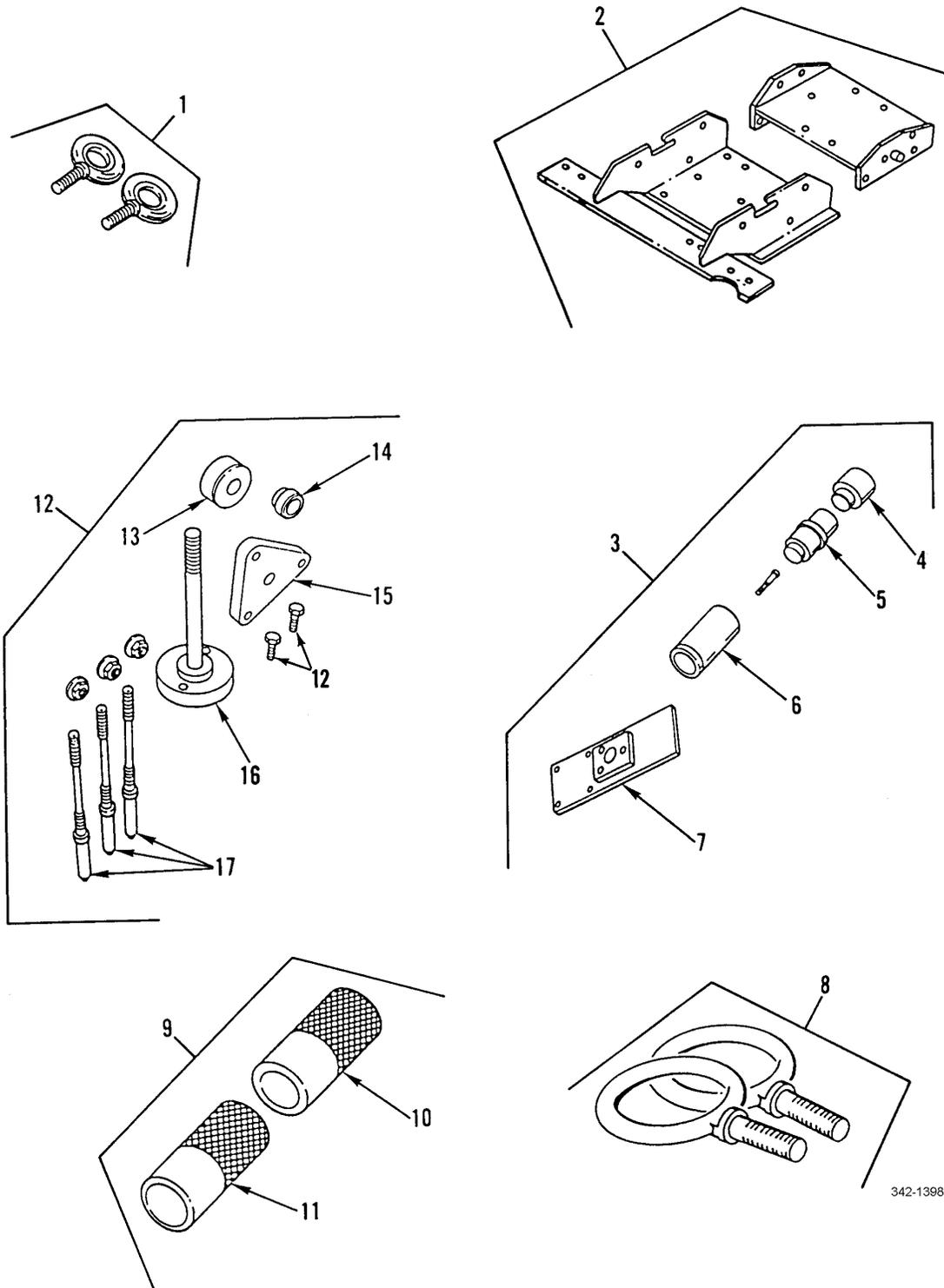

342-1398

Figure 269. General Support Special Tools

SECTION III			TM9-2320-302-24P			
(1)	(2)	(3)	(4)	(5)	(6)	(7)
ITEM	SMR			PART		
NO	CODE	NSN	CAGEC	NUMBER	DESCRIPTION AND USABLE ON CODES(UOC) QTY	
GROUP 2604 SPECIAL TOOLS						
FIG. 269 GENERAL SUPPORT SPECIAL TOOLS						
1	PEHZZ	5306013191987	33287	J35595	.BOLT,EYE CYLINDER BLOCK LIFT TOOL.	
2	PEHZZ	3950013196973	33287	J35635	.ADAPTER,MOTOR,HOIST.....	
3	PEHZZ	5120013223499	33287	J36024	.SERVICE KIT,ACCESSO.....	
4	PEHZZ	5120013532524	33287	J 36024-4	..INSTALLATION TOOL,S.....	
5	PEHZZ	5120013549447	33287	J 36024-2	..INSERTER AND REMOVE.....	
6	PEHZZ	5120013537061	33287	J 36024-8	..INSTALLATION TOOL,B.....	
7	PEHZZ	5120013538513	33287	J 36024-3	..FIXTURE,HOLDING USE (3) BOLTS M8 X 1.25 X 40.....	
8	PEHZZ	5306012943028	75377	993-042	.BOLT,EYE.....	
9	PEHZZ	5120013223500	33287	J36224	.INSERTER SET,DOWEL.....	
10	PEHZZ	5120013542776	33287	J-36224-2	..INSTALLER,DOWEL.....	
11	PEHZZ	5120013542775	33287	J-36224-1	..INSTALLER,DOWEL.....	
12	PEHZZ	5120013222360	33287	J35642	.INSERTER AND REMOVE.....	
13	PEHZZ	5310013573045	33287	J 35642-3	..NUT,PLAIN,HEXAGON.....	
14	PEHZZ	5120013537043	33287	J 35642-7	..INSERT.....	
15	PEHZZ	5120013549442	33287	J 35642-4	..PLATE,PRESSURE.....	
16	PEHZZ	5120013561649	33287	J 35642-1	..POST,BASE USE (2) BOLTS 9/16- 18UNF X 2.25,GR8.....	
17	PEHZZ	5120013538517	33287	J 35642-2	..LEGS,MOUNTING USE (3) FLANGED HEX NUTS 5/8-18UNF,GR8.....	

END OF FIGURE

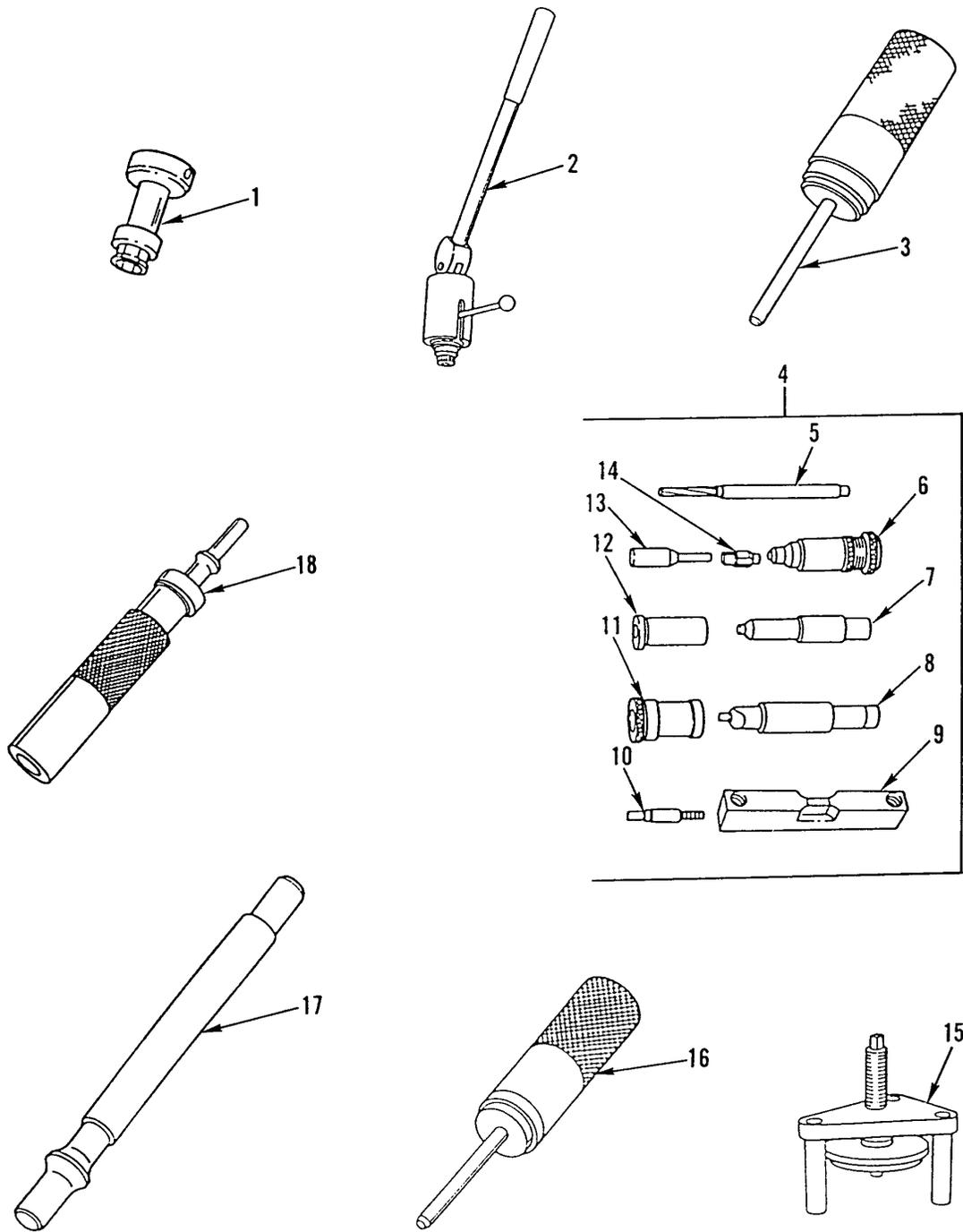

342-1399

Figure 270. General Support Special Tools

SECTION III			TM9-2320-302-24P			
(1)	(2)	(3)	(4)	(5)	(6)	(7)
ITEM	SMR			PART		
NO	CODE	NSN	CAGEC	NUMBER	DESCRIPTION AND USABLE ON CODES(UOC) QTY	
GROUP 2604 SPECIAL TOOLS						
FIG. 270 GENERAL SUPPORT SPECIAL TOOLS						
1	PEHZZ	5120004941836	33287	J23479-271		.REMOVER,VALVE SEAT.....
2	PEHZZ	5120013228883	33287	J23479-460		.REMOVER,VALVE SEAT.....
3	PEHZZ	5120013221133	33287	J33190		.REPLACING TOOL,ENGI.....
4	PEHZZ	5120013223507	33287	J33880		.RECONDITIONING SET,.....
5	PEHZZ	5110013550636	33287	J 33880-5		..REAMER,HAND.....
6	PEHZZ	5120013540426	33287	J 33880-4		..INSTALLING TOOL,TUB.....
7	PEHZZ	5210013556424	33287	J 33880-7		..GAGE,HEIGHT.....
8	PEHZZ	5110013550637	33287	J 33880-1		..REAMER,HAND.....
9	PEHZZ	5210013532535	33287	J 33880-20		..GAGE BLOCK.....
10	PEHZZ	4940007111919	33287	J5286-5		..INSTALLER,PILOT,INJ.....
11	PEHZZ	5120013537039	33287	J 33880-3		..PILOT,SEAT REAMER.....
12	PEHZZ	5120013537040	33287	J 33880-10		..PILOT,TIP REAMER.....
13	PEHZZ	5120007111920	33287	J5286-6		..FLARING TOOL,TUBE,H.....
14	PEHZZ	5120007851017	33287	J5286-8		..TUBE TIP REFINISHER.....
15	PEHZZ	3449013195599	33287	J35597		.PRESS,CYLINDER LINE.....
16	PEHZZ	5120013222955	33287	J34983		.REPLACING TOOL,ENGI.....
17	PEHZZ	5120013223506	33287	J34696		.REMOVER,VALVE GUIDE.....
18	PEHZZ	5120013223501	33287	J33191		.INSTALLER,VALVE GUI.....

END OF FIGURE

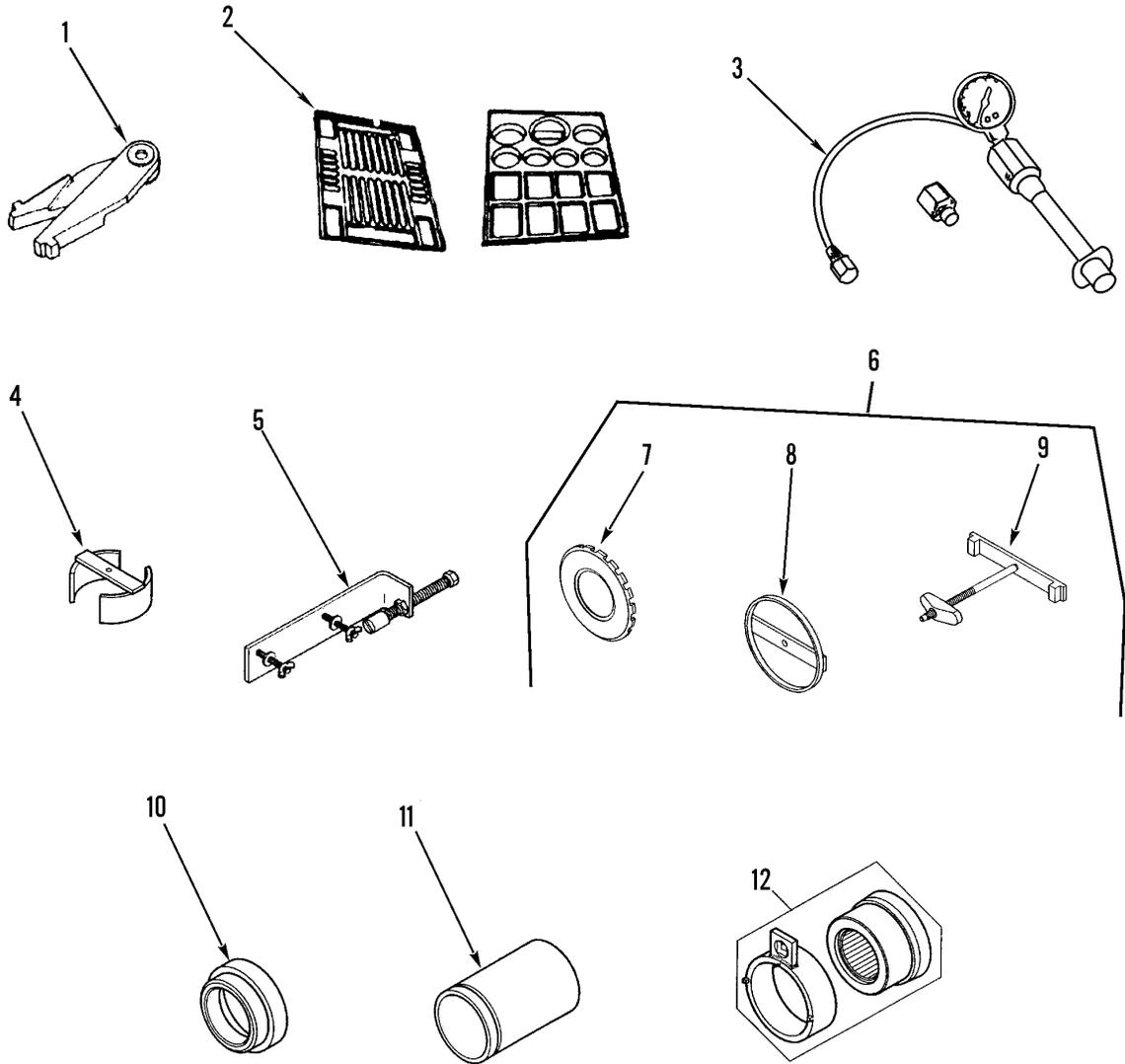

342-1559-1

Figure 271. General Support Special Tools (Sheet 1 of 2)

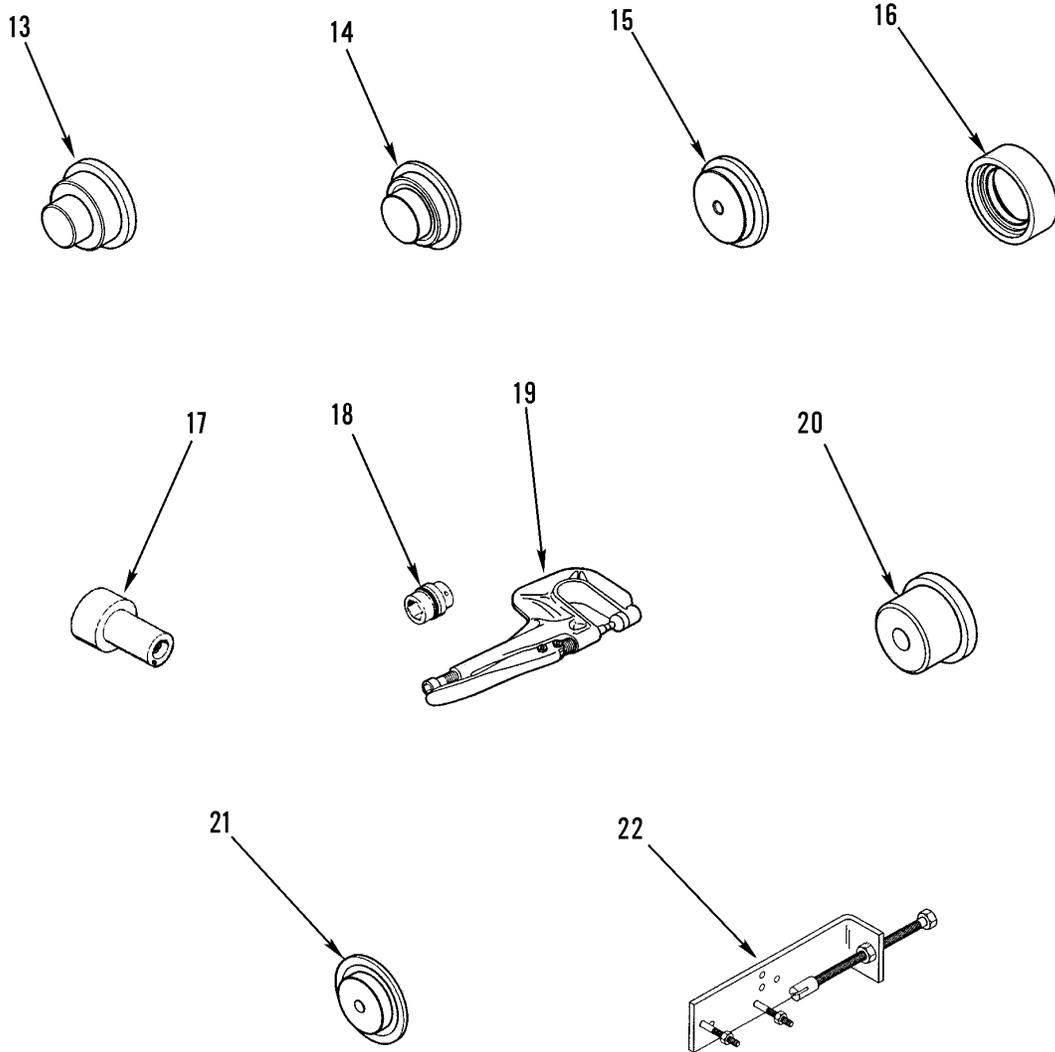

342-1559-2

Figure 271. General Support Special Tools (Sheet 2 of 2)

SECTION III			TM9-2320-302-24P			
(1)	(2)	(3)	(4)	(5)	(6)	(7)
ITEM	SMR			PART		
NO	CODE	NSN	CAGEC	NUMBER	DESCRIPTION AND USABLE ON CODES(UOC)	QTY
GROUP 2604 SPECIAL TOOLS						
FIG. 271 GENERAL SUPPORT SPECIAL TOOLS						
1	PEHZZ	5120007846482	33287	J3940	.REMOVER,WHEEL BEARI.....	
2	PEHZZ		33287	J33163	.TRAY,SHOP MAINTENAN VALVE BODY	
3	PEHZZ	5930014750242	33287	J33884	PARTS TRAY INCLUDES J33163-1 & -2...	
4	PEHZZ	5120013885623	33287	J35923-2	.SWITCH,PRESSURE.....	
5	PEHZZ	5120014769379	33287	J35924	.INSERTER AND REMOVE.....	
6	PEHZZ		33287	J37030	.INSERTER AND REMOVE.....	
7	PEHZZ	5325014754635	33287	J37030-1	.KIT INSERTER & REMO.....	
8	PEHZZ	5325014754745	33287	J37030-2	..RING,RETAINING.....	
9	PEHZZ	5120014769378	33287	J37030-3	..RING,RETAINING.....	
10	PEHZZ	5120014757608	33287	J37033	..INSERTER AND REMOVE.....	
11	PEHZZ		33287	J37033	.INSERTER,BEARING AN USE WITH ITEM	
12	PEHZZ		33287	J37034	11.....	
13	PEHZZ	5180014762361	33287	J37035	.INSTALLER/DRIVER BR.....	
14	PEHZZ	5120014769380	33287	J37036	.TOOL KIT,TRANSMISS.....	
15	PEHZZ	5120014769377	33287	J37038	.INSERTER AND REMOVE.....	
16	PEHZZ	5120014772749	33287	J37040	.INSERTER AND REMOVE.....	
17	PEHZZ	3120014751603	33287	J37041	.INSERTER AND REMOVE.....	
18	PEHZZ	5220013881460	33287	J38548-1	.BUSHING,SLEEVE.....	
19	PEHZZ		33287	J38564	.GAGE,PROFILE.....	
20	PEHZZ		33287	J39534	.ADAPTER,TORQUE WREN.....	
21	PEHZZ	5120014757609	33287	J39949	.BAR,BUCKING,RIVET.....	
22	PEHZZ	5120014757610	33287	J39954	.INSERTER,BEARING AN.....	
23	PEHZZ	5120014769381	33287	J41462	.INSERTER,BEARING AN.....	
					.INSERTER AND REMOVE.....	

END OF FIGURE

CROSS-REFERENCE INDEXES

STOCK NUMBER	NATIONAL STOCK NUMBER INDEX			
	FIG.	ITEM	STOCK NUMBER	FIG. ITEM
5310-00-004-5033	81	14	5305-00-068-0508	201 21
4730-00-005-4894	31	1		249 6
4730-00-010-3875	140	7	5305-00-068-0509	152 27
	141	7		227 21
4730-00-010-3885	7	6	5305-00-068-0510	39 18
	27	16		250 12
4730-00-011-3176	153	7	5305-00-068-0511	152 23
	158	6		182 12
5315-00-013-7214	36	6		183 8
	138	21		197 3
	170	7		206 12
5310-00-014-5850	68	40		210 5
	82	4		211 1
	92	19		212 7
	107	2	5306-00-068-0513	227 13
	118	2	6240-00-069-2640	82 3
	201	53	5305-00-071-2067	91 32
	205	2		206 15
5310-00-020-4787	60	1		208 20
5306-00-021-2544	27	24		222 11
5305-00-021-3806	22	11		238 17
	56	1		251 13
	59	7	5305-00-071-2069	44 5
5970-00-035-5100	60	53		80 4
4730-00-044-4688	60	11		92 9
5331-00-044-5726	159	30		176 43
5310-00-045-5207	89	4		181 21
4730-00-050-4203	136	4		239 14
	186	3	5305-00-071-2070	41 13
	186	14		44 23
4730-00-050-4208	138	10		176 14
	146	12		176 16
	147	17		182 13
5305-00-050-9231	245	3		183 3
5999-00-057-2929	94	14		194 7
	96	11		239 15
	100	6	5305-00-071-2071	174 5
	100	13		176 34
	245	7	5305-00-071-2072	42 6
2920-00-058-6608	60	14		135 18
3120-00-064-1723	60	44		176 36
5310-00-067-6356	3	7		183 4
	195	6	5305-00-071-2073	160 10
	197	8		177 11
5305-00-068-0502	37	7	5305-00-071-2075	184 3
	60	57		208 11
	82	17	5305-00-071-2078	193 28
	113	7	5305-00-071-2079	192 3
	208	23	5305-00-071-2081	205 22
5305-00-068-0508	90	5	5305-00-071-2083	238 21

CROSS-REFERENCE INDEXES

STOCK NUMBER	NATIONAL STOCK NUMBER INDEX		STOCK NUMBER	FIG.	ITEM
	FIG.	ITEM			
5305-00-071-2083	239	19	3120-00-082-0403	60	63
5305-00-071-2507	154	29	5306-00-082-5161	162	3
5305-00-071-2509	91	5		162	21
5305-00-071-2510	201	47	5310-00-087-0306	159	37
5305-00-071-2511	151	16	5310-00-087-4652	15	17
	154	16		30	21
5305-00-071-2512	30	17		31	14
5305-00-071-2517	201	51		39	13
5305-00-071-2519	225	15		44	14
4730-00-071-3175	155	77		68	35
5340-00-078-2394	30	5		153	10
7510-00-079-7604	BULK	35		153	13
5310-00-080-6004	15	12		154	1
	30	22		156	38
	41	2		158	7
	46	5		158	11
	152	22		177	13
	154	2		182	10
	158	24		183	7
	182	5		197	5
	182	11		204	1
	197	4		208	15
	206	7		210	1
	210	2		212	5
	211	2		221	11
	212	6		229	13
	221	12	5310-00-088-1251	15	2
	250	10		32	5
5310-00-081-4219	32	4		40	3
	39	15		42	4
	43	4		49	8
	46	2		55	12
	55	15		68	34
	91	43		76	2
	92	3		77	1
	155	19		78	3
	156	7		81	4
	182	21		82	20
	209	3		88	2
	210	7		91	3
	211	4		91	28
	212	9		113	1
	214	4		135	26
	222	15		153	2
	222	25		154	33
	239	12		155	4
	249	17		163	9
	250	4		201	29
	256	3		201	43
3120-00-082-0403	60	35		201	52

CROSS-REFERENCE INDEXES

STOCK NUMBER	NATIONAL STOCK NUMBER INDEX		STOCK NUMBER	FIG.	ITEM	
	FIG.	ITEM				
5310-00-088-1251	201	72	5310-00-121-2803	159	51	
	203	26	5306-00-121-8232	61	1	
	205	7		232	4	
	221	2		233	34	
	222	23	2530-00-137-9235	154	26	
	224	4		156	32	
	226	10	4730-00-138-8121	240	30	
	227	4	5305-00-139-7071	184	4	
	229	4		192	20	
	234	17	3110-00-144-9455	142	18	
	249	13		144	10	
	251	4	3110-00-144-9793	142	28	
	251	9		144	9	
	4730-00-088-8666	226	25	6240-00-155-7949	83	5
	2940-00-089-2520	14	4	5975-00-156-3253	230	5
5330-00-090-2128	154	25	5970-00-160-4001	57	23	
	154	28	5970-00-160-4066	57	7	
	155	42	5310-00-166-8341	44	11	
	155	47		45	12	
	156	31		49	20	
	156	36	5331-00-166-8406	6	20	
5315-00-094-3733	6	9	5310-00-167-0721	163	15	
5365-00-094-4271	24	7	4730-00-172-0034	192	14	
3110-00-100-0380	142	9	5325-00-174-9341	103	57	
	142	45	5305-00-177-5568	60	37	
3110-00-100-0615	142	65	5315-00-187-9572	183	5	
3110-00-100-3104	164	2	3110-00-191-3923	143	6	
3110-00-100-3630	144	3	4730-00-193-0875	55	17	
3110-00-100-4218	165	6		234	6	
3110-00-100-6152	172	54	4730-00-196-0930	150	29	
3110-00-100-6170	125	11	4730-00-202-6491	87	2	
5940-00-107-1481	61	4	5120-00-215-8200	264	6	
	65	14	4730-00-221-2140	238	24	
	68	23		239	20	
	68	29	2530-00-225-0680	172	44	
	96	16	5305-00-225-3842	199	5	
			5305-00-225-3843	15	4	
3120-00-111-3711	60	39		42	10	
5330-00-111-3795	60	32		49	12	
9390-00-112-8047	60	10		55	16	
5910-00-112-8051	57	28		78	5	
5940-00-113-3145	61	6		81	2	
	65	16		82	16	
	93	47		91	7	
	96	25		91	23	
	101	19		91	46	
				92	29	
5940-00-113-9820	67	11		102	4	
	93	12		135	29	
5940-00-114-1300	57	17		151	33	
2520-00-114-3294	137	5				
3110-00-120-4464	261	6				

CROSS-REFERENCE INDEXES

STOCK NUMBER	NATIONAL STOCK NUMBER INDEX		STOCK NUMBER	FIG.	ITEM	
	FIG.	ITEM				
5305-00-225-3843	153	1	5305-00-226-4831	222	18	
	155	1	5306-00-226-4833	43	3	
	163	3		210	8	
	201	100	5306-00-226-4835	208	3	
	203	3	5306-00-226-4837	155	20	
	203	22	5306-00-226-4843	145	19	
	203	45	3110-00-227-3673	138	33	
	205	9	3110-00-227-3729	142	57	
	226	17	4820-00-229-9917	173	14	
	227	6	4730-00-230-1996	226	16	
	229	1	5310-00-231-0280	173	27	
	229	11	5340-00-231-1964	13	14	
	234	14	5315-00-234-1624	153	35	
	240	9		156	57	
	5310-00-225-6993	22	10		158	16
		41	10	5315-00-234-1848	186	9
		44	8	5330-00-237-6140	BULK	33
56		17	5999-00-239-2070	115	14	
80		17	4730-00-241-7651	32	2	
92		25	5330-00-246-6380	50	7	
174		6	5305-00-253-5627	238	10	
176		20	4730-00-254-6225	22	5	
176		44	4730-00-254-6228	37	14	
177		14	3120-00-255-6042	146	5	
178		8		147	5	
181		18	5330-00-262-3272	162	46	
182		15	2590-00-264-8828	244	4	
183		11	4730-00-266-0534	22	3	
184		8	5305-00-269-3211	31	4	
192		1		59	10	
205		14		154	3	
206		11		182	7	
208		9		204	6	
208		17		206	6	
222	19		217	3		
251	11	5305-00-269-3218	158	25		
5306-00-225-8492	43	5	208	2		
5306-00-225-8499	239	16	5310-00-269-4040	4	10	
5306-00-225-8503	182	24		36	8	
	212	4		44	17	
5306-00-226-4825	161	21		92	28	
	164	11		147	22	
	208	22		160	9	
	209	2		176	22	
	256	4		177	15	
5306-00-226-4827	39	17		177	18	
	154	49		178	1	
5306-00-226-4829	223	3		179	6	
5305-00-226-4831	210	15		179	12	
	211	3		180	5	

CROSS-REFERENCE INDEXES

STOCK NUMBER	NATIONAL STOCK NUMBER INDEX		STOCK NUMBER	FIG.	ITEM
	FIG.	ITEM			
5310-00-269-4040	181	6	5340-00-413-0070	88	3
	184	7	5970-00-421-1207	57	58
	187	10	4720-00-421-1279	BULK	10
	188	3	5905-00-426-7095	255	31
	193	9	4730-00-426-8180	152	19
	197	11		153	17
	213	5		156	46
	222	27		156	63
	5340-00-272-3560	145	25	158	3
	5310-00-274-4546	60	13	158	14
	5310-00-276-2698	142	34	158	21
	5305-00-276-5739	181	3	160	26
5325-00-276-6056	82	6	160	31	
4730-00-277-3874	163	6	4820-00-426-8386	162	17
4730-00-277-9615	150	14	5310-00-429-3127	57	8
	153	33	5310-00-429-3135	57	51
4730-00-278-3167	240	31	5310-00-429-3156	57	6
4730-00-278-4822	152	8	57	62	
4010-00-285-3705	BULK	32	5310-00-429-3453	57	43
4730-00-287-1614	48	19	2920-00-431-6584	57	53
4730-00-289-0232	155	49	5310-00-432-3959	57	41
4730-00-289-3141	14	6	5305-00-432-4170	15	7
3110-00-293-8998	164	4	5325-00-432-7380	100	4
2520-00-294-6752	169	5	100	17	
5310-00-325-1900	154	5	4730-00-439-1722	154	47
	156	28	5310-00-442-0908	230	22
5305-00-335-4067	60	50	5310-00-442-0966	60	18
5331-00-352-0327	249	10	5305-00-450-0463	57	47
2520-00-353-2286	140	4	5310-00-451-0631	57	39
	141	4	5305-00-451-1623	57	29
4730-00-355-1872	41	17	5342-00-455-5899	244	2
5310-00-364-6497	57	59	5305-00-461-5860	60	43
	60	68	5305-00-465-7854	159	38
4730-00-371-5337	27	4	4730-00-469-7797	154	46
3010-00-374-4940	9	4	155	27	
2520-00-374-4950	9	2	2590-00-473-6331	256	2
5935-00-378-1253	68	20	5940-00-476-6752	57	56
	93	48	8105-00-477-3716	238	13
5940-00-399-6676	94	11	5365-00-480-6974	203	61
	96	8	5310-00-482-1999	60	28
	100	3	5306-00-483-8833	158	27
	100	22	5310-00-484-8816	186	4
	245	10	5305-00-486-5292	186	13
	3110-00-400-8419	143	10	5310-00-490-6482	43
5310-00-401-5175	138	31	92	14	
5210-00-402-9619	259	1	3120-00-493-4034	60	62
5330-00-406-0664	57	49	5120-00-494-1836	270	1
5310-00-407-9566	161	20	5360-00-494-2165	142	31
	162	4	5310-00-508-5439	60	22
	239	11	5310-00-517-6564	60	4

CROSS-REFERENCE INDEXES

STOCK NUMBER	NATIONAL STOCK NUMBER INDEX		STOCK NUMBER	FIG.	ITEM
	FIG.	ITEM			
3020-00-517-7586	122	9	5310-00-638-2830	138	29
5330-00-531-3197	163	17	5935-00-644-6750	83	7
5120-00-537-3375	259	4	2910-00-646-9727	39	2
4720-00-541-4243	BULK	11	5340-00-664-9056	79	21
5310-00-543-5858	172	4	5120-00-677-2259	267	7
5310-00-550-1130	90	4	5331-00-682-7193	63	5
5310-00-550-3503	82	14	4720-00-682-7920	BULK	14
2640-00-555-2824	166	3	5310-00-687-7697	201	32
5310-00-556-8420	201	18	2530-00-700-1705	138	27
	207	7	2530-00-700-1709	138	28
5975-00-570-9598	114	2	4730-00-702-6932	174	18
	241	25	3120-00-702-9850	145	13
5310-00-576-5752	58	2	4940-00-711-1919	270	10
	203	34	5120-00-711-1920	270	13
5330-00-580-6567	140	11	5325-00-715-7391	144	20
	141	8	5310-00-720-8819	4	2
5310-00-582-5965	57	3		36	2
	57	5		44	13
	60	38		92	7
	120	9		160	6
	151	18		176	2
	151	28		177	3
	199	6		177	16
5310-00-582-6714	154	4		178	2
	156	29		179	7
5310-00-584-5272	238	18		179	10
	239	5		180	2
5310-00-584-7796	192	8		181	5
	196	16		184	6
5310-00-584-7799	3	2		185	4
	193	25		188	2
5310-00-584-7888	238	5		193	7
2940-00-586-4792	142	61		193	10
4730-00-595-3108	160	23		213	4
5310-00-595-7237	59	11	5325-00-721-7680	203	15
4730-00-602-3707	162	43	5305-00-724-5903	60	33
4730-00-613-9339	37	16	5305-00-724-6847	160	5
	160	33	5305-00-724-7220	121	1
	163	1		178	4
5310-00-616-1739	57	2	5305-00-724-7221	92	11
	57	4		176	29
5340-00-616-4018	15	15		180	3
	81	5		181	10
5315-00-616-5523	57	37	5305-00-724-7222	146	28
6685-00-618-1822	238	11		147	24
	239	22		178	6
5310-00-625-5756	56	4		179	8
5331-00-633-6818	60	30		184	9
5331-00-633-6827	60	49		195	7
5306-00-638-1936	9	6		238	2

CROSS-REFERENCE INDEXES

STOCK NUMBER	NATIONAL STOCK NUMBER INDEX		STOCK NUMBER	FIG.	ITEM
	FIG.	ITEM			
5305-00-724-7223	177	1	5977-00-764-5530	57	54
	178	5	5340-00-764-7361	60	23
	179	14	2920-00-764-7365	60	8
	187	7	5310-00-767-9425	22	9
	188	4		56	2
	222	29		192	2
5305-00-724-7224	92	12		194	6
	176	3		208	10
	185	2		251	12
5305-00-724-7225	4	8	5310-00-768-0318	42	12
	36	3		238	23
	193	38		239	6
5305-00-724-7228	36	1	5975-00-771-6634	93	67
	176	4	5935-00-773-1428	102	3
	177	2	5310-00-773-7618	35	11
	179	9		48	10
	213	2		153	9
5305-00-724-7236	180	6		156	39
	193	40		158	10
	196	13		177	5
	197	1		217	4
5305-00-724-7254	193	13		218	6
5305-00-724-7263	196	4		229	9
	193	11	9905-00-774-4284	156	33
5305-00-724-7265	177	20	4820-00-774-8299	153	19
5305-00-725-2317	153	14		156	55
	210	11		158	23
5305-00-727-6804	121	5	5310-00-775-5139	57	52
5310-00-732-0558	48	16		60	19
	81	13	2540-00-776-0103	186	2
	182	6	4910-00-779-6832	268	4
	250	11	5305-00-781-3930	48	8
	238	28	5310-00-781-4762	209	5
5310-00-732-0560	44	12	5310-00-781-4787	57	68
5305-00-732-9207	42	8	5305-00-782-9489	168	9
5310-00-737-5065	27	23	5315-00-784-0637	146	17
5310-00-737-5429	159	28		147	20
5340-00-738-7552	156	34	5120-00-784-6482	271	1
9905-00-740-9721	49	7	5120-00-785-1017	270	14
4820-00-752-9040	172	21	5305-00-787-2177	218	4
3110-00-756-2022	60	58	5940-00-788-1586	68	28
5977-00-758-9555	34	25		71	21
5342-00-763-0482	244	3		82	22
1095-00-763-7348	121	9		93	15
5310-00-763-8920	148	3		94	3
	238	16		99	7
	238	4		103	56
5310-00-763-8921	49	11		103	63
5340-00-764-5231	76	6		255	42
	225	17	5305-00-791-9426	89	5

CROSS-REFERENCE INDEXES

STOCK NUMBER	NATIONAL STOCK NUMBER INDEX		STOCK NUMBER	FIG.	ITEM
	FIG.	ITEM			
4730-00-803-5665	231	24	5310-00-809-4085	15	10
5325-00-804-2025	159	26		91	42
5325-00-804-9740	26	2		234	8
5310-00-809-3078	168	7	5310-00-809-5997	135	16
5310-00-809-3079	80	3		140	8
5310-00-809-4058	15	3		141	9
	37	5		142	6
	40	2		142	54
	42	5		144	22
	49	9		146	27
	55	11		147	23
	72	2	5310-00-809-5998	121	4
	74	8		222	20
	76	5		239	7
	78	4	5310-00-809-8540	171	3
	79	8		176	5
	81	3	5360-00-811-1609	173	12
	82	19	5306-00-816-2441	153	12
	91	4		156	42
	91	29		158	9
	102	2	5310-00-820-6653	238	3
	113	6	5305-00-821-3869	177	4
	135	27		182	9
	150	16		206	8
	153	3		247	1
	154	17		247	6
	155	3	5310-00-823-8804	203	40
	163	8		203	65
	201	22	2530-00-827-5934	163	16
	201	28	5310-00-832-9719	170	4
	201	49	5342-00-833-1236	32	16
	203	21	5935-00-833-8561	94	13
	205	8		96	6
	208	24		100	2
	223	2		100	23
	224	1		245	8
	225	9	5970-00-833-8562	94	12
	225	20		96	7
	226	11	5310-00-833-8567	94	15
	227	5		96	10
	229	3		100	5
	229	10		100	14
	234	15		245	9
	240	7	5310-00-835-2037	56	3
	249	5	6240-00-836-2079	82	11
	251	15	5331-00-838-6729	60	21
5310-00-809-4061	31	5	4730-00-840-7236	135	20
	39	12	5340-00-841-9141	7	4
	204	5	5315-00-842-3044	145	27
	218	3	5315-00-842-3045	138	30

CROSS-REFERENCE INDEXES

STOCK NUMBER	NATIONAL STOCK NUMBER INDEX		STOCK NUMBER	FIG.	ITEM	
	FIG.	ITEM				
5940-00-842-5353	66	23	5310-00-913-3366	156	6	
	67	8		203	59	
	71	20		209	6	
	93	18		211	7	
	94	4		222	14	
	101	5		222	24	
	103	11		249	19	
	103	32		250	5	
	108	4		256	5	
	117	9		5310-00-915-4891	36	5
	255	20		185	6	
5935-00-846-3884	103	60	187	2		
5305-00-846-5703	182	17	5310-00-915-8460	57	11	
	210	4	5331-00-916-6639	249	2	
4720-00-848-1038	BULK	30	250	1		
5315-00-849-9854	190	23	2520-00-917-7434	140	15	
5310-00-851-2674	91	13	141	14		
	225	30	5340-00-919-2876	6	12	
	211	5	5305-00-922-7994	185	1	
5310-00-852-8593	118	4	6240-00-924-7526	80	6	
5305-00-857-6886	15	13	5305-00-925-7853	4	7	
5310-00-877-5796	34	29	5305-00-926-5517	196	15	
	34	34	5310-00-926-5871	171	5	
5310-00-877-5798	159	7	5331-00-929-8171	174	9	
5315-00-880-6027	142	24	174	13		
	144	16	174	15		
5310-00-880-7744	39	16	4730-00-930-5392	135	1	
	239	10	5310-00-930-8214	208	5	
5310-00-880-8189	247	4	5342-00-931-4527	159	12	
4730-00-881-1161	155	76	3010-00-932-4813	173	37	
2520-00-887-5522	9	5	5310-00-933-0993	8	11	
6240-00-889-1799	80	10	5310-00-933-8118	83	6	
5310-00-889-2528	227	16	5310-00-934-9751	57	60	
5305-00-889-3000	33	9	5310-00-934-9757	89	12	
	33	17	5310-00-934-9766	89	2	
4820-00-893-3216	162	16	5310-00-939-1060	150	12	
5305-00-899-2049	172	43	151	24		
4730-00-900-3296	151	32	5305-00-939-9204	238	6	
9905-00-901-2942	238	9	5305-00-940-8068	181	14	
5305-00-903-7767	170	1	5305-00-941-3580	4	4	
4730-00-906-0982	136	7	147	3		
4730-00-908-3194	174	2	5305-00-943-2092	196	8	
	234	3	5305-00-943-2094	4	1	
	240	17	193	16		
	242	3	6240-00-944-1264	111	2	
	51	1	231	3		
4730-00-908-6292	51	1	231	3		
4730-00-909-8627	51	5	5975-00-944-1499	80	20	
5310-00-913-3366	91	44	105	10		
	92	2	113	8		
	155	21	251	1		

CROSS-REFERENCE INDEXES

STOCK NUMBER	NATIONAL STOCK NUMBER INDEX		STOCK NUMBER	FIG.	ITEM
	FIG.	ITEM			
5975-00-944-1499	252	1	5340-01-022-7474	238	7
6240-00-946-9654	71	18	2910-01-022-8183	38	2
5305-00-947-4350	171	4	5935-01-023-4871	101	11
5305-00-947-4359	195	5		116	4
5305-00-947-4360	197	10	5310-01-023-8927	57	67
5305-00-947-4364	195	2	5935-01-024-1902	115	13
5305-00-948-0677	3	1	5935-01-030-5090	115	15
5940-00-956-3517	68	24	5320-01-032-1043	33	11
	93	2		83	8
	94	8	4820-01-034-1287	KITS	
	103	61	3040-01-036-6582	91	8
	113	5	5330-01-037-4129	34	20
5305-00-957-2395	176	28	3110-01-038-5721	25	8
5310-00-959-4679	159	3	5325-01-046-0769	103	33
5305-00-964-0512	176	6	5180-01-048-2153	265	6
3110-00-969-7315	142	56	5120-01-048-2156	267	2
5310-00-974-6623	81	7	5120-01-048-2159	267	4
	145	9	4730-01-048-5260	48	23
	164	10		150	9
5120-00-977-5578	257	5		150	24
5120-00-977-5579	257	2		151	3
2530-00-980-2384	159	6		152	4
3110-00-980-5621	142	38		152	11
	144	7		154	8
5310-00-982-5003	33	3		154	43
	33	15		155	25
5310-00-984-3806	145	7		155	30
	145	11		155	34
	168	8		155	53
	182	20		155	57
	205	17		155	61
	208	4		156	4
	210	18		156	10
	212	10		156	26
5305-00-984-6191	60	61		156	50
5305-00-984-6192	57	50		160	36
5305-00-984-6193	200	5		163	11
5305-00-984-6212	205	5	4730-01-048-5261	152	16
5310-00-984-7042	204	4		153	26
5305-00-988-1728	201	94		155	14
5305-00-990-0695	239	4		155	66
5305-00-990-8400	135	24		155	69
	176	9		155	73
5305-00-993-1848	57	69		156	14
	58	1		156	23
4720-01-003-6706	BULK	29	4730-01-048-6358	48	4
4820-01-005-2994	238	8		48	13
	239	1		150	5
4720-01-009-9058	BULK	27		150	32
4720-01-014-4915	BULK	28		150	40

CROSS-REFERENCE INDEXES

STOCK NUMBER	NATIONAL STOCK NUMBER INDEX		STOCK NUMBER	FIG.	ITEM	
	FIG.	ITEM				
4730-01-048-6358	150	45	4730-01-049-1559	156	15	
	151	11		156	22	
	153	31	5120-01-054-4042	265	3	
	154	20	5120-01-054-4048	262	3	
	226	3	4730-01-055-4017	150	38	
	226	14	5320-01-056-2973	169	1	
4730-01-048-6968	48	3		207	6	
	48	14	4730-01-056-4990	48	22	
	150	4		150	8	
	150	31		150	23	
	150	41		151	4	
	150	46		152	5	
	151	10		152	10	
	153	30		154	7	
	154	21		154	44	
	226	4		155	24	
	226	15		155	31	
	4730-01-048-7873	48	24		155	33
		150	10		155	52
		150	25		155	58
151		2		155	62	
152		3		156	5	
152		12		156	9	
154		9		156	27	
154		42		156	51	
155		26		160	35	
155		29		163	12	
155		35	4730-01-057-7109	48	5	
155		54		48	12	
155		56		150	6	
155		60		150	33	
156		3		150	39	
156		11		150	44	
156		25		151	12	
156		49		153	32	
160		37		154	19	
163		13		226	2	
4730-01-048-7874	152	14		226	13	
	153	24	5310-01-059-3609	148	2	
	155	64	4730-01-062-2570	151	1	
	155	71		155	59	
	155	75		156	2	
	156	16	5935-01-065-7983	93	23	
	156	21		103	55	
4730-01-049-1559	152	15	5935-01-065-7984	69	12	
	153	25		82	23	
	155	15		93	6	
	155	65		255	41	
	155	70	5365-01-067-9583	14	11	
	155	74	4820-01-068-3477	156	60	

CROSS-REFERENCE INDEXES

STOCK NUMBER	NATIONAL STOCK NUMBER INDEX		STOCK NUMBER	FIG.	ITEM
	FIG.	ITEM			
5306-01-075-8519	145	8	4730-01-086-4064	150	43
	222	4		226	1
2920-01-076-9812	60	59	5330-01-086-6196	26	11
2920-01-077-0911	60	64	5310-01-086-7725	255	25
5310-01-077-9437	57	18	5310-01-086-7726	101	13
5310-01-077-9648	60	67	5310-01-088-2825	88	8
5305-01-077-9659	57	42	2530-01-088-4432	60	75
4730-01-079-3275	156	13	4730-01-088-4453	174	14
5330-01-079-6372	60	40	4730-01-088-7502	48	11
5340-01-079-6715	41	1	5360-01-089-9103	26	4
5305-01-080-4755	60	73	5330-01-091-1107	KITS	
4820-01-080-7439	162	19	4730-01-091-8032	152	9
5310-01-081-0798	255	24		155	63
5310-01-081-0799	101	14		155	72
2530-01-081-3213	162	38	4730-01-091-9212	150	3
5360-01-081-8276	162	18		153	29
2815-01-082-2134	9	13		154	18
2920-01-082-6458	57	40	5310-01-092-5011	205	13
2920-01-082-6731	60	74	6240-01-093-2131	83	3
5315-01-082-6938	138	19	6635-01-093-3710	259	6
3120-01-082-6996	57	65	4730-01-094-0941	155	12
3110-01-082-8752	142	52	5360-01-094-2428	33	14
4730-01-082-8799	152	17	4820-01-095-1697	154	48
3120-01-082-9419	57	63	4730-01-095-2034	156	53
5310-01-083-0104	141	16	6220-01-095-2616	80	8
	142	26	5945-01-095-6280	74	1
	142	33		75	1
	144	18	4730-01-096-0574	153	15
2530-01-083-6343	159	23		156	44
5340-01-083-6420	159	21		158	12
4820-01-083-6788	159	19		160	24
2530-01-083-8102	159	20	4730-01-096-9127	156	8
5310-01-083-9359	138	17	4730-01-096-9128	48	21
5310-01-083-9509	142	68		154	6
	143	4		155	51
5365-01-083-9531	142	58		156	24
5365-01-083-9532	142	58	5310-01-097-7691	182	8
5365-01-083-9533	142	58		182	23
5360-01-083-9766	159	22		201	102
5330-01-084-1063	146	13		203	60
6105-01-084-3049	60	42		212	3
2520-01-084-3251	136	6	2540-01-098-1865	225	7
	137	6	3110-01-099-0022	142	51
5342-01-084-4459	263	4	3110-01-099-4888	144	21
5305-01-084-6065	159	49	4720-01-100-0740	51	2
5920-01-085-0825	74	11		51	6
6240-01-085-2319	245	2	4730-01-102-4123	155	28
5331-01-085-3105	26	10		158	1
5310-01-085-4523	159	25		160	29
4730-01-086-4064	31	10	5310-01-102-9221	201	88

CROSS-REFERENCE INDEXES

STOCK NUMBER	NATIONAL STOCK NUMBER INDEX		STOCK NUMBER	FIG.	ITEM
	FIG.	ITEM			
5970-01-104-1074	57	24	5970-01-118-6753	60	17
5970-01-104-1075	57	22	4820-01-120-4532	22	7
2920-01-104-8950	60	41	5970-01-120-5418	57	13
2920-01-104-8951	60	25	5310-01-120-6997	60	2
5305-01-105-6888	57	26	5305-01-121-5475	60	24
4730-01-105-9466	234	5	4730-01-122-3338	55	5
4730-01-106-0313	55	6		234	2
5330-01-106-4329	57	21	2530-01-122-9933	159	31
5330-01-106-6101	57	19	5920-01-123-5211	74	5
4020-01-106-6523	92	24	5920-01-123-5212	75	3
5306-01-106-9928	57	27		252	3
5310-01-106-9929	57	16	5306-01-124-1225	159	2
	60	66	5360-01-124-6811	159	42
5310-01-107-9269	57	33	5305-01-125-0929	159	33
5365-01-107-9291	138	5	5310-01-125-1137	89	3
5310-01-107-9715	57	10	5360-01-125-1670	159	9
5310-01-108-6232	247	2	5360-01-125-1671	159	15
5310-01-109-1977	41	11	5331-01-125-6268	135	14
	44	4		135	21
	92	10	5331-01-126-1233	159	32
	160	11	5310-01-126-3664	80	19
	174	4	5310-01-126-8834	159	10
	176	13	5365-01-126-9574	146	9
	176	21	5340-01-127-0445	60	48
	177	9	2530-01-127-3971	159	41
	178	3	5342-01-127-5636	60	60
	181	8	4910-01-127-7959	265	4
	182	14	5360-01-128-6186	201	80
	183	2	5310-01-128-6503	201	81
	184	2	4730-01-129-3047	7	9
	193	30		23	2
	206	16		50	5
3110-01-109-3058	57	46	5315-01-129-6898	146	4
5330-01-111-2281	214	13		147	4
5330-01-111-6531	57	45	2590-01-130-6720	159	5
5315-01-112-1505	138	14	4820-01-132-0606	159	11
5310-01-112-1738	60	36	5305-01-133-1052	201	63
5310-01-112-1740	60	5	5365-01-134-0522	172	31
4730-01-113-1791	151	9		172	47
	226	12	4730-01-134-0854	48	2
5310-01-114-5637	138	26	5330-01-135-4068	172	36
5120-01-115-1160	268	2	5331-01-135-4069	172	35
5120-01-115-1161	268	3	5340-01-135-4292	159	8
5310-01-115-2550	138	3	5331-01-135-4807	172	48
5330-01-116-1132	138	34	5975-01-135-5917	BULK	2
5120-01-116-5016	268	8	5975-01-135-5919	BULK	1
5330-01-116-5309	138	13	5975-01-135-5941	BULK	3
5120-01-116-6049	262	4	5305-01-136-1619	172	18
5330-01-117-1014	165	1	3110-01-136-2090	57	32
5970-01-118-6746	60	16	3110-01-136-2093	57	20

CROSS-REFERENCE INDEXES

STOCK NUMBER	NATIONAL STOCK NUMBER INDEX		STOCK NUMBER	FIG.	ITEM
	FIG.	ITEM			
3110-01-136-5534	57	44	5305-01-158-2041	85	8
5310-01-136-5543	57	15		122	2
5305-01-137-3938	47	3	4910-01-158-3972	268	10
	78	1	4910-01-158-3996	266	13
	198	12	5220-01-158-3999	268	11
	200	9	5310-01-158-7840	170	6
	225	19	4730-01-158-9201	154	45
	225	36	5310-01-158-9215	60	72
5305-01-138-7735	176	39	5315-01-159-1263	191	6
5305-01-140-9118	173	28	5340-01-159-6484	191	7
2920-01-141-1488	57	38	5360-01-159-6485	191	5
5342-01-144-1937	7	14	5307-01-160-0471	190	4
5340-01-145-3232	49	10	4910-01-160-3618	265	1
	163	4	2530-01-160-9652	159	13
	229	5	5310-01-160-9956	190	7
5305-01-145-8384	26	25	5305-01-161-0017	190	11
2920-01-147-2208	60	78	5305-01-161-0019	190	9
5920-01-149-6952	67	16	2815-01-161-6540	9	1
	74	3	5935-01-161-8087	68	5
5920-01-149-6953	74	2		93	55
5330-01-149-7229	172	45		99	8
5330-01-149-9677	138	25		255	8
5310-01-150-8599	186	19	5310-01-162-4753	190	8
5310-01-151-1036	35	5	5365-01-162-4787	190	6
	82	15	4730-01-163-5002	45	13
	102	8	2920-01-164-8123	60	34
	169	7	3040-01-164-9277	190	19
	185	10	5310-01-165-2274	190	27
2540-01-151-5703	186	5	5360-01-165-2290	190	3
4820-01-152-0193	159	48	5360-01-165-2301	190	20
4820-01-152-0194	159	50		190	26
5305-01-153-1375	124	1	5306-01-165-5583	20	9
5315-01-153-1451	186	7	4910-01-165-6015	263	9
4310-01-153-8352	162	40	5340-01-166-4444	51	12
5999-01-153-9432	101	12	5325-01-166-6633	51	11
5935-01-154-4586	83	9	5315-01-167-0207	190	18
5330-01-154-5214	80	7	5935-01-168-0731	93	8
2510-01-155-5796	191	2	3110-01-168-9203	190	29
2590-01-155-5873	191	8	3120-01-168-9204	190	12
5977-01-155-7352	60	15	5310-01-171-2356	203	49
5320-01-157-0908	198	10	5310-01-171-4689	203	50
	204	11	5310-01-172-1991	60	71
	210	13	5306-01-174-0373	56	8
	226	20	5935-01-174-1235	66	4
5340-01-157-1009	35	7		117	5
4910-01-157-3571	259	2		255	21
4730-01-157-8925	29	3	5306-01-174-2553	173	33
5306-01-158-1154	155	22	5315-01-175-3907	173	21
	155	48	5315-01-175-3916	173	8
5305-01-158-2041	85	4	5306-01-175-7558	74	10

CROSS-REFERENCE INDEXES

STOCK NUMBER	NATIONAL STOCK NUMBER INDEX		STOCK NUMBER	FIG.	ITEM
	FIG.	ITEM			
4730-01-177-3515	31	3	5999-01-203-6687	254	4
2530-01-178-7154	138	24	9390-01-204-7151	60	46
4910-01-179-6364	261	17	4730-01-210-4252	6	18
5935-01-179-9105	93	66		7	16
5365-01-180-2369	140	17	5305-01-210-4595	185	9
	141	17		218	5
3120-01-180-5624	60	26	5365-01-213-5069	146	10
4720-01-182-9067	BULK	45		147	15
5310-01-184-6477	44	15	5935-01-214-4163	65	30
5310-01-184-7647	89	11		66	22
5310-01-185-0433	143	13		96	15
	144	27		117	21
5306-01-185-7049	19	10	5935-01-214-5259	65	32
	27	22		66	5
	30	12		100	21
5306-01-185-7051	2	1	5999-01-214-9682	64	4
	30	10		65	21
	63	1		100	9
5306-01-186-1052	172	2		100	19
5306-01-186-5367	6	24	5340-01-215-1558	193	34
	19	6	4730-01-216-3331	29	7
	34	22	5999-01-216-3648	101	16
	63	12		254	2
	161	7		255	23
4030-01-187-0964	185	14	4730-01-216-9355	162	44
2520-01-187-3619	60	77	6220-01-218-4968	245	1
4730-01-187-3645	60	47	5330-01-221-3166	245	4
4730-01-188-3492	16	6	2930-01-222-6696	45	5
	18	17	6220-01-224-3042	82	10
5920-01-188-6294	74	12	5975-01-226-8078	65	36
5310-01-190-0283	54	21		67	7
5310-01-190-4607	54	22		96	12
5307-01-190-5854	54	19		96	13
4720-01-192-5261	BULK	39	4730-01-227-5373	163	10
5310-01-194-0658	138	32	5975-01-230-4370	94	16
5305-01-195-5050	171	6		96	9
4730-01-196-7479	156	61		100	7
	158	19		100	15
2920-01-196-7730	60	76		245	5
4820-01-197-1880	232	5	4730-01-230-6584	240	29
2510-01-198-0857	190	21	5940-01-234-7272	63	8
5310-01-199-9467	190	17		66	8
4730-01-200-4278	31	6		115	8
5310-01-200-9879	138	9		117	20
	142	11	5940-01-234-7954	69	10
4720-01-202-0248	BULK	16		93	19
6240-01-203-2106	79	10		94	9
5999-01-203-6687	66	3		255	40
	115	35	5330-01-235-8331	249	11
	117	7		250	2

CROSS-REFERENCE INDEXES

STOCK NUMBER	NATIONAL STOCK NUMBER INDEX		STOCK NUMBER	FIG.	ITEM
	FIG.	ITEM			
4730-01-238-2980	22	2	5310-01-250-7679	161	19
4730-01-241-6612	6	17	5305-01-251-1626	124	17
	7	5		125	2
4820-01-242-4714	159	36	5310-01-251-9276	74	9
5306-01-243-1346	15	6	5340-01-253-0128	102	5
5320-01-243-2947	204	10		234	16
	231	1	5310-01-254-4255	140	12
5975-01-243-9900	BULK	4		141	12
4730-01-244-0000	150	30	9330-01-256-5345	BULK	31
4730-01-244-1226	152	2	5340-01-263-0821	174	10
	155	23	5310-01-264-1640	19	8
	155	55	5325-01-265-7251	173	3
	156	48	2920-01-267-2088	57	30
4730-01-244-1227	152	13	4720-01-267-5991	BULK	37
	155	68	5330-01-269-4327	144	2
4730-01-244-1265	151	17	4730-01-270-2477	174	8
4730-01-244-3552	150	7	5320-01-270-2951	214	6
	154	41	5320-01-270-2952	42	1
	155	32		198	3
	160	34	5306-01-270-8909	91	20
5306-01-244-3973	76	8		173	34
4730-01-244-5365	154	27	5330-01-271-9407	173	22
	155	41	5330-01-271-9544	KITS	
	156	30	2910-01-274-1915	55	8
8145-01-245-2092	239	17	5310-01-275-1065	170	3
8145-01-245-2099	239	2		186	16
4030-01-245-4168	187	4		195	3
7690-01-245-4316	239	21	5305-01-277-0451	171	1
8140-01-245-4321	239	13	2530-01-278-7558	148	1
8140-01-245-4323	239	9	5310-01-278-9527	45	7
8140-01-245-4325	239	23	5306-01-281-0554	134	52
8140-01-245-5694	239	8	5305-01-281-7811	142	5
4730-01-245-6995	155	45	4210-01-282-1789	224	3
	156	1	4730-01-283-8173	225	16
5365-01-245-8802	15	5	4720-01-284-1668	BULK	19
	135	6	4730-01-284-9065	151	30
	152	32	5305-01-285-3996	92	23
	226	21	5340-01-285-5558	240	33
5305-01-246-0609	221	13	5306-01-286-7169	37	1
2590-01-246-4298	226	18		234	9
5365-01-247-1114	93	68	5340-01-287-1979	240	35
	103	58	4720-01-287-9313	BULK	21
3990-01-247-3625	239	18	5340-01-288-1244	164	9
4310-01-247-7126	268	9	5365-01-289-1922	143	9
5310-01-248-3077	93	69	2540-01-289-3947	186	12
	103	59	5935-01-291-2814	65	20
5330-01-248-7817	239	3		67	5
5310-01-250-7679	34	28		100	10
	53	3		100	20
	56	14	5935-01-292-2336	65	25

CROSS-REFERENCE INDEXES

STOCK NUMBER	NATIONAL STOCK NUMBER INDEX		STOCK NUMBER	FIG.	ITEM	
	FIG.	ITEM				
5935-01-292-2336	101	25	5310-01-305-2539	196	5	
	115	18	3040-01-306-2646	9	3	
	117	19	3120-01-306-9870	60	55	
5340-01-292-3904	136	9	5970-01-307-6070	60	12	
5330-01-292-5293	63	3	5970-01-308-0374	60	6	
	66	9	5970-01-308-0375	60	52	
	104	4	5970-01-308-5176	60	9	
	110	26	5935-01-308-7866	66	21	
	115	17		117	16	
	117	14	5305-01-308-8195	176	8	
	4010-01-293-1710	186	11	5935-01-308-8599	65	27
4720-01-293-1827	BULK	20	4730-01-310-4665	153	23	
4730-01-293-2939	170	8	5975-01-310-5011	101	27	
4720-01-293-6177	BULK	41	5940-01-310-9565	60	54	
4730-01-293-6907	186	6	5305-01-312-4837	60	20	
4720-01-293-9313	BULK	12	5315-01-315-3614	146	26	
5306-01-294-3028	269	8	3040-01-315-6720	151	6	
4720-01-294-7228	BULK	42	5340-01-315-7223	92	17	
5305-01-295-1317	60	29	5310-01-316-5096	149	1	
5935-01-295-2863	93	65	2920-01-316-8813	27	18	
5310-01-296-0327	159	45	2815-01-317-5521	20	1	
5935-01-296-2196	93	70	4320-01-317-8240	29	8	
	94	2	5935-01-318-1066	63	10	
	68	25	5330-01-318-1949	7	21	
5305-01-298-7333	255	9		KITS		
	31	8	5340-01-318-2049	121	6	
	42	11	5330-01-318-2324	KITS		
	44	1	2530-01-318-4214	138	23	
	198	9	2530-01-318-4215	138	23	
	199	2	5330-01-318-4569	27	6	
	201	42		161	14	
	203	2	2910-01-318-5439	6	19	
	205	15	2815-01-318-8471	12	1	
	3120-01-298-7357	31	12	4730-01-318-9668	30	2
		42	3	4730-01-318-9675	30	6
		44	21	2990-01-318-9754	84	1
		198	7	1650-01-319-0808	26	13
199		1	2530-01-319-0833	26	24	
201		41	3040-01-319-0848	262	5	
203		9	2815-01-319-0902	13	6	
205		16	5306-01-319-1987	269	1	
4730-01-298-9423		6	5330-01-319-2035	29	1	
5340-01-299-1813		226	5310-01-319-2127	121	7	
5940-01-300-9339		103		135	15	
5310-01-303-4701		33	4	5330-01-319-2136	27	19
		33	12	5315-01-319-2188	8	1
5331-01-304-3453	60	7	5315-01-319-2189	11	9	
5310-01-305-2539	121	2	5935-01-319-2334	63	6	
	193	36		96	26	
	195	8	5330-01-319-2435	25	9	

CROSS-REFERENCE INDEXES

STOCK NUMBER	NATIONAL STOCK NUMBER INDEX		STOCK NUMBER	FIG.	ITEM
	FIG.	ITEM			
5315-01-319-2509	20	12	2990-01-320-0163	84	5
2930-01-319-2777	50	1	3120-01-320-1034	8	3
3020-01-319-2831	25	10	3120-01-320-1035	8	3
4730-01-319-3374	18	20	3120-01-320-1036	8	5
	29	6	3120-01-320-1037	8	5
	34	18	3120-01-320-1038	8	5
	161	13	5305-01-320-2007	27	25
4730-01-319-3469	34	23	3110-01-320-2309	11	1
4730-01-319-3474	18	12	3110-01-320-2310	8	5
4810-01-319-3495	21	1	5315-01-320-3625	20	5
2815-01-319-3579	23	5	5315-01-320-3626	7	3
5331-01-319-4857	28	4	5360-01-320-3689	12	5
5331-01-319-4858	28	5	5306-01-320-3940	18	19
5340-01-319-4862	19	7		20	15
3120-01-319-4879	8	4		27	21
3120-01-319-4880	8	4		34	13
5340-01-319-4908	12	6	5306-01-320-3941	18	6
5331-01-319-5207	19	1	5306-01-320-3942	23	8
5331-01-319-5208	19	3	5306-01-320-3943	53	7
5340-01-319-5305	64	2	4320-01-320-4618	267	3
3460-01-319-5533	268	1	4910-01-320-4638	268	6
3449-01-319-5599	270	15	5306-01-320-4894	10	15
5315-01-319-5895	7	13	5330-01-320-4926	10	4
	27	2	3120-01-320-4983	8	4
5220-01-319-6604	260	5	5330-01-320-5071	KITS	
4910-01-319-6971	268	5	5340-01-320-5174	7	19
3950-01-319-6973	269	2	5340-01-320-5179	24	2
3040-01-319-6983	24	4	5310-01-320-5919	6	23
4910-01-319-6990	266	5	5305-01-320-7142	26	17
5310-01-319-7295	12	6	5305-01-320-7153	7	10
5999-01-319-7394	65	23	5305-01-320-7157	5	4
4730-01-319-7471	7	7	5331-01-320-7183	18	5
	51	17	5330-01-320-7190	19	19
2815-01-319-7851	8	9	5330-01-320-7191	18	7
3120-01-319-8619	8	3	5325-01-320-7327	25	2
5305-01-319-8651	53	5	5305-01-320-8043	20	16
5330-01-319-8671	34	26		28	6
5330-01-319-9227	23	6	5310-01-320-8100	27	26
3120-01-319-9271	8	3	5330-01-320-8114	6	27
3020-01-319-9400	8	8	2510-01-320-8289	2	3
3020-01-319-9401	11	8	5306-01-320-8614	27	3
5305-01-319-9881	11	11	5315-01-320-8883	7	15
	19	5		27	5
	21	2	2510-01-320-8903	5	5
	25	13	2510-01-320-8904	5	1
	27	8	2510-01-320-8905	267	1
	27	17	3010-01-320-8941	29	2
	53	6	6620-01-320-9060	50	6
5305-01-319-9882	2	4	5306-01-321-0556	6	4
2990-01-320-0162	84	6	5365-01-321-0574	26	29

CROSS-REFERENCE INDEXES

STOCK NUMBER	NATIONAL STOCK NUMBER INDEX				FIG.	ITEM
	FIG.	ITEM	STOCK NUMBER	FIG.		
3120-01-321-0598	20	4	5120-01-322-6888	261	18	
	20	8	5305-01-322-8772	51	8	
5331-01-321-2160	10	3	5120-01-322-8883	270	2	
5310-01-321-2419	161	1	5120-01-322-8885	260	7	
5310-01-321-2421	10	16	2815-01-322-9163	12	8	
5310-01-321-2441	34	27	2815-01-322-9164	12	9	
5310-01-321-2444	7	11	2910-01-322-9191	KITS		
5315-01-321-3220	6	10	3020-01-322-9234	51	20	
5306-01-321-3559	6	28	2815-01-322-9277	23	9	
	7	17	3020-01-322-9945	20	13	
	18	15	4710-01-323-0095	19	9	
	29	9	2815-01-323-1353	12	7	
	30	4	5306-01-323-2292	8	12	
	34	19	3040-01-323-3261	51	23	
	63	13	5999-01-323-4929	66	6	
	64	3		101	26	
5330-01-321-4132	18	13	5365-01-323-5621	26	6	
5306-01-321-4903	9	14	5315-01-323-5661	7	2	
5310-01-321-5302	25	11	5340-01-323-8363	12	6	
5330-01-321-8616	51	9	3940-01-324-4713	260	3	
2910-01-321-9247	28	8	5360-01-325-1570	26	12	
2815-01-321-9248	266	2	5330-01-325-2615	142	8	
3130-01-322-0935	7	12		142	10	
5120-01-322-1123	262	17	5330-01-325-2623	138	12	
5120-01-322-1128	266	4	3120-01-325-2638	142	48	
5120-01-322-1129	261	1	3130-01-325-2662	143	3	
5120-01-322-1131	261	10	2530-01-325-3381	138	20	
5120-01-322-1132	260	8	4730-01-325-3762	142	62	
5120-01-322-1133	270	3	4820-01-325-4657	142	41	
5120-01-322-2358	257	12	5360-01-325-5795	142	40	
5120-01-322-2359	266	14	5305-01-325-5908	142	22	
5120-01-322-2360	269	12		144	15	
5340-01-322-2747	12	6	5305-01-325-5920	142	36	
5305-01-322-2917	5	2	3020-01-325-6390	142	13	
5120-01-322-2955	270	16	2520-01-325-6405	137	2	
5120-01-322-3498	262	2	2530-01-325-6410	138	24	
5120-01-322-3499	269	3	5325-01-325-7221	143	7	
5120-01-322-3500	269	9	5325-01-325-7222	142	15	
5120-01-322-3501	270	18	5310-01-325-7279	142	21	
5120-01-322-3503	266	3		144	14	
5120-01-322-3505	261	20	5340-01-325-7332	142	7	
5120-01-322-3506	270	17	5315-01-326-1864	142	23	
5120-01-322-3507	270	4	5310-01-326-2667	142	35	
5120-01-322-3508	262	14	4730-01-326-2939	250	6	
4710-01-322-4975	19	2	3130-01-326-4524	143	1	
4710-01-322-4978	51	3	2530-01-326-4571	139	1	
5120-01-322-6115	262	6	2530-01-326-4647	138	22	
5120-01-322-6116	261	19	5315-01-326-5530	138	2	
5120-01-322-6222	261	13	5310-01-326-7480	197	2	
2815-01-322-6694	12	4	5365-01-326-7524	142	44	

CROSS-REFERENCE INDEXES

STOCK NUMBER	NATIONAL STOCK NUMBER INDEX			
	FIG.	ITEM	STOCK NUMBER	FIG. ITEM
2510-01-326-9147	192	21	5340-01-328-4418	147 19
3040-01-327-0143	192	13	5305-01-328-4430	169 6
2520-01-327-1298	169	4	5340-01-328-4438	142 67
2530-01-327-1350	172	1	3130-01-328-4447	172 14
2530-01-327-5416	139	3	5340-01-328-4513	191 3
5306-01-327-5536	192	4	2540-01-328-4750	228 1
5340-01-327-7708	191	1	5331-01-328-6016	174 12
2530-01-327-7713	175	1	5330-01-328-6054	KITS
2510-01-327-7717	206	1	5995-01-328-8997	208 19
2510-01-327-7773	192	19	5995-01-328-8998	208 21
5365-01-327-9084	192	15	5999-01-329-0309	60 56
3110-01-328-4066	172	41	5940-01-329-1096	100 11
3110-01-328-4074	172	51		100 16
5315-01-328-4104	172	37	5365-01-329-1141	192 12
5315-01-328-4106	191	4	4720-01-329-1298	174 16
5315-01-328-4112	172	39	4720-01-329-1299	174 7
5360-01-328-4126	145	24	4710-01-329-1585	173 32
5360-01-328-4127	172	40	4140-01-329-1664	33 1
5360-01-328-4128	175	7	6115-01-329-1671	57 1
5305-01-328-4245	KITS		2540-01-329-1682	219 2
5305-01-328-4246	175	4	4010-01-329-1837	208 18
3120-01-328-4276	169	3	4730-01-329-1842	172 49
3120-01-328-4295	172	27	4730-01-329-2139	174 1
3120-01-328-4296	172	22	4730-01-329-2141	174 17
5305-01-328-4357	145	21	5306-01-329-3695	173 25
5315-01-328-4358	145	12	5310-01-329-3697	46 1
5315-01-328-4359	138	7	5310-01-329-3700	171 2
5340-01-328-4367	37	9		176 7
	49	34		176 42
	91	21	5340-01-329-3719	44 19
	153	6	5360-01-329-3756	208 7
	154	34	5306-01-329-3835	208 14
	155	6	5305-01-329-3857	207 3
	163	5	5340-01-329-3863	176 33
	240	23		208 12
5340-01-328-4368	42	7	5340-01-329-3891	206 3
5340-01-328-4369	42	13	5340-01-329-3892	207 1
5340-01-328-4370	49	24	5310-01-329-3925	172 11
5340-01-328-4371	91	18	5310-01-329-3928	176 32
	152	28	5310-01-329-3929	207 13
	163	7	5305-01-329-3969	207 9
	240	8	5340-01-329-3978	44 7
5340-01-328-4372	205	20	5340-01-329-3979	44 3
5305-01-328-4386	45	18	5340-01-329-3980	206 9
5305-01-328-4387	45	15	5340-01-329-3981	208 8
5305-01-328-4388	169	9	5340-01-329-3982	207 4
5305-01-328-4389	172	10	5340-01-329-3983	207 4
5305-01-328-4390	173	24	5340-01-329-3984	205 20
5340-01-328-4391	169	2	5305-01-329-3991	138 8
5340-01-328-4418	146	21	5305-01-329-3992	142 19

CROSS-REFERENCE INDEXES

STOCK NUMBER	NATIONAL STOCK NUMBER INDEX		STOCK NUMBER	FIG.	ITEM
	FIG.	ITEM			
5305-01-329-3992	144	12	4220-01-330-0663	174	11
5305-01-329-4004	205	12	3020-01-330-0676	142	16
5340-01-329-4009	207	2	2520-01-330-0772	140	10
5365-01-329-4034	172	25	2520-01-330-0773	140	3
5365-01-329-4041	205	10	2530-01-330-0774	170	5
5310-01-329-4045	59	4	5365-01-330-2145	142	17
	68	39		144	11
	92	20	5365-01-330-2162	142	59
	201	19	5365-01-330-2164	172	38
	205	1	2540-01-330-2621	228	2
5340-01-329-4090	44	22	5310-01-330-6354	169	8
5340-01-329-4091	44	10	5310-01-330-6362	142	66
5340-01-329-4092	44	9	5310-01-330-6364	192	16
5340-01-329-4093	206	10	5365-01-330-6369	142	44
5340-01-329-4094	206	13	5365-01-330-6370	142	44
5340-01-329-4095	206	5	5340-01-330-6876	207	17
5340-01-329-4096	206	2	5365-01-330-6903	172	46
5365-01-329-4102	208	13	5365-01-330-7318	KITS	
5340-01-329-4106	44	18	5310-01-330-7592	30	9
5340-01-329-4107	44	6		34	15
5340-01-329-4108	44	2	2520-01-330-8163	142	4
4320-01-329-5022	KITS		4330-01-330-8203	175	6
2510-01-329-5035	207	12	6680-01-330-8259	175	2
2510-01-329-5036	207	14	5365-01-330-8392	13	2
2530-01-329-5045	90	1	5307-01-330-8430	6	1
4320-01-329-5101	173	23	5305-01-330-8432	13	3
3120-01-329-6626	175	3	5340-01-330-8435	5	3
5330-01-329-6920	45	9	5305-01-330-8440	6	22
5365-01-329-6987	139	2	2540-01-330-9287	33	2
	139	4	5365-01-330-9716	KITS	
5305-01-329-7038	129	1	3110-01-331-1340	165	3
5310-01-329-7043	192	22	2930-01-331-1731	45	6
5970-01-329-7358	206	14	3020-01-331-1905	8	10
2540-01-329-8654	219	3	4730-01-331-2844	49	1
4330-01-329-8821	175	8	2530-01-331-2996	149	2
3040-01-329-9878	173	20	5340-01-331-3781	172	5
2990-01-329-9894	43	6	5905-01-331-4103	89	1
2990-01-329-9895	41	14	5340-01-331-5739	33	13
2990-01-329-9896	41	12		225	2
2990-01-329-9899	41	9	5310-01-331-5832	142	27
2930-01-329-9900	47	1		144	19
2510-01-329-9904	184	5	5905-01-331-6366	87	1
2510-01-329-9905	184	1	4730-01-331-6629	45	2
3020-01-329-9942	142	60	4710-01-331-6720	49	6
2530-01-330-0002	149	2	5340-01-331-7277	249	12
2990-01-330-0004	41	15	5340-01-331-7290	205	21
2530-01-330-0030	170	2	5325-01-331-7516	172	13
3020-01-330-0034	173	26	4720-01-331-7810	BULK	25
4820-01-330-0547	173	11	2530-01-331-8709	151	7
3040-01-330-0646	142	30	5430-01-331-8795	45	10

CROSS-REFERENCE INDEXES

STOCK NUMBER	NATIONAL STOCK NUMBER INDEX		STOCK NUMBER	FIG.	ITEM
	FIG.	ITEM			
5970-01-331-8972	207	15	3460-01-332-2798	205	3
5315-01-331-9241	60	31	5310-01-332-3254	46	4
5330-01-331-9283	54	7		47	2
5325-01-331-9372	54	13		201	73
5310-01-331-9416	54	20		207	8
5340-01-331-9466	15	1	5342-01-332-3584	44	16
	154	31	2530-01-332-5446	150	34
	234	7	4730-01-332-5450	35	2
5340-01-331-9498	91	49	2990-01-332-5459	89	10
5365-01-331-9503	54	10	4730-01-332-5483	150	13
5340-01-331-9610	54	24		151	22
5342-01-331-9612	220	1	3040-01-332-5490	172	42
5310-01-331-9710	168	1	4730-01-332-5824	31	15
5935-01-331-9749	64	8	4730-01-332-5941	31	17
5342-01-331-9919	42	9	4720-01-332-5963	154	14
5930-01-332-0680	68	21	4720-01-332-5964	22	1
	68	32	4720-01-332-5973	BULK	9
	69	7	4730-01-332-5998	36	15
5365-01-332-0913	44	24	4730-01-332-5999	152	6
4820-01-332-1311	55	4	4730-01-332-6000	151	26
4720-01-332-1335	22	4	4720-01-332-6010	35	3
3030-01-332-1351	56	10	2510-01-332-6037	220	20
2510-01-332-1356	205	11	2590-01-332-6050	15	16
5430-01-332-1373	45	17	2920-01-332-6051	60	51
5430-01-332-1374	209	4	4730-01-332-6117	154	12
2530-01-332-1393	156	56	4710-01-332-6121	32	1
2530-01-332-1394	158	5	5305-01-332-6506	32	14
2540-01-332-1403	209	1	5310-01-332-6518	32	12
5305-01-332-1487	23	4	5365-01-332-6546	3	3
5305-01-332-1488	23	3	5340-01-332-6583	15	11
5365-01-332-1521	208	1	5340-01-332-6584	210	9
5340-01-332-1538	207	18	5340-01-332-6585	210	17
5340-01-332-1539	45	21	5340-01-332-6588	210	6
5340-01-332-1540	45	11	5340-01-332-6590	154	22
4820-01-332-1574	31	16	5340-01-332-6591	219	11
4820-01-332-1578	155	50	5340-01-332-6653	210	3
2530-01-332-1586	152	7	5340-01-332-6654	158	26
2530-01-332-1587	152	1	5340-01-332-6692	219	14
4720-01-332-1598	163	2	5340-01-332-6696	66	16
4720-01-332-1604	220	10		96	39
2590-01-332-1628	210	14		99	5
3040-01-332-1633	60	27		210	16
3040-01-332-1634	60	45		222	17
3040-01-332-1670	172	20	5340-01-332-6705	220	28
4730-01-332-2389	161	4	3120-01-332-7172	220	17
4710-01-332-2408	35	4	5305-01-332-7219	220	11
4730-01-332-2428	15	19	5305-01-332-7226	163	14
4730-01-332-2432	153	34	5305-01-332-7228	56	12
	154	13	5310-01-332-7253	219	17
4730-01-332-2465	151	20		220	19

CROSS-REFERENCE INDEXES

STOCK NUMBER	NATIONAL STOCK NUMBER INDEX		STOCK NUMBER	FIG.	ITEM
	FIG.	ITEM			
5310-01-332-7278	32	13	5120-01-333-4744	260	2
5330-01-332-7292	33	6	5305-01-333-5272	59	6
5340-01-332-7372	33	5	5342-01-333-5425	36	14
	33	16	6220-01-333-5592	69	6
5340-01-332-7473	91	6	6130-01-333-5850	57	25
	153	4	5975-01-333-5872	150	2
	154	32	5975-01-333-5974	65	22
	155	2		96	3
5305-01-332-7560	219	8		97	5
5340-01-332-7595	64	1		99	4
5342-01-332-7614	3	4		100	8
5342-01-332-7615	3	6		100	18
4820-01-332-7647	226	6		103	48
2540-01-332-7679	KITS		5342-01-333-5993	45	4
2530-01-332-8475	150	18	5340-01-333-6039	4	3
4720-01-332-8491	BULK	26	5940-01-333-6368	63	7
4820-01-332-8542	172	30		64	5
4820-01-333-0095	153	21	5310-01-333-6436	80	1
	156	59		92	21
	158	18		102	1
5340-01-333-0160	43	1		151	19
2510-01-333-0199	191	9		151	29
2510-01-333-0206	4	12		152	30
2940-01-333-0720	32	17	5340-01-333-6624	220	26
2530-01-333-0721	220	27	6695-01-333-6750	68	13
2530-01-333-0722	220	25		69	5
2940-01-333-0723	32	6	6680-01-333-6757	15	14
2940-01-333-0724	32	15	6130-01-333-6779	57	66
4820-01-333-0732	153	27	5340-01-333-8208	153	11
2510-01-333-0740	33	8		156	43
2930-01-333-0743	45	20		158	8
2930-01-333-0744	45	16	2520-01-333-8359	142	49
2530-01-333-0748	153	20	2520-01-333-8361	142	25
5970-01-333-1156	207	16	5340-01-333-8889	56	16
5315-01-333-2771	261	9		91	19
5305-01-333-2822	79	7	6150-01-333-9318	60	3
	203	27	3990-01-333-9342	220	2
	226	9	5340-01-334-0466	208	6
5340-01-333-3003	45	8	5340-01-334-1362	210	10
5365-01-333-3575	3	5	5330-01-334-2725	18	8
5305-01-333-4516	220	23	5330-01-334-2726	25	12
5310-01-333-4537	4	5	3120-01-334-2740	KITS	
5310-01-333-4538	187	8	3120-01-334-2776	11	1
	222	28	3120-01-334-2777	11	1
5310-01-333-4542	219	19	2995-01-334-2795	20	2
5365-01-333-4556	4	9	5306-01-334-2813	219	5
5340-01-333-4614	15	22	5340-01-334-2880	80	16
	91	17		153	5
	154	35		155	5
5340-01-333-4670	31	13		234	13

CROSS-REFERENCE INDEXES

STOCK NUMBER	NATIONAL STOCK NUMBER INDEX		STOCK NUMBER	FIG.	ITEM
	FIG.	ITEM			
5342-01-334-3569	15	8	5935-01-336-5394	93	14
5310-01-334-3646	173	35		103	62
5305-01-334-4468	18	22	5935-01-336-5395	65	12
5325-01-334-4808	82	8	5935-01-336-5396	65	28
	227	20	5935-01-336-5399	63	14
5330-01-334-7187	11	4	5935-01-336-5400	96	32
	173	36	5935-01-336-5401	93	16
5340-01-334-7424	55	2		103	53
2815-01-334-8096	KITS		5930-01-336-5441	86	4
4310-01-334-8636	KITS		5930-01-336-5442	231	22
3120-01-334-9614	11	1	5340-01-336-5449	216	6
5940-01-335-2924	57	12	5940-01-336-5777	65	3
6685-01-335-4471	246	1		93	46
5340-01-335-6703	56	5	5340-01-336-5923	KITS	
3020-01-335-7394	20	14	5340-01-336-5953	176	19
5342-01-335-7854	4	6	5340-01-336-5954	176	24
4730-01-335-9621	161	16	5340-01-336-5955	201	40
	240	28	5340-01-336-5957	176	30
5340-01-336-0120	210	12	5340-01-336-5970	201	78
5925-01-336-1734	74	13	5340-01-336-5971	201	69
5935-01-336-1792	66	12	4010-01-336-5983	181	17
5340-01-336-2447	49	22	5340-01-336-6029	183	1
5340-01-336-3269	71	3	5340-01-336-6030	201	26
5930-01-336-3684	93	52	5340-01-336-6115	68	42
5935-01-336-3693	93	62	5310-01-336-6222	24	1
	255	18	5305-01-336-6238	79	4
5935-01-336-3694	93	53	5940-01-336-6322	65	4
5935-01-336-3695	93	56		93	57
5340-01-336-3911	233	14		96	24
5340-01-336-3928	181	19		108	6
5340-01-336-3930	71	17		109	9
5340-01-336-3932	201	95		255	14
5340-01-336-3933	231	2	5940-01-336-6323	65	18
5340-01-336-3934	212	13	5940-01-336-6324	65	17
5340-01-336-3936	182	22	5940-01-336-6325	93	41
5340-01-336-3938	201	92		101	10
5340-01-336-3962	216	7	5940-01-336-6326	68	19
5340-01-336-4022	199	16		93	5
5340-01-336-4024	201	98		103	52
5340-01-336-4025	230	14	5940-01-336-6327	65	9
5340-01-336-4248	216	10		112	4
5342-01-336-4250	197	13	5940-01-336-6329	109	3
5340-01-336-4251	201	55	5940-01-336-6331	67	14
5930-01-336-5334	79	16	5935-01-336-6408	66	10
	96	20	5935-01-336-6409	65	24
	98	8		117	18
	103	19	5935-01-336-6410	93	59
5310-01-336-5344	71	4		255	17
5310-01-336-5345	229	7	5935-01-336-6411	96	34
5330-01-336-5360	230	11	5935-01-336-6412	93	27

CROSS-REFERENCE INDEXES

STOCK NUMBER	NATIONAL STOCK NUMBER INDEX		STOCK NUMBER	FIG.	ITEM
	FIG.	ITEM			
5935-01-336-6413	93	31	5325-01-336-6929	227	24
5340-01-336-6442	201	96	4730-01-336-6945	135	13
5340-01-336-6446	187	6	5340-01-336-6976	176	35
5340-01-336-6447	82	13	5340-01-336-6978	182	16
5365-01-336-6449	201	58	5305-01-336-7014	224	2
5365-01-336-6450	201	75	5342-01-336-7037	197	6
	227	23	5940-01-336-7056	65	13
5365-01-336-6451	227	2		65	15
6150-01-336-6469	95	1		93	44
6150-01-336-6470	68	22		103	10
6150-01-336-6472	99	1		103	18
6150-01-336-6477	91	12	5940-01-336-7061	68	38
6150-01-336-6478	59	9	5940-01-336-7062	109	2
6150-01-336-6489	78	2	5940-01-336-7095	65	29
5340-01-336-6531	253	8	5330-01-336-7291	60	70
5940-01-336-6544	66	14	5342-01-336-7391	154	24
5340-01-336-6547	201	93		155	46
5340-01-336-6549	182	16		156	35
5305-01-336-6595	68	36	5340-01-336-7410	201	91
	201	17	5305-01-336-7543	214	5
5305-01-336-6596	201	54	5305-01-336-7550	215	6
5305-01-336-6597	201	82		216	8
5305-01-336-6598	231	26	5305-01-336-7551	229	14
5340-01-336-6663	72	4		230	26
5340-01-336-6665	176	18		232	3
6145-01-336-6678	61	5	5310-01-336-7579	135	23
5310-01-336-6681	186	10		176	10
5330-01-336-6720	79	2		181	2
5305-01-336-6730	214	12	5340-01-336-7647	229	2
5310-01-336-6745	186	8	5365-01-336-7656	72	5
5340-01-336-6758	205	19	5365-01-336-7657	227	3
5340-01-336-6759	205	19	5365-01-336-7658	213	3
5365-01-336-6774	60	69	5365-01-336-7659	217	6
5340-01-336-6809	201	1	5307-01-336-7673	201	25
5306-01-336-6829	181	9	5325-01-336-7688	201	79
5305-01-336-6830	201	11	5340-01-336-7696	201	15
	230	23	5340-01-336-7697	201	66
5305-01-336-6838	177	10	5340-01-336-7794	102	7
5310-01-336-6861	197	7	5340-01-336-7827	201	9
5310-01-336-6864	201	59	5340-01-336-7829	177	7
5330-01-336-6893	214	9	5340-01-336-7992	182	3
5935-01-336-6900	93	50	4720-01-336-8154	BULK	22
	101	7	5310-01-336-8850	28	7
5340-01-336-6909	181	15	5340-01-336-8885	6	25
5340-01-336-6911	204	12	5340-01-336-9041	204	9
5340-01-336-6914	222	16	5930-01-336-9056	68	11
5340-01-336-6918	182	19	5935-01-336-9065	65	10
5340-01-336-6920	217	5		93	28
5325-01-336-6929	94	10	5305-01-336-9151	71	1
	99	6	5305-01-336-9466	75	4

CROSS-REFERENCE INDEXES

STOCK NUMBER	NATIONAL STOCK NUMBER INDEX		STOCK NUMBER	FIG.	ITEM
	FIG.	ITEM			
5305-01-336-9466	200	3	5310-01-337-2353	201	27
	215	1		230	21
	225	25		253	4
	230	19	5335-01-337-2521	33	10
5305-01-336-9467	202	2	5305-01-337-3258	227	10
5340-01-336-9560	92	22	5940-01-337-3317	93	49
4720-01-336-9719	230	24	5940-01-337-3318	93	13
5310-01-336-9731	201	50	5940-01-337-3319	93	10
5310-01-336-9850	135	22		109	5
	176	11	6150-01-337-3427	68	26
	181	12	2540-01-337-3725	186	1
5310-01-336-9856	201	101	2930-01-337-3765	233	3
5935-01-336-9923	93	4	5305-01-337-3804	199	7
	103	13	5305-01-337-3805	83	1
	103	41		203	37
5935-01-336-9924	94	6	5940-01-337-3812	65	33
5999-01-337-0088	79	15	4720-01-337-3960	BULK	23
	96	19	4720-01-337-3961	BULK	24
4520-01-337-0207	230	27	2540-01-337-4096	230	29
2590-01-337-0211	216	5	2540-01-337-4097	230	1
2510-01-337-0230	179	5	2540-01-337-4098	230	18
2510-01-337-0231	222	5	2540-01-337-4105	86	3
2510-01-337-0232	230	30	2510-01-337-4121	212	11
2510-01-337-0233	214	3	2510-01-337-4122	212	8
2510-01-337-0246	214	10	2510-01-337-4125	213	1
2510-01-337-0247	214	17	2510-01-337-4130	212	12
5935-01-337-0288	67	9	2920-01-337-4135	68	2
5306-01-337-0351	92	18	2990-01-337-4138	84	4
5310-01-337-0369	35	8	2510-01-337-4143	198	5
	204	2	2510-01-337-4144	198	14
5310-01-337-0370	177	17	3040-01-337-4160	98	7
5365-01-337-0371	176	23	3020-01-337-4220	25	6
5365-01-337-0372	181	11	5305-01-337-4267	176	45
5340-01-337-0380	182	4	5220-01-337-4412	268	7
5325-01-337-0387	98	4	2540-01-337-4416	183	10
5340-01-337-0399	204	3	4730-01-337-4479	225	13
2590-01-337-0425	176	38	5305-01-337-4796	186	15
2590-01-337-0426	176	25	5940-01-337-4910	68	3
5310-01-337-0905	187	3		69	11
5935-01-337-1028	93	64		101	29
	94	17	6150-01-337-5038	93	34
	108	7		93	43
	108	12	6150-01-337-5039	93	36
	109	8	5305-01-337-5637	106	1
	255	34		107	3
5340-01-337-1033	176	41	5340-01-337-6577	229	6
5340-01-337-1034	176	40	2530-01-337-7345	173	1
2510-01-337-2114	214	14	4710-01-337-7366	230	8
2510-01-337-2115	214	8	4710-01-337-7367	230	9
2510-01-337-2116	214	2	3040-01-337-7428	230	10

CROSS-REFERENCE INDEXES

STOCK NUMBER	NATIONAL STOCK NUMBER INDEX				
	FIG.	ITEM	STOCK NUMBER	FIG.	ITEM
3040-01-337-7428	233	17	6220-01-338-5772	71	2
2510-01-337-7592	214	11	6220-01-338-5773	82	7
4720-01-337-8833	230	12	6220-01-338-5779	71	9
2510-01-337-8841	212	2	6220-01-338-5780	71	8
2510-01-337-8843	213	6	6220-01-338-5781	71	11
2540-01-337-8845	201	62	6250-01-338-5816	71	19
2540-01-337-8846	201	48	9390-01-338-5872	214	15
2590-01-337-8936	216	3	9390-01-338-5873	214	1
2540-01-337-9004	186	18	6220-01-338-5928	79	25
5340-01-337-9020	201	87	6620-01-338-5952	71	24
5340-01-337-9231	222	3	6220-01-338-5992	80	18
3020-01-337-9277	20	11	6220-01-338-5993	80	2
2540-01-337-9332	216	9	2590-01-338-6044	79	25
5340-01-337-9995	201	71	5310-01-338-6844	26	3
5305-01-338-0428	50	2	5340-01-338-7068	200	10
	161	11	5120-01-338-7182	260	4
5306-01-338-0894	24	6	5305-01-338-7295	176	27
2920-01-338-1069	68	16	5305-01-338-7313	202	2
2540-01-338-1710	198	6	2590-01-338-7391	197	12
5940-01-338-1964	65	19	2540-01-338-7454	222	2
5930-01-338-2035	86	2	2540-01-338-7727	183	6
6220-01-338-2055	79	23	5305-01-338-8155	136	8
6220-01-338-2057	83	2	6220-01-338-9050	82	12
6150-01-338-2076	103	54	5975-01-338-9190	67	10
2510-01-338-2317	201	46		76	3
2530-01-338-2348	138	6		225	32
3040-01-338-2410	230	13		231	25
2815-01-338-2566	12	2	5355-01-338-9457	231	18
5340-01-338-2877	182	18	6220-01-338-9504	79	5
5340-01-338-2907	178	9	6150-01-338-9777	91	10
5340-01-338-2908	179	11	2510-01-338-9982	211	8
5940-01-338-2929	67	12	2540-01-339-0554	182	2
5340-01-338-3189	222	12	5305-01-339-0901	53	4
5905-01-338-3434	233	9	6150-01-339-1180	94	1
5935-01-338-3532	65	31	6220-01-339-1192	79	3
	66	7	6220-01-339-1193	82	2
	96	17	6150-01-339-1204	68	17
5935-01-338-3533	79	14	5310-01-339-1331	175	5
5935-01-338-3534	65	11	2510-01-339-2317	222	13
5999-01-338-3808	77	2	5935-01-339-3227	66	17
5306-01-338-3981	124	12		96	37
	125	4		99	2
5310-01-338-4116	201	2	5340-01-339-4266	76	4
	203	38		91	14
	230	25		152	31
4820-01-338-4270	26	7		249	20
2510-01-338-4486	176	31	2920-01-339-4308	59	5
2510-01-338-4491	181	20	5340-01-339-4331	212	1
3020-01-338-4547	24	3	6220-01-339-5102	79	23
2540-01-338-4621	183	10	5975-01-339-5950	93	33

CROSS-REFERENCE INDEXES

STOCK NUMBER	NATIONAL STOCK NUMBER INDEX				
	FIG.	ITEM	STOCK NUMBER	FIG.	ITEM
6220-01-339-6015	82	1	5305-01-341-8926	55	14
6150-01-339-6118	91	2	6685-01-341-9125	71	15
6150-01-339-6119	91	1	5940-01-342-0558	65	8
5940-01-339-6981	68	37		103	31
5340-01-339-7022	76	7	5940-01-342-0559	93	54
6685-01-339-8261	71	25	5940-01-342-1640	65	6
6150-01-339-8299	93	38		93	20
5340-01-339-8805	231	17		96	33
5940-01-339-9566	93	17		109	10
	94	19		255	27
5975-01-339-9574	65	26	5940-01-342-3882	96	23
	104	5		98	9
	110	23	5340-01-342-5635	27	20
	117	17	5935-01-342-5944	93	58
6150-01-339-9891	91	16	5310-01-343-1030	192	9
5940-01-340-0586	99	3	5940-01-343-1262	93	24
5940-01-340-0587	65	7		101	23
	93	63		255	32
	94	18	5975-01-343-1290	BULK	5
	96	29	5330-01-344-0636	147	11
	108	8	5970-01-344-1070	79	17
	109	7		96	21
	110	20		98	3
	112	8		103	21
5940-01-340-0588	65	5		103	35
	96	36	5342-01-344-3727	214	16
	112	6	5306-01-344-6714	177	19
5975-01-340-0600	67	17	2590-01-344-8439	201	10
5340-01-340-5633	31	11	6240-01-345-0526	68	6
6160-01-340-8837	92	15	5305-01-345-2449	142	12
6160-01-340-8856	92	1	5365-01-345-2513	203	54
5940-01-340-9064	93	9	5365-01-345-4056	203	20
	93	29	5340-01-345-4647	49	16
	110	15	5340-01-345-4692	244	5
5305-01-340-9857	226	7	5360-01-345-5143	203	16
5940-01-341-0525	93	3	5360-01-345-5386	121	3
	103	29	5340-01-345-5533	203	48
	109	12	5340-01-345-5534	201	60
5306-01-341-2895	199	10	2540-01-345-5736	203	36
6240-01-341-3770	79	11	2540-01-345-5746	203	18
6150-01-341-4886	57	61	2540-01-345-5966	203	28
5940-01-341-7689	68	18	5305-01-345-6545	203	8
	93	51		203	35
5970-01-341-7696	93	32	5340-01-345-6569	203	12
	96	31	5305-01-345-6582	203	56
5970-01-341-7697	93	30	5340-01-345-9873	203	42
	96	35	5340-01-345-9874	203	52
6220-01-341-7723	71	14	2540-01-346-0736	203	55
6150-01-341-7737	103	54	5310-01-346-1594	203	41
5305-01-341-8825	142	69		203	53

CROSS-REFERENCE INDEXES

STOCK NUMBER	NATIONAL STOCK NUMBER INDEX				
	FIG.	ITEM	STOCK NUMBER	FIG.	ITEM
2540-01-346-1813	203	18	5340-01-350-2444	226	22
5305-01-346-2284	201	56	4730-01-350-3589	29	5
3040-01-346-3237	203	30		161	10
3040-01-346-3238	203	31	2590-01-350-4238	252	6
3040-01-346-3239	203	29	5340-01-350-7062	203	62
3040-01-346-3240	203	30	5305-01-350-7067	219	20
3040-01-346-3241	203	31	5325-01-350-7068	203	19
2590-01-346-3243	203	5		203	32
5305-01-346-3694	91	36	5325-01-350-7069	203	19
	156	17	5342-01-350-7071	88	5
5330-01-346-3816	33	18	5310-01-350-7074	65	2
5307-01-346-8672	140	16		93	26
5305-01-346-9416	32	7	5975-01-350-7083	201	24
5340-01-346-9470	32	11	9905-01-352-2213	111	3
5340-01-346-9471	32	10	5340-01-352-4352	60	65
2540-01-346-9851	203	57	6150-01-353-1002	93	35
2540-01-346-9852	203	25	5180-01-353-2518	258	8
2540-01-346-9853	203	25	5120-01-353-2520	264	7
5935-01-347-2657	109	4	5120-01-353-2521	260	6
	255	38	5180-01-353-2523	266	6
5940-01-347-3383	96	2	5120-01-353-2524	269	4
	97	2	5935-01-353-2532	257	10
5340-01-347-5917	201	57	5120-01-353-2534	258	9
5940-01-347-6142	93	25	5210-01-353-2535	270	9
	94	5	5940-01-353-3175	66	18
	112	3		67	4
	255	11		104	3
5940-01-347-6143	69	9	6150-01-353-4812	93	37
	101	6	4940-01-353-7038	265	2
	255	10	5120-01-353-7039	270	11
5310-01-347-7051	32	9	5120-01-353-7040	270	12
4730-01-347-9326	140	5	5180-01-353-7041	266	8
	141	5	5180-01-353-7042	266	9
5925-01-347-9837	75	2	5120-01-353-7043	269	14
5365-01-348-2443	203	24	5120-01-353-7059	262	10
6220-01-348-3028	71	10	5120-01-353-7060	261	15
5310-01-348-3195	32	8	5120-01-353-7061	269	6
5340-01-348-5016	203	46	5340-01-353-8466	266	7
2540-01-348-6129	203	55	5340-01-353-8467	266	11
5340-01-348-7014	49	33	5120-01-353-8490	264	3
5640-01-348-9745	207	11	5120-01-353-8513	269	7
5640-01-348-9746	207	10	5120-01-353-8514	262	8
5220-01-348-9747	246	2	5120-01-353-8515	267	6
5935-01-349-0792	93	61	5180-01-353-8516	266	12
4720-01-349-1970	BULK	43	5120-01-353-8517	269	17
8115-01-349-2459	1	3	5120-01-353-8567	267	5
5640-01-349-5289	198	2	5120-01-353-8568	261	2
2520-01-349-9996	33	19	5120-01-353-8569	261	5
4730-01-350-1589	15	18	5340-01-353-8575	266	10
5340-01-350-2444	88	7	5120-01-354-0426	270	6

CROSS-REFERENCE INDEXES

STOCK NUMBER	NATIONAL STOCK NUMBER INDEX		STOCK NUMBER	FIG.	ITEM
	FIG.	ITEM			
5120-01-354-0468	264	8	5365-01-356-0081	20	17
5120-01-354-0469	262	13	5365-01-356-0083	187	9
5120-01-354-0470	261	14		222	26
6150-01-354-2604	259	3	2815-01-356-0764	12	8
5120-01-354-2768	262	11	2815-01-356-0765	12	8
5120-01-354-2769	262	7	2815-01-356-0766	12	9
5120-01-354-2770	261	12	2815-01-356-0767	12	9
5120-01-354-2771	262	9	5305-01-356-1546	19	11
5120-01-354-2772	262	12		20	10
5120-01-354-2773	266	15	5120-01-356-1649	269	16
5120-01-354-2774	266	16	2510-01-356-2309	203	1
5120-01-354-2775	269	11	2510-01-356-2310	203	1
5120-01-354-2776	269	10	2815-01-356-2668	12	9
5120-01-354-2943	264	9	2590-01-356-2690	18	1
5120-01-354-2944	261	8	2910-01-356-2715	89	7
5120-01-354-5673	261	16	5330-01-356-5086	BULK	34
5120-01-354-5674	261	3	5310-01-356-6158	61	3
5310-01-354-5785	82	21	5120-01-356-8911	263	2
2540-01-354-9260	227	15	5365-01-356-8950	192	11
5120-01-354-9442	269	15	5365-01-356-8951	192	11
3940-01-354-9446	264	5	5940-01-357-0069	110	17
5120-01-354-9447	269	5		115	7
5110-01-355-0636	270	5		255	12
5110-01-355-0637	270	8	5120-01-357-0740	263	6
5120-01-355-0844	258	4	5120-01-357-0741	263	5
5120-01-355-0845	258	7	5120-01-357-0742	263	7
5110-01-355-0848	258	3	5120-01-357-0743	263	1
5120-01-355-3011	258	2	5310-01-357-0819	227	8
5120-01-355-3012	258	5	5310-01-357-0820	227	11
5140-01-355-3013	258	11		227	18
4720-01-355-3104	BULK	8	5310-01-357-0821	140	9
5120-01-355-4178	258	10		141	10
5975-01-355-4570	49	18	5360-01-357-0838	227	9
	76	1	5310-01-357-0854	37	4
5120-01-355-4791	264	2		120	8
5340-01-355-5416	73	3		201	86
5305-01-355-5504	89	6		203	44
5210-01-355-6424	270	7		223	1
5330-01-355-7002	89	8		225	10
4730-01-355-9204	152	20	5310-01-357-0878	145	18
	153	18		227	12
	156	45		227	17
	156	64	5120-01-357-1599	264	4
	158	4	6220-01-357-1883	73	1
	158	15	5120-01-357-2937	258	6
	158	22	5310-01-357-3045	269	13
	160	25	6220-01-357-3672	79	9
	160	32	5120-01-357-4583	264	10
4730-01-355-9205	89	9	5310-01-357-4594	261	7
5305-01-356-0042	144	23	5220-01-357-4913	257	4

CROSS-REFERENCE INDEXES

STOCK NUMBER	NATIONAL STOCK NUMBER INDEX				
	FIG.	ITEM	STOCK NUMBER	FIG.	ITEM
5999-01-357-4951	68	4	5365-01-360-1721	129	2
5905-01-357-4958	68	30	5306-01-360-1970	123	34
2590-01-357-5444	150	35	5306-01-360-2033	128	18
2540-01-357-5687	221	4	5305-01-360-2038	122	7
	222	9	4820-01-360-2354	134	47
2540-01-357-5696	232	6	4820-01-360-2355	134	59
4730-01-357-8736	137	4	4820-01-360-2421	134	40
2815-01-357-8737	12	8	2940-01-360-3389	134	51
6220-01-357-9487	79	5	4810-01-360-4314	134	38
5330-01-358-1289	175	9	4820-01-360-4408	134	87
5340-01-358-3686	22	6	4810-01-360-4433	134	48
5365-01-358-4625	20	17	4730-01-360-4458	134	50
5340-01-358-4652	98	5	5315-01-360-4771	134	44
5180-01-358-5231	258	1	5315-01-360-4772	134	75
5305-01-358-6668	79	18	5930-01-360-5002	134	27
5307-01-359-0178	23	11	5945-01-360-5161	134	34
5120-01-359-1234	261	11	5945-01-360-5162	134	31
5120-01-359-2857	263	8	5945-01-360-5163	134	71
6150-01-359-5773	93	42	5315-01-360-5913	125	10
5360-01-359-7944	134	39	5315-01-360-5914	134	90
5360-01-359-7945	134	46	5340-01-360-5983	134	57
5360-01-359-7946	134	60	5340-01-360-5984	134	58
5360-01-359-7947	134	63	5330-01-360-6006	134	25
5360-01-359-7948	134	66	5331-01-360-6013	134	33
5360-01-359-7949	134	69		134	73
5360-01-359-7950	134	77	5331-01-360-6016	134	36
5360-01-359-7951	134	80	5331-01-360-6017	85	2
5360-01-359-7952	134	83		85	6
5340-01-359-8849	134	45		134	32
5340-01-359-8850	134	61	5331-01-360-6018	129	3
5340-01-359-8851	134	62	4820-01-360-6160	134	64
5340-01-359-8852	134	67	4820-01-360-6161	134	81
5340-01-359-8853	134	68	4820-01-360-6162	134	82
5340-01-359-8854	134	84	5315-01-360-6729	134	37
5305-01-359-8904	79	6	5330-01-360-7520	124	14
5365-01-359-9336	134	94	3120-01-360-7544	126	5
5340-01-359-9416	134	78		129	12
5306-01-359-9429	134	24	5331-01-360-7725	134	99
5305-01-359-9445	130	1	5340-01-360-7812	134	56
5320-01-360-0925	130	4	5330-01-360-7826	120	6
5365-01-360-0937	134	92	5330-01-360-9034	134	49
5365-01-360-1017	129	2	4820-01-360-9095	134	70
5365-01-360-1018	129	2	5330-01-360-9103	129	21
5365-01-360-1019	129	2	5331-01-361-0235	134	93
5365-01-360-1020	129	2	4820-01-361-1924	134	65
5365-01-360-1021	129	2	2590-01-361-2388	225	34
5365-01-360-1022	129	2	2540-01-361-5146	225	31
5340-01-360-1033	85	3	6695-01-361-6056	85	1
5340-01-360-1048	124	13	6620-01-361-7595	84	3
5340-01-360-1075	134	79	5330-01-361-9785	123	2

CROSS-REFERENCE INDEXES

STOCK NUMBER	NATIONAL STOCK NUMBER INDEX		STOCK NUMBER	FIG.	ITEM
	FIG.	ITEM			
5325-01-362-9783	25	4	5940-01-370-5059	66	11
3110-01-363-1479	25	3		96	27
2520-01-363-6918	142	50	5340-01-371-1658	KITS	
5999-01-363-6922	59	8	4730-01-371-4370	152	18
8145-01-364-1126	238	20		153	16
8145-01-364-1131	238	1		156	47
5999-01-364-1237	104	12		156	62
4720-01-364-3392	BULK	44		158	2
5935-01-364-3646	254	5		158	13
5315-01-364-3744	146	23		158	20
4720-01-364-4437	BULK	13		160	27
3040-01-364-4466	25	5		160	30
3040-01-364-4500	25	7	5342-01-371-6339	238	25
5935-01-364-4696	104	13	5120-01-371-7369	264	1
5305-01-364-4778	150	17	5935-01-372-0218	64	7
5305-01-364-4803	203	33	5999-01-372-4955	113	4
5935-01-364-5211	105	5	5330-01-372-5690	238	26
5935-01-364-7773	255	22	5999-01-373-4494	117	11
2510-01-364-8287	238	15	5340-01-376-0542	252	4
5310-01-365-0234	203	58	5310-01-379-8077	56	7
5305-01-365-0343	201	3	8145-01-386-1304	119	3
5340-01-365-1034	104	10	4940-01-386-6108	263	3
5340-01-365-1035	66	13	4940-01-387-0948	259	5
2510-01-365-5318	203	39	5220-01-388-1460	271	17
4710-01-365-6944	150	21	5331-01-388-1528	134	30
4730-01-365-7023	155	43	2520-01-388-4778	124	11
2510-01-365-7135	201	20	5120-01-388-5623	271	4
2540-01-365-7155	203	11	5330-01-388-7501	143	8
2540-01-365-7156	203	11	5130-01-389-8450	257	3
3040-01-365-7779	25	1	5340-01-391-1349	92	30
2510-01-365-8975	203	4	6680-01-391-8588	70	6
4730-01-365-9072	150	22	6680-01-391-8589	70	3
7690-01-365-9128	238	12	5940-01-391-9982	96	30
5940-01-366-1561	96	28		101	18
5940-01-366-1563	105	4		108	10
5120-01-366-2545	262	15		110	21
2510-01-366-5035	203	39		115	11
2540-01-366-5112	203	7		255	15
2540-01-366-5254	203	6	2940-01-392-0417	48	6
6140-01-366-5533	91	9	5945-01-392-9346	61	2
6150-01-367-0599	92	16	5360-01-392-9389	54	11
6350-01-367-0757	90	3	5330-01-393-5626	54	9
3990-01-367-4625	238	22	4730-01-394-8139	240	3
5340-01-367-6668	149	3		241	20
5340-01-367-7087	KITS		5310-01-395-1250	18	11
2590-01-367-7601	203	7	4730-01-398-7635	6	13
5935-01-367-8677	115	32		17	1
3990-01-367-8803	238	19		30	13
2590-01-368-3478	203	6	5940-01-400-0618	255	35
3990-01-368-7040	238	27	5325-01-406-2124	225	37

CROSS-REFERENCE INDEXES

STOCK NUMBER	NATIONAL STOCK NUMBER INDEX				
	FIG.	ITEM	STOCK NUMBER	FIG.	ITEM
5330-01-406-2130	203	14	6685-01-438-5088	265	7
5935-01-406-3802	66	20	5930-01-438-6328	68	15
5999-01-406-4110	65	37		72	1
	96	14	2520-01-438-7589	136	2
2815-01-406-4883	142	46	5120-01-439-0305	259	9
5310-01-406-6332	230	2	5340-01-439-0816	135	28
5340-01-406-6966	177	6	5360-01-439-2291	190	16
4730-01-407-3710	73	2	5360-01-439-2295	190	24
3120-01-408-7869	197	9	5365-01-439-2357	56	6
5340-01-410-6637	201	7	5342-01-439-2534	247	7
5340-01-410-7065	81	8	4130-01-439-2870	247	3
5305-01-411-3449	81	6	5310-01-439-4256	190	2
6220-01-411-3686	81	1	4710-01-439-4427	15	9
5340-01-411-3823	81	12	4730-01-439-5324	31	18
4730-01-411-7532	6	16	2510-01-439-5341	190	25
	9	12	4730-01-439-5343	49	30
	18	2		135	7
5330-01-411-8119	23	1	4710-01-439-5383	31	19
2940-01-412-5275	17	2	2990-01-439-5607	41	8
6150-01-412-6544	100	1	4730-01-439-6599	31	2
6150-01-412-6546	100	12	4730-01-439-6613	49	4
2990-01-413-1395	84	7	5331-01-439-6677	134	98
5342-01-414-2177	62	2	3020-01-439-7085	56	11
2835-01-414-8485	10	2	2510-01-439-7490	190	1
2990-01-415-2366	84	2	1005-01-439-9229	244	1
2815-01-415-3248	12	1	5315-01-440-0441	248	2
4730-01-416-3262	150	19	5220-01-440-0686	265	5
5940-01-419-5877	255	33	5315-01-440-1440	190	22
5305-01-421-4222	136	3	3040-01-440-1841	190	28
	137	3	6220-01-440-2402	70	2
5315-01-422-4331	203	63	5342-01-440-4428	34	31
2540-01-422-7763	203	64	5340-01-440-4885	161	5
2540-01-422-7773	203	64	5365-01-440-5246	23	7
5999-01-422-9740	67	6	2815-01-440-5796	23	12
2530-01-424-0396	164	7	2815-01-440-5799	23	9
5331-01-424-6629	134	95	5340-01-440-6000	34	16
2540-01-428-2983	205	6	5310-01-440-6750	54	28
2540-01-428-2985	205	6	5331-01-440-7531	34	30
2590-01-428-2988	205	4	5330-01-440-7532	110	27
6140-01-431-1172	91	11	4720-01-440-7809	161	3
2910-01-431-1324	134	100		161	18
6250-01-432-9541	93	72	6220-01-440-8056	80	5
5930-01-435-0397	87	4	6220-01-440-8065	80	5
2590-01-435-4231	71	6	5306-01-440-8202	56	9
3030-01-435-7194	54	36	5330-01-440-8651	134	97
6150-01-435-7199	93	1	4730-01-440-9431	48	20
2835-01-435-8024	162	1	5310-01-440-9675	54	27
2930-01-437-0479	54	1	4730-01-440-9730	161	2
5120-01-437-1725	262	1	3020-01-441-0430	24	5
5310-01-438-2370	247	5	3020-01-441-0433	8	7

CROSS-REFERENCE INDEXES

STOCK NUMBER	NATIONAL STOCK NUMBER INDEX		STOCK NUMBER	FIG.	ITEM
	FIG.	ITEM			
4810-01-441-0851	48	7	2910-01-443-0385	38	1
5340-01-441-1103	15	23	6250-01-443-0403	70	4
5340-01-441-1668	154	30		70	8
4720-01-441-1677	161	17	5306-01-443-1230	56	13
2520-01-441-1704	KITS		5930-01-443-1947	87	5
2930-01-441-1726	KITS		5342-01-443-2557	233	32
2520-01-441-1736	KITS		4720-01-443-3020	14	7
2530-01-441-1881	165	8	4130-01-443-3814	233	4
4720-01-441-2384	161	6	5305-01-443-4906	54	35
5365-01-441-2674	233	21	4720-01-443-5051	155	7
5365-01-441-2679	233	19		155	8
5305-01-441-3307	230	7	4820-01-443-6639	160	16
4730-01-441-3513	150	37	4440-01-443-9031	160	14
5935-01-441-4919	97	3	5325-01-443-9525	231	28
4730-01-441-6491	231	14	5305-01-444-0594	249	16
5940-01-441-7557	110	12	5305-01-444-0597	70	5
2540-01-441-7689	231	5		70	7
4730-01-441-8605	155	67	2990-01-444-2368	160	21
	156	52	5930-01-444-3672	250	13
5305-01-441-8719	145	26	5325-01-445-0252	233	24
	230	20	4130-01-445-0443	250	7
4130-01-441-9145	250	3	5935-01-445-5144	115	21
5305-01-441-9376	59	2	5310-01-445-9489	146	11
	150	36	6220-01-445-9920	81	11
	231	19	6220-01-446-3528	81	9
5330-01-442-0443	151	34	5365-01-446-3725	36	4
6220-01-442-1071	70	1	5330-01-446-4690	81	10
5930-01-442-1113	86	1	5940-01-446-7581	108	3
4820-01-442-1673	233	31	5940-01-446-7607	103	47
4720-01-442-2305	249	3	5325-01-446-8320	104	11
4720-01-442-2306	249	1		105	3
4720-01-442-2371	249	8	5340-01-446-9624	39	8
4720-01-442-2730	249	14	4720-01-447-0911	BULK	38
4720-01-442-2732	249	9	4730-01-447-3214	39	6
4730-01-442-3515	15	20	4810-01-447-4578	39	7
2540-01-442-4550	233	28	6150-01-447-5600	39	20
2590-01-442-5038	231	27	6150-01-447-5601	39	19
4710-01-442-5074	249	4	5935-01-447-6280	67	2
4720-01-442-5077	249	15	5340-01-447-6352	110	29
2510-01-442-5470	201	6	5305-01-447-6368	146	3
2540-01-442-5480	218	1		147	9
2540-01-442-5560	218	2	5935-01-447-6852	101	30
2540-01-442-6101	218	7		108	2
5940-01-442-6298	115	20	2910-01-447-7956	39	3
4820-01-442-8339	162	47	2910-01-447-8036	39	1
6685-01-442-8552	233	5	5945-01-447-9142	39	4
2510-01-442-9289	201	4	2530-01-447-9838	226	19
2540-01-442-9346	225	12	5945-01-448-0189	90	8
5305-01-442-9868	162	31	2520-01-448-9159	248	1
5340-01-443-0317	134	96	4730-01-448-9840	49	31

CROSS-REFERENCE INDEXES

STOCK NUMBER	NATIONAL STOCK NUMBER INDEX		STOCK NUMBER	FIG.	ITEM
	FIG.	ITEM			
4710-01-448-9982	49	32	5331-01-466-9013	128	14
2530-01-452-4670	KITS		5330-01-466-9015	124	2
5120-01-452-6036	265		5330-01-467-6287	142	42
5360-01-453-2343	125	12	5940-01-469-7988	96	4
5315-01-453-6936	125	13		97	4
5120-01-455-0436	262	18		117	15
4730-01-455-3774	29	4	2530-01-470-1777	142	29
5999-01-458-0082	110	11	6150-01-470-3205	104	17
4730-01-459-0000	153	28	5935-01-470-4143	64	6
2520-01-459-1944	118	1	5935-01-470-8337	254	3
5935-01-459-9845	134	20	5935-01-471-1122	103	4
	134	27	2520-01-471-5061	141	1
5935-01-459-9848	134	7	2520-01-473-7409	137	1
5935-01-459-9907	134	5	5310-01-474-8453	36	7
5935-01-459-9908	134	8	5310-01-474-8462	4	11
4820-01-460-0245	134	43	5310-01-474-8888	261	4
5360-01-460-1139	134	42	5310-01-474-8891	261	4
5360-01-460-1141	134	86	5340-01-474-9581	203	23
5331-01-460-1190	134	9	5340-01-474-9584	22	8
5935-01-460-2272	115	22		135	5
5935-01-460-2344	134	22	5331-01-474-9719	134	72
5935-01-460-2478	115	30	5340-01-474-9800	55	9
5935-01-460-2479	115	31	5340-01-474-9827	55	13
5930-01-460-2495	115	26	5930-01-475-0077	107	5
5935-01-460-2601	115	29	6680-01-475-0101	246	3
5935-01-460-2604	115	23	5999-01-475-0215	241	24
5935-01-460-7491	115	27	5930-01-475-0242	271	3
5935-01-460-8050	115	24	3120-01-475-1603	271	16
5330-01-461-0587	127	1	5365-01-475-2572	261	3
5330-01-461-0588	134	10	4720-01-475-2616	240	32
4820-01-461-0598	134	76	5340-01-475-3164	240	5
4820-01-461-0599	134	41	5340-01-475-3497	265	9
5940-01-461-2235	134	21	5340-01-475-3622	241	8
5940-01-461-2236	134	18	2990-01-475-3969	240	27
	134	20	5325-01-475-4635	271	7
5940-01-462-1717	96	38	5325-01-475-4745	271	8
	117	23	5305-01-475-4853	134	26
5940-01-462-1718	117	13	2530-01-475-4935	107	1
4730-01-464-2348	6	15	5315-01-475-5229	266	17
	18	3	5975-01-475-5309	104	9
	50	3	5120-01-475-7608	271	10
4730-01-464-2375	50	4	5120-01-475-7609	271	20
5935-01-466-0260	117	26	5120-01-475-7610	271	21
5310-01-466-1602	143	12	2590-01-475-7886	265	10
	144	26	5331-01-475-8687	134	35
5310-01-466-1604	142	2	5330-01-475-9540	164	8
	142	39	5306-01-476-1456	35	9
5305-01-466-4547	141	15	5306-01-476-1458	54	37
	142	63	5180-01-476-2361	271	12
5935-01-466-7448	115	28	5120-01-476-9377	271	14

CROSS-REFERENCE INDEXES

STOCK NUMBER	NATIONAL STOCK NUMBER INDEX		STOCK NUMBER	FIG.	ITEM
	FIG.	ITEM			
5120-01-476-9378	271	9	3120-01-478-7470	129	5
5120-01-476-9379	271	5	3120-01-478-7477	132	6
5120-01-476-9380	271	13	3120-01-478-7481	131	6
5120-01-476-9381	271	22	2530-01-478-7545	164	1
5905-01-477-2349	134	14	6620-01-478-7549	71	23
5120-01-477-2749	271	15	2530-01-478-7603	166	1
5935-01-477-7230	257	11	5935-01-478-7605	103	17
3120-01-478-4833	88	6	5935-01-478-7607	103	9
5340-01-478-4881	134	54	2530-01-478-7619	147	2
5331-01-478-5191	146	7	2530-01-478-7622	147	2
5925-01-478-5959	74	4	5315-01-478-7697	146	24
2990-01-478-6000	41	5	5360-01-478-7764	193	22
2990-01-478-6006	41	3	3040-01-478-7794	225	4
4720-01-478-6009	41	7	2530-01-478-8502	155	44
4720-01-478-6010	BULK	15		156	19
4720-01-478-6012	49	23	5306-01-478-8505	55	1
4720-01-478-6013	BULK	36		193	2
4720-01-478-6021	135	31	3120-01-478-8661	147	10
4720-01-478-6025	135	32	5310-01-478-8671	193	19
4720-01-478-6032	155	40	5310-01-478-8675	193	14
4710-01-478-6094	35	1	5310-01-478-8676	79	20
6680-01-478-6145	120	1	5310-01-478-8683	243	10
4720-01-478-6407	BULK	40	5355-01-478-8725	68	7
6150-01-478-6501	97	1		231	21
6150-01-478-6791	69	1	4720-01-478-8827	135	8
6150-01-478-6801	90	7	5310-01-478-8939	243	9
6150-01-478-6805	109	1	5310-01-478-8946	193	24
6150-01-478-6810	103	27	5310-01-478-8953	193	6
5930-01-478-6816	225	6	5310-01-478-9004	46	6
6150-01-478-6819	98	1	5310-01-478-9014	79	19
6150-01-478-6824	103	1	5310-01-478-9022	194	1
6150-01-478-6828	103	16	5310-01-478-9028	193	35
5315-01-478-6920	46	3		195	9
6250-01-478-6934	68	1		196	11
6210-01-478-7219	71	12	5310-01-478-9035	243	5
6210-01-478-7230	71	13	2540-01-478-9089	69	2
6210-01-478-7235	68	8	2530-01-478-9211	165	7
5331-01-478-7278	123	31	2530-01-478-9345	164	6
5330-01-478-7279	124	16	5325-01-478-9347	130	8
5331-01-478-7281	128	6	5325-01-478-9348	128	11
5330-01-478-7285	128	8	2530-01-478-9360	164	3
5331-01-478-7287	128	15	2590-01-478-9451	88	10
5330-01-478-7289	129	6	2520-01-479-0012	85	5
5330-01-478-7291	129	14	2520-01-479-0035	136	5
5330-01-478-7292	129	15	5306-01-479-0111	165	4
5330-01-478-7293	129	16	5306-01-479-0176	164	5
5331-01-478-7295	129	25	5975-01-479-0207	BULK	6
4820-01-478-7296	156	12	2520-01-479-0244	134	2
5330-01-478-7298	134	89	5305-01-479-0269	243	3
3110-01-478-7434	125	14	5306-01-479-0281	243	7

CROSS-REFERENCE INDEXES

STOCK NUMBER	NATIONAL STOCK NUMBER INDEX		STOCK NUMBER	FIG.	ITEM
	FIG.	ITEM			
5305-01-479-0300	49	15	4820-01-481-3346	30	3
5945-01-479-0302	48	9	4820-01-481-3347	30	11
5305-01-479-0308	193	18	2520-01-481-3350	142	14
5306-01-479-0376	193	8	2520-01-481-3352	142	3
5305-01-479-0499	193	15	2510-01-481-3358	192	7
2520-01-479-0533	168	4	2510-01-481-3359	207	5
5340-01-479-0540	41	6	2510-01-481-3360	192	18
2530-01-479-0541	146	2	4720-01-481-3449	156	40
2530-01-479-0545	146	2	5325-01-481-3468	10	13
2530-01-479-0550	147	2	4720-01-481-3471	154	37
5305-01-479-0553	196	10	5360-01-481-3524	26	26
5340-01-479-0560	49	25	5360-01-481-3525	26	21
5340-01-479-0563	46	7	5360-01-481-3527	26	5
5306-01-479-0577	193	21	2510-01-481-3545	208	29
2530-01-479-0826	147	2	2590-01-481-3550	216	1
2530-01-479-0838	88	4	2590-01-481-3553	216	2
2510-01-479-0934	KITS		2510-01-481-3575	214	10
2510-01-479-0985	189	1	2540-01-481-3578	201	74
2510-01-479-0989	189	3	2510-01-481-3584	229	12
2510-01-479-0990	189	2	2540-01-481-3593	215	2
2510-01-479-0997	189	4	2540-01-481-3597	227	14
2530-01-479-1053	196	9	5325-01-481-3600	200	2
2530-01-479-1066	196	1	5315-01-481-3615	185	13
2530-01-479-1172	196	3	5325-01-481-3622	200	7
2530-01-479-1184	196	12	6220-01-481-3742	79	1
2530-01-479-1357	KITS		4720-01-481-3757	154	36
2930-01-479-1384	45	14	4720-01-481-3760	156	41
2510-01-479-1515	194	9	4720-01-481-3767	37	15
2540-01-479-1522	225	11	2520-01-481-3960	144	1
2540-01-479-1528	228	3	5999-12-301-9403	98	6
2590-01-479-1562	243	2	2530-12-352-2728	168	2
5180-01-479-1626	266	1			
2520-01-479-1629	136	1			
5180-01-479-1630	257	1			
5180-01-479-1631	260	1			
2510-01-479-1632	188	1			
2510-01-479-2207	195	4			
2990-01-479-2450	41	16			
2540-01-479-2467	240	1			
2520-01-479-2470	140	1			
9330-01-479-3259	217	2			
2530-01-479-4198	243	1			
2815-01-479-4199	1	1			
5120-01-479-4986	259	8			
2520-01-479-8832	119	1			
2510-01-480-2400	198	1			
3120-01-481-3139	10	17			
3120-01-481-3166	192	10			
4810-01-481-3229	155	14			
4820-01-481-3343	18	9			

CROSS-REFERENCE INDEXES

CAGEC	PART NUMBER	PART NUMBER INDEX		FIG.	ITEM
			STOCK NUMBER		
60038	A- 46221			51	22
78500	A-1205-B-1432		5330-01-116-1132	138	34
78500	A-1205-V-1556		5330-01-084-1063	146	13
78500	A-1205-X-1428		5330-01-116-5309	138	13
78500	A-2297-D-5334S			142	32
78500	A-3144-D-524		2530-01-318-4214	138	23
78500	A-3144-E-525		2530-01-318-4215	138	23
78500	A-3226-D-1226			142	43
78500	A-3226-N-1236			144	4
78500	A-3226-T-1112		3130-01-325-2662	143	3
78500	A-3235-N-2380		2520-01-481-3350	142	14
78500	A-3260-P-1264S		2520-01-481-3352	142	3
78500	A-3296-A-1093		2520-01-333-8359	142	49
78500	A-3297-T-1346S			142	47
78500	A-3303-P-1030		2815-01-406-4883	142	46
86928	A-703-1		5310-01-336-5345	229	7
85411	A-84-R		2540-01-338-7727	183	6
78225	AA0615		2930-01-222-6696	45	5
58536	AA55569/01-005		5920-01-123-5212	252	3
58536	AA55569/01-011		5920-01-188-6294	74	12
58536	AA5569/01-008			117	2
5A910	AC-12261		6220-01-411-3686	81	1
64678	AMA/Y101506		6250-01-443-0403	70	4
64678	AMA/162316		5220-01-348-9747	246	2
88044	AN3121-1816		6240-00-155-7949	83	5
88044	AN380-4-7		5315-00-013-7214	36	6
				138	21
88044	AN935-616		5310-01-108-6232	247	2
64678	ARS 651B		5340-01-339-8805	231	17
64678	ARS805-0001-000		2540-01-441-7689	231	5
82654	AS-1340		5330-01-111-2281	214	13
73973	AS1040			147	21
35510	A001 4626AA		6115-01-329-1671	57	1
64678	A01-20695-001		5340-01-358-3686	22	6
64678	A01-21192-000		2590-01-332-6050	15	16
64678	A01-21197-000		6680-01-333-6757	15	14
64678	A02-12002-000			145	5
64678	A02-12094-000			145	2
64678	A03-17757-000		2540-01-330-9287	33	2
64678	A03-20547-000		4730-01-332-5824	31	15
64678	A03-28234-201			36	13
64678	A03-30459-000			36	12
64678	A05-12792-000		5340-01-329-4106	44	18
64678	A05-12793-000		5340-01-329-3978	44	7
64678	A05-12793-001		5340-01-329-3979	44	3
64678	A05-12855-000		4710-01-331-6720	49	6
64678	A05-12959-001		2930-01-333-0743	45	20
64678	A05-12959-003		2930-01-333-0744	45	16
64678	A05-12991-000		5430-01-331-8795	45	10
64678	A05-12992-000		5430-01-332-1373	45	17
64678	A05-15513-000		5340-01-479-0563	46	7

CROSS-REFERENCE INDEXES

CAGEC	PART NUMBER	PART NUMBER INDEX		FIG.	ITEM
			STOCK NUMBER		
64678	A05-16317-000		4710-01-448-9982	49	32
64678	A05-16366-005			45	1
64678	A05-16455-000			46	8
64678	A05-17096-000			46	9
64678	A05-17245-000			49	26
64678	A06-09547-005		6150-01-336-6489	78	2
64678	A06-09664-000		6145-01-336-6678	61	5
64678	A06-09664-002			252	9
64678	A06-09664-003		5999-01-338-3808	77	2
64678	A06-14209-072			91	15
64678	A06-14889-001		5930-01-336-5442	231	22
64678	A06-14973-000		6220-01-339-6015	82	1
64678	A06-15605-006		6220-01-338-9504	79	5
64678	A06-15605-007		6220-01-357-9487	79	5
64678	A06-17139-000		6220-01-339-5102	79	23
64678	A06-17139-001		6220-01-338-2055	79	23
64678	A06-17158-000		2510-01-337-0231	222	5
64678	A06-17188-001		6150-01-478-6819	98	1
64678	A06-17569-000		6150-01-336-6472	99	1
64678	A06-17960-001		6160-01-340-8837	92	15
64678	A06-17965-000		6160-01-340-8856	92	1
64678	A06-18016-000		6150-01-338-2076	103	54
64678	A06-18016-002		6150-01-341-7737	103	54
64678	A06-18114-001			71	5
64678	A06-18198-000			92	8
64678	A06-18198-001			92	26
64678	A06-18212-000		6150-01-339-1180	94	1
64678	A06-18214-000		6150-01-336-6469	95	1
64678	A06-18247-000		6150-01-339-1204	68	17
64678	A06-18247-001		6150-01-336-6470	68	22
64678	A06-18247-002		6150-01-337-3427	68	26
64678	A06-18260-000		6220-01-338-5773	82	7
64678	A06-18294-086		6140-01-366-5533	91	9
64678	A06-18295-061		6150-01-339-6119	91	1
64678	A06-18296-055		6150-01-339-6118	91	2
64678	A06-18319-002		6150-01-478-6501	97	1
64678	A06-19799-000			225	1
64678	A06-20074-000		6150-01-412-6546	100	12
64678	A06-20074-001		6150-01-412-6544	100	1
64678	A06-22688-007			96	1
64678	A06-23337-000		6150-01-435-7199	93	1
64678	A06-23362-000			69	8
64678	A06-23390-000			66	1
64678	A06-23391-000			65	1
64678	A06-23393-000			112	1
64678	A06-23561-000			93	40
64678	A06-24520-000		6150-01-447-5601	39	19
64678	A06-24521-000		6150-01-447-5600	39	20
64678	A06-25989-000			104	1
64678	A06-25990-000			105	1
64678	A06-26631-000		4810-01-441-0851	48	7

CROSS-REFERENCE INDEXES

CAGEC	PART NUMBER	PART NUMBER INDEX		FIG.	ITEM
			STOCK NUMBER		
64678	A06-26871-000		6150-01-478-6828	103	16
64678	A06-26871-008		6150-01-478-6824	103	1
64678	A06-27038-000			106	3
64678	A06-27300-000			110	1
64678	A06-27385-135		6150-01-478-6810	103	27
64678	A06-27386-000		6150-01-478-6805	109	1
64678	A06-28026-000			117	27
64678	A06-28027-000			117	3
64678	A06-29036-000			115	4
64678	A06-29039-000			117	4
64678	A06-29041-000			117	1
64678	A06-29042-000			116	3
64678	A06-29362-000			116	1
64678	A06-29754-000			116	2
64678	A06-29754-001			116	10
64678	A06-29754-002			116	9
64678	A06-29783-000			108	1
64678	A06-30356-000			115	5
64678	A06-30881-000		6150-01-478-6801	90	7
64678	A06-31483-000			252	2
64678	A06-31714-000			251	2
64678	A06-31940-000			115	2
64678	A06-32225-060			67	1
64678	A06-32540-000			108	9
64678	A06-32989-000		6150-01-478-6791	69	1
64678	A06-33143-000			251	17
64678	A06-33155-000			101	1
64678	A06-33246-104			76	9
64678	A06-33247-098			76	10
64678	A06-35602-000			68	31
64678	A06-35801-050			91	25
64678	A06-35823-057			91	26
64678	A06-37346-000			58	5
64678	A06-37347-036			91	33
64678	A06-37348-036			91	34
64678	A06-37349-054			91	50
64678	A07-14032-000			118	6
64678	A07-16798-000			118	3
64678	A07-17057-003		6680-01-478-6145	120	1
35510	A0790-79406		3110-01-136-2093	57	20
64678	A09-09185-250		2520-01-473-7409	137	1
64678	A09-10067-490		2520-01-479-1629	136	1
78500	A1 3299A6787			146	15
78500	A1 3299Z6786			146	15
78500	A1-3226-T-1112		3130-01-326-4524	143	1
64678	A10-09972-001			194	8
64678	A10-09972-002			194	8
41947	A1197		4730-00-266-0534	22	3
78500	A1199P1394		2520-00-353-2286	140	4
				141	4
64678	A12-11593-054		4720-01-332-1598	163	2

CROSS-REFERENCE INDEXES

CAGEC	PART NUMBER	PART NUMBER INDEX		FIG.	ITEM
			STOCK NUMBER		
64678	A12-11924-000		2530-01-332-1393	156	56
64678	A12-11924-001		2530-01-333-0748	153	20
64678	A12-11924-002		2530-01-332-1394	158	5
64678	A12-12035-000		5340-01-332-6654	158	26
64678	A12-13004-000		2530-01-332-1587	152	1
64678	A12-13688-000		5340-01-333-8208	153	11
				156	43
				158	8
64678	A12-13828-000			145	14
64678	A12-14544-024			153	22
				156	58
				158	17
64678	A12-17593-001			151	31
78500	A12-3200-H-1984- 529M			142	1
78500	A1205-H-2426	5330-01-269-4327		144	2
78500	A1205R2592	5330-01-467-6287		142	42
78500	A13-3235-W-1843	2520-01-333-8361		142	25
64678	A14-12093-000	2530-01-327-7713		175	1
64678	A15-10198-000			181	7
64678	A15-12169-002	5340-01-338-2907		178	9
64678	A15-12507-000			181	16
64678	A15-12619-001	5340-01-338-2908		179	11
64678	A15-13339-000			181	4
64678	A15-13551-000	5340-01-336-6976		176	35
64678	A15-14555-000	5340-01-406-6966		177	6
64678	A15-16879-000			185	11
64678	A15-16879-001			185	11
64678	A16-12355-003			192	17
64678	A16-13412-001	2510-01-481-3358		192	7
64678	A16-14038-001			192	5
64678	A16-15023-005			193	20
64678	A16-15074-000			193	26
64678	A17-10375-001	5340-01-329-4093		206	10
64678	A17-10464-001	5340-01-331-7290		205	21
64678	A17-12039-001	2510-01-329-5036		207	14
64678	A17-12081-000	5995-01-328-8997		208	19
64678	A17-12082-000	5995-01-328-8998		208	21
64678	A17-12104-000	2540-01-332-1403		209	1
64678	A17-12108-000	5430-01-332-1374		209	4
64678	A17-12137-000	5970-01-331-8972		207	15
64678	A17-12137-001	5970-01-333-1156		207	16
64678	A17-12443-000	2510-01-327-7717		206	1
64678	A17-12669-000	2510-01-329-5035		207	12
64678	A18-16142-002	2540-01-346-0736		203	55
64678	A18-16142-003	2540-01-348-6129		203	55
64678	A18-17428-002	2510-01-337-7592		214	11
64678	A18-17428-003	2510-01-337-0247		214	17
64678	A18-18557-002	2540-01-345-5736		203	36
64678	A18-18585-003	2510-01-338-2317		201	46
64678	A18-19194-000	5340-01-338-7068		200	10

CROSS-REFERENCE INDEXES

CAGEC	PART NUMBER	PART NUMBER INDEX		FIG.	ITEM
			STOCK NUMBER		
64678	A18-19555-003		5340-01-336-7696	201	15
64678	A18-19569-003		2590-01-344-8439	201	10
64678	A18-20931-000			42	2
64678	A18-22178-017			201	45
64678	A18-23406-001		5340-01-336-4024	201	98
64678	A18-23456-000		5340-01-336-3938	201	92
64678	A18-23836-001			199	11
64678	A18-24195-000		2510-01-365-5318	203	39
64678	A18-24195-001		2510-01-366-5035	203	39
64678	A18-24201-000		2590-01-338-7391	197	12
64678	A18-24221-000		5340-01-348-5016	203	46
64678	A18-24695-000		5340-01-336-3932	201	95
64678	A18-25208-000			145	20
64678	A18-25672-003			145	22
64678	A18-25689-000		5340-01-345-9873	203	42
64678	A18-25719-000		5340-01-345-9874	203	52
64678	A18-26081-000		5340-01-336-6030	201	26
64678	A18-26081-001			201	39
64678	A18-26205-000		2590-01-337-0211	216	5
64678	A18-26205-001		2590-01-337-8936	216	3
64678	A18-26207-000		5340-01-336-5449	216	6
64678	A18-26208-000		5340-01-336-3962	216	7
64678	A18-26258-000		5340-01-336-7410	201	91
64678	A18-26290-000			145	1
64678	A18-26381-000		2510-01-481-3359	207	5
64678	A18-26517-000		2540-01-337-8846	201	48
64678	A18-27085-000			215	4
64678	A18-27086-000			215	9
64678	A18-27781-000		2590-01-346-3243	203	5
64678	A18-27781-001			203	5
64678	A18-27783-000		2540-01-346-9852	203	25
64678	A18-27783-001		2540-01-346-9853	203	25
64678	A18-28001-000		2510-01-356-2309	203	1
64678	A18-28001-001		2510-01-356-2310	203	1
64678	A18-28702-000			202	1
64678	A18-29448-003			199	4
64678	A18-41021-000		2590-01-481-3553	216	2
64678	A18-41021-001		2590-01-481-3550	216	1
78500	A2-3102-X-3456		2530-01-326-4647	138	22
78500	A2-3200-H-1984			142	20
78500	A2-3261-Q-1057		2530-01-470-1777	142	29
64678	A21-26065-000			185	8
64678	A21-26181-000			185	12
64678	A22-11731-003		6250-01-338-5816	71	19
64678	A22-16019-000		5999-01-357-4951	68	4
64678	A22-20252-000		2540-01-337-4096	230	29
64678	A22-21041-001			225	8
64678	A22-24864-002		5340-01-336-6920	217	5
64678	A22-25231-003		6220-01-333-5592	69	6
64678	A22-25231-008			68	9
64678	A22-25627-002		4820-01-332-7647	226	6

CROSS-REFERENCE INDEXES

CAGEC	PART NUMBER	PART NUMBER INDEX		FIG.	ITEM
			STOCK NUMBER		
64678	A22-30548-000		5340-01-336-3933	231	2
64678	A22-30594-000		6220-01-338-2057	83	2
64678	A22-30599-001		4710-01-337-7366	230	8
64678	A22-30822-000		5930-01-478-6816	225	6
64678	A22-30931-000		2540-01-479-1528	228	3
64678	A22-32031-000		2540-01-357-5696	232	6
64678	A22-32401-401		2540-01-337-9332	216	9
64678	A22-32550-000		5340-01-336-6978	182	16
64678	A22-32550-001		5340-01-336-6549	182	16
64678	A22-32896-000		2510-01-337-4130	212	12
64678	A22-32896-001		2510-01-337-8841	212	2
64678	A22-32945-094		4720-01-442-2306	249	1
64678	A22-33408-000		2510-01-337-0233	214	3
64678	A22-34381-000		2540-01-481-3578	201	74
64678	A22-34726-000			214	7
64678	A22-34757-000		2510-01-329-9904	184	5
64678	A22-34757-001		2510-01-329-9905	184	1
64678	A22-35022-000			68	14
64678	A22-35023-000			68	12
64678	A22-35146-000		2510-01-337-8843	213	6
64678	A22-35146-001		2510-01-337-4125	213	1
64678	A22-35189-001		2540-01-338-7454	222	2
64678	A22-35190-001			222	1
64678	A22-35193-003			221	1
64678	A22-35197-002			222	22
64678	A22-35197-003			222	7
64678	A22-35310-001		2590-01-332-1628	210	14
64678	A22-35350-000		5340-01-345-4692	244	5
64678	A22-35376-000		2510-01-337-0230	179	5
64678	A22-35399-000		6250-01-478-6934	68	1
64678	A22-35430-000		5340-01-336-7647	229	2
64678	A22-35598-000			223	4
64678	A22-35839-002			179	1
64678	A22-35921-000		5340-01-332-6653	210	3
64678	A22-36278-001			231	4
64678	A22-36464-000		5930-01-443-1947	87	5
64678	A22-36918-000		5340-01-327-7708	191	1
64678	A22-38640-001			222	6
64678	A22-38643-000			222	10
64678	A22-38715-000			221	3
64678	A22-38762-000		4720-01-442-2732	249	9
64678	A22-38763-000		4720-01-442-2371	249	8
64678	A22-38898-000		6680-01-391-8588	70	6
64678	A22-38915-000		6680-01-391-8589	70	3
64678	A22-38941-000		4710-01-442-5074	249	4
64678	A22-39127-000		6620-01-338-5952	71	24
64678	A22-39265-000			182	1
64678	A22-39265-001			182	1
64678	A22-41330-002		4720-01-442-2305	249	3
64678	A22-41331-014		4720-01-442-2730	249	14
64678	A22-41332-017		4720-01-442-5077	249	15

CROSS-REFERENCE INDEXES

CAGEC	PART NUMBER	PART NUMBER INDEX		FIG.	ITEM
			STOCK NUMBER		
64678	A22-41519-000		3040-01-478-7794	225	4
64678	A22-43203-000			179	4
64678	A22-44869-000			181	13
64678	A22-44869-001			181	13
64678	A22-45432-000		4820-01-442-1673	233	31
64678	A22-45492-000		2540-01-479-1522	225	11
64678	A22-45533-000			225	3
64678	A22-45655-000			231	20
64678	A22-47301-000			183	9
64678	A22-47301-001			183	9
64678	A22-48497-001		2510-01-479-1632	188	1
64678	A22-48592-000			185	5
64678	A22-48592-001			185	5
64678	A22-49798-000			221	10
64678	A22-49952-000			233	1
64678	A22-52996-000			187	1
64678	A23-02232-028		4720-01-332-1335	22	4
64678	A23-02232-080		4720-01-332-5964	22	1
64678	A23-02235-060		4720-01-443-5051	155	7
				155	8
64678	A23-02235-090			157	1
				160	1
64678	A23-11466-101		5305-01-336-6730	214	12
64678	A23-11771-016		4720-01-329-1298	174	16
64678	A23-12005-021		4720-01-329-1299	174	7
64678	A23-12248-013			30	20
64678	A23-12248-040		4720-01-481-3471	154	37
64678	A23-12248-051			37	12
64678	A23-12249-020			30	19
64678	A23-12250-047		4720-01-481-3449	156	40
64678	A23-12250-100		4720-01-481-3767	37	15
64678	A23-12317-080		4720-01-478-6025	135	32
64678	A23-12346-064		4720-01-481-3757	154	36
64678	A23-12348-055		4720-01-481-3760	156	41
64678	A23-12629-070		4720-01-478-6021	135	31
78500	A3-3211-Q-4307			147	8
78500	A3-3222-D-2006			147	7
78500	A3211J5782			146	6
78500	A3211K5783			146	6
86928	A367-276-2		5310-01-336-6864	201	59
41947	A4889		4730-00-254-6228	37	14
78500	A6 3222M2223			146	18
78500	A8-3211-P-3448			147	8
78500	A9-3235W1843			144	17
72582	B-21951		3120-01-321-0598	20	4
				20	8
78500	B-41274-1			144	8
78500	B-41284-1			142	55
64678	B-850		5340-01-336-6029	183	1
72582	BAHH0177			161	12
64678	BCH14P1		5355-01-338-9457	231	18

CROSS-REFERENCE INDEXES

CAGEC	PART NUMBER	PART NUMBER INDEX		FIG.	ITEM
			STOCK NUMBER		
06721	BE20301			59	3
64678	BMK-F1TC-01		5310-01-337-0905	187	3
64678	BOA 180156 03			233	13
64678	BOA 180168 03			233	23
64678	BOA 630014 00		6685-01-442-8552	233	5
64678	BOA 640019 00			233	16
64678	BOA 680018 01			233	20
64678	BOA 70 112 04 12		5365-01-441-2674	233	21
	3				
64678	BOA 702011 00			233	15
64678	BOA 702013 00			233	8
64678	BOA 707004 00			233	27
64678	BOA 707014 00			233	18
64678	BOA 708003 00		5365-01-441-2679	233	19
64678	BOA 730004 07		4130-01-443-3814	233	4
64678	BOA 750033 09			233	7
64678	BOA 750034 08			233	22
64678	BOA 750045 05			233	2
64678	BOA 750049 03			233	10
64678	BOA 782017 02			233	30
64678	BOA 782039 00		5325-01-445-0252	233	24
64678	BOA 782094 00			233	6
64678	BOA 78211501			233	33
64678	BOA 85 031 52 00		5342-01-443-2557	233	32
	2				
64678	BOA 90 703 06 76			233	11
	8				
99017	BP-2 1/2			230	31
33287	BT-33-73F		6635-01-093-3710	259	6
55719	BWD482		5130-01-389-8450	257	3
26848	BX15-16		5120-00-215-8200	264	6
80204	B1821BH025C044N		5305-00-071-2507	154	29
80204	B1821BH025C075L		5306-01-175-7558	74	10
80204	B1821BH025C075N		5305-00-068-0508	90	5
				201	21
				249	6
80204	B1821BH025C100N		5305-00-225-3843	15	4
				42	10
				49	12
				55	16
				78	5
				81	2
				82	16
				91	7
				91	23
				91	46
				92	29
				102	4
				135	29
				153	1
				155	1

CROSS-REFERENCE INDEXES

CAGEC	PART NUMBER	PART NUMBER INDEX		FIG.	ITEM		
			STOCK NUMBER				
80204	B1821BH025C100N		5305-00-225-3843	163	3		
				201	100		
				203	3		
				203	22		
				203	45		
				205	9		
				226	17		
				227	6		
				229	1		
				229	11		
				234	14		
				240	9		
		80204		B1821BH025C113N	5305-00-225-3842	199	5
		80204		B1821BH025C125N	5305-00-068-0509	152	27
227	21						
80204	B1821BH025C150N	5305-00-071-2509	91	5			
80204	B1821BH025C175N	5305-00-071-2510	201	47			
80204	B1821BH025C200N	5305-00-071-2511	151	16			
			154	16			
80204	B1821BH025C225N	5305-00-071-2512	30	17			
80204	B1821BH025C350N	5305-00-071-2517	201	51			
80204	B1821BH025C400N	5305-00-071-2519	225	15			
80204	B1821BH031C075N	5306-00-226-4825	161	21			
			164	11			
			208	22			
			209	2			
			256	4			
			39	17			
			154	49			
80204	B1821BH031C100N	5306-00-226-4827	154	49			
80204	B1821BH031C125N	5306-00-226-4829	223	3			
80204	B1821BH031C150N	5305-00-226-4831	210	15			
			211	3			
			222	18			
80204	B1821BH031C200N	5306-00-226-4833	43	3			
			210	8			
80204	B1821BH031C250N	5306-00-226-4835	208	3			
80204	B1821BH031C275D	5306-01-158-1154	155	22			
			155	48			
80204	B1821BH031C300N	5306-00-226-4837	155	20			
80204	B1821BH031C450N	5306-00-226-4843	145	19			
80204	B1821BH038C088N	5305-01-140-9118	173	28			
80204	B1821BH038C100N	5305-00-068-0510	39	18			
			250	12			
			152	23			
80204	B1821BH038C125N	5305-00-068-0511	182	12			
			183	8			
			197	3			
			206	12			
			210	5			
			211	1			
			212	7			

CROSS-REFERENCE INDEXES

CAGEC	PART NUMBER	PART NUMBER INDEX		FIG.	ITEM
			STOCK NUMBER		
80204	B1821BH038C150N		5305-00-725-2317	153	14
				210	11
80204	B1821BH038C175N		5305-00-821-3869	177	4
				182	9
				206	8
				247	1
				247	6
				168	9
80204	B1821BH038C200N		5305-00-782-9489	168	9
80204	B1821BH038C300N		5305-00-846-5703	182	17
				210	4
80204	B1821BH038C450N		5305-00-857-6886	15	13
80204	B1821BH038C475N		5305-00-781-3930	48	8
80204	B1821BH050C125N		5305-00-071-2067	91	32
				206	15
				208	20
				222	11
				238	17
				251	13
				44	5
80204	B1821BH050C150N		5305-00-071-2069	80	4
				92	9
				176	43
				181	21
				239	14
				41	13
				44	23
80204	B1821BH050C175N		5305-00-071-2070	176	14
				176	16
				182	13
				183	3
				194	7
				174	5
				176	34
80204	B1821BH050C200N		5305-00-071-2071	42	6
				135	18
				176	36
				183	4
80204	B1821BH050C225N		5305-00-071-2072	160	10
				177	11
80204	B1821BH050C250N		5305-00-071-2073	184	3
				208	11
				193	28
80204	B1821BH050C300N		5305-00-071-2075	192	3
80204	B1821BH050C375N		5305-00-071-2078	205	22
80204	B1821BH050C400N		5305-00-071-2079	238	21
80204	B1821BH050C450N		5305-00-071-2081	239	19
80204	B1821BH050C500N		5305-00-071-2083	239	4
80205	B1821BH050F088N		5305-00-990-0695	121	1
80204	B1821BH063C150N		5305-00-724-7220	178	4
				92	11
80204	B1821BH063C175N		5305-00-724-7221	176	29

CROSS-REFERENCE INDEXES

CAGEC	PART NUMBER	PART NUMBER INDEX		FIG.	ITEM
			STOCK NUMBER		
80204	B1821BH063C175N		5305-00-724-7221	180	3
				181	10
80204	B1821BH063C200N		5305-00-724-7222	146	28
				147	24
				178	6
				179	8
				184	9
				195	7
				238	2
80204	B1821BH063C225N		5305-00-724-7223	177	1
				178	5
				179	14
				187	7
				188	4
80204	B1821BH063C250N		5305-00-724-7224	222	29
				92	12
				176	3
80204	B1821BH063C275N		5305-00-724-7225	185	2
				4	8
				36	3
80204	B1821BH063C300N		5305-00-724-7228	193	38
				36	1
				176	4
				177	2
80204	B1821BH063C325N		5305-00-724-7236	179	9
				213	2
				180	6
				193	40
80204	B1821BH063C400N		5305-00-724-7254	196	13
				197	1
80204	B1821BH063C425N		5305-00-724-7263	193	13
80204	B1821BH063C475N		5305-00-724-7265	196	4
				193	11
80204	B1821BH063C500N		5305-00-724-7266	177	20
80204	B1821BH063C550N		5305-00-732-9207	44	12
80204	B1821BH063C600N		5305-00-724-6847	160	5
80204	B1821BH075C250N		5305-00-922-7994	185	1
80204	B1821BH075C425N		5305-00-947-4359	195	5
80204	B1821BH075C450N		5305-00-947-4360	197	10
80204	B1821BH075C600N		5305-00-947-4364	195	2
80204	B1821BH075F400N		5305-00-903-7767	170	1
80204	B1821BH088C275N		5305-00-964-0512	176	6
80204	B1821BH088C350N		5305-01-138-7735	176	39
80204	B1821BH088C475N		5305-01-277-0451	171	1
80204	B1821BH088C500N		5305-01-195-5050	171	6
80204	B1821BH088C550N		5305-00-947-4350	171	4
80204	B1821BH100C300N		5305-00-940-8068	181	14
80204	B1821BH100C350N		5305-00-990-8400	135	24
				176	9
80204	B1821BH100C375N		5305-00-276-5739	181	3
78500	B20-3299-E-6089			147	16

CROSS-REFERENCE INDEXES

CAGEC	PART NUMBER	PART NUMBER INDEX		FIG.	ITEM
			STOCK NUMBER		
78500	B20-3299-F-6090			147	16
05411	B28H			49	2
7Z588	B9223-0175B	4730-01-442-3515		15	20
7Z588	B9223-0269B	4730-01-439-6613		49	4
7Z588	B9223-0325B	4730-01-439-5343		49	30
				135	7
62789	B9226-0306B			135	10
76005	CB-1120-3	5340-01-157-1009		35	7
76005	CBA24-650-17	5342-01-335-7854		4	6
99539	CBM21389	5310-00-582-5965		57	3
				57	5
				60	38
82458	CLF1420S	5310-00-088-1251		201	72
21760	CS791	3110-00-120-4464		261	6
7Z588	CT9216			49	14
9K475	C120LB-R12-4	5306-01-341-2895		199	10
78500	C22-3121-R-2280S			140	6
79470	C3169X1	4730-01-216-9355		162	44
78500	C34-3121P1966S			141	6
79470	C3609X4	4730-00-088-8666		226	25
30327	C602	4720-01-192-5261		BULK	39
13174	C608-100BLK	4720-01-003-6706		BULK	29
78500	C7-3200S1865-529	2520-01-481-3960		144	1
	M				
93061	DC604-2	4820-00-752-9040		49	7
5A910	DC9653			69	13
78500	DEFR567	2520-01-330-8163		142	4
78500	DEFR59 1			144	24
15526	DIN127-B10.1-431	5310-01-379-8077		56	7
	0				
21969	DIN933-M10X25-8.	5306-01-338-3981		124	12
	8-B3B			125	4
15526	DIN933-M8-1.25X2	5306-01-270-8909		91	20
	0-8.8-A4C			173	34
15526	DIN985-M10-A4C	5310-01-264-1640		19	8
28520	DP-875 2703			229	15
11139	DT04-3P			254	1
11139	DT06-4S			254	7
78500	D63-3299-U-5195			147	16
78500	D63-3299-V-5196			147	16
18265	ECCG11-2530	2940-01-333-0720		32	17
19954	ER-27856-210	4820-01-330-0547		173	11
06721	ER-42185			173	6
06721	ER-42485			173	2
64678	ER-42534	3020-01-330-0034		173	26
06721	ER-42549			173	5
19954	ER-62793	3040-01-329-9878		173	20
19954	ER-7621	4820-00-229-9917		173	14
06721	ER-82143			173	16

CROSS-REFERENCE INDEXES

CAGEC	PART NUMBER	PART NUMBER INDEX		FIG.	ITEM
			STOCK NUMBER		
06721	ER-82349			173	29
06721	ER-8913-015			173	9
06721	ER-8913-028			173	17
06721	ER-8913-041			173	7
06721	ER-8913-211			173	13
19954	ER-90101-075	5315-01-175-3916		173	8
19954	ER-91153-088	5306-01-174-2553		173	33
06721	ER-92739-069			173	4
19954	ER-9476	5315-01-175-3907		173	21
06721	ER-99562			173	15
06721	ER-99620			173	19
06721	ER-99969	4320-01-329-5101		173	23
06721	ERS-28310	4320-01-329-5022		KITS	
06721	ERS-28395.			173	10
06721	ERS-28598.			173	30
06721	ERS-99563			173	18
06721	ERS85120-088	5306-01-329-3695		173	25
06721	ERS91381-250	5305-01-328-4390		173	24
81118	ER7614	5360-00-811-1609		173	12
64678	ETN/8981K529	5930-01-475-0077		107	5
0W4A6	ET210L-25073C	4130-01-439-2870		247	3
06092	E0300-037-2000M	5360-01-094-2428		33	14
64678	E06-13353-000	5340-01-336-6447		82	13
64678	E07-10869-000	4730-01-336-6945		135	13
64678	E15-11813-002			181	1
64678	E22-25578-000	5340-01-331-9498		91	49
64678	E22-25841-008	5365-01-356-0083		187	9
				222	26
72582	E23524912			11	2
64678	E24-00049-045			236	4
64678	E24-00242-009			68	10
01276	FC352-28	4720-01-100-0740		51	2
				51	6
81348	FFB187/01-TYPE A	3110-00-100-0380		142	9
	BMA 3920				
01276	FF9311-36	4730-00-909-8627		51	5
64678	FIA 7222821S			90	6
64678	FITC-02			187	5
64678	FITC-05	5340-01-336-6446		187	6
64678	FLT/1600-15MT	5365-01-336-7658		213	3
64678	FTL/M915A3CAB	2510-01-480-2400		198	1
74410	FW33S04716	2510-01-479-0985		189	1
29944	F10581	2540-01-442-5560		218	2
29944	F10582	2540-01-442-5480		218	1
64678	GTD 5050	2940-01-392-0417		48	6
77640	G223734	5306-01-186-1052		172	2
77640	G9419666	5310-00-543-5858		172	4
77640	G9426534	5305-01-328-4389		172	10
60038	H-715311	3110-00-227-3729		142	57
55719	HCP48A	5120-00-537-3375		259	4
11139	HD10 6 12P	5935-01-447-6852		108	2

CROSS-REFERENCE INDEXES

CAGEC	PART NUMBER	PART NUMBER INDEX		FIG.	ITEM
			STOCK NUMBER		
11139	HD10-6-12P		5935-01-447-6852	101	30
11139	HD10-9-96P			101	31
11139	HD34-18-14PN		5935-01-364-7773	255	22
11139	HD34-24-31PT			101	15
11139	HD36-18-14SN		5935-01-364-3646	254	5
11139	HD362431ST			66	2
64678	HE1260034		4710-01-329-1585	173	32
77640	HFB644100A10397		3040-01-332-5490	172	42
77640	HFB649000			172	6
60038	HM212049		3110-00-293-8998	164	4
64386	HRM 277-A-80		5340-01-336-9560	92	22
7Z588	HTM600		4730-00-005-4894	31	1
7Z588	HTM800		4730-01-177-3515	31	3
08805	H4651		6240-01-203-2106	79	10
56962	H4739		6240-01-341-3770	79	11
60038	H715334		3110-00-969-7315	142	56
33287	J 26598-A		4910-01-158-3996	266	13
33287	J 28593		4940-01-353-7038	265	2
33287	J 28742-A		5180-01-353-2518	258	8
33287	J 33095		5120-01-353-2534	258	9
33287	J 33880-1		5110-01-355-0637	270	8
33287	J 33880-10		5120-01-353-7040	270	12
33287	J 33880-20		5210-01-353-2535	270	9
33287	J 33880-3		5120-01-353-7039	270	11
33287	J 33880-4		5120-01-354-0426	270	6
33287	J 33880-5		5110-01-355-0636	270	5
33287	J 33880-7		5210-01-355-6424	270	7
33287	J 3453-1		5120-01-455-0436	262	18
33287	J 34812-1		5935-01-353-2532	257	10
33287	J 35123		5120-01-355-0844	258	4
33287	J 35517-1		5120-01-354-0469	262	13
33287	J 35547		5140-01-355-3013	258	11
33287	J 35598		5120-01-353-8567	267	5
33287	J 35606		5120-01-355-4178	258	10
33287	J 35615		5110-01-355-0848	258	3
33287	J 35642-1		5120-01-356-1649	269	16
33287	J 35642-2		5120-01-353-8517	269	17
33287	J 35642-3		5310-01-357-3045	269	13
33287	J 35642-4		5120-01-354-9442	269	15
33287	J 35642-7		5120-01-353-7043	269	14
33287	J 35688		5120-01-355-0845	258	7
33287	J 35689-A		5120-01-357-2937	258	6
33287	J 35751		6150-01-354-2604	259	3
33287	J 35888-60		5180-01-358-5231	258	1
33287	J 35889-A		5120-01-355-3011	258	2
33287	J 35945		5120-01-353-8515	267	6
33287	J 35984-1		5340-01-353-8575	266	10
33287	J 35984-2		5340-01-353-8466	266	7
33287	J 35988-1		5120-01-353-7059	262	10
33287	J 35988-2		5120-01-353-8514	262	8
33287	J 36024-2		5120-01-354-9447	269	5

CROSS-REFERENCE INDEXES

CAGEC	PART NUMBER	PART NUMBER INDEX		FIG.	ITEM
			STOCK NUMBER		
33287	J 36024-3		5120-01-353-8513	269	7
33287	J 36024-4		5120-01-353-2524	269	4
33287	J 36024-8		5120-01-353-7061	269	6
33287	J 36223-1		5180-01-353-7042	266	9
33287	J 36223-2		5180-01-353-8516	266	12
33287	J 36223-3A		5340-01-353-8467	266	11
33287	J 36223-4		5180-01-353-7041	266	8
33287	J 36223-7		5180-01-353-2523	266	6
33287	J 36310-1		5120-01-353-7060	261	15
33287	J 36310-2		5120-01-354-0470	261	14
33287	J 37070		5120-01-371-7369	264	1
33287	J 37071		5120-01-354-2943	264	9
33287	J 37073		5120-01-354-0468	264	8
33287	J 37464		5120-01-353-8490	264	3
33287	J 38384		5120-01-355-3012	258	5
33287	J 38500-H			257	6
33287	J 38500-2300D			257	9
33287	J 38662		5120-01-353-2520	264	7
33287	J 43172		5120-01-452-6036	265	8
76005	J-17700-5		5365-01-329-4102	208	13
76005	J-2049-54		5310-01-184-6477	44	15
33287	J-24197		5120-01-115-1160	268	2
33287	J-24202-1A		5120-01-054-4042	265	3
33287	J-24208-D		5120-01-116-5016	268	8
33287	J-24365		5120-01-116-6049	262	4
76005	J-2610-46		5342-01-336-4250	197	13
33287	J-26282		5120-01-115-1161	268	3
33287	J-26487-B		4910-01-160-3618	265	1
33287	J-35653-1		5120-01-354-2773	266	15
33287	J-35653-2		5120-01-354-2774	266	16
33287	J-35686-1		5120-01-353-8568	261	2
33287	J-35686-2		5120-01-354-2944	261	8
33287	J-35686-3		5310-01-357-4594	261	7
33287	J-35686-4		5120-01-353-8569	261	5
33287	J-35686-6		5120-01-354-5674	261	3
33287	J-35906-1.			262	16
33287	J-35906-4		5120-01-366-2545	262	15
33287	J-35988-14		5120-01-354-2771	262	9
33287	J-35988-15		5120-01-354-2772	262	12
33287	J-35988-3A		5120-01-354-2768	262	11
33287	J-35993-1		5120-01-359-1234	261	11
33287	J-35993-5		5120-01-354-2770	261	12
33287	J-35998-18		5120-01-354-2769	262	7
33287	J-36224-1		5120-01-354-2775	269	11
33287	J-36224-2		5120-01-354-2776	269	10
33287	J-36310-9		5120-01-354-5673	261	16
72582	J-38351-15			259	17
72582	J-38351-25			259	12
72582	J-38351-30			259	14
33287	J-38500-1A			257	7
33287	J-38500-1300E			257	14

CROSS-REFERENCE INDEXES

CAGEC	PART NUMBER	PART NUMBER INDEX		FIG.	ITEM
			STOCK NUMBER		
33287	J-38500-4100			257	13
45225	J-38500-60A		5935-01-477-7230	257	11
72582	J-38500-96-A			259	16
72582	J-39877-3			259	11
72582	J-42375-5			259	15
72528	J-42375-6			259	13
72582	J-42431-ECD			259	10
				259	11
11873	JB2520-001		5940-01-339-6981	68	37
11873	JB3816-202		5940-01-336-7061	68	38
60380	JH-2216		3110-01-038-5721	25	8
02032	JHP42-113		5315-00-842-3044	145	27
78500	JLM-710910		3110-01-082-8752	142	52
60038	JLM104910		3110-00-191-3923	143	6
0LTL1	JLM710949		3110-01-099-0022	142	51
60038	JM716610		3110-00-144-9455	142	18
				144	10
60038	JM716649		3110-00-144-9793	142	28
				144	9
99657	J200AR11		5331-00-916-6639	249	2
				250	1
33287	J23479-271		5120-00-494-1836	270	1
33287	J23479-460		5120-01-322-8883	270	2
33287	J24171A		5180-01-048-2153	265	6
33287	J24202-4		5120-01-054-4048	262	3
33287	J24204-3		5120-01-048-2159	267	4
33287	J24208-13		5220-01-158-3999	268	11
33287	J24208-2		4310-01-247-7126	268	9
33287	J24208-3		4910-01-158-3972	268	10
33287	J24210		5120-01-048-2156	267	2
33287	J25447-B		5120-01-338-7182	260	4
33287	J26554-A		4910-01-127-7959	265	4
25341	J26941		4910-01-179-6364	261	17
33287	J29006-5		4910-01-320-4638	268	6
81343	J30R6-TYPE1-3/16 ID		4720-01-202-0248	BULK	16
33287	J33163			271	2
33287	J33190		5120-01-322-1133	270	3
33287	J33191		5120-01-322-3501	270	18
33287	J33880		5120-01-322-3507	270	4
33287	J33884		5930-01-475-0242	271	3
33287	J34696		5120-01-322-3506	270	17
33287	J34983		5120-01-322-2955	270	16
33287	J35595		5306-01-319-1987	269	1
33287	J35596		5120-01-322-8885	260	7
33287	J35597		3449-01-319-5599	270	15
33287	J35635		3950-01-319-6973	269	2
33287	J35636		2510-01-320-8905	267	1
33287	J35637		5220-01-319-6604	260	5
33287	J35641		3940-01-324-4713	260	3
33287	J35642		5120-01-322-2360	269	12

CROSS-REFERENCE INDEXES

CAGEC	PART NUMBER	PART NUMBER INDEX		FIG.	ITEM
			STOCK NUMBER		
33287	J35651		3460-01-319-5533	268	1
33287	J35652		3040-01-319-0848	262	5
33287	J35653		5120-01-322-2359	266	14
33287	J35686		5120-01-322-1129	261	1
33287	J35686-10		5310-01-474-8888	261	4
33287	J35686-11		5365-01-475-2572	261	3
33287	J35686-20		5310-01-474-8891	261	4
33287	J35687		5120-01-322-2358	257	12
33287	J35785		5120-01-322-3503	266	3
33287	J35791		5120-01-322-1128	266	4
33287	J35906		5120-01-322-3508	262	14
33287	J35923-2		5120-01-388-5623	271	4
33287	J35924		5120-01-476-9379	271	5
33287	J35926-A		2590-01-475-7886	265	10
33287	J35949		5120-01-322-1132	260	8
33287	J35951-175		4320-01-320-4618	267	3
33287	J35988-B		5120-01-322-6115	262	6
33287	J35993		5120-01-322-1131	261	10
33287	J35994		2815-01-321-9248	266	2
33287	J35996		5120-01-322-6116	261	19
33287	J36003		5120-01-322-1123	262	17
33287	J36024		5120-01-322-3499	269	3
33287	J36107		5120-01-322-3505	261	20
33287	J36223-D.		4910-01-319-6990	266	5
33287	J36224		5120-01-322-3500	269	9
33287	J36235		5315-01-333-2771	261	9
33287	J36237		5120-01-322-3498	262	2
33287	J36310		5120-01-322-6222	261	13
33287	J36326		5120-01-333-4744	260	2
33287	J36347		5120-01-322-6888	261	18
33287	J37030			271	6
33287	J37030-1		5325-01-475-4635	271	7
33287	J37030-2		5325-01-475-4745	271	8
33287	J37030-3		5120-01-476-9378	271	9
33287	J37031			265	12
33287	J37032			265	11
33287	J37033		5120-01-475-7608	271	10
33287	J37034			271	11
33287	J37035		5180-01-476-2361	271	12
33287	J37036		5120-01-476-9380	271	13
33287	J37038		5120-01-476-9377	271	14
33287	J37040		5120-01-477-2749	271	15
33287	J37041		3120-01-475-1603	271	16
33287	J38460-A			259	7
33287	J38500-1500C			257	8
33287	J38500-1800			257	15
33287	J38509		6685-01-438-5088	265	7
33287	J38548-1		5220-01-388-1460	271	17
33287	J38564			271	18
33287	J38609		5220-01-337-4412	268	7
33287	J38768-A		4910-01-319-6971	268	5

CROSS-REFERENCE INDEXES

CAGEC	PART NUMBER	PART NUMBER INDEX		FIG.	ITEM
			STOCK NUMBER		
33287	J3940		5120-00-784-6482	271	1
33287	J39534			271	19
33287	J39697		5220-01-440-0686	265	5
33287	J39949		5120-01-475-7609	271	20
33287	J39954		5120-01-475-7610	271	21
33287	J41445		5340-01-475-3497	265	9
33287	J41462		5120-01-476-9381	271	22
33287	J43431		5315-01-475-5229	266	17
33287	J5286-5		4940-00-711-1919	270	10
33287	J5286-6		5120-00-711-1920	270	13
33287	J5286-8		5120-00-785-1017	270	14
33287	J7079-2		5120-00-977-5578	257	5
33287	J7872		5210-00-402-9619	259	1
33287	J8092		5120-00-677-2259	267	7
33287	J8129		4910-00-779-6832	268	4
33287	J8550		5120-00-977-5579	257	2
78500	KIT 1568		5330-01-091-1107	KITS	
78500	KIT 2322		5365-01-330-9716	KITS	
78500	KIT 2756			144	13
69444	KITZAKTN3/8		4820-01-332-1578	155	50
78500	KSR301 4702QP		2530-01-479-1357	KITS	
7Z588	K231-D-374			49	28
8B911	LE871620134		5305-01-328-4388	169	9
60038	LM104949		3110-00-400-8419	143	10
78280	LP-535-1		2910-00-646-9727	39	2
10988	L124720		5935-01-291-2814	100	10
				100	20
77640	L14-MN-2		5310-01-158-7840	170	6
55719	L883		5120-01-437-1725	262	1
33873	M-1492-5		8140-01-245-4325	239	23
72582	MAHH0093			30	14
72582	MAHU0489			30	7
34623	MA35-21072		5977-00-758-9555	60	58
06721	MA36200		2530-01-278-7558	148	1
96139	MB14106-2		6150-01-367-0599	92	16
64678	MGM/3430080		2530-01-330-0002	149	2
64678	MGM/3430081		2530-01-331-2996	149	2
78500	MN-312-1		5310-01-326-2667	142	35
96906	MS14304-1-T-12-0 6		4730-01-238-2980	22	2
96906	MS14315-1XA		4730-00-196-0930	150	29
96906	MS14315-4			156	54
96906	MS15003-1		4730-00-050-4208	138	10
				146	12
				147	17
96906	MS15003-6		4730-00-172-0034	192	14
96906	MS15795-812		5310-00-625-5756	56	4
96906	MS15795-814		5310-00-773-7618	35	11
				48	10
				153	9
				156	39

SECTION IV

TM9-2320-302-24P

CROSS-REFERENCE INDEXES

CAGEC	PART NUMBER	PART NUMBER INDEX		FIG.	ITEM
			STOCK NUMBER		
96906	MS15795-814		5310-00-773-7618	158	10
				177	5
				217	4
				218	6
				229	9
96906	MS15795-818		5310-00-767-9425	22	9
				56	2
				192	2
				194	6
				208	10
96906	MS15795-821		5310-00-720-8819	251	12
				4	2
				36	2
				44	13
				92	7
				160	6
				176	2
				177	3
				177	16
				178	2
				179	7
				179	10
				180	2
				181	5
				184	6
185	4				
188	2				
193	7				
193	10				
213	4				
96906	MS15795-822		5310-00-584-7799	3	2
				193	25
96906	MS15795-824		5310-00-584-7796	192	8
				196	16
96906	MS15795-908		5310-00-045-5207	89	4
96906	MS16624-1087		5325-00-804-2025	159	26
96906	MS16625-1081		5325-00-804-9740	26	2
96906	MS16633-1025		5325-00-721-7680	203	15
96906	MS16997-233		5305-00-957-2395	176	28
96906	MS19081-131		3110-00-100-4218	165	6
96906	MS20659-104		5940-00-107-1481	61	4
				65	14
				68	23
				68	29
96906	MS20659-105		5940-00-114-1300	57	17
96906	MS20659-128		5940-00-113-9820	67	11
96906	MS20659-163		5940-00-113-3145	101	19
78500	MS208045-1		5305-01-345-2449	142	12
96906	MS20913-6S		4730-00-221-2140	238	24
				239	20
78500	MS210020-1		5305-01-341-8825	142	69

CROSS-REFERENCE INDEXES

CAGEC	PART NUMBER	PART NUMBER INDEX		FIG.	ITEM
			STOCK NUMBER		
96906	MS21044-N4	5310-00-877-5796	34	29	
			34	34	
96906	MS21044D3	5310-00-877-5798	159	7	
96906	MS21045C06	5310-00-982-5003	33	3	
			33	15	
78500	MS212045-1	5305-01-356-0042	144	23	
96906	MS21318-48	5305-00-253-5627	238	10	
96906	MS21919WG6	5340-00-664-9056	79	21	
78500	MS220120-1	5305-01-325-5908	142	22	
			144	15	
96906	MS24630-15	5305-01-133-1052	201	63	
96906	MS24665-326	5315-00-234-1624	153	35	
			156	57	
			158	16	
			170	7	
96906	MS24665-359	5315-00-013-7214	170	7	
80205	MS24665-499	5315-00-842-3045	138	30	
80205	MS24665-621	5315-00-187-9572	183	5	
80205	MS24671-90	5305-01-308-8195	176	8	
96906	MS27183-10	5310-00-809-4058	15	3	
			37	5	
			40	2	
			42	5	
			49	9	
			55	11	
			72	2	
			74	8	
			76	5	
			78	4	
			79	8	
			81	3	
			82	19	
			91	4	
			91	29	
			102	2	
			113	6	
			135	27	
			150	16	
			153	3	
154	17				
155	3				
163	8				
201	22				
201	28				
201	49				
203	21				
205	8				
208	24				
223	2				
224	1				
225	9				
225	20				

SECTION IV

TM9-2320-302-24P

CROSS-REFERENCE INDEXES

CAGEC	PART NUMBER	PART NUMBER INDEX		FIG.	ITEM			
			STOCK NUMBER					
96906	MS27183-10		5310-00-809-4058	226	11			
				227	5			
				229	3			
				229	10			
				234	15			
				240	7			
				249	5			
				251	15			
				96906	MS27183-11	5310-00-809-3078	168	7
				96906	MS27183-12	5310-00-081-4219	32	4
			39	15				
			43	4				
			46	2				
			55	15				
			91	43				
			92	3				
			155	19				
			156	7				
			182	21				
			209	3				
			210	7				
			211	4				
			212	9				
			214	4				
			222	15				
			222	25				
			239	12				
			249	17				
			250	4				
			256	3				
96906	MS27183-14	5310-00-080-6004	15	12				
			30	22				
			41	2				
			46	5				
			152	22				
			154	2				
			158	24				
			182	5				
			182	11				
			197	4				
			206	7				
			210	2				
			211	2				
			212	6				
			221	12				
			250	10				
96906	MS27183-15	5310-00-809-4061	31	5				
			39	12				
			204	5				
			218	3				
96906	MS27183-16	5310-00-809-4085	15	10				

CROSS-REFERENCE INDEXES

CAGEC	PART NUMBER	PART NUMBER INDEX		FIG.	ITEM				
			STOCK NUMBER						
96906	MS27183-16		5310-00-809-4085	91	42				
				234	8				
96906	MS27183-17		5310-00-809-5997	135	16				
				140	8				
				141	9				
				142	6				
				142	54				
				144	22				
				146	27				
				147	23				
				96906	MS27183-18		5310-00-809-5998	121	4
								222	20
239	7								
96906	MS27183-19		5310-00-809-3079	80	3				
96906	MS27183-25		5310-00-809-8540	171	3				
				176	5				
96906	MS27183-42		5310-00-014-5850	68	40				
				82	4				
				92	19				
				107	2				
				118	2				
				201	53				
				205	2				
96906	MS27183-9		5310-00-823-8804	203	40				
				203	65				
96906	MS3367-2-9		5975-00-156-3253	230	5				
96906	MS3367-7-9		5975-00-570-9598	114	2				
				241	25				
96906	MS3368-1-9A		5975-00-944-1499	80	20				
				105	10				
				113	8				
				251	1				
				252	1				
				33	9				
96906	MS35206-230		5305-00-889-3000	33	17				
96906	MS35206-243		5305-00-984-6191	60	61				
96906	MS35206-244		5305-00-984-6192	57	50				
96906	MS35206-245		5305-00-984-6193	200	5				
96906	MS35206-265		5305-00-984-6212	205	5				
96906	MS35206-287		5305-00-988-1728	201	94				
96906	MS35207-265		5305-00-993-1848	57	69				
96906	MS35307-413		5305-00-021-3806	58	1				
				22	11				
				56	1				
				59	7				
96906	MS35307-414		5305-00-727-6804	121	5				
96906	MS35307-420		5305-00-139-7071	184	4				
				192	20				
96906	MS35307-464		5305-00-941-3580	4	4				
				147	3				
96906	MS35307-465		5305-00-925-7853	4	7				

CROSS-REFERENCE INDEXES

CAGEC	PART NUMBER	PART NUMBER INDEX		FIG.	ITEM
			STOCK NUMBER		
96906	MS35307-468		5305-00-943-2092	196	8
96906	MS35307-470		5305-00-943-2094	4	1
				193	16
96906	MS35307-499		5305-00-948-0677	3	1
96906	MS35308-387		5305-00-787-2177	218	4
96906	MS35333-39		5310-00-576-5752	58	2
				203	34
96906	MS35333-40		5310-00-550-1130	90	4
96906	MS35333-41		5310-00-167-0721	163	15
96906	MS35333-42		5310-00-595-7237	59	11
96906	MS35333-49		5310-00-582-6714	154	4
				156	29
96906	MS35333-81		5310-00-939-1060	150	12
				151	24
96906	MS35335-36		5310-00-550-3503	82	14
96906	MS35338-135		5310-00-933-8118	83	6
96906	MS35338-140		5310-00-974-6623	81	7
				145	9
				164	10
96906	MS35338-141		5310-00-984-7042	204	4
96906	MS35338-147		5310-00-926-5871	171	5
96906	MS35338-44		5310-00-582-5965	120	9
				151	18
				151	28
				199	6
96906	MS35338-45		5310-00-407-9566	161	20
				162	4
				239	11
96906	MS35338-48			91	35
			5310-00-584-5272	239	5
96906	MS35338-51		5310-00-584-7888	238	5
96906	MS35340-45		5310-00-959-4679	159	3
96906	MS35649-103		5310-00-852-8593	118	4
96906	MS35649-282		5310-00-934-9757	89	12
96906	MS35650-302		5310-00-934-9751	57	60
96906	MS35650-305		5310-00-934-9766	89	2
96906	MS35691-1		5310-00-851-2674	91	13
				225	30
96906	MS35691-17		5310-00-851-2682	211	5
96906	MS35691-53		5310-00-835-2037	56	3
96906	MS35692-1824		5310-00-401-5175	138	31
96906	MS35751-71		5306-00-816-2441	153	12
				156	42
				158	9
96906	MS35842-11		4730-00-908-3194	174	2
				234	3
				240	17
				242	3
96906	MS35842-14		4730-00-908-6292	51	1
96906	MS45904-68		5310-00-889-2528	227	16
96906	MS51107-64		5305-01-337-3258	227	10

CROSS-REFERENCE INDEXES

CAGEC	PART NUMBER	PART NUMBER INDEX		FIG.	ITEM
			STOCK NUMBER		
96906	MS51412-1		5310-01-303-4701	33	4
				33	12
96906	MS51412-13		5310-01-275-1065	170	3
				186	16
				195	3
				74	9
96906	MS51414-4		5310-01-251-9276	135	1
96906	MS51525A16		4730-00-930-5392	135	20
96906	MS51527A16		4730-00-840-7236	187	4
96906	MS51844-65		4030-01-245-4168	226	16
96906	MS51846-1		4730-00-230-1996	15	7
96906	MS51861-35		5305-00-432-4170	47	3
96906	MS51871-3		5305-01-137-3938	78	1
				198	12
				200	9
				225	19
				225	36
				155	21
				156	6
				203	59
				209	6
				211	7
222	14				
222	24				
250	5				
256	5				
96906	MS51922-17		5310-00-087-4652	15	17
				31	14
				44	14
				153	10
				153	13
				156	38
				158	7
				158	11
				177	13
				182	10
				183	7
				197	5
				204	1
				208	15
				210	1
212	5				
221	11				
229	13				
96906	MS51922-17A		5310-00-087-4652	68	35
96906	MS51922-33		5310-00-225-6993	41	10
				44	8
				56	17
				80	17
				92	25
				174	6

SECTION IV

TM9-2320-302-24P

CROSS-REFERENCE INDEXES

CAGEC	PART NUMBER	PART NUMBER INDEX		FIG.	ITEM
			STOCK NUMBER		
96906	MS51922-33		5310-00-225-6993	176	20
				176	44
				177	14
				178	8
				181	18
				182	15
				183	11
				184	8
				192	1
				205	14
				206	11
				208	9
				208	17
				222	19
96906	MS51922-49		5310-00-269-4040	4	10
				36	8
				44	17
				92	28
				176	22
				177	15
				177	18
				178	1
				179	6
				179	12
				180	5
				181	6
				184	7
				187	10
188	3				
197	11				
213	5				
222	27				
96906	MS51922-57		5310-00-067-6356	3	7
				197	8
96906	MS51922-61		5310-00-832-9719	170	4
96906	MS51922-9		5310-00-984-3806	182	20
				205	17
				208	4
				210	18
				212	10
96906	MS51953-132		4730-00-138-8121	240	30
96906	MS51963-85		5305-00-724-5903	60	33
96906	MS51967-11		5310-00-880-8189	247	4
96906	MS51967-14		5310-00-768-0318	42	12
				238	23
				239	6
96906	MS51967-20		5310-00-763-8920	121	9
				148	3
				238	16
96906	MS51967-21		5310-00-915-4891	36	5
				185	6

CROSS-REFERENCE INDEXES

CAGEC	PART NUMBER	PART NUMBER INDEX		FIG.	ITEM
			STOCK NUMBER		
96906	MS51967-21		5310-00-915-4891	187	2
96906	MS51967-23		5310-00-763-8921	238	4
96906	MS51967-5		5310-00-880-7744	39	16
				239	10
96906	MS51967-8		5310-00-732-0558	48	16
				81	13
				182	6
				250	11
96906	MS51968-14		5310-00-732-0560	238	28
96906	MS51988-7		5310-00-930-8214	208	5
96906	MS75021-2		5935-00-846-3884	103	60
96906	MS9068-016		5331-00-044-5726	159	30
96906	MS90725-187		5305-00-939-9204	238	6
96906	MS90725-27		5306-00-225-8492	43	5
96906	MS90725-34		5306-00-225-8499	239	16
96906	MS90725-36		5306-01-075-8519	145	8
				222	4
96906	MS90725-39		5306-00-225-8503	182	24
				212	4
96906	MS90725-6		5305-00-068-0502	37	7
				60	57
				82	17
				113	7
				208	23
96906	MS90725-60		5305-00-269-3211	31	4
				59	10
				154	3
				182	7
				204	6
				206	6
				217	3
96906	MS90725-68		5305-00-269-3218	158	25
				208	2
96906	MS90727-219		5305-00-926-5517	196	15
96906	MS90728=8		5305-00-225-3843	151	33
96906	MS9356-04			90	2
96906	MS9356-06		5310-00-490-6482	43	2
				92	14
24975	M027095090		2920-01-104-8950	60	41
24975	M151055272		2920-00-058-6608	60	14
98441	M2130808-4-4-4-2		4720-01-332-5963	154	14
	9.00				
81349	M45913/1-10CG5C		5310-00-269-4040	147	22
				160	9
				193	9
81349	M45913/1-4CG5C		5310-00-088-1251	15	2
				32	5
				40	3
				42	4
				49	8
				55	12

CROSS-REFERENCE INDEXES

CAGEC	PART NUMBER	PART NUMBER INDEX		FIG.	ITEM
			STOCK NUMBER		
81349	M45913/1-4CG5C		5310-00-088-1251	68	34
				76	2
				77	1
				78	3
				81	4
				82	20
				88	2
				91	3
				91	28
				113	1
				135	26
				153	2
				154	33
				155	4
				163	9
				201	29
				201	43
				201	52
				203	26
				205	7
				221	2
				222	23
				224	4
				226	10
				227	4
				229	4
				234	17
	249	13			
	251	4			
	251	9			
81349	M45913/1-5CBB	5310-00-913-3366	91	44	
			92	2	
			249	19	
81349	M45913/1-5CG5C	5310-00-984-3806	145	7	
			145	11	
			168	8	
81349	M45913/1-6CG5C	5310-00-087-4652	30	21	
			39	13	
			154	1	
81349	M45913/1-8CG5C	5310-00-225-6993	22	10	
			193	31	
			194	5	
			251	11	
81349	M45913/2-12CG5C	5310-00-067-6356	195	6	
81349	M83248/1-219	5331-00-166-8406	6	20	
81349	M83420/1-005	4010-00-285-3705	BULK	32	
06721	N-30252-D	4820-01-332-1574	31	16	
06721	N-30255	2540-01-337-4105	86	3	
06721	N-50029-B	2530-01-337-7345	173	1	
80205	NAS1021N17	5310-00-325-1900	154	5	
			156	28	

CROSS-REFERENCE INDEXES

CAGEC	PART NUMBER	PART NUMBER INDEX		FIG.	ITEM
			STOCK NUMBER		
78500	NA1205V1556		5330-01-344-0636	147	11
64678	NPN-DOOR			33	7
21335	NTA2840		3110-00-756-2022	172	21
78500	N110-1		5310-00-276-2698	142	34
58429	N11246			154	23
				156	37
06721	N13440DL		2530-01-332-5446	150	34
06721	N20966R		2530-01-332-1586	152	7
24446	N22P29028C11		5305-00-071-2070	239	15
64678	N220-2		4730-01-337-4479	225	13
06721	N30103BN		2530-01-331-8709	151	7
64678	PAC/12052924		5325-01-446-8320	105	3
31033	PC47607VN208		5325-01-481-3622	200	7
97111	PD38BTX		4220-01-330-0663	174	11
57760	PD6		5340-01-263-0821	174	10
70040	PF-2100		2940-01-412-5275	17	2
61424	PFT-4A BLACKX130		4720-01-267-5991	BULK	37
	0				
64678	PFT-4A-BLK-100X4			150	42
	6				
87373	PFT-4A-BRN		4720-01-478-6407	BULK	40
61424	PFT-4A-RED		4720-01-294-7228	BULK	42
64678	PFT-4A-REDX60			150	47
61424	PFT-4A-YEL		4720-01-293-6177	BULK	41
64678	PFT-4A-YELX24			150	48
61424	PFT-6B-BLK-100		4720-01-182-9067	BULK	45
64678	PFT-6B-BLK-100X1			157	3
	15				
				160	3
64678	PFT-6B-BLK-100X1			155	79
	49				
64678	PFT-6B-BLK-100X1			155	78
	50				
64678	PFT-6B-BLK-100X1			155	11
	59				
64678	PFT-6B-BLK-100X2			150	26
	5				
64678	PFT-6B-BLK-100X3			150	15
	4				
				150	27
93061	PFT-6B-BLK100X42			151	15
93061	PFT-6B-BLK100X54			151	5
61424	PFT-6B-GRN		4720-01-349-1970	BULK	43
64678	PFT-6B-GRNX36			152	26
98441	PFT-6B-ORG		4720-01-364-3392	BULK	44
64678	PFT-6B-ORGX120			155	37
61424	PFT-6B-RED		4720-01-287-9313	BULK	21
93061	PFT-6B-REDX36			152	25
64678	PFT-6B-YELX60			151	21
64678	PFT-8B-BLK-100X1			155	38
	00				

CROSS-REFERENCE INDEXES

CAGEC	PART NUMBER	PART NUMBER INDEX		FIG.	ITEM
			STOCK NUMBER		
64678	PFT-8B-BLKX120			155	36
64678	PFT-8B-REDX60			152	24
87373	PFT10BGRN100X120			155	39
87373	PFT4A BLK100X105			226	23
87373	PFT4A BLK100X48			226	5
64678	PFT4A-BRNX064			151	13
74410	PH-760		2540-01-337-3725	186	1
58451	PL194		6240-00-944-1264	231	3
18876	PMS90727001-06		5306-00-068-0513	227	13
33287	PT 4365-1		5120-01-353-2521	260	6
61424	PTF-6B-YEL		4720-01-293-1827	BULK	20
18265	P14-9099		4820-01-197-1880	232	5
18265	P15-3551		2940-01-333-0724	32	15
78500	P18		4730-00-702-6932	174	18
78500	P28-S		4730-01-347-9326	140	5
				141	5
25511	P49787		4730-00-602-3707	162	43
18265	P52-6150		5305-01-332-6506	32	14
18265	P52-6151		5310-01-332-7278	32	13
18265	P52-6152		5310-01-332-6518	32	12
18265	P52-6735		4140-01-329-1664	33	1
18265	P52-6738			32	3
18265	P52-6745		4710-01-332-6121	32	1
18265	P52-6746		2940-01-333-0723	32	6
18265	P52-6816		5340-01-346-9470	32	11
18265	P52-6817		5340-01-346-9471	32	10
18265	P52-6822		5305-01-346-9416	32	7
18265	P52-6823		5310-01-348-3195	32	8
18265	P52-6824		5310-01-347-7051	32	9
18265	P533226			221	6
				222	21
91816	P59-500		4820-01-120-4532	22	7
76700	Q-02853		5340-01-333-0160	43	1
76700	Q-39426		2990-01-329-9894	43	6
76700	Q-59278		5330-01-358-1289	175	9
78500	QPX 1657 7305			147	1
78500	QPX 1657 7306			147	1
78500	QPX 1657 7909			147	1
78500	QPX 1657 7910			147	1
78500	QP6 1540 1085			146	1
78500	QP6 1540 1086			146	1
93061	QP8020		4730-01-441-8605	155	67
				156	52
7Z588	QS300-M96H		4730-00-355-1872	41	17
76700	Q53670		5305-01-328-4246	175	4
76700	Q63135		5360-01-328-4128	175	7
76700	Q66214		3120-01-329-6626	175	3
76700	Q66957		5310-01-339-1331	175	5
76700	Q80381		4330-01-329-8821	175	8
62534	RD4366-0			234	1
62534	RD5-4471-0			234	10

CROSS-REFERENCE INDEXES

CAGEC	PART NUMBER	PART NUMBER INDEX		FIG.	ITEM
			STOCK NUMBER		
74410	RK-04413		2510-01-333-0199	191	9
74410	RK-331-1		2510-01-479-0997	189	4
74410	RK-331-2		2510-01-479-0989	189	3
74410	RK-331-3		2510-01-479-0990	189	2
74410	RK-351-A-02-L		2510-01-479-0934	KITS	
81349	RNC60K1002FS		5905-00-426-7095	255	31
78500	RP20145NNN2160-5 29			140	2
78500	RR20145NFN3281-5 29			141	2
64678	RUD/AA727	2590-01-479-1562		243	2
64678	RUD/AP003-3			243	12
64678	RUD/AP004-3			243	12
64678	RUD/AP306			243	4
64678	RUD/AP376			243	8
64678	RUD/AP690			243	6
64678	RUD/AP691	5310-01-478-9035		243	5
64678	RUD/AP694	5306-01-479-0281		243	7
64678	RUD/AP695	5310-01-478-8939		243	9
64678	RUD/AP696	5310-01-478-8683		243	10
64678	RUD/KP300	5305-01-479-0269		243	3
78500	R280X	2520-01-325-6405		137	2
04071	R354273-11	5999-01-153-9432		101	12
72582	R5236977			28	1
78500	R801079			146	22
55752	R90-DDC-01	2910-01-443-0385		38	1
78500	R950011	4440-01-443-9031		160	14
78500	R950012			160	15
78500	R950013			160	17
78500	R950014	4820-01-443-6639		160	16
78500	R950015	2990-01-444-2368		160	21
78500	R950017			160	18
78500	R955205			160	13
78500	S-258-1	5305-01-329-3991		138	8
73973	SA098 02			147	21
64678	SIE/481STUDS	2540-01-357-5687		221	4
				222	9
78500	SN-1019-1	5307-01-346-8672		140	16
53421	SNP-7HSO			150	20
02UG1	SP-4097	5930-01-444-3672		250	13
64678	SPF6S055			208	31
64678	SPN/1760	2540-01-330-2621		228	2
64678	SPN/1761	2540-01-328-4750		228	1
78500	SRWABC002			160	20
76005	SSB33-1001-7	5342-01-332-7614		3	4
76005	SSB33-1001-8	5342-01-332-7615		3	6
64678	SS05702-138-060	5310-01-336-9856		201	101
30226	S158KDV1H	2540-01-481-3597		227	14
35510	S214077452	2920-01-082-6731		60	74
18076	S219G18			113	3
78500	S2206-D-1226			160	19

CROSS-REFERENCE INDEXES

CAGEC	PART NUMBER	PART NUMBER INDEX		FIG.	ITEM
			STOCK NUMBER		
78500	S2810B		5305-01-447-6368	146	3
				147	9
78500	S434 100 310 0			160	22
78500	S4410328130		2530-01-479-0838	88	4
78500	S4410328140			88	11
78500	S4419023524			88	1
78500	S4460044260		2530-01-475-4935	107	1
78500	S4497110150			105	7
18076	S463-G18		5340-01-339-7022	76	7
18076	S463-G23		5340-01-332-7473	91	6
				153	4
				154	32
				155	2
18076	S463-G26		5340-01-333-4614	15	22
				91	17
				154	35
18076	S463-G4		5340-01-350-2444	88	7
				226	22
18076	S464-G10		5342-01-333-5993	45	4
18076	S464-G12		5340-01-331-7277	249	12
18076	S464-G15		5340-01-441-1103	15	23
18076	S464-G20		5340-01-348-7014	49	33
18076	S464-G8		5340-01-336-2447	49	22
78500	S4721950760			155	17
78500	S4725004230		4810-01-481-3229	155	14
15434	S627		5310-00-820-6653	238	3
18076	S630-G14		5340-01-334-2880	80	16
				153	5
				155	5
				234	13
18076	S630G-6		5340-01-336-6531	253	8
70210	S8157N100-063		5310-00-687-7697	201	32
78500	S8946010732			105	9
45722	TAPITS10-12-3-4		5305-00-791-9426	89	5
77640	TAS650006		5330-01-328-6054	KITS	
77640	TAS65004		2530-01-327-1350	172	1
77640	TAS652005J1			172	12
77640	TAS653003B3			172	19
77640	TAS653003S3		3040-01-332-1670	172	20
77640	TAS655002J1		5340-01-331-3781	172	5
77640	TAS656005A1		4820-01-332-8542	172	30
77640	TC34055			168	3
74410	TF-0237		5220-01-357-4913	257	4
74410	TFTLN-1000		4910-01-157-3571	259	2
74410	TFTLN-2500		4910-01-165-6015	263	9
70040	TP916		2910-01-022-8183	38	2
27783	TR572-D12			166	4
27783	TR573		2640-00-555-2824	166	3
14859	TXI40PS15-1		5930-01-435-0397	87	4
53421	T120MR		5975-01-350-7083	201	24
60038	T182		3110-00-227-3673	138	33

CROSS-REFERENCE INDEXES

CAGEC	PART NUMBER	PART NUMBER INDEX		FIG.	ITEM
			STOCK NUMBER		
81779	T2062PP			91	38
81779	T3075PP			91	39
01652	U-500		5340-01-079-6715	41	1
14242	UBX-212		4730-00-289-3141	14	6
77342	VF4-15F11-C01			116	8
				252	5
07382	VSH-137-2		5325-01-320-7327	25	2
88763	VSHE1 45 6B		4730-01-331-2844	49	1
93061	VS0103-16-16		4730-01-448-9840	49	31
57760	VS149F-10-6			30	23
77272	VS15305-5039-20		5310-00-781-4762	209	5
93061	VS211P-6		4730-01-332-5999	152	6
93061	VS219P-2		4730-01-332-6000	151	26
93061	VS219P-6		4730-01-244-1265	151	17
93061	VS219P-8		4730-01-441-3513	150	37
98441	VS2202P4-2		4730-01-284-9065	151	30
93061	VS2224P-4			150	28
57760	VS249F-8-6			30	18
93061	VS249F4-4		4730-01-332-2432	153	34
				154	13
93061	VS269NTA-4-2		4730-01-244-0000	150	30
93061	VS269NTA-6-4		4730-01-244-3552	150	7
				154	41
				155	32
				160	34
93061	VS269NTA-6-6		4730-01-244-1226	152	2
				155	23
				155	55
				156	48
93061	VS269NTA-8-6		4730-01-244-1227	152	13
				155	68
93061	VS269NTA-8-8		4730-01-310-4665	153	23
93061	VS279NTA-10-8		4730-01-096-0574	160	24
93061	VS279NTA-6-4		4730-01-365-9072	150	22
93601	VS3103-8-10		4730-01-329-2141	174	17
93061	VS404P-10-6		4820-01-332-1311	55	4
93061	VS48F10-8			155	13
93061	VS68NTA-4-2		4730-01-055-4017	150	38
81722	V4458VG			51	24
12624	V532X3/4IN,X200F T		5330-00-237-6140	BULK	33
82464	W-58-1		4730-01-283-8173	225	16
33457	WF-2077		2910-01-274-1915	55	8
11139	WTA10-24-01			115	33
11139	WTA10-24-02			115	34
11139	WTC04B24-31SN			115	36
11139	WTC06B24-31PN			117	10
11139	WTC06B24-31SN			117	6
81348	WW-P-471ACBBUE		4730-00-010-3875	140	7
				141	7
81348	WW-P-471BDQBUED		4730-00-193-0875	234	6

CROSS-REFERENCE INDEXES

CAGEC	PART NUMBER	PART NUMBER INDEX		FIG.	ITEM
			STOCK NUMBER		
11139	W3P		5935-01-470-8337	254	3
5G881	W4NY-125NA		5340-01-299-1813	226	8
11139	W4S			254	6
74410	XA-01586		5315-01-328-4106	191	4
74410	XA-0372-A		5340-01-328-4513	191	3
74410	XA-07150-L		3040-01-440-1841	190	28
74410	XA-07151-1			190	13
74410	XA-07292-T		5315-01-440-1440	190	22
74410	XA-07295		2510-01-439-7490	190	1
74410	XA-07296		2510-01-439-5341	190	25
74410	XA-1029		3110-01-168-9203	190	29
74410	XA-1507		3120-01-168-9204	190	12
74410	XA-1706		5307-01-160-0471	190	4
74410	XA-199		4010-01-293-1710	186	11
74410	XA-2501		5340-01-159-6484	191	7
74410	XA-2503		5315-01-159-1263	191	6
74410	XA-2524-R		2590-01-155-5873	191	8
74410	XA-3528		3040-01-164-9277	190	19
74410	XA-3542-M		2510-01-198-0857	190	21
74410	XA-7001		2510-01-155-5796	191	2
74410	XA-761		2540-01-289-3947	186	12
74410	XA-763			186	17
74410	XA-763-A		2540-01-337-9004	186	18
74410	XA-764-A		2540-01-151-5703	186	5
74410	XA-766-1		4730-01-293-6907	186	6
74410	XA-768		5310-01-336-6745	186	8
74410	XB-CX-58-F-134		5305-01-161-0017	190	11
74410	XB-HNH-34-F		5310-01-162-4753	190	8
74410	XB-PW-1316-112		5310-01-160-9956	190	7
74410	XB-PW-1732-1-116			190	15
74410	XB-T-49		5310-01-199-9467	190	17
74410	XB-T-69-A		5310-01-165-2274	190	27
74410	XB-02312			190	5
74410	XB-07291		5360-01-439-2291	190	16
74410	XB-07431		5310-01-439-4256	190	2
74410	XB-07508			190	14
74410	XB-07628		5360-01-439-2295	190	24
74410	XB-08559			190	10
74410	XB-1127		5365-01-162-4787	190	6
74410	XB-128		5305-00-486-5292	186	13
74410	XB-1505		5360-01-165-2290	190	3
74410	XB-2083		5305-01-161-0019	190	9
74410	XB-21-S-500-2750		5315-01-167-0207	190	18
74410	XB-2149		5360-01-165-2301	190	20
				190	26
74410	XB-2502		5360-01-159-6485	191	5
74410	XB-5		5315-00-849-9854	190	23
74410	XB-767		4730-00-050-4203	136	4
				186	3
				186	14
74410	XB-769		5310-01-150-8599	186	19

CROSS-REFERENCE INDEXES

CAGEC	PART NUMBER	PART NUMBER INDEX		FIG.	ITEM
			STOCK NUMBER		
74410	XB-771-1		5310-01-336-6681	186	10
74410	XB-772		5305-01-337-4796	186	15
74410	XB-773		5315-00-234-1848	186	9
76377	XE-16		5120-01-355-4791	264	2
14351	X296		5310-00-584-5272	238	18
61349	Y101506		6250-01-443-0403	70	8
76385	Z-3003		5325-00-432-7380	100	4
				100	17
8E515	Z053095777		5331-01-304-3453	60	7
35510	Z082095780		3120-01-306-9870	60	55
35510	Z0930-78423		5310-01-120-6997	60	2
75078	00-016557		5365-01-323-5621	26	6
64678	000127 008203		5310-01-334-3646	173	35
64678	000933 010020		5306-01-286-7169	37	1
64678	000933 010128		5306-01-286-7169	234	9
64678	000933 010174		5306-01-243-1346	15	6
64678	000933010016		5306-01-244-3973	76	8
75078	001082		5331-01-085-3105	26	10
75078	001083		5330-01-086-6196	26	11
75078	001492		5305-01-145-8384	26	25
75078	001519		5360-01-089-9103	26	4
10402	01-0681853LASC		6220-01-218-4968	245	1
64678	01-11367-000		5340-01-335-6703	56	5
64678	01-11424-010		5306-01-440-8202	56	9
64678	01-12120-001		5365-01-333-4556	4	9
64678	01-14976-001		5365-01-332-6546	3	3
64678	01-15047-000		5365-01-333-3575	3	5
64678	01-15492-000		2510-01-333-0206	4	12
64678	01-16492-000		4710-01-332-2408	35	4
64678	01-20753-000		5340-01-333-6039	4	3
64678	01-20963-000		5310-01-333-4537	4	5
64678	01-20963-001		5310-01-474-8462	4	11
64678	01-21187-000		5340-01-334-7424	55	2
64678	01-21193-000		5340-01-332-6583	15	11
64678	01-21200-001		4720-01-332-6010	35	3
64678	01-21823-000		4710-01-439-4427	15	9
64678	01-22830-000		4710-01-478-6094	35	1
64678	01-22950-000		3020-01-439-7085	56	11
64678	01-23127-000			35	6
64678	01-23132-000			35	10
64678	01-23292-000			177	21
64678	01-23808-001			39	11
64678	01-23914-000			39	14
64678	01-4811-77		6220-01-357-1883	73	1
64678	01-5371-78		6220-01-440-8056	80	5
81834	01-5377-71		6220-01-440-8065	80	5
81834	01-6496-74			79	13
81834	01-9213-32		6220-01-339-1192	79	3
81834	01-9218-70		6220-01-339-1193	82	2
81834	01-9233-71		5325-01-337-0387	98	4
75078	011426		5305-01-320-7142	26	17

CROSS-REFERENCE INDEXES

CAGEC	PART NUMBER	PART NUMBER INDEX		FIG.	ITEM
			STOCK NUMBER		
75078	011930		4820-01-338-4270	26	7
75078	012983		1650-01-319-0808	26	13
75078	012990		5360-01-325-1570	26	12
75078	016505		5310-01-338-6844	26	3
75078	016771			26	20
0HXS2	017-0007-001		4730-01-441-6491	231	14
75078	017658		5360-01-481-3524	26	26
75078	018179		5360-01-481-3527	26	5
77060	01864022			110	22
75078	019576		5360-01-481-3525	26	21
75078	019740			26	23
75078	019741			26	22
75078	019987			26	15
64678	02-09920-000			145	3
64678	02-12094-010			145	4
77640	020228			172	50
75078	020229			26	9
77640	020251		5305-01-136-1619	172	18
77640	021200		5305-00-899-2049	172	43
77640	021407			172	8
77640	021407X1		5305-01-328-4245	KITS	
2E480	023432		5940-01-336-6329	109	3
2E480	023433		5940-01-336-7062	109	2
0W4A6	024-21590		2520-01-448-9159	248	1
75078	024338			26	19
77640	025119			172	9
75078	025911			26	1
75078	025914			26	16
77640	026124		5310-01-331-9710	168	1
76640	027007			172	26
75078	028082			26	14
77640	028519		3110-01-328-4066	172	41
0W4A6	029-09888		5315-01-440-0441	248	2
77640	029116			172	28
77640	029119		5310-01-329-3925	172	11
77640	029124			172	23
64678	03-17755-000		2510-01-333-0740	33	8
64678	03-17759-000		5340-01-332-7372	33	5
				33	16
64678	03-17827-000		5340-01-333-4670	31	13
64678	03-17840-000		5335-01-337-2521	33	10
64678	03-17841-000		5330-01-332-7292	33	6
64678	03-20493-000		2520-01-349-9996	33	19
64678	03-20537-000		5340-01-340-5633	31	11
64678	03-20618-000		5330-01-346-3816	33	18
64678	03-21346-000			36	10
64678	03-21347-000			36	9
64678	03-22885-000		4710-01-439-5383	31	19
64678	03-27310-004			36	11
64678	03-32071-000			30	15
77640	032200-152			172	29

CROSS-REFERENCE INDEXES

CAGEC	PART NUMBER	PART NUMBER INDEX		FIG.	ITEM
			STOCK NUMBER		
77640	032200-158			172	24
77640	032229		5331-01-135-4807	172	48
77640	032590		5331-01-135-4069	172	35
77640	032615		5330-01-135-4068	172	36
77640	032616		5330-01-149-7229	172	45
77640	032823			172	17
53867	0332-204-101		5945-01-095-6280	74	1
				75	1
77640	036201			172	3
77640	037027		4730-01-329-1842	172	49
64678	04-09152-026		2990-01-439-5607	41	8
64678	04-10259-000		5340-01-328-4368	42	7
64678	04-11848-000		5340-01-328-4369	42	13
64678	04-12099-000		2990-01-329-9895	41	14
64678	04-12584-000			42	16
64678	04-12585-000			42	15
64678	04-14209-000		2990-01-329-9899	41	9
64678	04-15105-000		2990-01-329-9896	41	12
64678	04-16076-000		2990-01-479-2450	41	16
64678	04-16554-001			42	14
64678	04-17094-030		2990-01-478-6000	41	5
64678	04-19105-013		4720-01-478-6009	41	7
64678	04-19249-000		5340-01-479-0540	41	6
64678	04-19338-017		2990-01-478-6006	41	3
77640	040209		5315-01-328-4112	172	39
77640	040210		5315-01-328-4104	172	37
11139	0460-202-16141		5999-01-216-3648	254	2
				255	23
11139	0460-215-16141		5999-01-373-4494	117	11
11139	0460-220-1231		5940-01-446-7581	108	3
11139	0462-201-16141		5999-01-203-6687	66	3
				115	35
				254	4
11139	046220116141		5999-01-203-6687	117	7
11139	046220216141			117	12
64678	05-09562-005			49	29
64678	05-09562-006			49	5
64678	05-12207-000		5340-01-332-1539	45	21
64678	05-12289-000		5330-01-329-6920	45	9
64678	05-12295-000		5340-01-333-3003	45	8
64678	05-12499-000		5340-01-332-1540	45	11
64678	05-12538-028			49	13
64678	05-12539-024			49	17
64678	05-12539-043			49	3
64678	05-12795-000		5340-01-329-4107	44	6
64678	05-12952-000		5340-01-329-4090	44	22
64678	05-12952-001		5340-01-329-4091	44	10
64678	05-13022-000		5340-01-329-4108	44	2
64678	05-13033-000		5340-01-329-4092	44	9
64678	05-15274-000		5340-01-329-3719	44	19
64678	05-15353-000		5340-01-328-4370	49	24

CROSS-REFERENCE INDEXES

CAGEC	PART NUMBER	PART NUMBER INDEX		FIG.	ITEM
			STOCK NUMBER		
64678	05-15799-000		2930-01-331-1731	45	6
64678	05-16070-000		5342-01-332-3584	44	16
64678	05-16960-000		4720-01-478-8827	135	8
64678	05-17081-000			46	10
64678	05-17251-000			135	9
64678	05-17252-000			135	11
64678	05-18833-000		4720-01-478-6012	49	23
30780	053T-8-8		5331-01-328-6016	174	12
2E480	059011			109	6
2E480	059022		5935-01-347-2657	109	4
				255	38
2E480	059056		5940-01-336-6325	93	41
				101	10
64678	06-09782-000		5340-01-331-9466	15	1
				154	31
				234	7
64678	06-09782-001		5340-01-474-9827	55	13
64678	06-09782-003		5340-01-474-9584	22	8
				135	5
64678	06-13076-000			201	44
64678	06-15160-000			59	1
64678	06-17156-006		2510-01-338-9982	211	8
64678	06-17867-000		5930-01-336-3684	93	52
64678	06-17964-000			211	9
64678	06-17964-001			211	6
64678	06-17976-000			92	6
64678	06-17976-001			92	27
64678	06-18043-000		6220-01-338-5992	80	18
64678	06-18043-001		6220-01-338-5993	80	2
64678	06-18126-000		2590-01-338-6044	79	25
64678	06-18126-001		6220-01-338-5928	79	25
64678	06-18131-001			92	5
64678	06-18158-000		6150-01-339-9891	91	16
64678	06-18159-000		6150-01-336-6477	91	12
64678	06-18203-001			102	6
64678	06-18305-001			82	18
64678	06-18338-000		5340-01-336-6115	68	42
64678	06-18405-001			92	4
64678	06-19019-000		6350-01-367-0757	90	3
64678	06-19508-000		6150-01-338-9777	91	10
64678	06-19690-000			91	37
64678	06-19807-000		5340-01-355-5416	73	3
64678	06-20072-000		5340-01-411-3823	81	12
64678	06-20072-001		5340-01-410-7065	81	8
64678	06-20733-001			37	13
64678	06-20879-000		5340-01-391-1349	92	30
64678	06-21383-000			91	40
64678	06-22309-000		6220-01-442-1071	70	1
64678	06-22309-001		6220-01-440-2402	70	2
64678	06-22309-002			111	1
64678	06-23089-000		5340-01-447-6352	110	29

CROSS-REFERENCE INDEXES

CAGEC	PART NUMBER	PART NUMBER INDEX		FIG.	ITEM
			STOCK NUMBER		
64678	06-25941-000			91	47
64678	06-26822-000			107	4
64678	06-27069-000			106	2
64678	06-32041-101			92	13
64678	06-32349-000			251	14
64678	06-35699-001			91	31
64678	06-35870-000			251	6
64678	06-36014-000			91	24
77640	062005		2530-00-225-0680	172	44
19986	062659			225	28
19986	063350			225	21
06853	065187		2530-01-332-8475	150	18
06853	065706		2530-01-478-8502	155	44
				156	19
19986	066011		2540-01-361-5146	225	31
19986	066023		2590-01-361-2388	225	34
64678	07-11652-000		5340-01-318-2049	121	6
64678	07-14494-000			120	10
64678	07-14642-000			120	3
64678	07-9485-000		5360-01-345-5386	121	3
81495	071 312 13		5305-01-281-7811	142	5
77640	071020		3130-01-328-4447	172	14
75078	071565		2530-01-319-0833	26	24
16956	08-402		5975-01-338-9190	67	10
				76	3
				231	25
16956	08-404		5975-01-355-4570	49	18
				76	1
77640	080154		5365-01-330-2164	172	38
30756	088335-00		4130-01-445-0443	250	7
11139	0914-212-2486			115	38
2E480	092576		6150-01-337-5038	93	34
				93	43
2E480	092578		6150-01-359-5773	93	42
2E480	092579		6150-01-337-5039	93	36
2E480	092580		6150-01-339-8299	93	38
2E480	092587		6150-01-353-4812	93	37
11139	0926-208-2401			115	39
2E480	092612		6150-01-353-1002	93	35
06789	0984-C		2815-01-338-2566	12	2
D8129	1 04 00 23727 0		5340-01-358-4652	98	5
00779	1 9673671			110	5
00779	1-86402-2		5935-01-367-8677	115	32
80204	1/4-2OUNC-2AX1 L		5305-01-285-3996	92	23
	G PAN HD				
50022	1AC00044S		2930-01-479-1384	45	14
45152	1PS100			159	14
45152	1PS47			159	27
45152	1PS66			159	24
45152	1PS88			159	34
45152	1PS90			159	44

CROSS-REFERENCE INDEXES

CAGEC	PART NUMBER	PART NUMBER INDEX		FIG.	ITEM
			STOCK NUMBER		
45152	1PS93			159	47
98441	1X1.5FFF-S		4730-01-350-1589	15	18
81343	10-10 010101B		4730-00-277-3874	163	6
64678	10-12032-002		2510-01-479-1515	194	9
64678	10-12233-000			194	4
64678	10-12332-000		3120-01-478-4833	88	6
28839	10-51354		5310-00-442-0908	230	22
81834	10-7103-03			80	13
81343	10-8-100302BA		4730-01-096-0574	153	15
				156	44
				158	12
78500	10X1594		5305-01-466-4547	141	15
				142	63
78500	10X1597			141	18
				142	64
62380	100.424		5340-01-285-5558	240	33
75418	1002-07005-35		2990-01-332-5459	89	10
70763	1002931		4320-01-317-8240	29	8
36378	1003292-07		5935-01-023-4871	101	11
				116	4
36378	1003296-02		5935-01-024-1902	115	13
07295	100740		4730-00-900-3296	151	32
5R547	101028-B02		5940-01-336-6322	65	4
				93	57
				96	24
56563	101624-01		5320-01-032-1043	33	11
				83	8
4N501	102290		5306-01-479-0111	165	4
D8129	10239219160		5999-12-301-9403	98	6
06721	102461-K		3040-01-315-6720	151	6
75078	1024612			26	8
06853	103081			159	52
4N501	103193		5306-01-479-0176	164	5
75418	1033-05435-03		2520-01-441-1704	KITS	
75418	1033-07781-01		2930-01-441-1726	KITS	
75418	1033-08250-01		2520-01-441-1736	KITS	
4N501	103430			165	5
4N501	103620G		2590-01-478-9451	88	10
4N501	103705		2530-01-478-9211	165	7
4N501	103706		2530-01-478-9345	164	6
62793	104J005-29		5310-00-004-5033	81	14
D8129	10400237241		3040-01-337-4160	98	7
4N501	104221		2530-01-478-9360	164	3
4N501	104434			165	2
4N501	104437			165	2
3B481	106079-002		5306-01-334-2813	219	5
3B481	1063016-002			220	13
3B481	1063248-801			220	16
3B481	1064790-002			220	8
3B481	106713-001		5305-01-332-7560	219	8
79470	1070X4		4730-01-200-4278	31	6

CROSS-REFERENCE INDEXES

CAGEC	PART NUMBER	PART NUMBER INDEX		FIG.	ITEM
			STOCK NUMBER		
06853	107082			162	2
4N501	107119		5120-01-479-4986	259	8
3B481	107226-001		5305-01-333-4516	220	23
06853	107516		2815-01-334-8096	KITS	
06853	107639		4310-01-334-8636	KITS	
75418	1077-07895-04			54	26
3B481	107913-001		5305-01-332-7219	220	11
06853	107969		3120-01-334-2740	KITS	
06853	108842		2530-01-452-4670	KITS	
19207	10890481		8105-00-477-3716	238	13
75418	1090-08500-01			54	2
19207	10906697		6685-00-618-1822	238	11
				239	22
75418	1093-07896-04		2930-01-437-0479	54	1
06853	109363			162	20
06853	109426		2835-01-435-8024	162	1
06853	109884			162	34
64678	11-09624-100		5306-01-327-5536	192	4
64678	11-09624-105			192	4
64678	11-17450-000			192	6
64678	11-19895-000		5306-01-479-0376	193	8
64678	11-20807-000			193	4
64678	11-20808-000			193	3
64678	11-20810-000			193	33
64678	11-22804-000			193	1
64678	11-22814-000			193	5
64678	11-22815-000			193	32
3B481	1100642-001			220	14
3B481	1102769-001		5305-01-350-7067	219	20
3B481	1102770-001		5340-01-332-6705	220	28
3B481	1102812-001		5342-01-331-9612	220	1
3B481	1104385-002		5310-01-333-4542	219	19
06853	110447			162	33
3B481	1104926-002			220	3
3B481	1104950-001			220	22
3B481	1104984-002			220	6
3B481	1105712-002			220	4
3B481	1105957-002			219	9
3B481	1105995-002			219	12
3B481	1105999-002			219	13
3B481	1106001-002		5340-01-332-6591	219	11
3B481	1106004-002			219	7
3B481	1106019-004			220	21
3B481	1106021-002		5340-01-333-6624	220	26
3B481	1106025-002			220	12
3B481	1106026-002			220	18
3B481	1106039-002			220	9
3B481	1106049-002			219	18
3B481	1106051-002			219	10
3B481	1106065-002			219	16
3B481	1106214-002			219	15

CROSS-REFERENCE INDEXES

CAGEC	PART NUMBER	PART NUMBER INDEX		FIG.	ITEM
			STOCK NUMBER		
3B481	1106335-004.			220	24
5R547	110634-AK02		5940-01-336-7056	65	13
				65	15
5R547	110640-AK02		5940-01-336-5777	93	46
3B481	1106529-002			219	6
3B481	1106537-364		2540-01-329-1682	219	2
3B481	1106617-002			220	15
86845	1106729-001		3990-01-333-9342	220	2
3B481	1106748-001		3120-01-332-7172	220	17
3B481	1106834-002			220	7
3B481	1107352-002		4720-01-332-1604	220	10
3B481	1107485-032			219	4
5R547	110751-D02		5940-01-338-1964	65	19
3B481	1107585-600		2540-01-329-8654	219	3
06853	110907			162	15
06853	110910			162	12
06853	110911			162	8
3B481	1111134-002			219	1
06853	111666			162	14
11139	112263-90		5310-01-086-7726	101	13
11139	112264		5310-01-081-0799	101	14
06853	112442		2530-01-083-8102	159	20
06853	112514			162	41
06853	112531			162	23
06853	112547			162	25
06853	112550			162	29
06853	112551			162	27
06853	113054			162	28
06853	113189			162	26
11139	114017		5935-01-174-1235	66	4
				117	5
				255	21
11139	114020-90		5310-01-086-7725	255	25
11139	114021		5310-01-081-0798	255	24
7X677	11500930		5305-01-153-1375	124	1
73342	11501822			125	1
11862	11503454		5306-01-186-5367	6	24
				19	6
				34	22
				63	12
				161	7
72582	11504822		5305-01-319-9881	11	11
				19	5
				21	2
				25	13
				27	8
				27	17
				53	6
11862	11504986		5306-01-185-7051	2	1
				30	10
				63	1

CROSS-REFERENCE INDEXES

CAGEC	PART NUMBER	PART NUMBER INDEX		FIG.	ITEM
			STOCK NUMBER		
73342	11505232		5305-01-360-2038	122	7
11862	11505299		5306-01-185-7049	19	10
				27	22
				30	12
73342	11506706		5320-01-360-0925	130	4
72582	11507036		5310-01-330-7592	30	9
				34	15
72582	11509512			161	8
72582	11509514		5305-01-356-1546	19	11
				20	10
72582	11509523			27	15
				51	4
72582	11509525			27	13
				53	1
72582	11509526		5305-01-332-1487	23	4
72582	11509527		5305-01-322-8772	51	8
72582	11509528		5305-01-320-7157	5	4
72582	11509530		5305-01-322-2917	5	2
72582	11509531		5305-01-339-0901	53	4
72582	11509533		5305-01-319-8651	53	5
72582	11509584		5310-01-321-5302	25	11
72582	11509607		5310-01-336-6222	24	1
72582	11509799		5305-01-332-1488	23	3
73342	11513011		5315-01-360-4772	134	75
72582	11513811		5305-01-320-2007	27	25
72582	11513960		5306-01-320-3943	53	7
73342	11515190		5306-01-360-2033	128	18
73342	11515309		5306-01-281-0554	134	52
73342	11515310		5306-01-359-9429	134	24
73342	11515469		5305-01-359-9445	130	1
45152	115307A		5310-01-151-1036	35	5
				82	15
				102	8
				169	7
				185	10
08806	1156		6240-00-924-7526	80	6
08108	1157		6240-00-889-1799	80	10
19207	11602023		5342-00-833-1236	32	16
19207	11628332-2		5310-01-109-1977	41	11
				44	4
				92	10
				160	11
				174	4
				176	13
				176	21
				177	9
				178	3
				181	8
				182	14
				183	2
				184	2

CROSS-REFERENCE INDEXES

CAGEC	PART NUMBER	PART NUMBER INDEX		FIG.	ITEM
			STOCK NUMBER		
19207	11628332-2		5310-01-109-1977	193	30
				206	16
19207	11630529		1095-00-763-7348	244	3
19207	11630594		2590-00-264-8828	244	4
19207	11664241		5310-00-231-0280	173	27
94223	1183		5310-00-556-8420	201	18
				207	7
74410	119-1		5315-01-153-1451	186	7
78500	1199-A-963		4730-01-357-8736	137	4
78500	1199R2176		5315-00-880-6027	142	24
				144	16
64466	12-006		5342-01-336-7391	154	24
				155	46
				156	35
64678	12-09068-006		5340-01-336-6663	72	4
64678	12-10945-000		4730-01-332-2465	151	20
64678	12-11596-000		5330-01-442-0443	151	34
64678	12-12238-000			145	6
64678	12-12241-000		5315-01-328-4358	145	12
64678	12-12277-000			159	4
64678	12-12280-000		5360-01-328-4126	145	24
64678	12-12336-000			145	15
64678	12-13299-000			153	8
64678	12-13340-000			145	23
64678	12-13367-060			31	7
64678	12-13367-142			150	1
				217	1
64678	12-13370-037			151	14
64678	12-13371-037			151	8
64678	12-13608-000		5340-01-332-6590	154	22
64678	12-14109-000			156	18
64678	12-14496-004			160	7
64678	12-14621-000		5325-01-406-2124	225	37
64678	12-15218-001			155	18
64678	12-15604-000			154	50
64678	12-15695-000			152	21
64678	12-17042-000			221	7
81343	12-8 430260B		4730-01-335-9621	240	28
64678	12-9287-001		4730-01-332-6117	154	12
11873	12F10-00			116	7
74410	120-2		5310-00-484-8816	186	4
3B481	1200025-001			220	5
11862	12004008		5920-01-149-6952	67	16
11862	12004009		5920-01-085-0825	74	11
11862	12004010		5920-01-149-6953	74	2
77060	12004264		6250-01-432-9541	93	72
77060	12004433		5940-01-366-1561	96	28
77060	12004435		5940-01-329-1096	100	11
				100	16
77060	12004436		5940-01-341-7689	68	18
				93	51

CROSS-REFERENCE INDEXES

CAGEC	PART NUMBER	PART NUMBER INDEX		FIG.	ITEM
			STOCK NUMBER		
77060	12004437			67	13
			5940-00-113-9820	93	12
			5940-01-336-6322	109	9
77060	12004438		5940-01-336-6323	65	18
77060	12004439		5940-01-336-7056	93	44
64466	12008			103	10
				103	18
			4730-01-244-5365	154	27
				155	41
				156	30
19204	12008084		3040-01-036-6582	91	8
77060	1201 0182		5999-01-214-9682	64	4
				65	21
				100	9
				100	19
77060	1201 0293		5975-01-226-8078	65	36
77060	1201 0300		5975-01-339-9574	65	26
77060	1201 0717			104	5
			5935-01-336-6409	65	24
				117	18
77060	1201 0973		5935-01-214-4163	65	30
				66	22
				96	15
				65	28
77060	1201 0974		5935-01-336-5396	65	28
77060	1201 0996		5935-01-338-3532	65	31
				66	7
				96	17
				115	16
77060	1201 5092			115	16
64678	1201 5271		5935-01-337-1028	93	64
				94	17
				63	3
77060	1201 5284		5330-01-292-5293	66	9
				115	17
				93	27
77060	1201 5508		5935-01-336-6412	93	27
77060	1201 5509		5935-01-336-5395	65	12
77060	1201 5510		5310-01-350-7074	65	2
				93	26
				65	10
77060	1201 5511		5935-01-336-9065	65	10
77060	1201 5791			93	28
			5935-01-291-2814	65	20
				67	5
77060	1201 5792		5935-01-214-5259	65	32
				66	5
				100	21
				65	27
77060	1201 5797		5935-01-308-8599	65	27
77060	1201 5870		5940-01-340-9064	93	9
				93	29
				93	49
77060	1201 5880		5940-01-337-3317	93	49
77060	1201 5966		5935-01-336-6411	96	34
77060	1201 5968		5970-01-341-7696	93	32
				96	31

CROSS-REFERENCE INDEXES

CAGEC	PART NUMBER	PART NUMBER INDEX		FIG.	ITEM
			STOCK NUMBER		
77060	1201 5969		5970-01-341-7697	93	30
				96	35
77060	12010293		5975-01-226-8078	67	7
				96	12
				96	13
77060	12010300		5975-01-339-9574	110	23
				117	17
22785	12010973		5935-01-214-4163	117	21
77060	12015193		5975-01-333-5974	65	22
				96	3
				97	5
				99	4
				100	8
				100	18
				103	48
77060	12015199			255	39
77060	12015271		5935-01-337-1028	108	7
				108	12
				109	8
				255	34
77060	12015284		5330-01-292-5293	104	4
				110	26
				117	14
77060	12015323		5975-01-310-5011	101	27
77060	12015344			108	11
				110	18
				112	2
				255	13
77060	12015345			101	17
				108	13
				110	19
				112	7
				255	16
77060	12015360		5975-01-340-0600	67	17
77060	12015664			93	11
				110	16
				116	5
77060	12015793		5935-01-292-2336	65	25
				101	25
				115	18
				117	19
77060	12015823			108	15
77060	12015865		5940-01-441-7557	110	12
77060	12015869			101	8
				255	36
77060	12015870		5940-01-340-9064	110	15
77060	12015952			93	22
				101	24
				103	28
				109	13
77060	12015987			93	21

SECTION IV

TM9-2320-302-24P

CROSS-REFERENCE INDEXES

CAGEC	PART NUMBER	PART NUMBER INDEX		FIG.	ITEM
			STOCK NUMBER		
77060	12015987			101	22
				103	30
				109	11
77060	1202 0116		5940-01-340-0587	65	7
				93	63
				94	18
				96	29
77060	1202 0120		5940-01-342-1640	65	6
				93	20
				96	33
77060	1202 0126		5940-01-340-0588	65	5
				96	36
				112	6
77060	1202 0128		5935-01-336-5400	96	32
77060	1202 0545		5935-01-336-6413	93	31
77060	1202 0629		5935-01-338-3534	65	11
77060	1202 0833			103	23
77060	12020035			101	9
77060	12020116		5940-01-340-0587	255	37
				108	8
				109	7
				110	20
				112	8
77060	12020119			101	21
77060	12020120		5940-01-342-1640	109	10
				255	27
77060	12020321		5940-01-400-0618	255	35
77060	12020807			117	24
77060	12020833		5935-01-471-1122	103	4
77060	1203 3820		5940-01-342-0558	65	8
				103	31
				67	14
77060	1203 3997		5940-01-336-6331	66	10
77060	1203 4398		5935-01-336-6408	66	12
77060	1203 4413		5935-01-336-1792	108	14
77060	12033821			110	13
77060	12033871			110	14
77060	12033872			110	17
77060	12034046		5940-01-357-0069	115	7
				255	12
				96	30
				101	18
				108	10
77060	12034047		5940-01-391-9982	110	21
				115	11
				255	15
				112	5
				116	6
77060	12034295			63	10
77060	12034400		5935-01-318-1066	99	3
77060	1204 0559		5940-01-340-0586	96	26
77060	1204 0753		5935-01-319-2334		

CROSS-REFERENCE INDEXES

CAGEC	PART NUMBER	PART NUMBER INDEX		FIG.	ITEM
			STOCK NUMBER		
77060	1204 0977		5935-01-336-9924	94	6
77060	1204 1411		5935-01-336-5399	63	14
77060	1204 5575		5935-01-349-0792	93	61
64678	1204 5696		5935-01-338-3533	79	14
77060	1204 5699		5970-01-344-1070	79	17
				96	21
				98	3
77060	1204 7680		5940-01-333-6368	63	7
				64	5
77060	12040753		5935-01-319-2334	63	6
77060	12045537			255	19
77060	12045699		5970-01-344-1070	103	21
				103	35
77060	12045773		5999-01-364-1237	104	12
77060	12045808		5935-01-364-4696	104	13
77060	12045810		5340-01-365-1034	104	10
77060	12045889		5935-01-336-6410	93	59
				255	17
77060	12045890		5935-01-336-3693	93	62
				255	18
73342	12047662			134	15
73342	12047664			134	17
73342	12047767			134	16
77060	12048074		5940-01-366-1563	105	4
77060	12048159			66	15
			5940-01-462-1717	96	38
				110	25
				117	23
77060	12048254			103	15
77060	12048344			101	33
77060	12048345			101	34
				101	35
77060	12048346			101	32
77060	1205 2455		5940-01-342-3882	96	23
				98	9
77060	1205 2613		5935-01-336-9923	93	4
				103	13
				103	41
78500	1205G761		5331-01-478-5191	146	7
77060	12052139			103	12
				103	43
77060	12052172			103	7
				103	50
77060	12052387		5930-01-336-5334	79	16
				96	20
				98	8
				103	19
77060	12052456			103	39
77060	12052641			63	15
77060	12052816			67	18
77060	12052924		5325-01-446-8320	104	11

CROSS-REFERENCE INDEXES

CAGEC	PART NUMBER	PART NUMBER INDEX		FIG.	ITEM
			STOCK NUMBER		
77060	12059160			255	4
77060	12059162			255	6
77060	12059168		5340-01-365-1035	66	13
77060	12059257			103	36
77060	12059260			103	14
				103	25
				103	37
77060	12059860			255	28
77060	12059897			103	6
				103	40
77060	1206 4735		5999-01-337-0088	79	15
				96	19
77060	1206 4998			115	6
77060	1206 4999			115	9
77060	1206 5141			115	12
77060	1206 5143		5935-01-331-9749	64	8
77060	1206 5172		5935-01-406-3802	66	20
77060	1206 5849		5330-01-440-7532	110	27
77060	1206 6195			115	10
77060	1206 6214		5940-01-347-6142	93	25
77060	1206 6317		5940-01-336-6544	66	14
77060	12064736			103	24
77060	12064737			103	20
77060	12064749			255	26
77060	12064750			255	29
77060	12064751			255	30
77060	12064993			101	2
77060	12065171.			65	35
77060	12065249			65	34
				66	19
77060	12065425		5935-01-364-5211	105	5
77060	12065703			103	8
				103	44
77060	12065848			110	28
77060	12065850			104	2
77060	12065862		5935-01-441-4919	97	3
77060	12065863			103	5
				103	49
77060	12066050			104	7
77060	12066082			103	42
				104	6
				110	30
77060	12066129			104	8
				110	2
77060	12066170			101	4
77060	12066214		5940-01-347-6142	94	5
				112	3
				255	11
77060	12066240		5975-01-475-5309	104	9
73342	12066337		5940-01-461-2235	134	21
77060	12066493		5940-01-336-6327	65	9

CROSS-REFERENCE INDEXES

CAGEC	PART NUMBER	PART NUMBER INDEX		FIG.	ITEM
			STOCK NUMBER		
77060	12066493		5940-01-336-6327	112	4
77060	12077411		5940-01-353-3175	66	18
				67	4
				104	3
77060	12077413			67	3
			5940-01-446-7607	103	47
77060	1208 4588			93	39
77060	1208 4590		5940-01-337-3319	93	10
77060	1208 4891			96	5
77060	1208 9040		5940-01-234-7272	63	8
				66	8
				115	8
77060	1208 9188		5999-01-323-4929	66	6
				101	26
77060	1208 9305		5999-01-319-7394	65	23
64678	1208 9306		5940-01-336-7095	65	29
64678	1208-9272		5935-01-337-0288	67	9
77060	12084586		5940-01-419-5877	255	33
77060	12084590		5940-01-337-3319	109	5
77060	12084595		5940-01-341-0525	93	3
				103	29
				109	12
77060	12084912		5940-01-442-6298	115	20
77060	12085030			67	15
77060	12089040		5940-01-234-7272	117	20
77060	12089134			93	71
77060	12089649			93	60
				101	3
73342	12092195		5331-01-460-1190	134	9
73342	12092420		5935-01-459-9845	134	20
				134	27
77060	12092733			103	3
77060	12103505			93	45
				108	5
77060	12103881		5940-01-370-5059	66	11
				96	27
73342	12110139		5935-01-460-2344	134	22
77060	12110293			63	11
77060	1212 4685			98	2
77060	1212 9022			115	25
77060	12124075			117	25
				255	2
77060	12124304		5940-01-343-1262	93	24
				101	23
				255	32
77060	12124515		5999-01-458-0082	110	11
77060	12124520			110	9
				255	7
77060	12124582		5999-01-406-4110	65	37
				96	14
77060	12124587			65	38

CROSS-REFERENCE INDEXES

CAGEC	PART NUMBER	PART NUMBER INDEX		FIG.	ITEM
			STOCK NUMBER		
73342	12124618			134	19
77060	12124634		5935-01-447-6280	67	2
73342	12124639		5940-01-461-2236	134	18
				134	20
77060	12124685			96	22
				103	38
77060	12124686			96	18
				103	22
77060	12124819			117	22
77060	12129021		5935-01-460-2479	115	31
77060	12129023		5935-01-460-2601	115	29
77060	12129493		5940-01-469-7988	96	4
				97	4
				117	15
77060	12129557		5935-01-460-7491	115	27
77060	12129565			103	46
77060	12129600			103	2
73342	12129691		5905-01-477-2349	134	14
77060	12146448			255	5
77060	1216 0493			115	19
77060	12160494		5935-01-445-5144	115	21
77060	12160959			110	24
77060	12162182			63	2
77060	12162188			255	1
77060	12162193		5935-01-466-0260	117	26
77060	12162825		5935-01-372-0218	64	7
77060	12176336			105	2
77060	12177289		5935-01-460-2272	115	22
78500	1218-G-85		5315-00-784-0637	147	20
78500	1218G85		5315-00-784-0637	146	17
77060	12191001		5935-01-460-2478	115	30
77060	12191002		5935-01-460-2604	115	23
77060	12191003		5935-01-466-7448	115	28
78528	12244		5945-01-479-0302	48	9
78500	1225-B-496		3120-00-255-6042	147	5
78500	1225-R-512		3120-01-478-8661	147	10
78500	1225-W-985		5365-01-329-6987	139	2
				139	4
78500	1225B496		3120-00-255-6042	146	5
78500	1225L1208			146	14
19207	12267565		5310-01-083-0104	141	16
				142	26
				142	33
				144	18
78500	1227-R-330		5310-01-254-4255	140	12
				141	12
78500	1227-U-541		5310-01-114-5637	138	26
78500	1227-Z-780		5310-01-115-2550	138	3
78500	1227B106		5310-00-638-2830	138	29
78500	1227J1544		5310-01-194-0658	138	32
78500	1227W517		2520-00-917-7434	140	15

CROSS-REFERENCE INDEXES

CAGEC	PART NUMBER	PART NUMBER INDEX		FIG.	ITEM
			STOCK NUMBER		
78500	1227W517		2520-00-917-7434	141	14
14262	1228-F-552		3110-01-099-4888	144	21
78500	1229-A-1301		5325-00-715-7391	144	20
78500	1229-E-1669-C		5310-01-200-9879	138	9
				142	11
78500	1229-G-4063		5310-01-330-6362	142	66
78500	1229-H-4090			147	12
78500	1229-J-3130			147	13
78500	1229-K-1597		5310-01-083-9509	142	68
				143	4
78500	1229-N-1626		5310-01-059-3609	148	2
78500	1229-N-4590		5310-01-445-9489	146	11
78500	1229-P-2590		5365-01-289-1922	143	9
78500	1229-P-4072		3120-01-325-2638	142	48
78500	1229-S-2697		5365-01-126-9574	146	9
78500	1229-W-3117			147	14
78500	1229-W-4131		5325-01-325-7221	143	7
78500	1229-W-4521S			142	70
78500	1229D2942		5365-01-213-5069	146	10
				147	15
78500	1229E4139			138	15
78500	1229F4634S			140	13
				141	13
78500	1229F474		2530-00-700-1705	138	27
78500	1229G475		2530-00-700-1709	138	28
78500	1229J3130			146	8
78500	1229J4638			140	14
78500	1229T1736		5310-01-185-0433	143	13
				144	27
19207	12328579		4030-01-187-0964	185	14
7X677	12337902		5305-01-251-1626	124	17
				125	2
19207	12342306		5340-01-315-7223	92	17
19207	12389942		8115-01-349-2459	1	3
19207	12389943		8145-01-364-1131	238	1
19207	12389944		8145-01-364-1126	238	20
19207	12389945			238	14
19207	12389946		3990-01-367-4625	238	22
19207	12389948		3990-01-367-8803	238	19
19207	12389949		3990-01-368-7040	238	27
19207	12389950		2510-01-364-8287	238	15
19207	12389951		5330-01-372-5690	238	26
19207	12389955		5342-01-371-6339	238	25
19207	12389969		7690-01-365-9128	238	12
3B481	1239101-002		2540-01-442-6101	218	7
19207	12419140		5999-01-372-4955	113	4
19207	12420936		5999-01-422-9740	67	6
0FW39	12421884		5935-01-470-4143	64	6
19207	12436544		8145-01-386-1304	119	3
78500	1244-V-1764		5365-01-330-2162	142	59
78500	1246-P-1134		5315-01-326-1864	142	23

CROSS-REFERENCE INDEXES

CAGEC	PART NUMBER	PART NUMBER INDEX		FIG.	ITEM
			STOCK NUMBER		
19207	12468576		5330-01-446-4690	81	10
19207	12468578-1		6220-01-445-9920	81	11
5A910	12468579-1-383G		6220-01-446-3528	81	9
19207	12478859.			1	2
19207	12478860			119	2
19207	12478861			138	1
19207	12478862		2520-01-479-2470	140	1
19207	12478863		2520-01-471-5061	141	1
78500	1250-E-473		5365-01-180-2369	140	17
				141	17
78500	1259-N-274		5315-01-129-6898	146	4
				147	4
62380	126830			240	25
52304	1277701		5330-01-117-1014	165	1
78500	13-X-163		5310-01-083-9359	138	17
06853	131081		4820-01-442-8339	162	47
97403	13217E7108-15		4730-01-230-6584	240	29
97403	13222E0109		5305-01-210-4595	185	9
				218	5
21563	13357-1-5			135	19
3B481	1349236-002		5310-01-332-7253	219	17
				220	19
64386	135HL5		4730-01-439-5324	31	18
64678	14-09254-000		3120-01-328-4276	169	3
64678	14-09683-000		5305-01-328-4430	169	6
64678	14-10281-004		2530-01-330-0774	170	5
10402	14-104216-120		5305-00-050-9231	245	3
64678	14-12007-000		2530-01-330-0030	170	2
64678	14-12078-000		5340-01-328-4391	169	2
94222	14-18-150-24		5360-01-128-6186	201	80
11862	14060613		5306-01-165-5583	20	9
11862	14074437		5342-00-455-5899	244	2
72582	144034		4730-00-193-0875	55	17
64386	1449-380-55640		5342-01-331-9919	42	9
24617	145651		3110-00-100-6170	125	11
64678	15-09170-038		5340-01-336-3928	181	19
64678	15-09170-050		5340-01-336-6909	181	15
64678	15-10279-000		2510-01-338-4491	181	20
64678	15-12128-446			176	17
64678	15-12129-446			176	15
64678	15-12182-000		2590-01-337-0425	176	38
64678	15-12182-003		2590-01-337-0426	176	25
64678	15-12185-000		5340-01-336-5953	176	19
64678	15-12185-001		5340-01-337-1033	176	41
64678	15-12186-000		5340-01-336-6665	176	18
64678	15-12621-000		5340-01-336-7829	177	7
64678	15-12643-000		2510-01-338-4486	176	31
64678	15-12644-000		5340-01-336-5957	176	30
64678	15-13270-000		4010-01-336-5983	181	17
64678	15-13538-000			176	26
64678	15-13538-002			176	37

CROSS-REFERENCE INDEXES

CAGEC	PART NUMBER	PART NUMBER INDEX		FIG.	ITEM
			STOCK NUMBER		
64678	15-13541-000		5340-01-336-5954	176	24
64678	15-13541-001		5340-01-337-1034	176	40
64678	15-13553-000		5365-01-337-0371	176	23
64678	15-13565-000		5365-01-337-0372	181	11
64678	15-13915-001			177	8
64678	15-14661-000			177	12
64678	15-15185-000			176	12
64678	15-15636-001			178	7
				179	13
64678	15-17533-000			180	4
64678	15-17534-003			180	1
78500	15X-387			143	5
77060	1530 0002		5935-01-339-3227	66	17
				96	37
				99	2
77060	1530 0014		5340-01-332-6696	66	16
				96	39
				99	5
77060	1530 0017		5940-01-347-3383	96	2
77060	15300014		5940-01-462-1718	117	13
77060	15300016			103	45
77060	15300017		5940-01-347-3383	97	2
77060	15300027		5935-01-308-7866	66	21
				117	16
77060	15305333		5930-01-460-2495	115	26
77060	15305371		5935-01-460-8050	115	24
62380	15527A			240	26
62380	15752A			74	7
62380	15757A			74	6
30226	158HFRGVV2L			227	7
30226	158HFRGVV2R			227	7
93061	159F-10-8		4730-01-094-0941	155	12
93061	159F-6-6		4730-01-158-9201	154	45
64466	16 826		5935-01-478-7605	103	17
64678	16-09040-002		2510-01-326-9147	192	21
64678	16-10386-002			192	12
64678	16-10386-003		5365-01-329-1141	192	12
64678	16-11890-000		2510-01-327-7773	192	19
64678	16-12265-000		5365-01-327-9084	192	15
64678	16-13363-001		5365-01-356-8950	192	11
64678	16-13363-003			192	11
64678	16-13363-005			192	11
64678	16-13363-007			192	11
64678	16-13363-011		5365-01-356-8951	192	11
64678	16-13363-013			192	11
64678	16-13363-015			192	11
64678	16-13363-017			192	11
64678	16-13470-000		3040-01-327-0143	192	13
64678	16-14044-000			195	1
64678	16-14511-003		5306-01-479-0577	193	21
64678	16-15001-000		2530-01-479-1066	196	1

CROSS-REFERENCE INDEXES

CAGEC	PART NUMBER	PART NUMBER INDEX		FIG.	ITEM
			STOCK NUMBER		
64678	16-15001-001		2530-01-479-1172	196	3
64678	16-15002-000		2530-01-479-1184	196	12
64678	16-15002-001		2530-01-479-1053	196	9
64678	16-15010-000			193	17
64678	16-15011-000			193	27
64678	16-15066-004			193	12
64678	16-15067-001			193	29
64678	16-15071-001			196	2
64678	16-15073-000			193	37
64678	16-15076-000			196	14
64678	16-15103-000			193	23
64678	16-15450-000		2510-01-479-2207	195	4
64678	16-15724-002		5360-01-478-7764	193	22
64466	16-726		5935-01-478-7607	103	9
81834	16-9043-07		5935-01-336-3694	93	53
78500	16X-202		5315-01-082-6938	138	19
72582	16070629		2990-01-318-9754	84	1
61349	162309			71	16
61349	162312		6620-01-478-7549	71	23
19738	1641-0631		5320-01-056-2973	169	1
				207	6
07295	16500		4940-01-387-0948	259	5
75078	16766			26	18
59150	168501-00225		6680-01-475-0101	246	3
26501	1697		2530-01-447-9838	226	19
64678	17-10133-000		5310-01-329-3928	176	32
64678	17-10320-001		5365-01-329-4041	205	10
64678	17-10401-000		5340-01-329-3980	206	9
64678	17-10401-001		5340-01-329-4094	206	13
64678	17-10407-000		5340-01-336-6758	205	19
64678	17-10407-001		5340-01-336-6759	205	19
64678	17-10417-002			205	18
64678	17-10425-002		5340-01-329-3863	176	33
				208	12
64678	17-10460-000		5340-01-329-4009	207	2
64678	17-10465-000		5340-01-329-4095	206	5
64678	17-10465-001		5340-01-329-4096	206	2
64678	17-12002-000		5340-01-329-3892	207	1
64678	17-12006-000		5340-01-334-0466	208	6
64678	17-12036-000		5340-01-329-3982	207	4
64678	17-12036-001		5340-01-329-3983	207	4
64678	17-12053-000		2510-01-332-1356	205	11
64678	17-12062-000		5340-01-329-3891	206	3
64678	17-12069-000		5360-01-329-3756	208	7
64678	17-12076-000		3460-01-332-2798	205	3
64678	17-12080-000		5340-01-329-3981	208	8
64678	17-12134-000		5640-01-348-9745	207	11
64678	17-12134-001		5640-01-348-9746	207	10
64678	17-12135-000		5340-01-332-1538	207	18
64678	17-12136-000		5340-01-330-6876	207	17
64678	17-12434-000		2590-01-428-2988	205	4

CROSS-REFERENCE INDEXES

CAGEC	PART NUMBER	PART NUMBER INDEX		FIG.	ITEM
			STOCK NUMBER		
64678	17-12435-000		2540-01-428-2983	205	6
64678	17-12435-001		2540-01-428-2985	205	6
64678	17-13019-000			208	28
64678	17-13020-000		2510-01-481-3545	208	29
31223	17W12580		5310-01-332-3254	46	4
				47	2
				201	73
				207	8
80201	1711		2530-01-424-0396	164	7
57733	171105		5310-01-125-1137	89	3
26501	1725		2590-01-246-4298	226	18
75418	173119		2540-01-442-4550	233	28
11873	17425-4E09F3		5925-01-336-1734	74	13
87823	1749-1121			150	49
24161	17513		3030-01-435-7194	54	36
45225	1764		4940-01-386-6108	263	3
64678	18-09723-000			204	8
64678	18-11197-001X10			216	4
64678	18-14569-001		5360-01-345-5143	203	16
64678	18-15174-008		5310-01-326-7480	197	2
64678	18-17247-000		2540-01-422-7763	203	64
64678	18-17247-001		2540-01-422-7773	203	64
64678	18-17268-000		5340-01-336-6809	201	1
64678	18-17409-000		2540-01-346-9851	203	57
64678	18-17450-001		2510-01-337-2115	214	8
64678	18-17733-000			199	9
64678	18-17849-000		5365-01-336-6450	201	75
				227	23
64678	18-17849-001		5365-01-336-7657	227	3
64678	18-17849-002		5365-01-336-6451	227	2
64678	18-17951-000			198	4
64678	18-17963-000		2540-01-345-5966	203	28
64678	18-17997-002		3040-01-346-3237	203	30
64678	18-17997-003		3040-01-346-3240	203	30
64678	18-17999-000		3040-01-346-3239	203	29
64678	18-18239-000		5365-01-345-2513	203	54
64678	18-18372-000		5365-01-336-6449	201	58
64678	18-18586-003		2540-01-337-8845	201	62
64678	18-18954-000		5340-01-345-5534	201	60
64678	18-18955-0		5340-01-347-5917	201	57
64678	18-19193-000		5315-01-422-4331	203	63
64678	18-19420-000		2510-01-337-0232	230	30
64678	18-19557-0		5340-01-345-6569	203	12
64678	18-19790-000			215	7
64678	18-20141-000		5310-01-329-3929	207	13
64678	18-2133-000			201	35
64678	18-21756-000			200	4
64678	18-22127-006			201	14
64678	18-22457-001		5340-01-336-7827	201	9
64678	18-23408-003		5340-01-336-7697	201	66
64678	18-23504-000		3040-01-346-3238	203	31

CROSS-REFERENCE INDEXES

CAGEC	PART NUMBER	PART NUMBER INDEX		FIG.	ITEM
			STOCK NUMBER		
64678	18-23504-001		3040-01-346-3241	203	31
64678	18-23529-003		2510-01-337-2114	214	14
64678	18-23530-001		9390-01-338-5872	214	15
64678	18-23531-000		5342-01-344-3727	214	16
64678	18-23534-001		5340-01-336-4022	199	16
64678	18-23794-000			145	16
64678	18-23837-003			199	12
64678	18-24027-009			201	33
64678	18-24095-000			199	14
64678	18-24095-001			199	17
64678	18-24220-000		5340-01-345-5533	203	48
64678	18-24266-003		5340-01-336-5970	201	78
64678	18-24267-003		5340-01-337-9995	201	71
64678	18-24268-001		5340-01-337-9020	201	87
64678	18-24417-001			203	43
				203	51
64678	18-24502-000		5340-01-336-6442	201	96
64678	18-24578-000		5340-01-336-6547	201	93
64678	18-24685-000		5365-01-336-7656	72	5
64678	18-25178-000			198	11
64678	18-25509-000		2540-01-338-1710	198	6
64678	18-25612-000			198	8
64678	18-25612-001			198	13
64678	18-25627-000		2510-01-337-4143	198	5
64678	18-25628-000		2510-01-337-4144	198	14
64678	18-25631-002		5340-01-410-6637	201	7
64678	18-25652-000			198	16
64678	18-25653-000			198	15
64678	18-25656-000			215	3
64678	18-25657-000		5640-01-349-5289	198	2
64678	18-25662-000		2540-01-481-3593	215	2
64678	18-25731-002		5340-01-329-3984	205	20
64678	18-25731-003		5340-01-328-4372	205	20
64678	18-25772-000		2510-01-481-3575	214	10
64678	18-25956-000		5365-01-348-2443	203	24
64678	18-26028-000			168	5
64678	18-26054-000			201	65
64678	18-26068-001		5340-01-336-5971	201	69
64678	18-26082-000		5340-01-336-5955	201	40
64678	18-26135-000		5340-01-337-0399	204	3
64678	18-26136-000		5340-01-350-7062	203	62
64678	18-26181-000			204	7
64678	18-26331-000			201	85
64678	18-26758-006			201	38
64678	18-26759-000			201	30
64678	18-26875-000			201	67
64678	18-27087-001			215	5
64678	18-27088-001			215	8
64678	18-27217-000		2510-01-365-8975	203	4
64678	18-27307-000			201	97
64678	18-27330-000		5365-00-480-6974	203	61

CROSS-REFERENCE INDEXES

CAGEC	PART NUMBER	PART NUMBER INDEX		FIG.	ITEM
			STOCK NUMBER		
64678	18-27366-000			201	64
64678	18-27525-000			201	89
64678	18-27690-000			200	8
64678	18-27692-000			200	6
64678	18-27742-000		2540-01-365-7155	203	11
64678	18-27742-001		2540-01-365-7156	203	11
64678	18-27779-000		2540-01-366-5112	203	7
64678	18-27779-001		2590-01-367-7601	203	7
64678	18-27780-000		2540-01-366-5254	203	6
64678	18-27780-001		2590-01-368-3478	203	6
64678	18-28020-000			200	1
64678	18-28020-001			200	1
64678	18-28199-000		5310-01-365-0234	203	58
64678	18-28345-000			199	15
64678	18-29297-000			214	9
64678	18-30008-000			201	36
64678	18-32853-000			106	4
64678	18-34573-000			253	7
64678	18-38936-000			253	5
72582	181333		5306-00-021-2544	27	24
77060	1839906		5940-00-842-5353	66	23
				67	8
				71	20
				93	18
				94	4
				101	5
				103	11
				103	32
				108	4
				117	9
				255	20
15434	186917			41	4
08108	1895		6240-00-946-9654	71	18
75755	19M8029		5305-01-329-7038	129	1
78500	19X1116			146	25
78500	19X127		5315-01-315-3614	146	26
68505	19X3439		5310-00-020-4787	60	1
19738	1901-0810		5305-01-298-7333	44	1
				198	9
				199	2
				201	42
				203	2
				205	15
11873	19115-01M		5925-01-347-9837	75	2
83298	19128		5310-00-442-0966	60	18
15434	191772		5306-00-483-8833	158	27
08108	193		6240-00-069-2640	82	3
62607	194		6240-00-944-1264	111	2
62380	19562C		2990-01-475-3969	240	27
78528	1961A		5342-01-333-5425	36	14
19738	1981-0800		3120-01-298-7357	42	3

CROSS-REFERENCE INDEXES

CAGEC	PART NUMBER	PART NUMBER INDEX		FIG.	ITEM
			STOCK NUMBER		
19738	1981-0800		3120-01-298-7357	44	21
				198	7
				199	1
				201	41
				203	9
				205	16
62380	199 37B			241	16
02697	2-013C557-70		5331-00-352-0327	249	10
02697	2-015C873-70		5330-01-235-8331	249	11
				250	2
1ET49	2C447622		5310-01-330-6354	169	8
78500	2KSR2024707QP			KITS	
64678	2PB51		3030-01-332-1351	56	10
06853	201499		9905-00-774-4284	156	33
06853	202981		5310-00-087-0306	159	37
06853	203198		5305-00-465-7854	159	38
15434	204163S			55	3
45225	204266		5120-01-357-4583	264	10
55156	20430			58	4
47457	20510093-20Z		5325-01-265-7251	173	3
47457	20510093-25Z		5330-01-271-9544	KITS	
47457	20510093-4Z		5330-01-271-9407	173	22
01276	2062-8-10S		4730-01-088-4453	174	14
00779	206322-1		5935-01-030-5090	115	15
45225	206457		5120-01-357-0740	263	6
45225	206459		5120-01-357-0741	263	5
93061	207P-2		4730-00-287-1614	48	19
70334	20723		4730-00-254-6225	22	5
62380	208 17B			241	18
93061	209P-12-8		4730-00-278-3167	240	31
93061	209P-6-4		4730-00-202-6491	87	2
93061	209P-8-6		4730-01-459-0000	153	28
64678	21-26182-010			176	1
64678	21-26182-020			176	1
64678	21-26184-000			208	16
64678	210101 012001		5306-01-476-1458	54	37
75078	21183			26	28
75078	21184			26	27
02768	212-180602-13			79	12
62380	21295A		5340-01-475-3622	241	8
06853	213630		5330-00-090-2128	154	25
				154	28
				155	42
				155	47
				156	31
				156	36
77640	213684		3110-00-100-6152	172	54
93061	215PNL-6-15		4730-00-071-3175	155	77
93061	216P-6-4		4730-00-289-0232	155	49
93061	216P8		4730-00-595-3108	160	23
10966	216806 004		2540-01-478-9089	69	2

CROSS-REFERENCE INDEXES

CAGEC	PART NUMBER	PART NUMBER INDEX		FIG.	ITEM
			STOCK NUMBER		
10966	217131 001			69	3
93061	219P-4		4730-01-245-6995	156	1
93061	219P4		4730-01-245-6995	155	45
61649	219353		5310-01-092-5011	205	13
64678	22-16975-005		5905-01-331-4103	89	1
64678	22-20576-001			230	3
64678	22-20981-004			202	4
64678	22-21148-000		6695-01-333-6750	68	13
				69	5
64678	22-21952-063			234	12
64678	22-23372-001		5355-01-478-8725	68	7
				225	5
				231	21
64678	22-24618-001			243	11
64678	22-24648-000		5340-01-336-4248	216	10
64678	22-25294-001		5330-01-356-5086	BULK	34
64678	22-25294-005		5330-01-406-2130	203	14
64678	22-25773-012			91	51
64678	22-27156-000		5330-01-355-7002	89	8
64678	22-28607-010			55	7
64678	22-28607-018			234	4
64678	22-28607-061			55	10
64678	22-28696-000		2510-01-337-2116	214	2
64678	22-28965-00		5330-01-336-5360	230	11
64678	22-28966-000		5340-01-336-4025	230	14
64678	22-28974-000		2510-01-337-0246	214	10
64678	22-29913-000			232	2
64678	22-30530-000			232	1
64678	22-30549-000		4720-01-336-9719	230	24
64678	22-30934-000			83	4
64678	22-32394-000		5340-01-332-6588	210	6
64678	22-32466-001		4130-01-441-9145	250	3
64678	22-32514-001		5340-01-337-0380	182	4
64678	22-32515-000		5340-01-336-3936	182	22
64678	22-32516-000		5340-01-336-3934	212	13
64678	22-32551-000		5340-01-338-2877	182	18
64678	22-32552-000		5340-01-336-6918	182	19
64678	22-32610-000			250	8
64678	22-32640-000		5340-01-336-7992	182	3
64678	22-32642-000		2540-01-339-0554	182	2
64678	22-33178-010		2540-01-337-4416	183	10
64678	22-33178-011		2540-01-338-4621	183	10
64678	22-33267-000		5340-01-339-4331	212	1
64678	22-33726-000		2510-01-337-4121	212	11
64678	22-33726-001		2510-01-337-4122	212	8
64678	22-33741-000		2540-01-337-4098	230	18
64678	22-34443-000		4520-01-337-0207	230	27
64678	22-34781-000		5340-01-337-6577	229	6
64678	22-34805-001		2510-01-442-5470	201	6
64678	22-34806-001		2510-01-442-9289	201	4
64678	22-34916-001			201	16

CROSS-REFERENCE INDEXES

CAGEC	PART NUMBER	PART NUMBER INDEX		FIG.	ITEM
			STOCK NUMBER		
64678	22-35017-001			201	23
64678	22-35018-000		2510-01-365-7135	201	20
64678	22-35222-000		5340-01-336-6914	222	16
64678	22-35222-001		5340-01-338-3189	222	12
64678	22-35299-000		5340-01-336-0120	210	12
64678	22-35299-001		5340-01-332-6585	210	17
64678	22-35632-000		5340-01-336-6911	204	12
64678	22-35633-000		5340-01-336-9041	204	9
64678	22-35842-000		5340-01-337-9231	222	3
64678	22-35920-000		5340-01-332-6584	210	9
64678	22-35920-001		5340-01-334-1362	210	10
64678	22-38270-000		2510-01-481-3584	229	12
64678	22-39473-002			71	7
64678	22-40896-000		2590-01-442-5038	231	27
64678	22-43373-007			201	5
64678	22-43540-000			179	3
64678	22-44545-000			250	9
64678	22-46220-000			199	13
64678	22-46774-000			249	7
64678	22-49591-002			201	8
93061	2202P-6-6		4730-00-278-4822	152	8
78500	2203-B-9804			144	5
78500	2203-C-8115..			144	5
78500	2203-D-8116..			144	5
78500	2203-D-9806			142	37
78500	2203-E-8117..			144	5
78500	2203-E-9807			142	37
78500	2203-F-2788		5365-01-083-9531	142	58
78500	2203-F-9808			142	37
78500	2203-G-2789		5365-01-083-9532	142	58
78500	2203-G-9809			142	37
78500	2203-H-2790		5365-01-083-9533	142	58
78500	2203-H-9810			142	37
78500	2203-J-9474			144	6
78500	2203-J-9812			142	37
78500	2203-K-3001		5365-01-107-9291	138	5
78500	2203-K-9241		5365-01-326-7524	142	44
78500	2203-K-9475			144	6
78500	2203-K-9813			142	37
78500	2203-L-3002			138	4
78500	2203-L-9242		5365-01-330-6369	142	44
78500	2203-L-9476			144	6
78500	2203-L-9814			142	37
78500	2203-M-9243		5365-01-330-6370	142	44
78500	2203-M-9477			144	6
78500	2203-M-9815			142	37
78500	2203-N-9478			144	6
78500	2203-N-9816			142	37
78500	2203-P-9480			144	6
78500	2203-P-9818			142	37
78500	2203-Q-9481			144	6

CROSS-REFERENCE INDEXES

CAGEC	PART NUMBER	PART NUMBER INDEX		FIG.	ITEM
			STOCK NUMBER		
78500	2203-Q-9819			142	37
78500	2203-R-9482			144	6
78500	2203-R-9820			142	37
78500	2203-S-9483			144	6
78500	2203-S-9821			142	37
78500	2203-T-9484			144	6
78500	2203-T-9822			142	37
78500	2203-U-9485			144	6
78500	2203-U-9823			142	37
78500	2203-W-9175			144	5
78500	2203-X-9176			144	5
78500	2203-Y-9177			144	5
78500	2203-Z-9178			144	5
14892	220635		2530-00-137-9235	154	26
				156	32
79780	2208X440		5330-00-580-6567	140	11
				141	8
78500	2210-A-7645		2530-01-478-7622	147	2
78500	2210-K-7603		2530-01-479-0826	147	2
78500	2210-L-7604		2530-01-479-0550	147	2
78500	2210-Z-7644		2530-01-478-7619	147	2
78500	2210M7449		2530-01-479-0545	146	2
78500	2210N7450		2530-01-479-0541	146	2
78500	2214-C-1095		5365-01-330-2145	142	17
				144	11
64678	221822 010000			37	2
93061	2225P-4		4730-00-277-9615	150	14
				153	33
93061	2225P-6		4730-00-469-7797	155	27
93061	2225P-8		4730-01-095-2034	156	53
93061	2225P6		4730-00-469-7797	154	46
78528	223-455		4820-01-333-0732	153	27
11873	22315-000		5925-01-478-5959	74	4
78500	2234-R-1188		3020-01-330-0676	142	16
72582	2236474			30	8
93907	224-60610		5305-01-333-2822	79	7
				203	27
				226	9
78500	2244-K-1025		3040-01-330-0646	142	30
35871	225-40		4730-00-241-7651	32	2
35510	225022		5365-01-336-6774	60	69
35510	225087		6150-01-333-9318	60	3
35510	225265		3040-01-332-1633	60	27
35510	225266		5315-01-331-9241	60	31
78500	2257C1173		5315-01-364-3744	146	23
78500	2257D1174		5315-01-478-7697	146	24
78500	2258-H-1230			147	6
78500	2258-W-803			147	18
78500	2258-Z-1118		5360-01-325-5795	142	40
78500	2258H1230			146	20
78500	2258L1234			146	19

CROSS-REFERENCE INDEXES

CAGEC	PART NUMBER	PART NUMBER INDEX		FIG.	ITEM
			STOCK NUMBER		
78500	2258U411		5360-00-494-2165	142	31
76700	22867-A		2990-01-330-0004	41	15
78500	2297-E-5335		5325-01-325-7222	142	15
78500	2297-U-5273		4820-01-325-4657	142	41
78500	2297-Z-5278		4730-01-325-3762	142	62
3E158	2297T4752			138	11
78500	2297T7222			146	16
64678	23-00461-005		5310-01-478-8953	193	6
64678	23-00461-006		5310-01-478-8946	193	24
64678	23-00461-007		5310-01-343-1030	192	9
64678	23-00600-075			194	2
81834	23-0104-02			80	12
81834	23-0106-06			80	14
81834	23-0133-36			80	9
81834	23-0133-38		5305-01-358-6668	79	18
81834	23-0136-11		5305-01-359-8904	79	6
81834	23-0171-02			80	15
81834	23-0172-02			80	11
64678	23-09021-009			120	4
64678	23-09033-000		5360-01-357-0838	227	9
64678	23-09093-004			49	27
64678	23-09114-000		5310-01-305-2539	193	36
				195	8
				196	5
64678	23-09114-001		5310-01-438-2370	247	5
64678	23-09114-002			208	26
64678	23-09114-007		5310-01-333-4538	187	8
				222	28
64678	23-09114-008		5310-01-336-7579	135	23
				176	10
				181	2
64678	23-09114-009		5310-01-329-7043	192	22
64678	23-09114-013		5310-01-478-8671	193	19
64678	23-09114-014			185	3
64678	23-09114-017		5310-01-478-8675	193	14
64678	23-09130-000		5340-01-328-4367	37	9
				49	34
				91	21
				153	6
				154	34
				155	6
				163	5
				240	23
64678	23-09130-001		5340-01-333-8889	56	16
				91	19
64678	23-09130-002		5340-01-328-4371	91	18
				152	28
				163	7
				240	8
64678	23-09130-003		5365-01-245-8802	15	5
				135	6

CROSS-REFERENCE INDEXES

CAGEC	PART NUMBER	PART NUMBER INDEX		FIG.	ITEM
			STOCK NUMBER		
64678	23-09130-003		5365-01-245-8802	152	32
				226	21
64678	23-09130-007			37	8
64678	23-09130-008		5340-01-336-3269	71	3
64678	23-09130-012			37	11
64678	23-09130-013		5340-01-345-4647	49	16
64678	23-09130-015			249	18
64678	23-09130-024			135	4
64678	23-09130-028			37	3
64678	23-09130-034			135	25
64678	23-09200-005		4730-01-332-5998	36	15
64678	23-09215-006		4730-01-332-2428	15	19
64678	23-09219-014		4730-01-440-9431	48	20
64678	23-09219-021		4730-01-332-5941	31	17
64678	23-09247-104		5310-01-088-2825	88	8
64678	23-09247-210		5310-01-357-0821	140	9
				141	10
64678	23-09254-003			208	30
64678	23-09254-008			150	11
				151	23
64678	23-09271-238			192	10
64678	23-09271-262		3120-01-481-3166	192	10
64678	23-09277-049			225	22
64678	23-09291-388			160	8
64678	23-09330-171		5365-01-332-1521	208	1
64678	23-09331-050		5365-01-332-0913	44	24
64678	23-09331-100			135	17
64678	23-09336-005		5310-01-329-4045	59	4
				68	39
				92	20
				201	19
				205	1
64678	23-09337-105		5310-01-336-5344	71	4
64678	23-09337-113		5310-01-478-9022	194	1
64678	23-09339-009			91	45
64678	23-09339-513			185	7
64678	23-09340-001		4730-01-329-2139	174	1
64678	23-09340-003			234	11
64678	23-09426-203			201	12
				233	35
64678	23-09426-401			168	10
64678	23-09427-025			201	76
64678	23-09436-125		5305-01-246-0609	221	13
64678	23-09440-650		5305-01-332-7228	56	12
64678	23-09440-800		5305-01-336-6838	177	10
64678	23-09444-675		5305-01-479-0553	196	10
64678	23-09457-005		5325-01-443-9525	231	28
64678	23-09462-225			201	77
64678	23-09528-076		5340-01-439-0816	135	28
64678	23-09528-086			152	29
64678	23-09596-050			91	22

CROSS-REFERENCE INDEXES

CAGEC	PART NUMBER	PART NUMBER INDEX		FIG.	ITEM
			STOCK NUMBER		
64678	23-09614-375		5305-01-338-7295	176	27
64678	23-09744-100		5305-01-328-4386	45	18
64678	23-09744-150		5305-01-328-4387	45	15
64678	23-09796-309		5975-01-338-9190	225	32
64678	23-09796-409			251	3
64678	23-09900-104		5310-01-357-0854	37	4
				120	8
				201	86
				203	44
				223	1
				225	10
64678	23-09901-104			240	6
64678	23-09901-105			240	21
64678	23-09901-108		5310-01-319-2127	121	7
				135	15
64678	23-09901-110		5310-01-478-9028	193	35
				195	9
				196	11
64678	23-09901-114		5310-01-329-3700	171	2
				176	7
				176	42
64678	23-09901-116		5310-01-336-9850	135	22
				176	11
				181	12
64678	23-09901-206			208	27
64678	23-09901-214			196	17
64678	23-09982-031			221	14
64678	23-09983-025		5310-01-357-0878	145	18
				227	12
				227	17
64678	23-10035-100		5305-01-336-7550	215	6
				216	8
64678	23-10056-704			230	28
64678	23-10056-705			106	5
64678	23-10094-038		5305-01-441-3307	230	7
64678	23-10330-704		5305-01-345-6582	203	56
64678	23-10340-108		5310-01-126-3664	80	19
64678	23-10340-125		5310-01-333-6436	80	1
				92	21
				102	1
				151	19
				151	29
				152	30
64678	23-10340-131		5310-01-329-3697	46	1
64678	23-10340-138		5310-01-478-9004	46	6
64678	23-10406-025		5305-01-346-2284	201	56
64678	23-10410-062		5305-01-336-6598	231	26
64678	23-10410-704		5305-01-337-5637	106	1
				107	3
64678	23-10410-706		5305-01-336-9151	71	1
64678	23-10410-712		5305-01-336-6595	68	36

CROSS-REFERENCE INDEXES

CAGEC	PART NUMBER	PART NUMBER INDEX		FIG.	ITEM
			STOCK NUMBER		
64678	23-10410-712		5305-01-336-6595	201	17
64678	23-10411-710			69	4
64678	23-10414-125		5305-01-364-4778	150	17
64678	23-10414-150		5305-01-336-7014	224	2
64678	23-10414-706			68	41
				115	1
64678	23-10570-050		5305-01-345-6545	203	8
				203	35
64678	23-10574-275		5305-01-332-7226	163	14
64678	23-10673-075		5305-01-336-7551	229	14
				230	26
				232	3
64678	23-10673-100			115	3
64678	23-10742-062			145	17
64678	23-10744-350		5305-01-346-3694	91	36
				156	17
64678	23-10744-450			168	6
64678	23-10745-050		5305-01-411-3449	81	6
64678	23-10748-125			91	41
64678	23-10891-075		5305-01-337-3804	199	7
64678	23-10891-704		5305-01-340-9857	226	7
64678	23-10891-794			203	13
64678	23-10899-075		5305-01-337-3805	83	1
				203	37
64678	23-10899-125		5305-01-364-4803	203	33
64678	23-10899-706			201	68
64678	23-10900-010		5310-01-478-8676	79	20
64678	23-10900-025			225	29
				251	5
64678	23-11005-125		5305-01-329-4004	205	12
64678	23-11007-125		5306-01-478-8505	55	1
				193	2
64678	23-11007-200		5306-01-476-1456	35	9
64678	23-11011-350		5306-01-336-6829	181	9
64678	23-11033-100			225	27
64678	23-11036-810		5305-01-298-7333	31	8
				42	11
64678	23-11037-800		3120-01-298-7357	31	12
64678	23-11052-101			227	19
64678	23-11160-025		5305-01-355-5504	89	6
64678	23-11160-088		5305-01-336-6596	201	54
64678	23-11160-706			201	31
64678	23-11164-125		5305-01-336-6597	201	82
64678	23-11164-704			118	5
				201	90
64678	23-11164-710			118	7
				201	13
				201	70
64678	23-11164-720			72	3
64678	23-11164-724			201	99
64678	23-11177-075		5305-01-444-0594	249	16

CROSS-REFERENCE INDEXES

CAGEC	PART NUMBER	PART NUMBER INDEX		FIG.	ITEM
			STOCK NUMBER		
64678	23-11185-000		5325-01-334-4808	82	8
				227	20
64678	23-11226-706			202	5
64678	23-11344-088		5305-01-365-0343	201	3
64678	23-11345-707			201	37
				253	3
64678	23-11345-710		5305-01-336-6830	201	11
				230	23
64678	23-11352-428		5306-01-329-3835	208	14
64678	23-11358-024		5340-01-339-4266	76	4
				91	14
				152	31
				249	20
64678	23-11358-035		5340-01-474-9800	55	9
64678	23-11358-039		5340-01-441-1668	154	30
64678	23-11358-040		5340-01-336-7794	102	7
64678	23-11377-028			145	28
64678	23-11427-050		5365-01-439-2357	56	6
64678	23-11488-110		5310-01-478-9014	79	19
64678	23-11529-275			227	1
64678	23-11551-844		5340-01-479-0560	49	25
64678	23-11553-138		5310-01-357-0819	227	8
64678	23-11553-225		5310-01-357-0820	227	11
				227	18
64678	23-11599-002			228	4
64678	23-11600-102			179	2
64678	23-11609-100		5305-01-336-6238	79	4
64678	23-11609-714			79	22
64678	23-11610-710			82	5
64678	23-11613-706			251	10
64678	23-11613-710			251	7
64678	23-11623-710			79	24
64678	23-11632-000		5307-01-336-7673	201	25
64678	23-11657-305		5305-01-336-9466	75	4
				200	3
				215	1
				225	25
				230	19
64678	23-11657-306		5305-01-336-9467	202	2
64678	23-11657-308		5305-01-338-7313	202	2
64678	23-11668-000		5310-01-338-4116	201	2
				203	38
				230	25
64678	23-11681-075			228	5
64678	23-11683-150			229	8
64678	23-11685-050		5305-01-329-3857	207	3
64678	23-11688-022			145	10
64678	23-11689-005			227	22
64678	23-11689-008			201	34
64678	23-11709-100			160	12
64678	23-11710-038			196	7

CROSS-REFERENCE INDEXES

CAGEC	PART NUMBER	PART NUMBER INDEX		FIG.	ITEM
			STOCK NUMBER		
64678	23-11710-040			193	39
64678	23-11710-150			196	6
64678	23-11812-012		5310-01-337-0370	177	17
64678	23-11829-075		5305-01-329-3969	207	9
64678	23-11860-000		5310-01-346-1594	203	41
				203	53
64678	23-11865-000		5310-01-337-2353	201	27
				230	21
				253	4
64678	23-12008-125		5305-01-337-4267	176	45
64678	23-12020-062		5305-01-328-4357	145	21
64678	23-12022-075		5305-01-441-8719	145	26
				230	20
80205	23-12027-130			58	3
64678	23-12036-012		5305-01-336-7543	214	5
64678	23-12062-000		5365-01-446-3725	36	4
64678	23-12063-000		5310-01-474-8453	36	7
64678	23-12067-062		5305-01-444-0597	70	5
				70	7
64678	23-12096-125			221	9
64678	23-12099-306			252	8
64678	23-12114-000		5325-01-481-3600	200	2
64678	23-12139-006		5315-01-481-3615	185	13
64678	23-12195-075		5305-01-441-9376	59	2
				150	36
				231	19
64678	23-12231-003			37	10
64678	23-12231-004			37	6
64678	23-12231-108			135	30
64678	23-12237-075		5305-01-479-0300	49	15
64678	23-12301-000		9330-01-479-3259	217	2
64678	23-12501-000			206	4
64678	23-12567-100		5305-01-479-0499	193	15
64678	23-12576-125		5305-01-479-0308	193	18
64678	23-12661-000			208	25
64678	23-9277-049		5310-01-356-6158	61	3
64678	23-9426-203		5310-01-354-5785	82	21
64678	23-9890-100		5306-01-337-0351	92	18
70485	23W		5340-00-272-3560	145	25
73342	23014057		5331-01-360-6016	134	36
73342	23016455		5331-01-475-8687	134	35
73342	23019664		5331-01-361-0235	134	93
73342	23043446		5331-01-424-6629	134	95
72582	23045507		3040-01-306-2646	9	3
73342	23045615		5330-01-360-9103	129	21
73342	23046274		5331-01-360-6018	129	3
73342	23046354		5315-01-360-5914	134	90
73342	23046376		5330-01-360-6006	134	25
73342	23046428		2815-01-161-6540	9	1
73342	23047102		2520-01-388-4778	124	11
73342	23047920			128	5

CROSS-REFERENCE INDEXES

CAGEC	PART NUMBER	PART NUMBER INDEX		FIG.	ITEM
			STOCK NUMBER		
73342	23047945			124	7
73342	23048037		5330-01-360-7520	124	14
73342	23048038		5340-01-360-1048	124	13
73342	23048095		5330-01-478-7291	129	14
73342	23048096		5330-01-478-7292	129	15
73342	23048098		5330-01-478-7293	129	16
73342	23048104		5331-01-478-7295	129	25
73342	23048105			129	26
73342	23048131			129	13
73342	23048164		5331-01-478-7281	128	6
73342	23049312		4820-01-361-1924	134	65
73342	23049315		4820-01-360-2355	134	59
73342	23049316		4820-01-360-6160	134	64
73342	23049318		4820-01-360-6162	134	82
73342	23049320		4820-01-360-6161	134	81
73342	23049321		4820-01-360-2354	134	47
73342	23049325		5360-01-359-7949	134	69
73342	23049326		5360-01-359-7946	134	60
73342	23049327		5360-01-359-7947	134	63
73342	23049332		5360-01-359-7945	134	46
73342	23049337		5340-01-359-8850	134	61
73342	23049338		5340-01-359-8851	134	62
73342	23049340		5340-01-359-8854	134	84
73342	23049341		5340-01-359-9416	134	78
73342	23049342		5340-01-360-1075	134	79
73342	23049343		5340-01-359-8849	134	45
73342	23049345		5340-01-360-5983	134	57
73342	23049372		5315-01-360-4771	134	44
73342	23049391		5360-01-359-7951	134	80
73342	23049409			129	20
64678	2309114000		5310-01-305-2539	121	2
06853	230935		4820-00-426-8386	162	17
35510	2313		5310-01-106-9929	57	16
				60	66
78500	2317		5340-01-367-7087	KITS	
18179	2318BC-FRL12		5999-01-363-6922	59	8
72582	23500708			13	1
72582	23501572		5330-01-318-1949	7	21
				KITS	
72582	23501576		2815-01-318-8471	12	1
72582	23501580		2910-01-318-5439	6	19
72582	23503510-ND		5905-01-331-6366	87	1
72582	23504088		4720-01-443-3020	14	7
72582	23504431		5365-01-321-0574	26	29
72582	23505039		4730-01-319-3469	34	23
72582	23505050		5305-01-338-0428	50	2
				161	11
72582	23505056		2815-01-319-0902	13	6
72582	23505062		5306-01-320-3940	18	19
				20	15
				27	21

CROSS-REFERENCE INDEXES

CAGEC	PART NUMBER	PART NUMBER INDEX		FIG.	ITEM
			STOCK NUMBER		
72582	23505062		5306-01-320-3940	34	13
72582	23505086			34	14
72582	23505201		4730-01-332-2389	161	4
72582	23505246		4730-01-455-3774	29	4
72582	23505248		5330-01-319-2035	29	1
72582	23505249		3010-01-320-8941	29	2
72582	23505265			87	3
72582	23505272			27	7
72582	23505273			27	11
72582	23505299			27	10
72582	23505720			16	8
72582	23505876		5340-01-342-5635	27	20
72582	23505877			20	3
72582	23505878		2995-01-334-2795	20	2
72582	23505882		3020-01-337-9277	20	11
72582	23505883			20	6
72582	23505884		3020-01-322-9945	20	13
72582	23505885		5315-01-320-3625	20	5
72582	23505886		2815-01-317-5521	20	1
72582	23505887		4710-01-323-0095	19	9
72582	23505890		4710-01-322-4975	19	2
72582	23505891		5331-01-319-5207	19	1
72582	23505892		5331-01-319-5208	19	3
72582	23505896		3040-01-323-3261	51	23
72582	23505897			51	19
72582	23505898			51	7
72582	23505899		4710-01-322-4978	51	3
72582	23505902		5330-01-334-2725	18	8
72582	23505910		3020-01-322-9234	51	20
72582	23505992		5330-01-320-7190	19	19
72582	23506222		5306-01-321-3559	6	28
				7	17
				18	15
				29	9
				30	4
				34	19
				63	13
				64	3
72582	23506247		5330-01-320-7191	18	7
72582	23506346		5310-01-321-2419	161	1
72582	23506443			14	9
72582	23507126		2590-01-356-2690	18	1
72582	23507182		5305-01-334-4468	18	22
72582	23507183		5306-01-320-3941	18	6
72582	23507337		3020-01-335-7394	20	14
72582	23507338			20	7
72582	23507422			2	2
72582	23507438ND		5307-01-359-0178	23	11
72582	23507504		2815-01-415-3248	12	1
72582	23508392			18	10
72582	23508408		5331-01-440-7531	34	30

CROSS-REFERENCE INDEXES

CAGEC	PART NUMBER	PART NUMBER INDEX		FIG.	ITEM
			STOCK NUMBER		
75282	23508739		5365-01-356-0081	20	17
72582	23508740-ND		5365-01-358-4625	20	17
72582	23508863			51	18
72582	23509105		5330-01-320-5071	KITS	
72582	23509128			KITS	
72582	23509200		3040-01-365-7779	25	1
72582	23509201		3040-01-364-4500	25	7
72582	23509202		3040-01-364-4466	25	5
72582	23509203		3110-01-363-1479	25	3
72582	23509204		5325-01-362-9783	25	4
72582	23509239			7	18
72582	23509256		5340-01-440-6000	34	16
72582	23509322			14	8
72582	23511176		6620-01-361-7595	84	3
72582	23511221		2815-01-440-5799	23	9
72582	23511222		2815-01-322-9277	23	9
72582	23511290			30	1
72582	23511356			53	2
72582	23511572		4730-01-464-2375	50	4
72582	23511573		4730-01-464-2348	6	15
				18	3
				50	3
72582	23511574		4730-01-411-7532	6	16
				9	12
				18	2
72582	23511666		5330-01-319-9227	23	6
72582	23511667		5365-01-440-5246	23	7
72582	23511786			14	10
72582	23511983			27	1
72582	23512048			51	13
72582	23512307		5342-01-414-2177	62	2
72582	23512309			62	1
72582	23512691		5330-01-318-2324	KITS	
72582	23512901		4810-01-319-3495	21	1
72582	23513197			6	11
72582	23513530			13	13
72582	23513537		3020-01-441-0433	8	7
72582	23513559		3020-01-441-0430	24	5
72582	23513683		4730-01-319-3474	18	12
72582	23513842		5310-01-395-1250	18	11
72582	23513939			13	12
72582	23514371			13	5
72582	23514442			9	11
72582	23514708		2990-01-415-2366	84	2
72582	23514711			18	14
72582	23514716			6	29
72582	23514898		2815-01-440-5796	23	12
72582	23515250		2990-01-413-1395	84	7
72582	23515353			34	21
72582	23515354			34	24
72582	23515369			161	9

CROSS-REFERENCE INDEXES

CAGEC	PART NUMBER	PART NUMBER INDEX		FIG.	ITEM
			STOCK NUMBER		
72582	23515499			10	9
72582	23515500			10	8
72582	23515598			8	2
72582	23516100			27	12
72582	23516104			7	8
72582	23516767			19	4
72582	23516961		5342-01-439-2534	247	7
72582	23516993		4820-01-481-3346	30	3
72582	23517027			51	16
72582	23517093		4730-01-440-9730	161	2
72582	23517094		4720-01-441-1677	161	17
72582	23517130			161	15
72582	23517283			13	8
72582	23517285		4720-01-440-7809	161	3
				161	18
72582	23517417			7	1
72582	23517435		2815-01-319-3579	23	5
72582	23517696		4730-01-447-3214	39	6
72582	23517706		5340-01-446-9624	39	8
72582	23517769		2910-01-447-8036	39	1
72582	23517771		2910-01-447-7956	39	3
72582	23517779		4810-01-447-4578	39	7
72582	23517781		5945-01-447-9142	39	4
72582	23517875		5330-01-411-8119	23	1
72582	23517913			51	14
72582	23518092		2990-01-337-4138	84	4
72582	23518355			27	14
72582	23518506			39	5
72582	23518563			34	32
72582	23518639			18	4
72582	23519094		5342-01-440-4428	34	31
72582	23519124			23	10
72582	23519268		4720-01-441-2384	161	6
72582	23519308			62	3
72582	23519651			8	6
72582	23519764		5340-01-319-4862	19	7
72582	23519765			13	10
72582	23519766			13	7
72582	23520013			KITS	
72582	23520014			KITS	
72582	23520377		5330-01-321-8616	51	9
72582	23520644			13	11
72582	23520929			16	4
72582	23520930			16	3
72582	23520931			16	5
72582	23521111			6	2
72582	23521125			56	15
72582	23521131		5310-01-250-7679	34	28
				53	3
				56	14
				161	19

CROSS-REFERENCE INDEXES

CAGEC	PART NUMBER	PART NUMBER INDEX		FIG.	ITEM
			STOCK NUMBER		
72582	23521132		5306-01-443-1230	56	13
72582	23521330			KITS	
72582	23521365			18	16
72582	23521375			7	20
72582	23521390			34	17
72582	23521436			KITS	
72582	23521649			10	12
72582	23521672			18	18
72582	23521781		5325-01-481-3468	10	13
72582	23521892			11	7
72582	23521894			11	5
72582	23521895			11	6
72582	23522178			64	9
72582	23522188			34	1
				34	33
72582	23522268			14	3
72582	23522269			14	12
72582	23522271			14	1
72582	23522272			14	2
72582	23522279			16	1
72582	23522281			16	7
72582	23522282			16	2
72582	23522323			63	9
72582	23522326			9	8
72582	23522327			9	7
72582	23522329			9	9
72582	23522416			18	21
72582	23522433			51	15
72582	23522436			51	10
72582	23522588			6	26
72582	23522643			9	10
72582	23522649			6	8
72582	23522713			10	6
72582	23522719			63	4
72582	23522975			6	21
72582	23523120			34	3
72582	23523174			13	4
72582	23523195			10	14
72582	23523294			6	3
72582	23523506			14	5
72582	23523809			34	35
72582	23523811			34	36
72582	23523930			12	3
72582	23523935		3120-01-481-3139	10	17
72582	23523948		2835-01-414-8485	10	2
72582	23524098			10	11
72582	23524520		4820-01-481-3343	18	9
72582	23524596			10	1
72582	23524597			10	10
72582	23524882			11	12
72582	23524883			11	10

CROSS-REFERENCE INDEXES

CAGEC	PART NUMBER	PART NUMBER INDEX		FIG.	ITEM
			STOCK NUMBER		
72582	23525553			10	5
72582	23526109		4820-01-481-3347	30	11
72582	23526131			30	16
06853	236577		5330-00-531-3197	163	17
06853	237687		5306-00-082-5161	162	3
				162	21
06853	237688		5305-01-442-9868	162	31
35510	2385		5310-00-781-4787	57	68
78500	2396		5365-01-330-7318	KITS	
06853	239668		2530-00-980-2384	159	6
06853	239943		5310-00-121-2803	159	51
64678	24-00401-000			225	35
64678	24-00407-006		6220-01-338-5780	71	8
64678	24-00407-027		6210-01-478-7219	71	12
64678	24-00442-000		6210-01-478-7235	68	8
64678	24-00613-000			104	14
				105	6
64678	24-00613-001			104	14
				105	6
64678	24-00613-002			104	16
				105	8
64678	24-00613-003			104	16
				105	8
64678	24-00646-006			235	3
64678	24-00647-006			235	7
64678	24-00655-006			235	4
64678	24-00658-001			235	5
64678	24-00662-000			237	1
64678	24-00665-003			231	23
				236	1
64678	24-00666-000			236	2
64678	24-00667-000			236	3
64678	24-00743-000			208	32
64678	24-01076-000			235	6
77326	24-405		5930-01-438-6328	68	15
				72	1
96881	24L24-F		3120-00-702-9850	145	13
D1510	2401.00.901			91	27
24161	24032		4720-00-848-1038	BULK	30
06853	240345		5340-00-738-7552	159	28
24161	24224		4720-00-421-1279	BULK	10
24161	24240		4720-01-293-9313	BULK	12
35510	2434		5310-00-775-5139	57	52
				60	19
06853	243430		5330-00-262-3272	162	46
06853	244435		5340-01-083-6420	159	21
06853	244437		5360-01-083-9766	159	22
06853	244438		5310-01-085-4523	159	25
06853	244439		2530-01-083-6343	159	23
06853	245050			159	17
06853	246432		4820-01-080-7439	162	19

CROSS-REFERENCE INDEXES

CAGEC	PART NUMBER	PART NUMBER INDEX		FIG.	ITEM
			STOCK NUMBER		
06853	247216		2530-01-127-3971	159	41
06853	247217		5360-01-124-6811	159	42
06853	247219			159	43
06853	247220			159	46
06853	247226		5331-01-126-1233	159	32
06853	247231		5360-01-125-1671	159	15
72582	2476233		5342-00-763-0482	34	25
06853	248536			159	40
98688	2486 7022			82	9
93061	249F-10-8		4730-00-613-9339	37	16
				160	33
				163	1
06853	249371		4820-01-152-0194	159	50
06853	249704			162	32
93061	2515-00155		4730-01-332-5483	150	13
				151	22
70485	2566		5325-00-276-6056	82	6
75915	257 005		5920-01-123-5212	75	3
75915	257 010		5920-01-123-5211	74	5
75915	257 015		5920-01-149-6952	74	3
76211	2575		5310-01-336-9731	201	50
78500	26X-1003			138	18
35510	26175		5310-00-429-3127	57	8
30327	269-P 1/8 X 1/8		4730-00-803-5665	231	24
93061	269HB-10-8		4730-01-106-0313	55	6
93061	269NTA-10-8		4730-01-102-4123	155	28
				158	1
				160	29
93061	269NTA-4-4		4730-01-086-4064	31	10
				150	43
				226	1
93061	270NTA-4-2		4730-01-113-1791	151	9
				226	12
70418	27035		6240-00-836-2079	82	11
58723	2749-2108		5930-01-442-1113	86	1
06853	275707		2530-00-827-5934	163	16
35510	2771		5310-00-616-1739	57	2
				57	4
19738	2771-0613		5320-01-270-2951	214	6
19738	2771-0617		5320-01-270-2952	42	1
				198	3
19738	2771-0817		5320-01-157-0908	198	10
				204	11
				210	13
				226	20
19738	2771-0824		5320-01-243-2947	204	10
				231	1
70523	27800		5325-01-350-7069	203	19
70523	27801		5325-01-350-7068	203	19
				203	32
93061	279NTA-6-2		4730-01-227-5373	163	10

CROSS-REFERENCE INDEXES

CAGEC	PART NUMBER	PART NUMBER INDEX		FIG.	ITEM
			STOCK NUMBER		
93061	279NTA-8-8		4730-01-079-3275	156	13
06853	279754		4820-01-083-6788	159	19
93061	28-8-4		4730-01-416-3262	150	19
70485	2802		5325-01-046-0769	103	33
73195	28408PG		2530-01-478-7603	166	1
06853	284143		4820-01-068-3477	156	60
24161	28430		4720-00-541-4243	BULK	11
10001	2856628		5340-01-022-7474	238	7
06853	286171		2590-01-130-6720	159	5
06853	286172			159	39
70485	2872		5325-00-174-9341	103	57
06853	287696			162	39
06853	289108			159	35
06853	289714		4820-01-095-1697	154	48
70523	28986		5365-01-345-4056	203	20
06853	290181			159	18
06853	290182		4820-01-242-4714	159	36
06853	290183		5310-01-296-0327	159	45
06853	290184		2530-01-160-9652	159	13
06853	290185		5360-01-125-1670	159	9
06853	290186		5305-01-125-0929	159	33
06853	290187		4820-01-132-0606	159	11
06853	290188		5310-01-126-8834	159	10
06853	290189		5340-01-135-4292	159	8
06853	290190			159	29
06853	290202		2530-01-122-9933	159	31
06853	292275		5305-01-084-6065	159	49
06853	292304			162	24
06853	292375		5360-01-081-8276	162	18
06853	292392		2530-01-081-3213	162	38
06853	292530		4310-01-153-8352	162	40
06853	292596			159	16
79500	293		6240-01-345-0526	68	6
06853	293337		5306-01-124-1225	159	2
06853	294569			162	11
06853	294751		4820-00-893-3216	162	16
06853	294821			162	7
73342	29500034		5365-01-359-9336	134	94
73342	29500616		5306-01-360-1970	123	34
73342	29500713			123	18
73342	29500822		5340-01-360-7812	134	56
73342	29500823		5340-01-360-5984	134	58
73342	29500963		5360-01-359-7948	134	66
73342	29501013			125	7
73342	29501024			131	1
				132	1
73342	29501034			131	2
				132	2
				133	2
73342	29501037			131	10
73342	29501053			132	12

CROSS-REFERENCE INDEXES

CAGEC	PART NUMBER	PART NUMBER INDEX		FIG.	ITEM
			STOCK NUMBER		
73342	29501066			133	8
73342	29501068			129	33
73342	29501071		5360-01-359-7950	134	77
73342	29501110			130	3
73342	29501135		5315-01-360-5913	125	10
73342	29501197			132	7
73342	29501221			129	32
73342	29501298			123	24
73342	29501299			123	25
73342	29501300			123	27
73342	29501301			123	23
73342	29501304			123	21
73342	29501318			123	17
73342	29501321			123	7
73342	29501323			123	9
73342	29501326			123	11
73342	29501327			123	12
73342	29501339			123	4
73342	29501420			124	5
73342	29501421			124	8
73342	29501426			130	9
73342	29501439		5331-01-388-1528	134	30
73342	29501485			129	10
73342	29501586			131	12
73342	29501588			132	9
73342	29501590			133	11
73342	29501593			131	3
				132	3
				133	3
73342	29502068		2940-01-360-3389	134	51
73342	29502195		5360-01-359-7944	134	39
73342	29503035			128	4
73342	29503036			128	3
73342	29503037			128	2
73342	29503208		5330-01-361-9785	123	2
73342	29503218			126	4
73342	29503219			126	4
73342	29503220			126	4
73342	29503221			126	4
73342	29503222			126	4
73342	29503223			126	4
73342	29503224			126	4
73342	29503225		3120-01-360-7544	126	5
				129	12
73342	29503263		5330-01-360-9034	134	49
73342	29503382		5331-01-360-6013	134	33
				134	73
73342	29503383		5331-01-360-6017	85	2
				85	6
				134	32
73342	29503384		5331-01-474-9719	134	72

CROSS-REFERENCE INDEXES

CAGEC	PART NUMBER	PART NUMBER INDEX		FIG.	ITEM
			STOCK NUMBER		
73342	29503547		5330-01-461-0587	127	1
73342	29503663		5340-01-359-8852	134	67
73342	29503670		4730-01-360-4458	134	50
73342	29503673		4820-01-360-9095	134	70
73342	29503674		5340-01-359-8853	134	68
73342	29503843		5340-01-360-1033	85	3
73342	29503873			123	26
73342	29503876			123	29
73342	29503877			123	30
73342	29503879			123	28
73342	29503880			123	28
73342	29503881			123	28
73342	29505572			129	8
73342	29505573		3110-01-478-7434	125	14
73342	29505574			128	7
73342	29505605		3120-01-478-7470	129	5
73342	29505607			126	2
73342	29505613			128	1
				128	10
73342	29505630			130	5
73342	29505631			131	8
73342	29505634			126	6
73342	29505681		5365-01-360-1021	129	2
73342	29505682		5365-01-360-1020	129	2
73342	29505683		5365-01-360-1019	129	2
73342	29505684		5365-01-360-1018	129	2
73342	29505685		5365-01-360-1721	129	2
73342	29505686		5365-01-360-1017	129	2
73342	29505688		5365-01-360-1022	129	2
73342	29505690			130	13
73342	29505691			130	12
73342	29505699			125	3
73342	29505714			129	36
73342	29505715			129	7
73342	29505716			129	19
73342	29505717			129	17
73342	29505719			129	18
73342	29505720			129	34
73342	29505759			129	29
73342	29505765			130	7
73342	29505771			130	14
73342	29505782			123	8
73342	29505783			123	10
73342	29505803			133	6
73342	29505823			129	35
73342	29505858		5330-01-478-7279	124	16
26095	29505859		5330-01-466-9015	124	2
73342	29505906			131	5
73342	29506051			131	9
73342	29506053			132	10
73342	29506055			133	7

CROSS-REFERENCE INDEXES

CAGEC	PART NUMBER	PART NUMBER INDEX		FIG.	ITEM
			STOCK NUMBER		
73342	29506056			133	10
73342	29506206		5325-01-478-9347	130	8
73342	29506317			132	4
73342	29506484		5930-01-360-5002	134	27
73342	29506507			127	2
73342	29506616			123	19
73342	29506620			123	16
H1934	29506622			123	22
73342	29506623			123	20
73342	29506629			123	32
73342	29506675		5331-01-478-7278	123	31
73342	29507430			134	74
73342	29507432		4820-01-360-2421	134	40
73342	29507433		4810-01-360-4433	134	48
73342	29507437		5331-01-360-7725	134	99
73342	29507450			134	55
73342	29507451		5945-01-360-5163	134	71
73342	29507453		5945-01-360-5161	134	34
73342	29507454		5945-01-360-5162	134	31
73342	29507455		5360-01-460-1139	134	42
73342	29507456		5360-01-460-1141	134	86
73342	29507457		4820-01-460-0245	134	43
73342	29507459		4820-01-461-0599	134	41
73342	29507460		4820-01-461-0598	134	76
73342	29507462		4820-01-360-4408	134	87
73342	29507464		4810-01-360-4314	134	38
73342	29507709		5360-01-453-2343	125	12
73342	29507793			129	2
73342	29507794			129	2
73342	29507795			127	3
73342	29507803			133	9
73342	29507805			132	11
73342	29507807			131	11
73342	29507815			130	2
73342	29507817			131	4
73342	29507823		5330-01-360-7826	120	6
73342	29507871			126	1
73342	29507888			121	8
73342	29509453			129	23
73342	29509637		6695-01-361-6056	85	1
73342	29509723		2910-01-431-1324	134	100
73342	29510309			120	7
73342	29510823			122	1
73342	29511368			134	3
73342	29511369			134	6
73342	29511371			134	4
73342	29511429		5325-01-478-9348	128	11
73342	29511431			133	4
73342	29511436			123	15
73342	29511444		5331-01-466-9013	128	14
73342	29511448			124	3

CROSS-REFERENCE INDEXES

CAGEC	PART NUMBER	PART NUMBER INDEX		FIG.	ITEM
			STOCK NUMBER		
73342	29511450			128	12
73342	29511461			129	31
73342	29511462			129	28
73342	29511508			85	7
73342	29511647		5315-01-360-6729	134	37
73342	29511834			120	5
73342	29511880			122	4
73342	29512201		2520-01-479-0012	85	5
73342	29512739			125	9
73342	29512875		5331-01-478-7287	128	15
73342	29513004			122	3
73342	29513005			122	5
				122	6
73342	29513006			122	8
73342	29513007			122	10
73342	29513725			122	12
73342	29514029			122	11
73342	29514041		5935-01-459-9908	134	8
73342	29514042		5935-01-459-9848	134	7
73342	29514043		5935-01-459-9907	134	5
73342	29514114			130	11
73342	29514154			123	5
73342	29514677			123	13
73342	29514683			123	14
73342	29514684			131	7
73342	29514686			132	5
73342	29514709			124	9
73342	29514723			123	33
73342	29515393			134	23
73342	29515628			130	10
73342	29515650			124	10
73342	29515664			128	9
73342	29515688			125	5
73342	29515691			128	13
73342	29516030		5315-01-453-6936	125	13
73342	29516328			134	12
73342	29516329		5340-01-478-4881	134	54
73342	29516330			134	53
73342	29516490			125	8
73342	29516499			129	4
73342	29518438			124	6
73342	29518439		5330-01-478-7289	129	6
73342	29518440			125	15
73342	29520396		5330-01-461-0588	134	10
73342	29524006			134	11
73342	29524122			124	15
73342	29524398			134	88
73342	29524445			134	91
73342	29524447		5340-01-443-0317	134	96
73342	29524448		5331-01-439-6677	134	98
73342	29524449		5330-01-440-8651	134	97

CROSS-REFERENCE INDEXES

CAGEC	PART NUMBER	PART NUMBER INDEX		FIG.	ITEM
			STOCK NUMBER		
73342	29527000			134	1
73342	29527102			125	6
73342	29529291			130	6
73342	29529430		2520-01-459-1944	118	1
73342	29529973			134	13
73342	29530531		5330-01-478-7298	134	89
73342	29533656		2520-01-479-0244	134	2
73342	29534355		5330-01-478-7285	128	8
73342	29534362		5365-01-360-0937	134	92
73342	29534503			129	11
73342	29534504			129	9
73342	29534572			129	30
73342	29534573			129	27
73342	29534576			129	24
73342	29534577			129	22
73342	29534834			130	15
73342	29534835			132	8
73342	29535215			128	16
73342	29535219			128	17
73342	29535224			133	5
73342	29535235			133	1
73342	29535575		5305-01-475-4853	134	26
73342	29535581			123	1
73342	29535584			123	3
73342	29535596			123	6
73342	29535630			126	3
73342	29535946			134	85
73342	29535956		3120-01-478-7481	131	6
73342	29535957		3120-01-478-7477	132	6
73342	29537060			124	4
77060	2962064		5940-01-336-5777	65	3
77060	2962987		5940-00-956-3517	68	24
				93	2
				94	8
				103	61
				113	5
77060	2965019			93	7
77060	2965141		5940-01-337-4910	68	3
				69	11
				101	29
77060	2965142		5940-00-788-1586	68	28
				71	21
				82	22
				93	15
				94	3
				99	7
				103	56
				103	63
				255	42
77060	2965143		5940-01-336-6326	68	19
				93	5

CROSS-REFERENCE INDEXES

CAGEC	PART NUMBER	PART NUMBER INDEX		FIG.	ITEM
			STOCK NUMBER		
77060	2965143		5940-01-336-6326	103	52
77060	2965439		5940-01-347-6143	69	9
				101	6
				255	10
77060	2965467		5940-01-339-9566	93	17
				94	19
06853	296615			162	13
77060	2971859		5940-01-337-3318	93	13
77060	2973781		5935-01-161-8087	68	5
				93	55
				99	8
				255	8
77060	2973849		5940-00-107-1481	96	16
77060	2973890		5935-01-336-5401	93	16
				103	53
77060	2977042		5935-01-295-2863	93	65
77060	2977044		5935-01-296-2196	93	70
				94	2
77060	2977048		5935-01-065-7983	93	23
				103	55
10988	2977253			68	33
			5935-01-065-7984	69	12
				71	22
				82	23
				93	6
				110	10
				255	41
77060	2977373			68	27
				101	28
62380	29842A		4720-01-475-2616	240	32
77060	2984378		5935-00-378-1253	68	20
				93	48
77060	2984528		5940-01-234-7954	69	10
				93	19
				94	9
				255	40
77060	2984576		5940-00-113-3145	61	6
				65	16
				93	47
				96	25
77060	2984678		5935-01-336-3695	93	56
77060	2984807-5		5940-01-300-9339	103	51
06853	298486			159	1
77060	2984883		5935-01-296-3521	68	25
				255	9
06853	298706			162	37
06853	298710			162	35
06853	298714			162	36
06853	298715			162	42
06853	298719			162	10
06853	298721			162	6

CROSS-REFERENCE INDEXES

CAGEC	PART NUMBER	PART NUMBER INDEX		FIG.	ITEM
			STOCK NUMBER		
06853	298722			162	5
06853	298724			162	9
06853	298725			162	30
06853	298730			162	22
06853	298749			162	45
35510	29968		5310-01-077-9648	60	67
02697	3-908N552-90		5331-00-929-8171	174	9
				174	13
				174	15
87373	3-916 N0552			135	2
83259	3-916N552-90		5331-01-125-6268	135	14
				135	21
17446	3LC120-2R12		5365-01-336-7659	217	6
58312	3S9643-00		5330-00-246-6380	50	7
7Z588	30010H		4730-01-122-3338	55	5
				234	2
75418	3018-01507-01		5330-01-393-5626	54	9
75418	3018-01519-01		5330-01-331-9283	54	7
75418	3018-01609-01			54	5
75418	3018-01610-01			54	15
75418	3018-01612-01			54	6
75418	3018-01613-01			54	17
45225	302026		5120-01-359-2857	263	8
45225	302027		5120-01-357-0742	263	7
45225	302030		5120-01-356-8911	263	2
75418	3022-01372-03		4730-01-355-9205	89	9
75418	3029-01317-03		5310-01-440-9675	54	27
75418	3029-01371-01			54	3
51377	3030-00364-01		5310-01-190-4607	54	22
95879	3038-B		4730-01-293-2939	170	8
75418	3038-01510-01		5325-01-331-9372	54	13
75418	3038-01564-01			54	33
75418	3038-01565-01			54	31
75418	3042-01223-16		5305-01-443-4906	54	35
75418	3042-01684-01			54	25
51377	3051-01405-01		5307-01-190-5854	54	19
75418	3058-00843-07		5310-01-331-9416	54	20
75418	3058-01603-01		5310-01-440-6750	54	28
51377	3059-00870-06		5310-01-190-0283	54	21
51377	3059-00874-02		5310-01-184-7647	89	11
35510	30806		5310-01-107-9269	57	33
32195	308742		5306-00-121-8232	61	1
				232	4
				233	34
77326	31-200		2920-01-338-1069	68	16
82465	31WLF51618		5310-00-166-8341	44	11
				45	12
				49	20
78500	3100-W-7121		2530-01-338-2348	138	6
78500	3101-W-179		5315-01-112-1505	138	14
78500	3105-B-210		5340-01-328-4418	146	21

CROSS-REFERENCE INDEXES

CAGEC	PART NUMBER	PART NUMBER INDEX		FIG.	ITEM
			STOCK NUMBER		
78500	3105-B-210		5340-01-328-4418	147	19
78500	3107-S-1059		2520-01-363-6918	142	50
78500	3111-C-2863		2530-01-326-4571	139	1
78500	3111-L-2950		2530-01-327-5416	139	3
78500	3133-C-2551		2530-01-178-7154	138	24
78500	3133-E-7337		2530-01-325-6410	138	24
78500	3133-U-6573		2530-01-325-3381	138	20
35510	31757		5305-00-177-5568	60	37
64678	318 464 00 01		2530-12-352-2728	168	2
82465	32WLF3816		5310-01-278-9527	45	7
78500	3202-S-9483		2520-01-330-0773	140	3
78500	3202-T-9484		2520-01-330-0772	140	10
78500	3206-T-1346			141	11
78500	3206-U-1347			141	3
78500	3208-M-1027		5330-01-325-2623	138	12
35510	32172		5310-01-107-9715	57	10
31033	3240-RO-674-99		2815-01-322-6694	12	4
35510	3249		5310-00-274-4546	60	13
85757	3250-061		4720-01-014-4915	BULK	28
85757	3250-1010		4720-01-009-9058	BULK	27
78500	3266-C-1095		5340-01-328-4438	142	67
78500	3280-V-8394		2940-00-586-4792	142	61
78500	3280-Z-8398		5340-01-325-7332	142	7
78500	3280B8530			138	16
78500	3297-E-1019			143	2
62380	330.027		4730-01-394-8139	240	3
				241	20
01347	330-10-10-R		4820-01-005-2994	238	8
				239	1
79470	3300X6		4730-00-881-1161	155	76
OJRU8	333			166	2
62380	342 95A			241	11
35510	34752		5310-01-158-9215	60	72
62380	348 59A			241	21
62380	348 88A			241	13
64678	35000		4820-01-333-0095	153	21
				156	59
				158	18
24161	350357		4720-01-332-5973	BULK	9
98933	35055		4720-01-336-8154	BULK	22
80201	35066		5330-01-149-9677	138	25
11331	351345			40	1
70655	3553		5310-01-337-0369	35	8
				204	2
10402	36-0240409-00		6240-01-085-2319	245	2
73972	3600AX		2530-01-441-1881	165	8
62380	367400		5340-01-475-3164	240	5
35510	36900		5310-00-482-1999	60	28
62380	371 009			241	17
64678	3744936X006			225	26
60038	3782		3110-00-100-3104	164	2

CROSS-REFERENCE INDEXES

CAGEC	PART NUMBER	PART NUMBER INDEX		FIG.	ITEM
			STOCK NUMBER		
62380	379-55C			241	4
28158	37992		2510-01-481-3360	192	18
10402	38-0240201-00		5330-01-221-3166	245	4
73973	3800X		2530-01-478-7545	164	1
45225	38095		5120-01-357-1599	264	4
35510	38401		3120-00-064-1723	60	44
35510	38406		9390-00-112-8047	60	10
62380	386-41C			241	3
62380	38652C			241	14
45225	38841		3940-01-354-9446	264	5
78500	3892-N-4902		3020-01-329-9942	142	60
78500	3892-R-4932		3020-01-325-6390	142	13
57733	391-NX		2910-01-356-2715	89	7
62265	3915647		5330-01-388-7501	143	8
60038	3920		3110-00-100-0380	142	45
73342	39534511			129	37
35510	3966		5305-01-121-5475	60	24
81343	4-2-100103BA		4730-01-088-7502	48	11
78493	4R313		6620-01-320-9060	50	6
78500	40X-1182		5310-01-331-5832	144	19
78500	40X-1233		5310-01-466-1604	142	2
				142	39
78500	40X1182		5310-01-331-5832	142	27
78500	40X1237		5310-01-466-1602	143	12
				144	26
78528	4000-8D		4820-01-478-7296	156	12
78528	4000-9		4730-01-365-7023	155	43
75418	4001-40690-01		5365-01-331-9503	54	10
75418	4001-40691-01			54	14
77640	400143		3120-01-328-4295	172	27
77640	400144		3120-01-328-4296	172	22
77640	400149		5365-01-329-4034	172	25
77640	400156			172	53
77640	400161		3110-01-328-4074	172	51
08179	400696-7			34	4
08179	400698-1			34	8
08179	400729-111			34	5
75418	4011-42175-04			54	34
75418	4012-41486-01			54	30
75418	4012-41904-01			54	32
77640	401637			172	33
77640	401650		5325-01-331-7516	172	13
77640	401662		5360-01-328-4127	172	40
75418	4026-36900-01			54	23
75418	4038-40903-01			54	18
77640	403851		2520-01-479-0533	168	4
75418	4040-41131-03			54	8
75418	4043-41795-01			54	4
75418	4073-38444-01		5340-01-331-9610	54	24
75418	4077-42315-01			54	29
75418	4079-41132-03			54	12

CROSS-REFERENCE INDEXES

CAGEC	PART NUMBER	PART NUMBER INDEX		FIG.	ITEM
			STOCK NUMBER		
75418	4079-42079-01			54	16
75418	4088-40615-01		5360-01-392-9389	54	11
77640	409118A2		5365-01-330-6903	172	46
78500	41X-1208		5305-01-325-5920	142	36
78500	41X-1216		5305-01-329-3992	142	19
				144	12
78500	41X-1327			142	53
62380	412-44D			241	6
07637	415437-A1		5365-01-134-0522	172	31
				172	47
0U276	41596		5342-01-334-3569	15	8
24161	4175-3			BULK	7
24161	4175-3X8			135	12
82484	4188 30BWS		2540-01-442-9346	225	12
64678	419 546 70 35		5935-00-773-1428	102	3
64678	419 990 70 54		5310-01-248-3077	103	59
78500	42X-1021		5310-01-325-7279	142	21
				144	14
45225	42052		5342-01-084-4459	263	4
75175	42127-001		6220-01-357-3672	79	9
24161	4230-0002		4720-01-332-8491	BULK	26
24161	4230-0174		4720-01-331-7810	BULK	25
24161	4230NX-3/4		4720-01-337-3961	BULK	24
24161	4230NX-5/8		4720-01-337-3960	BULK	23
24161	4230T-3/8ID		4720-01-478-6010	BULK	15
0U276	42365		6680-01-330-8259	175	2
29500	4246-02277		4720-01-447-0911	BULK	38
64678	4246-0410X5			31	9
24161	4251-0125		4720-01-364-4437	BULK	13
0U276	42987			120	2
35510	4340		5310-00-429-3135	57	51
70523	43970		2540-01-346-1813	203	18
70523	43971		2540-01-345-5746	203	18
12662	445-25		6220-01-095-2616	80	8
08179	446397-460			34	12
08179	446401-795			34	10
08179	447844-17			34	9
78500	449 711 046 0			104	15
08179	449094-5			34	7
35510	4492		5310-01-136-5543	57	15
08179	449289-610			34	6
80201	450434		5340-01-288-1244	164	9
80201	450755		5330-01-475-9540	164	8
52152	4516 5/8 IN.		7510-00-079-7604	BULK	35
08179	451638-7			34	11
08179	451911-27			34	2
77640	453094-A2		5945-01-448-0189	90	8
S3465	4536226-786		5310-01-171-4689	203	50
S3465	4537800-247		5306-01-174-0373	56	8
57733	467-EC		6685-01-339-8261	71	25
57733	467-ED		6685-01-341-9125	71	15

CROSS-REFERENCE INDEXES

CAGEC	PART NUMBER	PART NUMBER INDEX		FIG.	ITEM
			STOCK NUMBER		
19986	468105		4720-01-478-6013	BULK	36
64678	468105X42			225	33
75418	4735-41392-08			52	1
77640	478040			172	7
77640	478041			172	15
77640	478042			172	52
77640	478044			172	34
77640	478045			172	16
77640	478054			172	32
62380	47901A			240	13
64678	48-00050-206X6			199	3
64678	48-00081-038X24			45	3
64678	48-00099-150X3			15	21
64678	48-00100-010X15			48	1
64678	48-00100-010X5			48	15
64678	48-00100-019X102			154	15
64678	48-00100-812X15			231	16
64678	48-00100-812X18			231	10
64678	48-00100-814X16			231	7
64678	48-00100-815X15			231	11
64678	48-00100-816X18			231	12
64678	48-00100-816X48			231	8
				231	13
64678	48-00100-816X6			231	6
64678	48-00100-829X12			231	9
64678	48-00100-829X36			39	9
64678	48-00100-829X56			231	15
64678	48-00101-010X144			154	10
64678	48-00101-010X180			154	39
64678	48-00101-010X7			157	4
				160	4
64678	48-00101-010X84			154	38
64678	48-00101-015X180			154	40
				155	10
64678	48-00101-015X96			154	11
64678	48-00101-022	4720-01-355-3104		BULK	8
64678	48-00101-030X180			157	2
				160	2
				160	28
64678	48-00101-035X180			155	9
64678	48-02014-008X48			49	21
64678	48-02015-012X24			174	3
64678	48-02017-100X18			225	14
64678	48-02017-100X30			225	18
64678	48-02017-156X048			225	23
64678	48-02017-156X72			225	24
64678	48-02188-001	9330-01-256-5345		BULK	31
64678	48-02188-001X4"			91	30
64678	48-02217-025X36			39	10
64678	48-02217-025X5			48	18
64678	48-02217-050X3			88	9

CROSS-REFERENCE INDEXES

CAGEC	PART NUMBER	PART NUMBER INDEX		FIG.	ITEM
			STOCK NUMBER		
64678	48-02217-075X57. 08			112	9
64678	48-02217-100	5975-01-343-1290		BULK	5
64678	48-02217-100X132			103	34
64678	48-02454-106X27			203	10
64678	48-02454-206X12			199	8
64678	48-02470-000	9390-01-338-5873		214	1
64678	48-02471-001X55			222	8
64678	48-02471-001X8			221	5
64678	48-25122-062			BULK	17
64678	48-25122-062X63			233	25
64678	48-25122-075			BULK	18
64678	48-25122-075X3			233	29
64678	48-25122-075X37			233	26
77060	48-25360-019	5975-01-479-0207		BULK	6
79470	48X6X6	4730-00-439-1722		154	47
62380	483931X42			240	11
62380	483931X50			240	4
62380	484032			240	2
01212	484156VGR	5330-01-319-2435		25	9
62380	487171			240	12
74545	4890	5935-01-154-4586		83	9
57733	490-ZY	6685-01-335-4471		246	1
62380	499.021	5340-01-287-1979		240	35
95019	5-170X	2520-00-294-6752		169	5
97271	5-188X	2520-01-084-3251		136	6
				137	6
72447	5-469X	2520-01-438-7589		136	2
11083	5D768	5342-00-931-4527		159	12
78500	5X-1034	5330-01-325-2615		142	8
				142	10
28803	500-9302	6220-01-338-5772		71	2
97271	500168-2	4730-00-906-0982		136	7
89346	50410DA	4730-00-044-4688		60	11
78528	5060-1			48	17
70412	51-15	2540-01-098-1865		225	7
72582	5100532	2815-01-082-2134		9	13
72582	5101760	2940-00-089-2520		14	4
72582	5108612	5340-00-078-2394		30	5
72582	5109157	5340-00-919-2876		6	12
45225	51100	5120-01-357-0743		263	1
33873	51178-005			239	9
33873	51178-1-002	8145-01-245-2092		239	17
33873	51178-1-003	8145-01-245-2099		239	2
33873	51178-1-006	8140-01-245-4323		239	9
33873	51178-1-008	8140-01-245-5694		239	8
33873	51178-1-100	5330-01-248-7817		239	3
33873	51178-1-101	3990-01-247-3625		239	18
33873	51178-1-104	7690-01-245-4316		239	21
33873	51178-1-105	8140-01-245-4321		239	13
72582	5133981	5310-00-933-0993		8	11

CROSS-REFERENCE INDEXES

CAGEC	PART NUMBER	PART NUMBER INDEX		FIG.	ITEM
			STOCK NUMBER		
72582	5138638		5315-00-094-3733	6	9
72582	5139988		5342-01-144-1937	7	14
72582	5139991		4730-01-241-6612	6	17
				7	5
72582	5141452		5365-00-094-4271	24	7
72582	5143616		3010-00-932-4813	173	37
72582	5145225			27	9
72582	5147753		5340-01-440-4885	161	5
72582	5151272		5340-00-841-9141	7	4
72582	5157412		5365-01-067-9583	14	11
72582	5166664		3020-00-517-7586	122	9
72582	5180370		5310-01-320-8100	27	26
72582	5182977		5331-00-682-7193	63	5
35510	52066		5310-01-023-8927	57	67
55156	52210			91	48
72582	5234224			28	3
72582	5234699		5331-01-319-4858	28	5
72582	5234702		5331-01-319-4857	28	4
72582	5235586			28	2
72582	5236116		2910-01-322-9191	KITS	
35510	52720		5977-01-155-7352	60	15
77060	5290433			103	26
35510	5293		5310-00-364-6497	57	59
				60	68
70485	5436		5325-01-336-6929	94	10
				99	6
				227	24
06853	550502		2590-01-435-4231	71	6
60038	55206		3110-00-100-3630	144	3
08108	561		6240-01-093-2131	83	3
86928	5613-37-062		5310-01-406-6332	230	2
19207	57K1748		2815-01-479-4199	1	1
19207	57K1749		2520-01-479-8832	119	1
19207	57K4212		5180-01-479-1630	257	1
19207	57K4213		5180-01-479-1631	260	1
19207	57K4214		5180-01-479-1626	266	1
86928	5702-107-060BO			201	83
35510	57022		5342-01-127-5636	60	60
81646	5706		4730-01-331-6629	45	2
35510	57246		6150-01-341-4886	57	61
19204	572929		5999-00-057-2929	94	14
				96	11
				100	6
				100	13
				245	7
81646	5748		4730-01-326-2939	250	6
35510	57594		5940-00-476-6752	57	56
35510	57611		5330-00-406-0664	57	49
35510	57613			57	55
35510	57615		5970-00-421-1207	57	58
35510	58754		5305-00-450-0463	57	47

CROSS-REFERENCE INDEXES

CAGEC	PART NUMBER	PART NUMBER INDEX		FIG.	ITEM
			STOCK NUMBER		
35510	58777		2920-00-431-6584	57	53
32498	588-11		2920-01-337-4135	68	2
2E480	59011		2590-01-350-4238	252	6
13445	59024-33		5930-01-332-0680	68	21
2E480	59099		5340-01-376-0542	252	4
08645	591909AA1-H680			203	17
35510	59225		5310-00-451-0631	57	39
08645	592727AA1-H680			201	61
60038	594A-592A		3110-01-331-1340	165	3
35510	5955		5310-00-508-5439	60	22
35510	59982S		5310-00-429-3156	57	6
				57	62
72447	6.3-3-41X		2520-01-479-0035	136	5
7H161	6.5-70-89		5340-01-292-3904	136	9
95019	6-3-3441KX		2520-00-114-3294	137	5
95019	6-4-6371			143	11
				144	25
95019	6-73-209		5305-01-421-4222	136	3
				137	3
04055	6TLFP		6140-01-431-1172	91	11
93061	60NTA-10		4730-00-426-8180	152	19
				153	17
				156	46
				156	63
				158	3
				158	14
				158	21
				160	26
				160	31
93061	60NTA-4		4730-01-048-6358	48	4
				48	13
				150	5
				150	32
				150	40
				150	45
				151	11
				153	31
				154	20
				226	3
				226	14
93061	60NTA-6		4730-01-048-5260	48	23
				150	9
				150	24
				151	3
				152	4
				152	11
				154	8
				154	43
				155	25
				155	30
				155	34

CROSS-REFERENCE INDEXES

CAGEC	PART NUMBER	PART NUMBER INDEX		FIG.	ITEM			
			STOCK NUMBER					
93061	60NTA-6		4730-01-048-5260	155	53			
				155	57			
				155	61			
				156	4			
				156	10			
				156	26			
				156	50			
				160	36			
				163	11			
				152	15			
				153	25			
93061	60NTA-8		4730-01-049-1559	155	15			
				155	65			
				155	70			
				155	74			
				156	15			
				156	22			
				240	38			
				156	34			
				60	47			
				194	3			
				201	55			
94	7							
62380	601025							
						9905-00-740-9721	156	34
						4730-01-187-3645	60	47
						5340-01-336-4251	201	55
						5340-01-371-1658	KITS	
						5330-01-154-5214	80	7
						5330-01-336-6720	79	2
						4730-01-371-4370	152	18
						153	16	
						156	47	
						156	62	
158	2							
158	13							
158	20							
160	27							
160	30							
93061	61NTA-4		4730-01-048-6968	48	3			
				48	14			
				150	4			
				150	31			
				150	41			
				150	46			
				151	10			
				153	30			
				154	21			
				226	4			
				226	15			
93061	61NTA-6		4730-01-048-7873	48	24			
				150	10			
				150	25			
				151	2			
				152	3			

CROSS-REFERENCE INDEXES

CAGEC	PART NUMBER	PART NUMBER INDEX		FIG.	ITEM
			STOCK NUMBER		
93061	61NTA-6		4730-01-048-7873	152	12
				154	9
				154	42
				155	26
				155	29
				155	35
				155	54
				155	56
				155	60
				156	3
				156	11
				156	25
				156	49
				160	37
				163	13
		93061		61NTA-8	
	153		24		
	155		64		
	155		71		
	155		75		
	156		16		
	156		21		
3B481	6107838-001	2540-01-332-7679	KITS		
00779	61863-2	5940-01-338-2929	67	12	
00779	61868-1	5940-01-337-3812	65	33	
00779	61903-1	5940-01-336-6324	65	17	
7Z588	62028	4730-01-407-3710	73	2	
0A8K5	62165		167	1	
3B481	6222077-001	2530-01-333-0721	220	27	
3B481	6222080-001	2530-01-333-0722	220	25	
3B481	6222086-001	2510-01-332-6037	220	20	
3B481	6222091-001	5340-01-332-6692	219	14	
45152	62411AX	5306-01-344-6714	177	19	
00779	62691-2	5940-01-336-6322	108	6	
			255	14	
77060	6288700	5935-01-336-5394	93	14	
			103	62	
77060	6294468	5940-01-342-0559	93	54	
77060	6294544	5935-01-168-0731	93	8	
93061	63NTA-10	4730-01-355-9204	152	20	
			153	18	
			156	45	
			156	64	
			158	4	
			158	15	
			158	22	
			160	25	
			160	32	
93061	63NTA-4	4730-01-057-7109	48	5	
			48	12	
			150	6	

CROSS-REFERENCE INDEXES

CAGEC	PART NUMBER	PART NUMBER INDEX		FIG.	ITEM				
			STOCK NUMBER						
93061	63NTA-4		4730-01-057-7109	150	33				
				150	39				
				150	44				
				151	12				
				153	32				
				154	19				
				226	2				
				226	13				
				93061	63NTA-6		4730-01-056-4990	48	22
								150	8
150	23								
151	4								
152	5								
152	10								
154	7								
154	44								
155	24								
155	31								
155	33								
155	52								
155	58								
155	62								
156	5								
156	9								
156	27								
156	51								
160	35								
93061	63NTA-8		4730-01-048-5261	163	12				
				152	16				
				153	26				
				155	14				
				155	66				
				155	69				
				155	73				
				156	14				
156	23								
89346	634419-C-1		4820-01-152-0193	159	48				
93061	639PMT4			151	25				
93061	639PM532			151	27				
35510	6399		5315-00-616-5523	57	37				
58723	6400-7051		5905-01-357-4958	68	30				
77060	64498R		5975-01-243-9900	BULK	4				
81834	64931-5		6220-01-224-3042	82	10				
72741	656212		5340-01-215-1558	193	34				
19207	6566675		2590-00-473-6331	256	2				
64386	66D638		4020-01-106-6523	92	24				
4R901	660570		5342-01-336-7037	197	6				
00779	66101-2		5999-00-239-2070	115	14				
73342	6750468		3010-00-374-4940	9	4				
73342	6751516		2520-00-374-4950	9	2				
73342	6753364		2520-00-887-5522	9	5				

CROSS-REFERENCE INDEXES

CAGEC	PART NUMBER	PART NUMBER INDEX		FIG.	ITEM
			STOCK NUMBER		
93061	68HB-10-8		4730-01-105-9466	234	5
93061	68NTA-10-6		4730-01-082-8799	152	17
93061	68NTA-10-8		4730-01-196-7479	156	61
				158	19
93061	68NTA-4-4		4730-01-091-9212	150	3
				153	29
				154	18
93061	68NTA-6-2		4730-01-134-0854	48	2
93061	68NTA-6-4		4730-01-062-2570	151	1
				155	59
				156	2
93061	68NTA-6-6		4730-01-096-9128	48	21
				154	6
				155	51
				156	24
93061	68NTA-6-8		4730-01-096-9127	156	8
93061	68NTA-8-6		4730-01-091-8032	152	9
				155	63
				155	72
64678	680 429 00 03		4710-01-365-6944	150	21
64678	680 545 42 26			101	20
75418	680 990 04 92		5315-01-478-6920	46	3
64678	681 065 01 040		5340-01-336-3930	71	17
64678	681 153 04 14		5930-01-338-2035	86	2
64678	681 317 04 76		5310-01-336-6861	197	7
64678	681 429 12 47		2590-01-357-5444	150	35
64678	681 460 00 40		2530-01-329-5045	90	1
64678	681 505 21 55		2930-01-329-9900	47	1
64678	681 540 08 38		6150-01-336-6478	59	9
64678	681 541 00 K0			223	5
64678	681 545 07 22		5930-01-332-0680	68	32
				69	7
64678	681 545 10 22		5930-01-336-9056	68	11
64678	681 545 11 24		5930-01-336-5441	86	4
64678	681 545 16 28		5935-01-336-6900	93	50
				101	7
64678	681 545 37 90		6220-01-341-7723	71	14
64678	681 545 47 90		6210-01-478-7230	71	13
64678	681 545 50 90		6220-01-338-5779	71	9
64678	681 545 55 90		6220-01-348-3028	71	10
64678	681 545 58 90		6220-01-338-5781	71	11
64678	681 546 02 88		5945-01-392-9346	61	2
64678	681 584 13 38			235	2
64678	681 584 14 38			235	1
64678	681 720 00 16			203	47
64678	681 721 02 K0		5340-01-474-9581	203	23
64678	681 790 02 K0		2530-01-479-4198	243	1
64678	681 816 00 K2		1005-01-439-9229	244	1
64678	681 830 10 K2		2540-01-479-2467	240	1
64678	681 883 00 32		5340-01-332-6696	210	16
				222	17

CROSS-REFERENCE INDEXES

CAGEC	PART NUMBER	PART NUMBER INDEX		FIG.	ITEM
			STOCK NUMBER		
64678	681 883 24 01		2510-01-339-2317	222	13
64678	681 899 02 K0			256	1
64678	681 990 11 05		5970-01-329-7358	206	14
64678	681 990 16 40			221	8
64678	681 997 05 81			226	24
64678	681 997 06 90			113	2
77060	68236R		5975-01-135-5941	BULK	3
77060	68237R		5975-01-135-5919	BULK	1
77060	68240R		5975-01-135-5917	BULK	2
64678	68240R-006			49	19
64678	684038.00			230	16
73342	6885065		5360-01-359-7952	134	83
12361	7-543-001790		4720-01-284-1668	BULK	19
12361	7-689-000704		5999-01-216-3648	101	16
78500	7X-1002		5315-01-328-4359	138	7
78500	7X-1003		5315-01-326-5530	138	2
35510	7092		5305-00-335-4067	60	50
35510	71038		5331-00-633-6818	60	30
35510	71041		5331-00-633-6827	60	49
35510	71045		3120-00-082-0403	60	35
				60	63
35510	71046		3120-00-493-4034	60	62
35510	71065		5970-00-035-5100	60	53
35510	71157		2920-01-164-8123	60	34
35510	71163		2530-01-088-4432	60	75
35510	71193			57	31
35510	71194			57	64
35510	71245		3120-01-180-5624	60	26
64678	721		2540-01-337-4097	230	1
60038	72212C		3110-00-980-5621	142	38
				144	7
60038	72487		3110-00-100-0615	142	65
2E480	7255-99-00		5935-01-342-5944	93	58
72741	730-012		5310-01-330-6364	192	16
61424	731516		4720-01-478-6032	155	40
35510	73450S		5310-00-517-6564	60	4
35510	73498		5330-00-111-3795	60	32
35510	73502		5305-00-461-5860	60	43
35510	73503		5305-01-080-4755	60	73
35510	73543		5305-00-451-1623	57	29
35510	73545		5970-00-160-4066	57	7
35510	73546		5970-00-160-4001	57	23
35510	73547		3120-01-082-6996	57	65
35510	73571		5340-01-127-0445	60	48
35510	73579		2920-00-764-7365	60	8
35510	73644		3120-00-111-3711	60	39
19207	7375065		5310-00-737-5065	42	8
19207	7375429		5310-00-737-5429	27	23
35510	73814			57	57
35510	7400MC		2920-01-339-4308	59	5
74545	7467		5935-00-644-6750	83	7

CROSS-REFERENCE INDEXES

CAGEC	PART NUMBER	PART NUMBER INDEX		FIG.	ITEM
			STOCK NUMBER		
35510	74980		5331-00-838-6729	60	21
35510	74987		5340-00-764-7361	60	23
5F845	75000681		5330-01-336-6893	214	9
35510	75451		5310-00-429-3453	57	43
35510	75570			57	36
27783	7572B			166	5
35510	75777		5310-01-112-1740	60	5
35510	76985		5310-00-432-3959	57	41
19207	7716634		5975-00-771-6634	93	67
5A910	7716895		5935-01-179-9105	93	66
5A910	7722333		5365-01-247-1114	93	68
				103	58
5A910	7723309		5310-01-248-3077	93	69
35510	77302		5977-00-764-5530	57	54
19207	7735571		4730-01-163-5002	45	13
74410	7760103		2540-00-776-0103	186	2
35510	77916		3120-01-082-9419	57	63
35510	78138		2920-01-077-0911	60	64
35510	78145			57	9
35510	78302		5310-01-112-1738	60	36
35510	78328		5310-01-172-1991	60	71
35510	78420		5970-01-118-6746	60	16
35510	78421		5970-01-118-6753	60	17
35510	78752		6130-01-333-6779	57	66
35510	78753		6130-01-333-5850	57	25
35510	78895		3110-01-136-5534	57	44
35510	78983		2920-01-141-1488	57	38
35510	78991		5305-01-077-9659	57	42
81834	79-9007-06		5340-01-336-5923	KITS	
35510	79024		5310-01-077-9437	57	18
35510	79035		2920-01-082-6458	57	40
35510	79121		2920-01-332-6051	60	51
24975	79123		6105-01-084-3049	60	42
35510	79144		2920-01-147-2208	60	78
35510	79313		5305-01-105-6888	57	26
35510	79314		5306-01-106-9928	57	27
24975	79390		2920-01-104-8951	60	25
35510	79403		5330-01-106-6101	57	19
35510	79404		5330-01-106-4329	57	21
35510	79405		5330-01-111-6531	57	45
35510	79422			57	34
35510	79424		3110-01-136-2090	57	32
35510	79431		5970-01-104-1074	57	24
35510	79432		5970-01-104-1075	57	22
35510	79435			57	14
35510	79436		5970-01-120-5418	57	13
35510	79444		5940-01-335-2924	57	12
35510	79486		3110-01-109-3058	57	46
35510	79516			57	35
35510	79517		2920-01-267-2088	57	30
35510	79529		5970-01-308-0375	60	52

CROSS-REFERENCE INDEXES

CAGEC	PART NUMBER	PART NUMBER INDEX		FIG.	ITEM
			STOCK NUMBER		
35510	79624		3040-01-332-1634	60	45
19207	7973326		9905-00-901-2942	238	9
19206	7986694		5310-00-915-8460	57	11
81343	8 130109AB		4730-00-011-3176	153	7
				158	6
30780	8-16-16GX6JX-S			135	3
7H161	8-73-316		5305-01-338-8155	136	8
30780	8V6X-S		4730-01-270-2477	174	8
64678	80 412 04 139			233	12
64678	80.233.00.069			230	15
64678	80.349.00.109		4720-01-337-8833	230	12
64678	80.373.00.109		2930-01-337-3765	233	3
64678	80.618.00.009		3040-01-337-7428	230	10
				233	17
64678	80.618.00.019		3040-01-338-2410	230	13
64678	80.926.00.079		5905-01-338-3434	233	9
19954	80026-001			253	2
06853	800372		4820-00-774-8299	153	19
				156	55
				158	23
04963	805 1INLGGRAY		5975-01-333-5872	150	2
19954	80626-740			252	7
19954	80893-102			253	6
54905	809		4210-01-282-1789	224	3
19954	81082-102			253	1
4R901	811320		3120-01-408-7869	197	9
64678	815 00 899		5340-01-336-3911	233	14
45152	82TV196		4820-01-034-1287	KITS	
62380	820 96A			241	5
62380	824-06A			241	12
62380	824-07A			241	22
62380	824-10A			241	23
62380	824-13A			241	19
62380	824-15A			241	9
57733	830540-70		9905-01-352-2213	111	3
19954	83124-100			251	16
19954	83200-100			251	8
76700	83213D		4330-01-330-8203	175	6
19207	8338561		5935-00-833-8561	94	13
				96	6
				100	2
				100	23
				245	8
19207	8338562		5970-00-833-8562	94	12
				96	7
19207	8338564		5940-00-399-6676	94	11
				96	8
				100	3
				100	22
				245	10
5A910	8338566		5975-01-230-4370	94	16

CROSS-REFERENCE INDEXES

CAGEC	PART NUMBER	PART NUMBER INDEX		FIG.	ITEM
			STOCK NUMBER		
5A910	8338566		5975-01-230-4370	96	9
				100	7
				100	15
				245	5
19207	8338567		5310-00-833-8567	94	15
				96	10
				100	5
				100	14
				245	9
				241	10
62380	835 15B			241	10
98749	849257-2		5310-01-097-7691	182	8
				182	23
				201	102
				203	60
				212	3
64678	85.031.30.809		4710-01-337-7367	230	9
94222	85-11-540-52		5325-01-336-7688	201	79
94222	85-34-201-20		5310-01-102-9221	201	88
94222	85-46-101-41		5310-01-128-6503	201	81
62380	85042A			241	2
64678	8512030300			230	6
64678	8512030400			230	4
64678	8512630200			230	17
57648	85524		4010-01-329-1837	208	18
62380	862-44A			241	7
11139	88057 24 31			117	8
98441	881-12		4720-00-682-7920	BULK	14
70655	8868		5340-01-331-5739	33	13
				225	2
				11	3
72582	8920172			7	9
72582	8922327		4730-01-129-3047	23	2
				50	5
				51	12
				51	11
72582	8922383		5340-01-166-4444	16	6
72582	8922407		5325-01-166-6633	18	17
72582	8923313		4730-01-188-3492	6	13
72582	8923847		4730-01-398-7635	17	1
				30	13
				6	18
72582	8923916		4730-01-210-4252	7	16
72582	8924148		4730-01-157-8925	29	3
72582	8924380		4730-00-371-5337	27	4
72582	8924517		4730-00-010-3885	7	6
				27	16
72582	8924998		4730-01-350-3589	29	5
				161	10
72582	8925325		4730-01-216-3331	29	7
72582	8926993		4730-01-298-9423	6	14
72582	8929007		2920-01-316-8813	27	18

CROSS-REFERENCE INDEXES

CAGEC	PART NUMBER	PART NUMBER INDEX		FIG.	ITEM
			STOCK NUMBER		
72582	8929011		5315-01-319-2509	20	12
72582	8929013		5331-01-321-2160	10	3
72582	8929015		5315-01-319-5895	7	13
				27	2
72582	8929019		5310-01-321-2421	10	16
72582	8929021		5310-01-336-8850	28	7
72582	8929022		5315-01-320-8883	7	15
				27	5
72582	8929068		5305-01-319-9882	2	4
72582	8929076-B		5340-01-322-2747	12	6
72582	8929077		3020-01-331-1905	8	10
72582	8929085		3120-01-320-4983	8	4
72582	8929088		2910-01-321-9247	28	8
72582	8929111		3040-01-319-6983	24	4
72582	8929123		5305-01-330-8440	6	22
72582	8929124		5305-01-320-7153	7	10
72582	8929125		5310-01-321-2444	7	11
72582	8929126		2815-01-322-9163	12	8
72582	8929127		2815-01-322-9164	12	9
72582	8929129		5306-01-321-0556	6	4
72582	8929130		5330-01-319-2136	27	19
72582	8929152		5315-01-320-3626	7	3
72582	8929153		5315-01-323-5661	7	2
72582	8929169-B		5310-01-321-2441	34	27
72582	8929176		5330-01-320-4926	10	4
72582	8929222		5306-01-323-2292	8	12
72582	8929253		5330-01-334-2726	25	12
72582	8929276		3130-01-322-0935	7	12
72582	8929285		5330-01-319-8671	34	26
72582	8929289		5331-01-320-7183	18	5
72582	8929299		5330-01-318-4569	27	6
				161	14
72582	8929302		5330-01-321-4132	18	13
72582	8929310		3020-01-337-4220	25	6
72582	8929318		5330-01-334-7187	11	4
				173	36
72582	8929322		3020-01-338-4547	24	3
72582	8929328		5310-01-320-5919	6	23
72582	8929333		5306-01-320-8614	27	3
72582	8929336		5340-01-320-5179	24	2
72582	8929355		5306-01-320-4894	10	15
72582	8929357		5306-01-320-3942	23	8
72582	8929379		3020-01-319-9401	11	8
72582	8929387		2990-01-320-0162	84	6
72582	8929388		2990-01-320-0163	84	5
72582	8929393		5305-01-320-8043	20	16
				28	6
72582	8929408		5340-01-330-8435	5	3
72582	8929415		5360-01-320-3689	12	5
72582	8929427			51	21
72582	8929432		5340-01-320-5174	7	19

CROSS-REFERENCE INDEXES

CAGEC	PART NUMBER	PART NUMBER INDEX		FIG.	ITEM
			STOCK NUMBER		
72582	8929448		5306-01-338-0894	24	6
72582	8929497		3020-01-319-9400	8	8
72582	8929502		2815-01-319-7851	8	9
72582	8929508		5340-01-319-5305	64	2
72582	8929529		5330-01-037-4129	34	20
72582	8929532		3020-01-319-2831	25	10
72582	8929534		5340-01-332-7595	64	1
72582	8929586		5365-01-330-8392	13	2
72582	8929587		5305-01-330-8432	13	3
72582	8929588		5307-01-330-8430	6	1
72582	8929594		4730-01-319-7471	7	7
				51	17
72582	8929607			13	9
72582	8929625		2815-01-356-0766	12	9
72582	8929626		2815-01-356-0767	12	9
72582	8929627		2815-01-356-2668	12	9
72582	8929628		2815-01-357-8737	12	8
72582	8929629		2815-01-356-0764	12	8
72582	8929630		2815-01-356-0765	12	8
72582	8929631		2815-01-323-1353	12	7
72582	8929634-ND		5340-01-319-4908	12	6
72582	8929635-ND		5340-01-323-8363	12	6
72582	8929636		5310-01-319-7295	12	6
72582	8929638		2510-01-320-8903	5	5
72582	8929670		3120-01-320-1034	8	3
72582	8929671		3120-01-319-9271	8	3
72582	8929672		3120-01-320-1035	8	3
72582	8929673		3120-01-319-8619	8	3
72582	8929680		3110-01-320-2310	8	5
72582	8929681		3120-01-320-1036	8	5
72582	8929682		3120-01-320-1037	8	5
72582	8929683		3120-01-320-1038	8	5
72582	8929690		3110-01-320-2309	11	1
72582	8929691		3120-01-334-2776	11	1
72582	8929693		3120-01-334-2777	11	1
72582	8929695		3120-01-334-9614	11	1
72582	8929697		3120-01-319-4879	8	4
72582	8929698		3120-01-319-4880	8	4
72582	8929725		4730-01-318-9668	30	2
72582	8929728		2930-01-319-2777	50	1
72582	8929739			6	5
72582	8929740		5330-01-320-8114	6	27
72582	8929744		2510-01-320-8289	2	3
72582	8929749		4730-01-335-9621	161	16
72582	8929754		2510-01-320-8904	5	1
72582	8929760		5340-01-336-8885	6	25
72582	8929805		5306-01-321-4903	9	14
72582	8929808		5315-01-319-2188	8	1
72582	8929810		5315-01-319-2189	11	9
72582	8929832		4730-01-318-9675	30	6
72582	8929833		4730-01-319-3374	18	20

CROSS-REFERENCE INDEXES

CAGEC	PART NUMBER	PART NUMBER INDEX		FIG.	ITEM
			STOCK NUMBER		
72582	8929833		4730-01-319-3374	29	6
				34	18
				161	13
72582	8929843		5315-01-321-3220	6	10
72582	8929845			10	7
72582	8929870			6	6
72582	8929871			6	7
78500	894 601 075 2		6150-01-470-3205	104	17
78500	899 760 510 4		5342-01-350-7071	88	5
64386	90HL70R50C18		4730-01-439-6599	31	2
18179	90PC20R		5975-01-339-5950	93	33
4B100	9002001		5310-01-316-5096	149	1
01276	900729-1		5340-00-616-4018	15	15
				81	5
				49	10
01276	900729-21		5340-01-145-3232	163	4
				229	5
				102	5
01276	900729-24		5340-01-253-0128	234	16
				49	11
				76	6
01276	900729-4		5340-00-764-5231	225	17
				88	3
				240	37
62380	901016A			240	15
62380	901100X19			240	34
62380	901100X20			240	14
62380	901100X23			240	36
62380	901100X29			242	4
62380	901100X4			240	20
62380	901100X86			240	19
62380	901100X90			242	2
62380	901106			240	42
62380	901108			240	43
62380	901114			240	16
62380	901118			240	18
62380	901129			240	24
62380	901199			115	37
11139	9013-3-0402			149	3
4B100	9019005		5340-01-367-6668	241	15
62380	902-50A			241	24
62380	90223A		5999-01-475-0215	240	22
62380	902712			240	39
62380	902888			240	40
62380	905483A			240	10
62380	905794			242	1
62380	906029			114	1
62380	906041A			240	41
62380	906304A			169	4
95019	908213-24SX		2520-01-327-1298	203	49
64678	912004 006102		5310-01-171-2356	241	1
62380	92209A				

CROSS-REFERENCE INDEXES

CAGEC	PART NUMBER	PART NUMBER INDEX		FIG.	ITEM
			STOCK NUMBER		
00779	927768 3			110	3
00779	927775 3			110	4
15526	933-M8X20		5305-01-341-8926	55	14
73342	9409056		5306-00-638-1936	9	6
54646	94143-0428		4730-01-332-5450	35	2
72582	9415918		5305-01-333-5272	59	6
73342	9421497			44	20
				45	19
72582	9421745		5340-00-231-1964	13	14
30226	951		2540-01-354-9260	227	15
35510	95280		5305-01-312-4837	60	20
8E515	95440		5340-01-352-4352	60	65
35510	95648		5305-01-295-1317	60	29
35510	95656		2920-01-196-7730	60	76
35510	95770		5970-01-308-0374	60	6
35510	95771		5970-01-308-5176	60	9
35510	95778		5970-01-307-6070	60	12
35510	95781		5330-01-336-7291	60	70
35510	95971		2920-01-076-9812	60	59
35510	96021		5940-01-310-9565	60	54
35510	96032		5999-01-329-0309	60	56
00779	964561 2			110	8
00779	964561 4			110	7
00779	964561-5			110	6
35510	96545		5910-00-112-8051	57	28
64678	9700 005		6220-01-481-3742	79	1
78500	973 011 022 0			155	16
35510	97439		2520-01-187-3619	60	77
35510	97712			57	48
35510	97799		5330-01-079-6372	60	40
07BE6	99-499		5120-01-439-0305	259	9
13548	99120C		6220-01-338-9050	82	12
34914	992 4051		5305-01-158-2041	85	4
				85	8
				122	2
35510	99278		9390-01-204-7151	60	46
75377	993-042		5306-01-294-3028	269	8

By Order of the Secretary of the Army:

ERIC K. SHINSEKI
General, United States Army
Chief of Staff

Official:

JOEL B. HUDSON
Administrative Assistant to the
Secretary of the Army
13904

DISTRIBUTION:

To be distributed in accordance with the initial distribution number (IDN) 381096, requirements for TM 9-2320-302-24P.

This Page Intentionally Left Blank.

RECOMMENDED CHANGES TO PUBLICATIONS AND BLANK FORMS

For use of this form, see AR 25-30; the proponent agency is ODISC4.

Use Part II (reverse) for Repair Parts and Special Tool Lists (RPSTL) and Supply Catalogs/Supply Manuals (SC/SM).

DATE

1 Jul 01

TO: (Forward to proponent of publication or form) (Include ZIP Code)
 AMSTA-LC-CI/TECH PUBS, TACOM-RI
 1 Rock Island Arsenal
 Rock Island, IL 61299-7630

FROM: (Activity and location) (Include ZIP Code)
 125th Transportation Company
 ATTN: Motor SGT (SGT Wilson)
 Ft. Riley, KA 78665-4000

PART I - ALL PUBLICATIONS (EXCEPT RPSTL AND SC/SM) AND BLANK FORMS

PUBLICATION/FORM NUMBER TM 9-2320-302-24P	DATE 28 May 2001	TITLE Unit DS and GS Maintenance Repair Parts and Special tools Lists (RPSTL) for Truck, Tractor, M915A3
--	---------------------	---

ITEM	PAGE	PARA-	LINE	FIGURE NO.	TABLE	RECOMMENDED CHANGES AND REASON
				Figure 203		Missing Item 2 in Illustration.

SAMPLE

* Reference to line numbers within the paragraph or subparagraph.

TYPED NAME, GRADE OR TITLE Johnny Wilson, E-5, MOTOR SGT	TELEPHONE EXCHANGE/AUTOVON, PLUS EXTENSION DSN 867-7967	SIGNATURE
---	--	-----------

RECOMMENDED CHANGES TO PUBLICATIONS AND BLANK FORMS

For use of this form, see AR 25-30; the proponent agency is ODISC4.

Use Part II (*reverse*) for Repair Parts and Special Tool Lists (RPSTL) and Supply Catalogs/Supply Manuals (SC/SM).

DATE

TO: (*Forward to proponent of publication or form*) (*Include ZIP Code*)
 AMSTA-LC-CI/TECH PUBS, TACOM-RI
 1 Rock Island Arsenal
 Rock Island, IL 61299-7630

FROM: (*Activity and location*) (*Include ZIP Code*)

PART I - ALL PUBLICATIONS (EXCEPT RPSTL AND SC/SM) AND BLANK FORMS

PUBLICATION/FORM NUMBER
 TM 9-2320-302-24P

DATE
 28 May 2001

TITLE Unit DS and GS Maintenance Repair
 Parts and Special tools Lists (RPSTL)
 for Truck, Tractor, M915A3

ITEM	PAGE	PARA-	LINE	FIGURE NO.	TABLE	RECOMMENDED CHANGES AND REASON

** Reference to line numbers within the paragraph or subparagraph.*

TYPED NAME, GRADE OR TITLE

TELEPHONE EXCHANGE/AUTOVON,
 PLUS EXTENSION

SIGNATURE

RECOMMENDED CHANGES TO PUBLICATIONS AND BLANK FORMS

For use of this form, see AR 25-30; the proponent agency is ODISC4.

Use Part II (*reverse*) for Repair Parts and Special Tool Lists (RPSTL) and Supply Catalogs/Supply Manuals (SC/SM).

DATE

TO: (*Forward to proponent of publication or form*) (*Include ZIP Code*)
 AMSTA-LC-CI/TECH PUBS, TACOM-RI
 1 Rock Island Arsenal
 Rock Island, IL 61299-7630

FROM: (*Activity and location*) (*Include ZIP Code*)

PART I - ALL PUBLICATIONS (EXCEPT RPSTL AND SC/SM) AND BLANK FORMS

PUBLICATION/FORM NUMBER
 TM 9-2320-302-24P

DATE
 28 May 2001

TITLE Unit DS and GS Maintenance Repair Parts and Special tools Lists (RPSTL) for Truck, Tractor, M915A3

ITEM	PAGE	PARA-	LINE	FIGURE NO.	TABLE	RECOMMENDED CHANGES AND REASON

* Reference to line numbers within the paragraph or subparagraph.

TYPED NAME, GRADE OR TITLE

TELEPHONE EXCHANGE/AUTOVON, PLUS EXTENSION

SIGNATURE

RECOMMENDED CHANGES TO PUBLICATIONS AND BLANK FORMS

For use of this form, see AR 25-30; the proponent agency is ODISC4.

Use Part II (*reverse*) for Repair Parts and Special Tool Lists (RPSTL) and Supply Catalogs/Supply Manuals (SC/SM).

DATE

TO: (*Forward to proponent of publication or form*) (*Include ZIP Code*)
 AMSTA-LC-CI/TECH PUBS, TACOM-RI
 1 Rock Island Arsenal
 Rock Island, IL 61299-7630

FROM: (*Activity and location*) (*Include ZIP Code*)

PART I - ALL PUBLICATIONS (EXCEPT RPSTL AND SC/SM) AND BLANK FORMS

PUBLICATION/FORM NUMBER
 TM 9-2320-302-24P

DATE
 28 May 2001

TITLE Unit DS and GS Maintenance Repair Parts and Special tools Lists (RPSTL) for Truck, Tractor, M915A3

ITEM	PAGE	PARA-	LINE	FIGURE NO.	TABLE	RECOMMENDED CHANGES AND REASON

** Reference to line numbers within the paragraph or subparagraph.*

TYPED NAME, GRADE OR TITLE

TELEPHONE EXCHANGE/AUTOVON, PLUS EXTENSION

SIGNATURE

